

Series 4, Free-standing fridge-freezer with freezer at bottom, 203 x 60 cm, Cast Iron, Green Collection, Total No Frost KGN390CAFG



Smaller carbon footprint with our Green Collection: built with CO₂ reduced materials as well as energy efficiency class A, VitaFresh XXL <0°C> and Total No Frost.

- **Energy efficiency class A:** reduce energy consumption while enjoying optimal cooling performance.
- **No Frost:** never defrost again, thanks to perfect protection from ice formation - that saves time and effort.
- **VitaFresh XXL <0°C>:** keeps food fresh for longer in extra-large climate-controlled fridge drawers.
- **Perfect Fit:** place your appliance right next to walls or in a niche.
- **Glossy Backwall with Multi Airflow:** evenly circulates cool, fresh air to maintain consistent temperatures.

Technical Data

Energy Efficiency Class ¹ : A
Average annual energy consumption in kilowatt hour per year (kWh/a): 112 kWh/annum
Sum of volume of frozen compartments: 103 l
Sum of volume of chill compartments: 260 l
Airborne acoustical noise emissions : 29 dB(A) re 1pW
Airborne acoustical noise emission class: A
Built-in / Free-standing: Freestanding
Door panel options: Not possible
Height: 2030 mm
Width of the appliance: 600 mm
Depth: 665 mm
Net weight: 96.3 kg
EAN code: 4242005541812
Fuse protection: 10 A
Door hinge: Right reversible
Voltage: 220-240 V
Frequency: 50-60 Hz
Length electrical supply cord: 220 cm
Number of compressors: 1
Number of independent cooling systems: 2
Interior ventilator: No
Reversible Door Hinge: Yes
Number of Adjustable Shelves in fridge compartment: 3
Shelves for Bottles: Yes
Frost free system: Fridge and freezer
Installation typology: Free-standing



¹ Scale of Energy Efficiency Classes from A to G

Series 4, Free-standing fridge-freezer with freezer at bottom, 203 x 60 cm, Cast Iron, Green Collection, Total No Frost KGN39OCAFG

Smaller carbon footprint with our Green Collection: built with CO₂ reduced materials as well as energy efficiency class A, VitaFresh XXL <0°C> and Total No Frost.

-
- KGN39OCAFG
 - Twin No Frost (RC + FC), Fridge freezer
 - Standard door Cast Iron

Performance and Consumption

- EU19_EEK_D: A
- Total Volume : 363 l
- Annual Energy Consumption: 112 kWh/a
- EU19_Fast freezer facility_D
- Noise Level : 29 dB , EU19_Noise emission class_D: A

Functions

- Cast Iron doors and cast iron side panels
- White glossy back wall
- Integrated vertical handle
- Bright interior LED fridge light in fridge section

Design features

- NO_FROST_NEU_BL, never have to defrost ever again
- Separate, electronic temperature control with LED display
- Two separate cooling circuits allow independent temperature control and prevents the transference of humidity between the fridge and freezer cavity
- Super Cooling: automatic deactivation
- SuperFreeze function with automatic deactivation
- Optical and accoustical
- Freezer malfunction warning signal: optical and acoustical warning system

Design features

- Net Fridge Volume : 260 l
- MultiAirflow system - improves circulation of air around the fridge
- 5 safety glass shelves of which 3 are height adjustable
- Metal bottle rack
- Door shelves in fridge door: 1 large and 3 small.

Freshness System

- 1 VitaFresh drawer - Fish and meat stay fresh for longer
- 1 VitaFresh drawer with humidity control - Fruits and vegetables retain vitamins and stay fresh for longer

Food freshness system

- Net Freezer Volume : 103 l
- Freezing capacity 24h : 10 kg
- Temperature rise time : EU19_Temperature rise time_D: 21 H
- 3 freezer drawers

Dimension and installation

- Dimensions: 203 cm H x 60 cm W x 66.5 cm D

Key features - Fridge section

- door reversible
- Height adjustable front feet
- Climate Class: SN-T
- 220 - 240 V
- Length of power cord:220 cm

Key features - Freezer section

- 2 x cold accumulator, 1 x ice cube tray

Country Specific Options

- Based on the results of the standard 24-hour test. Actual consumption depends on usage/position of the appliance.

Design features

Dimension and installation

Additional features

**Series 4, Free-standing fridge-freezer
with freezer at bottom, 203 x 60 cm,
Cast Iron, Green Collection, Total No
Frost
KGN390CAFG**

Measurements in mm

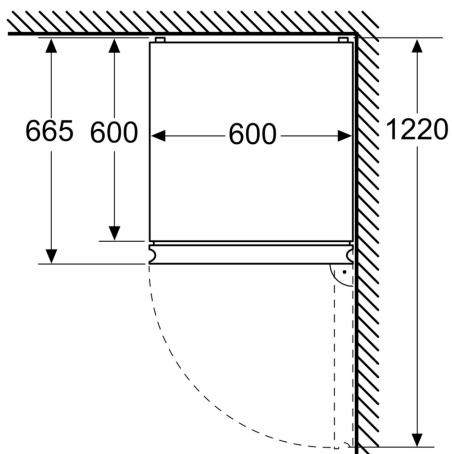

Measurements in mm

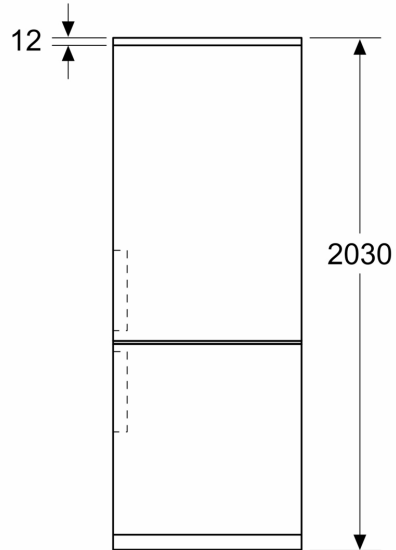

Measurements in mm

