



BOSCH

Register your
new device on
MyBosch now and
get free benefits:
[bosch-home.com/
welcome](https://bosch-home.com/welcome)



Tumble dryer

WQB246DLSN

[en] User manual and installation instructions



**You can find additional information and explanations online.
Scan the QR code on the title page.**



Table of contents

| | | | |
|--|-----------|--|-----------|
| 1 Safety | 3 | 10.1 Preparing the laundry | 24 |
| 1.1 General information | 3 | 10.2 Care symbols on the care labels | 25 |
| 1.2 Intended use | 3 | 11 Basic operation | 25 |
| 1.3 Restriction on user group | 4 | 11.1 Switching on the appliance .. | 25 |
| 1.4 Safe installation | 4 | 11.2 Setting a programme | 25 |
| 1.5 Safe use | 6 | 11.3 Saving the programme settings | 25 |
| 1.6 Safe cleaning and maintenance | 8 | 11.4 Opening the door | 26 |
| 2 Preventing material damage | 9 | 11.5 Loading laundry | 26 |
| 3 Environmental protection and saving energy | 10 | 11.6 Starting the programme | 26 |
| 3.1 Disposing of packaging | 10 | 11.7 Adding laundry | 26 |
| 3.2 Saving energy | 10 | 11.8 Cancelling the programme ... | 26 |
| 3.3 Energy saving mode | 10 | 11.9 Unloading the laundry | 26 |
| 4 Installation and connection | 10 | 11.10 Put the appliance into standby mode | 26 |
| 4.1 Unpacking the appliance | 10 | 11.11 Fluff filter | 27 |
| 4.2 Contents of package | 11 | 11.12 Condensation container | 28 |
| 4.3 Requirements for the installation location | 11 | 12 Dryness level | 29 |
| 4.4 Water outlet hose | 12 | 12.1 Changing the dryness level .. | 29 |
| 4.5 Aligning the appliance | 13 | 12.2 Adjusting the dryness level ... | 29 |
| 4.6 Reversing the door | 14 | 13 Childproof lock | 30 |
| 4.7 Connecting the appliance to the electricity supply | 14 | 13.1 Activating the childproof lock | 30 |
| 5 Familiarising yourself with your appliance | 15 | 13.2 Deactivating the childproof lock | 30 |
| 5.1 Appliance | 15 | 14 Wool basket | 30 |
| 5.2 Control panel | 16 | 14.1 Inserting the wool basket | 30 |
| 5.3 Operating logic | 16 | 14.2 Starting a programme with the wool basket | 30 |
| 6 Display | 16 | 14.3 Examples of how to use the wool basket | 31 |
| 7 Buttons | 18 | 15 Home Connect | 32 |
| 8 Programmes | 21 | 15.1 Setting up Home Connect | 32 |
| 8.1 Automatic programmes | 21 | 15.2 Deactivating Wi-Fi on the appliance | 32 |
| 8.2 Timed programmes | 23 | | |
| 9 Accessories | 23 | | |
| 10 Laundry | 24 | | |

| | | | |
|---|-----------|---|-----------|
| 15.3 Activating Wi-Fi on the appliance | 32 | 18 Cleaning and servicing | 37 |
| 15.4 Installing the software update | 33 | 18.1 Moisture sensor | 37 |
| 15.5 Resetting the appliance network settings | 33 | 18.2 Condensation container filter | 37 |
| 15.6 Remote start | 33 | 19 Troubleshooting | 38 |
| 15.7 Intelligent programme recommendation | 33 | 20 Transportation, storage and disposal | 42 |
| 15.8 Remote diagnostics | 34 | 20.1 Disposing of old appliance ... | 42 |
| 15.9 Data protection | 34 | 21 Customer Service | 42 |
| 16 Basic settings | 34 | 21.1 Product number (E-Nr.), production number (FD) and consecutive numbering (Z-Nr.) | 43 |
| 16.1 Overview of the basic settings | 34 | 22 Consumption values | 43 |
| 16.2 Changing the basic settings | 35 | 23 Technical data | 45 |
| 17 Appliance care | 35 | 23.1 Information regarding Free and Open Source Software .. | 46 |
| 17.1 Preparing for appliance care | 35 | 24 Declaration of Conformity | 47 |
| 17.2 Running the basic appliance care programme | 36 | 24.1 Statement of Compliance for Great Britain | 47 |
| 17.3 Running the intensive appliance care programme | 36 | | |

1 Safety

Observe the following safety instructions.

1.1 General information



- Read this instruction manual carefully.
- Keep the instruction manual and the product information safe for future reference or for the next owner.
- Do not connect the appliance if it has been damaged in transit.

1.2 Intended use

Only use this appliance:

- for drying and freshening up fabrics that are washed with water and suitable for dryers.

- in private households and in enclosed spaces in a domestic environment.
- Up to an altitude of 4000 m above sea level.

1.3 Restriction on user group

This appliance may be used by children aged 8 or over and by people who have reduced physical, sensory or mental abilities or inadequate experience and/or knowledge, provided that they are supervised or have been instructed on how to use the appliance safely and have understood the resulting dangers.

Do not let children play with the appliance.

Cleaning and user maintenance must not be performed by children unless they are being supervised.

Keep children under the age of 3 years and pets away from the appliance.

1.4 Safe installation

WARNING – Risk of electric shock!

Incorrect installation is dangerous.

- ▶ Connect and operate the appliance only in accordance with the specifications on the rating plate.
- ▶ Connect the appliance to a power supply with alternating current only via a properly installed socket with earthing.
- ▶ The protective conductor system of the domestic electrical installation must be properly installed. The installation must have a sufficiently large cross section.
- ▶ When using a residual current circuit breaker, only use a type with the  mark.
- ▶ Never equip the appliance with an external switching device, e.g. a timer or remote control.
- ▶ Never connect the appliance to a circuit that is regularly switched on and off by the energy supplier.
- ▶ When the appliance is installed, the mains plug of the power cord must be freely accessible. If free access is not possible, an isolating switch must be integrated into the permanent electrical installation according to the installation regulations.
- ▶ When installing the appliance, check that the power cable is not trapped or damaged.

If the insulation of the power cord is damaged, this is dangerous.

- ▶ Never let the power cord come into contact with hot appliance parts or heat sources.
- ▶ Never let the power cord come into contact with sharp points or edges.
- ▶ Never kink, crush or modify the power cord.

⚠ WARNING – Risk of fire!

It is dangerous to use an extended power cord and non-approved adapters.

- ▶ Do not use extension cables or multiple socket strips.
- ▶ Only use adapters and power cords approved by the manufacturer.
- ▶ If the power cord is too short and a longer one is not available, please contact an electrician to have the domestic installation adapted.

⚠ WARNING – Risk of injury!

The heavy weight of the appliance may result in injury when lifted.

- ▶ Do not lift the appliance on your own.

If this appliance is not correctly installed in a washer-dryer stack, the installed appliance may fall.

- ▶ Only stack the dryer on a washing machine using the connection kit from the dryer manufacturer . No other installation method is permitted.

→ *"Accessories", Page 23*

- ▶ Do not install the appliance in a washer-dryer stack if the dryer manufacturer does not offer a suitable connection kit.
- ▶ Do not install appliances from different manufacturers and with varying depths and widths in a washer-dryer stack.
- ▶ Do not install a washer-dryer stack on a platform; the appliances may tip over.

⚠ WARNING – Risk of suffocation!

Children may put packaging material over their heads or wrap themselves up in it and suffocate.

- ▶ Keep packaging material away from children.
- ▶ Do not let children play with packaging material.

⚠ CAUTION – Risk of injury!

The appliance may vibrate or move when in use.

- ▶ Place the appliance on a clean, even, solid surface.
 - ▶ Align the appliance using the appliance feet and a spirit level.
- If hoses and power cords have been laid incorrectly, this causes a tripping hazard.
- ▶ Lay hoses and power cords in such a way that there is no risk of tripping.

If the appliance is moved by holding onto protruding components, such as the appliance door, the parts may break off.

- ▶ Do not move the appliance by holding onto protruding parts.

⚠ CAUTION – Risk of cutting!

Touching sharp edges on the appliance may lead to cuts.

- ▶ Do not touch the sharp edges on the appliance.
- ▶ Wear protective gloves when installing and transporting the appliance.

1.5 Safe use

⚠ WARNING – Risk of electric shock!

If the appliance or the power cord is damaged, this is dangerous.

- ▶ Never operate a damaged appliance.
- ▶ Never pull on the power cord to unplug the appliance. Always unplug the appliance at the mains.
- ▶ If the appliance or the power cord is damaged, immediately unplug the power cord or switch off the fuse in the fuse box.
- ▶ Call customer service. → *Page 42*

An ingress of moisture can cause an electric shock.

- ▶ Only use the appliance in enclosed spaces.
- ▶ Never expose the appliance to intense heat or humidity.
- ▶ Do not use steam- or high-pressure cleaners, hoses or sprays to clean the appliance.

⚠ WARNING – Risk of harm to health!

Children can lock themselves in the appliance, thereby putting their lives at risk.

- ▶ Do not install the appliance behind a door as this may obstruct the appliance door or prevent it from opening.

- ▶ With redundant appliances, unplug the power cord. Then cut through the cord and damage the lock on the appliance door beyond repair so that the appliance door will no longer close.

⚠ WARNING – Risk of suffocation!

Children may breathe in or swallow small parts, causing them to suffocate.

- ▶ Keep small parts away from children.
- ▶ Do not let children play with small parts.

⚠ WARNING – Risk of explosion!

If there is coal dust or flour in the air around the appliance, this may cause an explosion.

- ▶ Keep the area around the appliance clean during operation.

⚠ WARNING – Risk of poisoning!

Condensation water from this appliance is not suitable for drinking and may be contaminated with fluff.

- ▶ Do not drink or reuse the condensation water from the appliance.

Detergents and care products may result in poisoning if consumed.

- ▶ If accidentally swallowed, seek medical advice.
- ▶ Keep detergents and care products out of the reach of children.

⚠ WARNING – Risk of fire!

The refrigerant R290 in this appliance is environmentally friendly yet combustible and may ignite if it comes into contact with open flames or ignition sources.

- ▶ Keep naked flames and ignition sources away from the appliance.



⚠ WARNING – Risk of explosion!

If there is any residual material left in the fluff filter, this may ignite during the drying process.

- ▶ Clean the fluff filter regularly.

Highly flammable objects such as lighters or matches may ignite during the drying process.

- ▶ Remove all highly flammable objects from any pockets in your laundry before the drying process.

Unwashed laundry that has come into contact with solvents, oil, wax, wax remover, paint, grease or stain remover may ignite when drying is in progress.

- ▶ Do not place laundry in this appliance to be dried if the laundry has not been washed first.
- ▶ Rinse the laundry thoroughly with warm water and detergent before drying it in the machine.
- ▶ Do not use the appliance if industrial chemicals have been used to clean the laundry beforehand.

⚠ WARNING – Risk of fire!

If drying is interrupted early, the laundry is not cooled sufficiently and may ignite.

- ▶ Do not interrupt the drying programme early.
- ▶ If drying is interrupted early, remove the laundry immediately and spread it out.

⚠ CAUTION – Risk of injury!

The covering plate may break if you stand on or climb onto the appliance.

- ▶ Do not stand on or climb onto the appliance.

The appliance may tip over if you sit on or lean against the open door.

- ▶ Do not sit on or lean against the appliance door.
- ▶ Do not place any objects on the appliance door.

Reaching into the drum while it is still turning may cause hand injuries.

- ▶ Wait for the drum to come to a complete stop before reaching inside.

1.6 Safe cleaning and maintenance

⚠ WARNING – Risk of electric shock!

Improper repairs are dangerous.

- ▶ Never make any technical modifications to the appliance or its features.

- ▶ Repairs to the appliance should only be carried out by trained specialist staff.
- ▶ Only use genuine spare parts when repairing the appliance.
- ▶ If the power cord of this appliance is damaged, it must be replaced by the manufacturer, the manufacturer's Customer Service or a similarly qualified person in order to prevent any risk.

An ingress of moisture can cause an electric shock.

- ▶ Before cleaning, pull out the mains plug or switch off the fuse in the fuse box.
- ▶ Do not use steam- or high-pressure cleaners, hoses or sprays to clean the appliance.

⚠ WARNING – Risk of injury!

The use of non-original spare parts and non-original accessories is dangerous.

- ▶ Only use the manufacturer's original spare parts and original accessories.

⚠ WARNING – Risk of poisoning!

Poisonous fumes may be given off if you use cleaning agents that contain solvents.

- ▶ Do not use cleaning agents that contain solvents.

2 Preventing material damage

ATTENTION

The functionality of the appliance may be impaired if you use the wrong quantity of fabric softener, detergent, care product or cleaning agent.

- ▶ Follow the dosage recommendations from the manufacturer.

Exceeding the maximum load capacity impairs the function of the appliance.

- ▶ Observe the maximum load capacity for each programme and do not exceed it.

→ "Programmes", Page 21

The function of the appliance may be impaired if the appliance overheats.

- ▶ Keep the ventilation opening on the appliance clear during operation.
- ▶ Make sure that the area is adequately ventilated.

Light objects such as hair and fluff may be sucked in from the ventilation opening on the appliance during operation and impair the function of the appliance.

- ▶ Keep the area around the appliance clean during operation.
- ▶ Keep light objects away from the appliance.

If you operate the appliance without a fluff guard (e.g. fluff filter, fluff collector, filter mat, etc., depending on appliance specifications), or if the

en Environmental protection and saving energy

fluff guard is incomplete or defective, this may result in damage to the appliance.

- ▶ Do not operate the appliance without a fluff guard, or with a fluff guard that is incomplete or defective.

Foam and foam rubber may deform or melt during the drying process.

- ▶ Do not dry laundry that contains foam or foam rubber.

Unsuitable cleaning products may damage the surfaces of the appliance.

- ▶ Do not use harsh or abrasive detergents.
- ▶ Do not use cleaning products with a high alcohol content.
- ▶ Do not use hard scouring pads or cleaning sponges.
- ▶ Clean the appliance with nothing but water and a soft, damp cloth.
- ▶ Remove all detergent residue, spray residue or other residues immediately if they come into contact with the appliance.

3 Environmental protection and saving energy

3.1 Disposing of packaging

The packaging materials are environmentally compatible and can be recycled.

- ▶ Sort the individual components by type and dispose of them separately.

3.2 Saving energy

If you follow these instructions, your appliance will use less power.

- Operate the appliance in a well-ventilated room and keep the vent-

ilation opening on the appliance clear.

- Spin the laundry in the washing machine before drying.
- For each drying process, use the maximum load for the programs. Programmes → *Page 21*
- Do not exceed the programme's maximum load capacity. Programmes → *Page 21*
- After drying, clean the fluff filter. → *"Cleaning the fluff filter", Page 27*
- Deactivate Wi-Fi on the appliance if it is not being used. → *"Deactivating Wi-Fi on the appliance", Page 32*

3.3 Energy saving mode

If you do not use the appliance for a brief period, it automatically switches to energy-saving mode. All displays go out and ▷ flashes.

Energy-saving mode ends when you use the appliance again.

If you do not use the appliance for an extended period, it automatically switches to standby mode.

4 Installation and connection

4.1 Unpacking the appliance

ATTENTION

Objects remaining in the drum that are not designed for operation with the appliance may cause material damage and damage to the appliance.

- ▶ Remove these objects, along with all supplied accessories, from the drum before starting the appliance.

1. Remove any packaging and protective covers completely from the appliance.
→ *"Disposing of packaging"*, Page 10
2. Check the appliance for visible damage.
3. Open the door. → *Page 26*
4. Remove any accessories from the drum.
5. Close the door.

4.2 Contents of package

After unpacking all parts, check for any damage in transit and completeness of the delivery.

ATTENTION

If the appliance is operated with incomplete or defective accessories, the appliance may not be able to operate properly, or this may result in material damage or damage to the appliance.

- ▶ Do not operate the appliance with incomplete or defective accessories.
- ▶ Replace the accessories in question before operating the appliance.
→ *"Accessories"*, Page 23

The delivery consists of the following:

- Tumble dryer
- Accompanying documents
- Wool basket with insert
→ *Page 30*
- Water outlet hose with connection adapter, fixing material and elbow
→ *Page 12*

4.3 Requirements for the installation location

Observe the instructions for the installation location.

ATTENTION

If the appliance is tilted at an angle greater than 40°, residual water may leak out of the appliance and cause material damage.

- ▶ Tilt the appliance carefully.
- ▶ Transport the appliance in an upright position.

If residual water in the appliance freezes, this may cause damage to the appliance.

- ▶ Do not install or operate this appliance anywhere that is liable to experience frost or outdoors.

If the appliance is operated immediately after transportation, the refrigerant contained in the appliance may result in damage to the appliance.

- ▶ Immediately after transporting the appliance, leave it to rest for two hours before putting it into operation.

On the floor

Place the appliance on a clean, level and firm surface.

Align the appliance. → *Page 13*

In a washer-dryer stack

Only use the original connection set from the dryer manufacturer when setting up this appliance in a washer-dryer stack.

- Connection kit → *Page 23*
- Connection kit with pull-out work-top → *Page 24*

This appliance must only be stacked on a washing machine from the same manufacturer. The depth and width of this appliance must correspond with the dimensions of the washing machine.

Do not place the washer-dryer stack on a platform.

Against a wall

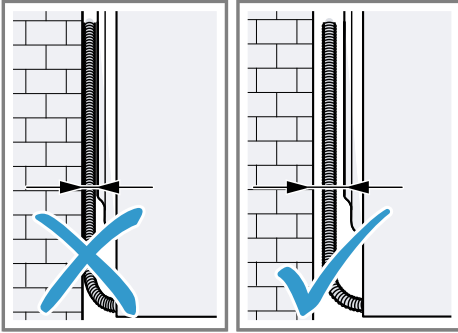

Do not trap the hoses and power cord between the wall and the appliance.

4.4 Water outlet hose

Condensation that forms in the appliance as it dries the laundry is collected by default in the condensation container. Use the water outlet hose to drain away excess condensation directly into the waste water system.

Note: Operate this appliance using the water outlet hose provided.

→ *Page 12*

If you connect the water outlet hose, you do not have to regularly empty the condensation container.

→ *"Emptying the condensation container", Page 28*

Connecting the water outlet hose

If you do not want to regularly empty the appliance's condensation container, connect the water outlet hose.

ATTENTION

When operating the appliance without the condensation hose or water outlet hose being connected properly, liquid may leak out of the connecting piece.

- ▶ Before operating the appliance, connect the condensation hose or

water outlet hose properly to the connecting piece.

Requirements

- The appliance and the accessory have been unpacked. → *Page 10*
 - The appliance is installed at the installation location.
1. Pull out the condensation hose from the connecting piece.

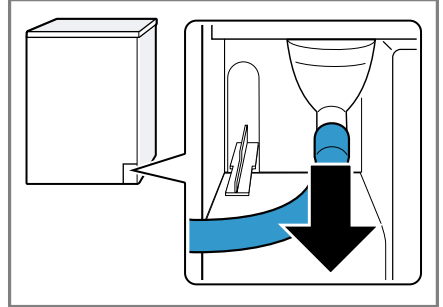

The condensation hose is connected to the connecting piece at the factory.

Note: When removing the condensation hose, liquid may leak out of the connecting piece.

2. Push the condensation hose into the holder.

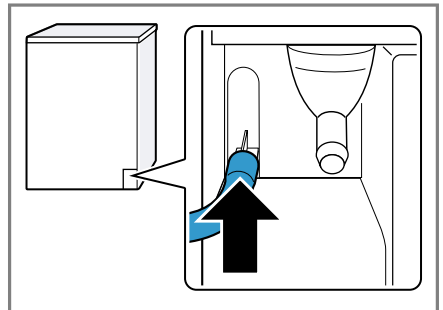

3. Push the water outlet hose as far as it will go into the connecting piece.

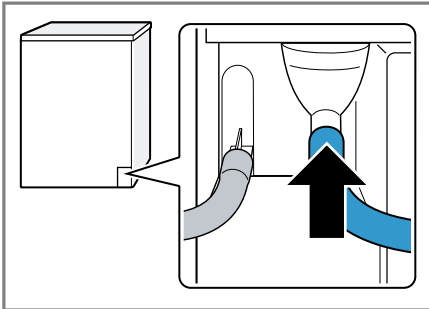

4. Empty the condensation container. → Page 28
5. Remove the stopper from the underside ① and insert it in the recess in the top ②.

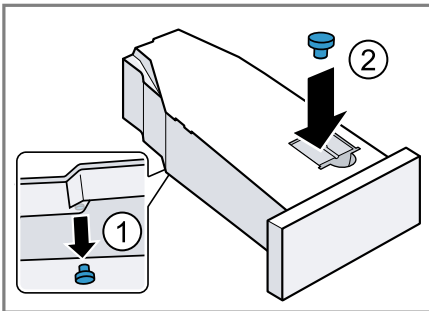

6. Insert the condensation container. → Page 29
7. Connect the appliance to the water drain. → Page 13

Tip: To collect condensation in the condensation container again (e.g. if you change where the appliance is located), carry out these steps in reverse order.

Water outlet connection types

ATTENTION

In the event of a blocked or covered outlet, accumulated wastewater can flow back into the appliance.

- ▶ Before operating the appliance, ensure that the wastewater drains

away quickly and eliminate any blockages.

Drainage into a siphon.

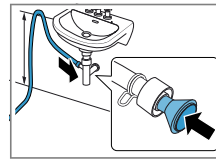

Secure the connection point with a (12-22 mm) hose clamp. Secure the water outlet hose with a hose guide at a height of at least 80 cm and no more than 100 cm.

Note: You can use the Y-distributor → Page 24 to connect the water outlet hose of an additional appliance, such as a washing machine, to the same siphon outlet.

Drainage into a wash basin.

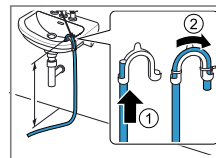

Push the water outlet hose fully through the elbow and secure it using fixing material. Secure the elbow at a height of no more than 100 cm.

Drainage into a gully.

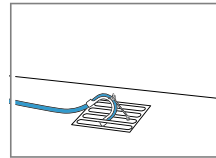

Push the water outlet hose fully through the elbow and secure it using fixing material. Secure the elbow to the gully.

4.5 Aligning the appliance

In order to reduce vibrations and noises, align the appliance correctly.

en Installation and connection

- ▶ To align the appliance, turn the appliance feet. Check that the appliance is level using a spirit level.

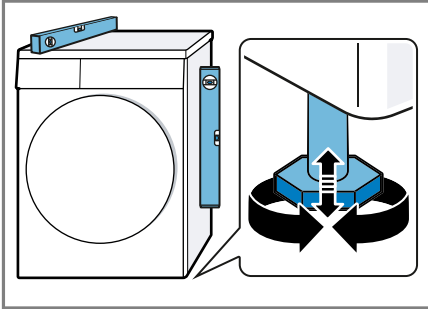

All appliance feet must stand firmly on the ground.

4.6 Reversing the door

Note: You can find more information about changing the door direction online. Scan the QR code on the title page.

4.7 Connecting the appliance to the electricity supply

1. Insert the mains plug of the appliance's power cable in a socket nearby.
The connection details of the appliance can be found under Technical data → *Page 45*.
2. Check the mains plug is inserted properly.
 - ✓ The appliance is now ready for use.

5 Familiarising yourself with your appliance

5.1 Appliance

You can find an overview of the parts of your appliance here.

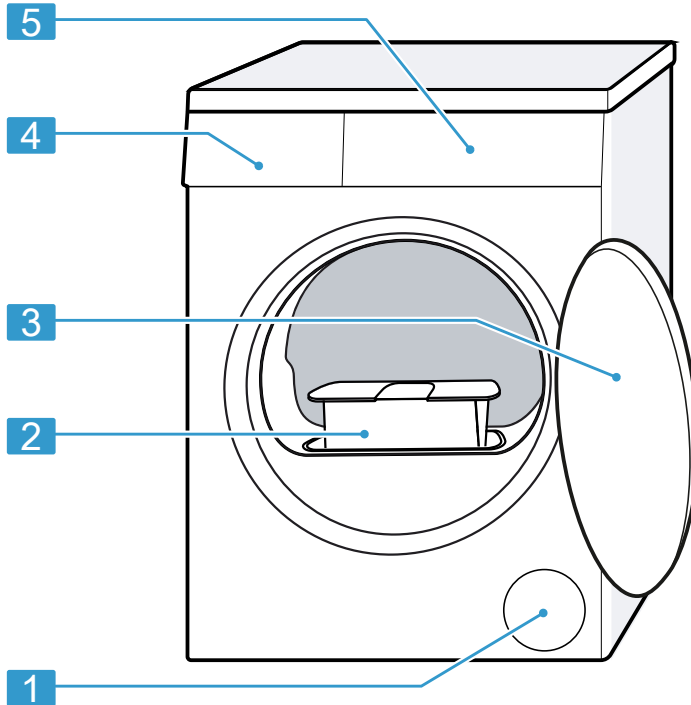

On certain models, specific details such as the colour and shape may differ from those pictured.

1 Ventilation opening

2 Fluff filter → *Page 27*

3 Door → *Page 26*

4 Condensation container
→ *Page 28*

5 Control panel → *Page 16*

5.2 Control panel

You can use the control panel to configure all functions of your appliance and to obtain information about the operating status.

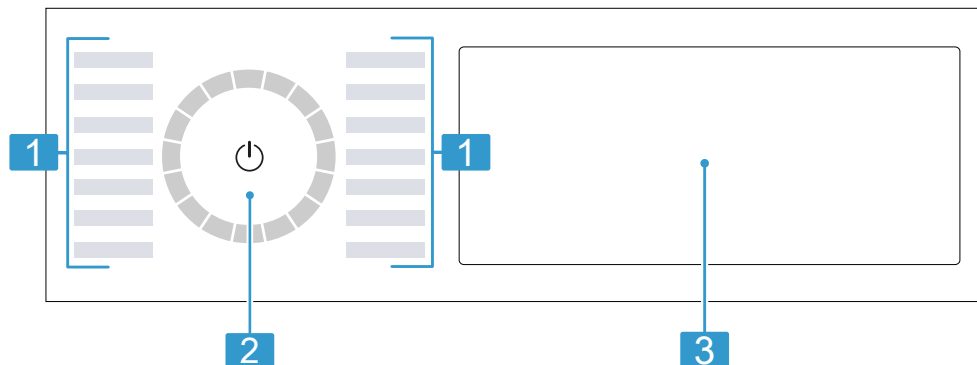

1 Programmes → *Page 21*

2 Programme selector
→ *Page 25*

3 Buttons → *Page 18* and display
→ *Page 16*

5.3 Operating logic

Some areas of the display are buttons and respond to touch. You can activate, deactivate or change settings by pressing the buttons. The activated settings are highlighted brightly on the display.

ATTENTION

Pressing on the display with force may cause damage.

- ▶ Do not apply heavy pressure on the display.
- ▶ Do not press on the display using pointed or sharp objects.

Changing a setting value

If you activate certain settings, the display shows selection buttons and you can change the setting value.

- ▶ Press the selection buttons
→ *Page 19*.
The display shows the setting value.

6 Display

The display shows the current settings, options or relevant information. Depending on the programme status, the display shows some information in the `BB:BB` area, e.g. `E n.d.`

Note: Additional functions may be available as a result of software updates.
→ *Page 33*

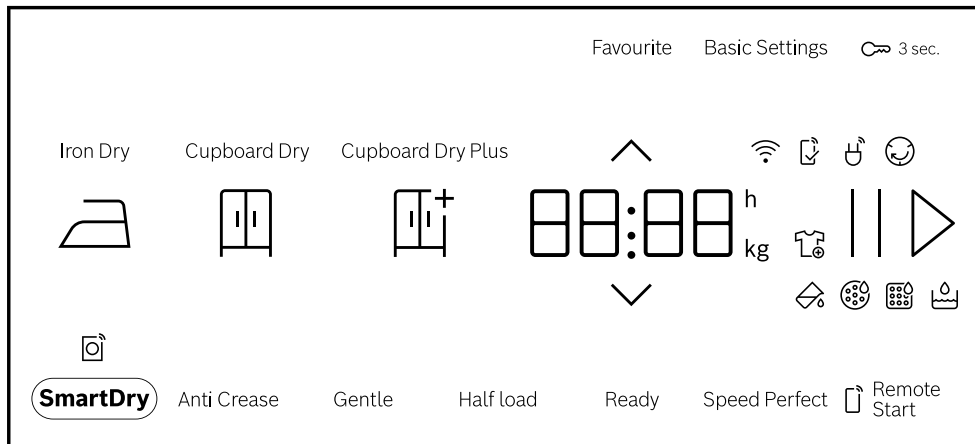

If a software update is available, you can find further information in the Home Connect app.



Example: Display

| Indicator | Description |
|-------------------|---|
| 0:40 ¹ | Expected programme duration or programme time remaining in hours and minutes. |
| 9.0 ¹ | Recommendation for the maximum load capacity for the selected program in kg. |
| 10h ¹ | Programme end time → <i>Page 20</i> |
| | You can remove or add laundry, and interrupt the current programme. → <i>Page 26</i> |
| | Empty and insert the condensation container. → <i>Page 28</i> |
| | Clean the fluff filter → <i>Page 27</i> . |
| CArE | Run the basic appliance care programme. → <i>Page 35</i> |
| Hot | The cooling process cools the laundry independently of the programme status for a few minutes while the drum is rotating, in order to avoid damage to the laundry. The cooling process can be cancelled by opening the door. Note: Do not change the set programme. |
| | <ul style="list-style-type: none"> ■ Lights up: The appliance is connected to your home network via Wi-Fi. ■ Flashes: The appliance is trying to connect to your home network via Wi-Fi. |

¹ Example

| Indicator | Description |
|--|--|
|  | Settings that are not available on the appliance have been set via the Home Connect app. You can find more information in the Home Connect app. |
|  | Programme status: Crease-reduction function |
|  | Programme status: Pause |
| End | Programme status: Programme end |







7 Buttons







Below is an overview of the buttons and their setting options.

Note: Additional functions may be available as a result of software updates.

→ *Page 33*

If a software update is available, you can find further information in the Home Connect app.

| Button | Selection | Description |
|--|--|--|
|  | <ul style="list-style-type: none"> ■ Start ■ Cancel ■ Pause | Start, cancel or pause the programme. If  is displayed, you can pause the programme. If  is displayed, you can start the programme. |
|  | <ul style="list-style-type: none"> ■ Switch on ■ Standby mode ■ Restart the appliance | Switch on the appliance or put it in standby mode. If the control panel does not respond, press and hold  for approximately 5 seconds to restart the appliance. → <i>"The display and buttons do not respond.", Page 39</i> |
|  3 sec. | <ul style="list-style-type: none"> ■ Activate ■ Deactivate | Activate or deactivate the childproof lock. Disable the control panel to prevent unwanted or accidental operation. If the childproof lock is activated and the appliance has been switched |

| Button | Selection | Description |
|---|--|--|
| | | off, the childproof lock remains activated. → <i>"Childproof lock"</i> , <i>Page 30</i> |
|  | Multiple selection | To change a setting, press the  or  selection button until the display shows the required setting. |
| Basic Settings | Multiple selection | → <i>"Basic settings"</i> , <i>Page 34</i> |
| Favourite | <ul style="list-style-type: none"> ▪ Store ▪ Adjust | Press the button for approx. 3 seconds to save your customised programme settings. → <i>"Saving the programme settings"</i> , <i>Page 25</i> If you briefly press the button, you set your saved programme with individual programme settings. |
| Cupboard Dry Plus  | <ul style="list-style-type: none"> ▪ Activate ▪ Deactivate | The dryness level defines how damp or dry the laundry is after the programme ends. → <i>"Dryness level"</i> , <i>Page 29</i> |
| Cupboard Dry  | <ul style="list-style-type: none"> ▪ Activate ▪ Deactivate | The dryness level defines how damp or dry the laundry is after the programme ends. → <i>"Dryness level"</i> , <i>Page 29</i> |
| Iron Dry  | <ul style="list-style-type: none"> ▪ Activate ▪ Deactivate | The dryness level defines how damp or dry the laundry is after the programme ends. → <i>"Dryness level"</i> , <i>Page 29</i> |
| Anti Crease | <ul style="list-style-type: none"> ▪ Activate ▪ Deactivate | Activate or deactivate the crease-reduction function. |

| Button | Selection | Description |
|--|--|--|
| | | Once the programme has ended, the drum moves the laundry at regular intervals for 120 minutes to prevent creasing. |
| Speed Perfect | <ul style="list-style-type: none"> ■ Activate ■ Deactivate | <p>Activate or deactivate a shorter programme duration.</p> <p>Note: Energy consumption and noise emissions increase. This does not impair the drying result.</p> |
| Gentle | <ul style="list-style-type: none"> ■ Activate ■ Deactivate | <p>Activate or deactivate gentle drying. The temperature is reduced for delicate fabrics, e.g. polyacrylic or elastane. The programme duration is extended.</p> |
| Ready | Up to 24 hours | <p>Set the programme end time. The programme duration is already included in the set number of hours. Once the programme has started, the programme duration is displayed.</p> |
| Half load | <ul style="list-style-type: none"> ■ Activate ■ Deactivate | Dry individual items of laundry or small loads of laundry. |
|  SmartDry | Activate | After you have washed your laundry in the washing machine, the dryer recommends a suitable programme for drying the laundry. |

| Button | Selection | Description |
|----------------|---|--|
| | | Note: The washing machine must be compatible with Home Connect. The washing machine and dryer must be connected to your home network and registered in your Home Connect app. |
| ☐ Remote Start | <ul style="list-style-type: none"> ▪ Activate ▪ Deactivate ▪ Opening the Home Connect settings | Activate or deactivate remote start. → <i>Page 33</i> |

8 Programmes

You can dry your fabrics using either an automatic programme or a timed programme.

Notes

- The laundry's care labels provide you with additional information about programme selection.
→ *"Care symbols on the care labels", Page 25*

- Additional functions may be available as a result of software updates. → *Page 33*
If a software update is available, you can find further information in the Home Connect app.

8.1 Automatic programmes

Automatic programmes are programmes in which humidity sensors measure the residual moisture in the laundry during the drying cycle. The programme only ends once the set dryness level is reached.

Each automatic programme has a dryness level → *Page 29*. The dryness level defines how dry or damp the laundry is after the programme ends.

Tip: Select the dryness level according to the type of fabric or the desired drying result.

| Programme | Description | Max. load (kg) |
|-----------|---|----------------|
| Cotton | Dry hard-wearing, heat-resistant fabrics made of cotton or linen. | 9.0 |
| Eco | Dry hard-wearing, heat-resistant fabrics made of cotton or linen. Energy-saving programme. | 9.0 |

| Programme | Description | Max. load (kg) |
|--|---|----------------|
| Easy Care | Dry items made of synthetic materials or blended fabrics. | 3.5 |
| Mix | Dry items made of cotton and synthetics. | 3.0 |
| Bed linen | Dry duvet covers, pillowcases and sheets made of cotton. Note: The drum movement is optimised for drying large items of laundry. | 3.5 |
| Delicate | Dry delicate items made of satin, synthetics or blended fabrics. | 2.0 |
| Hygiene Plus | Dry hard-wearing, heat-resistant fabrics made of cotton or linen. Suitable for increased hygiene requirements. | 4.0 |
| Sport | Dry self-drying sportswear made of performance fibres, microfibres and synthetics. | 1.5 |
| Shirts/Blouses | Suitable for shirts and blouses made of cotton, linen, synthetics or blended fabrics. Note: For optimal drying results, dry a maximum of 5 shirts or 5 blouses at the same time. Once the laundry is dry, iron it or hang it up. The residual moisture is then distributed evenly. | 1.5 |
| Towels | Dry hard-wearing, heat-resistant towels and dressing gowns made of cotton or linen. | 6.0 |
| Silent Dry | Dry hard-wearing, heat-resistant fabrics made of cotton or linen. Suitable for quiet drying. | 9.0 |
|  App programs | Select additional programmes directly via the Home Connect app. A description of the programmes can be found in the Home Connect app. Note: Your appliance must be connected to your home network and registered in your Home Connect app. → <i>Page 32</i> | – |

8.2 Timed programmes

Timed programmes are programmes with a defined or adjustable programme duration. The programme ends once this time has elapsed, even if the laundry is still not dry, for example. Timed programmes are suitable for drying individual items of laundry or thin fabrics.

| Programme | Description | Max. load (kg) |
|--|--|----------------|
| Wool in Basket | Dry items made of wool or containing wool. Note: Dry these items only using the wool basket. → <i>Page 30</i> | 0.5 |
| Time Program Warm | Dry all types of fabric except for wool and silk. Suitable for pre-dried or slightly damp laundry and for drying off multi-layered, thick laundry. Note: This programme is suitable for drying using the wool basket. → <i>Page 30</i> If you are using the wool basket, you can also dry fabrics made from wool using this programme. | 3.0 |
|  App programs | Select additional programmes directly via the Home Connect app. – A description of the programmes can be found in the Home Connect app. Note: Your appliance must be connected to your home network and registered in your Home Connect app. → <i>Page 32</i> | |

9 Accessories

Use original accessories. These have been made especially for your appliance.

Tip: Some accessories are available in other colours. Contact customer service. → *Page 42*

| | Use | Order number |
|----------------|--|--------------|
| Connection kit | To save space, stack the appliance on a suitable washing machine of the same width and depth | WTZ27510 |

| | Use | Order number |
|--------------------------------------|---|---------------------|
| | and that is from the same manufacturer. | |
| Connection kit with pull-out worktop | To save space, stack the appliance on a suitable washing machine of the same width and depth and that is from the same manufacturer. The pull-out worktop makes it easier to load and unload the appliance. | WTZ27500 |
| Wool basket | Dry or air individual wool-len items, sports shoes and soft toys. | WMZ20600 |
| Y-distributor | Connect the water outlet hose of an additional appliance to the same siphon outlet. | 15000490 |
| Appliance care product | Spare part for the intensive appliance care function. | 00312474 |
| Platform | Install the appliance at a raised height so that it can be easily loaded and unloaded. | WTZPW20D |

10 Laundry

10.1 Preparing the laundry

ATTENTION

Objects remaining in the laundry may damage the laundry and the drum.

- ▶ Remove all items from any pockets in your laundry before using the appliance.

Note



The appliance and fabrics are protected when you prepare your laundry.

- Brush off sand and soil

- Sort the laundry according to colour and textiles and observe the care labels
- Close all zips, hook and loop fasteners, hooks and eyes
- Remove curtain fittings and lead strips
- Load the laundry unfolded into the drum
- Spin the laundry before drying
- Dry woollen items, sports shoes and soft toys in the wool basket
Wool basket
→ "Wool basket", Page 30

10.2 Care symbols on the care labels

Drying care symbols

| Symbol | Fabrics |
|---|--|
|  | Items made from cotton and linen, e.g. towels, bed linen, underwear |
|  | Items made from synthetic, blended or delicate fabrics, e.g. functional garments, shirts |
|  | Do not tumble dry items made from silk, nylon, air-impermeable and rubber-coated fabrics, synthetic curtains |

11 Basic operation

11.1 Switching on the appliance

Note: If you switch the appliance on the first time after you have connected it to the electrical system, the switch-on process takes up to one minute.

Requirement: The appliance has been correctly installed and connected. → *Page 10*

- ▶ Press .

The switch-on process takes a few seconds.

Note: The lighting for the drum goes out automatically.

11.2 Setting a programme

1. Press the required programme.
→ *Page 21*

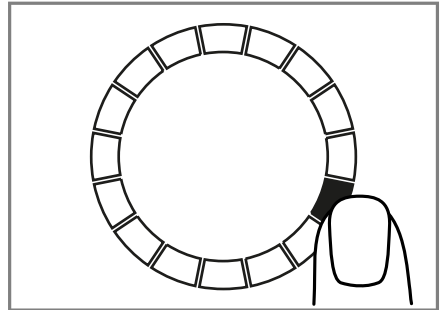

- ✓ The display shows the programme settings.
2. Adjust the programme settings.
→ *Page 18*
Observe the information about operating logic → *Page 16*.
The programme settings are not saved permanently for the programme.

11.3 Saving the programme settings

You can save your individual programme settings as favourites.

Requirement: A programme is set.
→ *Page 25*

- ▶ Press and hold **Favourite** for approx. 3 seconds.
Press **Favourite** to call up the saved programme.

Note: To overwrite the saved programme, repeat the steps above.

11.4 Opening the door

1. Grip under the door handle and pull on the door.

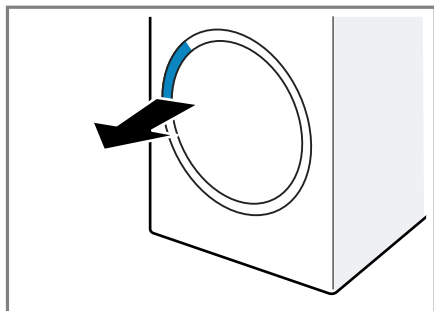

2. Open the door.

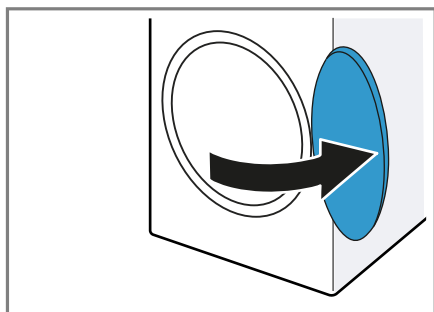

11.5 Loading laundry

Note: To prevent creasing, note the maximum load for the programmes.
→ *Page 21*

Requirements

- The laundry is prepared and sorted. → *Page 24*

- The drum is empty.

1. Open the door. → *Page 26*
2. Place the laundry in the drum.
3. Close the door.

Ensure that there is no laundry trapped in the door.

11.6 Starting the programme

Requirements

- A programme is set. → *Page 25*
- The door is closed.

- ▶ Press **||▷**.
- ✓ The display shows the programme duration or the programme end time.
- ✓ After the programme has ended, the display shows: "End" .

Note: When "Hot" is shown on the display, the appliance cools the laundry.

When "Hot" goes out, the laundry has cooled down.

11.7 Adding laundry

After the programme starts, you can remove or add laundry at any time.

1. Press **||▷**.

The cooling process starts automatically after approximately 30 seconds and cools down the laundry while the drum is rotating. If you want to avoid or cancel the cooling process, open the door.

→ *Page 17*

2. Open the door. → *Page 26*
3. Add or remove laundry.
4. Close the door.
5. Start the programme. → *Page 26*

11.8 Cancelling the programme

1. Press **||▷**.
2. Open the door. → *Page 26*
3. Remove the laundry. → *Page 26*

11.9 Unloading the laundry

1. Open the door. → *Page 26*
2. Remove the laundry from the drum.

11.10 Put the appliance into standby mode

- ▶ Press **⏻**.

11.11 Fluff filter

During drying, fluff from the laundry is collected in the fluff filter. The fluff filter protects the appliance from fluff.

Cleaning the fluff filter

If the drying programme has finished or the display shows a notification while the appliance is in operation, clean the fluff filter after the programme end.

Note: If you do not clean the appliance as described, the appliance's functionality may be impaired.

Requirements

- The display shows the following after drying: "End"
- or the display shows the following during operation: .

1. Open the door. → *Page 26*
2. Remove the fluff from the inside of the door.
3. Remove the two-part fluff filter one part at a time.

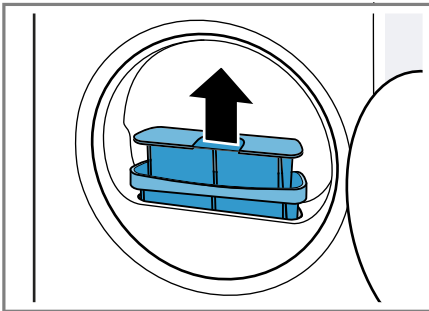

4. Remove the fluff from the recess.

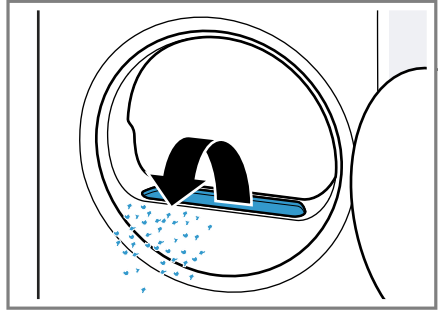

Ensure that no fluff falls into the air channel.

5. Open the two fluff filters ① and remove the fluff ②.

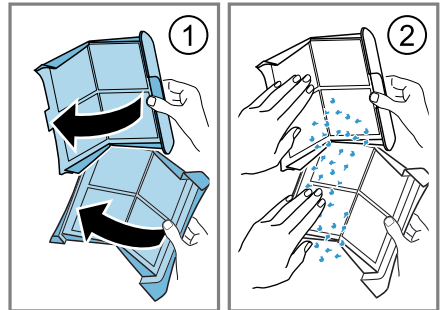

Dispose of the fluff with the household waste in order to prevent the water from being contaminated with microplastics.

6. Clean the two fluff filters thoroughly under warm, running water and then dry them off.

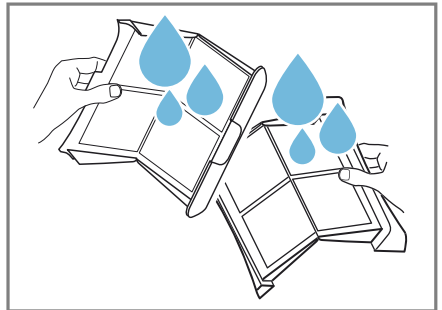

Note: Collect the cleaning water in a container, e.g. a bucket. After

en Basic operation

cleaning, pour the contents of the container through a filter, e.g. a coffee filter.

Dispose of the coffee filter with the household waste in order to prevent the water from being contaminated with microplastics.

7. Close the two fluff filters and put them together.

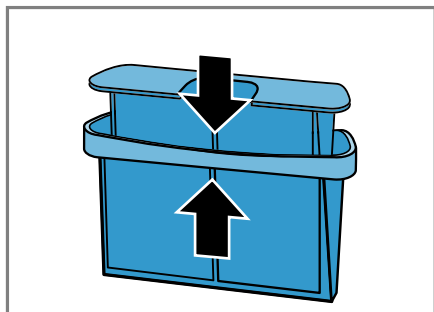

8. Insert the two-part fluff filter.

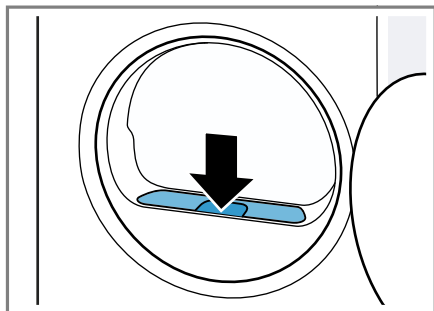

9. Close the door.

11.12 Condensation container

Condensation that forms in the appliance as it dries the laundry is collected by default in the condensation container.

Note: Operate this appliance using the water outlet hose provided.

→ Page 12

If you connect the water outlet hose, you do not have to regularly empty the condensation container.

→ "Emptying the condensation container", Page 28

Emptying the condensation container

If the drying programme has finished or the display shows a notification that the drying programme is paused, empty the condensation container.

Requirements

- The display shows the following after drying: "End"
 - or the display shows the following while operation is paused:  .
1. Pull out the condensation container, keeping it level.

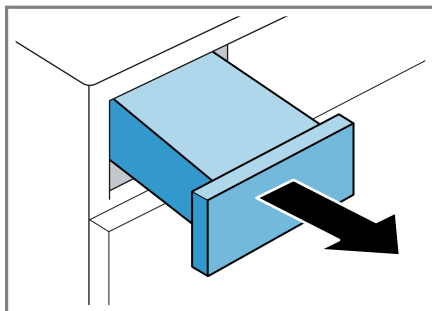

2. Empty the condensation container.

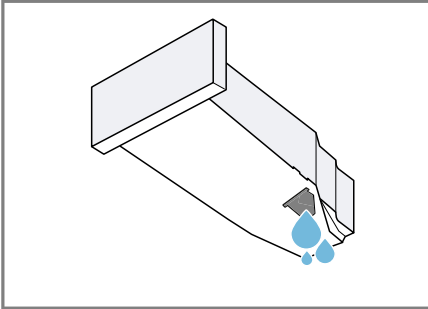

Check the condensation container filter regularly and clean the filter if it is dirty. → *Page 38*

Make sure that you insert the condensation container before operating the appliance. → *Page 29*

3. If the drying programme is paused, start the programme. → *Page 26*

Inserting the condensation container

- ▶ Push the condensation container in as far as it will go.

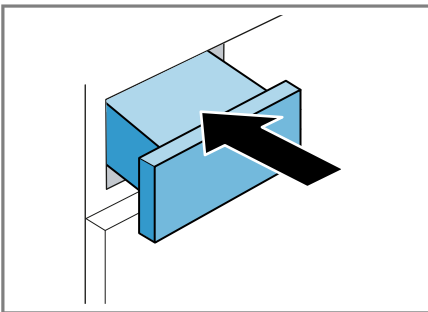

12 Dryness level

Each automatic programme has a specified dryness level. The dryness level defines how dry or damp your laundry is after the programme ends.

| Dryness level | Description |
|---------------|--|
| | For multi-layered, thick laundry that does not dry readily. |
| | For normal, single-layered laundry. |
| | For normal, single-layered laundry. The laundry is still slightly damp after the programme ends. To prevent creasing after drying, iron the laundry or hang it up. |

12.1 Changing the dryness level

For some automatic programmes, you can change the dryness level so that your laundry will be drier or more damp.

1. Set an automatic programme. → *Page 21*
- ✓ The display shows the specified dryness level.
2. Press **Cupboard Dry** , **Cupboard Dry Plus** or **Iron Dry** .





12.2 Adjusting the dryness level

If the laundry feels too damp after it has been dried to a particular dryness level, you can adjust the dryness level.

Note: You can also adjust the dryness level in the basic settings.

1. Set an automatic programme. → *Page 21*
- ✓ The display shows the specified dryness level.

en Childproof lock

2. Press and hold **Cupboard Dry** , **Cupboard Dry Plus**  or **Iron Dry**  for approx. 3 seconds.
 - ✓ The display shows "0", "1", "2" or "3".
3. Press  or  to adjust the dryness level from "0" (dry) to "3" (driest).
4. Press and hold the selected drying target for approx. 3 seconds to return to the automatic programme.

13 Childproof lock

Secure your appliance against being operated unintentionally using the controls.

13.1 Activating the childproof lock

- ▶ Press and hold  **3 sec.** for approx. 3 seconds.
 - ✓ The control elements are locked.
 - ✓ The childproof lock also remains activated when the appliance is in standby mode and in the event of a power cut.

13.2 Deactivating the childproof lock

Requirement: To deactivate the childproof lock, the appliance must be switched on.

- ▶ Press and hold  **3 sec.** for approx. 3 seconds.

14 Wool basket

Use the wool basket to gently dry delicate fabrics, soft toys or sports shoes in a stationary position.

14.1 Inserting the wool basket

1. Open the door.
 - Ensure that the drum is empty.

2. Insert the feet of the wool basket into the holes from the door opening.

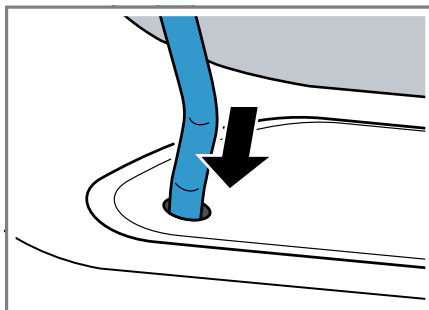

3. Insert the tab on the front of the wool basket into the upper hooks.

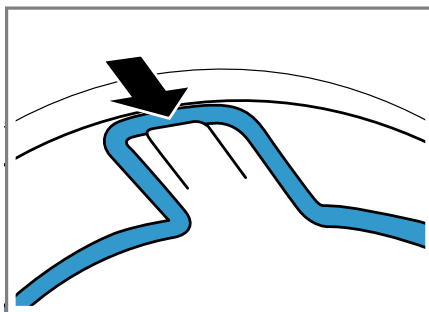

14.2 Starting a programme with the wool basket

ATTENTION

If items of laundry in the wool basket touch the rotating drum or the ribs of the drum, the laundry may cause material damage and damage to the appliance.

- ▶ Place the items of laundry in the insert or wool basket such that they do not touch the drum or the ribs of the drum.

Requirement: The wool basket is inserted into the appliance.

→ Page 30

- Place the laundry into the wool basket, either directly or using the insert. → *Page 31*

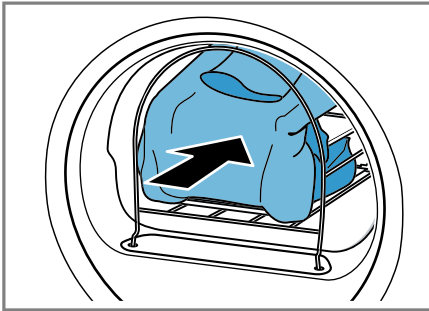

- Close the door.
- Set a programme that is suitable for drying with the wool basket. Observe the programme description. → *Page 23*
- If required, adjust the duration of the programme. Observe the recommended programme duration for items of laundry in the wool basket:

| Laundry item | Programme duration in hours:minutes |
|------------------------|--|
| Thin woollen pullover | Approx. 1:20 |
| Thick woollen pullover | Approx. 1:30 - 3:00 |
| Skirt | Approx. 1:00 - 1:30 |
| Trousers | Approx. 1:00 - 1:30 |
| Gloves | Approx. 0:30 |
| Sports shoes | Approx. 1:30/ max. 2:00 with airing |

Tip: Increase the programme duration for thick or multi-layered items of laundry.

- Start the programme. → *Page 26*
- Remove the wool basket once the programme has ended.

14.3 Examples of how to use the wool basket

ATTENTION

If items of laundry in the wool basket touch the rotating drum or the ribs of the drum, the laundry may cause material damage and damage to the appliance.

- Place the items of laundry in the insert or wool basket such that they do not touch the drum or the ribs of the drum.

Example

Use

Trousers or skirt

Place the items of laundry unfolded into the insert.

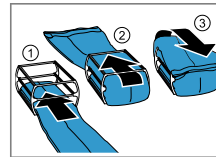

Note: Spin the laundry before drying.

Pullover

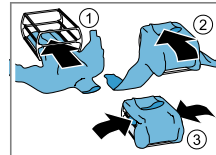

Sports shoes

Lift the tongues of the shoes. Remove the in-soles or heel cushions. Place a rolled-up hand towel in the wool basket to create an inclined surface.

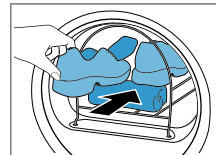

Place the shoes on the towel with the heels facing down.

| Example | Use |
|-----------|--|
| Soft toys | <p>Note: Do not use the insert. Do not dry leather shoes or shoes with leather parts.</p> <p>Place the soft toy in the wool basket.</p> <p>Note: Do not use the insert. If you place numerous or small soft toys in the wool basket, make sure they do not fall out.</p> |

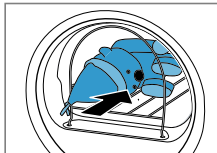

15 Home Connect

This appliance is network-capable. Connecting your appliance to a mobile device lets you control its functions via the Home Connect app, adjust its basic settings and monitor its operating status.

The Home Connect services are not available in every country. The availability of the Home Connect function depends on the availability of the Home Connect services in your country. You can find information about this at: www.home-connect.com.

The Home Connect app guides you through the entire login process. Follow the instructions, noting the information in the Home Connect app.

Notes

- Please note the safety precautions in this instruction manual and make sure that they are also observed when operating the appliance via the Home Connect app.
→ "Safety", Page 3

- Operating the appliance on the appliance itself always takes priority. During this time it is not possible to operate the appliance using the Home Connect app.

15.1 Setting up Home Connect

Requirement: The appliance is receiving signals from the WLAN home network (Wi-Fi) at its installation location.



1. Scan the following QR code.



You can install the Home Connect app and connect your appliance via the QR code.

2. Follow the instructions in the Home Connect app.



15.2 Deactivating Wi-Fi on the appliance

1. Press and hold  **Remote Start** for approx. 3 seconds.
2. Press  **Remote Start** repeatedly until the display shows "on".
3. Press  to deactivate the Wi-Fi.
✓ The display shows "oFF".

Note: To exit the Home Connect settings, press and hold  **Remote Start** for approx. 3 seconds.

15.3 Activating Wi-Fi on the appliance

1. Press and hold  **Remote Start** for approx. 3 seconds.

2. Press  **Remote Start** repeatedly until the display shows "oFF".
 3. Press  to activate the Wi-Fi.
- ✓ The display shows "on".

Notes



- If the Wi-Fi is activated, the display alternately shows "on" and the signal strength of the Wi-Fi connection.
- To exit the Home Connect settings, press and hold  **Remote Start** for approx. 3 seconds.

15.4 Installing the software update

Note: If a software update is available, a message appears in the Home Connect app.

- ▶ To install the software update, follow the instructions in the Home Connect app.
- ✓ The control panel is partially locked during the installation.
- ✓ In the event of a malfunction, installation may take up to 40 minutes. Do not reset the network settings or the appliance to the factory settings.

15.5 Resetting the appliance network settings



1. Press and hold  **Remote Start** for approx. 3 seconds.
 2. Press  **Remote Start** repeatedly until the display shows "rES".
 3. Press and hold  for approx. 3 seconds.
- ✓ The network settings are reset.

15.6 Remote start

Enable the appliance for remote start via the Home Connect app.



Note

Remote start will be deactivated in the following circumstances:

- The appliance door is opened.
-  is pressed.
-  **Remote Start** is pressed.
- Following a power cut.

Activating remote start

Requirement: The appliance door is closed.

- ▶ Press  **Remote Start**.
- ✓  **Remote Start** lights up and the appliance is enabled for remote start via the Home Connect app.

Deactivating remote start

- ▶ Press  **Remote Start**.
- ✓  **Remote Start** goes out.

15.7 Intelligent programme recommendation

When you activate the intelligent programme recommendation, your appliance recommends a suitable programme for drying the laundry once you have washed your laundry in the washing machine.

Intelligent programme recommendation

Requirements

- Your washing machine has the Home Connect function.
 - Your washing machine and your dryer must be connected to your home network and registered in your Home Connect app.
1. Press  **SmartDry**.
- ✓ The appliance detects a suitable programme. To cancel the process, set a different programme or switch the appliance to standby mode.
 - ✓ If the appliance finds a suitable programme, the display for the

en Basic settings

programme lights up and the programme information is displayed.

- ✓ If the appliance does not find a suitable programme, a signal tone sounds and the display shows "- _".
2. Press **||▷**.

15.8 Remote diagnostics

Customer Service can use Remote Diagnostics to access your appliance if you contact them, have your appliance connected to the Home Connect server and if Remote Diagnostics is available in the country in which you are using the appliance.

Tip: For further information and details about the availability of Remote Diagnostics in your country, please visit the service/support section of your local website: www.home-connect.com.

15.9 Data protection

Please see the information on data protection.

The first time your appliance is registered on a home network connected to the Internet, your appliance will transmit the following types of data to the Home Connect server (initial registration):

- Unique appliance identification (consisting of appliance codes as well as the MAC address of the installed Wi-Fi communication module).
- Security certificate of the Wi-Fi communication module (to ensure a secure data connection).
- The current software and hardware version of your appliance.
- Status of any previous resetting to factory settings.

This initial registration prepares the Home Connect functions for use and is only required when you want to use the Home Connect functions for the first time.

Note: Please note that the Home Connect functions can only be utilised with the Home Connect app. Information on data protection can be retrieved in the Home Connect app.

16 Basic settings

You can configure the basic settings for your appliance to meet your needs.

Note: You can also adjust the basic settings in the Home Connect app.

16.1 Overview of the basic settings

Note: Additional functions may be available as a result of software updates. → *Page 33*

If a software update is available, you can find further information in the Home Connect app.

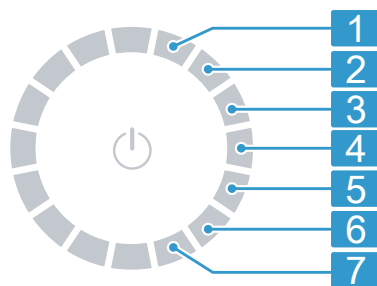

Programme selector with programme positions

-
- 1** Set the volume of the signal at the end of the programme: 0 (off) to 4 (very loud)
-

-
- 2** Set the volume of the signal tone emitted when the buttons are pressed:
0 (off) to 4 (very loud)
-
- 3** Set the display brightness:
1 (low) to 4 (very high)
-
- 4** Adjust the dryness level
→ *Page 29*:
0 (dry) to 3 (driest)
-
- 5** Start the basic (CP1) or intensive (CP2) appliance care programme.
→ *"Appliance care", Page 35*
-
- 6** Display the number of started programmes (PC).
-
- 7** Restore the appliance to the factory settings (rES).
-

16.2 Changing the basic settings

- To call up the basic settings, press **Basic Settings**.
- Use the programme selector to select the required basic setting.
→ *Page 34*
- Adjust the basic setting:
 - ▶ To change the value, press \wedge or \vee .
 - ▶ To reset the appliance to the factory settings, press and hold $\text{||}\triangleright$ for approx. 3 seconds.
- To exit the basic settings, press **Basic Settings**.

17 Appliance care

The appliance offers cleaning programmes for basic and intensive appliance care.

To remove light dirt deposits in the appliance, you can run the basic appliance care programme when the display shows "CaRE " after a longer period of use.

Note: The basic appliance care programme runs for approximately 1 hour.

To remove any stubborn dirt deposits in the appliance and odours after a downtime of more than one month, you can run the intensive appliance care programme.

Notes

- The intensive appliance care programme runs for approximately 4 hours and must not be cancelled.
- When you run the intensive appliance care programme, you need the original appliance care product
→ *Page 24*.

17.1 Preparing for appliance care

Preparing the appliance

Requirement: The drum is empty.

- Put the appliance into standby mode. → *Page 26*
- Clean the fluff filter → *Page 27*.
- Empty the condensation container.
→ *Page 28*

Preparing the condensation container

If you drain the condensation using the water outlet hose, prepare the condensation container.

1. Remove the stopper from the recess in the top ① and insert it in the underside ②.

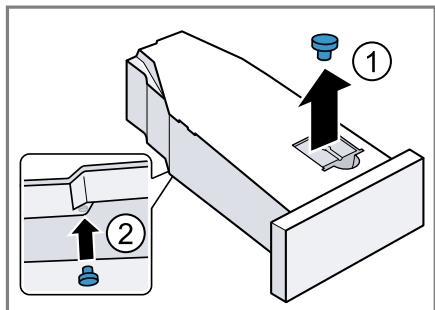

2. Clean the filter in the condensation container.

17.2 Running the basic appliance care programme

Requirement: The appliance care is prepared. → *Page 35*

1. Pour approx. 1.5 litres of hot mains water into the condensation container.
Hold the filled condensation container level so that no liquid spills out.
2. Insert the condensation container so that it locks into place.
3. Switch on the appliance.
4. Press **Basic Settings**.
5. Set the programme selector to position 5. → *Page 34*
 - ✓ "CP1" and the programme duration alternate on the display.
6. Press **|| ▷**.
 - ✓ The appliance care programme starts and a signal tone sounds.
 - ✓ "End" appears on the display and a signal tone sounds once the appliance care programme has ended.
7. Empty the condensation container. → *Page 28*
8. If you drain the condensation using the water outlet hose, remove the

stopper from the underside of the condensation container and insert it into the recess in the top of the condensation container. → *Page 35*

9. Insert the condensation container so that it locks into place.
10. Put the appliance into standby mode. → *Page 26*

17.3 Running the intensive appliance care programme

Starting the intensive appliance care programme

Requirement: The appliance care is prepared. → *Page 35*

1. Pour a bottle of the appliance care product and approx. 1.5 litres of hot mains water into the condensation container.
Hold the filled condensation container level so that no liquid spills out.
2. Insert the condensation container so that it locks into place.
3. Switch on the appliance.
4. Press **Basic Settings**.
5. Set the programme selector to position 5. → *Page 34*
 - ✓ "CP1" and the programme duration alternate on the display.
6. Press **∨**.
 - ✓ "CP2" and the programme duration alternate on the display.
7. Press **|| ▷**.
 - ✓ The appliance care programme starts and a signal tone sounds.
 - ✓ After around 3 hours, the appliance pauses the appliance care programme and the remaining programme duration flashes on the display.
8. Empty the condensation container. → *Page 28*

9. Pour approx. 1.5 litres of hot mains water into the condensation container.
10. Carefully swivel the condensation container horizontally and empty it to rinse out any remaining appliance care product.

Continuing the intensive appliance care programme

1. Pour approx. 1.5 litres of hot mains water into the condensation container.
Hold the filled condensation container level so that no liquid spills out.
2. Insert the condensation container so that it locks into place.
3. Press **||▷**.
 - ✓ The appliance care programme continues.
 - ✓ "End" appears on the display and a signal tone sounds once the appliance care programme has ended.
4. Empty the condensation container. → *Page 28*
5. If you drain the condensation using the water outlet hose, remove the stopper from the underside of the condensation container and insert it into the recess in the top of the condensation container. → *Page 35*
6. Put the appliance into standby mode. → *Page 26*

18 Cleaning and servicing

To keep your appliance working efficiently for a long time, it is important to clean and maintain it carefully.

18.1 Moisture sensor

The moisture sensor in this appliance measures how damp the laundry is during the drying cycle. The appliance changes the duration of the automatic programme depending on the residual moisture in the laundry.

Cleaning the moisture sensor

Over time, residue from limescale, detergents and care products can build up on the moisture sensor. Clean the moisture sensor regularly.

ATTENTION

Hard or rough objects may damage the moisture sensor.

- ▶ Do not use hard or rough objects, abrasive cleaning products or steel wool for cleaning.

Note: If you do not clean the appliance as described, the appliance's functionality may be impaired.

1. Open the door.
2. Clean the moisture sensor with a sponge.

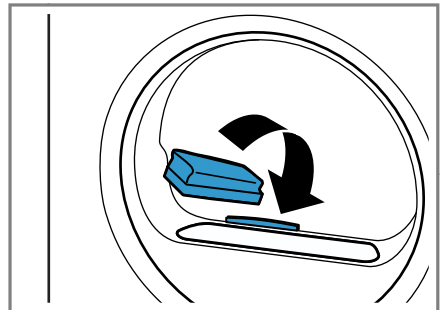

18.2 Condensation container filter

During drying, fluff from the laundry gets into the condensation. The filter in the condensation container protects the appliance from fluff.

Clean the filter for the condensation tank.

The filter is cleaned automatically when the condensation container is emptied. Check the filter regularly and clean the filter if it is dirty.

1. Empty the condensation container.
→ *Page 28*
2. Remove the filter.

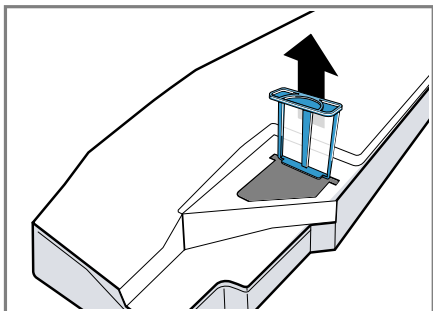

3. Clean the filter under warm, running water.
Note: Collect the cleaning water in a container, e.g. a bucket. After

cleaning, pour the contents of the container through a filter, e.g. a coffee filter.
Dispose of the coffee filter with the household waste in order to prevent the water from being contaminated with microplastics.
You can also clean the filter in the dishwasher.

4. Slide in the filter as far as it will go.

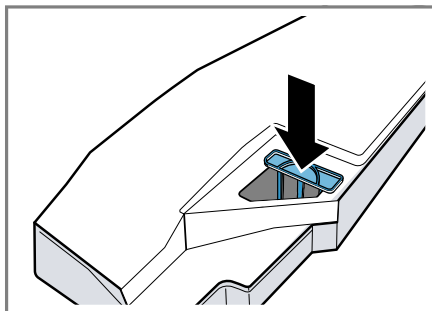

5. Insert the condensation container.
→ *Page 29*

19 Troubleshooting



You can rectify minor faults on your appliance yourself. Read the troubleshooting information before contacting after-sales service. This will avoid unnecessary costs.



WARNING

Risk of electric shock!

Improper repairs are dangerous.

- ▶ Never make any technical modifications to the appliance or its features.
- ▶ Repairs to the appliance should only be carried out by trained specialist staff.
- ▶ Only use genuine spare parts when repairing the appliance.
- ▶ If the power cord of this appliance is damaged, it must be replaced by the manufacturer, the manufacturer's Customer Service or a similarly qualified person in order to prevent any risk.

| Fault | Cause and troubleshooting |
|---|---|
| The display goes out and  flashes. | Energy-saving mode is active ▶ Press  . |

| Fault | Cause and troubleshooting |
|---|---|
| All other error codes. | Malfunction <ol style="list-style-type: none"> 1. To restart the appliance, press and hold ϕ for approximately 5 seconds. 2. If the fault occurs again, disconnect the appliance from the power supply for at least 30 seconds. Unplug the appliance from the mains or switch off the circuit breaker in the fuse box. 3. If the fault persists, call customer service. → <i>Page 42</i> Please specify the exact error message when calling. If possible, document the fault with photos and videos. |
| "Hot" and the drum rotates. | Not a fault. The cooling process is active. No action required. <p>Note: Do not change the programme during the cooling process. The cooling process takes up to 10 minutes.</p> |
|  and programme terminated. | The condensation container is full. <ul style="list-style-type: none"> ▶ Empty the condensation container. → <i>Page 28</i> <hr/> The water outlet hose is not connected correctly, or is kinked or trapped. <ul style="list-style-type: none"> ▶ Check the installation of the water outlet hose. → <i>Page 12</i> <hr/> Water outlet hose is blocked. <ul style="list-style-type: none"> ▶ Rinse the water outlet hose with tap water. <hr/> The filter for the condensation tank is soiled. <ul style="list-style-type: none"> ▶ Clean the filter for the condensation container. → <i>Page 38</i> |
| "CArE" | The basic appliance care programme should be run. <ul style="list-style-type: none"> ▶ Run the basic appliance care programme → <i>Page 35</i>. |
|  | Fluff filter is soiled. <ul style="list-style-type: none"> ▶ Clean the fluff filter. → <i>Page 27</i> |
| The display and buttons do not respond. | Software fault. <ol style="list-style-type: none"> 1. To restart the appliance, press and hold ϕ for approximately 5 seconds. 2. If the fault occurs again, disconnect the appliance from the power supply for at least 30 seconds. Unplug the appliance from the mains or switch off the circuit breaker in the fuse box. |

| Fault | Cause and troubleshooting |
|--|---|
| Home Connect is not working properly. | Different causes are possible. <ol style="list-style-type: none"> 1. Reset the appliance network settings. → <i>Page 33</i> 2. Set up Home Connect again. → <i>Page 32</i> ▶ Go to <i>www.home-connect.com</i> . |
| The programme does not start. | Childproof lock is activated. <ul style="list-style-type: none"> ▶ Deactivate the childproof lock. → <i>Page 30</i> Ready is activated. <ul style="list-style-type: none"> ▶ Check whether Ready is activated. → <i>Page 20</i> |
| The length of the programme changes during the drying cycle. | Not a fault. The programme sequence is optimised electronically. No action required. |
| The drying time is too long. | Fluff filter is soiled. <ul style="list-style-type: none"> ▶ Clean the fluff filter. → <i>Page 27</i> The ambient temperature is lower than 15 °C or higher than 30 °C. <ul style="list-style-type: none"> ▶ Ensure that the ambient temperature is between 15 °C and 30 °C. The air circulation at the appliance's installation location is insufficient. <ul style="list-style-type: none"> ▶ Ventilate the appliance's installation location. Insufficient condensation for the automatic self-cleaning when permanently drying small loads of laundry. <ul style="list-style-type: none"> ▶ Regularly dry a load weighing more than 3 kg of damp laundry until the programme ends. The appliance's ventilation opening is blocked. <ul style="list-style-type: none"> ▶ Ensure that the ventilation opening of the appliance is kept clear. Heat exchanger is soiled. <ul style="list-style-type: none"> ▶ Run the basic appliance care programme → <i>Page 35</i>. |
| Drum movement direction changes during drying. | Not a fault. The laundry is better distributed for optimum drying results. No action required. |
| Humming, whirring or pumping noises. | Not a fault. The compressor, compressor ventilation or condensation pump is active. No action required. |
| The laundry is too damp. | The selected programme is unsuitable for the type of fabric. <ul style="list-style-type: none"> ▶ Set a time programme for subsequent drying. → <i>Page 23</i> |

| Fault | Cause and troubleshooting |
|--------------------------------------|--|
| The laundry is too damp. | <p>The load is too large.</p> <ul style="list-style-type: none"> ▶ Observe the programme's maximum load capacity. → <i>Page 21</i> |
| | <p>After the end of the programme, warm laundry feels damper than it actually is.</p> <ol style="list-style-type: none"> 1. Remove the laundry from the drum as soon as the drying programme has finished. 2. Spread the items of laundry for cooling. |
| | <p>The selected dryness level is unsuitable.</p> <ul style="list-style-type: none"> ▶ Change the dryness level. → <i>Page 29</i> |
| | <p>The dryness level is not adjusted.</p> <ul style="list-style-type: none"> ▶ Adjust the dryness level. → <i>Page 29</i> |
| | <p>The load is too small.</p> <ul style="list-style-type: none"> ▶ Set a time programme for subsequent drying. → <i>Page 23</i> |
| | <p>The moisture sensor is dirty.</p> <ul style="list-style-type: none"> ▶ Clean the moisture sensor. → <i>Page 37</i> |
| | <p>The appliance has interrupted the drying process due to the condensation container being full.</p> <ul style="list-style-type: none"> ▶ Empty the condensation container. → <i>Page 28</i> |
| Creasing. | <p>The selected programme is unsuitable for the type of fabric.</p> <ul style="list-style-type: none"> ▶ Set a suitable programme. → <i>Page 21</i> |
| | <p>The load is unsuitable.</p> <ul style="list-style-type: none"> ▶ Observe the programme's maximum load capacity. → <i>Page 21</i> ▶ Prepare the laundry. → <i>Page 24</i> |
| | <p>The laundry lies in the drum for too long after drying.</p> <ol style="list-style-type: none"> 1. Remove the laundry from the drum as soon as the drying programme has finished. 2. Spread the items of laundry for cooling. |
| | <p>Easy Care fabrics have been dried for too long.</p> <ul style="list-style-type: none"> ▶ Change or adjust the dryness level. → <i>Page 29</i> |
| | <p>The crease-reduction function is not activated.</p> <ul style="list-style-type: none"> ▶ Activate the crease-reduction function. → <i>Page 18</i> |
| Water is leaking from the appliance. | <p>Appliance is not correctly aligned.</p> <ul style="list-style-type: none"> ▶ Align the appliance. → <i>Page 13</i> |
| | <p>Water outlet hose is not connected correctly.</p> <ul style="list-style-type: none"> ▶ Check the installation of the water outlet hose. → <i>Page 12</i> |

| Fault | Cause and troubleshooting |
|--|---|
| Condensation collects in the condensation container despite the water outlet hose being connected. | <p>Not a fault. The remaining volume of condensation may remain in the condensation container. No action required.</p> <hr/> <p>Water outlet hose is not connected correctly.</p> <ul style="list-style-type: none"> ▶ Check the installation of the water outlet hose. <p>→ Page 12</p> |
| Odours have formed in the appliance. | <p>Stubborn dirt in the appliance or an extended appliance downtime of more than one month.</p> <ul style="list-style-type: none"> ▶ Run the intensive appliance care programme. <p>→ Page 35</p> |

20 Transportation, storage and disposal

20.1 Disposing of old appliance

Valuable raw materials can be re-used by recycling.

⚠ WARNING
Risk of harm to health!

Children can lock themselves in the appliance, thereby putting their lives at risk.

- ▶ Do not install the appliance behind a door as this may obstruct the appliance door or prevent it from opening.
- ▶ With redundant appliances, unplug the power cord. Then cut through the cord and damage the lock on the appliance door beyond repair so that the appliance door will no longer close.

⚠ WARNING
Risk of fire!

The refrigerant R290 used in this appliance is environmentally friendly. It is however flammable and may ignite if appliances are not disposed of properly.

- ▶ Dispose of the appliance properly.

- ▶ Do not damage the tubing of the refrigerant circuit.
1. Unplug the appliance from the mains.
 2. Cut through the power cord.
 3. Dispose of the appliance in an environmentally friendly manner.
- Information about current disposal methods are available from your specialist dealer or local authority.



This appliance is labelled in accordance with European Directive 2012/19/EU concerning used electrical and electronic appliances (waste electrical and electronic equipment - WEEE). The guideline determines the framework for the return and recycling of used appliances as applicable throughout the EU.

21 Customer Service

Function-relevant genuine spare parts according to the corresponding Eco-design Order can be obtained from Customer Service for a period of at

least 10 years from the date on which your appliance was placed on the market within the European Economic Area.

Note: Under the terms of the manufacturer's warranty the use of Customer Service is free of charge.

Detailed information about the warranty period and the warranty conditions in your country is available via the QR code on the enclosed document on service contacts and warranty conditions, from our customer service or on our website.

If you contact Customer Service, you will require the product number (E-Nr.), the production number (FD) and the consecutive numbering (Z-Nr.) of your appliance.

You can find the contact details for our customer service via the QR code on the enclosed document on

service contacts and warranty conditions or on our website.

21.1 Product number (E-Nr.), production number (FD) and consecutive numbering (Z-Nr.)

You can find the product number (E-Nr.), the production number (FD) and the consecutive numbering (Z-Nr.) on the appliance's rating plate.

Depending on the model, the rating plate is located:

- On the inside of the door.
- On the inside of the maintenance flap.
- On the rear of the appliance.

Make a note of your appliance's details and the Customer Service telephone number to find them again quickly.

22 Consumption values

The **Eco** programme is suitable for drying cotton laundry with a normal dampness level, and is the most efficient programme for drying damp cotton laundry in terms of combined energy consumption. This programme serves to assess compliance with Regulations (EU) 2023/2533 and (EU) 2023/2534. It corresponds to the "standard cotton programme" within the meaning of Regulation (EU) No 392/2012 and within the meaning of Annex I, point 1.1 of Regulation (EU) No 932/2012. The consumption values for this programme that are declared on the energy label refer to a moisture content of the laundry of 60%. The values specified for other programmes are indicative only and were determined in accordance with the applicable standard EN61121.

The actual values may deviate from the indicated values depending on the type of fabric, composition of laundry to be dried, residual moisture in the fabric, set degree of dryness, amount of laundry being loaded, environmental conditions and the activation of additional functions.

The expected programme duration/"Ready in" time that is shown on the appliance display when selecting the programme is based on the spin speed in the washing machine of 1000 rpm when the appliance is delivered.

| Programme | Final mois- ture level (%) | Load (kg) | Spin speed (rpm) | Initial mois- ture level (%) | Pro- gramm e dura- tion (h:min) | Energy con- sump- tion (kWh/ cycle) |
|--|---|----------------------|---------------------------------|---|--|--|
| Cotton + Cupboard Dry Plus [†] | -3.0 | 9.0 | 1400 | 50 | 4:42 | 1.47 |
| Cotton + Cupboard Dry Plus [†] | -3.0 | 4.5 | 1400 | 50 | 3:35 | 1.05 |
| Cotton + Cupboard Dry Plus [†] | -3.0 | 9.0 | 1000 | 60 | 5:12 | 1.68 |
| Cotton + Cupboard Dry Plus [†] | -3.0 | 4.5 | 1000 | 60 | 3:52 | 1.16 |
| Cotton + Cupboard Dry Plus [†] | -3.0 | 9.0 | 800 | 70 | 5:43 | 1.89 |
| Cotton + Cupboard Dry Plus [†] | -3.0 | 4.5 | 800 | 70 | 4:09 | 1.26 |
| Cotton + Cupboard Dry [†] | -1.5 | 9.0 | 1400 | 50 | 4:13 | 1.39 |
| Cotton + Cupboard Dry [†] | -1.5 | 4.5 | 1400 | 50 | 3:03 | 0.90 |
| Cotton + Cupboard Dry [†] | -1.5 | 9.0 | 1000 | 60 | 4:43 | 1.59 |
| Cotton + Cupboard Dry [†] | -1.5 | 4.5 | 1000 | 60 | 3:19 | 0.99 |
| Cotton + Cupboard Dry [†] | -1.5 | 9.0 | 800 | 70 | 5:12 | 1.79 |
| Cotton + Cupboard Dry [†] | -1.5 | 4.5 | 800 | 70 | 3:35 | 1.09 |
| Eco | 0.0 | 9.0 | 1400 | 50 | 3:53 | 1.23 |
| Eco | 0.0 | 4.5 | 1400 | 50 | 2:22 | 0.65 |
| Eco ¹ | 0.0 | 9.0 | 1000 | 60 | 4:25 | 1.44 |
| Eco | 0.0 | 4.5 | 1000 | 60 | 2:40 | 0.76 |
| Eco | 0.0 | 9.0 | 800 | 70 | 4:57 | 1.65 |
| Eco | 0.0 | 4.5 | 800 | 70 | 2:58 | 0.87 |
| Cotton + Iron Dry [⊃] | 12.0 | 9.0 | 1400 | 50 | 2:42 | 0.83 |
| Cotton + Iron Dry [⊃] | 12.0 | 4.5 | 1400 | 50 | 1:44 | 0.49 |

¹ The acoustical noise emissions during the drying cycle are 56 dB.

| Programme | Final moisture level (%) | Load (kg) | Spin speed (rpm) | Initial moisture level (%) | Programme duration (h:min) | Energy consumption (kWh/cycle) |
|---|--------------------------|-----------|------------------|----------------------------|----------------------------|--------------------------------|
| Cotton + Iron Dry \triangleleft | 12.0 | 9.0 | 1000 | 60 | 3:12 | 1.04 |
| Cotton + Iron Dry \triangleleft | 12.0 | 4.5 | 1000 | 60 | 2:01 | 0.59 |
| Cotton + Iron Dry \triangleleft | 12.0 | 9.0 | 800 | 70 | 3:43 | 1.25 |
| Cotton + Iron Dry \triangleleft | 12.0 | 4.5 | 800 | 70 | 2:18 | 0.69 |
| Easy Care + Cupboard Dry Plus \square | 0.0 | 3.5 | 800 | 40 | 1:41 | 0.45 |
| Easy Care + Cupboard Dry Plus \square | 0.0 | 3.5 | 600 | 50 | 1:57 | 0.53 |
| Easy Care + Cupboard Dry \square | 2.0 | 3.5 | 800 | 40 | 1:22 | 0.38 |
| Easy Care + Cupboard Dry \square | 2.0 | 3.5 | 600 | 50 | 1:38 | 0.46 |
| Easy Care + Iron Dry \triangleleft | 12.0 | 3.5 | 800 | 40 | 1:04 | 0.37 |
| Easy Care + Iron Dry \triangleleft | 12.0 | 3.5 | 600 | 50 | 1:20 | 0.46 |
| Delicate | 0.0 | 2.0 | - | - | 1:17 | 0.35 |
| Wool in Basket | 0.0 | 0.5 | - | - | 2:00 | 0.99 |

23 Technical data

| | |
|----------------------------------|------------------|
| Appliance height | 84.2 cm |
| Appliance width | 59.8 cm |
| Appliance depth | 61.3 cm |
| Appliance depth with door closed | 65.1 cm |
| Appliance depth with door open | 110.5 cm |
| Weight | 56.4 kg |
| Maximum load | 9.0 kg |
| Mains voltage | 220-240 V, 50 Hz |

\Rightarrow Minimum installation protection

10 A

Nominal power 800 W

Power consumption ■ Standby mode: 0.30 W

Ambient temperature ■ Minimum: 5 °C
■ Maximum: 35 °C

Length of the power cord 145 cm

This product contains light sources from energy efficiency class F. These light sources are available as a spare

en Technical data

part and must only be replaced by trained specialist staff.

More information about your model can be found online at <https://eprel.ec.europa.eu/qr/2274343>¹.

This web address is linked to the official EU EPREL product database.

offer support and spare parts for the relevant appliance.

23.1 Information regarding Free and Open Source Software

This product includes software components that are licensed by the copyright holders as free or open source software.

The applicable licence information is stored on your home appliance. You can also access the applicable licence information via your

Home Connect app: "Profile -> Legal information -> Licence Information".²

You can download the licence information on the brand product website. (Please search on the product website for your appliance model and additional documents). Alternatively, you can request the relevant information from oss-request@bshg.com or BSH Hausgeräte GmbH, Carl-Wery-Str. 34, 81739 Munich, Germany.

The source code will be made available to you on request.

Please send your request to oss-request@bshg.com or BSH Hausgeräte GmbH, Carl-Wery-Str.34, 81739 Munich, Germany.

Subject: „OSSREQUEST“

The cost of performing your request will be charged to you. This offer is valid for three years from the date of purchase or at least as long as we

¹ Only applies to countries in the European Economic Area. This website address is available from 1st July 2025.

² Depending on the appliance specifications

24 Declaration of Conformity

BSH Hausgeräte GmbH hereby declares that the appliance with Home Connect functionality conforms to the essential requirements and other relevant provisions of Directive 2014/53/EU.

A detailed RED Declaration of Conformity can be found online at www.bosch-home.com among the additional documents on the product page for your appliance.



Hereby, BSH Hausgeräte GmbH declares that the appliance with Home Connect functionality is in compliance with relevant statutory requirements.¹

A detailed Declaration of Conformity can be found online at www.bosch-home.co.uk among the additional documents on the product page for your appliance.¹



2.4 GHz band (2400–2483.5 MHz): Max. 100 mW

5-GHz band (5150–5350 MHz + 5470–5725 MHz): max. 150 mW

| | | | | | | | | | |
|--|----|----|----|----|----|---------|----|----|----|
| | BE | BG | CZ | DK | DE | EE | IE | EL | ES |
| | FR | HR | IT | CY | LI | LV | LT | LU | HU |
| | MT | NL | AT | PL | PT | RO | SI | SK | FI |
| | SE | NO | CH | TR | IS | UK (NI) | | | |

5 GHz WLAN (Wi-Fi): For indoor use only.

| | | | | | | | |
|----|----|----|----|----|----|----|----|
| AL | BA | MD | ME | MK | RS | UK | UA |
|----|----|----|----|----|----|----|----|

5 GHz WLAN (Wi-Fi): For indoor use only.

24.1 Statement of Compliance for Great Britain

The full Statement of Compliance according to the Product Security and Telecommunications Infrastructure (Security Requirements for Relevant Connectable Products) Regulations 2023 can be found online at www.bosch-home.co.uk among the additional documents on the product page for your appliance.

Product type

This statement of compliance covers the products described in this information for use whose model identifier group is seen on the title page. The full model identifier is made up of the characters before the slash in the product number (E no.) which can be found on the rating plate. Alternatively, you can also find the model identifier in the first line of the UK Energy Label.

¹ Only applies to Great Britain

Name and address of manufacturer

BSH Hausgeräte GmbH, Carl-Wery-Strasse 34, 81739 München, Germany

This statement of compliance is prepared by the manufacturer.

The manufacturer, BSH Hausgeräte GmbH deems that it has complied with

- provision 5.1-1 of ETSI EN 303 645 v2.1.1 and, where relevant, provision 5.1-2 of ETSI EN 303 645 v2.1.1;
- provision 5.2-1 of ETSI EN 303 645 v2.1.1;
- provision 5.3-13 of ETSI EN 303 645 v2.1.1.

Support period

BSH Hausgeräte GmbH will provide security updates that are necessary to maintain the main functions free of charge until at least 28/02/2034.



Thank you for buying a Bosch Home Appliance!

Register your new device on MyBosch now and profit directly from:

- **Expert tips & tricks for your appliance**
- **Warranty extension options**
- **Discounts for accessories & spare-parts**
- **Digital manual and all appliance data at hand**
- **Easy access to Bosch Home Appliances Service**

Free and easy registration – also on mobile phones:

www.bosch-home.com/welcome



Looking for help? You'll find it here.

Expert advice for your Bosch home appliances, help with problems or a repair from Bosch experts.

Find out everything about the many ways Bosch can support you:

www.bosch-home.com/service

Contact data of all countries are listed in the attached service directory.

BSH Hausgeräte GmbH

Carl-Wery-Straße 34
81739 München, GERMANY
www.bosch-home.com

A Bosch Company

Valid within Great Britain:
Imported to Great Britain by
BSH Home Appliances Ltd.
Grand Union House
Old Wolverton Road
Wolverton, Milton Keynes
MK12 5PT
United Kingdom



9002008861 (050625)

en