



BOSCH

Register your
new device on
MyBosch now and
get free benefits:
[bosch-home.com/
welcome](https://bosch-home.com/welcome)



FlexInduction hob with integrated ventilation system

PXX...D5..

[en] Information for Use



You can find additional information and explanations online.
Scan the QR code on the title page.



Table of contents

1	Safety	2	16	Transfer settings	13
2	Avoiding material damage	4	17	PerfectFry Sensor	14
3	Environmental protection and saving energy	5	18	Childproof lock	14
4	Suitable cookware	6	19	Wipe protection	15
5	Familiarising yourself with your appliance	6	20	Individual safety switch-off	15
6	Operating modes	8	21	Basic settings	15
7	Before using for the first time	8	22	Cookware test	17
8	Basic operation	9	23	Power limitation	17
9	Ventilation control	10	24	Home Connect	17
10	FlexInduction	11	25	Cleaning and servicing	19
11	MoveMode	11	26	Troubleshooting	22
12	Time-setting options	12	27	Disposal	23
13	PowerBoost	12	28	Declaration of Conformity	24
14	PanBoost	13	29	Customer Service	24
15	Keep-warm function	13	30	Test dishes	25

1 Safety

Observe the following safety instructions.

1.1 General information

- Read this instruction manual carefully.
- Keep the instructions, the appliance and the product information safe for future reference or for the next owner.
- Do not connect the appliance if it has been damaged in transit.

1.2 Intended use

Only a licensed professional may connect appliances without plugs. Damage caused by incorrect connection is not covered under the warranty.

The appliance can only be used safely if it is correctly installed according to the safety instructions. The installer is responsible for ensuring that the appliance works perfectly at its installation location.

Only use this appliance:

- To prepare meals and drinks.

- Under supervision. Never leave the appliance unattended when cooking for short periods.
- in private households and in enclosed spaces in a domestic environment.
- Up to an altitude of 2000 m above sea level.

Do not use the appliance:

- On boats or in vehicles.
- With an external timer or a separate remote control. This does not apply if operation with appliances included in EN 50615 is switched off.
- To extract hazardous or explosive substances and vapours.
- To extract small parts and liquids.

If you wear an active implantable medical device (e.g. a pacemaker or defibrillator), check with your doctor that it complies with Council Directive 90/385/EEC of 20th June 1990, EN 45502-2-1 and EN 45502-2-2, and that it has been chosen, implanted and programmed in accordance with VDE-AR-E 2750-10. If these conditions are satisfied, and

if, in addition, non-metal cooking utensils and cookware with non-metal handles are used, it is safe to use this induction hob as intended.

1.3 Restriction on user group

This appliance may be used by children aged 8 or over and by people who have reduced physical, sensory or mental abilities or inadequate experience and/or knowledge, provided that they are supervised or have been instructed on how to use the appliance safely and have understood the resulting dangers.

Do not let children play with the appliance. Children must not perform cleaning or user maintenance unless they are at least 15 years old and are being supervised.

Keep children under the age of 8 years away from the appliance and power cable.

1.4 Safe use

⚠ WARNING – Risk of suffocation!

Children may breathe in or swallow small parts, causing them to suffocate.

- ▶ Keep small parts away from children.
 - ▶ Do not let children play with small parts.
- Children may put packaging material over their heads or wrap themselves up in it and suffocate.
- ▶ Keep packaging material away from children.
 - ▶ Do not let children play with packaging material.

⚠ WARNING – Risk of poisoning!

Risk of poisoning from flue gases being drawn back in. Room-air-dependent heat-producing appliances (e.g. gas, oil, wood or coal-operated heaters, continuous flow heaters or water heaters) obtain combustion air from the room in which they are installed and discharge the exhaust gases into the open through an exhaust gas system (e.g. a chimney). With the extractor hood switched on, air is extracted from the kitchen and the adjacent rooms.

Without an adequate supply of air, the air pressure falls below atmospheric pressure. Toxic gases from the chimney or the extraction shaft

are sucked back into the living space.

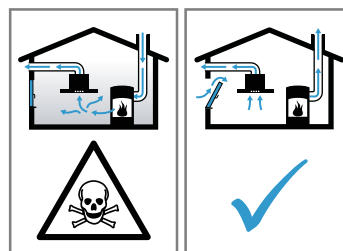

- ▶ Always ensure adequate fresh air in the room if the appliance is being operated in exhaust air mode at the same time as a room-air-dependent heat-producing appliance is being operated.
- ▶ It is only possible to safely operate the appliance if the pressure in the room in which the heating appliance is installed does not fall below 4 Pa (0.04 mbar). This can be achieved whenever the air needed for combustion is able to enter through openings that cannot be sealed, for example in doors, windows, incoming/exhaust air wall boxes or by other technical means. An incoming/exhaust air wall box alone is not sufficient to ensure compliance with the limit.
- ▶ In any case, consult your responsible chimney sweep. They are able to assess the house's entire ventilation setup and will suggest the suitable ventilation measures to you.
- ▶ Unrestricted operation is possible if the appliance is operated exclusively in circulating-air mode.

⚠ WARNING – Risk of fire!

Leaving fat or oil cooking on an unattended hob can be dangerous and may lead to fires.

- ▶ Never leave hot oil or fat unattended.
- ▶ Never attempt to extinguish a fire using water; instead, switch off the appliance and then cover with a lid or a fire blanket.

The cooking surface becomes very hot.

- ▶ Never place flammable objects on the cooking surface or in its immediate vicinity.
- ▶ Never place objects on the cooking surface.

The appliance will become hot.

- ▶ Do not keep combustible objects or aerosol cans in drawers directly underneath the hob. Hob covers can cause accidents, for example due to overheating, catching fire or materials shattering.

- ▶ Do not use hob covers.

After every use, switch off the hob using the main switch.

- ▶ Do not wait until the hob turns off automatically as there are no longer any pots and pans on it.

Fatty deposits in the grease filters may catch fire.

- ▶ Never operate the appliance without a grease filter.
- ▶ Clean the grease filters regularly.
- ▶ Never work with naked flames close to the appliance (e.g. flambéing).
- ▶ Do not install the appliance near a solid fuel heating appliance (e.g. wood- or coal-burning) unless the heating appliance has a sealed, non-removable cover. There must be no flying sparks.

⚠ WARNING – Risk of burns!

The appliance and its parts that can be touched become hot during use, particularly the hob surround, if fitted.

- ▶ Caution should be exercised here in order to avoid touching heating elements.
- ▶ Young children under 8 years of age must be kept away from the appliance.

Hob guards may cause accidents.

- ▶ Never use hob guards.

Metal objects on the hob quickly become very hot.

- ▶ Never place metal objects (such as knives, forks, spoons and lids) on the hob.

The appliance becomes hot during operation.

- ▶ Allow the appliance to cool down before cleaning.
- ▶ If hot liquids penetrate the appliance, only remove the grease filter or the overflow container once the appliance has cooled down.

⚠ WARNING – Risk of electric shock!

Improper repairs are dangerous.

- ▶ Repairs to the appliance should only be carried out by trained specialist staff.
- ▶ Only use genuine spare parts when repairing the appliance.
- ▶ If the power cord or the appliance power cable of this appliance is damaged, it must

be replaced with a special power cord or special appliance power cable, which is available from the manufacturer or its Customer Service.

- ▶ If the power cord of this appliance is damaged, it must be replaced by trained specialist staff.

If the appliance or the power cord is damaged, this is dangerous.

- ▶ Never operate a damaged appliance.
- ▶ Never operate an appliance with a cracked or fractured surface.
- ▶ Never pull on the power cord to unplug the appliance. Always unplug the appliance at the mains.
- ▶ If the appliance or the power cable is damaged, immediately switch off the fuse in the fuse box.
- ▶ Call customer service. → *Page 24*

An ingress of moisture can cause an electric shock.

- ▶ Do not use steam- or high-pressure cleaners to clean the appliance.

The insulation on cables of electrical appliances may melt if it touches hot parts of the appliance.

- ▶ Never bring electrical appliance cables into contact with hot parts of the appliance.

⚠ WARNING – Risk of injury!

Saucepans may suddenly jump due to liquid between the saucepan base and the hotplate.

- ▶ Always keep hotplates and saucepan bases dry.
- ▶ Never use icy-cold cookware that has been in the freezer.

When cooking in a bain marie, the hob and cooking container could shatter due to overheating.

- ▶ The cooking container in the bain marie must not directly touch the bottom of the water-filled pot.
- ▶ Only use heat-resistant cookware.

An appliance with a cracked or broken surface can cause cuts.

- ▶ Do not use the appliance if it has a cracked or broken surface.

2 Avoiding material damage

This is where you can find the most common causes of damage and tips on how to avoid them.

Damage	Cause	Measure
Stains	Unsupervised cooking process.	Monitor the cooking process.

Damage	Cause	Measure
Stains, blisters	Spilled food, especially food with a high sugar content.	Remove immediately with a glass scraper.
Stains, blisters or fractures in the glass	Defective cookware, cookware with melted enamel or cookware with copper or aluminium base.	Use suitable cookware that is in a good condition.
Stains, discolouration	Unsuitable cleaning methods.	Only use cleaning agents that are suitable for glass ceramic, and only clean the hob when it is cold.
Blisters or fractures in the glass	Knocks or falling cookware, cooking accessories or other hard or pointed objects.	When cooking, do not hit the glass or let objects fall onto the hob.
Scratches, discolouration	Rough cookware bases or moving the cookware on the hob.	Check the cookware. Lift the cookware when moving it.
Scratches	Salt, sugar or sand.	Do not use the hob as a work surface or storage space.
Damage to the appliance	Cooking with frozen cookware.	Never use frozen cookware.
Damage to the cookware or the appliance	Cooking without contents.	Never place or heat empty cookware on a hot cooking zone.
Glass damage	Melted material on the hot cooking zone or hot pot lid on the glass.	Do not place greaseproof paper or aluminium foil nor plastic containers or pot lids on the hob.
Overheating	Hot cookware on the control panel or on the frame.	Never place hot cookware on these areas.

3 Environmental protection and saving energy

3.1 Disposing of packaging

The packaging materials are environmentally compatible and can be recycled.

- ▶ Sort the individual components by type and dispose of them separately.

3.2 Saving energy

If you follow these instructions, your appliance will use less energy.

Select the cooking zone to match the size of your pan. Centre the cookware on the hob.

Use cookware whose base diameter is the same diameter as the hotplate.

Tip: Cookware manufacturers often give the upper diameter of the saucepan. It is often larger than the base diameter.

- ✓ Unsuitable cookware or incompletely covered cooking zones consume a lot of energy.

Cover saucepans with suitable lids.

- ✓ Cooking without a lid consumes considerably more energy.

Lift lids as infrequently as possible.

- ✓ When you lift the lid, a lot of energy escapes.

Using a glass lid

- ✓ You can see into the pan through a glass lid without having to lift it.

Use pots and pans with flat bases.

- ✓ Uneven bases increase energy consumption.

Use cookware that is suitable for the quantity of food.

- ✓ Large items of cookware containing little food need more energy to heat up.

Cook with only a little water.

- ✓ The more water there is in the cookware, the more energy that is required to heat it up.

Turn down to a lower power level early on. Use a suitable ongoing power level.

- ✓ If you use an ongoing power level that is too high, you will waste energy.

Adjust the fan speed to the amount of steam produced during cooking.

- ✓ The lower the fan speed, the less energy is consumed.

If cooking produces large amounts of steam, select a higher fan speed in good time.

- ✓ The odours are distributed around the room less.

Switch the appliance off when you are not using it.

Ensure that there is sufficient ventilation when cooking.

- ✓ The appliance works more efficiently and with fewer operating noises.

Clean or replace the filters at regular intervals.

- ✓ The effectiveness of the filter is retained.

4 Suitable cookware

Cookware that is suitable for induction cooking must have a ferromagnetic base, i.e. it must be attracted by a magnet. The base must also match the size of the cook-

ing zone. If cookware is not detected on a cooking zone, place this on the cooking zone with the next smallest diameter.

4.1 Size and characteristics of the cookware

To be able correctly detect the cookware, you must take the size and the material of the cookware into consideration. All cookware bases must be perfectly flat and smooth. Use Cookware test to check whether the cookware is suitable.

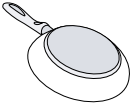
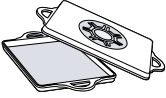
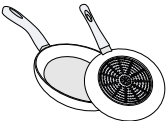
Cookware	Materials	Properties
Recommended cookware 	Stainless steel cookware in a sandwich design that distributes the heat well.	This cookware distributes the heat evenly, heats up quickly, and ensures that it can be detected easily.
Suitable  	Ferromagnetic cookware made of enamelled steel, cast iron or special induction cookware made of stainless steel. The base is not fully ferromagnetic. Cookware bases that contain aluminium.	This cookware distributes the heat evenly, heats up quickly, and ensures that it can be detected. If the ferromagnetic area is smaller than the base of the cookware, only the area that is ferromagnetic heats up. As a result, the heat is not distributed evenly. These cookware bases reduce the ferromagnetic area, which means that less power is emitted to the cookware. This cookware may not be sufficiently detected or may not be detected at all, and therefore does not heat sufficiently.
Not suitable	Cookware made from normal thin steel, glass, clay, copper or aluminium.	

Notes

- Do not use adapter plates between the hob and the cookware.
- Do not heat up empty cookware and do not use cookware with a thin base, as this may become very hot.

5 Familiarising yourself with your appliance

5.1 Cooking with induction

In comparison to conventional hobs, induction technology brings with it a series of changes and has a number of benefits such as time savings when cooking and frying, energy savings as well as greater ease of cleaning and care. It also offers improved heat control as the heat is generated directly in the cookware.

5.2 Your new appliance

Information about your new appliance

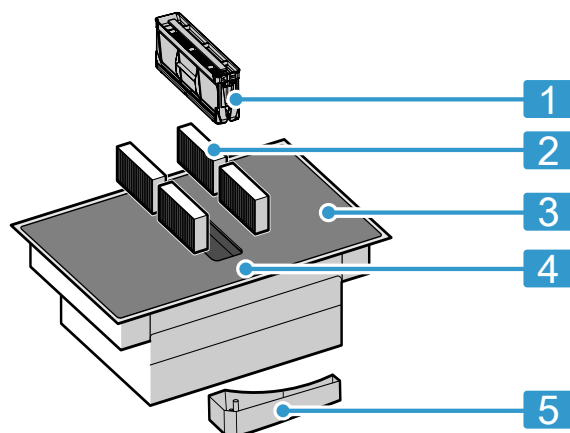

1 Grease filter

- 2 Odour filter for circulating-air mode or acoustics filter for air extraction mode ¹
- 3 Hob
- 4 Control panel
- 5 Overflow container

5.4 Control panel

Individual details, such as colour and shape, may differ from the figure.

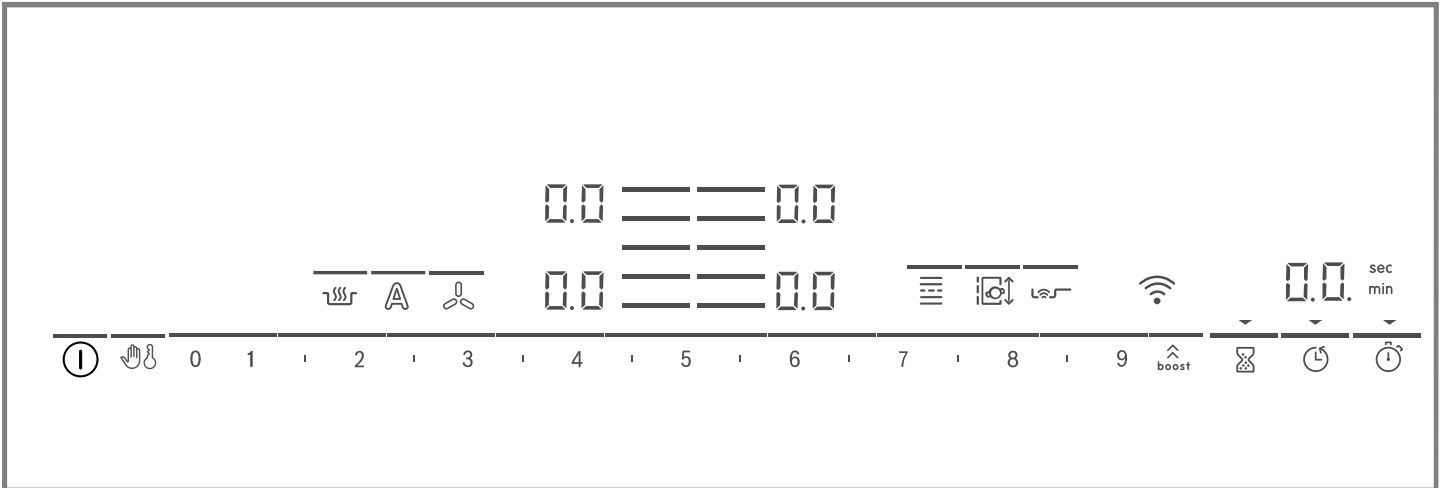

Notes

- Always keep the control panel clean and dry.
- Do not place any cookware near the displays or sensors. The electronics may overheat.

Touch buttons

When you switch on the hob, the symbols for the controls available at this time light up.

Sensor	Function
①	Main switch
👉	Wipe protection
🔒	Childproof lock
0 1 2 3...	Settings range
⬆️ boost	PowerBoost / PanBoost
⌚	Timer
🕒	Switch-off timer
🕒	Count-up timer
🔥	Keep-warm function
🔥	PerfectFry Sensor
☰	FlexInduction
🔄	MoveMode
☰	Select a cooking zone
📶	Wi-Fi
🌀	Ventilation control
A	Sensor ventilation control

5.3 Special accessories

Depending on the appliance model, various accessories are available and you can obtain these from specialist retailers, from our after-sales service or from our official website.

- Air extraction set
- Air recirculation set
- Odour filter for recirculating air mode
- Acoustics filter for air extraction mode

Depending on the status of the hob, the displays for the cooking zones and the various activated and available functions also light up.

5.5 Distribution of the cooking zones

The specified power has been measured with the standard pots, which are described in IEC/EN 60335-2-6. The power may vary depending on the size of the cookware or cookware material.

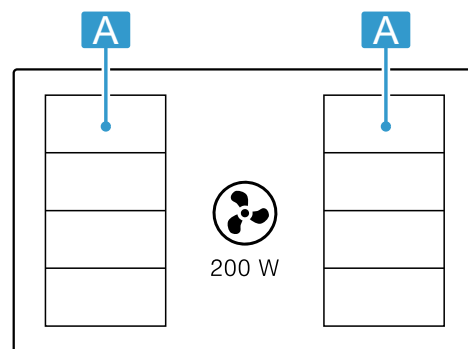



Area	Highest power level	
A ☰☰☰	Power level 9	2200 W
	PowerBoost	3700 W
A ☰	Power level 9	3300 W
	PowerBoost	3700 W

¹ Depending on the appliance specifications.

5.6 Cooking zone

Before you start cooking, check whether the size of the cookware fits the cooking zone that you want to use for cooking:

Area	Cooking zone type
	Single-circuit cooking zone
	Flex Zone → "FlexInduction", Page 11

5.7 Residual heat indicator

The hob has a residual heat indicator for each cooking zone. Do not touch the cooking zone if the residual heat indicator is lit.

Display	Meaning
H	The cooking zone is hot.
h	The cooking zone is warm.

6 Operating modes

You can use your appliance in air extraction mode or circulating-air mode.

6.1 Air extraction mode

The air which is drawn in is cleaned by the grease filters and conveyed to the exterior by a pipe system.



The air must not be discharged into a flue that is used for exhausting fumes from appliances burning gas or other fuels (not applicable to appliances that only discharge the air back into the room).

- If the exhaust air is to be conveyed into a non-functioning smoke or exhaust gas flue, you must obtain the consent of the heating engineer responsible.
- If the exhaust air is conveyed through the external wall, a telescopic duct should be used.

6.2 Air recirculation

The air which is drawn in is cleaned by the grease filters and an odour filter, and conveyed back into the room.



To bind odours in air recirculation mode, you must install an odour filter. The different options for operating the appliance in air circulation mode can be found in our catalogue. Alternatively, ask your dealer. The required accessories are available from specialist retailers, from our after-sales service or from the online shop.

Note: When cooking intensively and for a long time, moisture is released into the air in the room. When using the appliance in air recirculation mode, we recommend ventilating the kitchen adequately, e.g. by briefly opening a window to remove excessive moisture.

7 Before using for the first time

Observe the following recommendations.

7.1 Initial cleaning

Remove any leftover packaging from the hob surface and wipe the surface with a damp cloth. You can find a list of recommended detergents on the official website www.bosch-home.com.

More information on care and cleaning. → Page 19

7.2 Preparing the appliance

To ensure correct operation, you must arrange the components in this order:

1. Insert the filter.
2. Insert the metal grease filter.

Note: Never operate the appliance without the metal grease filter and the overflow container.

7.3 Cooking with induction

In comparison to conventional hobs, induction technology brings with it a series of changes and has a number of benefits such as time savings when cooking and frying, energy savings as well as greater ease of cleaning and care. It also offers improved heat control as the heat is generated directly in the cookware.

7.4 Cookware

You can find a list of recommended cookware on the official website www.bosch-home.com.

Further information on suitable cookware. → Page 6

7.5 Setting the operating mode

The appliance is supplied with a preset circulating-air mode.

When your hob is installed with an air outlet to the outside, you must configure the setting ϵ 7 to this mode. You can find additional information about this in the section entitled

→ "Basic settings", Page 15

7.6 Setting Home Connect



When you first switch on the appliance, you are prompted to set up your home network. The  symbol lights up for a few seconds on the display panel.

To begin setting up the connection, touch the  sensor and proceed in accordance with the information given in the section entitled . To exit initial set-up, touch any sensor.

→ "Home Connect ", Page 17

8 Basic operation

8.1 Switching on the hob

- ▶ Touch . An audible signal sounds. The symbols for the cooking zones and the currently available functions light up.  lights up next to the cooking zones.
- ✓ The hob is ready for use.

ReStart

- ▶ If you switch the appliance on within four seconds of switching it off, the hob operates with the settings that were previously set.



8.2 Switching the hob off

- ▶ Touch  until the displays go out.
- ✓ All cooking zones are switched off.

Note: If all of the cooking zones are switched off for longer than 20 seconds, the hob is automatically switched off.

8.3 Setting the power level in the cooking zones

The cooking zone has 17 power levels, which are displayed from 1 to 9 with intermediate values. Select the best power level for the food and the planned cooking process.

1. Touch the  symbol for the cooking zone you require.
 - ✓ The  display gets brighter.
2. Select the required power level in the settings area.
 - ✓ The power level has been set.

Note: If no cookware is placed on the cooking zone or the pot is not suitable, the selected power level flashes. After a certain period of time, the cooking zone switches itself off.



QuickStart

- ▶ If you place cookware on the hob before you switch it on, the cookware is detected when you switch on and the corresponding cooking zone is selected automatically. Select the power level in the next 20 seconds, or the hob switches itself off.



Changing the power level and switching off the cooking zone

1. Select the cooking zone.
2. Select the required power level in the settings range or set it to .
- ✓ The cooking zone's power level changes or the cooking zone switches itself off and the residual heat indicator appears.

8.4 Cooking recommendations

The table shows which power level () is suitable for which food. The cooking time ( min) may vary depend-

ing on the type, weight, thickness and quality of the food. To preheat, set power level 8–9.

		 min
Melting		
Butter, honey, gelatine	1 - 2	-
Heating and keeping warm		
Boiled sausages ¹	3 - 4	-
Defrosting and heating		
Spinach, frozen	3 - 4	15 - 25
Poaching, simmering		
Potato dumplings ¹	4.5 - 5.5	20 - 30
Whisked sauces, e.g. Béarnaise sauce, Hollandaise sauce	3 - 4	8 - 12
Boiling, steaming, braising		
Rice, with double the volume of water	2.5 - 3.5	15 - 30
Unpeeled boiled pots	4.5 - 5.5	25 - 35
Pasta ¹	6 - 7	6 - 10
Soups	3.5 - 4.5	15 - 60
Vegetables	2.5 - 3.5	10 - 20
Stew in a pressure cooker	4.5 - 5.5	-
Stewing		
Pot roast	4 - 5	60 - 100
Goulash ²	3 - 4	50 - 60
Braising/frying with a small amount of fat ¹		
Escalope, plain or breaded	6 - 7	6 - 10
Steak (3 cm thick)	7 - 8	8 - 12
Poultry breast (2 cm thick)	5 - 6	10 - 20
Hamburgers (2 cm thick)	6 - 7	10 - 20
Fish and fish fillet, breaded	6 - 7	8 - 20
Prawns and scampi	7 - 8	4 - 10
Sautéing fresh vegetables and mushrooms	7 - 8	10 - 20
Frozen dishes, e.g. stir-fries	6 - 7	6 - 10
Omelette (cooked one after the other)	3.5 - 4.5	3 - 10
Deep-frying, 150–200 g per portion in 1–2 l oil, deep-fat fried in portions ¹		
Frozen products, e.g. chips, chicken nuggets	8 - 9	-
Vegetables, mushrooms, breaded, beer-battered or tempura	6 - 7	-
Small baked items, e.g. doughnuts, battered fruit	4 - 5	-

¹ Without lid

² Preheat to power level 8 - 8.5

9 Ventilation control

You can use the hood control to control the highly efficient air extraction system that is integrated in the cooking surface.

9.1 Manual ventilation control

You can control the ventilation setting manually.

Note: When tall items of cookware are used, we cannot guarantee that the extraction system will work at optimum power. Extraction can be improved by placing the lid on the cookware at an angle.

Activating the manual ventilation control



1. Touch .

The ventilation system starts at the preset performance level.
2. Within the next 10 seconds, select the required performance level in the settings area.

The set performance level lights up.
3. Touch  to confirm the setting.

✓ The ventilation system is activated.



Changing or deactivating manual ventilation control

1. Touch .
2. Select the required performance level in the settings area or set it to .

9.2 Intensive ventilation setting



There are two intensive modes for the ventilation system. If you activate the intensive settings, the ventilation system works at maximum output for a short time.

Activating the intensive ventilation setting

1. Touch .
2. Select the required intensive setting:
 - ▶ **Intensive setting I:** Press . The line above the symbol lights up. The setting is activated.
 - ▶ **Intensive setting II:** Press  twice. The line above the symbol flashes. The setting is activated.

Note: After approx. eight minutes, the appliance automatically switches back to performance level .

Changing or deactivating the intensive ventilation setting

1. Touch .
2. Select the required performance level in the settings area or set it to .

9.3 Automatic start for the ventilation system

If you select a performance level for a cooking zone, the automatic start switches on.

As standard, the hob is supplied with sensor-controlled automatic start. You can find out how to change this setting in section .

→ "Basic settings", Page 15

Automatic start with sensor control

The air quality sensor detects the cooking vapours automatically, switches on the optimum performance level, and the line above  lights up.

Automatic start via performance levels

The ventilation system switches on at a performance level in accordance with the respective performance level for the cooking zone.

9.4 Automatic mode with sensor control

The hob has an air quality sensor that automatically registers the cooking vapours and switches on the ventilation system.

If the automatic start is switched off or is set in accordance with the power levels, you can manually switch this on with sensor control at any time.

Activating automatic mode with sensor control

- ▶ Touch .

The line above the symbol lights up brighter. The optimum performance level is set automatically with the help of the sensor.
- ✓ The function has been activated.

Deactivating automatic mode with sensor control

- ▶ Touch .

The line above the symbol goes out.
- ✓ The function has now been deactivated.

Note: You can find out how to set the sensor sensitivity in section .

→ "Basic settings", Page 15

9.5 Run-on function for the ventilation system



The run-on function leaves the ventilation system running for a few minutes after the hob has been switched off. This allows you to remove any cooking fumes that remain. The ventilation system then automatically switches off.

The hob is supplied as standard with the run-on time with a maximum switch-off time. You can find out how to change this setting in section .

→ "Basic settings", Page 15

Activating the fan run-on

The run-on is configured in accordance with the basic settings:

- Via the control for the air quality sensor.  lights up.
- With a maximum switch-off time.  lights up.

Note: The run-on function only switches on if at least one cooking zone has been switched on for at least one minute.

Deactivating the fan run-on

Manually

To deactivate the function, touch  or .

Automatically

The appliance deactivates the run-on function when:

- The run-on time has elapsed.

- You switch the appliance on again.
- The sensor ensures that the air quality is in order.

10 FlexInduction

The flexible cooking zone allows you to position cookware of any shape or size any way you like. It consists of four inductors that work independently of each other. When the flexible cooking zone is in use, only the area that is covered by cookware is activated.

10.1 Positioning the cookware

The flexible cooking zone can be configured in two ways, depending on which cookware is used. In order to guarantee good thermal detection and heat distribution, we recommend positioning the cookware in the centre, as shown in the figures.

As a connected cooking zone

Recommended for cooking with just one item of cookware.

- Position the cookware depending on the size:

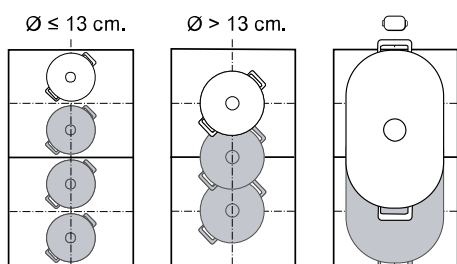

- Recommended oblong cookware :



As two separate cooking zones

Recommended for cooking with two items of cookware. You can use the front and rear zone independently of one another, and set a separate power level for each zone.

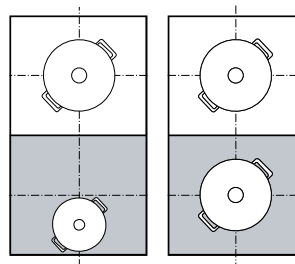

10.2 Switching on FlexInduction

1. Place the cookware on the cooking zone.
 2. The appliance detects the cookware and selects the cooking zone.
- ✓ The cooking zones split or connect automatically depending on the size and position of the cookware.
 - ✓ The FlexZone is connected and  lights up.

Notes

- By touching , you can manually change the settings for the cooking zone.
- You can change the default configuration of the flexible cooking zone. You can find out how to do this in the "Basic settings" section. → *Page 15*
- If you move or lift the cookware from an active connected cooking zone, an automatic search starts. Each item of cookware that is found within the cooking zone during this search is heated at the previously selected power level.

11 MoveMode

You can use this function to change the power level of an item of cookware by simply sliding it forwards or backwards in the flexible cooking zone. The zone is divided into three areas with different power levels.

11.1 Positioning and moving the cookware

Only use one item of cookware. The cooking area depends on the cookware used, as well as its size and positioning.

Each cooking area has a preset power level:

- Front area = power level 9
- Middle area = power level 5
- Rear area = power level 1.5

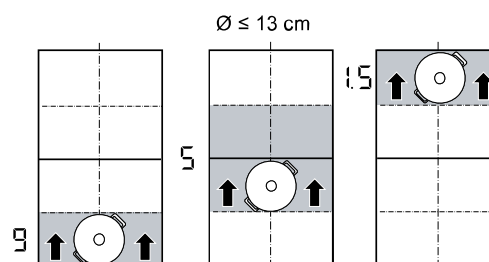

You can change the standard setting of the preset power levels. You can find out how to do this in the "Basic settings" section → *Page 15*.

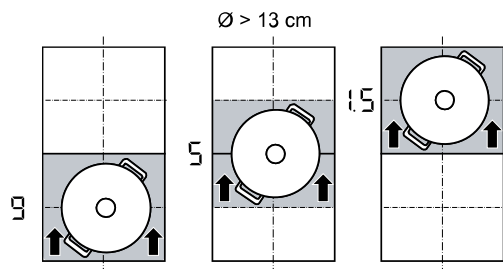





11.2 Activating MoveMode

Requirement: Only place one item of cookware on a flexible zone.

1. Select one of the two cooking zones in the flexible zone.
2. Press .
 - ✓ The power level in the area in which the cookware is located lights up in the cooking zone display next to .
 - ✓ The function is switched on.

Note: You can change the power levels during cooking.

11.3 Deactivating MoveMode

- ▶ Touching 
 - ✓ The display beside  switches off.
 - ✓ The function has been deactivated.

12 Time-setting options



Your hob has various functions for setting the cooking time:

- Switch-off timer
- Timer
- Count-up timer

12.1 Switch-off timer



Allows you to program a cooking time for one or more cooking zones. Once the time has elapsed, the cooking zone is automatically switched off.

Switching on Switch-off timer

1. Select the cooking zone and the power level.
2. Press .
 - ✓ The  indicator for the hotplate will light up.
3. Set the time on the control panel.
 - ▶ To set a cooking time of less than 10 minutes, always touch 0 before you select the required value.
4. Press  to confirm.
 - ✓ The cooking time begins to count down.
 - ✓ Once the cooking time has elapsed, the cooking zone switches itself off and an audible signal sounds.

Note: If a cooking time has been programmed in a cooking zone in which the PerfectFry Sensor is activated, the programmed cooking time will start to count down as soon as the selected temperature level has been reached.



Changing or switching off Switch-off timer

1. Select the cooking zone and touch .
2. In the settings area, change the time or set to  to delete the time.
3. Press  to confirm.



12.2 Timer

Enables the activation of a timer of 0–99 minutes. This function can be used independently of the cooking zones and other settings. It does not automatically switch off the cooking zones.

Switching on Timer

1. Touch .
2. Set the desired time on the control panel.
3. Press  to confirm.
 - ✓ The time will begin to elapse.
 - ✓ An audible signal sounds once the time has elapsed.

Changing or switching off the Timer

1. Touch .
2. In the settings range, change the time or set to  to delete the time.
3. Press  to confirm.



12.3 Count-up timer

The stopwatch function displays the time that has elapsed since activation.

Switching on Count-up timer

- ▶ Touch .
- ✓ The time will begin to elapse.

Switching off Count-up timer

1. Touch . The stopwatch stops. The timer displays remain lit.
2. Touch . The displays go out.

13 PowerBoost

You can use this function to heat up large volumes of water more quickly than with 9.

This function is available for all cooking zones, provided the other cooking zone in the same group is not in use.

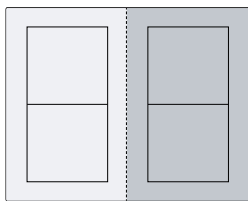

13.1 Switching on PowerBoost

1. Select the cooking zone.
 2. Touch . The **b.** display lights up.
- ✓ The function is switched on.

Note: You can also switch on this function when cooking with a connected FlexZone.

13.2 Switching off PowerBoost

1. Select the cooking zone.
 2. Touch . The **b.** display goes out and the cooking zone switches back to the **9** power level.
- ✓ The function has been deactivated.

Note: In certain circumstances, this function may switch itself off automatically in order to protect the electronic elements inside the hob.

14 PanBoost

You can use this function to heat up pans more quickly than with **9**.

This function is available for all cooking zones, provided the other cooking zone in the same group is not in use.

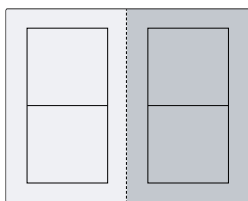

14.1 Recommended applications

- Do not place a lid on the pan.
- Never leave pans unattended when they are heating up.
- Only use cold pans.

- Use pans with a completely flat base. Do not use pans with a thin base.

14.2 Switching on PanBoost

1. Select the cooking zone.
 2. Touch  twice. **Pb.** lights up.
- ✓ The function is switched on.

Note: You can also switch on this function when cooking with a connected FlexZone.

14.3 Switching off PanBoost

1. Select the cooking zone.
 2. Touch . **Pb.** goes out and the cooking zone switches back to the **9** power level.
- ✓ The function has been deactivated.

Note: To avoid high temperatures, this function automatically switches itself off after 30 seconds.

15 Keep-warm function

You can use this function to melt chocolate or butter and to keep meals warm.

15.1 Switching on Keep-warm function

1. Select the required cooking zone.
 2. Touch  within the next 10 seconds. **L** lights up.
- ✓ The function is switched on.

15.2 Switching off Keep-warm function

1. Select the cooking zone.
 2. Touch . **L** goes out.
- ✓ The function has been deactivated.

16 Transfer settings

You can use this function to transfer the power level and the programmed cooking time from one cooking zone to another.

16.1 Transfer settings

Requirement: Move the cookware to a cooking zone which is not switched on, which you have not yet preset and on which no other cookware has been placed.

1. Move the cookware.

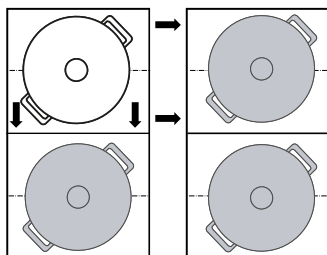

The cookware is detected and the previously selected power level and t flash alternately on the display for the new cooking zone.

2. Select the new cooking zone to implement the settings.

The appliance sets the power level for the original cooking zone to 00 .

✓ The settings are transferred to the new cooking zone.

Note: If you place a new item of cookware on a different cooking zone before you have confirmed the settings, you can use this function for both items of cookware.

17 PerfectFry Sensor

Suitable for cooking or reducing sauces, pancakes or frying eggs with butter, for frying vegetables or steaks up to the required level of boiling, and for keeping the temperature under control.

Instead of frequently adjusting the power level during cooking, select the required target temperature once at the start. The sensors under the glass ceramic measure the temperature of the cookware and keep this constant throughout the entire cooking process.

This function is available on all cooking zones marked with this symbol

17.1 Advantages

- The temperature is automatically kept constant without you having to change the power level.
- Oil does not overheat. This prevents the food from burning.
- The cooking zone only continues heating for as long as this is necessary to maintain the temperature. This saves energy.

17.2 Temperature levels

Temperature levels for preparing meals.

Level	Temperature	Functions
1	120 °C	Boiling and reducing sauces, fry vegetables
2	140 °C	Searing in olive oil or butter
3	160 °C	Frying fish and coarse foods
4	180 °C	Deep-fat frying breaded, frozen and grilled food
5	215 °C	High-temperature grill and griddle plate

17.3 Recommended cookware

Special cookware has been developed for this function, which delivers the best results.

The recommended cookware is available from customer service, specialist retailers or our online shop www.bosch-home.com.

Note: You can also use other cookware. Depending on the composition of the cookware, the achieved temperature may differ from the selected temperature level.

17.4 Switching on the PerfectFry Sensor

1. Place empty cookware on the cooking zone.
 2. Select the cooking zone and touch .
 3. Within the next 10 seconds, select the required temperature setting on the control panel.
- ✓ The function starts. flashes until the set target temperature is reached.
 - ✓ Once the target temperature has been reached, a signal tone sounds and stops flashing.
4. Add the frying fat and then the food to the frying pan.

Note: If you need to cook with more than 250 ml oil, add the oil and wait a few seconds before you add the food.

17.5 Switching off PerfectFry Sensor

- ▶ Select the cooking zone and touch .
- ✓ The function has been deactivated.

17.6 Recommendations for cooking with PerfectFry Sensor

The enclosed documentation contains a table with recommendations for cooking with PerfectFry Sensor.

18 Childproof lock



The hob is equipped with a childproof lock. This prevents children from switching on the hob.

18.1 Switching on Childproof lock

Requirement: The hob must be switched off.

1. Touch .
 2. Touch and hold for 4 seconds.
- ✓ The display lights up for 10 seconds.
 - ✓ The hob is locked.

18.2 Switching off Childproof lock

1. Touch .
 2. Touch and hold  for 4 seconds.
- ✓ The lock is released.



18.3 Automatic childproof lock

You can also activate the childproof lock automatically every time the hob is switched off. You can find out how to switch the function on and off in the "Basic settings" section → *Page 15*.

19 Wipe protection

Allows the control panel to be locked for cleaning so that the settings are not inadvertently adjusted. The lock has no effect on the main switch.

19.1 Switching on Wipe protection

- ▶ Press . A warning tone sounds and  lights up.
- ✓ The control panel remains locked for 35 seconds. A signal tone sounds 5 seconds before the appliance is switched off.

19.2 Switching off Wipe protection

To switch off the function early:

- ▶ touch .
- ✓ The control panel is unlocked.

20 Individual safety switch-off

























The safety function is activated if one cooking zone is in operation for an extended period and you do not change any settings. The cooking zone displays *FB* and switches itself off.

The time from 1 to 10 hours depends on the selected power level. Press any button to switch on the cooking zone.

21 Basic settings

You can configure the basic settings for your appliance to meet your needs.

21.1 Overview of the basic settings

Display	Setting	Value
 1	Childproof lock	 - Manual. ¹  - Automatic.  - Switched off.
 2	Signal tones	 - Confirmation and fault signals are switched off.  - Only the fault signal is switched on.  - Only the confirmation signal is switched on.  - All signal tones are switched on ¹ .
 3	Energy consumption display Shows the total energy consumption between switching the hob on and off in kWh. The accuracy of the display depends on various factors such as the voltage quality of the power supply.	 - Switched off. ¹  - Switched on.
 4	Select the setting in accordance with the height about sea level: ²	 - Decrease.  - Basic setting.  - Increase.
 5	Automatic switch-off of the cooking zones.	  - switched off. ¹    - minutes until the appliance switches off automatically.
 6	Duration of the timer end signal tone	 - 10 seconds ¹

¹ Factory setting



² The function is not available in this model.



Display	Setting	Value
		2 - 30 seconds 3 - 1 minute
c 7	Power limitation Enables the total power of the hob to be limited, if necessary, based on the conditions of your electrical installation. The available settings depend on the maximum power of the hob (see rating plate). If the function is active and the hob has reached the set power limit, _ is displayed and you cannot select a higher power level.	0 - Switched off. Maximum power of the hob ¹ . 1 - 1000 W. Lowest power setting. 1.5 - 1500 W. ... 3 - 3000 W. Recommended for 13 A 3.5 - 3500 W. Recommended for 16 A. 4 - 4000 W. 4.5 - 4500 W. Recommended for 20 A. ... 9 - Maximum power of the hob.
c 11	MoveMode Allows you to change the preset power levels for the three cooking areas of the flexible cooking zone. Select one of the two cooking zones, set the required power level in the settings area and touch  to confirm the new power level and select the next cooking zone.	9 - Preset power level for the front cooking zone. 5 - Preset power level for the middle cooking zone. 1.5 - Preset power level for the rear cooking zone.
c 12	Cookware test You can use this function to test the quality of the cookware.	0 - Not suitable. 1 - Not optimal. 2 - Suitable.
c 13	FlexInduction Change the switch-on mode for the Flex Zone.	0 - As two independent cooking zones. ¹ 1 - As a connected cooking zone.
c 14	Connect the wireless cooking sensor to the hob. ²	0 - Connected correctly. 1 - Not connected correctly due to a transmission error. 2 - Not connected correctly due to a cooking sensor fault.
c 17	Set circulating-air mode or air extraction mode.	0 - Configure circulating-air mode. ¹ 1 - Configure air extraction mode.
c 18	Setting automatic start	0 - Switched off. 1 - Switched on: Automatic mode with sensor control. ¹ 2 - Switched on: The ventilation system starts at a power level in accordance with the relevant power levels for the cooking zones.
c 19	Setting the sensor sensitivity for the ventilation system.	1 - Lowest sensor sensitivity setting. 2 - Medium sensor sensitivity setting. ¹ 3 - Highest sensor sensitivity setting.
c 20	Setting the run-on If your hob is working in air extraction mode, the ventilation system is switched on at the power level for approx. 6 minutes. If your hob is working in circulating-air mode, the ventilation system is switched on at the power level for approx. 30 minutes. The run-on function automatically switches off after this time.	0 - Switched off. 1 - Switched on: Automatic function with sensor-controlled run-on. 2 - Switched on ¹ :
c 25	Automatic cookware detection	0 - Manually select the required cooking zone. 1 - The cooking zone detects the size and the position of the cookware and selects the corresponding cooking zone(s). ¹
c 0	Restoring factory settings	0 - Individual settings ¹ . 1 - Factory settings.

¹ Factory setting² The function is not available in this model.





21.2 To go to the basic settings

Requirement: The hob must be switched off.

1. To switch on the hob, touch .
2. Within the next 10 seconds, press and hold  for 4 seconds.

Product information	Display
Directory for the technical after-sales service (TK)	 
Production number	Fd
Production number 1	02.
Production number 2	0.5

- ✓ The first four displays provide the product information. To call up the individual displays, touch the control panel.

3. Touch  to access the basic settings.
 - ✓  and  light up as a presetting.
4. Touch  repeatedly until the desired setting appears.
5. Select the required setting in the settings area.
6. Touch and hold  for 4 seconds.
 - ✓ The settings are saved.

21.3 Discarding changes to the basic settings

- ▶ Touch .
- ✓ All changes are discarded and not saved.

22 Cookware test

The quality of the cookware has a major influence on the speed and the result of the cooking process. You can use this function to test the quality of the cookware.

Before the test, ensure that the size of the cookware base corresponds to the size of the cooking zone being used.

Access is via the basic settings. → *Page 15*

22.1 Carrying out Cookware test



As a single cooking zone, the flexible cooking zone is set in such a way that only the individual item of cookware is checked.

1. At room temperature, place the cookware with approx. 200 ml water in the centre of the cooking zone that best fits the base of the cookware in terms of size.

2. Call up the basic settings and select .
3. Touch the settings area. The — display flashes in the cooking zones.
 - ✓ The test is running.
 - ✓ After 10 seconds, the result appears in the cooking zone displays.

22.2 Checking the result

You can see what the result means for the quality and speed of the cooking process in the following table.

Result
 The cookware is not suitable for the cooking zone and therefore does not heat up.
 The cookware is taking longer to heat up than expected and cooking is not progressing as well as it ought to.
 The cookware is heating up correctly and cooking is progressing well.

To activate this function, touch the settings range.

23 Power limitation

You can use this function to set the total power of the hob.

The hob is set at the factory. You can find the maximum power of the hob on the rating plate. You can use this function to adjust the configuration to the requirements of each electrical installation.

To ensure that this set value is not exceeded, the hob automatically distributes the available power as needed between the cooking zones that are switched on.

While this function is activated, the output of each cooking zone may temporarily fall below the nominal value. In order to not exceed this set value, the hob automatically distributes the available power as needed between the cooking zones that are switched on. The appliance regulates and selects the highest power level automatically.

You can find out how to do this in the "Basic settings" section → *Page 15*

24 Home Connect

This appliance is network-capable. Connecting your appliance to a mobile device lets you control its functions

via the Home Connect app, adjust its basic settings and monitor its operating status.

The Home Connect services are not available in every country. The availability of the Home Connect function depends on the availability of Home Connect services in your country. You can find information about this at: www.home-connect.com.

The Home Connect app guides you through the entire login process. Follow the instructions in the Home Connect app to configure the settings.

Tip: Please also follow the instructions in the Home Connect app.

Notes

- Please note the safety precautions in this instruction manual and make sure that they are also observed when operating the appliance via the Home Connect app.
→ "Safety", Page 2
- Operating the appliance on the appliance itself always takes priority. During this time it is not possible to operate the appliance using the Home Connect app.
- In networked standby mode, the appliance requires a maximum of 2 W.

24.1 Setting up Home Connect

Requirements

- The appliance is connected to the power supply and is switched on.
- You have a mobile device with a current version of the iOS or Android operating system, e.g. a smartphone.
- The appliance is receiving signals from the WLAN home network (Wi-Fi) at its installation location.
- The mobile device and the appliance are within range of your home network's Wi-Fi signal.

1. Scan the following QR code.



You can install the Home Connect app and connect your appliance via the QR code.

2. Follow the instructions in the Home Connect app.

24.2 Overview of the Home Connect settings

You can adjust the settings and network settings for Home Connect by going to your hob's basic settings.

Setting	Selection or display	Additional information
H C 1	Network connection 0 – Not connected/disconnect network 1 – Connect automatically 2 – Connect manually 3 – Connected	Log on the hob in the Wi-Fi home network (Wi-Fi) or disconnect from the network
H C 2	Connection to app 0 – Not connected 1 – Connect	H C 2 is only displayed if the hob is connected to the home network.
H C 3	Connection to the Wi-Fi 0 – Wireless module switched off 1 – Wireless module switched on	If Wi-Fi has been activated, you can use the Home Connect functions. H C 3 is only displayed if the hob has been previously connected to a network.
H C 4	Set using the app 0 – Switched off 1 – Switched on ¹	If H C 4 is switched off, only the hob's operating statuses are displayed in the Home Connect app.
H C 5	Software update 1 – Update available and ready to install 2 – Start installation	H C 5 is only displayed if a software update is available.
H C 6	Controlling remote access by after-sales service 0 – Not authorised 1 – Authorised	H C 6 is only displayed if after-sales service is attempting to connect to the hob. After granting access, you can terminate this at any time.
H C 7	Display Wi-Fi signal strength 0 – Not connected to the WLAN home network (Wi-Fi) 1 – Signal strength 1 (poor) 2 – Signal strength 2 (moderate) 3 – Signal strength 3 (good)	H C 7 is only displayed if there is a connection to the WLAN home network (Wi-Fi).

¹ Factory setting

Setting	Selection or display	Additional information
H E B	Connection to Home Connect server B – Not connected ! – Connected	H E B is only displayed if there is a connection to the WLAN home network (Wi-Fi).

24.3 Switching off the network connection

- ▶ Access the basic settings, H E 3 and then select the value B.
- ✓ The connection to the Wi-Fi is deactivated.

Note: Select the value ! to reactivate the network connection.

24.4 Changing settings via the Home Connect app

You can use the Home Connect app to change the settings for the cooking zones and send them to the hob.

Requirements

- The hob is connected to the Wi-Fi and to the Home Connect app.
- To use the Home Connect app to set the hob, H E 4 must be switched on in the basic settings. H E 4 is switched on on delivery. If the option for the transmission of settings has been deactivated, only the hob's operating statuses are displayed in the Home Connect app.

1. Select the setting in the Home Connect app and send it to the hob.
Follow the instructions in the Home Connect app. Settings that you send from the Home Connect app to the hob must be confirmed on the hob.
- ✓ As soon as cooking settings are transmitted to a cooking zone, the display starts to flash, depending on the setting.
2. To confirm the setting, press the hotplate display for the required cooking zone.
3. To discard the setting, touch any other touch field on the hob.

24.5 Software update

Your appliance's software can be updated using the software update function, e.g. for the purposes of optimisation, troubleshooting or security updates.

To do this, you must be a registered Home Connect user, have installed the app on your mobile device and be connected to the Home Connect server.

As soon as a software update is available, you will be informed via the Home Connect app and will be able to start the software update via the app. Once the update has been successfully downloaded, you can start installing it via the Home Connect app if you are in your home network (Wi-Fi). The Home Connect app informs you once installation is successful.

Notes

- The software update consists of two steps.
 - The first step is the download.
 - The second step is the installation on your appliance.
- You can continue to use your appliance as normal while updates are downloading. Depending on your personal settings in the app, software updates can also be set to download automatically.
- Installation takes a few minutes. You cannot use your appliance during installation.
- We recommend that you install security updates as soon as possible.

24.6 Remote diagnostics

Customer Service can use Remote Diagnostics to access your appliance if you contact them, have your appliance connected to the Home Connect server and if Remote Diagnostics is available in the country in which you are using the appliance.

Tip: For further information and details about the availability of Remote Diagnostics in your country, please visit the service/support section of your local website: www.home-connect.com.

24.7 Data protection

Please see the information on data protection.

The first time your appliance is registered on a home network connected to the Internet, your appliance will transmit the following types of data to the Home Connect server (initial registration):

- Unique appliance identification (consisting of appliance codes as well as the MAC address of the installed Wi-Fi communication module).
- Security certificate of the Wi-Fi communication module (to ensure a secure data connection).
- The current software and hardware version of your appliance.
- Status of any previous resetting to factory settings.

This initial registration prepares the Home Connect functions for use and is only required when you want to use the Home Connect functions for the first time.

Note: Please note that the Home Connect functions can only be utilised with the Home Connect app. Information on data protection can be retrieved in the Home Connect app.

25 Cleaning and servicing

To keep your appliance working efficiently for a long time, it is important to clean and maintain it carefully.

25.1 Hob surface

Preventing damage to the surface

Before you use the appliance for the first time, clean the surface with a soft cloth and a commercially available glass ceramic cleaner.

- Do not use the hob as a work surface or storage space.
- Prevent food from coming into contact with the hot-plate since this may lead to permanent discolouration of the surface.
- Carefully remove any food residue, sugar, plastic, aluminium foil and spilled food immediately with a glass scraper.
- Immediately remove the coarse dirt, salt and sugar from the cooking surface.
- Do not use cookware with a rough base.
- Lift the cookware when moving it.
- Do not use a scraper that is in poor condition.

25.2 Cleaning products

You can obtain suitable cleaning products and glass scrapers from customer service, the online shop or a retailer.

ATTENTION

Unsuitable cleaning products may damage the surfaces of the appliance.

- ▶ Never use unsuitable cleaning products.
- ▶ Do not use cleaning products while the hob is still hot. This may cause marks on the surface.

Unsuitable cleaning products

- Undiluted detergent
- Detergent intended for dishwashers
- Abrasive cleaning products
- Aggressive cleaning products such as oven spray or stain remover
- Abrasive sponges
- High-pressure or steam jet cleaners
- Basic products such as degreasing agents

25.3 Cleaning the hob

Clean the hob after every use to prevent cooking residues from getting burnt on.

Requirement: The hob must be cold. Do not allow the hob to cool down if it has sugar stains, rice starch, plastic or aluminium foil on it.

1. Remove heavy soiling using a glass scraper.
2. Spray the entire surface with soapy water or commercially available detergent. Only use cleaning agents for glass ceramic cooktops if there is stubborn dirt.
 - ▶ Apply the cleaning agent evenly and gently.
 - ▶ Follow the cleaning instructions on the packaging of the cleaning product.
 - ▶ You can achieve good cleaning results using a special sponge for glass ceramic.
3. Wipe it with a damp cloth and dry it with a cloth.

Tip: If you keep the base of the cookware clean, the hob surface remains in a good condition.

25.4 Cleaning profiles

Clean the profiles if they are dirty or stained after use.

Note: Do not use a glass scraper.

1. Clean using warm soapy water and a soft cloth. Wash new sponge cloths thoroughly before use.
2. Dry with a soft cloth.

25.5 Grease filter

The grease filter filters the grease out of the kitchen steam. The filter comprises a container and two removable grease filters. How frequently you clean the module depends on the quantity and type of grease used when cooking. To keep them in good working order, you must clean the grease filters if there are visible grease deposits or at least once a month.

⚠ WARNING – Risk of fire!

Fatty deposits in the grease filters may catch fire.

- ▶ Never operate the appliance without a grease filter.
- ▶ Clean the grease filters regularly.
- ▶ Never work with naked flames close to the appliance (e.g. flambéing).

ATTENTION

Falling grease filters may damage the hob below.

- ▶ Grip below the grease filter with one hand.

1. Remove the grease filter.
 - ▶ Grease may accumulate in the bottom of the container. Keep the grease filter level to prevent grease from dripping out.

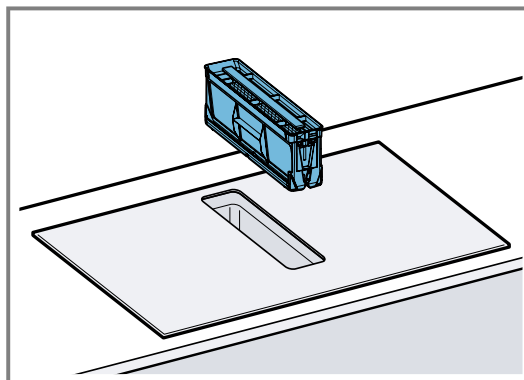

2. Remove the components of the grease filter.

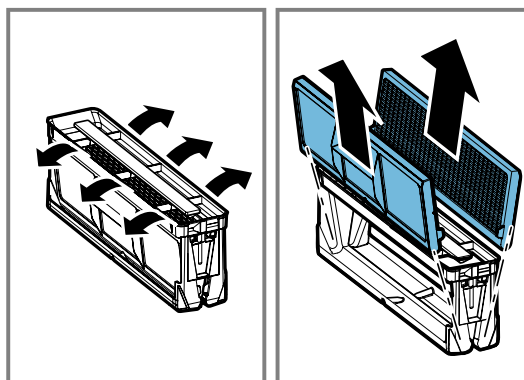

3. Clean the grease filter in the dishwasher or by hand.
 - "Cleaning the grease filters manually", Page 21
 - "Cleaning the grease filter in the dishwasher", Page 21
4. If required, remove the odour filters or acoustics filters and clean the appliance from the inside.
5. If any objects get into the appliance, remove these objects and ensure that the supply to the overflow container is not blocked.

6. Wipe out the inside of the appliance with soapy water and a dish cloth.
7. After cleaning, reinsert the dried grease filter.

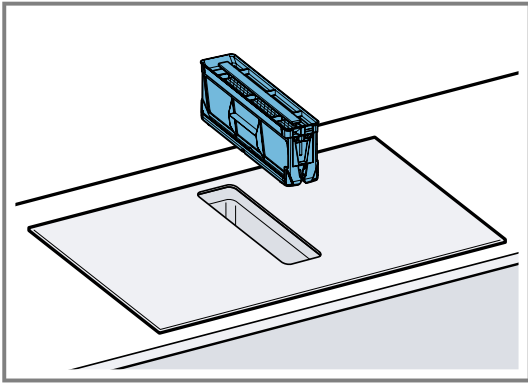

Cleaning the grease filters manually

1. Remove the components of the grease filter.
2. Soak the grease filter in hot soapy water.
 - ▶ Use a brush to clean the grease filter. Do not use aggressive, acidic or alkaline cleaning products.
 - ▶ Use special grease solvent for stubborn dirt. You can purchase the grease solvent from Customer Service, through our online shop or in a specialist shop.
3. Rinse the grease filters thoroughly.
4. Leave the grease filter to drain.
5. Fit the components of the grease filter.
6. After drying, insert the grease filter into the appliance.

Cleaning the grease filter in the dishwasher

1. Remove the grease filter.
2. Remove the components of the grease filter.
3. Place the components of the grease filter loosely in the dishwasher and do not jam them in.

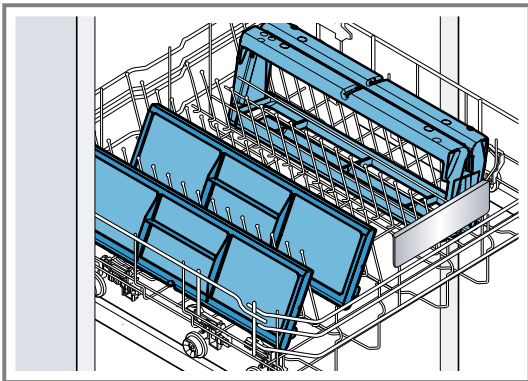

Do not clean heavily soiled grease filters with tableware. Do not use aggressive, acidic or alkaline cleaning products.

4. Start the dishwasher. Select a maximum temperature setting of 70 °C.
5. Leave the grease filter to drain.
6. After drying, insert the grease filter into the appliance.

25.6 Odour filter or acoustics filter

You can obtain odour filters or acoustics filters from specialist retailers, customer service or in the online shop.

Notes

- Replace the odour filters when the warning is displayed on the appliance.
→ "Resetting the saturation indicator", Page 21
- Change the acoustics filters if they are dirty.

Requirement: To keep them in good working order, only use genuine replacement filters.

1. Remove the grease filter.
2. Remove the four odour filters or acoustics filters, and dispose of them properly.

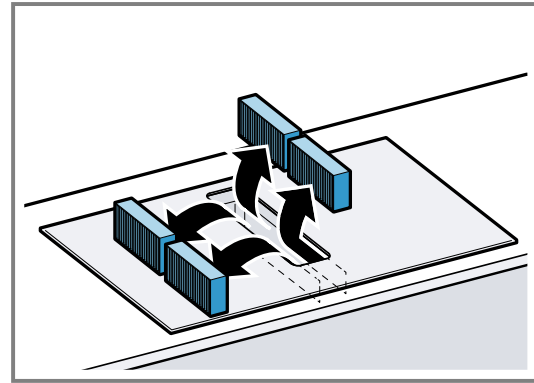

3. Insert two new odour filters or acoustics filters into the left and right of the appliance and slide them forwards.

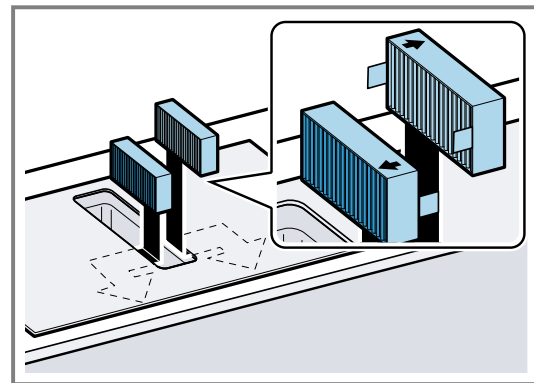

4. Insert the other odour filters or acoustics filters into the left and right of the appliance.

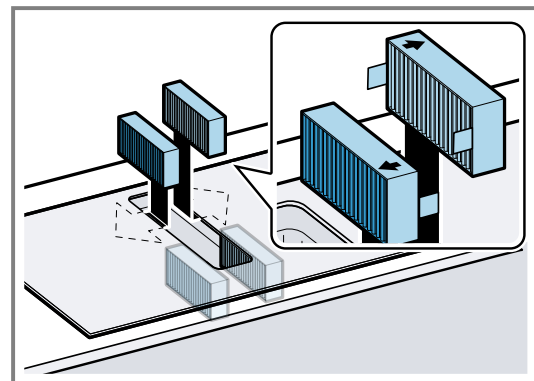

5. Insert the grease filter into the appliance.

Resetting the saturation indicator

After the appliance is switched off, *F* lights up.

- ▶ Replace the odour filters.
→ "Odour filter or acoustics filter", Page 21
- ✓ *F* stops lighting up. The odour filter display is reset.

25.7 Cleaning the overflow container

The overflow container collects liquids or objects that come into the appliance from above.

Requirement: The appliance has cooled and the residual heat indicator has gone out.

1. Hold the overflow container with one hand and unscrew it with the other hand.
 - ▶ Hold the overflow container level to prevent liquid from leaking out.

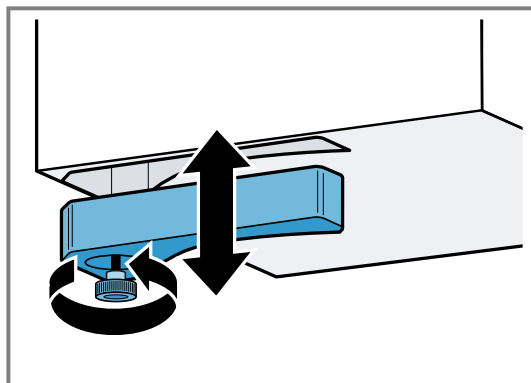

2. Empty the overflow container and rinse it out.
3. If required, unscrew the screw and clean the overflow container without the screw in the dishwasher.
4. Clean the overflow container before screwing it back into place.
5. Ensure that the supply to the overflow container is not blocked.

Remove any objects that have entered the appliance once it has cooled down. To do this, remove the grease filter.

26 Troubleshooting

You can rectify minor faults on your appliance yourself. Read the troubleshooting information before contacting after-sales service. This will avoid unnecessary costs.

⚠ **WARNING – Risk of injury!**

Improper repairs are dangerous.

- ▶ Repairs to the appliance should only be carried out by trained specialist staff.
- ▶ If the appliance is defective, call Customer Service.
 - "Customer Service", Page 24

⚠ **WARNING – Risk of electric shock!**

Improper repairs are dangerous.

- ▶ Repairs to the appliance should only be carried out by trained specialist staff.
- ▶ Only use genuine spare parts when repairing the appliance.
- ▶ If the power cord or the appliance power cable of this appliance is damaged, it must be replaced with a special power cord or special appliance power cable, which is available from the manufacturer or its Customer Service.
- ▶ If the power cord of this appliance is damaged, it must be replaced by trained specialist staff.

26.1 Warnings

Notes

- If *E* appears in the displays, press and hold the sensor for the respective cooking zone and read the fault code.
- If the fault code is not listed in the following table, disconnect the hob from the power supply and wait 30 seconds before reconnecting it. If this display ap-

pears again, contact Customer Service and specify the exact fault code.

- If an error occurs, the appliance does not switch to low power mode.
- In order to protect the appliance's electronic parts from overheating or surge currents, the hob may temporarily reduce the power level.

26.2 Information on the display panel

Fault	Cause and troubleshooting
No displays light up.	The power supply has been disconnected. <ul style="list-style-type: none"> ▶ Use other electrical appliances to check whether there has been a power failure.
	The appliance has not been connected as shown in the circuit diagram. <ul style="list-style-type: none"> ▶ Connect the appliance in accordance with the circuit diagram.
	Electronics fault <ul style="list-style-type: none"> ▶ If you are unable to rectify the fault, inform the technical after-sales service.

Fault	Cause and troubleshooting
Ventilation system not working	The appliance has not been connected as shown in the circuit diagram. ▶ Connect the appliance in accordance with the circuit diagram.
The displays flash.	The control panel is wet or an object is covering it. ▶ Dry the control panel or remove the object.
F	The odour filter is saturated or the saturation indicator lights up even though the filter has been replaced. ▶ Change the filter and reset the filter saturation indicator. You can find additional information about this in the section entitled . → "Cleaning and servicing", Page 19
F2, F 4, E 7015, E 8207, E 8208	The electronics have overheated and one or all of the cooking zones have been switched off. ▶ Wait until the electronics have cooled down sufficiently. Then touch any button on the control panel.
F5 + power level and audible signal	There is hot cookware in the vicinity of the control panel. This may cause the electronics to overheat. ▶ Remove the cookware. The fault display goes out shortly afterwards. You can continue to cook.
F5 and signal tone	There is hot cookware in the vicinity of the control panel. The cooking zone has been switched off to protect the electronics. ▶ Remove the cookware. Wait a few seconds. Touch any button. When the fault display goes out, you can continue cooking.
F1/F6	The cooking zone has overheated and has been switched off to protect the work surface. ▶ Wait until the electronics have cooled down sufficiently before switching the cooking zone back on.
F0	Transfer settings is not activated. ▶ Touch any button to confirm the fault display. You can continue to cook as normal without using the Transfer settings function. Contact customer service.
F8	The cooking zone has been operating continuously for an extended period. ▶ Individual safety switch-off is switched on. Touch any button to switch off the display so that you can set the cooking zone.
E 9000/E9010	The operating voltage is incorrect and outside of the normal operating range. ▶ Contact your energy supplier.
U400/E9011	The hob is not connected correctly. ▶ Disconnect the hob from the mains. Connect the hob in accordance with the circuit diagram.
d E	Demo mode is activated. ▶ Disconnect the hob from the mains. Wait for 30 seconds and connect the hob. Touch any sensor in the next three minutes. Demo mode is deactivated.
Home Connect is not working properly.	Different causes are possible. ▶ Go to www.home-connect.com .

26.3 Normal noises from your appliance

An induction hob may sometimes cause noises or vibrations, such as buzzing, crackling, hissing noises, fan noises or rhythmic noises.

27 Disposal

27.1 Disposing of old appliance

Valuable raw materials can be reused by recycling.

1. Unplug the appliance from the mains.

2. Cut through the power cord.

3. Dispose of the appliance in an environmentally friendly manner.

Information about current disposal methods are available from your specialist dealer or local authority.



This appliance is labelled in accordance with European Directive 2012/19/EU concerning used electrical and electronic appliances (waste electrical and electronic equipment - WEEE).

The guideline determines the framework for the return and recycling of used appliances as applicable throughout the EU.

28 Declaration of Conformity

BSH Hausgeräte GmbH hereby declares that the appliance with Home Connect functionality conforms to the basic requirements and other relevant provisions of Directive 2014/53/EU. A detailed RED Declaration of Conformity can be found online at www.bosch-home.com among the additional documents on the product page for your appliance.



Hereby, BSH Hausgeräte GmbH declares that the appliance with Home Connect functionality is in compliance with relevant statutory requirements.¹

A detailed Declaration of Conformity can be found online at www.bosch-home.co.uk among the additional documents on the product page for your appliance.¹



2.4 GHz band (2400–2483.5 MHz): Max. 100 mW
5-GHz band (5150–5350 MHz + 5470–5725 MHz): max. 50 mW

	BE	BG	CZ	DK	DE	EE	IE	EL	ES
	FR	HR	IT	CY	LI	LV	LT	LU	HU
	MT	NL	AT	PL	PT	RO	SI	SK	FI
	SE	NO	CH	TR	IS	UK (NI)			

5 GHz WLAN (Wi-Fi): For indoor use only.

AL	BA	MD	ME	MK	RS	UK	UA
----	----	----	----	----	----	----	----

5 GHz WLAN (Wi-Fi): For indoor use only.

28.1 Statement of Compliance for Great Britain

Product type

This statement of compliance covers the products described in this information for use whose model identifier group is seen on the title page. The full model identifier is made up of the characters before the slash in the product number (E no.) which can be found on the rating plate. Alternatively, you can also find the model identifier in the first line of the UK Energy Label.

Name and address of manufacturer

BSH Hausgeräte GmbH, Carl-Wery-Strasse 34, 81739 München, Germany

This statement of compliance is prepared by the manufacturer.

The manufacturer, BSH Hausgeräte GmbH deems that it has complied with

- provision 5.1-1 of ETSI EN 303 645 v2.1.1 and, where relevant, provision 5.1-2 of ETSI EN 303 645 v2.1.1;
- provision 5.2-1 of ETSI EN 303 645 v2.1.1;
- provision 5.3-13 of ETSI EN 303 645 v2.1.1.

Support period

BSH Hausgeräte GmbH will provide security updates that are necessary to maintain the main functions free of charge until at least 28/02/2034.

29 Customer Service

Function-relevant genuine spare parts according to the corresponding Ecodesign Order can be obtained from Customer Service for a period of at least 10 years from the date on which your appliance was placed on the market within the European Economic Area.

Note: Under the terms of the manufacturer's warranty the use of Customer Service is free of charge.

Detailed information about the warranty period and the warranty conditions in your country is available via the QR code on the enclosed document on service con-

¹ Only applies to Great Britain

tacts and warranty conditions, from our customer service or on our website.

If you contact Customer Service, you will require the product number (E-Nr.) and the production number (FD) of your appliance.

You can find the contact details for our customer service via the QR code on the enclosed document on service contacts and warranty conditions or on our website. You can find the information required as per Regulations (EU) 65/2014, (EU) 66/2014 and (EU) 2023/826 online at www.bosch-home.com on the product and service pages for your appliance, in the area of user manuals and additional documents.

29.1 Product number (E-Nr.) and production number (FD)

You can find the product number (E-Nr.) and the production number (FD) on the appliance's rating plate.

The rating plate can be found:

- On the appliance certificate.
- On the underside of the hob, towards the front.

The product number (E no.) can also be found on the glass ceramic. You can also display the customer service index (KI) and the production number (FD) in the basic settings. → *Page 15*

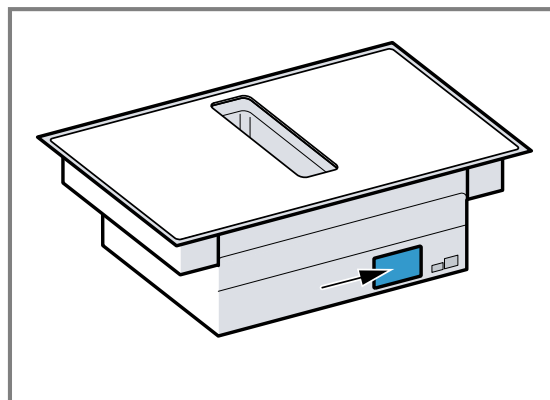

Make a note of your appliance's details and the Customer Service telephone number to find them again quickly.

30 Test dishes

These recommended settings are intended for test institutes to facilitate the testing of our appliances. The tests were carried out using our cookware sets for induction hobs. If required, these accessory sets can be purchased at a later point from specialist retailers, or through our technical after-sales service or our online shop.

30.1 Melting the chocolate coating

Ingredients: 150 g dark chocolate (55% cocoa).

- 16 cm saucepan without lid
 - Boiling: Power level 1.5

30.2 Heating and keeping lentil stew warm

Recipe in accordance with DIN 44550

Initial temperature 20 °C

Heating up without stirring

- 16 cm saucepan with lid, amount: 450 g
 - Heating up: Duration 1 min. 30 sec., power level 9
 - Simmering: Power level 1.5
- 20 cm saucepan with lid, amount: 800 g
 - Heating up: Duration 2 min. 30 sec., power level 9
 - Simmering: Power level 1.5

30.3 Heating and keeping lentil stew warm

E.g.: Lentil diameter 5–7 mm. Initial temperature 20 °C
Stir after heating for 1 minute

- 16 cm saucepan with lid, amount: 500 g
 - Heating up: Duration approx. 1 min. 30 sec., power level 9
 - Simmering: Power level 1.5
- 20 cm saucepan with lid, amount: 1 kg
 - Heating up: Duration approx. 2 min. 30 sec., power level 9
 - Simmering: Power level 1.5

30.4 Béchamel sauce

Milk temperature: 7 °C

- 16 cm saucepan without lid, ingredients: 40 g butter, 40 g flour, 0.5 l milk with 3.5% fat content and a pinch of salt

Preparing Béchamel sauce

1. Melt the butter, stir in the flour and salt, and heat up the mixture.
 - ▶ Heating up: Duration 6 min., power level 2
2. Add the milk to the roux and bring to the boil, stirring continuously.
 - ▶ Heating up: Duration 6 min. 30 sec., power level 7
3. Once the Béchamel sauce comes to the boil, leave it on the cooking zone for a further two minutes.
 - ▶ Simmering: Power level 2

30.5 Cooking rice pudding with the lid on

Milk temperature: 7 °C

1. Heat the milk until it starts to rise up. Heat up without a lid. Stir after heating for 10 min.

2. Set the recommended power level and add rice, sugar and salt to the milk.

The cooking time, including heating up, is approx. 45 minutes.

- 16 cm saucepan, ingredients: 190 g short-grain rice, 90 g sugar, 750 ml milk with 3.5% fat content and 1 g salt
 - Heating up: Duration approx. 5 min. 30 sec., power level 8.5
 - Simmering: Power level 3
- 20 cm saucepan, ingredients: 250 g short-grain rice, 120 g sugar, 1 l milk with 3.5% fat content and 1.5 g salt
 - Heating up: Duration approx. 5 min. 30 sec., power level 8.5
 - Simmering: Power level 3, stir after 10 minutes

30.6 Cooking rice pudding without a lid

Milk temperature: 7 °C

1. Add the ingredients to the milk and heat the mixture up while stirring continuously.
2. Once the milk has reached approx. 90 °C, select the recommended power level and leave it to simmer on a low heat for approx. 50 minutes.
 - 16 cm saucepan without lid, ingredients: 190 g short-grain rice, 90 g sugar, 750 ml milk with 3.5% fat content and 1 g salt
 - Heating up: Duration approx. 5 min. 30 sec., power level 8.5
 - Simmering: Power level 3
 - 20 cm saucepan without lid, ingredients: 250 g short-grain rice, 120 g sugar, 1 l milk with 3.5% fat content and 1.5 g salt
 - Heating up: Duration approx. 5 min. 30 sec., power level 8.5
 - Simmering: Power level 2.5

30.7 Cooking rice

Recipe in accordance with DIN 44550

Water temperature: 20 °C

- 16 cm saucepan with lid, ingredients: 125 g long-grain rice, 300 g water and a pinch of salt
 - Heating up: Duration approx. 2 min. 30 sec., power level 9
 - Simmering: Power level 2
- 20 cm saucepan with lid, ingredients: 250g long-grain rice, 600 g water and a pinch of salt
 - Heating up: Duration approx. 2 min. 30 sec., power level 9
 - Simmering: Power level 2.5

30.8 Roasting a pork loin

Initial temperature of the loin: 7 °C

- 24 cm pan without lid, ingredients: 3 pork loins, total weight approx. 300 g, 1 cm thick, and 15 g sunflower oil
 - Heating up: Duration approx. 1 min. 30 sec., power level 9
 - Simmering: Power level 7

30.9 Preparing crêpes

Recipe in accordance with DIN EN 60350-2

- 24 cm pan without lid, ingredients: 55 ml batter per crêpe
 - Heating up: Duration 1 min. 30 sec., power level 9
 - Simmering: Power level 7

30.10 Deep-fat frying frozen chips

- Pot dia. 20 cm without lid: ingredients: 2 l sunflower oil. For each frying time: 200 g frozen chips, 1 cm thick.
 - Heating up: Power level 9, until the oil temperature reaches 180 °C.
 - Simmering: Power level 9



Thank you for buying a Bosch Home Appliance!

Register your new device on MyBosch now and profit directly from:

- **Expert tips & tricks for your appliance**
- **Warranty extension options**
- **Discounts for accessories & spare-parts**
- **Digital manual and all appliance data at hand**
- **Easy access to Bosch Home Appliances Service**

Free and easy registration – also on mobile phones:
www.bosch-home.com/welcome

BOSCH
HOME APPLIANCES
SERVICE

Looking for help? You'll find it here.

Expert advice for your Bosch home appliances, help with problems
or a repair from Bosch experts.

Find out everything about the many ways Bosch can support you:

www.bosch-home.com/service

Contact data of all countries are listed in the attached service directory.

BSH Hausgeräte GmbH

Carl-Wery-Straße 34
81739 München, GERMANY
www.bosch-home.com

A Bosch Company

Valid within Great Britain:
Imported to Great Britain by
BSH Home Appliances Ltd.
Grand Union House
Old Wolverton Road
Wolverton, Milton Keynes
MK12 5PT
United Kingdom



9001996529 (050731) REG25

en