



# Oven

**HBF133BS0A**

[en] User manual and installation instructions

## Bosch BetterFood app

Discover your new appliance with a thousand flexible recipes!

- Vegan, low-carb or gluten-free? You can adapt all the recipes to your preferences.
- Discover recipes for the ingredients you already have at home.
- Healthy cooking made easy thanks to the Nutri-Check health compass.
- Get the optimum settings for your connected appliances in recipes.

This app is only available in certain European countries and languages.



You can find additional information and explanations online.  
Scan the QR code on the title page.



## Table of contents

### INFORMATION FOR USE

1	Safety .....	2	9	Childproof lock .....	11
2	Preventing material damage .....	4	10	Cleaning and servicing .....	11
3	Environmental protection and saving energy .....	5	11	Rails .....	13
4	Familiarising yourself with your appliance .....	5	12	Appliance door .....	14
5	Before using for the first time .....	9	13	Troubleshooting .....	17
6	Basic operation .....	9	14	Transportation and disposal .....	18
7	Rapid heating .....	9	15	Customer Service .....	18
8	Time-setting options .....	10	16	How it works .....	19
			17	INSTALLATION INSTRUCTIONS .....	22

## 1 Safety

Observe the following safety instructions.

### 1.1 Definition of the signal words

This is where you can find explanations for the safety signal words used in this manual.

#### **WARNING**

This indicates that death or serious injuries may occur as a result of non-observance of this warning.

#### **ATTENTION**

This indicates that damage to the appliance or other material damage may occur as a result of non-compliance with this warning.

**Note:** This alerts you to important information.

### 1.2 General information

- Read this instruction manual carefully.
- Keep the instruction manual and the product information safe for future reference or for the next owner.
- Do not connect the appliance if it has been damaged in transit.

### 1.3 Intended use

This appliance is designed only to be built into kitchen units. Read the special installation instructions.

Only a licensed professional may connect appliances without plugs. Damage caused by in-

correct connection is not covered under the warranty.

Only use this appliance:

- To prepare meals and drinks.
- in private households and in enclosed spaces in a domestic environment.
- Up to an altitude of 4000 m above sea level.

Do not use the appliance:

- with an external timer or a remote control.

### 1.4 Restriction on user group

Do not let children play with the appliance. Children must not perform cleaning or user maintenance unless they are at least 15 years old and are being supervised.

Keep children under the age of 8 years away from the appliance and power cable.

### 1.5 Safe use

Always place accessories in the cooking compartment the right way round.

#### **WARNING – Risk of fire!**

Combustible objects that are left in the cooking compartment may catch fire.

- ▶ Never store combustible objects in the cooking compartment.
- ▶ If smoke is emitted, the appliance must be switched off or the plug must be pulled out and the door must be held closed in order to stifle any flames.

Loose food remnants, fat and meat juices may catch fire.

- ▶ Before using the appliance, remove the worst of the food residues and remnants from the cooking compartment, heating elements and accessories.

Opening the appliance door creates a draught. Greaseproof paper may come into contact with the heating element and catch fire.

- ▶ Never place greaseproof paper loosely over accessories when preheating the appliance and while cooking.
- ▶ Always cut greaseproof paper to size and use a plate or baking tin to hold it down.

Overheating of the appliance may cause a fire.

- ▶ Never install the appliance behind a decorative door or unit door.

### ⚠ **WARNING – Risk of burns!**

The appliance and its parts that can be touched become hot during use.

- ▶ Caution should be exercised here in order to avoid touching heating elements.
- ▶ Young children under 8 years of age must be kept away from the appliance.

Accessories and cookware get very hot.

- ▶ Always use oven gloves to remove accessories or cookware from the cooking compartment.

When the cooking compartment is hot, any alcoholic vapours inside may catch fire. The appliance door may spring open. Hot steam and jets of flame may escape.

- ▶ Only use small quantities of drinks with a high alcohol content in food.
- ▶ Do not heat spirits ( $\geq 15\%$  vol.) when undiluted (e.g. for marinating or pouring over food).
- ▶ Open the appliance door carefully.

### ⚠ **WARNING – Risk of scalding!**

The accessible parts of the appliance become hot during operation.

- ▶ Never touch these hot parts.
- ▶ Keep children at a safe distance.

Hot steam may escape when you open the appliance door. Steam may not be visible, depending on the temperature.

- ▶ Open the appliance door carefully.
- ▶ Keep children at a safe distance.

If there is water in the cooking compartment when it is hot, this may create hot steam.

- ▶ Never pour water into the cooking compartment when the cooking compartment is hot.

### ⚠ **WARNING – Risk of injury!**

Scratched glass in the appliance door may develop into a crack.

- ▶ Do not use any harsh or abrasive cleaners or sharp metal scrapers to clean the glass on the oven door, as they may scratch the surface.

The hinges on the appliance door move when the door is opened and closed, which could trap your fingers.

- ▶ Keep your hands away from the hinges. If you leave the appliance door open, people may bump into it, resulting in injury.
- ▶ Always keep the appliance door closed during and after operation.

The appliance and its parts that can be touched may have sharp edges.

- ▶ Take care when handling and cleaning them.
- ▶ If possible, wear protective gloves. Components inside the appliance door may have sharp edges.
- ▶ Wear protective gloves.

### ⚠ **WARNING – Risk of electric shock!**

Improper repairs are dangerous.

- ▶ Repairs to the appliance should only be carried out by trained specialist staff.
- ▶ Only use genuine spare parts when repairing the appliance.
- ▶ If the power cord of this appliance is damaged, it must be replaced by the manufacturer, the manufacturer's Customer Service or a similarly qualified person in order to prevent any risk.

If the insulation of the power cord is damaged, this is dangerous.

- ▶ Never let the power cord come into contact with hot appliance parts or heat sources.
- ▶ Never let the power cord come into contact with sharp points or edges.
- ▶ Never kink, crush or modify the power cord. An ingress of moisture can cause an electric shock.

- ▶ Do not use steam- or high-pressure cleaners to clean the appliance.

If the appliance or the power cord is damaged, this is dangerous.

- ▶ Never operate a damaged appliance.
- ▶ Never pull on the power cord to unplug the appliance. Always unplug the appliance at the mains.
- ▶ If the appliance or the power cord is damaged, immediately unplug the power cord or switch off the fuse in the fuse box.
- ▶ Call customer service. → *Page 18*

**⚠ WARNING – Risk of suffocation!**

Children may put packaging material over their heads or wrap themselves up in it and suffocate.

- ▶ Keep packaging material away from children.
- ▶ Do not let children play with packaging material.

Children may breathe in or swallow small parts, causing them to suffocate.

- ▶ Keep small parts away from children.
- ▶ Do not let children play with small parts.

## 1.6 Halogen bulb

**⚠ WARNING – Risk of burns!**

The bulbs in the cooking compartment get very hot. There is still a risk of burning for some time after they have been switched off.

- ▶ Do not touch the glass cover.
- ▶ Avoid contact with your skin when cleaning.

**⚠ WARNING – Risk of electric shock!**

When changing the bulb, the bulb socket contacts are live.

- ▶ Before replacing the bulb, ensure that the appliance is switched off in order to prevent a potential electric shock.
- ▶ Also unplug the appliance from the mains or switch off the fuse in the fuse box.

---

## 2 Preventing material damage

### 2.1 General

**ATTENTION**

Alcoholic vapours may catch fire in the hot cooking compartment and cause permanent damage to the appliance. The appliance door may spring open due to an explosion and it may fall off. The door panels may shatter and fragment. Due to the resulting negative pressure, the cooking compartment may become considerably deformed inwards.

- ▶ Do not heat spirits ( $\geq 15\%$  vol.) when undiluted (e.g. for marinating or pouring over food).

If there is water on the cooking compartment floor when operating the appliance at temperatures above  $120\text{ }^{\circ}\text{C}$ , this will damage the enamel.

- ▶ Do not use the appliance if there is water on the cooking compartment floor.
- ▶ Wipe away any water on the cooking compartment floor before operation.

Objects on the cooking compartment floor at over  $50\text{ }^{\circ}\text{C}$  will cause heat to build up. The baking and roasting times will no longer be correct and the enamel will be damaged.

- ▶ Do not place any accessories, greaseproof paper or foil of any kind on the cooking compartment floor.
- ▶ Only place cookware on the cooking compartment floor if a temperature under  $50\text{ }^{\circ}\text{C}$  has been set.

When the cooking compartment is hot, any water inside it will create steam. The change in temperature may cause damage.

- ▶ Never pour water into the cooking compartment when it is still hot.
- ▶ Never place cookware containing water on the cooking compartment floor.

The prolonged presence of moisture in the cooking compartment leads to corrosion.

- ▶ Allow the cooking compartment to dry after use.
- ▶ Do not keep moist food in the cooking compartment for a long time with the door closed.
- ▶ Do not store food in the cooking compartment.
- ▶ Take care not to trap anything in the appliance door. Fruit juice dripping from the baking tray leaves stains that cannot be removed.
- ▶ When baking very juicy fruit flans, do not pack too much on the baking tray.
- ▶ If possible, use the deeper universal pan.

Using oven cleaner in a hot cooking compartment damages the enamel.

- ▶ Never use oven cleaner in the cooking compartment when it is still warm.
- ▶ Remove all food remnants from the cooking compartment and the appliance door before you next heat up the appliance.

If the seal is very dirty, the appliance door will no longer close properly during operation. This may damage the front of adjacent kitchen units.

- ▶ Keep the seal clean at all times.
- ▶ Never operate the appliance if the seal is damaged or missing.

Sitting or placing objects on the appliance door may damage it.

- ▶ Do not place, hang or support objects on the appliance door.
- ▶ Do not place cookware or accessories on the appliance door.

If aluminium foil comes into contact with the door pane, it could cause permanent discolouration.

- ▶ Do not allow aluminium foil in the cooking compartment to come into contact with the door pane.

## 3 Environmental protection and saving energy

### 3.1 Disposing of packaging

The packaging materials are environmentally compatible and can be recycled.

- ▶ Sort the individual components by type and dispose of them separately.

### 3.2 Saving energy

If you follow these instructions, your appliance will use less power.

Only preheat the appliance if the recipe or the recommended settings tell you to do so.

- ✓ Not preheating the appliance can reduce the energy used by up to 20%.

Use dark-coloured, black-coated or enamelled baking tins.

- ✓ These types of baking tin absorb the heat particularly well.

Open the appliance door as little as possible during operation.

- ✓ This maintains the temperature in the cooking compartment and eliminates the need for the appliance to reheat.

When baking multiple dishes, do so in succession or in parallel.

- ✓ The cooking compartment is heated after baking the first dish. This reduces the baking time for the subsequent cakes.

For longer cooking times, you can switch the appliance off 10 minutes before the cooking time ends.

- ✓ There is sufficient residual heat to finish cooking the dish.

Remove any accessories that are not being used from the cooking compartment.

- ✓ Accessories that are not being used do not need to be heated.

Allow frozen food to defrost before cooking.

- ✓ This saves the energy that would otherwise be required to defrost it.

**Note:** In accordance with the EU Ecodesign Directive 2023/826, this appliance is in a different state when switched off. This is referred to below as low power mode.

Even when the main function is not active, the appliance needs energy for:

- Detecting operation of the touch keys
- Monitoring door opening
- Editing the time (without display)

By definition, therefore, there is neither an "off" nor a "standby" mode, which is why the term low power mode is used. EN IEC 60350-1:2023 must be used to measure low power mode.

## 4 Familiarising yourself with your appliance

### 4.1 Control panels

You can use the control panel to configure all functions of your appliance and to obtain information about the operating status.

#### Controls

You can use the controls to configure all functions of your appliance and to obtain information about the operating status.

On certain models, specific details such as colour and shape may differ from those pictured.

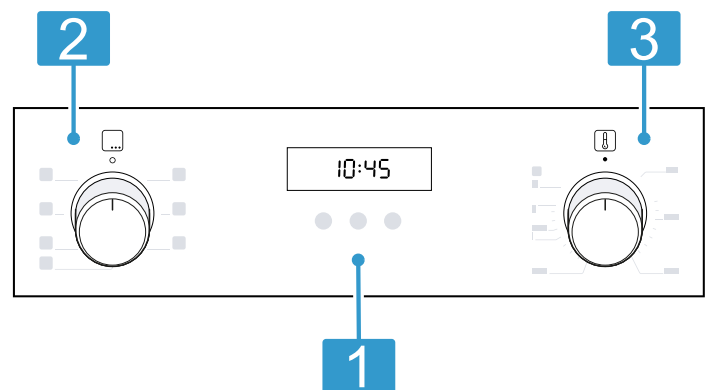



#### Buttons and display

The buttons are touch-sensitive surfaces. To select a function, simply press lightly on the relevant field. The display shows symbols for active functions and the time-setting options.

→ "Buttons and display", Page 6



### Function selector

Use the function selector to set the types of heating and other functions.

- 2** You can turn the function selector clockwise or anti-clockwise from the zero setting . Depending on the appliance, the function selector can be pushed in. Press on the function selector to click it into or out of the zero setting .  
→ "Types of heating and functions", Page 6







### Temperature selector

Use the temperature selector to set the temperature for the type of heating and select settings for other functions.

- 3** You can only turn the temperature selector clockwise from the zero setting  until it offers resistance. You cannot turn it any further than this. Depending on the appliance, the temperature selector can be pushed in. Press on the temperature selector to click it into or out of the zero setting .  
→ "Temperature and setting levels", Page 6





## Buttons and display

You can use the buttons to set various functions for your appliance. The display shows the settings. If a function is active, the corresponding symbol lights up on the display.  only lights up when you change the time.

Symbol	Function	Use
	Childproof lock	Activate or deactivate the childproof lock.
	Time-setting options	Select the time  , timer  , cooking time  and the end time  . To select the individual time-setting options, press  several times.
-	Minus	Decrease the setting values.
+	Plus	Increase the setting values.



## Types of heating and functions

To ensure that you always find the right type of heating to cook your food, we explain the differences and applications below.

Symbol	Type of heating	What it's used for and how it works
	3D hot air	Bake or roast on one or more levels. The fan distributes the heat from the ring-shaped heating element in the back wall evenly around the cooking compartment.
	Hot air gentle	Cook selected dishes gently on one level without preheating. The fan distributes the heat from the ring-shaped heating element in the back wall evenly around the cooking compartment. The food is cooked in phases using residual heat. Select a temperature between 120 °C and 230 °C. This type of heating is used to determine the energy consumption in air recirculation mode and the energy efficiency class.
	Full-surface grill	Grill flat items such as steak, sausages, or toast. Gratinated food. The entire area below the grill element becomes hot.
	Hot air grilling	Roast poultry, whole fish or large pieces of meat. The grill element and the fan switch on and off alternately. The fan circulates the hot air around the food.
	Top/bottom heating	Traditionally bake or roast on one level. This type of heating is especially suitable for cakes with moist toppings. The heat is emitted evenly from above and below. This type of heating is used to determine the energy consumption in the conventional mode.

## Additional functions

Here, you can find an overview of other functions of your appliance.

Symbol	Function	Use
	Rapid heating	Rapidly preheat the cooking compartment without accessories. → "Rapid heating", Page 9
	Oven light	Light up the cooking compartment without heating. → "Lighting", Page 7

## Temperature and setting levels

There are different settings for the types of heating and functions.

**Note:** For temperature settings above 250 °C, the appliance reduces the temperature to approx. 240 °C after approx. 10 minutes.

Symbol	Function	Use
●	Zero setting	The appliance does not heat up.
50–275	Temperature range	Set the temperature in the cooking compartment in °C.
1, 2, 3 or I, II, III	Grill settings	Depending on the appliance type, set the grill settings for the grill, for the large area and grill, or for the small area. 1 = low 2 = medium 3 = high

### Heat-up indicator

The appliance indicates when it is heating up. When the appliance is heating,  lights up on the display. This symbol goes out when heating is paused. When you preheat the appliance, the optimal time to place your food in the cooking compartment is when the symbol first goes out.

**Note:** Due to thermal inertia, the temperature that is displayed may differ slightly from the actual temperature inside the cooking compartment.

## 4.2 Cooking compartment

The functions in the cooking compartment make your appliance easier to use.

### Rails

The shelf supports in the cooking compartment enable you to place accessories at different heights. The cooking compartment has five shelf positions. The shelf positions are numbered from bottom to top. You can remove the rails, e.g. for cleaning.  
→ "Rails", Page 13

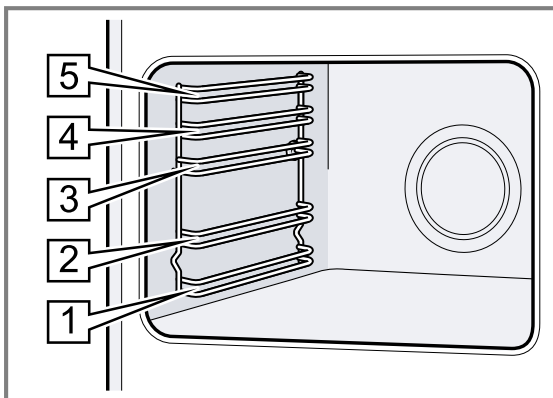

### Self-cleaning surfaces

The back panel in the cooking compartment is self-cleaning. The self-cleaning surfaces are coated with a

## 4.3 Accessories

Use original accessories. These have been made especially for your appliance.

**Note:** Heat may deform the accessory. This deformation has no effect on the function. When the accessory cools down, it will regain its original shape.

The accessories supplied may differ depending on the appliance model.

porous, matte ceramic layer and have a coarse surface. When the appliance is in operation, the self-cleaning surfaces absorb splashes from roasting or grilling and break them down.

If the self-cleaning surfaces no longer clean themselves adequately during operation, heat up the cooking compartment specifically to the right temperature.

→ "Cleaning self-cleaning surfaces in the cooking compartment", Page 13

### Lighting

The oven light lights up the cooking compartment. With most types of heating and functions, the lighting lights up during operation. If you use the function selector to end the operation, the lighting switches off. The oven light setting on the function selector can be used to switch on the light without heating.

### Appliance door

If you open the appliance door during operation, the operation continues.

### Cooling fan

The cooling fan switches on and off depending on the appliance's temperature. The hot air escapes above the door.

#### ATTENTION

Do not cover the ventilation slot above the appliance door.

The appliance overheats.

- ▶ Ensure that the ventilation slots are unobstructed.

To ensure that the appliance cools down more quickly after operation, the cooling fan continues to run for a certain period afterwards.

### Condensation

Condensation can occur in the cooking compartment and on the appliance door when cooking. Condensation is normal and does not adversely affect appliance operation. Wipe away the condensation after cooking.

Accessories	Use
Wire rack	<ul style="list-style-type: none"> <li>■ Baking tins</li> <li>■ Ovenproof dishes</li> <li>■ Cookware</li> <li>■ Meat, e.g. roasting joints or steak</li> <li>■ Frozen meals</li> </ul>
Universal pan	<ul style="list-style-type: none"> <li>■ Moist cakes</li> <li>■ Biscuits</li> <li>■ Bread</li> <li>■ Large roasts</li> <li>■ Frozen meals</li> <li>■ Catching dripping liquids, e.g. fat when grilling food on the wire rack.</li> </ul>
Baking tray	<ul style="list-style-type: none"> <li>■ Tray bakes</li> <li>■ Sponge cake, simple</li> </ul>

### Locking function

The locking function prevents the accessories from tilting when they are pulled out. You can pull out the accessories approximately halfway without them tipping. The accessories must be inserted into the cooking compartment correctly for the tilt protection to work properly.

### Sliding accessories into the cooking compartment

Always slide the accessory into the cooking compartment the right way round. This is the only way to ensure that accessories can be pulled out approximately halfway without tipping.

1. Turn the accessories so that the notch  is at the rear and is facing downwards.
2. Insert the accessory between the two guide rods for a shelf position.

3. Push the accessory all the way in, making sure that it does not touch the appliance door.

**Note:** Take any accessories that you will not be using out of the cooking compartment while the appliance is in operation.

### Combining accessories

You can combine the wire rack with the universal pan to catch any liquid that drips down.

1. Place the wire rack on the universal pan so that both spacers  are on the rear edge of the universal pan.
2. Insert the universal pan between the two guide rods for a shelf position. In so doing, the wire rack is on top of the upper guide rod.

Wire rack on universal pan

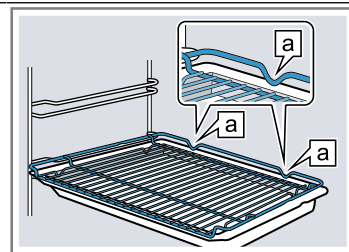

Wire rack Insert the wire rack with the open side facing the appliance door and the curved lip  facing downwards.

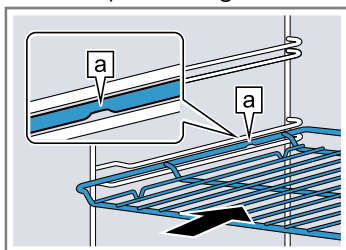

Tray E.g. universal pan or baking tray Slide the tray in with the sloping edge  towards the appliance door.

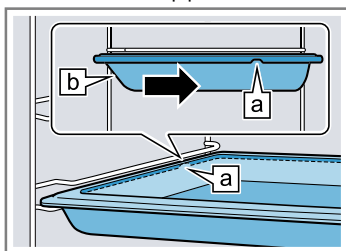

### Other accessories

You can purchase other accessories from our customer service, specialist retailers or online.

You will find a comprehensive range of products for your appliance in our brochures and online: [www.bosch-home.com](http://www.bosch-home.com)

Accessories are appliance-specific. When purchasing accessories, always quote the exact product number (E no.) of your appliance.

You can find out which accessories are available for your appliance in our online shop or from our customer service.

## 5 Before using for the first time

Configure the settings for initial start-up. Clean the appliance and accessories.

### 5.1 Initial configuration

Implement the settings for the initial configuration.

### 5.2 Cleaning the appliance before using it for the first time

Clean the cooking compartment and accessories before using the appliance to prepare food for the first time.

1. Remove the accessory and the leftover packaging, such as polystyrene pellets, from the cooking compartment.
2. Before heating, wipe the smooth surfaces in the cooking compartment with a soft, damp cloth.

3. Ventilate the room while the appliance is heating.
4. Set the type of heating and the temperature.  
→ "Basic operation", Page 9

Type of heating	3D hot air 
-----------------	--

Temperature	Maximum
-------------	---------

Cooking time	1 hour
--------------	--------

5. Switch off the appliance after the specified cooking time.
6. Wait until the cooking compartment has cooled down.
7. Clean the smooth surfaces with soapy water and a dish cloth.
8. Clean the accessory with soapy water and a dish cloth or a soft brush.

## 6 Basic operation

### 6.1 Switching on the appliance

- ▶ Turn the function selector to any position other than the "Off" position .
- ✓ The appliance is switched on.

### 6.2 Switching off the appliance

- ▶ Turn the function selector to the "Off" position .
- ✓ The appliance is switched off.

### 6.3 Types of heating and temperature

1. Use the function selector to set the type of heating.
2. Use the temperature selector to set the temperature or grill setting.
- ✓ The appliance starts heating after a few seconds.
3. When the dish is ready, switch off the appliance.

#### Tips

- The most suitable type of heating for your food can be found in the description of the types of heating.
- You can also set a cooking time and an end time on the appliance.  
→ "Time-setting options", Page 10

#### Changing the type of heating

You can change the type of heating at any time.

- ▶ Use the function selector to set the required type of heating.

#### Changing the temperature

You can change the temperature at any time.

- ▶ Turn the temperature selector to set the desired temperature.

## 7 Rapid heating

To save time, you can use the rapid heating to shorten the preheat time.

Only use rapid heat-up when a temperature of over 100 °C has been set.

After rapid heating, it is best to use the following types of heating:

- 3D hot air 
- Top/bottom heating 

### 7.1 Setting rapid heating

To ensure an even cooking result, do not place the food in the cooking compartment until rapid heating has come to an end.





1. Use the function selector to select rapid heating .
2. Use the temperature selector to set the required temperature.
- ✓ Rapid heating starts after a few seconds.
- ✓ When the rapid heating process ends, an audible signal sounds and the heating indicator goes out.
3. Use the function selector to set a suitable type of heating.
4. Place the food in the cooking compartment.

## 8 Time-setting options

Your appliance has different time-setting options which ensure that operation can be controlled.

### 8.1 Overview of the time-setting options





You can use the  button to select the different time-setting options.



Time-setting option	Use
Timer 	The timer can be set independently of the operation. It does not affect the appliance.
Cooking time 	If a cooking time has been set for the operation, the appliance stops heating automatically once this time has elapsed.
End 	A time at which the operation ends can be set for the cooking time. The appliance starts up automatically so that it finishes cooking at the required time.
Time 	Set the time.

### 8.2 Setting the timer

The timer runs independently of the appliance when it is in operation. The timer can be set up to 23 hours and 59 minutes regardless of whether the appliance is on or off. The timer has its own audible signal so that you can tell whether it is the timer or a cooking time which has elapsed.

**Note:** The timer and cooking time cannot count down at the same time. If a cooking time has already been set, you cannot set the timer.

1. Press  repeatedly until  is selected in the display.
2. Use the  or  button to set the timer duration.

Button	Recommended value
	5 minutes
	10 minutes



Up to 10 minutes, the timer duration can be set in 30-second increments. The time increments become bigger as the value increases.

- ✓ The timer starts and the timer duration begins to count down after a few seconds.
  - ✓ An audible signal sounds and the timer duration is zero in the display when the timer duration has elapsed.
3. Once the timer duration has elapsed
    - ▶ Press any button to switch off the timer.

### Changing the timer

The timer duration can be changed at any time.



**Requirement:**  is highlighted in the display.

- ▶ Use the  or  button to change the timer duration.
- ✓ The appliance applies the change after a few seconds.

### Cancelling the timer

The timer duration can be cancelled at any time.





**Requirement:**  is highlighted in the display.



- ▶ Use the  button to reset the timer duration to zero.
- ✓ After a few seconds, the appliance applies the change and  goes out.

### 8.3 Setting the cooking time

The cooking time can be set to up to 23 hours and 59 minutes for the operation.

**Requirement:** The type of heating and temperature or setting have been set.

1. Press  repeatedly until  is selected in the display.
2. Use the  or  button to set the cooking time.

Additional programme	Recommended value
	10 minutes
	30 minutes



The cooking time can be set in one-minute increments up to one hour, and then in five-minute increments.

- ✓ After a few seconds, the appliance starts heating and the cooking time counts down.
  - ✓ When the cooking time has elapsed, a signal sounds and the duration is at zero in the display.
3. When the cooking time has elapsed:
    - ▶ Press any button to end the signal prematurely.
    - ▶ To set another cooking time, press the  button.
    - ▶ When the dish is ready, switch off the appliance.

### Changing the cooking time

The cooking time can be changed at any time.

**Requirement:**  is highlighted in the display.

- ▶ Change the cooking time using the  or  button.
- ✓ The appliance applies the change after a few seconds.

### Cancelling the cooking time

The cooking time can be cancelled at any time.

**Requirement:**  is highlighted in the display.

- ▶ Reset the cooking time to zero using the  button.
- ✓ After a few seconds, the appliance applies the change and continues to heat without a cooking time.

### 8.4 Setting the end time

You can delay the time at which the cooking time is due to end by up to 23 hours and 59 minutes.

#### Notes

- The end time cannot be set for types of heating with grill function.
- In order to achieve a good cooking result, do not delay the end time once the appliance is already operating.
- Food will spoil if you leave it in the cooking compartment for too long.

#### Requirements

- The type of heating and temperature or setting have been set.
- A cooking time must be set.

1. Press  repeatedly until →I is selected in the display.
2. Press the — or + button.
  - ✓ The display shows the calculated end time.
3. Use the — or + button to delay the end time.
  - ✓ After a few seconds, the appliance applies the setting and the display shows the set end time.
  - ✓ Once the calculated start time has been reached, the appliance starts heating up and the cooking time starts counting down.
  - ✓ When the cooking time has elapsed, a signal sounds and the duration is at zero in the display.
4. When the cooking time has elapsed:
  - ▶ Press any button to end the signal prematurely.
  - ▶ To set another cooking time, press the + button.
  - ▶ When the dish is ready, switch off the appliance.

### Changing the end time

In order to achieve a good cooking result, you can only change the set end time before operation starts and the cooking time starts counting down.

**Requirement:** →I is highlighted in the display.

- ▶ Use the — or + button to delay the end time.
- ✓ The appliance applies the change after a few seconds.

### Cancelling the end time

You can delete the set end time at any time.

**Requirement:** →I is highlighted in the display.

- ▶ Reset the end time to the current time plus the set cooking time using the — button.
- ✓ After a few seconds, the appliance applies the change and starts heating up. The cooking time counts down.

### 8.5 Setting the time

Once the appliance has been connected to the mains or after a power cut, the time flashes in the display. The time starts at "12:00". Set the current time.

**Requirement:** The function selector must be set to the off  position.

1. Use — or + to set the time.
  2. Press .
- ✓ The time that is set appears in the display.



## 9 Childproof lock

Secure the appliance to prevent children from accidentally switching it on or changing the settings.

**Note:** After a power cut, the childproof lock will no longer be active.

### 9.1 Activating and deactivating the childproof lock

**Requirement:** The function selector must be set to the off  position.

- ▶ To activate the childproof lock, press and hold the  button until *SAFE* appears in the display.
  - ▶ To deactivate the childproof lock, press and hold the  button until *SAFE* goes out in the display.

## 10 Cleaning and servicing

### 10.1 Cleaning agent

To avoid damaging the different surfaces of the appliance, do not use unsuitable cleaning agents.

#### **WARNING – Risk of electric shock!**

An ingress of moisture can cause an electric shock.

- ▶ Do not use steam- or high-pressure cleaners to clean the appliance.

#### **ATTENTION**

Unsuitable cleaning agents damage the surfaces of the appliance.

- ▶ Do not use aggressive or abrasive cleaning agents.

### Suitable cleaning agents

Only use cleaning agents that are suitable for the different surfaces on your appliance.

Follow the instructions on cleaning the appliance.

→ "Cleaning the appliance", Page 12

- ▶ Do not use cleaning products with a high alcohol content.
- ▶ Do not use hard scouring pads or cleaning sponges.
- ▶ Do not use any special cleaners if the appliance is still warm.

Using oven cleaner in a hot cooking compartment damages the enamel.

- ▶ Do not use oven cleaner in the cooking compartment when it is still warm.
- ▶ Remove all food remnants from the cooking compartment and the appliance door before you next heat up the appliance.

New sponge cloths contain residues from production.

- ▶ Wash new sponge cloths thoroughly before use.

## Appliance

Surface	Suitable cleaning agents	Information
Stainless steel	<ul style="list-style-type: none"> <li>▪ Hot soapy water</li> <li>▪ Special stainless steel cleaning products suitable for hot surfaces</li> </ul>	To prevent corrosion, remove any limescale, grease, starch or albumin (e.g. egg white) stains on stainless steel surfaces immediately. Apply a thin layer of the stainless steel cleaning product.
Enamel, plastic, painted, and screen-printed surfaces E.g. control panel	<ul style="list-style-type: none"> <li>▪ Hot soapy water</li> </ul>	Do not use a glass cleaning product or a glass scraper.
Knobs	<ul style="list-style-type: none"> <li>▪ Hot soapy water</li> </ul>	Clean with a dish cloth and dry with a soft cloth. Do not remove or scrub.

## Appliance cover

Area	Suitable cleaning agents	Information
Door panels	<ul style="list-style-type: none"> <li>▪ Hot soapy water</li> </ul>	Do not use a glass scraper or steel wool. <b>Tip:</b> Remove the door panels in order to clean them thoroughly. → "Appliance door", Page 14
Door cover	<ul style="list-style-type: none"> <li>▪ Made of stainless steel: Stainless steel cleaner:</li> <li>▪ Made of plastic: Hot soapy water</li> </ul>	Do not use a glass cleaning product or a glass scraper. <b>Tip:</b> To thoroughly clean the cover plate, remove the cover. → "Appliance door", Page 14
Door handle	<ul style="list-style-type: none"> <li>▪ Hot soapy water</li> </ul>	In order to avoid stubborn dirt, remove descaling agents from the door handle immediately.
Door seal	<ul style="list-style-type: none"> <li>▪ Hot soapy water</li> </ul>	Do not remove or scrub.

## Hob

Area	Suitable cleaning agents	Information
Enamelled surfaces	<ul style="list-style-type: none"> <li>▪ Hot soapy water</li> <li>▪ Vinegar solution</li> <li>▪ Oven cleaner</li> </ul>	Soak any heavily soiled areas and use a brush or steel wool. Leave the appliance cover open so that the hob can dry after it has been cleaned. <b>Notes</b> <ul style="list-style-type: none"> <li>▪ Enamel burns at very high temperatures, causing minor discolouration. The functionality of the appliance is not affected by this.</li> <li>▪ The edges of thin baking trays cannot be completely enamelled and may be rough. This does not impair the corrosion protection.</li> <li>▪ Food residues leave a white coating on the enamelled surfaces. The coating does not pose a health risk. The functionality of the appliance is not affected by this. You can remove these residues with lemon juice.</li> </ul>
Self-cleaning surfaces	-	Follow the instructions for self-cleaning surfaces. → "Cleaning self-cleaning surfaces in the cooking compartment", Page 13
Glass cover on the oven light	<ul style="list-style-type: none"> <li>▪ Hot soapy water</li> </ul>	Use oven cleaner to remove very heavy soiling.
Rails	<ul style="list-style-type: none"> <li>▪ Hot soapy water</li> </ul>	Soak any heavily soiled areas and use a brush or steel wool. <b>Tip:</b> Remove the shelf supports for cleaning. → "Rails", Page 13
Accessories	<ul style="list-style-type: none"> <li>▪ Hot soapy water</li> <li>▪ Oven cleaner</li> </ul>	Soak any heavily soiled areas and use a brush or steel wool. Enamelled accessories are dishwasher-safe.

## 10.2 Cleaning the appliance

In order to avoid damaging the appliance, clean your appliance only as specified, and using suitable cleaning products.

**⚠ WARNING – Risk of burns!**

The appliance and its parts that can be touched become hot during use.

- ▶ Caution should be exercised here in order to avoid touching heating elements.
- ▶ Young children under 8 years of age must be kept away from the appliance.

**⚠ WARNING – Risk of fire!**

Loose food remnants, fat and meat juices may catch fire.

- ▶ Before using the appliance, remove the worst of the food residues and remnants from the cooking compartment, heating elements and accessories.

**Requirement:** Read the information on cleaning agents.

→ "Cleaning agent", Page 11

1. Clean the appliance using hot soapy water and a dish cloth.
  - ▶ For some surfaces, you can use alternative cleaning agents.
    - "Suitable cleaning agents", Page 11
2. Dry with a soft cloth.

**10.3 Cleaning controls****⚠ WARNING – Risk of electric shock!**

An ingress of moisture can cause an electric shock.

- ▶ Do not detach the control knobs to clean them.
- ▶ Do not use wet sponge cloths.

1. Observe the information regarding the cleaning agents.
2. Clean using a damp sponge cloth and hot soapy water.
3. Dry with a soft cloth.

**10.4 Cleaning self-cleaning surfaces in the cooking compartment**

The back wall in the cooking compartment is self-cleaning. The self-cleaning surfaces are coated with a porous, matt ceramic layer and have a rough surface. When the appliance is in operation, the self-cleaning surfaces absorb splashes from roasting or grilling and break them down. If the self-cleaning surfaces no longer clean sufficiently during operation, heat up the cooking compartment specifically.

**ATTENTION**

If the self-cleaning surfaces are not cleaned regularly, the surfaces may be damaged.

- ▶ If dark spots can be seen on the self-cleaning surfaces, heat up the cooking compartment.
- ▶ Do not use any oven cleaners or abrasive cleaning aids. If oven cleaner accidentally comes into contact with the self-cleaning surfaces, dab the surfaces immediately with water and a sponge cloth. Do not rub them.

1. Remove the accessories and cookware from the cooking compartment.
2. Detach the shelf supports and remove them from the cooking compartment.
  - "Rails", Page 13
3. Clean coarse dirt with hot soapy water and a soft cloth:
  - From the smooth enamel surfaces
  - From the inside of the appliance cover
  - From the glass cover on the oven lamp
 This prevents stubborn stains.
4. Remove any objects from the cooking compartment. The cooking compartment must be empty.
5. Use the function selector to set **3D hot air**.
6. Use the temperature selector to set the maximum temperature.
  - ✓ The appliance starts heating after a few seconds.
7. Switch off the appliance after 1 hour.
8. Once the appliance has cooled down sufficiently, wipe the cooking compartment with a damp cloth.
 

**Note:** Reddish marks may appear on the self-cleaning surfaces. This is not rust, but the residues of salty food. Nutrients such as sugars and proteins are not removed from the surface coating and may stick to the surface. These spots are not harmful and do not impair the cleaning ability of the self-cleaning surfaces.
9. Attach the shelf supports.
  - "Rails", Page 13

**10.5 Cleaning the stainless steel surfaces**

1. Observe the information regarding the cleaning agents.
2. Clean using a sponge cloth and hot soapy water in the direction of the finish.
3. Dry with a soft cloth.
4. Apply a thin layer of the stainless steel cleaning product with a soft cloth.

**Tip:** You can obtain stainless steel cleaning products from after-sales service or the online shop.

## 11 Rails

To clean the rails and cooking compartment thoroughly, you can remove the shelf supports.

**11.1 Unhooking the rails****⚠ WARNING – Risk of burns!**

The rails can be very hot.

- ▶ Never touch the rails when they are hot.
- ▶ Allow the appliance to cool down.

- ▶ Keep children at a safe distance.

1. Lift the front rail upwards and unhook it.

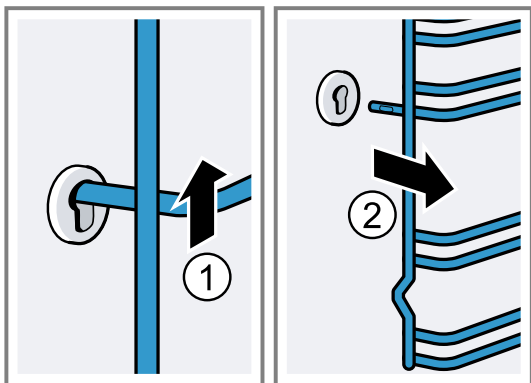

2. Then push the entire rail to the front and remove it.

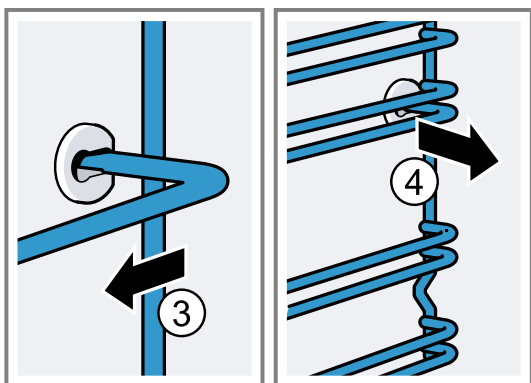

## 11.2 Attaching the rails

1. First insert the rail into the rear socket, press it to the back slightly

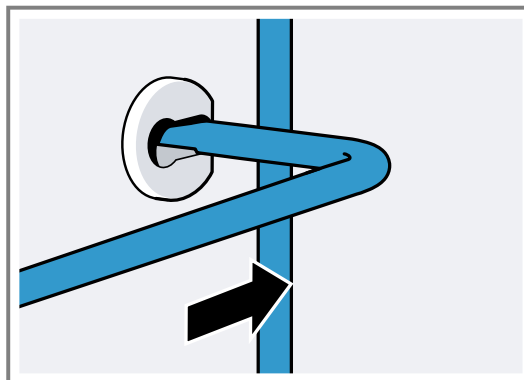

2. and insert it into the socket at the front.

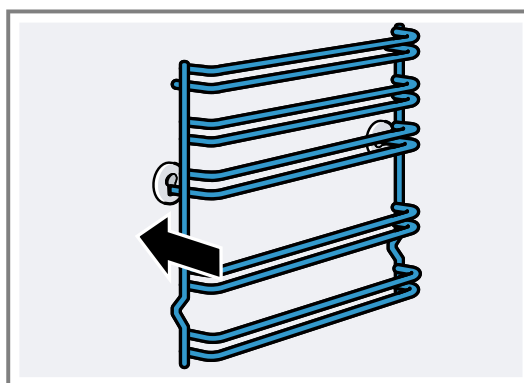

The rails fit both on the left and right sides. Shelf positions 1 and 2 are located at the bottom and shelf positions 3, 4 and 5 are located at the top.

## 12 Appliance door

It is normally sufficient if you clean the outside of the appliance door. If the appliance door is very dirty on the inside and outside, you can remove the appliance door and clean it.

### 12.1 Door hinges

#### ⚠ WARNING – Risk of injury!

When the hinges are not secured, they can snap shut with great force.

- ▶ If you open the appliance door, ensure that the locking levers are fully open or fully closed.

1. The oven door hinges each have a locking lever. When the locking levers are closed, the oven door is secured in place.

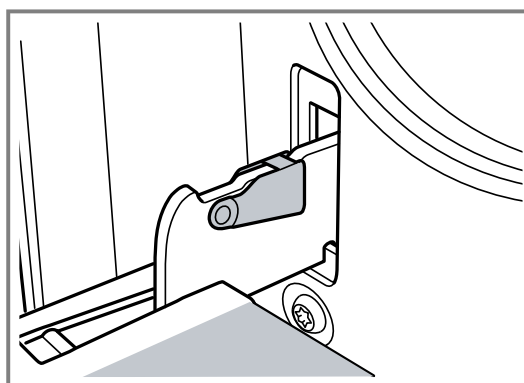

It cannot be detached.

2. When the locking levers are open in order to detach the oven door, the hinges are secured.

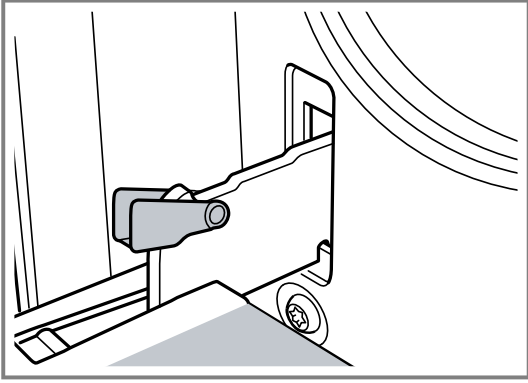

The hinges cannot snap shut.

## 12.2 Removing the appliance door

1. Open the oven door fully.
2. Open the locking levers on the left- and right-hand hinges.

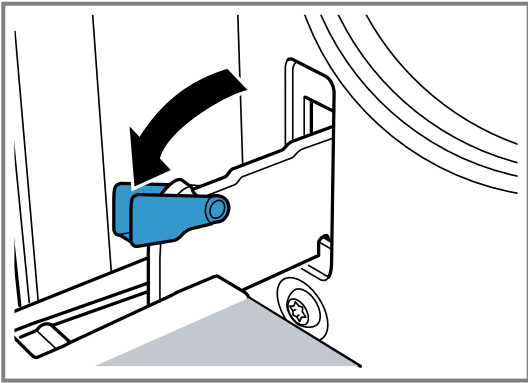

3. Close the oven door as far as the limit stop. Grip the left and right hand sides of the door with both hands. Close the door slightly more and remove it.

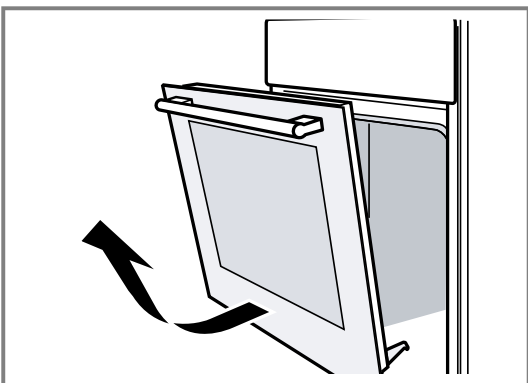

## 12.3 Removing the door panes

The glass panes of the oven door can be removed to make cleaning easier.

### ⚠ WARNING – Risk of injury!

Scratched glass in the appliance door may develop into a crack.

- ▶ Do not use any harsh or abrasive cleaners or sharp metal scrapers to clean the glass on the oven door, as they may scratch the surface.

The components in the appliance door may have sharp edges.

- ▶ Wear gloves.

1. Detach the oven door.  
→ "Removing the appliance door", Page 15
2. Position it on a cloth with its handle pointing downwards.
3. To remove the upper cover of the oven door, press in the tabs on the left and right using your fingers. Pull out and remove the cover.

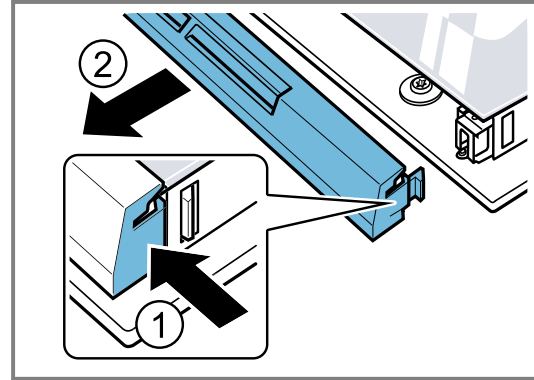

4. Lift the top pane up and out.

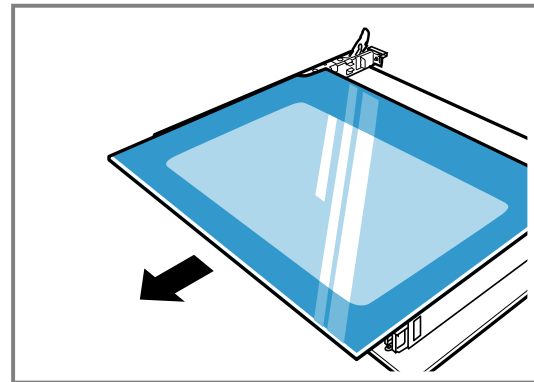

5. Lift the panel up and out.

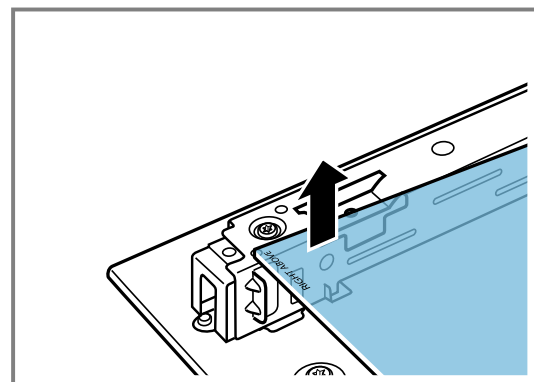

## 12.4 Fitting the door panes

When fitting the panes, ensure that the lettering "top right" is not upside down at the bottom left.

1. Insert the pane diagonally towards the back.

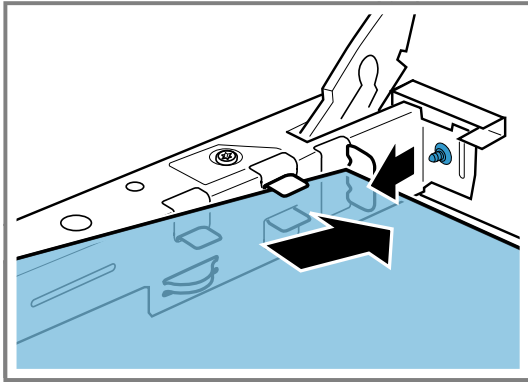

2. Hold the top pane in both brackets and insert it at an angle towards the back.

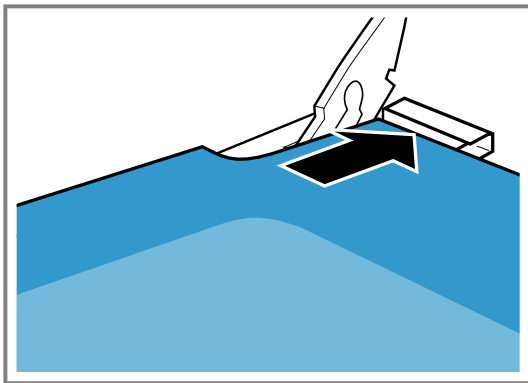

Push the pane into both openings on the underside. The smooth surface of the pane must face outwards.

3. Place the cover at the top of the oven door and press it on. The mounting brackets must lock in place on both sides.
4. Attach the oven door.

→ "Attaching the appliance door", Page 16

**Note:** Only use the oven once the glass panes have been correctly fitted.

## 12.5 Attaching the appliance door

Reattach the oven door in the reverse sequence to removal.

### ⚠ **WARNING – Risk of injury!**

The oven door might accidentally fall or a hinge may suddenly snap shut.

- ▶ In this case, do not hold onto the hinge. Call customer service.

1. When attaching the oven door, ensure that both hinges are inserted in the opening direction.

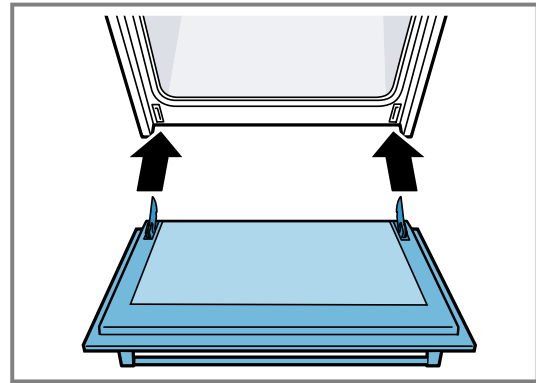

2. The notch on the hinge must engage on both sides.

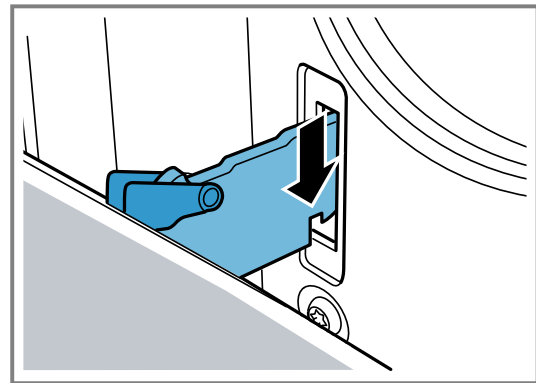

3. Close both locking levers again.

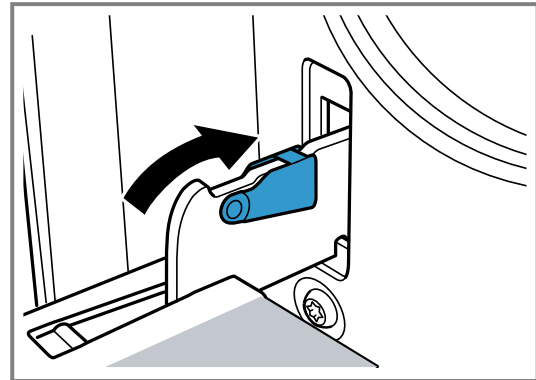

4. Close the appliance door.

## 12.6 Additional door safety

Additional safety devices have been fitted to prevent contact with the oven doors. Always attach these safety devices when children could come near the oven. You can purchase this special accessory from after-sales service. 11023590

### ⚠ **WARNING – Risk of burns!**

During long cooking times, the oven door may become very hot.

- ▶ Supervise small children when the oven is in operation.

# 13 Troubleshooting

You can rectify minor faults on your appliance yourself. Read the troubleshooting information before contacting after-sales service. This will avoid unnecessary costs.

**⚠ WARNING – Risk of injury!**

Improper repairs are dangerous.



- ▶ Repairs to the appliance should only be carried out by trained specialist staff.
- ▶ If the appliance is defective, call Customer Service.  
→ "Customer Service", Page 18

**⚠ WARNING – Risk of electric shock!**

Improper repairs are dangerous.

- ▶ Repairs to the appliance should only be carried out by trained specialist staff.
- ▶ Only use genuine spare parts when repairing the appliance.
- ▶ If the power cord of this appliance is damaged, it must be replaced by the manufacturer, the manufacturer's Customer Service or a similarly qualified person in order to prevent any risk.

## 13.1 Malfunctions

Fault	Cause and troubleshooting
The appliance is not working.	The mains plug of the power cord is not plugged in. ▶ Connect the appliance to the power supply. <hr/> The circuit breaker in the fuse box has tripped. ▶ Check the circuit breaker in the fuse box. <hr/> There has been a power cut. ▶ Check whether the lighting in your room or other appliances are working.
The appliance does not switch off fully at the end of a cooking time.	At the end of a cooking time, the appliance stops heating up. The oven light and cooling fan do not switch off. For types of heating with air recirculation, the fan continues to run in the back wall of the cooking compartment. ▶ Turn the function selector to the off position. ✓ The appliance is switched off. ✓ The oven light and the fan in the back wall are switched off. ✓ The cooling fan switches off automatically as soon as the appliance has cooled down.
The time flashes in the display.	There has been a power cut. ▶ Reset the time. → "Setting the time", Page 11
5 R F E lights up in the display and no settings can be made on the appliance.	Childproof lock is activated. ▶ Use  to deactivate childproof lock. → "Childproof lock", Page 11
A message with E appears in the display, e.g. E05-32.	Electronics fault 1. Press  . ▶ If necessary, reset the time on the clock. ✓ If the fault was a one-off, the error message disappears. 2. If the error message appears again, call the after-sales service. State the exact error message and the E no. for your appliance in full. → "Customer Service", Page 18

## 13.2 Replacing the oven light bulb

If the light in the cooking compartment fails, change the oven light bulb.

**Note:** Heat-resistant, 40 - 43-watt, 230 V halogen bulbs are available from the after-sales service or specialist retailers. Only use these bulbs. Hold the new halogen bulbs only with a clean, dry towel. This increases the service life of the bulb.

**⚠ WARNING – Risk of burns!**

The appliance and its parts that can be touched become hot during use.

- ▶ Caution should be exercised here in order to avoid touching heating elements.
- ▶ Young children under 8 years of age must be kept away from the appliance.

**⚠ WARNING – Risk of electric shock!**

When changing the bulb, the bulb socket contacts are live.

- ▶ Before replacing the bulb, ensure that the appliance is switched off in order to prevent a potential electric shock.
- ▶ Also unplug the appliance from the mains or switch off the fuse in the fuse box.

**Requirements**

- The appliance is disconnected from the power supply.
  - The cooking compartment has cooled down.
  - You must have a new halogen lamp to replace the old one.
1. Place a tea towel in the cooking compartment to prevent damage.
  2. Turn the glass cover anti-clockwise.

3. Pull out the halogen bulb without turning it.

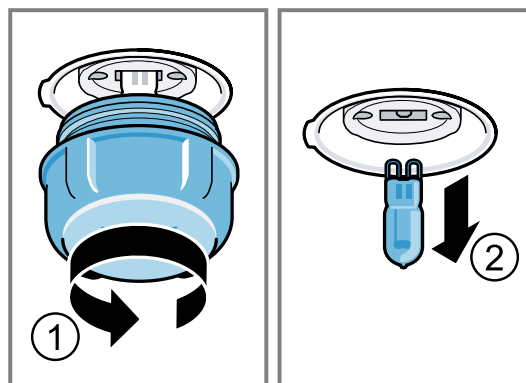

4. Insert the new halogen bulb and press it firmly into the socket. Make sure that the pins are positioned correctly.
5. Depending on the appliance model, the glass cover may have a sealing ring. Attach the sealing ring.
6. Screw in the glass cover.
7. Remove the tea towel from the cooking compartment.
8. Connect the appliance to the power supply.

## 14 Transportation and disposal

You can find out here how to prepare your appliance for transportation. You will also find out how to dispose of old appliances.

### 14.1 Disposing of old appliance

Valuable raw materials can be reused by recycling.

1. Unplug the appliance from the mains.
2. Cut through the power cord.
3. Dispose of the appliance in an environmentally friendly manner.

Information about current disposal methods are available from your specialist dealer or local authority.



This appliance is labelled in accordance with European Directive 2012/19/EU concerning used electrical and electronic appliances (waste electrical and electronic equipment - WEEE). The guideline determines the framework for the return and recycling of used appliances as applicable throughout the EU.

### 14.2 Transporting the appliance

Keep the original appliance packaging. Only transport the appliance in the original packaging. Observe the transport arrows on the packaging.

1. Secure all moving parts in and on the appliance using adhesive tape that can be removed without leaving any traces.
2. Slide all accessories, such as baking trays, into the corresponding slots with thin cardboard at the edges, in order to avoid damaging the appliance.
3. Place cardboard or similar between the front and rear side to prevent knocks against the inside of the door glass.
4. Secure the door and, if available, the top cover to the appliance sides using adhesive tape.

#### If the original packaging is no longer available

1. In order to guarantee sufficient protection against any transport damage, pack the appliance in protective packaging.
2. Always transport the appliance upright.
3. Do not hold the appliance by the door handle or the connections on the rear, as these could be damaged.
4. Do not place any heavy objects on the appliance.

## 15 Customer Service

Function-relevant genuine spare parts according to the corresponding Ecodesign Directive can be obtained from Customer Service for a period of at least 10 years from the date on which your appliance was placed on the market within the European Economic Area. Furthermore, our Customer Service will continue to provide you with other function-relevant and storable

genuine spare parts for up to 15 years from the date on which your appliance was placed on the market. For more information, please contact our Customer Service team.

Detailed information about the warranty period and the warranty conditions in your country is available via the QR code on the enclosed document on service con-

tacts and warranty conditions, from our customer service or on our website.

You can find the contact details for our customer service via the QR code on the enclosed document on service contacts and warranty conditions or on our website. This product contains light sources from energy efficiency class G.

### 15.1 Product number (E-Nr.) and production number (FD)

If you contact Customer Service, you will require the product number (E-Nr.) and the production number (FD), which you can find on the appliance's rating plate.

You will see the rating plate with these numbers if you open the appliance door.

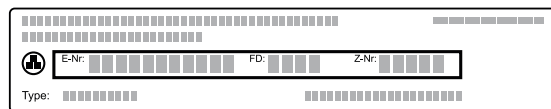

Make a note of your appliance's details and the Customer Service telephone number to find them again quickly.

## 16 How it works

Here, you can find the ideal settings for various types of food as well as the best accessories and cookware. These recommendations are perfectly tailored to your appliance.

Detailed baking tables for your appliance and tips for baking with your appliance can be found in the instructions on the Internet:

[www.bosch-home.com](http://www.bosch-home.com)

### 16.1 Cooking tips

Observe this information when preparing food.

- The temperature and cooking time depend on the amount of food and the recipe. Settings ranges are specified for this reason. Select the lower value first.
- The setting values apply to food placed in the cooking compartment while the cooking compartment is still cold. Do not place accessories into the cooking compartment until it has finished preheating.
- Remove any accessories that are not being used from the cooking compartment.
- Ensure that the accessory slides in the right way round.

### 16.2 Notes on baking

When baking, use the shelf positions indicated.

Baking on one level	Shelf position
Rising pasta/baked goods or tin on the wire rack	2
Flat pasta/baked items or in the baking tray	2-3
Baking on two or more levels	Shelf position
Universal pan	3
Baking tray	1
Baking tins on the wire rack:	Shelf position
First wire rack	3
Second wire rack	1

Baking on three levels	Shelf position
Baking trays	5
Universal pan	3
Baking trays	1

#### Notes

- When baking on several layers, use hot air. Different food that is placed in the oven at the same time will not necessarily be ready at the same time. In such cases, you can remove the cooked food and continue to cook the other baking tray. If necessary, you can change the position and direction of the baking trays.
- Place dishes next to each other or offset one above the other in the cooking chamber. You can cut energy use by cooking different items at the same time.
- For best results, we recommend using dark-coloured metal baking tins.

### 16.3 Notes on roasting and grilling

The setting values are based on the assumption that unstuffed, chilled, ready-to-roast poultry, meat or fish is placed into a cold cooking compartment.

#### ATTENTION

Acidic food may damage the wire rack

- ▶ Do not place acidic food, such as fruit or food with an acidic marinade directly on the wire rack.
- The larger the poultry, meat or fish, the lower the temperature and the longer the cooking time.
- Turn the poultry, meat or fish after approx. 1/2 to 2/3 of the time listed.
- Add a little liquid to the poultry in the cookware. Cover the base of the cookware with approx. 1-2 cm of liquid.
- When you turn poultry, ensure that the breast side or skin side is underneath to begin with.
- Use tongs to turn the pieces of food you are grilling. If you pierce the meat with a fork, the juices will run out and it will become dry.
- Only add salt to steaks once they have been grilled. Salt draws water from the meat.
- Set the cooking time (e.g. 20 + 35): For 500 g meat, calculate 20 minutes plus 35 minutes baking time



























with additional time. For 1.5 kg, the cooking time would therefore be 95 minutes.

- Cooking time range (e.g. 10–15): Your food will be ready within the specified range of time.

#### Information for those allergic to nickel

In rare cases, small amounts of nickel may pass into the food.

## 16.4 List of foods

Food	Accessories/cook-ware	Shelf posi-tion	Type of heating	Temperature in °C/grill setting	Cooking time in mins
Sponge cake, simple	Vienna ring tin/loaf tin	2		160–180	50–60
Sponge cake, simple, 2 levels	Vienna ring tin/loaf tin	3+1		140–160	60–80
Fruit tart or cheesecake with shortcrust pastry base	Springform cake tin, diameter 26 cm	2		160–180	70–90
Sponge flan, 6 eggs	Springform cake tin Ø 28 cm	2		160–170	35–45
Swiss roll	Universal pan	2		170–190 <sup>1</sup>	15–20
Shortcrust tart with moist topping	Universal pan	2		160–180	60–90
Muffins	Muffin tray on wire rack	2		170–190	20–40
Small baked items, with yeast	Universal pan	3		150–170	25–35
Biscuits	Universal pan	3		140–160	20–30
Biscuits, 2 levels	Universal pan + Baking tray	3+1		130–150	25–35
Biscuits, 3 levels	2x Baking tray + Universal pan	5+3+1		130–150	30–40
Bread, 1000 g, in a loaf tin or free-form	Universal pan or Loaf tin	2		200–220	35–50
Pizza, fresh	Universal pan	2		190–210	20–30
Pizza, fresh, thin-crust	Universal pan	2		250–270 <sup>1</sup>	15–25
Quiche, flan	Tart dish or tin	1		210–230	40–50
Bake, savoury, fresh, cooked ingredi-ents	Ovenproof dish	2		200–220	30–60
Chicken, 1.3 kg, unstuffed	Cookware without lid	2		200–220	60–70
Small chicken portions, 250 g each	Cookware without lid	3		220–230	30–35
Goose, unstuffed, 3 kg	Cookware without lid	2		170–190	120–140
Joint of pork without rind, e.g. neck, 1.5 kg	Cookware without lid	1		180–200	140–160
Fillet of beef, medium, 1 kg	Cookware without lid	3		210–220	45–55
Pot-roasted beef, 1.5 kg	Cookware with lid	2		200–220	100–120 <sup>2</sup>
Sirloin, medium, 1.5 kg	Cookware without lid	2		200–220	60–70
Hamburger, 3–4 cm thick	Wire rack	4		3 <sup>3</sup>	25–30 <sup>4</sup>
Leg of lamb, boned, medium, 1.5 kg	Cookware without lid	2		170–190	70–80 <sup>5</sup>
Fish, grilled, whole, 300 g, e.g. trout	Wire rack	2		2	20–25 <sup>4</sup>

<sup>1</sup> Preheat the appliance.

<sup>2</sup> At the start, add liquid to the cookware so that at least 2/3 of the joint is covered in liquid

<sup>3</sup> Turn the dish 2/3 of the way through the cooking time.

<sup>4</sup> Slide the universal pan underneath the wire rack.

<sup>5</sup> Do not turn the food. Cover the base with water.

## 16.5 Yoghurt

You can also use your appliance to make your own yoghurt.

### Making yoghurt

1. Remove the accessories and shelves from the cooking compartment.
2. Heat 1 litre of milk (3.5% fat) to 90 °C on the hob and then leave it to cool down to 40 °C. Only heat UHT milk to 40 °C.

3. Stir 30 g yoghurt into the milk.
4. Pour the mixture into small containers, e.g. small jars with lids.
5. Cover the containers with film, e.g. cling film.
6. Place the containers on the cooking compartment floor.
7. Use the recommended settings when configuring the appliance settings.
8. After making the yoghurt, leave it to cool in the refrigerator.

### Yoghurt

Meal	Accessory/cookware	Shelf position	Type of heating/function	Temperature in °C	Cooking time, minutes
Yoghurt	Cup/jar	Cooking compartment floor	☒	-	4–5 hours

## 16.6 Test dishes

These overviews have been produced for test institutes to facilitate appliance testing in accordance with EN 60350-1.

### Baking

Please take note of the following information if you are baking test dishes.

#### General information

- The setting values apply to food placed in the cooking compartment while the cooking compartment is still cold.
- Observe the notes about preheating in the tables. These setting values assume that the rapid heating function is not being used.
- When baking, use the lower of the listed temperatures to begin with.

#### Shelf positions

Shelf positions for baking on one level:

- Universal pan/baking tray: Shelf position 3
- Baking tins on the wire rack: Shelf position 2

**Note:** Items that are placed in the oven on baking trays or in baking tins/dishes at the same time will not necessarily be ready at the same time.

Shelf positions for baking on two levels:

- Universal pan: Shelf position 3

Baking tray: Shelf position 1

- Baking tins on the wire rack:  
First wire rack: Shelf position 3  
Second wire rack: Shelf position 1

Shelf positions for baking on three levels:

- Baking tray: Shelf position 5  
Universal pan: Shelf position 3  
Baking tray: Shelf position 1

Baking with two springform cake tins:



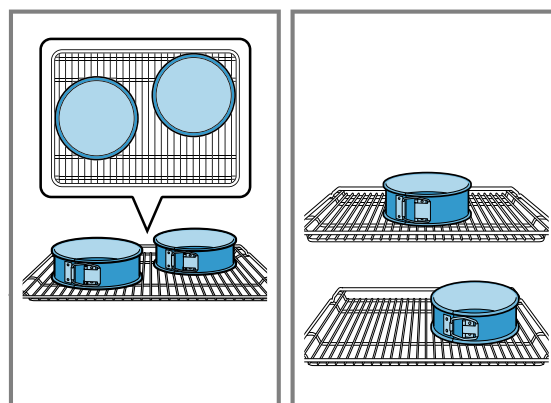



If you can use your appliance to cook on multiple levels, position baking tins either next to one another or offset on different shelves so that they are not directly one above the other in the cooking compartment.



### Baking

Meal	Accessory/cookware	Shelf position	Type of heating/function	Temperature in °C	Cooking time, minutes
Viennese whirls	Universal pan	3	☐	140–150	30–40
Viennese whirls	Universal pan	3	☒	140–150	30–40
Viennese whirls, 2 levels	Universal pan + Baking tray	3+1	☒	140–150 <sup>1</sup>	30–45
Viennese whirls, 3 levels	2x Baking tray	5+3+1	☒	130–140 <sup>1</sup>	40–55

<sup>1</sup> Preheat the appliance for 5 minutes. For appliances with the rapid heating function, do not use this function for preheating.

Meal	Accessory/cookware	Shelf position	Type of heating	Temperature in °C	Cooking time, minutes
	+ Universal pan				
Small cakes	Universal pan	3		150 <sup>1</sup>	25–35
Small cakes	Universal pan	3		150 <sup>1</sup>	25–35
Small cakes, 2 levels	Universal pan	3+1		150 <sup>1</sup>	25–35
	+ Baking tray				
Small cakes, 3 levels	2x Baking tray + Universal pan	5+3+1		140 <sup>1</sup>	35–45
Hot water sponge cake	Springform cake tin, diameter 26 cm	2		160–170 <sup>2</sup>	30–40
Hot water sponge cake	Springform cake tin, diameter 26 cm	2		170	30–40
Hot water sponge cake, 2 levels	Springform cake tin, diameter 26 cm	3+1		150–160 <sup>2</sup>	30–45

## Grilling

Food	Accessories/cookware	Shelf position	Type of heating	Temperature in °C/grill setting	Cooking time in mins
Toasting bread	Wire rack	5		3	0.2–1.5

# 17 Installation instructions

Observe this information when installing the appliance.



← mm →

## 17.1 Important information

This appliance is designed for use up to a maximum height of 4000 metres above sea level. Do not use the door handle to transport or install the appliance. The appliance must be disconnected from the power supply whenever installation work is being carried out.

- Only an appliance which has been correctly installed in accordance with these installation instructions can be used safely. The installer shall be liable for damages incurred as a result of incorrect installation.
- Check the appliance for damage after unpacking it. Do not connect the appliance if it has been damaged in transport.
- Proceed in accordance with the installation sheets for installing accessories.

- Before starting up the appliance, remove any packaging material and adhesive film from the cooking compartment and the door.
- Fitted units must be heat-resistant up to 90 °C, and adjacent unit fronts up to 70 °C.
- Do not install the appliance behind a decorative door or the door of a kitchen unit. Risk of overheating.
- Cut-out work on the units should be carried out before installing the appliance. Remove any shavings. Otherwise, the correct operation of electrical components may be adversely affected.
- To prevent cuts, wear protective gloves. Parts that are accessible during installation may have sharp edges.
- Dimensions of the figures in mm

<sup>1</sup> Preheat the appliance for 5 minutes. For appliances with the rapid heating function, do not use this function for preheating.

<sup>2</sup> Preheat the appliance. For appliances with the rapid heating function, do not use this function for preheating.

## 17.2 Appliance dimensions

You can find the appliance dimensions here.

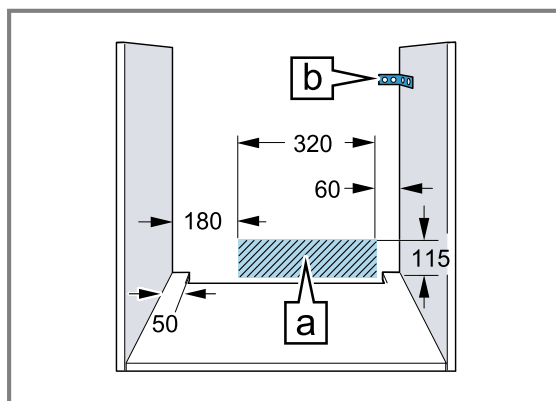
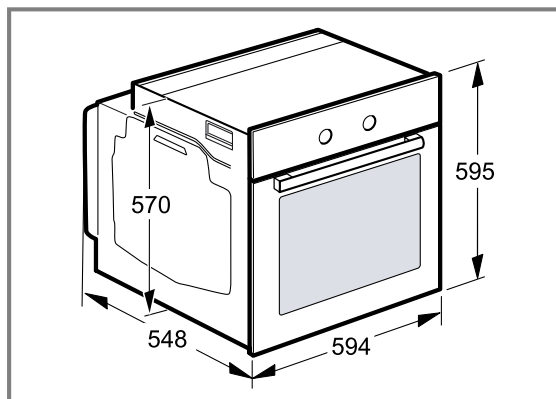

- The mains socket for the appliance must either be located in the hatched area A or outside of the area where the appliance is installed.
- Secure freestanding units to the wall using a standard bracket B.

## 17.3 Installing the appliance below a worktop

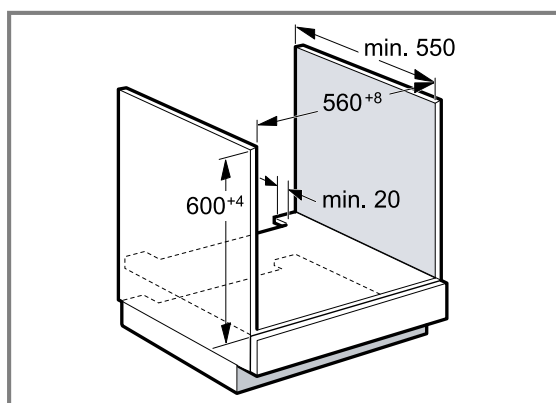

- To ventilate the appliance, the intermediate floor must have a ventilation cut-out.
- Secure the worktop to the built-in unit.
- Observe the installation instructions for the hob.

## 17.4 Installation in a tall unit

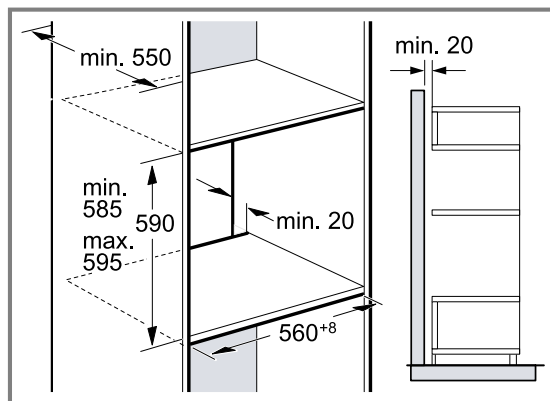

- To ventilate the appliance, the intermediate floor must have a ventilation cut-out.
- If the tall unit has another back panel in addition to the element back panels, remove this.
- Only fit the appliance up to a height which allows accessories to be easily removed.

## 17.5 Corner installation

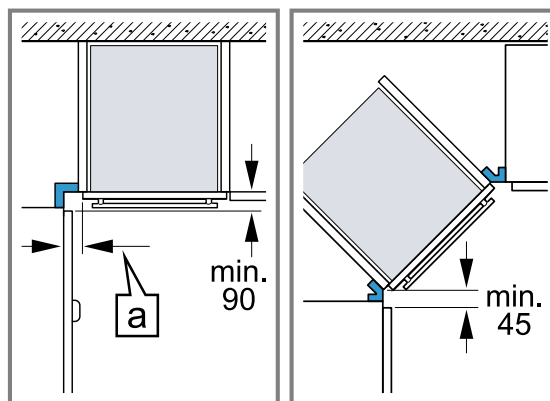

- Observe the minimum dimensions in a corner installation in order to be able to open the cover of the appliance. The dimension  $\text{a}$  depends on the thickness of the furniture panel and the handle.

## 17.6 Electrical connection

In order to safely connect the appliance to the electrical system, follow these instructions.

- Before using the appliance for the first time, you must ensure that your domestic power supply is earthed and complies with the effective safety requirements. The installation of the appliance must be carried out by a qualified technician. Observe the provisions of the local electricity supply company and the general laws. In rare cases, a missing productive conductor or incorrect installation may lead to material damage or serious injuries, such as death or injury caused by electric shock. The manufacturer accepts no responsibility for personal injuries or damage to the appliance due to faulty or incorrect electrical connection.
- The appliance must always be disconnected from the power supply when installation work is being carried out.
- The appliance fulfils the requirements of protection class I and must only be connected to an earthed mains socket.

- The H05 V V-F 3G mains connection cable must be at least 1.5 mm<sup>2</sup>. The yellow-green conductor must be connected first and be slightly longer than the two other wires on the appliance side.
- In accordance with safety regulations, an all-pole separator with at least a 3 mm contact opening must be provided. A separator is not required during connection, which is carried out via an earthed power socket that is easily accessible at all times.
- Contact protection must be guaranteed during installation.
- Determine the phase conductor and neutral conductor (zero conductor) in the socket. The appliance may be damaged if it is not connected correctly.
- Connect the oven in accordance with the specifications on the rating plate.
- Place the appliance in front of the surround unit to connect it. The connection cable must be long enough. Caution: During the installation, ensure that the power cord is not jammed and does not come into contact with hot appliance parts.
- All work on the appliance, including replacing the cabling, must only be carried out by the after-sales service.

### 17.7 Important information about the electrical connection

Note the following information and ensure that:

**⚠ WARNING – Risk of electric shock!**

There is a risk of electric shock if you touch live components.

- ▶ Hold the mains plug with dry hands only.
- ▶ Never pull out the mains plug from the socket while the appliance is in operation.
- ▶ Pull out the power cable directly at the plug and never by pulling the power cable as this may become damaged.
- Fit the mains plug and socket together.
- The mains plug can be accessed at all times.
- The cross section of the cable is sufficient.
- The mains cable is not kinked, crushed, modified or severed.
- If required, the mains cable must only be replaced by a qualified electrician. A replacement mains cable is available from the after-sales service.
- Do not use any multiple plugs or multi-connectors and extension cords.
- The earthing system is correctly installed.
- If using a residual current device, only use one that bears the mark . The presence of this mark is the only way to be sure that it fulfils all the applicable regulations.
- The mains cable does not come into contact with heat sources.

### 17.8 Power cable with protective contact plug

Connect the appliance only to a correctly installed, earthed socket.

If the plug can no longer be accessed following installation, provide a separator in the phases in the fixed elec-

trical installation in accordance with the set-up instructions.

### 17.9 Power cable without protective contact plug

Only allow a licensed professional to connect the appliance.

Provide a separator in the phases in the fixed electrical installation in accordance with the construction instructions. Identify the phase conductor and the neutral conductor (zero conductor) in the socket. An incorrect connection may damage the appliance.

Only connect in accordance with the connection diagram. The information about the voltage can be found on the rating plate. Connect the wires of the mains power cable according to the colour coding:

Cable colour	Cable type
Green-yellow	Earthing cable ⊕
Blue	Neutral conductor (zero)
Brown	Phase conductor (external conductor)

### 17.10 Securing the appliance

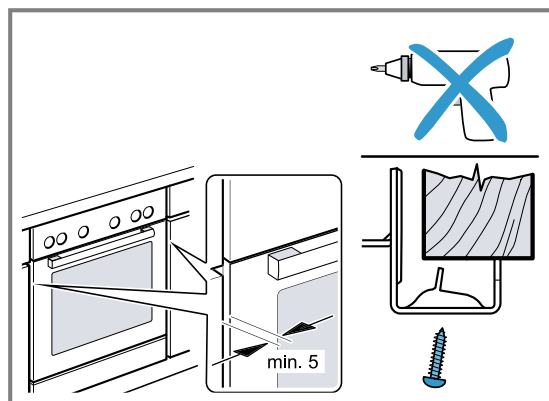

- Slide the appliance in fully and centre it.
  - Screw the appliance into place.
- The gap between the worktop and the appliance must not be closed by additional battens. Do not attach any thermal insulation strips to the side panels of the surround unit.
- To remove:
- Disconnect the appliance from the power supply.
  - Undo the fastening screws.
  - Lift the appliance slightly and pull it out completely.









# Many thanks for choosing a Bosch home appliance!

Register your new appliance now on MyBosch and benefit directly from:

- **Expert advice and tips to make the most of your appliance**
- **Options for warranty extension**
- **Discounts on spare parts and accessories**
- **Digital information for use and all appliance data to hand**
- **Easy access to Bosch Home Appliance Service**

Simple to register, free of charge – including on mobile devices:

**[www.bosch-home.com/welcome](http://www.bosch-home.com/welcome)**



## Need some help? You can find it here.

Expert advice on your Bosch home appliances, help with problems or repairs by professionals from Bosch.

Discover all the different ways Bosch can assist you:

**[www.bosch-home.com/service](http://www.bosch-home.com/service)**

The contact details of all countries are listed in the attached service directory.

### **BSH Hausgeräte GmbH**

Carl-Wery-Straße 34  
81739 München, GERMANY  
[www.bosch-home.com](http://www.bosch-home.com)

A Bosch Company



**9001771649** (060220) REG25

en