



Register your  
new device on  
MyBosch now and  
get free benefits:  
[bosch-home.com/  
welcome](https://bosch-home.com/welcome)



# Washer dryer

**WNA144VLSN**

**[en]** User manual and installation instructions



**You can find additional information and explanations online.  
Scan the QR code on the title page.**



## Table of contents

<b>1 Safety .....</b>	<b>3</b>	<b>11 Laundry .....</b>	<b>24</b>
1.1 General information .....	3	11.1 Preparing the laundry .....	24
1.2 Intended use .....	3	11.2 Care symbols on the care labels .....	24
1.3 Restriction on user group .....	4	<b>12 Detergents and care products .....</b>	<b>25</b>
1.4 Safe installation .....	4	<b>13 Basic operation .....</b>	<b>25</b>
1.5 Safe use .....	6	13.1 Switching on the appliance ..	25
1.6 Safe cleaning and maintenance .....	8	13.2 Setting a programme .....	25
<b>2 Preventing material damage .....</b>	<b>9</b>	13.3 Opening the door .....	25
<b>3 Environmental protection and saving energy .....</b>	<b>10</b>	13.4 Loading laundry .....	26
3.1 Disposing of packaging .....	10	13.5 Inserting the measuring aid ..	26
3.2 Save energy and conserve resources .....	10	13.6 Using the measuring aid .....	26
3.3 Energy saving mode .....	10	13.7 Adding detergent and care product .....	27
<b>4 Installation and connection .....</b>	<b>10</b>	13.8 Starting the programme .....	27
4.1 Unpacking the appliance .....	10	13.9 Soaking laundry .....	27
4.2 Contents of package .....	11	13.10 Adding laundry .....	27
4.3 Requirements for the installation location .....	11	13.11 Cancelling the washing programme .....	28
4.4 Removing the transit bolts .....	12	13.12 Cancelling the drying programme .....	28
4.5 Connecting the appliance .....	13	13.13 Unloading the laundry .....	28
4.6 Aligning the appliance .....	14	13.14 Switching off the appliance .....	28
<b>5 Before using for the first time ..</b>	<b>15</b>	<b>14 Dryness level .....</b>	<b>28</b>
5.1 Starting an empty washing cycle .....	15	14.1 Changing the dryness level ..	28
<b>6 Familiarising yourself with your appliance .....</b>	<b>16</b>	<b>15 Childproof lock .....</b>	<b>29</b>
6.1 Appliance .....	16	15.1 Activating the childproof lock .....	29
6.2 Detergent drawer .....	16	15.2 Deactivating the childproof lock .....	29
6.3 Control panel .....	17	<b>16 Basic settings .....</b>	<b>29</b>
<b>7 Display .....</b>	<b>17</b>	16.1 Overview of the basic settings .....	29
<b>8 Buttons .....</b>	<b>19</b>	16.2 Changing the basic settings .....	29
<b>9 Programmes .....</b>	<b>21</b>		
<b>10 Accessories .....</b>	<b>23</b>		

<b>17 Cleaning and servicing</b> .....	<b>30</b>	19.1 Removing the appliance .....	40
17.1 Cleaning the drum and cleaning fluff .....	30	19.2 Inserting the transit bolts .....	40
17.2 Cleaning the detergent drawer .....	30	19.3 Using the appliance again ....	40
17.3 Cleaning the drain pump .....	31	19.4 Disposing of old appliance ...	41
17.4 Cleaning the rubber gasket ..	33	<b>20 Customer Service</b> .....	<b>41</b>
<b>18 Troubleshooting</b> .....	<b>33</b>	20.1 Product number (E-Nr.) and production number (FD) .....	41
18.1 Emergency release .....	40	<b>21 Consumption values</b> .....	<b>42</b>
<b>19 Transportation, storage and disposal</b> .....	<b>40</b>	<b>22 Technical data</b> .....	<b>43</b>



## 1 Safety

Observe the following safety instructions.

### 1.1 General information

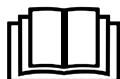

- Read this instruction manual carefully.
- Keep the instruction manual and the product information safe for future reference or for the next owner.
- Do not connect the appliance if it has been damaged in transit.

### 1.2 Intended use

Only use this appliance:

- for washing machine-washable fabrics and hand-washable wool in accordance with the care label.
- with tap water and commercially available detergents and care products suitable for washing machines.
- for drying and freshening up fabrics that are washed with water and suitable for dryers.
- in private households and in enclosed spaces in a domestic environment.
- Up to an altitude of 4000 m above sea level.

### 1.3 Restriction on user group

This appliance may be used by children aged 8 or over and by people who have reduced physical, sensory or mental abilities or inadequate experience and/or knowledge, provided that they are supervised or have been instructed on how to use the appliance safely and have understood the resulting dangers.

Do not let children play with the appliance.

Cleaning and user maintenance must not be performed by children unless they are being supervised.

Keep children under the age of 3 years and pets away from the appliance.

### 1.4 Safe installation

#### **⚠ WARNING – Risk of electric shock!**

Incorrect installation is dangerous.

- ▶ Connect and operate the appliance only in accordance with the specifications on the rating plate.
- ▶ Connect the appliance to a power supply with alternating current only via a properly installed socket with earthing.
- ▶ The protective conductor system of the domestic electrical installation must be properly installed. The installation must have a sufficiently large cross section.
- ▶ When using a residual current circuit breaker, only use a type with the  mark.
- ▶ Never equip the appliance with an external switching device, e.g. a timer or remote control.
- ▶ Never connect the appliance to a circuit that is regularly switched on and off by the energy supplier.
- ▶ When the appliance is installed, the mains plug of the power cord must be freely accessible. If free access is not possible, an isolating switch must be integrated into the permanent electrical installation according to the installation regulations.
- ▶ When installing the appliance, check that the power cable is not trapped or damaged.

If the insulation of the power cord is damaged, this is dangerous.

- ▶ Never let the power cord come into contact with hot appliance parts or heat sources.

- ▶ Never let the power cord come into contact with sharp points or edges.
- ▶ Never kink, crush or modify the power cord.

### **⚠ WARNING – Risk of fire!**

It is dangerous to use an extended power cord and non-approved adapters.

- ▶ Do not use extension cables or multiple socket strips.
- ▶ Only use adapters and power cords approved by the manufacturer.
- ▶ If the power cord is too short and a longer one is not available, please contact an electrician to have the domestic installation adapted.

### **⚠ WARNING – Risk of injury!**

The heavy weight of the appliance may result in injury when lifted.

- ▶ Do not lift the appliance on your own.

### **⚠ WARNING – Risk of suffocation!**

Children may put packaging material over their heads or wrap themselves up in it and suffocate.

- ▶ Keep packaging material away from children.
- ▶ Do not let children play with packaging material.

### **⚠ CAUTION – Risk of injury!**

The appliance may vibrate or move when in use.

- ▶ Place the appliance on a clean, even, solid surface.
  - ▶ Align the appliance using the appliance feet and a spirit level.
- If hoses and power cords have been laid incorrectly, this causes a tripping hazard.
- ▶ Lay hoses and power cords in such a way that there is no risk of tripping.

If the appliance is moved by holding onto protruding components, such as the appliance door, the parts may break off.

- ▶ Do not move the appliance by holding onto protruding parts.

### **⚠ CAUTION – Risk of cutting!**

Touching sharp edges on the appliance may lead to cuts.

- ▶ Do not touch the sharp edges on the appliance.
- ▶ Wear protective gloves when installing and transporting the appliance.

## 1.5 Safe use

### **⚠ WARNING – Risk of electric shock!**

If the appliance or the power cord is damaged, this is dangerous.

- ▶ Never operate a damaged appliance.
- ▶ Never pull on the power cord to unplug the appliance. Always unplug the appliance at the mains.
- ▶ If the appliance or the power cord is damaged, immediately unplug the power cord or switch off the fuse in the fuse box and turn off the water tap.
- ▶ Call customer services. → *Page 41*

An ingress of moisture can cause an electric shock.

- ▶ Only use the appliance in enclosed spaces.
- ▶ Never expose the appliance to intense heat or humidity.
- ▶ Do not use steam- or high-pressure cleaners, hoses or sprays to clean the appliance.

### **⚠ WARNING – Risk of harm to health!**

Children can lock themselves in the appliance, thereby putting their lives at risk.

- ▶ Do not install the appliance behind a door as this may obstruct the appliance door or prevent it from opening.
- ▶ With redundant appliances, unplug the power cord. Then cut through the cord and damage the lock on the appliance door beyond repair so that the appliance door will no longer close.

When spinning larger, waterproof items of laundry, imbalances may arise and lead to injuries.

- ▶ Do not wash and spin larger items of laundry, such as blankets or mattress covers, in the appliance.

### **⚠ WARNING – Risk of suffocation!**

Children may breathe in or swallow small parts, causing them to suffocate.

- ▶ Keep small parts away from children.
- ▶ Do not let children play with small parts.

### **⚠ WARNING – Risk of explosion!**

If there is coal dust or flour in the air around the appliance, this may cause an explosion.

- ▶ Keep the area around the appliance clean during operation.

**⚠ WARNING – Risk of poisoning!**

Detergents and care products may result in poisoning if consumed.

- ▶ If accidentally swallowed, seek medical advice.
- ▶ Keep detergents and care products out of the reach of children.

**⚠ WARNING – Risk of explosion!**

Highly flammable objects such as lighters or matches may ignite during the drying process.

- ▶ Remove all highly flammable objects from any pockets in your laundry before the drying process.

Unwashed laundry that has come into contact with solvents, oil, wax, wax remover, paint, grease or stain remover may ignite when drying is in progress.

- ▶ Do not place laundry in this appliance to be dried if the laundry has not been washed first.
- ▶ Rinse the laundry thoroughly with warm water and detergent before drying it in the machine.
- ▶ Do not use the appliance if industrial chemicals have been used to clean the laundry beforehand.

Laundry that has been pretreated with flammable cleaning agents that contain solvents may cause an explosion in the appliance.

- ▶ Rinse pretreated laundry thoroughly with water before washing.

**⚠ WARNING – Risk of fire!**

If drying is interrupted early, the laundry is not cooled sufficiently and may ignite.

- ▶ Do not interrupt the drying programme early.
- ▶ If drying is interrupted early, remove the laundry immediately and spread it out.

**⚠ CAUTION – Risk of injury!**

The covering plate may break if you stand on or climb onto the appliance.

- ▶ Do not stand on or climb onto the appliance.

The appliance may tip over if you sit on or lean against the open door.

- ▶ Do not sit on or lean against the appliance door.
- ▶ Do not place any objects on the appliance door.

Reaching into the drum while it is still turning may cause hand injuries.

- ▶ Wait for the drum to come to a complete stop before reaching inside.

**⚠ CAUTION – Risk of scalding!**

When you wash at high temperatures, the detergent solution gets hot.

- ▶ Do not touch the hot detergent solution.

**⚠ CAUTION – Risk of chemical burns!**

If the detergent drawer is opened, detergent and care products may spray out from the appliance.

Contact with eyes or skin may cause irritation.

- ▶ Rinse eyes and/or skin thoroughly with clean water if they come into contact with detergents or care products.
- ▶ If accidentally swallowed, seek medical advice.
- ▶ Keep detergents and care products out of the reach of children.

## **1.6 Safe cleaning and maintenance**

**⚠ WARNING – Risk of electric shock!**

Improper repairs are dangerous.

- ▶ Never make any technical modifications to the appliance or its features.
- ▶ Repairs to the appliance should only be carried out by trained specialist staff.
- ▶ Only use genuine spare parts when repairing the appliance.
- ▶ If the power cord of this appliance is damaged, it must be replaced by the manufacturer, the manufacturer's Customer Service or a similarly qualified person in order to prevent any risk.

An ingress of moisture can cause an electric shock.

- ▶ Before cleaning, pull out the mains plug or switch off the fuse in the fuse box.
- ▶ Do not use steam- or high-pressure cleaners, hoses or sprays to clean the appliance.

**⚠ WARNING – Risk of injury!**

The use of non-original spare parts and non-original accessories is dangerous.

- ▶ Only use the manufacturer's original spare parts and original accessories.

**⚠ WARNING – Risk of poisoning!**

Poisonous fumes may be given off if you use cleaning agents that contain solvents.

- ▶ Do not use cleaning agents that contain solvents.

---

## 2 Preventing material damage

**ATTENTION**

The functionality of the appliance may be impaired if you use the wrong quantity of fabric softener, detergent, care product or cleaning agent.

- ▶ Follow the dosage recommendations from the manufacturer.

Exceeding the maximum load capacity impairs the function of the appliance.

- ▶ Observe the maximum load capacity for each programme and do not exceed it.

→ *"Programmes", Page 21*

Foam and foam rubber may deform or melt during the drying process.

- ▶ Do not dry laundry that contains foam or foam rubber.

The appliance is secured for transportation using transit bolts.

Transit bolts which have not been removed may result in material damage and damage to the appliance.

- ▶ Before starting up the appliance, remove the transit bolts completely and keep them in a safe place.
- ▶ Before transport, fit the transit bolts fully in order to prevent damage in transit.

Material damage may be caused if the water inlet hose is connected incorrectly.

- ▶ Tighten the screw connections on the water inlet until they are hand-tight.
- ▶ Connect the water inlet hose directly to the water tap, without any additional connecting elements such as adapters, extensions or valves.
- ▶ Ensure that the inner diameter of the water tap is at least 17 mm.
- ▶ Make sure that the length of the thread on the connection to the water tap is at least 10 mm.

If the water pressure is too high or too low, the appliance may not be able to operate properly.

- ▶ Ensure that the water pressure in the water supply system is at least 100 kPa (1 bar) and max. 1000 kPa (10 bar).
- ▶ If the water pressure exceeds the maximum value specified, a pressure-reducing valve must be installed between the drinking water connection and the hose set of the appliance.
- ▶ Do not connect the appliance to the mixer tap of an unpressurised hot-water boiler.

Modified or damaged water hoses may result in material damage and damage to the appliance.

- ▶ Never kink, crush, modify or cut through water hoses.
- ▶ Only use the water hoses supplied with the appliance or genuine spare hoses.
- ▶ Never re-use water hoses that have been used before.

Operating the appliance using water that is dirty or too hot may lead to material damage and damage to the appliance.

- ▶ Only operate the appliance with cold mains water.

Unsuitable cleaning products may damage the surfaces of the appliance.

- ▶ Do not use harsh or abrasive detergents.
- ▶ Do not use cleaning products with a high alcohol content.
- ▶ Do not use hard scouring pads or cleaning sponges.
- ▶ Clean the appliance with nothing but water and a soft, damp cloth.
- ▶ Remove all detergent residue, spray residue or other residues immediately if they come into contact with the appliance.

---

## **3 Environmental protection and saving energy**

### **3.1 Disposing of packaging**

The packaging materials are environmentally compatible and can be recycled.

- ▶ Sort the individual components by type and dispose of them separately.

### **3.2 Save energy and conserve resources**

If you follow these instructions, your appliance will use less electricity and less water.

- Choose programs with low temperatures and longer wash times and use maximum load capacity.
- Add detergent based on the laundry's degree of soiling. Detergent dosage
- Reduce the washing temperature for lightly and normally soiled laundry.
- Set the maximum spin speed if you want to dry the laundry in the appliance afterwards.
- Wash the laundry without prewash.

### **3.3 Energy saving mode**

If you do not use the appliance for a brief period, it automatically switches to energy-saving mode.

Energy-saving mode ends when you use the appliance again.

---

## **4 Installation and connection**

### **4.1 Unpacking the appliance**

#### **ATTENTION**

Objects remaining in the drum that are not designed for operation with the appliance may cause material damage and damage to the appliance.

- ▶ Remove these objects, along with all supplied accessories, from the drum before starting the appliance.

1. Remove any packaging and protective covers completely from the appliance.  
→ *"Disposing of packaging"*, Page 10
2. Check the appliance for visible damage.
3. Open the door. → *Page 25*
4. Remove any accessories from the drum.
5. Close the door.

## 4.2 Contents of package

After unpacking all parts, check for any damage in transit and completeness of the delivery.

### ATTENTION

If the appliance is operated with incomplete or defective accessories, the appliance may not be able to operate properly, or this may result in material damage or damage to the appliance.

- ▶ Do not operate the appliance with incomplete or defective accessories.
- ▶ Replace the accessories in question before operating the appliance.  
→ *"Accessories"*, Page 23

**Note:** The appliance has undergone a function test at the factory. This may cause water stains in the appliance, which the first wash cycle removes.

The delivery consists of the following:

- Washer dryer
- Accompanying documents
- Transit bolts → *Page 12*
- Cover caps
- Connection adapter
- Water inlet hose → *Page 13*

## 4.3 Requirements for the installation location

### ⚠ WARNING

#### Risk of electric shock!

The appliance contains live parts. Touching live parts is dangerous.

- ▶ Do not operate the appliance without a cover cap.

### ⚠ WARNING

#### Risk of injury!

When using the appliance on a base, the appliance may tip over.

- ▶ Always secure the feet of the appliance to a base using the manufacturer's fixing brackets → *Page 24* before using the appliance for the first time.

### ATTENTION

If residual water in the appliance freezes, this may cause damage to the appliance.

- ▶ Do not install or operate this appliance anywhere that is liable to experience frost or outdoors.

If the appliance is tilted at an angle greater than 40°, residual water may leak out of the appliance and cause material damage.

- ▶ Tilt the appliance carefully.
- ▶ Transport the appliance in an upright position.

---

### Installation location Requirements

---

Base



Secure the appliance with fixing brackets  
→ *Page 24*.

Wooden joist floor

Place the appliance on a water-resistant wooden

### Installation location Requirements

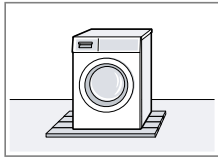

board (minimum thickness of 30 mm) which is screwed tightly to the floor.

#### Kitchen unit

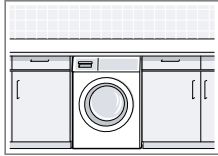

Only install the appliance underneath a continuous worktop that is securely connected to adjacent cabinets. Required niche width: 60 cm.

#### Against a wall

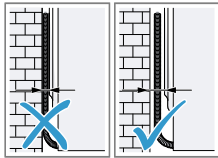

Do not trap the power cord or the hoses between the wall and the appliance.

## 4.4 Removing the transit bolts

The appliance is secured for transportation using transit bolts on the rear of the appliance.

**Note:** Keep the transit bolt screws and the sleeves in a safe place for future transport.

1. Pull the hose out of the holders.

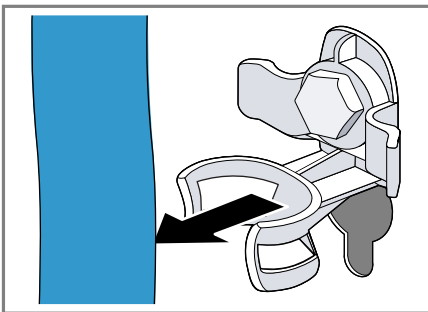

2. Unscrew ① and remove ② all of the screws for the 4 transit bolts using a WAF 13 wrench.

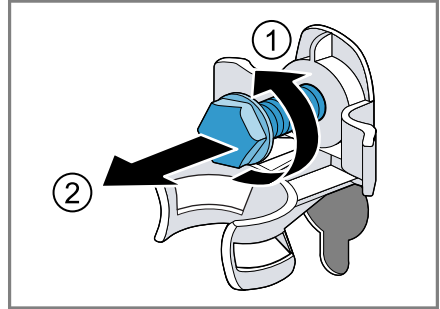

3. Remove the power cable from the holder.

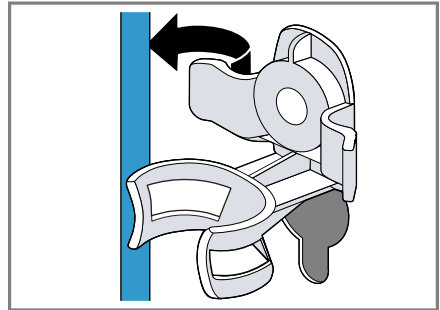

4. Remove the 4 sleeves.

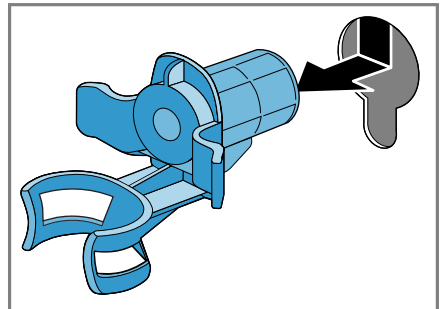

5. Insert the 4 cover caps ① and push them downwards ②.

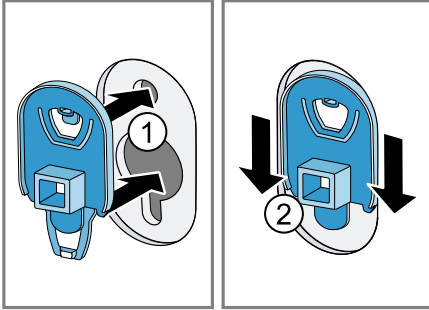

**Note:** To install the transit bolts to transport the appliance, perform these steps again in the reverse order.

## 4.5 Connecting the appliance

### Connecting the water inlet hose

#### ATTENTION

Material damage may be caused if the water inlet hose is connected incorrectly.

- ▶ Tighten the screw connections on the water inlet until they are hand-tight.
1. When connecting to a 21 mm = 1/2" tap, first fit the adapter with a sealing washer.

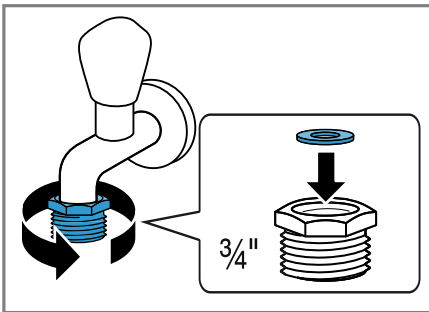

2. Connect the water inlet hose.

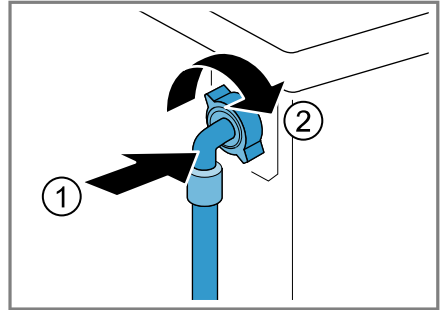

3. Connect the water inlet hose to a tap (26.4 mm = 3/4").

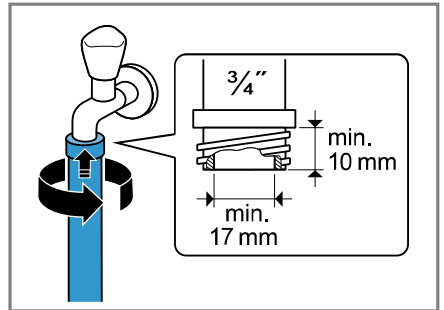

4. Open the water tap carefully and check that the connection points are tight.

### Water outlet connection types

This information is intended to help you to connect this appliance to the water outlet.

#### ATTENTION

When draining, the water outlet hose is subject to water pressure and may come loose from the installed connection point.

- ▶ Secure the water outlet hose against unintentional loosening. In the event of a blocked or covered outlet, accumulated wastewater can flow back into the appliance.
- ▶ Before operating the appliance, ensure that the wastewater drains away quickly and eliminate any blockages.

**Note:** Observe the draining heights. The draining heights are: minimum: 60 cm, maximum: 100 cm

Siphon

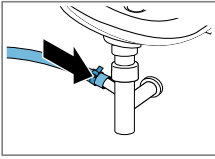

Secure the connection point with a (24–40 mm) hose clamp.

Sink

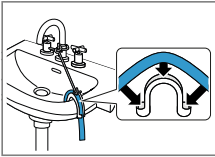

Fix and secure the water outlet hose with an elbow. → "Accessories", Page 24

Plastic pipe with rubber sleeve

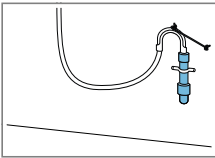

Fix and secure the water outlet hose with an elbow. → "Accessories", Page 24

### Connecting the appliance to the electricity supply

**Note:** Your electrical domestic installation for this appliance must comply with the local legal provisions and safety regulations, and should include a residual current circuit-breaker.

1. Insert the mains plug of the appliance's power cable in a socket nearby.

The connection details of the appliance can be found under Technical data → Page 43.

2. Check the mains plug is inserted properly.

### 4.6 Aligning the appliance

In order to reduce noise and vibration and to prevent the appliance

from moving, align the appliance correctly.

1. Use a WAF 17 wrench to loosen the lock nuts in a clockwise direction.

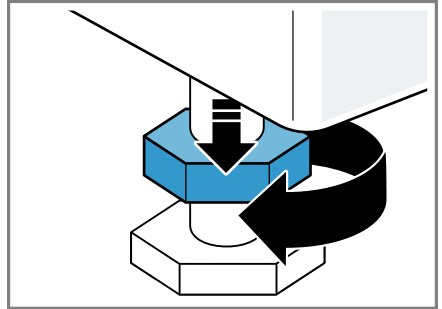

2. To align the appliance, turn the appliance feet. Check that the appliance is level using a spirit level.

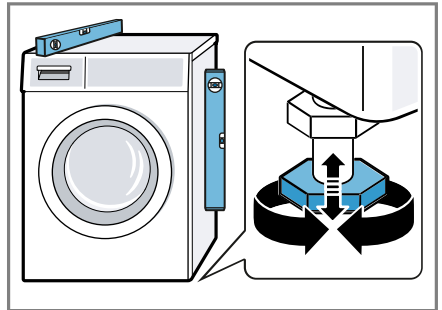

All appliance feet must stand firmly on the ground.

- Use a WAF 17 wrench to tighten the lock nuts against the housing until they are hand-tight.

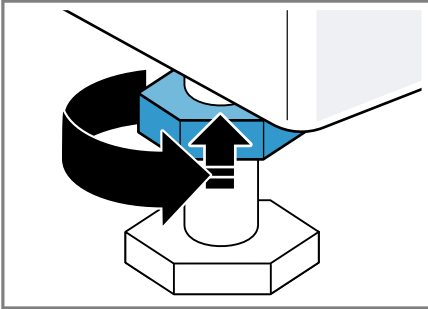

In doing so, hold the foot tight and do not adjust its height.

## 5 Before using for the first time

Prepare the appliance for use.

### 5.1 Starting an empty washing cycle

Your appliance was inspected thoroughly before leaving the factory. To remove any residual water, run the first wash cycle without any laundry.

- Turn the programme selector to **Bomull 90°**.
- Close the door.
- Pull out the detergent drawer.

- Pour approx. 1 litre of tap water into compartment II.

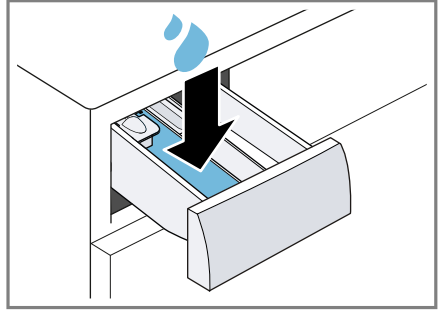

- Add washing powder containing oxygen bleach to compartment II.

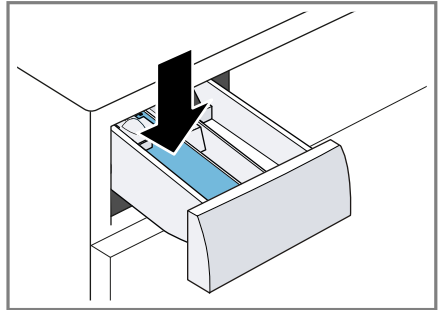

To prevent foaming, use only half of the amount of detergent recommended by the detergent manufacturer for light soiling. Do not use detergent suitable for woollens or delicates.

- Push in the detergent drawer.
- Start the programme. → *Page 27*
- Start the first wash cycle or set the programme selector to **Av** to switch off the appliance. → *"Basic operation", Page 25*

## 6 Familiarising yourself with your appliance

### 6.1 Appliance

You can find an overview of the parts of your appliance here.

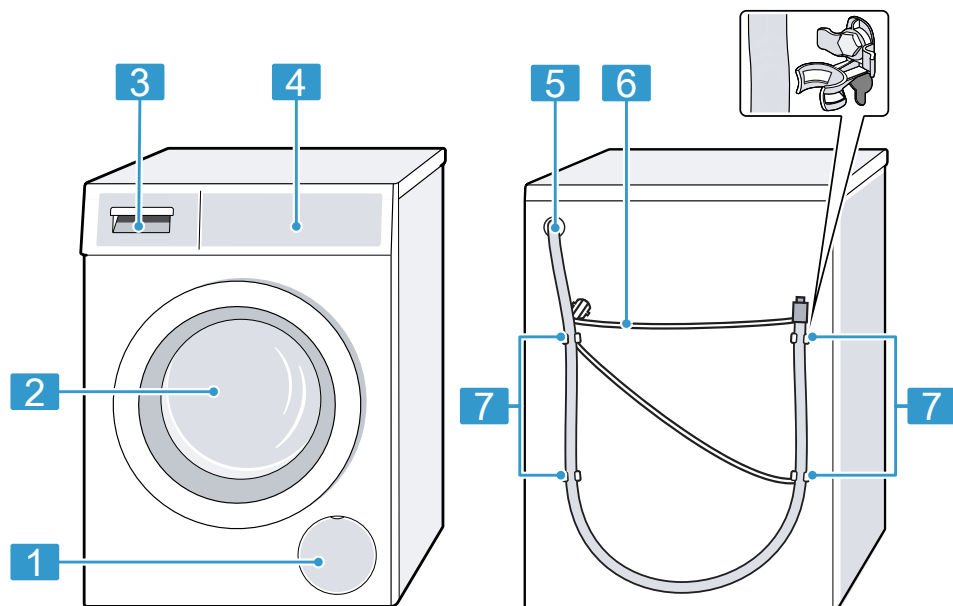

On certain models, specific details such as the colour and shape may differ from those pictured.

- 1** Maintenance flap for the drain pump → *Page 31*
- 2** Door → *Page 25*
- 3** Detergent drawer → *Page 16*

- 4** Control panel → *Page 17*
- 5** Water outlet hose → *Page 13*
- 6** Power cord → *Page 14*
- 7** Transit bolts

### 6.2 Detergent drawer

**Note:** Observe the manufacturer's instructions on the use and dosage of the detergent and care product and

the information in the programme descriptions.

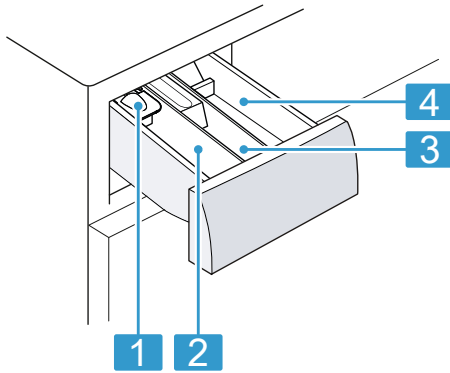

- 
- 1** Measuring aid for liquid detergent → *Page 26*

---

  - 2** Compartment II: Detergent for the main wash

---

  - 3** Compartment ⌘: Fabric softener

---

  - 4** Compartment I: Detergent for prewash

---

### 6.3 Control panel

You can use the control panel to configure all functions of your appliance and to obtain information about the operating status.

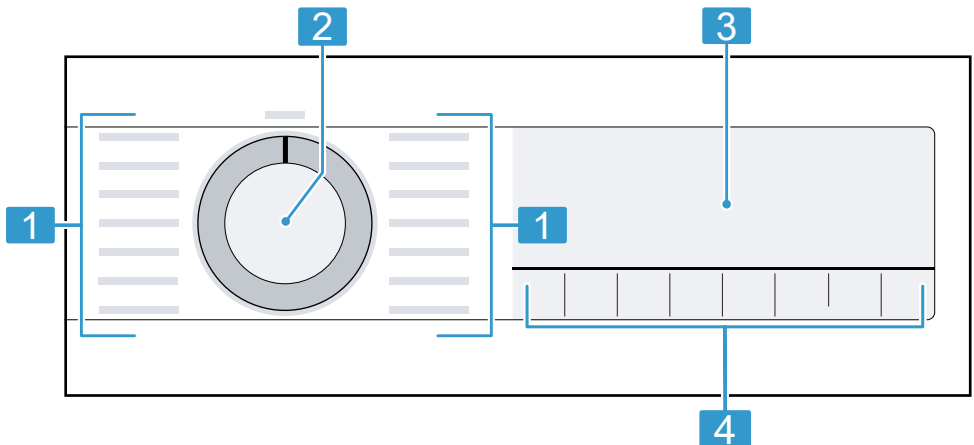

---

**1** Programmes → *Page 21*

---

**2** Programme selector  
→ *Page 25*

---



---

**3** Display → *Page 17*

---

**4** Buttons → *Page 19*

---

## 7 Display

The display shows the current settings, options or relevant information.

## en Display



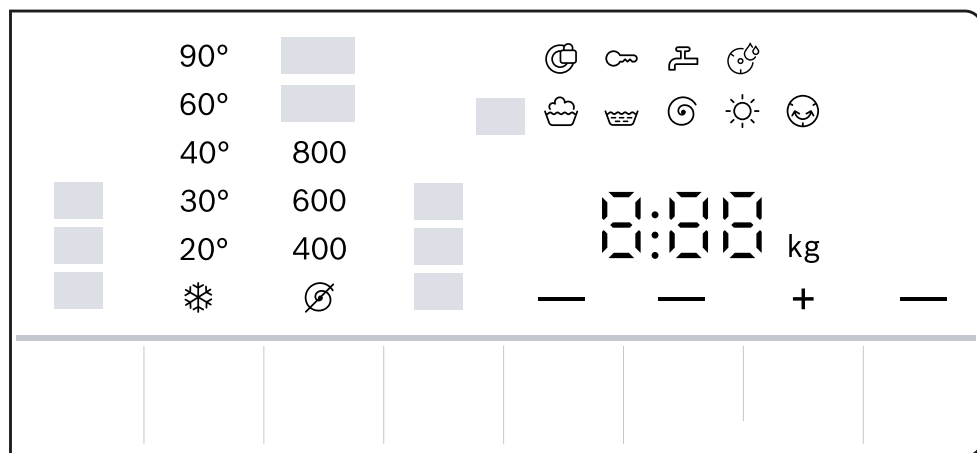







Depending on the programme status, the display shows some information in the 8:88 area, e.g. End.



Example: Display



Display	Description
0:40 <sup>1</sup>	Expected programme duration or programme time remaining in hours and minutes.
+8h <sup>1</sup>	Programme end time → <i>Page 20</i>
5.0 <sup>1</sup>	Recommendation for the maximum load capacity for the selected program in kg.
∅ - 1400	Set spin speed in rpm. → <i>Page 19</i> ∅: No spin cycle, draining only
* - 90	Set temperature in °C. → <i>Page 19</i> * (cold)
— (▷   )	Start, cancel or pause <ul style="list-style-type: none"> <li>▪ Lights up: The programme is running and can be cancelled or paused.</li> <li>▪ Flashes: The programme can be started or continued.</li> </ul>
↓	Programme status: Prewashing
🧺	Programme status: Washing
🧼	Programme status: Rinsing
🌀	Programme status: Spinning
End	Programme status: Programme end
☀️	Programme status: Drying

<sup>1</sup> Example













Display	Description
	Programme status: Crease-reduction function
	<ul style="list-style-type: none"> <li>▪ Lights up: The childproof lock is activated.</li> <li>▪ Flashes: The childproof lock is activated and the appliance has been operated. → <i>Page 29</i></li> </ul>
	The crease-reduction function is activated. → <i>Page 20</i>
	Prewash is activated. → <i>Page 20</i>
Hot	The cooling process cools the laundry for a few minutes while the drum is rotating, in order to avoid damage to the laundry. <b>Note:</b> Do not interrupt the cooling process, and wait for the door lock to open.
	Shortened programme duration is activated. → <i>Page 20</i>
	The dryness level is activated. → <i>Page 28</i>
	The dryness level is activated. → <i>Page 28</i>
	The dryness level is activated. → <i>Page 28</i>
	Flashes: Drum cleaning is required. Run the Bomull 90° programme for cleaning and caring for the drum and the outer tub. → <i>Page 30</i>
	<ul style="list-style-type: none"> <li>▪ Lights up: The door is locked and cannot be opened.</li> <li>▪ Flashes: The door is not closed properly.</li> <li>▪ Off: The door is unlocked and can be opened.</li> </ul>
	<ul style="list-style-type: none"> <li>▪ No water pressure. → <i>Page 34</i></li> <li>▪ The water pressure from the tap is too low.</li> </ul>
E:35 <sup>1</sup>	Error code, error display, signal. → <i>Page 33</i>

## 8 Buttons

The selection of programme settings and options to change these depend on the programme that is set as well as the programme status.

Button	Selection	Description
 (Temperature)	* - 90	Adjust the temperature. Set temperature in °C.
 (Spin Speed)	⊗ - 1400	Adjust the spin speed or deactivate the spin cycle. Set spin speed in rpm.



<sup>1</sup> Example

Button	Selection	Description
		If  is selected, the water is drained and the spin cycle is deactivated. The laundry stays wet inside the drum.
 (Start/Pause)	<ul style="list-style-type: none"> <li>■ Start</li> <li>■ Cancel</li> <li>■ Pause</li> </ul>	Start, cancel or pause the programme.
 (Ready In)	Up to 24 hours	Set the programme end time. The programme duration is already included in the set number of hours. Once the programme has started, the programme duration is displayed.
	Multiple selection	→ <i>"Basic settings", Page 29</i>
 (Speed Perfect)	<ul style="list-style-type: none"> <li>■ Activate</li> <li>■ Deactivate</li> </ul>	Activate or deactivate a shorter programme duration. <b>Note:</b> Energy consumption increases. The washing result is not affected by this.
 (Prewash)	<ul style="list-style-type: none"> <li>■ Activate</li> <li>■ Deactivate</li> </ul>	Activate or deactivate prewash, e.g. for washing heavily soiled laundry. <b>Note:</b> Add the detergent for the prewash in compartment I and the detergent for the main wash in compartment II of the detergent drawer. → <i>"Detergent drawer", Page 16</i>
 (Easy Iron)	<ul style="list-style-type: none"> <li>■ Activate</li> <li>■ Deactivate</li> </ul>	Activate or deactivate the reduced creasing programme. In order to reduce creasing in the laundry, the spin cycle and the spin speed are adapted. <b>Note:</b> The laundry has a higher residual moisture after washing. To reduce creasing, hang up the laundry immediately after washing.
 and  (Childlock)	<ul style="list-style-type: none"> <li>■ Activate</li> <li>■ Deactivate</li> </ul>	→ <i>"Childproof lock", Page 29</i>
	<ul style="list-style-type: none"> <li>■ </li> <li>■ </li> <li>■ </li> </ul>	The dryness level defines how damp or dry the laundry is after the programme ends.



## 9 Programmes

**Note:** The laundry's care labels provide you with additional information about programme selection.

→ "Care symbols on the care labels", Page 24

Programme	Description	Max. load (kg) Washing	Max. load (kg) Drying
Bomull (Cottons)	<p>Wash hard-wearing items made from cotton or linen.</p> <p>Also suitable as a short programme for normally soiled laundry when you activate .</p> <p>Programme setting:</p> <ul style="list-style-type: none"> <li>■ Max. 90 °C</li> <li>■ Max. 1400 rpm</li> </ul>	9.0 5.0 <sup>1</sup>	5.0
Eco 40-60	<p>Wash items made from cotton or linen.</p> <p><b>Note:</b> Fabrics which can be washed from 40 °C  up to 60 °C  as per the care symbol can be washed together.</p> <p>The washing performance corresponds to the best possible washing performance class according to the legal requirements.</p> <p>For this programme, the washing temperature is automatically adjusted depending on the load size, in order to achieve the best possible energy efficiency with the best possible washing result. You cannot change the washing temperature.</p> <p>The maximum spin speed is 1400 rpm.</p>	9.0	5.0
Syntet (Easy Care)	<p>Wash items made from synthetic fabrics.</p> <p>Programme setting:</p> <ul style="list-style-type: none"> <li>■ Max. 60 °C</li> <li>■ Max. 1400 rpm</li> </ul>	4.0	2.5
Mix	<p>Wash items made from cotton, linen or synthetic fabrics.</p> <p>Suitable for lightly soiled laundry.</p> <p>Programme setting:</p> <ul style="list-style-type: none"> <li>■ Max. 60 °C</li> <li>■ Max. 1400 rpm</li> </ul>	4.0	2.5

<sup>1</sup>  activated

Programme	Description	Max. load (kg) Washing	Max. load (kg) Drying
Fintvätt/Silke (Delicate/Silk)	<p>Wash delicate, washable items made from silk, viscose and synthetic fabrics. Use a detergent that is suitable for delicates or silk.</p> <p><b>Note:</b> Wash especially delicate items or items with hooks, eyelets or clips in a mesh laundry bag.</p> <p>Programme setting:</p> <ul style="list-style-type: none"> <li>■ Max. 40 °C</li> <li>■ Max. 800 rpm</li> </ul>	2.0	– <sup>1</sup>
Ylle/Handtvätt  (Wool/Handwash)	<p>Hand- or machine-washable items that are made from wool or contain wool. To prevent the laundry from shrinking, the drum moves the items very gently with long pauses. Use a detergent that is suitable for wool.</p> <p>Programme setting:</p> <ul style="list-style-type: none"> <li>■ Max. 40 °C</li> <li>■ Max. 800 rpm</li> </ul>	2.0	– <sup>1</sup>
Sköljning (Rinse)	<p>Rinse and then spin the laundry, and drain the water.</p> <p>Programme setting: Max. 1400 rpm</p>	–	–
Centrif./Urpumpning (Spin/Drain)	<p>Spin the laundry and drain the water. If you only want to drain the water, activate .</p> <p>The laundry is not spun.</p> <p>Programme setting: Max. 1400 rpm</p>	–	–
Sport	<p>Wash sports and leisure items made from synthetic fabrics. Use a detergent that is suitable for sports items. Do not use fabric softener.</p> <p><b>Tip:</b> Use the Syntet programme to wash heavily soiled laundry.</p> <p>Programme setting:</p> <ul style="list-style-type: none"> <li>■ Max. 40 °C</li> <li>■ Max. 800 rpm</li> </ul>	2.0	2.0

<sup>1</sup> Drying not possible

Programme	Description	Max. load (kg) Wash-	Max. load (kg) Drying
☼ Skontorkning (Gentle Dry)	Dry items made from synthetic fabrics. Gentle programme with low temperatures for delicate fabrics.	- <sup>1</sup>	2.5
☼ Intensivtorkning (Intensive Dry)	Dry items made from cotton or linen. Intensive programme with temperatures for hard-wearing fabrics.	- <sup>1</sup>	5.0
Iron Assist ☼	Reduce creases and airborne odours in suits and fabrics made of cotton and down. <b>Tip:</b> To prevent creasing, remove the laundry immediately after the programme has ended. <b>Notes</b> <ul style="list-style-type: none"> <li>▪ The laundry is not dried or cleaned.</li> <li>▪ If you use the programme often without washing in between, this may cause odours in the appliance.</li> </ul>	- <sup>1</sup>	1.0
☼ My Time Dry	Dry items made from synthetic fabrics. Programme with adjustable programme duration.	- <sup>1</sup>	5.0
Snabb 15'/Tvätt & Tork 60' (Rapid 15'/Wash & Dry 60')	Wash items made from cotton, linen or synthetic fabrics. Short programme for small items of lightly soiled laundry. <b>Note:</b> If you also want to dry the laundry after washing it, press . Programme setting: <ul style="list-style-type: none"> <li>▪ Max. 40 °C</li> <li>▪ Max. 1200 rpm</li> </ul>	2.0	1.0

## 10 Accessories

Use original accessories. These have been made especially for your appliance.

<sup>1</sup> Washing not possible

**Tip:** Some accessories are available in other colours. Contact customer service. → Page 41

	Use	Order number
Water outlet hose extension	Extend the water outlet hose (2.20 m).	11057910
Fixing brackets	Improves the stability of the appliance.	WMZ2200
Elbow	Secure the water outlet hose in place.	00655300
Liquid detergent insert	Measure liquid detergent.	00605740
Platform	Install the appliance at a raised height so that it can be easily loaded and unloaded.	WMZPW20W

## 11 Laundry

### 11.1 Preparing the laundry

#### WARNING

##### Risk of explosion!

Fillings made of polyamide, polyester, polyethylene, polypropylene or polystyrene can leak out of openings in items of laundry, melt during the drying process and cause an explosion in the appliance.

- ▶ Do not dry items of laundry with fillings made of polyamide, polyester, polyethylene, polypropylene or polystyrene in the appliance.

#### ATTENTION

Objects remaining in the laundry may damage the laundry and the drum.

- ▶ Remove all items from any pockets in your laundry before using the appliance.

#### Note

The appliance and fabrics are protected when you prepare your laundry.





- Brush off sand and soil
- Sort the laundry according to colour and textiles and observe the care labels

- Close all zips, hook and loop fasteners, hooks and eyes
- Tie cloth belts, cloth straps and cords together
- Remove curtain fittings and lead strips
- Wash small or particularly delicate items in a mesh washing bag
- Wash large and small items of laundry together
- Wash laundry with fresh stains immediately
- Pretreat laundry with dried stains and wash several times
- Load the laundry unfolded into the drum
- Spin the laundry before drying
- Before loading the drum, any laundry that has been pre-treated with chlorine bleach should be rinsed several times



### 11.2 Care symbols on the care labels

#### Washing care symbols

Symbol	Recommended programme
	Cottons (normal)

Symbol	Recommended programme
	Easy Care (gentle)
	Delicates/Silk for washing by hand (particularly gentle)
	Woollens (hand wash)
	(not suitable for machine-washing)

## Drying care symbols

Symbol	Fabrics
	Items made from cotton and linen, e.g. towels, bed linen, underwear
	Items made from synthetic, blended or delicate fabrics, e.g. functional garments, shirts
	Do not tumble dry items made from silk, nylon, air-impermeable and rubber-coated fabrics, synthetic curtains

## 12 Detergents and care products

You can protect your appliance and your laundry by selecting and using the correct detergents and care products.

The manufacturer's instructions for use and dosage can be found on the packaging.

### Notes

- When using liquid detergents, only use liquid detergents that are self-flowing
- Do not mix different liquid detergents
- Do not mix detergent and fabric softener

- Do not use products that have expired or are highly congealed
- Do not use products containing solvents, caustic agents or volatile substances
- Do not use chlorine bleach
- Do not use dyes regularly as fixing salt can damage stainless steel
- Do not use color-bleaching agents in the appliance

## 13 Basic operation

### 13.1 Switching on the appliance

**Requirement:** The appliance has been correctly installed and connected. → *Page 10*

- ▶ Turn the programme selector to a programme.

### 13.2 Setting a programme

1. Turn the programme selector and set the required programme.  
→ *Page 21*
2. If required, adjust the programme settings. → *Page 19*  
The programme settings are not saved permanently for the programme.

### 13.3 Opening the door

1. Grip under the door handle and pull on the door.

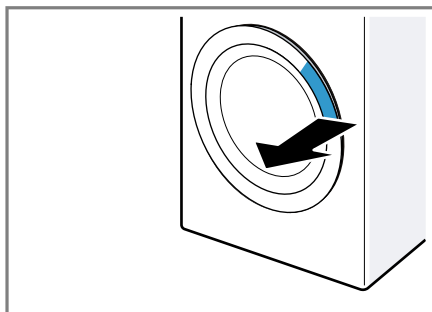

2. Open the door.

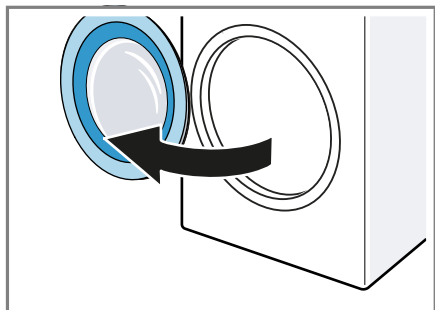

3. Insert the measuring aid.

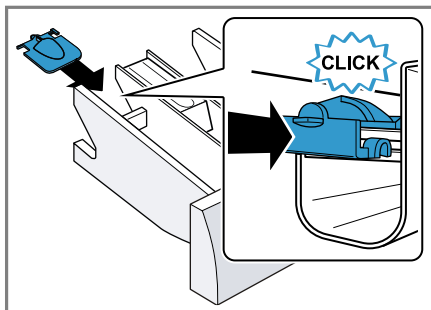

### 13.4 Loading laundry

**Note:** To prevent creasing, note the maximum load for the programmes.  
→ *Page 21*

#### Requirements

- The laundry is prepared and sorted. → *Page 24*
  - The drum is empty.
1. Open the door. → *Page 25*
  2. Place the laundry in the drum.
  3. Close the door.  
Ensure that there is no laundry trapped in the door.

### 13.5 Inserting the measuring aid

1. Pull out the detergent drawer.
2. Press down on the insert and remove the detergent drawer.

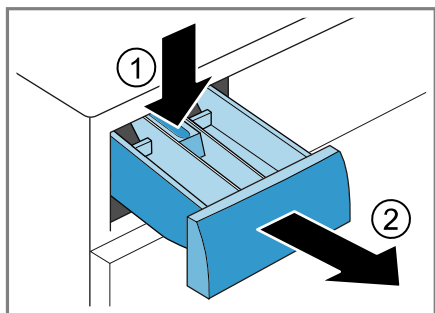

### 13.6 Using the measuring aid

To more easily measure the liquid detergent, you can use a measuring aid in the detergent drawer.

**Note:** Do not use a measuring aid for viscous detergents, for washing powder, or when the prewash or programme end time is activated.

#### Requirements

- The detergent drawer → *Page 16* has been pulled out.
  - The measuring aid is inserted.  
→ *Page 26*
1. Slide the measuring aid forwards.

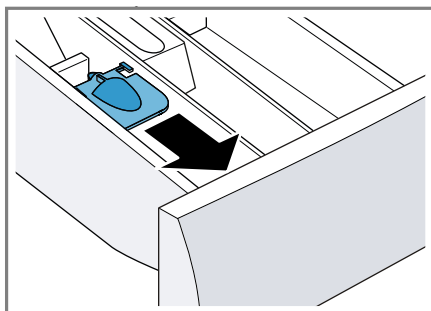

2. Fold the measuring aid down and click it into place.

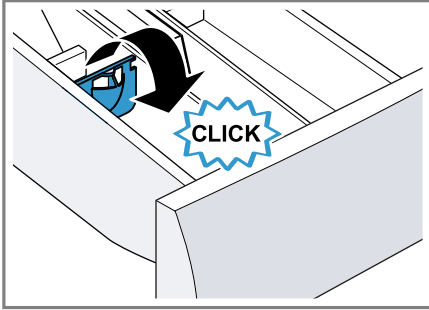

### 13.7 Adding detergent and care product

**Note:** Observe the information about detergents and care products  
→ *Page 25*.

1. Pull out the detergent drawer.
2. If required, use the dosing aid.  
→ *Page 26*
3. Pour in the detergent.  
→ *"Detergent drawer", Page 16*
4. If required, add the care product.
5. Push in the detergent drawer.

### 13.8 Starting the programme

#### Requirements

- A programme is set. → *Page 25*
  - The door is closed.
1. Press **▷|||**.
    - ✓ The drum rotates and load detection takes place. This can take up to 2 minutes, after which water enters the drum.
    - ✓ The display shows the programme duration or the programme end time.
    - ✓ After the programme has ended, the display shows: End.
  2. If the display shows **∅**, the laundry is not spun. The water is pumped out after the rinse cycle.

#### Notes

- If you do not remove the laundry once the programme has ended, the crease-reduction function starts after 15 minutes and takes approx. 30 minutes. The display shows **☺**. Press any button on the display to cancel the crease-reduction programme and to remove the laundry.
- When "Hot" is shown on the display, the appliance cools the laundry. When "Hot" goes out, the laundry has cooled down.

### 13.9 Soaking laundry

**Note:** No additional detergent is required for soaking. The appliance uses the filled detergent for soaking and washing.

#### Requirements

- The laundry is placed in the appliance. → *Page 26*
  - A programme has started.  
→ *Page 27*
1. Press **▷|||** approx. 10 minutes after the programme start. The programme pauses and the laundry can soak.
  2. Press **▷|||** after the required soaking time.

### 13.10 Adding laundry

After the programme starts, you can remove or add laundry depending on the programme status.

1. Press **▷|||**.
  - During the washing cycle, the appliance pauses. → *Page 17*
  - During the drying cycle, the appliance checks whether it is possible to add laundry.

## en Dryness level

**Note:** If you want to add laundry, follow the instructions on the display. → *Page 19*

2. Open the door. → *Page 25*
3. Add or remove laundry.
4. Close the door.
5. Start the programme. → *Page 27*

### 13.11 Cancelling the washing programme

1. Press .
2. Open the door. → *Page 25*  
The appliance door remains locked for safety reasons if the temperature and water levels are high.
  - If the temperature is high, start the **Sköljning** programme.
  - If the water level is high, start the **Centrif.** programme or select a suitable programme for draining. → *Page 21*
3. Remove the laundry. → *Page 28*

### 13.12 Cancelling the drying programme

- ▶ Turn the programme selector to set any other programme.
- ✓ The door lock opens automatically after a cooling period of a few minutes.

### 13.13 Unloading the laundry

1. Open the door. → *Page 25*
2. Remove the laundry from the drum.

### 13.14 Switching off the appliance



1. Turn the programme selector to **Av**.
2. Turn off the tap.
3. Cleaning the rubber gasket.  
→ *Page 33*

**Note:** Leave the appliance door and the detergent drawer open to dry.

---

## 14 Dryness level

In some programmes, a dryness level is predefined. The dryness level defines how dry or damp your laundry is after the programme ends.

Dryness level	Description
	For multi-layered, thick laundry that does not dry readily.
	For normal, single-layered laundry.
	For normal, single-layered laundry. The laundry is still slightly damp after the programme ends. To prevent creasing after drying, iron the laundry or hang it up.

### 14.1 Changing the dryness level

For some programmes, you can change the dryness level so that your laundry will be drier or more damp.

1. Set a washing and drying programme or a drying programme.  
→ *Page 21*
  - ✓ The display shows the specified dryness level.
2. Press  repeatedly until the display shows your required dryness level.

## 15 Childproof lock

Secure your appliance against being operated unintentionally using the controls.

### 15.1 Activating the childproof lock

- ▶ Press on both  $\equiv$  and  $\ominus$  buttons for approx. 3 seconds.
- ✓ The display shows  $\infty$ .
- ✓ The control elements are locked.
- ✓ The childproof lock remains active even after the appliance has been switched off and in the event of a power cut.

### 15.2 Deactivating the childproof lock

**Requirement:** To deactivate the childproof lock, the appliance must be switched on.

- ▶ Press on both  $\equiv$  and  $\ominus$  buttons for approx. three seconds. So that the programme currently running is not cancelled, the programme selector must be set to the initial programme.
- ✓  $\infty$  goes out on the display.

## 16 Basic settings

You can configure the basic settings for your appliance to meet your needs.

### 16.1 Overview of the basic settings

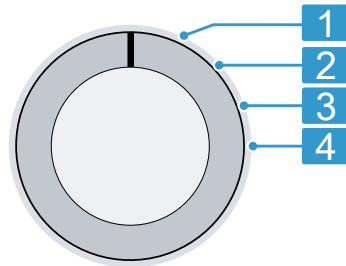

Programme selector with programme positions

- 
- 1** No basic setting.
- 
- 2** Set the volume of the signal at the end of the programme:  
0 (off) to 4 (very loud)
- 
- 3** Set the volume of the signal tone emitted when the buttons are pressed:  
0 (off) to 4 (very loud)
- 
- 4** Activate (On) or deactivate (OFF) the reminder to clean the drum.
- 

### 16.2 Changing the basic settings

1. Set the programme selector to position 1. → *Page 29*
2. Press  $\odot$  and, at the same time, turn the programme selector to position 2.
  - ✓ The display shows the current value.
3. Use the programme selector to select the required basic setting. → *Page 29*
4. To change the value, press  $\ominus$ .
5. To save the changes, switch off the appliance.

## 17 Cleaning and servicing

To keep your appliance working efficiently for a long time, it is important to clean and maintain it carefully.

### 17.1 Cleaning the drum and cleaning fluff

Clean the drum if you have carried out 20 washing cycles at a temperature of 40 °C or lower, if ☼ flashes, or if you have not used the appliance for a prolonged period, but at least once a year. Also clean the drum if you find fluff on the laundry after drying.

#### ⚠ CAUTION Risk of injury!

Permanently washing at low temperatures and a lack of ventilation for the appliance may damage the drum and cause injury.

- ▶ Regularly run a programme for cleaning the drum or wash at temperatures of at least 60 °C.
- ▶ Leave the appliance to dry after every operation with the door open, and leave the detergent drawer to dry.

**Tip:** You can get our tested and approved machine care and machine cleaner products online at <https://www.bosch-home.com/store> or from customer service.

- ▶ Run the **Bomull 90°** programme without laundry but with washing powder that contains oxygen bleach or a cleaning agent for caring for the inside of the appliance.

**Note:** If you only want to clean fluff, you can do this without washing powder or cleaning agent.

### 17.2 Cleaning the detergent drawer

**Note:** Scan the QR code to see an animation of the process.



1. Pull out the detergent drawer.
2. Press down on the insert and remove the detergent drawer.

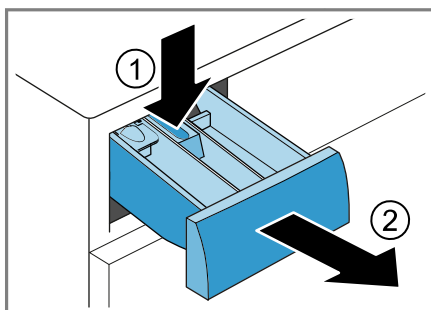

3. Pull out the insert upwards.

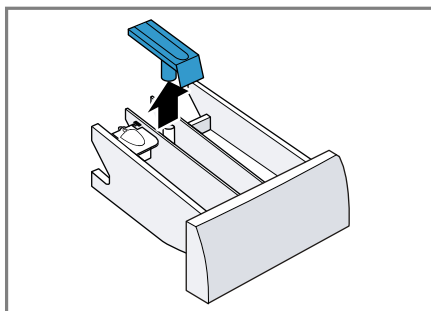

4. Clean the detergent drawer and insert with water and a brush, and then dry them.

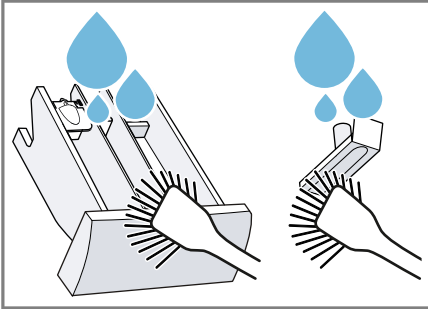

5. Fit the insert and click it into place.

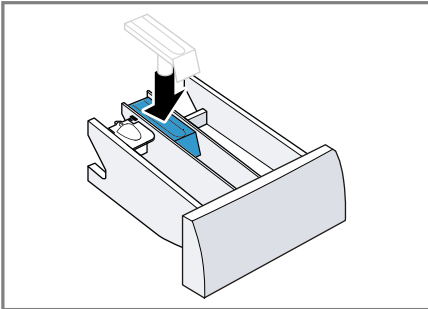

6. Clean the opening for the detergent drawer.

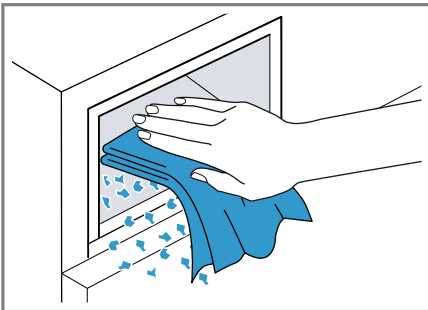

7. Push in the detergent drawer.

### 17.3 Cleaning the drain pump

Clean the drain pump regularly, at least once a year, as well as in the event of faults, e.g. blockages or rattling noises.

**Note:** Scan the QR code to see an animation of the process. Observe the following safety instructions before you start the animation.



### Emptying the drain pump

1. Turn off the tap.
2. Switch off the appliance.  
→ *Page 28*
3. Disconnect the appliance's mains plug from the power supply.
4. Open and remove the maintenance flap.

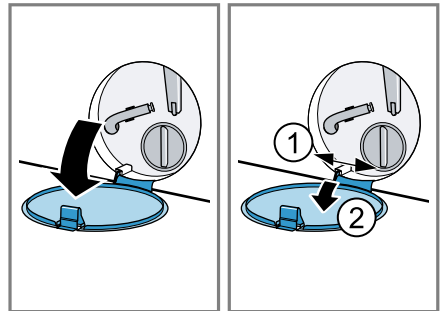

5. Slide a suitable receptacle under the opening for draining the detergent solution.

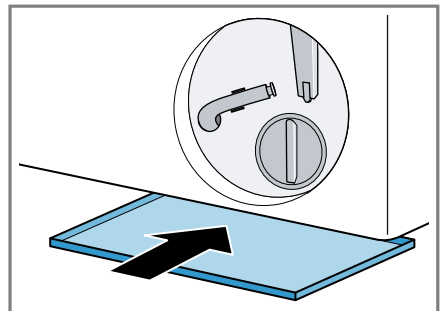

6. Take the drain hose out of the holder.

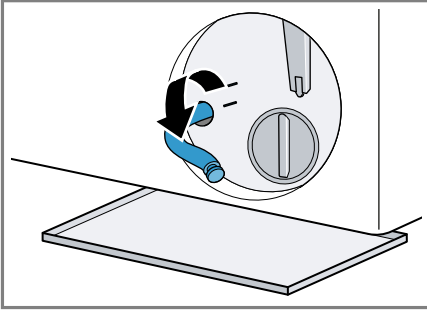

9. Insert the drain hose into the holder.

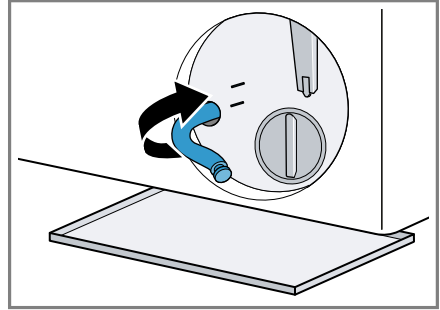

7. **⚠ CAUTION – Risk of scalding!**

When you wash at high temperatures, the detergent solution gets hot.

- ▶ Do not touch the hot detergent solution.

To allow the detergent solution to flow out into the container, remove the sealing cap.

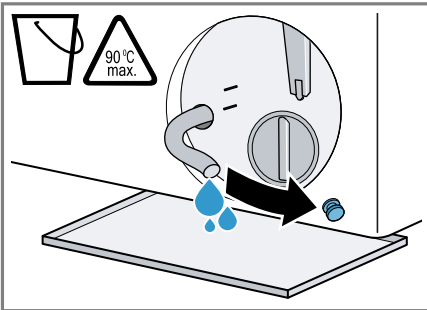

8. Once emptied, press firmly on the locking cap.

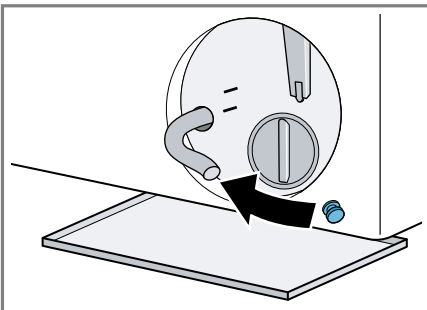

**Cleaning the drain pump**

**Requirement:** The drain pump is empty. → Page 31

1. Since water may remain in the drain pump, unscrew the pump cap carefully.

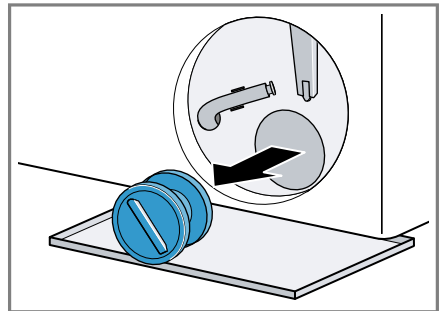

2. Clean the interior, the thread on the pump cap and the pump housing.

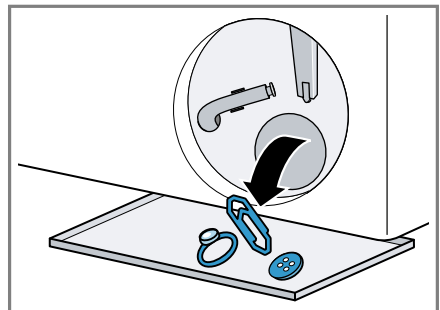

3. Insert the pump cap.

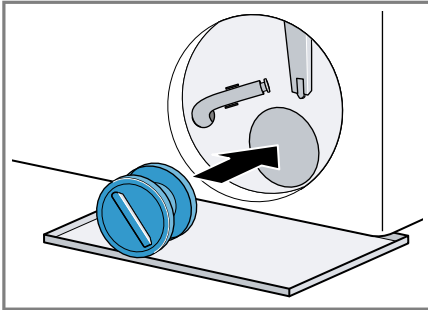

4. Screw the pump cap as far as it will go.

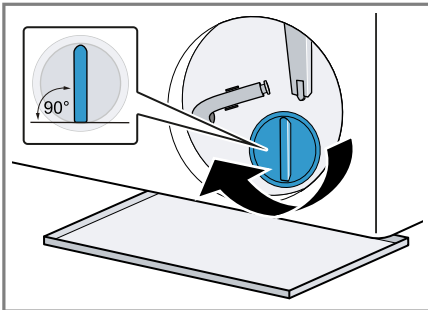

The handle on the pump cap must be in a vertical position.

5. Empty the receptacle with the detergent solution.
6. Insert and close the maintenance flap.

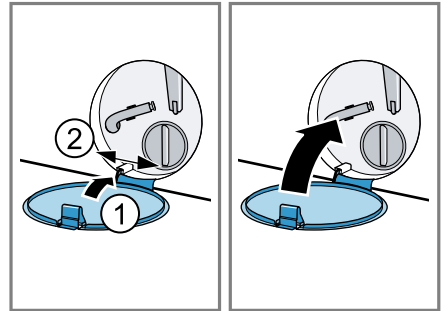

### 17.4 Cleaning the rubber gasket

Clean the rubber gasket regularly.

1. Open the door. → *Page 25*
2. Remove any foreign objects and fluff from the rubber gasket.

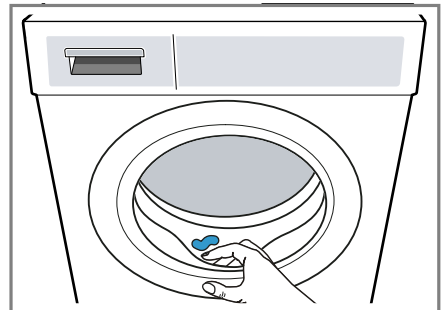

3. Clean the outside and the inside of the rubber gasket with a damp cloth and wipe dry.

## 18 Troubleshooting



You can rectify minor faults on your appliance yourself. Read the troubleshooting information before contacting after-sales service. This will avoid unnecessary costs.



**⚠ WARNING**

**Risk of electric shock!**

Improper repairs are dangerous.

- ▶ Never make any technical modifications to the appliance or its features.
- ▶ Repairs to the appliance should only be carried out by trained specialist staff.
- ▶ Only use genuine spare parts when repairing the appliance.
- ▶ If the power cord of this appliance is damaged, it must be replaced by the manufacturer, the manufacturer's Customer Service or a similarly qualified person in order to prevent any risk.

<b>Fault</b>	<b>Cause and troubleshooting</b>
The display goes out and  flashes.	Energy-saving mode is active ▶ Press  .
E:36 -10 / E:30 -80 / E:18 The detergent solution is not being pumped out.	The water outlet hose is connected too high, is kinked or trapped, or has been extended impermissibly. ▶ Check the installation of the water outlet hose. → <i>Page 13</i>
	Drain pipe or water outlet hose is blocked. ▶ Clean the drain pipe and the water outlet hose.
	The drain pump is blocked or the pump cover is not installed correctly. ▶ Check that the pump cover is installed correctly. → <i>Page 31</i> ▶ Clean the drain pump. → <i>Page 31</i>
	Detergent dosage is too high. ▶ Reduce the amount of detergent for the next washing cycle with the same load.
E:36 -25 -26	Drain pump is blocked. ▶ Clean the drain pump. → <i>Page 31</i>
E:60 -2B / E:32 / H:32	The appliance has interrupted the spin cycle because the laundry is unevenly distributed. ▶ Redistribute the laundry in the drum.
E:30 -10 / H:95 / 	The tap is turned off. ▶ Turn on the tap.
	The water inlet hose is kinked or jammed. ▶ Check the installation of the water inlet hose. → <i>Page 13</i>

Fault	Cause and troubleshooting
E:30 -10 / H:95 / 	<p>The filters in the water inflow are blocked.</p> <ul style="list-style-type: none"> <li>▶ Clean the filters in the water inflow. Scan the QR code to see an animation of the process.</li> </ul>  <hr/> <p>The water pressure is low.</p> <ul style="list-style-type: none"> <li>▶ Check whether the tap has sufficient water pressure.</li> </ul> <hr/> <p>The water level measuring system is defective. With this error message, the appliance starts a draining process.</p> <ol style="list-style-type: none"> <li>1. Wait approx. 5 minutes until the draining process ends.</li> <li>2. Restart the appliance. If required, start the draining process again.</li> <li>3. If the fault persists, call customer service. → <i>Page 41</i></li> </ol>
E:30 -20	<p>Critical malfunction.</p> <ul style="list-style-type: none"> <li>▶ Turn off the water tap.</li> </ul> <p>With this error message, the appliance starts a draining process.</p> <ol style="list-style-type: none"> <li>1. Wait approx. 5 minutes until the draining process ends.</li> <li>2. Restart the appliance. If required, start the draining process again.</li> <li>3. If the fault persists, call customer service. → <i>Page 41</i></li> </ol>
	<p>Detergent dosage is too high.</p> <ul style="list-style-type: none"> <li>▶ Reduce the amount of detergent for the next washing cycle with the same load.</li> </ul> <hr/> <p>Additional water has been added.</p> <ul style="list-style-type: none"> <li>▶ Do not add any extra water to the appliance while it is operating.</li> </ul>

Fault	Cause and troubleshooting
All other error codes.	<p>Malfunction</p> <ol style="list-style-type: none"> <li>1. Restart the appliance.</li> <li>2. If the fault occurs again, disconnect the appliance from the power supply for at least 30 seconds. Unplug the appliance from the mains or switch off the circuit breaker in the fuse box.</li> <li>3. If the fault persists, call customer service. → <i>Page 41</i> Please specify the exact error message when calling. If possible, document the fault with photos and videos.</li> </ol>
Heavy foam build-up.	<p>Detergent dosage is too high.</p> <ul style="list-style-type: none"> <li>▶ Mix one tablespoon of fabric softener with 0.5 litres of water and pour the mixture into compartment II (not for outdoor clothing, sportswear or items stuffed with down).</li> <li>▶ Reduce the amount of detergent for the next washing cycle with the same load.</li> </ul>
🔒 flashes.	<p>The door is not completely closed.</p> <ol style="list-style-type: none"> <li>1. Ensure that there is no laundry trapped in the door.</li> <li>2. Close the door.</li> </ol>
🌀	<p>Drum cleaning is required.</p> <ul style="list-style-type: none"> <li>▶ Clean the drum. → <i>Page 30</i></li> </ul>
"Hot" and the drum rotates.	<p>Not a fault. The cooling process is active. No action required.</p> <p><b>Note:</b> Do not change the programme during the cooling process. The cooling process takes up to 10 minutes.</p>
The programme does not start.	<p>Childproof lock is activated.</p> <ul style="list-style-type: none"> <li>▶ Deactivate the childproof lock. → <i>Page 29</i></li> </ul> <p>🔒 is activated.</p> <ul style="list-style-type: none"> <li>▶ Check whether 🔒 is activated. → <i>Page 20</i></li> </ul>
The programme is paused or has been interrupted, but the door will not open.	<p>The temperature is too high.</p> <ul style="list-style-type: none"> <li>▶ Start the <b>Sköljning</b> programme or wait until the temperature has dropped.</li> </ul> <hr/> <p>Water level is too high.</p> <ul style="list-style-type: none"> <li>▶ Start the <b>Centrif.</b> programme or a suitable draining programme. → <i>Page 21</i></li> </ul>
The door cannot be opened due to a power cut.	<p>The door is locked.</p> <ul style="list-style-type: none"> <li>▶ Open the door using the emergency release. → <i>Page 40</i></li> </ul>

Fault	Cause and troubleshooting
Drum jerks after the programme starts.	Not a fault. An internal motor test is started. No action required.
Drum rotates, water does not flow in.	Not a fault. Load detection is active for up to 2 minutes. No action required.
No water is visible in the drum.	Not a fault. Water is below the visible area. No action required.
The spin cycle runs several times.	Not a fault. The appliance eliminates an imbalance by repeatedly redistributing the laundry. No action required.
The appliance is vibrating, 'wandering' and making loud noises during the spin cycle.	Appliance is not correctly aligned. ▶ Align the appliance. → <i>Page 14</i>
	The appliance feet are not fixed. ▶ Secure the appliance's feet. → <i>Page 14</i>
	Transit bolts have not been removed. ▶ Remove the transit bolts.
High spin speed not reached.	 is activated. ▶ Select a programme that is suitable for the type of fabric. → <i>Page 21</i>
	The appliance is using a reduced spin speed to eliminate an imbalance. No action required.
The programme duration changes during the wash cycle.	Not a fault. The programme sequence is optimised electronically, another rinse cycle is switched on due to heavy foam build-up, or an imbalance is eliminated. No action required.
The drying time is too long.	The ambient temperature is higher than 30 °C. ▶ Ensure that the ambient temperature is below 30 °C.
	The air circulation at the appliance's installation location is insufficient. ▶ Ventilate the appliance's installation location.
	Fluff has accumulated in the drum. ▶ Start the <b>Bomull 90°</b> programme without any laundry or detergent.
Water intake during the drying phase.	Not a fault. The drying phase requires water. No action required.
Spinning during the drying phase.	Not a fault. Thermal spinning is active. No action required.

Fault	Cause and troubleshooting
Whooshing, hissing, whirring or sucking noises.	Not a fault. Water is pumped in, the process fan is active, or detergent solution is pumped out. No action required.
Banging noises, rattling in the drain pump.	A foreign object is in the drain pump. ▶ Clean the drain pump. → <i>Page 31</i>
There are detergent residues on the laundry.	Detergents may contain water-insoluble substances that deposit on the laundry. ▶ Start the <b>Sköljning</b> programme or brush out the laundry after drying.
Fluff on the laundry.	Fluff has accumulated in the drum. ▶ Start the <b>Bomull 90°</b> programme without any laundry or detergent.
The laundry is too wet after the spinning cycle.	<p>A low spin speed is selected. ▶ Start the <b>Centrif.</b> programme. ▶ The next time you run a wash cycle, set a higher spin speed.</p> <hr/> <p>The appliance is using a reduced spin speed to eliminate an imbalance. <b>1.</b> Redistribute the laundry in the drum. <b>2.</b> Start the <b>Centrif.</b> programme.</p> <hr/> <p> is activated. ▶ Set a suitable programme. → <i>Page 21</i></p>
The laundry is too damp.	<p>The selected programme is unsuitable for the type of fabric. ▶ Set a suitable programme for subsequent drying. → <i>Page 21</i></p> <hr/> <p>The load is too large. ▶ Observe the programme's maximum load capacity. → <i>Page 21</i></p> <hr/> <p>After the end of the programme, warm laundry feels damper than it actually is. <b>1.</b> Remove the laundry from the drum as soon as the drying programme has finished. <b>2.</b> Spread the items of laundry for cooling.</p> <hr/> <p>The selected dryness level is unsuitable. ▶ Change the dryness level. → <i>Page 28</i></p> <hr/> <p>The load is too small. ▶ Set a suitable programme for subsequent drying. → <i>Page 21</i></p>

<b>Fault</b>	<b>Cause and troubleshooting</b>
The laundry is too damp.	<p>The laundry has not been spun sufficiently.</p> <ul style="list-style-type: none"> <li>▶ Always select the highest possible spin speed for the washing programme in question.</li> </ul>
Creasing.	<p>The selected programme is unsuitable for the type of fabric.</p> <ul style="list-style-type: none"> <li>▶ Set a suitable programme. → <i>Page 21</i></li> </ul> <hr/> <p>A high spin speed is selected.</p> <ul style="list-style-type: none"> <li>▶ The next time you run a wash cycle, set a lower spin speed.</li> </ul> <hr/> <p>The load is unsuitable.</p> <ul style="list-style-type: none"> <li>▶ Observe the programme's maximum load capacity. → <i>Page 21</i></li> <li>▶ Prepare the laundry. → <i>Page 24</i></li> </ul> <hr/> <p>The laundry lies in the drum for too long after drying.</p> <ol style="list-style-type: none"> <li>1. Remove the laundry from the drum as soon as the drying programme has finished.</li> <li>2. Spread the items of laundry for cooling.</li> </ol> <hr/> <p>Easy Care fabrics have been dried for too long.</p> <ul style="list-style-type: none"> <li>▶ Change the dryness level. → <i>Page 28</i></li> </ul>
Water is leaking out at the water inlet hose.	<p>The water inlet hose is not correctly connected or is damaged.</p> <ul style="list-style-type: none"> <li>▶ Check the installation of the water inlet hose. → <i>Page 10</i></li> </ul> <p>Replace the water inlet hose if it is damaged.</p>
Water is leaking out at the water outlet hose.	<p>The water outlet hose is not connected correctly or is damaged.</p> <ul style="list-style-type: none"> <li>▶ Check the installation of the water outlet hose. → <i>Page 10</i></li> </ul> <p>Replace the water outlet hose if it is damaged.</p>
Water is leaking from below the door.	<p>Dirt on the door or seal causes leaks.</p> <ul style="list-style-type: none"> <li>▶ Clean the door and the seal.</li> </ul>
Detergent or fabric softener drips off the seal and collects on the door or in the seal fold.	<p>There is too much detergent or fabric softener in the detergent drawer.</p> <ul style="list-style-type: none"> <li>▶ When dosing, observe the marking in the detergent drawer. → <i>Page 27</i></li> </ul>
Residual water is present in the compartment ☼.	<p>Insert in compartment ☼ is blocked.</p> <ul style="list-style-type: none"> <li>▶ Clean the detergent drawer. → <i>Page 30</i></li> </ul>

Fault	Cause and troubleshooting
Fabric softener remains in the detergent drawer.	The use of fabric softener is not supported for the selected programme. <ul style="list-style-type: none"> <li>▶ Check whether the use of fabric softener is supported for the selected programme. → <i>Page 21</i></li> </ul>
Odours have formed in the appliance.	Humidity and detergent residue may promote the formation of bacteria. <ul style="list-style-type: none"> <li>▶ Clean the drum. → <i>Page 30</i></li> <li>▶ If you are not using the appliance, leave the door and detergent drawer open so that residual water can evaporate.</li> </ul>

## 18.1 Emergency release

### Releasing the door

**Requirement:** The drain pump is empty. → *Page 31*

1. **ATTENTION** – Escaping water may cause material damage.
  - ▶ Do not open the door if you can see water through the glass.

Pull the emergency unlock downwards with a tool and release.

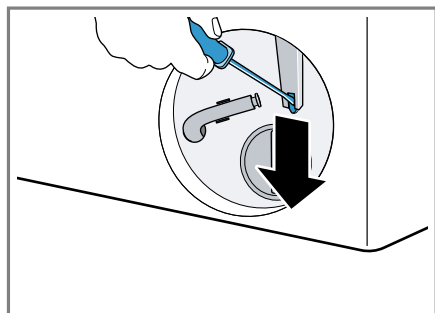

- ✓ The door lock is released.
2. Insert the maintenance flap and lock it into place.
  3. Close the service flap.

## 19 Transportation, storage and disposal

### 19.1 Removing the appliance

1. Turn off the tap.

2. Empty the water inlet hose.
3. Switch off the appliance. → *Page 28*
4. Unplug the appliance's mains plug.
5. Drain the water. → *"Cleaning the drain pump", Page 31*
6. Detach the hoses.

### 19.2 Inserting the transit bolts

Secure the appliance before transportation using transit bolts in order to prevent transport damage.

1. Use a screwdriver to remove the 4 cover caps.

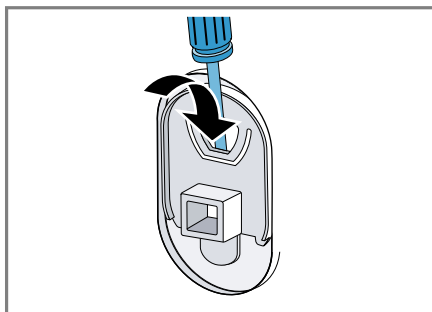

- Keep the cover caps.
2. Insert the 4 transit bolts.

### 19.3 Using the appliance again

- ▶ For further information, see Installation and connection → *Page 10*

and Starting an empty washing cycle → *Page 15*.

## 19.4 Disposing of old appliance

Valuable raw materials can be re-used by recycling.

### **WARNING**

#### **Risk of harm to health!**

Children can lock themselves in the appliance, thereby putting their lives at risk.

- ▶ Do not install the appliance behind a door as this may obstruct the appliance door or prevent it from opening.
- ▶ With redundant appliances, unplug the power cord. Then cut through the cord and damage the lock on the appliance door beyond repair so that the appliance door will no longer close.

1. Unplug the appliance from the mains.
2. Cut through the power cord.
3. Dispose of the appliance in an environmentally friendly manner. Information about current disposal methods are available from your specialist dealer or local authority.



This appliance is labelled in accordance with European Directive 2012/19/EU concerning used electrical and electronic appliances (waste electrical and electronic equipment - WEEE). The guideline determines the framework for the return and recycling of used appliances as applicable throughout the EU.

## 20 Customer Service

Function-relevant genuine spare parts according to the corresponding Eco-design Order can be obtained from Customer Service for a period of at least 10 years from the date on which your appliance was placed on the market within the European Economic Area.

**Note:** Under the terms of the manufacturer's warranty the use of Customer Service is free of charge.

Detailed information about the warranty period and the warranty conditions in your country is available via the QR code on the enclosed document on service contacts and warranty conditions, from our customer service or on our website.

If you contact Customer Service, you will require the product number (E-Nr.) and the production number (FD) of your appliance.

You can find the contact details for our customer service via the QR code on the enclosed document on service contacts and warranty conditions or on our website.

### 20.1 Product number (E-Nr.) and production number (FD)

You can find the product number (E-Nr.) and the production number (FD) on the appliance's rating plate.

Depending on the model, the rating plate is located:

- On the inside of the door.
- On the inside of the maintenance flap.
- On the rear of the appliance.

Make a note of your appliance's details and the Customer Service tele-

phone number to find them again quickly.

## 21 Consumption values

The following information is provided in accordance with the EU Ecodesign Regulation. The values specified for programmes other than **Eco 40-60** are only given as a guide and were determined in accordance with the applicable standards EN60456 and EN62512.

Programme	Load (kg)	Programme duration (h:min) <sup>1</sup>	Energy consumption (kWh/cycle) <sup>1</sup>	Water consumption (l/cycle) <sup>1</sup>	Maximum temperature (°C) 5 mins <sup>1</sup>	Spin speed (rpm) <sup>1</sup>	Residual moisture (%) <sup>1</sup>
Eco 40-60 <sup>2</sup>	9.0	3:44	1.120	63.0	43	1400	53.00
Eco 40-60 <sup>2</sup>	4.5	2:49	0.440	44.0	31	1400	53.00
Eco 40-60 <sup>2</sup>	2.5	2:34	0.180	33	23	1400	53.00
Eco 40-60 + ☀ + 🗑 <sup>2</sup>	5.0	7:30	3.900	90.0	37	-	-0.1
Eco 40-60 + ☀ + 🗑 <sup>2</sup>	2.5	5:10	2.200	50.0	34	-	-0.1
Bomull 20 °C	9.0	3:55	0.400	95.0	22	1400	50.00
Bomull 40 °C	9.0	3:55	1.200	95.0	41	1400	50.00
Bomull 60 °C	9.0	3:40	1.500	95.0	49	1400	50.00
Bomull 40 °C + ↓	9.0	4:14	1.300	105.0	41	1400	50.00
Syntet 40 °C	4.0	2:35	0.800	70.0	42	1400	30.00
Mix 40 °C	4.0	1:10	0.650	48.0	39	1400	55.00
Ylle/Handtvätt 🌀 30 °C	2.0	0:41	0.200	42.0	23	800	30.00

<sup>1</sup> Due to the influence of water pressure, hardness and inlet temperature, ambient temperature, type, amount and soiling of laundry, detergent used, fluctuations in the power supply and the selected additional functions, the actual values may deviate from the stated values.

<sup>2</sup> Test programme in accordance with the EU Ecodesign Directive and the EU Energy Labelling Regulation with cold water (15 °C).

## 22 Technical data

Appliance height	84.8 cm
Appliance width	59.8 cm
Appliance depth	59.0 cm
Appliance depth with door closed	64.9 cm
Appliance depth with door open	106.3 cm
Weight	71.6 kg
Maximum load	9.0 kg
Mains voltage	220-240 V, 50 Hz
⇒ Minimum installation protection	10 A
Nominal power	1900-2300 W
Power consumption	<ul style="list-style-type: none"> <li>▪ Off mode: 0.50 W</li> <li>▪ Left-on mode: 0.50 W</li> </ul>
Water pressure	<ul style="list-style-type: none"> <li>▪ Minimum: 100 kPa (1 bar)</li> <li>▪ Maximum: 1000 kPa (10 bar)</li> </ul>
Length of the water inlet hose	150 cm
Length of the water outlet hose	150 cm
Length of the power cord	210 cm

More information about your model can be found online at <https://eprel.ec.europa.eu/qr/934865><sup>1</sup>. This web address is linked to the official EU EPREL product database.

<sup>1</sup> Only applies to countries in the European Economic Area



# Thank you for buying a Bosch Home Appliance!

Register your new device on MyBosch now and profit directly from:

- **Expert tips & tricks for your appliance**
- **Warranty extension options**
- **Discounts for accessories & spare-parts**
- **Digital manual and all appliance data at hand**
- **Easy access to Bosch Home Appliances Service**

Free and easy registration – also on mobile phones:

**[www.bosch-home.com/welcome](http://www.bosch-home.com/welcome)**



## Looking for help? You'll find it here.

Expert advice for your Bosch home appliances, help with problems or a repair from Bosch experts.

Find out everything about the many ways Bosch can support you:

**[www.bosch-home.com/service](http://www.bosch-home.com/service)**

Contact data of all countries are listed in the attached service directory.

### **BSH Hausgeräte GmbH**

Carl-Wery-Straße 34  
81739 München, GERMANY  
[www.bosch-home.com](http://www.bosch-home.com)

A Bosch Company

Valid within Great Britain:  
Imported to Great Britain by  
BSH Home Appliances Ltd.  
Grand Union House  
Old Wolverton Road  
Wolverton, Milton Keynes  
MK12 5PT  
United Kingdom



**9001685863** (050722)

en