



Register your
new device on
MyBosch now and
get free benefits:
**[bosch-home.com/
welcome](https://bosch-home.com/welcome)**



Oven

HR..79...B

[en] User manual and installation instructions

Further information and explanations are available online:



Table of contents

INFORMATION FOR USE

1	Safety.....	2
2	Preventing material damage	5
3	Environmental protection and saving energy	6
4	Familiarising yourself with your appliance	7
5	Accessories.....	9
6	Before using for the first time	11
7	Basic operation	11
8	Rapid heating	12
9	Steam assistance.....	12
10	Time-setting options.....	13
11	Programme.....	14
12	Childproof lock.....	18
13	Sabbath mode	18
14	Basic settings.....	19
15	Home Connect	19
16	Cleaning and servicing.....	20
17	Pyrolytic self-cleaning	22
18	Cleaning aid.....	23
19	Shelf supports.....	24
20	Appliance door.....	25
21	Troubleshooting.....	27
22	Disposal.....	29
23	Declaration of Conformity	29
24	Customer Service.....	30
25	How it works.....	30
26	INSTALLATION INSTRUCTIONS	35
26.1	General installation instructions.....	35

1 Safety

Observe the following safety instructions.

1.1 General information

- Read this instruction manual carefully.
- Keep the instruction manual and the product information safe for future reference or for the next owner.
- Do not connect the appliance if it has been damaged in transit.

1.2 Intended use

This appliance is designed only to be built into kitchen units. Read the special installation instructions.

Only a licensed professional may connect appliances without plugs. Damage caused by incorrect connection is not covered under the warranty.

Only use this appliance:

- To prepare meals and drinks.
- in private households and in enclosed spaces in a domestic environment.
- up to an altitude of max. 4000 m above sea level.

Do not use the appliance:

- with an external timer or a remote control.

1.3 Restriction on user group

This appliance may be used by children aged 8 or over and by people who have reduced physical, sensory or mental abilities or inadequate experience and/or knowledge, provided that they are supervised or have been instructed on how to use the appliance safely and have understood the resulting dangers.

Do not let children play with the appliance.

Children must not perform cleaning or user maintenance unless they are at least 15 years old and are being supervised.

Keep children under the age of 8 years away from the appliance and power cable.

1.4 Safe use

Always place accessories in the cooking compartment the right way round.

→ "Accessories", Page 9

⚠ WARNING – Risk of fire!

Combustible objects that are left in the cooking compartment may catch fire.

- ▶ Never store combustible objects in the cooking compartment.
- ▶ If smoke is emitted, the appliance must be switched off or the plug must be pulled out and the door must be held closed in order to stifle any flames.

Loose food remnants, fat and meat juices may catch fire.

- ▶ Before using the appliance, remove the worst of the food residues and remnants from the cooking compartment, heating elements and accessories.

Opening the appliance door creates a draught. Greaseproof paper may come into contact with the heating element and catch fire.

- ▶ Never place greaseproof paper loosely over accessories when preheating the appliance and while cooking.
- ▶ Always cut greaseproof paper to size and use a plate or baking tin to hold it down.

⚠ WARNING – Risk of burns!

The appliance and its parts that can be touched become hot during use.

- ▶ Caution should be exercised here in order to avoid touching heating elements.
- ▶ Young children under 8 years of age must be kept away from the appliance.

Accessories and cookware get very hot.

- ▶ Always use oven gloves to remove accessories or cookware from the cooking compartment.

When the cooking compartment is hot, any alcoholic vapours inside may catch fire. The appliance door may spring open. Hot steam and jets of flame may escape.

- ▶ Only use small quantities of drinks with a high alcohol content in food.
- ▶ Do not heat spirits ($\geq 15\%$ vol.) when undiluted (e.g. for marinating or pouring over food).
- ▶ Open the appliance door carefully.

⚠ WARNING – Risk of scalding!

The accessible parts of the appliance become hot during operation.

- ▶ Never touch these hot parts.
- ▶ Keep children at a safe distance.

Hot steam may escape when you open the appliance door. Steam may not be visible, depending on the temperature.

- ▶ Open the appliance door carefully.
- ▶ Keep children at a safe distance.

If there is water in the cooking compartment when it is hot, this may create hot steam.

- ▶ Never pour water into the cooking compartment when the cooking compartment is hot.

⚠ WARNING – Risk of injury!

Scratched glass in the appliance door may develop into a crack.

- ▶ Do not use any harsh or abrasive cleaners or sharp metal scrapers to clean the glass on the oven door, as they may scratch the surface.

The appliance and its parts that can be touched may have sharp edges.

- ▶ Take care when handling and cleaning them.
- ▶ If possible, wear protective gloves.

The hinges on the appliance door move when the door is opened and closed, which could trap your fingers.

- ▶ Keep your hands away from the hinges.

Components inside the appliance door may have sharp edges.

- ▶ Wear protective gloves.

Alcoholic vapours may catch fire in the hot cooking compartment, and the appliance door may spring open and may fall off. The door panels may shatter and fragment.

→ "Preventing material damage", Page 5

- ▶ Only use small quantities of drinks with a high alcohol content in food.
- ▶ Do not heat spirits ($\geq 15\%$ vol.) when undiluted (e.g. for marinating or pouring over food).
- ▶ Open the appliance door carefully.

⚠ WARNING – Risk of electric shock!

Incorrect repairs are dangerous.

- ▶ Repairs to the appliance should only be carried out by trained specialist staff.
- ▶ Only use genuine spare parts when repairing the appliance.
- ▶ If the power cord of this appliance is damaged, it must be replaced by trained specialist staff.

If the insulation of the power cord is damaged, this is dangerous.

- ▶ Never let the power cord come into contact with hot appliance parts or heat sources.
- ▶ Never let the power cord come into contact with sharp points or edges.
- ▶ Never kink, crush or modify the power cord.

An ingress of moisture can cause an electric shock.

- ▶ Do not use steam- or high-pressure cleaners to clean the appliance.

If the appliance or the power cord is damaged, this is dangerous.

- ▶ Never operate a damaged appliance.
- ▶ Never pull on the power cord to unplug the appliance. Always unplug the appliance at the mains.
- ▶ If the appliance or the power cord is damaged, immediately unplug the power cord or switch off the fuse in the fuse box.
- ▶ Call customer services. → *Page 30*

⚠ WARNING – Risk of suffocation!

Children may put packaging material over their heads or wrap themselves up in it and suffocate.

- ▶ Keep packaging material away from children.
- ▶ Do not let children play with packaging material.

Children may breathe in or swallow small parts, causing them to suffocate.

- ▶ Keep small parts away from children.
- ▶ Do not let children play with small parts.

1.5 Halogen bulb

⚠ WARNING – Risk of burns!

The bulbs in the cooking compartment get very hot. There is still a risk of burning for some time after they have been switched off.

- ▶ Do not touch the glass cover.
- ▶ Avoid contact with your skin when cleaning.

⚠ WARNING – Risk of electric shock!

When changing the bulb, the bulb socket contacts are live.

- ▶ Before replacing the bulb, ensure that the appliance is switched off in order to prevent a potential electric shock.
- ▶ Also unplug the appliance from the mains or switch off the circuit breaker in the fuse box.

1.6 Steam assistance

Follow these instructions when using steam assistance.

⚠ WARNING – Risk of burns!

While the appliance is in operation, the water bowl reaches high temperatures.

- ▶ Never remove the water bowl while the appliance is in operation.
- ▶ Only remove the water bowl once it has cooled down.

⚠ WARNING – Risk of fire!

Due to the hot surfaces, vapours from flammable liquids may catch fire in the cooking compartment and cause an explosion. The appliance door may spring open. Hot steam and jets of flame may escape.

- ▶ Do not fill the water bowl with any flammable fluids, e.g. alcoholic drinks.
- ▶ Fill the water bowl with water only.

1.7 Cleaning function

⚠ WARNING – Risk of fire!

Loose food remnants, fat and meat juices may catch fire when the cleaning function is in progress.

- ▶ Before you start the cleaning function, always remove coarse dirt from the cooking compartment.
- ▶ Never clean accessories at the same time. The outside of the appliance gets very hot when the cleaning function is in progress.
- ▶ Never hang combustible objects, e.g. tea towels, on the door handle.
- ▶ Leave the front of the appliance clear.
- ▶ Keep children at a safe distance.

If the door seal is damaged, a large amount of heat is generated around the door.

- ▶ Do not scrub or remove the seal.
- ▶ Never operate the appliance if the seal is damaged or missing.

⚠ WARNING – Risk of serious harm to health!

The appliance gets very hot when the cleaning function is in progress. The non-stick coating on baking trays and tins is destroyed and noxious gases are released.

- ▶ Never clean non-stick baking trays or baking tins using the cleaning function.
- ▶ Never clean accessories at the same time.

⚠ WARNING – Risk of harm to health!

The cleaning function heats up the cooking compartment to a very high temperature so that food left over from roasting, grilling and baking will burn off. This process releases vapours, which can irritate mucous membranes.

- ▶ Keep the kitchen well ventilated while the cleaning function is running.
- ▶ Do not remain in the room for long periods.
- ▶ Keep children and pets away.

⚠ WARNING – Risk of burns!

The cooking compartment gets very hot when the cleaning function is in progress.

- ▶ Never open the appliance door.
- ▶ Allow the appliance to cool down.
- ▶ Keep children at a safe distance.

⚠ The outside of the appliance gets very hot when the cleaning function is in progress.

- ▶ Never touch the appliance door.
- ▶ Allow the appliance to cool down.
- ▶ Keep children at a safe distance.

2 Preventing material damage

2.1 General

ATTENTION!

Alcoholic vapours may catch fire in the hot cooking compartment and cause permanent damage to the appliance. The appliance door may spring open due to an explosion and it may fall off. The door panels may shatter and fragment. Due to the resulting negative pressure, the cooking compartment may become considerably deformed inwards.

- ▶ Do not heat spirits ($\geq 15\%$ vol.) when undiluted (e.g. for marinating or pouring over food).

If there is water on the cooking compartment floor when operating the appliance at temperatures above $120\text{ }^{\circ}\text{C}$, this will damage the enamel.

- ▶ Do not use the appliance if there is water on the cooking compartment floor.
- ▶ Wipe away any water on the cooking compartment floor before operation.

Objects on the cooking compartment floor at over $50\text{ }^{\circ}\text{C}$ will cause heat to build up. The baking and roasting times will no longer be correct and the enamel will be damaged.

- ▶ Do not place any accessories, greaseproof paper or foil of any kind on the cooking compartment floor.
- ▶ At cooking temperatures above $50\text{ }^{\circ}\text{C}$, do not place any cookware on the cooking compartment floor. The exception is the water bowl for using the steam assistant.

When the cooking compartment is hot, any water inside it will create steam. The change in temperature may cause damage.

- ▶ Never pour water into the cooking compartment when it is still hot.
- ▶ Never place reservoirs containing water on the cooking compartment floor. The exception is the water bowl for using the steam assistant.

The prolonged presence of moisture in the cooking compartment leads to corrosion.

- ▶ Allow the cooking compartment to dry after use.
 - ▶ Do not keep moist food in the cooking compartment for a long time with the door closed.
 - ▶ Do not store food in the cooking compartment.
- Leaving the appliance to cool down with the door open will damage the front of neighbouring kitchen units over time.

- ▶ Always allow the cooking compartment to cool down with the door closed after cooking at high temperatures.
- ▶ Take care not to trap anything in the appliance door.
- ▶ Only leave the cooking compartment to dry with the door open if a lot of moisture was produced during operation.

Fruit juice dripping from the baking tray leaves stains that cannot be removed.

- ▶ When baking very juicy fruit flans, do not pack too much on the baking tray.
- ▶ If possible, use the deeper universal pan.

Using oven cleaner in a hot cooking compartment damages the enamel.

- ▶ Never use oven cleaner in the cooking compartment when it is still warm.
- ▶ Remove all food remnants from the cooking compartment and the appliance door before you next heat up the appliance.

If the seal is very dirty, the appliance door will no longer close properly during operation. This may damage the front of adjacent kitchen units.

- ▶ Keep the seal clean at all times.
- ▶ Never operate the appliance if the seal is damaged or missing.

Sitting or placing objects on the appliance door may damage it.

- ▶ Do not place, hang or support objects on the appliance door.
- ▶ Do not place cookware or accessories on the appliance door.

With certain models, accessories may scratch the door pane when closing the appliance door.

- ▶ Always push accessories fully into the cooking compartment.

3 Environmental protection and saving energy

3.1 Disposing of packaging

The packaging materials are environmentally compatible and can be recycled.

- ▶ Sort the individual components by type and dispose of them separately.

3.2 Saving energy

If you follow these instructions, your appliance will use less power.

Only preheat the appliance if the recipe or the recommended settings tell you to do so.

- Not preheating the appliance can reduce the energy used by up to 20%.

Use dark-coloured, black-coated or enamelled baking tins.

- These types of baking tin absorb the heat particularly well.

Open the appliance door as little as possible during operation.

- This maintains the temperature in the cooking compartment and eliminates the need for the appliance to reheat.

When baking multiple dishes, do so in succession or in parallel.

- The cooking compartment is heated after baking the first dish. This reduces the baking time for the second cake.

If the cooking time is relatively long, you can switch the appliance off 10 minutes before the cooking time ends.

- There will be enough residual heat to finish cooking the dish.

Remove any accessories that are not being used from the cooking compartment.

- Accessories that are not being used do not need to be heated.

Allow frozen food to defrost before cooking.

- This saves the energy that would otherwise be required to defrost it.

Note:

The appliance requires:

- a maximum of 2 W in networked standby mode
- a maximum of 1 W when the appliance is not connected to the network, with the display switched on
- a maximum of 0.5 W when the appliance is not connected to the network, with the display switched off

4 Familiarising yourself with your appliance

4.1 Controls

You can use the control panel to configure all functions of your appliance and to obtain information about the operating status.

Note: On certain models, specific details such as colour and shape may differ from those pictured.

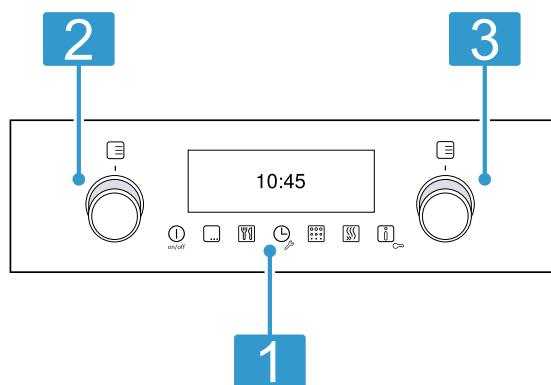

1 Buttons and display

The buttons are touch-sensitive surfaces. To select a function, simply press lightly on the relevant field.

The display shows symbols for active functions and the time-setting options.

2 Function selector

Use the function selector to set the types of heating and other functions.

You can freely turn the function selector clockwise or anti-clockwise; it does not have a zero setting.

Depending on the appliance, the function selector can be pushed in. Press on the function selector to engage or release it.

3 Temperature selector

Use the temperature selector to set the temperature for the type of heating and select settings for other functions.

You can freely turn the temperature selector clockwise and anti-clockwise; it does not have a zero setting.

Depending on the appliance, the temperature selector can be pushed in. Press on the temperature selector to click it in or out.

4.2 Buttons and display

You can use the buttons to set various functions for your appliance. The display shows the settings. The display shows the selected type of heating or operating mode together with the set cooking compartment temperature or setting.















Furthermore, you can read the settings for the active time-setting options to the left or right of the current time.

Symbol	Function	Use
	On/off	Switch the appliance on and off.
	Menu	Open the menu for the types of heating and operating modes.
	Home Connect	This appliance is Wi-Fi-capable and can be controlled using a mobile device. <ul style="list-style-type: none"> 📶 Home network and Home Connect server connected The number of lines shows the signal strength of the home network 📶 Home network not connected 📶 Home Connect server not connected 📶 Remote start activated 📶 Remote diagnostics activated
	Programmes	Open programmes that have coordinated set values.
	Time-setting options	Set the timer, cooking time or end time.
	Basic settings	Individually adjust the appliance settings.
	Cleaning	Open the pyrolytic self-cleaning cleaning function.
	Rapid heating	Start or cancel rapid heating for the cooking compartment.
	Information	Display information.
	Childproof lock	Lock and unlock oven functions on the control panel.

4.3 Types of heating and functions

To ensure that you always use the right type of heating to cook your food, we have explained the differences and applications below.

When you select a type of heating, the appliance suggests a suitable temperature or setting. You can use these values or change them within the specified range.

Symbol	Type of heating and temperature range	What it's used for/how it works
	3D hot air 30 - 275 °C	Bake and roast on one or more levels. The fan distributes the heat from the ring-shaped heating element in the back wall evenly around the cooking compartment.
	Top/bottom heating 30 - 275 °C	Traditionally bake or roast on one level. This type of heating is ideal for cakes with moist toppings. The heat is emitted evenly from above and below. This type of heating is used to measure the energy consumption in the conventional mode.
	Gentle hot air 125 - 275 °C	Cook selected dishes gently on one level without preheating. The fan distributes the heat from the ring-shaped heating element in the back wall evenly around the cooking compartment. The food is cooked in phases using residual heat. Always keep the appliance door closed when cooking. This type of heating is used to determine the energy consumption in air recirculation mode and the energy efficiency class.
	Intensive heat 30 - 275 °C	Preparing dishes with a crispy base. The heat is emitted from above and more intensively from below.
	Hot air grilling 30 - 275 °C	Roast poultry, whole fish and larger pieces of meat. The grill element and the fan switch on and off alternately. The fan circulates the hot air around the food.
	Full-surface grill Grill settings: 1 = low 2 = medium 3 = high	Grill flat items such as steak and sausages, or make toast. Gratinated food. The entire area underneath the grill element becomes hot.
	Grill, small area Grill settings: 1 = low 2 = medium 3 = high	Grill small quantities, such as steak, sausages or toast. Brown small quantities of food. The central area underneath the grill element becomes hot.
	Pizza setting 30 - 275 °C	Cook pizza or dishes that require a lot of heat from below. The bottom heating element and the ring-shaped heating element in the back wall heat the cooking compartment.
	Slow cooking 70 - 120 °C	Slowly and gently cook seared, tender pieces of meat in uncovered cookware. The heat is emitted evenly from above and below at a low temperature.
	Bottom heating 30 - 250 °C	Final baking or cooking food in a bain marie. Heat is emitted from below.
	Defrosting 30 - 60 °C	Gently defrost frozen food.
	Keeping food warm 60 - 100 °C	Keep cooked food warm.
	Plate warming 30 - 70 °C	Warming cookware.
	Oven light	Switch on the lighting in the cooking compartment.
	Hot air Steam 100 - 275 °C	Steam-assisted baking and roasting This type of heating is particularly well suited to frying meat and to baking bread and cakes. The fan distributes the heat and the steam evenly around the entire cooking compartment. Always use the appliance with the water bowl.

4.4 Temperature and setting levels

There are different settings for the types of heating and functions.

The settings appear in the display.

Notes

- The temperature can be set in 1 degree increments up to 100 °C, and in 5 degree increments thereafter.
- For grill setting 3, the appliance lowers the setting to grill setting 1 after approx. 20 minutes.

Heat-up indicator

The appliance indicates when it is heating up.

The line on the display fills from left to right as the cooking compartment heats up.

When preheating the appliance, the optimal time to place your food in the cooking compartment is once the entire line is full.

Residual heat indicator

If you switch off the appliance, the line on the display shows the residual heat in the cooking compartment. The brighter the line, the higher the residual heat.

Notes

- The heat-up indicator will only show the temperature increasing for types of heating for which a temperature is set. For grill settings, for example, the heat-up indicator shows a full line from the beginning.
- Due to thermal inertia, the temperature displayed may differ slightly from the actual temperature inside the cooking compartment.

4.5 Cooking compartment

The functions in the cooking compartment make your appliance easier to use.

Shelf supports

The shelf supports in the cooking compartment enable you to place accessories at different heights.

→ "Accessories", Page 9

Your appliance has five shelf positions. The shelf positions are numbered from bottom to top.

You can remove the shelf supports, e. g. for cleaning.
→ "Shelf supports", Page 24

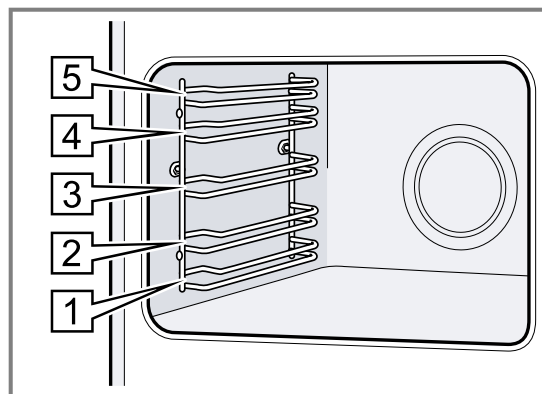

Lighting

The oven light lights up the cooking compartment. With most types of heating and functions, the lighting lights up during operation. The lighting goes off when operation ends.

You can use the oven light option in the menu to switch on the light without heating up the oven. After approximately 15 minutes, the lighting automatically switches itself off again.

Cooling fan

The cooling fan switches on automatically during operation. The hot air escapes above the door.

ATTENTION!

Do not cover the ventilation slot above the appliance door. The appliance overheats.

- ▶ Ensure that the ventilation slots are unobstructed.

To ensure that the appliance cools down more quickly after operation, the cooling fan continues to run for a certain period afterwards.

Appliance door

If you open the appliance door during operation, operation stops. When you close the appliance door, operation continues automatically.

5 Accessories

Use original accessories. These have been made especially for your appliance.

Note: Accessories may become deformed if they get hot. Deformation has no effect on function. As the accessory cools down, it will regain its original shape.

The accessories supplied may differ depending on the appliance model.

Accessories	Use
Wire rack	<ul style="list-style-type: none"> ■ Cake tins ■ Ovenproof dishes ■ Cookware ■ Meat, e.g. roasting joints or steak ■ Frozen meals
Universal pan	<ul style="list-style-type: none"> ■ Moist cakes ■ Baked items ■ Bread ■ Large roasts ■ Frozen meals ■ Catching dripping liquids, e.g. fat when grilling food on the wire rack.
Water bowl	<p>Cooking with the steam function The horizontal markings on the water bowl indicate the volume of water:</p> <ul style="list-style-type: none"> ■ 100 ml ■ 150 ml ■ 200 ml ■ 250 ml <p>→ "Steam assistance", Page 12</p>

5.1 Locking function

The locking function prevents the accessories from tilting when they are pulled out. You can pull out the accessories approximately halfway without them tipping. The accessories must be inserted into the cooking compartment correctly for the tilt protection to work properly.

5.2 Sliding accessories into the cooking compartment

Always slide accessories into the cooking compartment correctly. This is the only way to ensure that accessories can be pulled out approximately halfway without tipping.

1. Turn the accessories so that the notch **a** is at the rear and is facing downwards.
2. Insert accessories between the two guide rods for the shelf position.

Wire rack Insert the wire rack with the open side facing the appliance door and the curved lip **a** facing downwards.

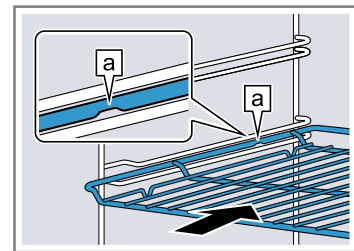

Baking tray Slide the tray, e.g. the universal pan, in with the sloping edge **b** facing the appliance door.

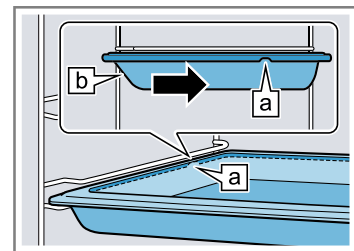

3. Push the accessory all the way in, making sure that it does not touch the appliance door.

Note: Take any accessories that you will not be using out of the cooking compartment while the appliance is in operation.

Combining accessories

You can combine the wire rack with the universal pan to catch any liquid that drips down.

1. Place the wire rack on the universal pan so that both spacers **a** are on the rear edge of the universal pan.
2. Insert the universal pan between the two guide rods for a shelf position. In so doing, the wire rack is on top of the upper guide rod.

Wire rack
on univer-
sal pan

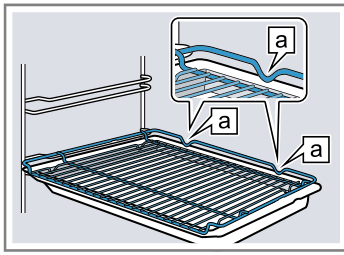

5.3 Other accessories

You can purchase other accessories from our customer service, specialist retailers or online. You will find a comprehensive range of products for your appliance in our brochures and online: www.bosch-home.com

Accessories are appliance-specific. When purchasing accessories, always quote the exact product number (E no.) of your appliance.

You can find out which accessories are available for your appliance in our online shop or from our customer service.

6 Before using for the first time

Configure the settings for initial start-up. Clean the appliance and accessories.

6.1 Initial use

You need to make settings for initial use before you can use your appliance.

Setting the language

German is preset as the language.

1. Use the temperature selector to set the required language.
2. Use the function selector to switch to the next setting.

Setting up Home Connect

This appliance is Wi-Fi-capable and can be remotely controlled using a mobile device.

1. To set up Home Connect, select "Use assistant to configure settings".
2. Follow the instructions on the appliance.
You can find more information about this in the section entitled Home Connect.

Note: You can also skip the set-up for Home Connect and instead carry out the steps in the basic settings at a later point. → Page 19

Use the function selector to switch to the next setting for the initial set-up.

Setting the time

The time starts at 12:00.

1. Use the temperature selector to set the current time.
2. Use the function selector to switch to the next setting.

Setting the date

To set the date, enter the year, month and day in that order.

1. Use the temperature selector to set the year.
 2. Use the function selector to change the setting to "Month".
 3. Use the temperature selector to set the month.
 4. Use the function selector to change the setting to "Day".
 5. Use the temperature selector to set the day.
 6. Press and hold the  button for three seconds.
- ✓ The initial configuration is complete.

Cleaning the appliance before using it for the first time

Clean the cooking compartment and accessories before using the appliance to prepare food for the first time.

1. Remove any accessories and leftover packaging, such as polystyrene pellets, from the cooking compartment.
2. Before heating the appliance, wipe the smooth surfaces in the cooking compartment with a soft, damp cloth.
3. Keep the room ventilated while the appliance is heating.
4. Set the type of heating and temperature.
→ "Basic operation", Page 11

Type of heating	3D hot air 
-----------------	--

Temperature	Maximum
-------------	---------

Cooking time	1 hour
--------------	--------

5. Switch off the appliance after the specified cooking time.
6. Wait until the cooking compartment has cooled down.
7. Clean the smooth surfaces with soapy water and a dish cloth.
8. Clean the accessories using soapy water and a dish cloth or soft brush.

7 Basic operation

7.1 Switching on the appliance

- ▶ Touch the  button.
- ✓ The appliance is switched on.

7.2 Switching off the appliance

- ▶ Touch the  button.
- ✓ The appliance is switched off.

7.3 Setting the type of heating and temperature

1. Use the function selector to set the type of heating.
2. Use the temperature selector to set the temperature or grill setting.
 - ✓ The appliance starts heating after a few seconds.
3. When your food is ready, switch off the appliance.

Note: The appliance starts in the types of heating menu. When you are in a different menu, touch the  button.

You can also set a cooking time and end time for the operation on the appliance.

Tip: The most suitable type of heating for your food can be found in the description of the type of heating.

Note: You can also set a cooking time and end time for the operation on the appliance.

→ "Time-setting options", Page 13

Changing the type of heating

You can change the type of heating at any time.

- ▶ Use the function selector to set the required type of heating.

Changing the temperature

You can change the temperature at any time.

- ▶ Use the temperature selector to set the required temperature.

8 Rapid heating

To save time, you can use rapid heating to shorten the preheat time.

Only use rapid heating when a temperature of over 100 °C has been set.



You can use rapid heating for the following types of heating:

- **3D hot air** 
- **Top/bottom heating** 
- **Intensive heat** 

8.1 Setting rapid heating

To ensure an even cooking result, do not place the food in the cooking compartment until rapid heating has come to an end.

Note: Do not set a cooking time until rapid heating has come to an end.

1. Set a suitable type of heating and a temperature of at least 100 °C.
2. Press the  button.
 - ✓  appears in the display.
 - ✓ Rapid heating starts after a few seconds.
 - ✓ Once rapid heating has ended, an audible signal sounds and the  symbol goes out in the display.
3. Place the food in the cooking compartment.

9 Steam assistance

If you are using steam-assisted cooking, steam is produced in the cooking compartment. This gives the food a crispy crust and a shiny surface. Furthermore, the food becomes tender and juicy inside and there is only a minimal reduction in its volume.

WARNING – Risk of burns!

While the appliance is in operation, the water bowl reaches high temperatures.

- ▶ Never remove the water bowl while the appliance is in operation.
- ▶ Only remove the water bowl once it has cooled down.

WARNING – Risk of scalding!

Hot steam may escape when you open the appliance door. Steam may not be visible, depending on the temperature.

- ▶ Open the appliance door carefully.
- ▶ Keep children at a safe distance.

ATTENTION!

Only use the water bowl that is enclosed with the appliance.

- ▶ Never fill the bowl while cooking.

Only use the water bowl to cook with steam assistance.

- ▶ Before you use other functions, first remove the water bowl.
- ▶ Do not use hard, metallic or sharp objects or aggressive cleaning agents.

9.1 Steam-assisted cooking

Tip: When preparing food and dishes with steam-assisted cooking, use a temperature setting above 100 °C to ensure optimal steam generation.

Observe the information in the table. → Page 32

Requirement: The oven must be cold.

1. Place the water bowl onto the floor of the appliance.
2. Fill the water bowl in accordance with the specified quantity.
3. Use the function selector to set **Hot air Steam** .
4. Use the temperature selector to set the required temperature.
 - ✓ After a few seconds, the appliance starts to heat and activates the steam-assisted cooking.

9.2 Ending steam-assisted cooking

1. Switch off the appliance.
2. Once the cooking compartment has cooled down:

- Take out the water bowl and clean with a soft cloth.



Tip: Wipe away stubborn limescale marks with a soft cloth moistened with vinegar or lemon juice. Clean using soapy water and dry with a soft cloth.

10 Time-setting options

Your appliance has different time-setting options, with which you can control its operation.



10.1 Overview of the time-setting options

Use the  button to select the different time-setting options.

Time-setting option	Use
Timer 	The timer can be set independently of the appliance when it is in operation. It does not affect the appliance.
Cooking time 	If you set a cooking time for the operation, operation of the appliance stops automatically once this time has elapsed.
End 	For the cooking time, you can set the time at which operation ends. The appliance starts up automatically so that it finishes cooking at the required time.

10.2 Setting the timer

The timer runs independently of the appliance when it is in operation. The timer can be set when the appliance is switched on or off, up to 24 hours. The timer has its own audible signal so that you can tell whether it is the timer or a cooking time which has elapsed.

1. Touch the  button.
 - ✓  appears in the display.
2. Use the temperature selector to set the timer duration.

The timer duration can be set in 30-second increments up to 10 minutes. The time increments then become bigger as the value increases.
3. Press the  button to confirm.
 - ✓ The timer starts and the timer duration begins to count down after a few seconds.
 - ✓ An audible signal sounds and the timer duration is zero in the display when the timer duration has elapsed.
4. Once the timer duration has elapsed:
 - Press any button to switch off the timer.

Changing the timer

You can change the timer duration at any time.

Requirement:  is highlighted in the display.

- ▶ Use the temperature selector to change the timer duration.
- ✓ The appliance applies the change after a few seconds.

Cancelling the timer

You can cancel the timer duration at any time.



Requirement:  is highlighted in the display.

- ▶ Use the temperature selector to reset the duration of the timer to zero.
- ✓ After a few seconds, the appliance applies the change and  goes out.

10.3 Setting the cooking time

You can set a cooking time for operation of up to 23 hours 59 minutes.

Requirement: The type of heating and temperature or setting have been set.

1. Touch the  button.
2. Use the function selector to select the cooking time .
3. Use the temperature selector to set the cooking time.

The cooking time can be set in one-minute increments up to one hour, and then in five-minute increments.

 - ✓ The appliance starts heating after a few seconds. The cooking time counts down in the display.
 - ✓ Once the cooking time has elapsed, a signal sounds and the appliance stops heating. "Operation finished" is shown in the display.
4. When your food is ready, use  to switch off the appliance.

Changing the cooking time

You can change the cooking time at any time.

Requirement:  is highlighted in the display.

- ▶ Use the temperature selector to change the cooking time.
- ✓ The appliance applies the change after a few seconds.

Cancelling the cooking time

You can cancel the cooking time at any time.

Requirement:  is highlighted in the display.

- ▶ Use the temperature selector to reset the cooking time to zero.
- ✓ After a few seconds, the appliance applies the change and continues to heat without a cooking time.

10.4 Setting the end time

You can delay the time at which cooking is due to finish by up to 23 hours and 59 minutes.



Notes

- Food will spoil if you leave it in the cooking compartment for too long.
- Food will spoil if you leave it in the cooking compartment for too long.

Requirements

- The type of heating and temperature are set.
- A cooking time is set.

1. Touch the  button.

2. Use the function selector to select the end time .
3. Use the temperature selector to set the end time.
 - ✓ The display shows the calculated end time.
4. Press the  button to confirm.
5. After a few seconds, the appliance applies the setting and the display shows the set end time.
 - ✓ Once the calculated start time has been reached, the appliance starts heating up and the cooking time starts counting down.
6. When the cooking time has elapsed:
 - An audible signal sounds and "Operation finished" is shown in the display.
 - When your food is ready, use  to switch off the appliance.

Changing the end time

You can also change the end time while the oven is operating. The operation is then stopped and restarts in accordance with the set cooking time and end time.

Requirement:  is highlighted in the display.

- ▶ Use the temperature selector to delay the end time.
- ✓ The appliance applies the change after a few seconds.

Cancelling the end time

You can delete the set end time at any time.

Requirement:  is highlighted in the display.

- ▶ Use the temperature selector to reset the end time to the current time plus the set cooking time.
- ✓ After a few seconds, the appliance applies the change and starts heating up. The cooking time counts down.

11 Programme

The programmes help you to use your appliance to prepare different dishes by selecting the optimum settings automatically.

11.1 Cookware for programmes

You should therefore use heat-resistant cookware that is suitable for temperatures up to 300 °C. Glass or glass ceramic cookware is best. The joint should cover approx. two thirds of the cookware base. Cookware made from the following material is not suitable:

- Bright, shiny aluminium
- Unglazed clay
- Plastic or plastic handles

11.2 Preparing food for the programme

Use fresh and, ideally, chilled food. Use frozen food straight from the freezer.

1. Weigh the food.
 - The weight of the food is required in order to correctly set the programme.
2. Add the food to the cookware.
3. Place the cookware onto the wire rack.
 - Always place the cookware into the cooking compartment while it is cold.

11.4 Programme table





The programme numbers are assigned to specific foods.

No.	Food	Cookware	Weight range Weight setting	Add liquid	Shelf position	Information
01	Pizza, thin base Frozen, prebaked	Universal pan with greaseproof paper	0.28–0.4 kg Total weight	No	3	For a second pizza, follow the instructions on the packaging

11.3 Setting a programme

The appliance selects the optimal type of heating, temperature and cooking time. All you need to do is set the weight.

Notes

- You can set the weight only in the intended range.
 - After the programme starts, you can no longer change the programme and the weight.
1. Touch the  button.
 2. Use the function selector to set the required programme.
 3. Use the temperature selector to set the weight of your food. Always set the next higher weight.
 - Touch the  button.
 - A message appears.
 4. Touch the  button.
 - A message appears.
 - ✓ After a few seconds, the programme starts and the cooking time counts down.
 5. When the programme ends:
 - To end the audible signal early, touch the  button.
 - To set the "Continue cooking" function, touch the  button.
 - You can use the temperature selector to set the cooking time for continued cooking.
 - When your food is ready, switch off the appliance.

No.	Food	Cookware	Weight range Weight setting	Add liquid	Shelf position	Information
02	Pizza, deep-pan Frozen, prebaked	Universal pan with greaseproof paper	0.28–0.6 kg Total weight	No	3	For a second pizza, follow the instructions on the packaging
03	Lasagne Frozen	Original packaging	0.3–1.2 kg Total weight	No	3	-
04	Chips Frozen	Universal pan with greaseproof paper	0.2–0.75 kg Total weight	No	3	Spread out beside each other on the universal pan
05	Prebaked bread rolls Frozen, prebaked	Universal pan with greaseproof paper	0.1–0.8 kg Total weight	No	3	-
06	Potato gratin	Ovenproof dish without lid	0.5–3.0 kg Total weight	No	2	-
07	Pasta bake With precooked pasta	Ovenproof dish without lid	0.4–3.0 kg Total weight	No	2	-
08	Crumble Fresh or frozen fruit with a crumble topping	Tin on wire rack	0.5–2.5 kg Total weight	No	3	Adding oats or nuts to the crumble topping makes it extra crunchy
09	Baked potatoes, whole Unpeeled, starchy potatoes	Universal pan	0.3–1.5 kg Total weight	No	3	-
10	Vegetable stew Vegetarian	Deep roasting dish with lid	0.5–2.5 kg Total weight	As per recipe	2	Cut vegetables that take longer to cook (e.g. carrots) into smaller pieces than vegetables that take less time to cook (e.g. tomatoes)
11	Meat stew	Deep roasting dish with lid	0.5–3.0 kg Total weight	As per recipe	2	Do not sear the meat beforehand
12	Goulash Beef or pork, diced with vegetables	Deep roasting dish with lid	0.5–2.5 kg Total weight	As per recipe	2	Place the meat at the bottom and cover with vegetables Do not sear the meat beforehand
13	Fish, whole Ready to cook, seasoned	Roasting dish with lid	0.3–1.5 kg Weight of fish	Cover the bottom of the roasting dish	2	-
14	Chicken, unstuffed Ready to cook, seasoned	Roasting dish with glass lid	0.6–2.5 kg Chicken weight	No	2	Place in the cookware with the breast facing up
15	Chicken pieces Ready to cook, seasoned	Roasting dish with lid	0.1–0.8 kg Weight of the heaviest piece	Cover the bottom of the roasting dish	2	-
16	Duck, unstuffed Ready to cook, seasoned	Roasting pan without lid	1.0–2.7 kg Duck weight	No	2	-
17	Goose, unstuffed Ready to cook, seasoned	Roasting pan without lid	2.5–3.5 kg Goose weight	No	2	-
18	Goose legs Ready to cook, seasoned	Roasting pan without lid	0.3–0.8 kg Chicken weight	Cover the bottom of the roasting dish	2	-

No.	Food	Cookware	Weight range Weight setting	Add liquid	Shelf position	Information
19	Unstuffed small turkey Ready to cook, seasoned	Roasting pan without lid	2.0–3.5 kg Weight of meat	No	2	-
20	Turkey breast Whole, seasoned	Roasting dish with glass lid	0.5–2.5 kg Turkey breast weight	Cover the bottom of the roasting dish, and add up to 250 g vegetables if required	2	-
21	Pot-roasted beef E.g. prime rib, shoulder, rump or marinated beef roast	Roasting dish with lid	0.5–2.5 kg Weight of meat	Almost cover the meat with liquid	2	Do not sear the meat beforehand
22	Sirloin, rare Ready to cook, seasoned	Roasting pan without lid	0.5–2.5 kg Weight of meat	No	2	Place in the cookware with the fatty side up Do not sear the meat beforehand
23	Sirloin, medium Ready to cook, seasoned	Roasting pan without lid	0.5–2.5 kg Weight of meat	No	2	Place in the cookware with the fatty side up Do not sear the meat beforehand
24	Beef roulades Stuffed with vegetables or meat	Roasting dish with lid	0.5–2.5 kg Total weight of all the stuffed roulades	Add stock, water or another liquid to the dish until the roulades are almost covered	2	Do not sear the meat beforehand
25	Meat loaf, fresh Minced beef, pork or lamb	Roasting dish with lid	0.5–2.5 kg Roast weight	No	2	Do not sear the meat beforehand
26	Boned leg of lamb, medium Ready to cook, seasoned	Roasting dish with lid	0.5–2.5 kg Weight of meat	Cover the bottom of the roasting dish, and add up to 250 g vegetables if required	2	Do not sear the meat beforehand
27	Boned leg of lamb, well done Ready to cook, seasoned	Roasting dish with lid	0.5–2.5 kg Weight of meat	Cover the bottom of the roasting dish, and add up to 250 g vegetables if required	2	Do not sear the meat beforehand
28	Leg of lamb on the bone, well done Ready to cook, seasoned	Roasting dish with lid	0.5–2.5 kg Weight of meat	Cover the bottom of the roasting dish, and add up to 250 g vegetables if required	2	Do not sear the meat beforehand

No.	Food	Cookware	Weight range Weight setting	Add liquid	Shelf position	Information
29	Joint of veal, marbled E.g. saddle or topside	Roasting dish with lid	0.5–3.0 kg Weight of meat	Cover the bottom of the roasting dish, and add up to 250 g vegetables if required	2	Do not sear the meat beforehand
30	Joint of veal, lean E.g. tenderloin or eye	Roasting dish with lid	0.5–2.5 kg Weight of meat	Cover the bottom of the roasting dish, and add up to 250 g vegetables if required	2	Do not sear the meat beforehand
31	Veal knuckle	Roasting dish with lid	0.5–2.5 kg Weight of meat	Cover the bottom of the roasting dish, and add up to 250 g vegetables if required	2	Do not sear the meat beforehand
32	Veal ossobucco	Roasting dish with lid	0.5–3.5 kg Weight of meat	Cover the bottom of the roasting dish, and add up to 250 g vegetables if required	2	Do not sear the meat beforehand
33	Boneless haunch of venison	Roasting dish with lid	0.5–2.5 kg Weight of meat	Cover the bottom of the roasting dish, and add up to 250 g vegetables if required	2	-
34	Boneless haunch of roe venison Seasoned with salt	Roasting dish with lid	0.5–2.0 kg Weight of meat	Cover the bottom of the roasting dish, and add up to 250 g vegetables if required	2	-
35	Rabbit, whole Ready to cook, seasoned	Roasting dish with glass lid	1.0–2.5 kg Weight of meat	Cover the bottom of the roasting dish, and add up to 250 g vegetables if required	2	-
36	Wild boar joint Ready to cook, seasoned	Roasting dish with glass lid	0.5–3.0 kg Weight of meat	Cover the bottom of the roasting dish, and add up to 250 g vegetables if required	2	-

No.	Food	Cookware	Weight range Weight setting	Add liquid	Shelf position	Information
37	Boned pork neck joint Ready to cook, seasoned	Roasting dish with glass lid	0.5–3.0 kg Weight of meat	Cover the bottom of the roasting dish, and add up to 250 g vegetables if required	2	Do not sear the meat beforehand
38	Joint of pork, with crackling E.g. shoulder, seasoned, and scored rind	Roasting dish with glass lid	0.5–3.0 kg Weight of meat	Cover the bottom of the roasting dish, and add up to 250 g vegetables if required	2	Place in the cookware fatty side up; salt the rind well
39	Pork tenderloin steak Seasoned	Roasting dish with glass lid	0.5–2.5 kg Weight of meat	Cover the bottom of the roasting dish, and add up to 250 g vegetables if required	2	Do not sear the meat beforehand
40	Rolled pork joint Ready to cook, seasoned	Roasting dish with glass lid	0.5–3.0 kg Weight of meat	Cover the bottom of the roasting dish, and add up to 250 g vegetables if required	2	Do not sear the meat beforehand





12 Childproof lock

You can secure your appliance to prevent children from accidentally switching it on or changing the settings.

Notes

- You can go to the basic settings → *Page 19* to specify whether you want the option to set the childproof lock.
- If you have connected a hob to the oven, the hob is not locked.

12.1 Activating and deactivating the childproof lock

1. To activate the childproof lock, press and hold the  button until  appears in the display.
2. To deactivate the childproof lock, press and hold the  button until  goes out in the display.

13 Sabbath mode

You can set a time of over 70 hours using Sabbath mode. You can use **Top/bottom heating** to keep food warm between 85 °C and 140 °C during this time without having to switch the appliance on or off.

13.1 Starting Sabbath mode



Notes

- If you open the appliance door during operation, the appliance stops heating. When you close the appliance door, the appliance continues to heat again.
- Once it has started, you can no longer change or interrupt Sabbath mode.
- You cannot delay the end time for Sabbath mode.

- If you want to cancel Sabbath mode, touch the  button.

Requirement: Sabbath mode is activated in the basic settings.

→ "*Basic settings*", *Page 19*

1. Touch the  button.
 2. Use the function selector to select Sabbath mode .
 3. Touch the  button.
 4. Use the function selector to select "Cooking time".
 5. Use the temperature selector to set the required cooking time.
- ✓ After a few seconds, the appliance applies the cooking time and Sabbath mode appears.

6. Use the temperature selector to set the temperature.
 - ✓ After a few seconds, the appliance starts heating and the cooking time counts down.
7. Once the time has elapsed, the display shows the time as zero. The appliance stops heating up and responds again as usual outside of Sabbath mode.

- Switch off the appliance. The appliance automatically switches off after approx. 10 to 20 minutes.

14 Basic settings

You can configure the basic settings for your appliance to meet your needs.

14.1 Overview of the basic settings

Here you can find an overview of the basic settings and factory settings. The basic settings depend on the features of your appliance.

Basic settings	Selection
Language	Selecting language
Home Connect	Implement settings for Home Connect and connect appliances. Appliance information
Wi-Fi	Off On
Clock	Set the current time
Audible signal	Short cooking time Medium cooking time ¹ Long cooking time
Button tone	Switched off ¹ Switched on
Display brightness	Display brightness is adjustable in five stages
Time	Displays ¹ Do not display
Lighting during operation	Off On ¹
Childproof lock	Button lock only ¹ Door lock + button lock Deactivated
Elapsed cooking time	Do not display From start ¹ After heating up
Night-time dimming	Off ¹ On (display dimmed between 22:00 and 05:59)



¹ Factory setting (may vary according to model)

Basic settings	Selection
Start-up animation	Do not display Displays ¹
Fan run-on time	Minimum Medium Recommended ¹ Long
Pull-out system	Not retrofitted (if shelf supports and a single set of pull-out rails are fitted) ¹ Retrofitted (if two or three sets of pull-out rails are fitted)
Sabbath mode	Do not display ¹ Displays
Dishes	All ¹ Kosher only No pork
Factory settings	Yes (reset) No

¹ Factory setting (may vary according to model)

14.2 Changing basic settings

Requirement: The appliance is switched off.

1. Press and hold the  button for approx. three seconds.
 - ✓ The first basic setting is shown in the display.
2. Use the function selector to switch to the next or previous basic setting.
3. To save the changes, press and hold the  button for approx. three seconds.

14.3 Discarding changes to the basic settings

- ▶ Touch the  button.
- ✓ All changes are discarded and not saved.

15 Home Connect

This appliance is network-capable. Connecting your appliance to a mobile device lets you control its functions via the Home Connect app, adjust its basic settings and monitor its operating status.

The Home Connect services are not available in every country. The availability of the Home Connect function depends on the availability of Home Connect services in your country. You can find information about this at: www.home-connect.com.

The Home Connect app guides you through the entire login process. Follow the instructions in the Home Connect app to configure the settings.

Tip: Please also follow the instructions in the Home Connect app.

Notes

- Please note the safety precautions in this instruction manual and make sure that they are also observed when operating the appliance via the Home Connect app.
→ "Safety", Page 2
- Operating the appliance on the appliance itself always takes priority. During this time it is not possible to operate the appliance using the Home Connect app.
- In networked standby mode, the appliance requires a maximum of 2 W.

15.1 Setting up the Home Connect app

1. Install the Home Connect app on your mobile device.
2. Start the Home Connect app and set up access for Home Connect.
The Home Connect app guides you through the entire login process.

15.2 Setting up Home Connect

Requirements

- The appliance is connected to the power supply and is switched on.
- You have a mobile device with a current version of the iOS or Android operating system, e.g. a smartphone.
- The Home Connect app has been installed on your mobile device.
- The appliance is receiving signals from the WLAN home network (Wi-Fi) at its installation location.
- The mobile device and the appliance are within range of your home network's Wi-Fi signal.

1. Open the Home Connect app and scan the following QR code.



2. Follow the instructions in the Home Connect app.

15.3 Software update

Your appliance's software can be updated using the software update function, e.g. for the purposes of optimisation, troubleshooting or security updates.

To do this, you must be a registered Home Connect user, have installed the app on your mobile device and be connected to the Home Connect server. As soon as a software update is available, you will be informed via the Home Connect app and will be able to start the software update via the app. Once the update has been successfully downloaded, you can start installing it via the Home Connect app if you are in your home network (Wi-Fi). The Home Connect app informs you once installation is successful.

Notes

- The software update consists of two steps.
 - The first step is the download.
 - The second step is the installation on your appliance.
- You can continue to use your appliance as normal while updates are downloading. Depending on your personal settings in the app, software updates can also be set to download automatically.
- Installation takes a few minutes. You cannot use your appliance during installation.
- We recommend that you install security updates as soon as possible.

15.4 Remote diagnostics

Customer Service can use Remote Diagnostics to access your appliance if you contact them, have your appliance connected to the Home Connect server and if Remote Diagnostics is available in the country in which you are using the appliance.

Tip: For further information and details about the availability of Remote Diagnostics in your country, please visit the service/support section of your local website: www.home-connect.com.

15.5 Data protection

Please see the information on data protection. The first time your appliance is registered on a home network connected to the Internet, your appliance will transmit the following types of data to the Home Connect server (initial registration):

- Unique appliance identification (consisting of appliance codes as well as the MAC address of the Wi-Fi communication module installed).
- Security certificate of the Wi-Fi communication module (to ensure a secure data connection).
- The current software and hardware version of your appliance.
- Status of any previous reset to factory settings.

This initial registration prepares the Home Connect functions for use and is only required when you want to use the Home Connect functions for the first time.

Note: Please note that the Home Connect functions can only be utilised with the Home Connect app. Information on data protection can be retrieved in the Home Connect app.

16 Cleaning and servicing

To keep your appliance working efficiently for a long time, it is important to clean and maintain it carefully.

16.1 Cleaning products

In order to avoid damaging the various oven surfaces on the appliance, do not use unsuitable cleaning products.

WARNING – Risk of electric shock!

An ingress of moisture can cause an electric shock.

- ▶ Do not use steam- or high-pressure cleaners to clean the appliance.

ATTENTION!

Unsuitable cleaning products may damage the surfaces of the appliance.

- ▶ Do not use harsh or abrasive cleaning products.

- ▶ Do not use cleaning products with a high alcohol content.
- ▶ Do not use hard scouring pads or cleaning sponges.
- ▶ Do not use any special cleaners for cleaning the appliance while it is hot.

Using oven cleaner in a hot cooking compartment damages the enamel.

- ▶ Never use oven cleaner in the cooking compartment when it is still warm.
- ▶ Remove all food remnants from the cooking compartment and the appliance door before you next heat up the appliance.

New sponge cloths contain residues from production.

- ▶ Wash new sponge cloths thoroughly before use.

Suitable cleaning agents

Only use cleaning products that are suitable for the different surfaces on your appliance.

Follow the instructions on cleaning the appliance.
→ "Cleaning the appliance", Page 22

Appliance front

Surface	Suitable cleaning agents	Information
Stainless steel	<ul style="list-style-type: none"> ▪ Hot soapy water ▪ Special stainless steel cleaning products suitable for hot surfaces 	To prevent corrosion, remove any patches of limescale, grease, starch or albumin (e.g. egg white) on stainless steel surfaces immediately. Apply a thin layer of the stainless steel cleaning product with a soft cloth.
Plastic or painted surfaces E.g. control panel	<ul style="list-style-type: none"> ▪ Hot soapy water 	Do not use glass cleaner or a glass scraper.

Appliance door

Area	Suitable cleaning agents	Information
Door panels	<ul style="list-style-type: none"> ▪ Hot soapy water 	Do not use a glass scraper or a stainless steel wool. Tip: Remove the door panels in order to clean them thoroughly. → "Appliance door", Page 25
Door cover	<ul style="list-style-type: none"> ▪ Made of stainless steel: Stainless steel cleaner ▪ Made of plastic: Hot soapy water 	Do not use glass cleaner or a glass scraper. Tip: Remove the door cover for thorough cleaning. → "Appliance door", Page 25
Door handle	<ul style="list-style-type: none"> ▪ Hot soapy water 	To avoid permanent stains, remove descaling agents from the door handle immediately.
Door seal	<ul style="list-style-type: none"> ▪ Hot soapy water 	Do not remove or scrub.

Cooking compartment

Area	Suitable cleaning agents	Information
Enamel surfaces	<ul style="list-style-type: none"> ▪ Hot soapy water ▪ Vinegar water ▪ Oven cleaner 	<p>Soak any heavily soiled areas and use a brush or steel wool. Leave the appliance door open to dry the cooking compartment after cleaning it.</p> <p>Tip: It is best to use the cleaning function. → "Pyrolytic self-cleaning ", Page 22</p> <p>Notes</p> <ul style="list-style-type: none"> ▪ Enamel burns at very high temperatures, causing minor discoloration. The functionality of your appliance is not affected by this. ▪ The edges of thin trays cannot be completely enamelled and may be rough. This does not impair corrosion protection. ▪ Food residues will leave a white coating on the enamel surfaces. The coating does not pose a health risk. The functionality of your appliance is not affected by this. You can remove residues with lemon juice.
Glass cover for the oven light	<ul style="list-style-type: none"> ▪ Hot soapy water 	Use oven cleaner to remove very heavy soiling.
Rails	<ul style="list-style-type: none"> ▪ Hot soapy water 	<p>Soak any heavily soiled areas and use a brush or steel wool.</p> <p>Tip: Remove the shelf supports for cleaning. → "Shelf supports", Page 24</p>
Accessories	<ul style="list-style-type: none"> ▪ Hot soapy water ▪ Oven cleaner 	Soak any heavily soiled areas and use a brush or steel wool. Enamelled accessories are dishwasher-safe.
Water bowl	<ul style="list-style-type: none"> ▪ Hot soapy water 	<p>Wash and dry with a soft cloth.</p> <p>The water bowl is dishwasher-safe.</p> <p>Do not use hard, metallic or sharp objects or aggressive cleaning agents. → "Steam assistance", Page 12</p>

16.2 Cleaning the appliance

In order to avoid damaging the appliance, you must clean your appliance only as specified, and with suitable cleaning products.

WARNING – Risk of burns!

The appliance and its parts that can be touched become hot during use.

- ▶ Caution should be exercised here in order to avoid touching heating elements.
- ▶ Young children under 8 years of age must be kept away from the appliance.

WARNING – Risk of fire!

Loose food remnants, fat and meat juices may catch fire.

- ▶ Before using the appliance, remove the worst of the food residues and remnants from the cooking compartment, heating elements and accessories.

Requirement: Read the information on cleaning products.

→ "Cleaning products", Page 21

1. Clean the appliance using hot soapy water and a dish cloth.
 - For some surfaces, you can use alternative cleaning agents.
→ "Suitable cleaning agents", Page 21
2. Dry with a soft cloth.

17 Pyrolytic self-cleaning

The **Pyrolytic self-cleaning** cleaning function cleans the cooking compartment almost by itself.

Use the cleaning function to clean the cooking compartment every two to three months. If required, you can use the cleaning function more frequently. The cleaning function requires approx. 2.5–4.8 kilowatt hours.

17.1 Preparing the appliance for the cleaning function

In order to achieve a good cleaning result, prepare the appliance carefully.

⚠ WARNING – Risk of fire!

Combustible objects that are left in the cooking compartment may catch fire.

- ▶ Never store combustible objects in the cooking compartment.
 - ▶ If smoke is emitted, the appliance must be switched off or the plug must be pulled out and the door must be held closed in order to stifle any flames. Loose food remnants, fat and meat juices may catch fire when the cleaning function is in progress.
 - ▶ Before you start the cleaning function, always remove coarse dirt from the cooking compartment.
 - ▶ Never clean accessories at the same time.
- The outside of the appliance gets very hot when the cleaning function is in progress.

- ▶ Never hang combustible objects, e.g. tea towels, on the door handle.
- ▶ Leave the front of the appliance clear.
- ▶ Keep children at a safe distance.

If the door seal is damaged, a large amount of heat is generated around the door.

- ▶ Do not scrub or remove the seal.
 - ▶ Never operate the appliance if the seal is damaged or missing.
1. Remove accessories and cookware from the cooking compartment.
 2. Unhook the shelf supports and remove them from the cooking compartment.
→ "Shelf supports", Page 24
 3. Remove heavy soiling from the cooking compartment.
 4. Use a detergent solution and a soft cloth to clean the surfaces at the edges of the cooking compartment around the door seal.
Do not remove or scrub the door seal.
Use oven cleaner to remove stubborn dirt from the inner door pane.
 5. Remove any objects from the cooking compartment.
The cooking compartment must be empty.

17.2 Setting the cleaning function

Ventilate the kitchen while the cleaning function is running.

⚠ WARNING – Risk of harm to health!

The cleaning function heats up the cooking compartment to a very high temperature so that food left over from roasting, grilling and baking will burn off. This process releases vapours, which can irritate mucous membranes.

- ▶ Keep the kitchen well ventilated while the cleaning function is running.
- ▶ Do not remain in the room for long periods.
- ▶ Keep children and pets away.

⚠ WARNING – Risk of burns!

The cooking compartment gets very hot when the cleaning function is in progress.

- ▶ Never open the appliance door.
- ▶ Allow the appliance to cool down.
- ▶ Keep children at a safe distance.

⚠ The outside of the appliance gets very hot when the cleaning function is in progress.

- ▶ Never touch the appliance door.
- ▶ Allow the appliance to cool down.
- ▶ Keep children at a safe distance.

Note: The oven light does not light up while the cleaning function is running.





Requirement: Prepare the appliance for the cleaning function. → Page 22

1. Touch the  button.
2. Use the temperature selector to set the cleaning setting.

Cleaning setting	Cleaning level	Duration in hours
1	Low	Approx. 1:15
2	Medium	Approx. 1:30
3	High	Approx. 2:00

Select a higher cleaning setting for heavier or older soiling.

The duration cannot be changed.

3. Touch the  button.
Refer to the messages in the display.
4. Use the  button to start the cleaning function.
 - ✓ After a few seconds, the cleaning function starts and the duration counts down.
 - ✓ For your safety, the appliance door locks shortly after the function starts.  appears in the display.
 - ✓ When the cleaning function ends, the duration is at zero in the display.
5. Press  to switch the appliance off.
When the appliance has cooled down, the appliance door is unlocked and  goes out.

17.3 Preparing the appliance for use following the cleaning function

1. Allow the appliance to cool down.
2. Wipe off any ash that has been left behind in the cooking compartment and around the appliance door with a damp cloth.
3. Remove white residues with lemon juice.

Note: White residues on the enamel surfaces may be caused by heavy soiling. These food residues are harmless. The deposits do not compromise the functionality of the appliance.

4. Attach the shelf supports.
→ "Shelf supports", Page 24

18 Cleaning aid

The cleaning aid is a quick alternative for occasionally cleaning the cooking compartment. The cleaning aid softens dirt by vaporising the soapy water. It is then easier to remove dirt.



18.1 Setting the cleaning aid

⚠ WARNING – Risk of scalding!

If there is water in the cooking compartment when it is hot, this may create hot steam.

- ▶ Never pour water into the cooking compartment when the cooking compartment is hot.

Requirement: The cooking compartment has cooled down completely.

1. Remove the accessories from the cooking compartment.
2. Mix 0.4 litres water with a drop of washing-up liquid and pour into the centre of the cooking compartment floor.
Do not use distilled water.
3. Use the function selector to set the **Bottom heating**  type of heating.
4. Use the temperature selector to set 80 °C.
5. Touch the  button and use the function selector to select the duration .
6. Use the temperature selector to set the duration to four minutes.
 - ✓ After a few seconds, the appliance starts heating and the duration counts down.
 - ✓ When the duration has counted down, a signal sounds and the duration is at zero in the display.

7. Switch off the appliance and leave the cooking compartment to cool down for 20 minutes.

18.2 Recleaning the cooking compartment

ATTENTION!

The prolonged presence of moisture in the cooking compartment leads to corrosion.

- ▶ After using the cleaning assistance, wipe the cooking compartment and allow it to dry completely.

Requirement: The cooking compartment has cooled down.

1. Open the appliance door and remove the remaining water with an absorbent sponge cloth.
2. Clean the smooth surfaces in the cooking compartment with a dish cloth or a soft brush. Remove stubborn food remnants using a stainless steel scouring pad.
3. Remove limescale with a cloth soaked in vinegar. Then wipe with clean water and rub dry with a soft cloth (including under the door seal).
4. Once the cooking compartment is cleaned sufficiently:
 - To allow the cooking compartment to dry, open the appliance door to the stop position (approx. 30°) and leave it open for approx. one hour.



19 Shelf supports

To clean the rails and the cooking compartment, or to replace the rails, you can remove these.

19.1 Detaching the shelf supports

⚠ WARNING – Risk of burns!

The shelf supports get very hot



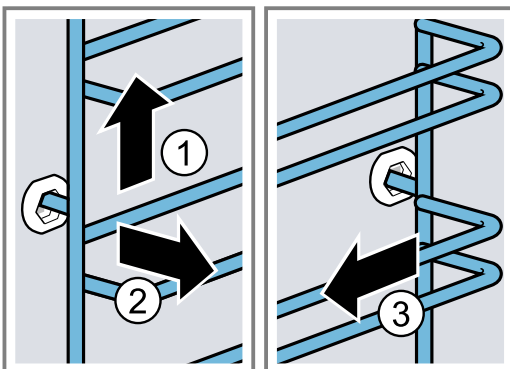

- ▶ Never touch the shelf supports when hot.
 - ▶ Always allow the appliance to cool down.
 - ▶ Keep children at a safe distance.
1. Lift the rail forwards slightly  and detach it .
 2. Pull the whole rail to the front  and remove it.



3. Clean the rail.
→ "Cleaning products", Page 21

19.2 Attaching the shelf supports

Notes

- The rails only fit on the right or left.
 - For both rails, ensure that the curved rods are at the front.
1. First, push the rail into the middle of the rear socket  until the rail rests against the cooking compartment wall, and then push this back .
 2. Push the rail into the front socket  until the rail also rests against the cooking compartment wall, and then press this downwards .

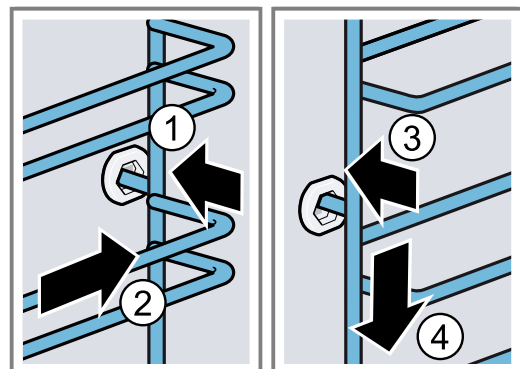

20 Appliance door

To ensure that your appliance retains its appearance and remains fully functioning for a long time, you can detach the appliance door and clean it.

20.1 Detaching the appliance door

⚠ WARNING – Risk of injury!

Components inside the appliance door may have sharp edges.

- ▶ Wear protective gloves.

The hinges on the appliance door move when the door is opened and closed, which could trap your fingers.

- ▶ Keep your hands away from the hinges.

1. Open the appliance door fully and push in the direction of the appliance.

2. **⚠ WARNING – Risk of injury!**

When the hinges are not secured, they can snap shut with great force.

- ▶ Make sure that the locking levers are always either fully closed or (when detaching the oven door) fully open.

Open the locking levers on the left- and right-hand hinges.

Locking levers opened

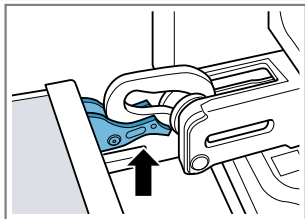

The hinge is now secured and cannot snap shut.

Locking levers closed

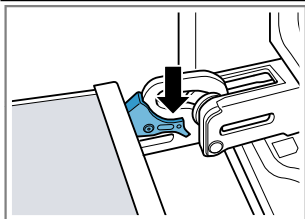

The appliance door is secured and cannot be detached.

- ✓ The locking levers are open. The hinges are now secured and cannot snap shut.

3. Close the appliance door fully ①. Grab hold of the appliance door with both hands (on the left and right) and pull it upwards and out ②.

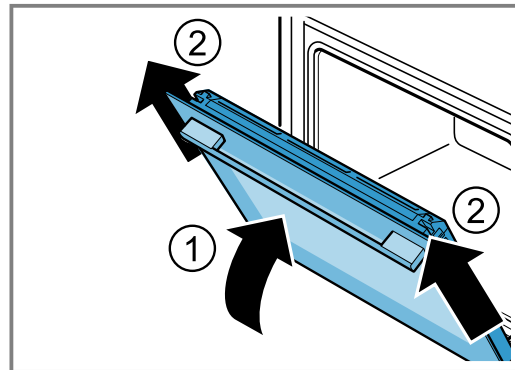

4. Carefully place the appliance door on a level surface.

20.2 Attaching the appliance door

⚠ WARNING – Risk of injury!

The hinges on the appliance door move when the door is opened and closed, which could trap your fingers.

- ▶ Keep your hands away from the hinges.

When the hinges are not secured, they can snap shut with great force.

- ▶ Make sure that the locking levers are always either fully closed or (when detaching the oven door) fully open.

1. **Note:** Ensure that the appliance door slides onto the hinges without any resistance. If you feel any resistance, check whether you are sliding it in at the correct opening.

Slide the appliance door straight onto the two hinges. Slide the appliance door on as far as it will go.

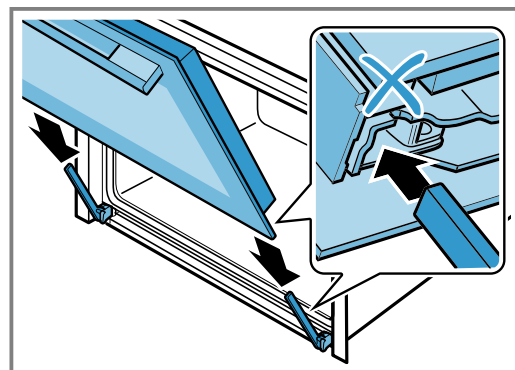

- Using both hands, press down on the left and right of the door cover from above to check whether the appliance has been pushed in as far as it will go.

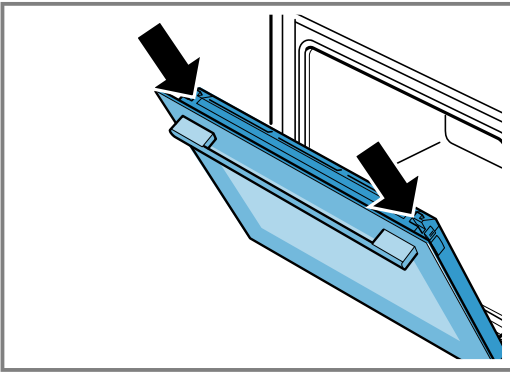

- Open the appliance door fully.
- Close the locking levers on the left- and right-hand hinges.

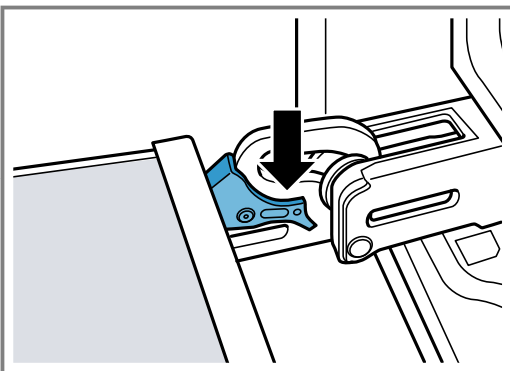

✓ The locking levers are closed. The appliance door is secured and cannot be detached.

- Close the appliance door.

20.3 Removing the door panes

⚠ WARNING – Risk of injury!

The hinges on the appliance door move when the door is opened and closed, which could trap your fingers.

- Keep your hands away from the hinges.
- Components inside the appliance door may have sharp edges.
- Wear protective gloves.

- Open the appliance door slightly.
- Push on the left- and right-hand side of the door cover from the outside ① until it is released.
- Remove the door cover ②.

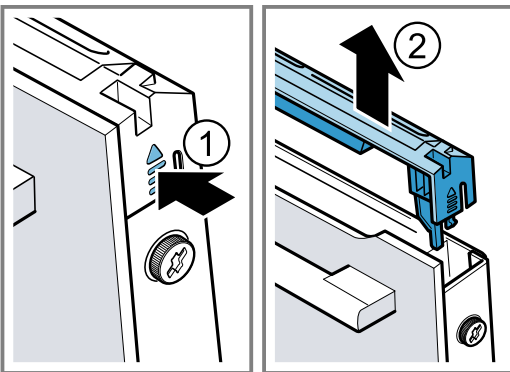

- Clean the door cover.
→ "Suitable cleaning agents", Page 21

- Undoing and removing the left- and right-hand screws on the appliance door ①
- Place a folded-up tea towel in the appliance door. Pull the front pane up and out ②.

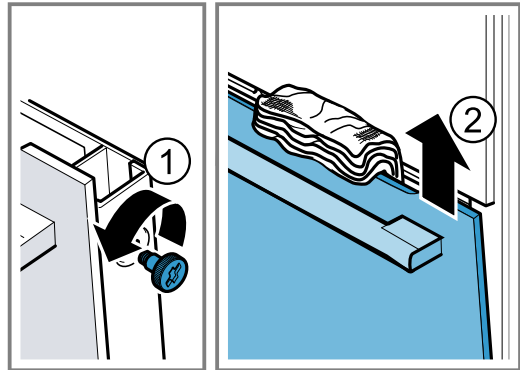

- Set the front pane down on a level surface with the door handle facing down.
- Press the intermediate pane against the appliance with one hand while pushing the left- and right-hand retainers [a] upwards. Do not detach the retainers [a].

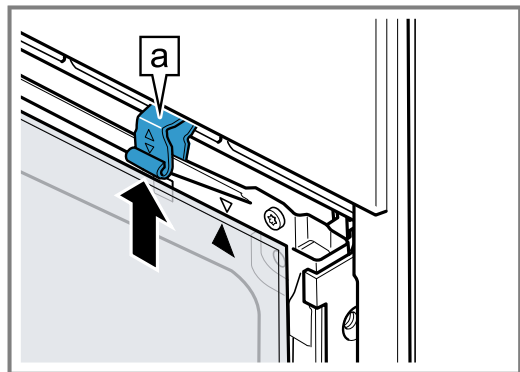

- Remove the intermediate pane.
- ⚠ **WARNING – Risk of injury!**
Scatched glass in the appliance door may develop into a crack.
 - Do not use any harsh or abrasive cleaners or sharp metal scrapers to clean the glass on the oven door, as they may scratch the surface.
 Clean the removed door panes on both sides with glass cleaner and a soft cloth.
- Clean the appliance door.
→ "Suitable cleaning agents", Page 21
- Dry the door panes and refit them.
→ "Fitting the door panes", Page 26

20.4 Fitting the door panes

⚠ WARNING – Risk of injury!

The hinges on the appliance door move when the door is opened and closed, which could trap your fingers.

- Keep your hands away from the hinges.
- Components inside the appliance door may have sharp edges.
- Wear protective gloves.

1. Turn the intermediate pane until the arrow **a** is in the top right.

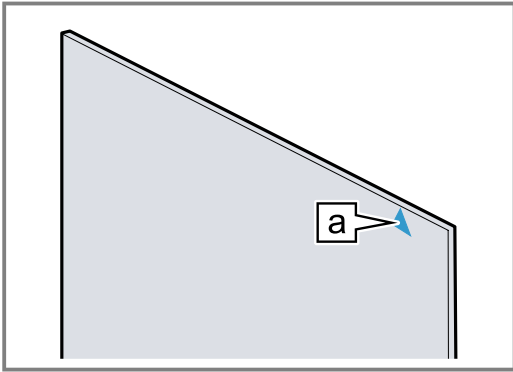

2. Insert **1** the intermediate pane into the retainer **a** at the bottom and push it in firmly at the top.
3. Push the left- and right-hand retainer **a** downwards until the intermediate pane is clamped **2**.

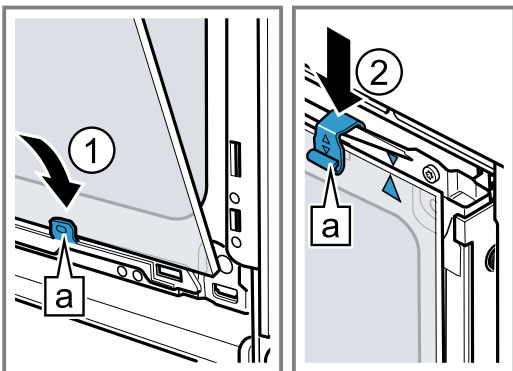

4. Attach the front pane downwards into the left- and right-hand retainers **a** **1**.

5. Push the front pane to the appliance until the left- and right-hand hook **a** is opposite the support **b** **2**.

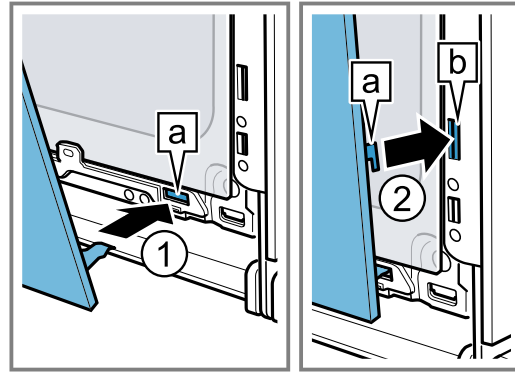

6. Push the front pane in at the bottom **1** until you hear it click into place.
7. Open the appliance door slightly and remove the tea towel.
8. Screw both screws back in on the left and right of the appliance door.
9. Put the door cover in position and push down on it **2** until you hear it click into place.

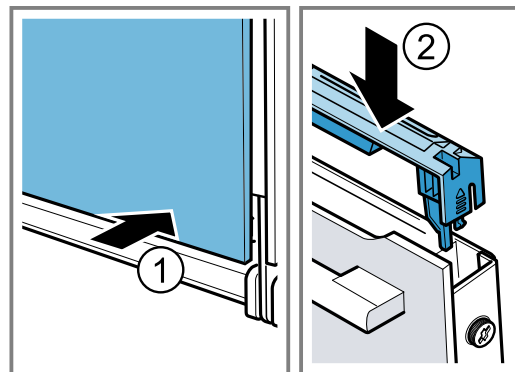

10. Close the appliance door.

Note: Do not use the cooking compartment again until the door panes have been correctly fitted.

21 Troubleshooting

You can rectify minor faults on your appliance yourself. Read the troubleshooting information before contacting after-sales service. This will avoid unnecessary costs.

⚠ WARNING – Risk of injury!

Improper repairs are dangerous.

- ▶ Repairs to the appliance should only be carried out by trained specialist staff.
- ▶ If the appliance is defective, call Customer Service.









⚠ WARNING – Risk of electric shock!

Incorrect repairs are dangerous.

- ▶ Repairs to the appliance should only be carried out by trained specialist staff.
- ▶ Only use genuine spare parts when repairing the appliance.
- ▶ If the power cord of this appliance is damaged, it must be replaced by trained specialist staff.

21.1 Malfunctions

Fault	Cause and troubleshooting
The appliance is not working.	The circuit breaker is faulty. <ul style="list-style-type: none"> ▶ Check the circuit breaker in the fuse box.
	There has been a power cut. <ul style="list-style-type: none"> ▶ Check whether the lighting in your room or other appliances are working.

Fault	Cause and troubleshooting
The appliance is not working.	Electronics fault <ol style="list-style-type: none"> Briefly disconnect the appliance from the power supply by switching off the fuse. Reset the basic settings to the factory settings. → "Basic settings", Page 19
The appliance prompts you again to carry out initial configuration.	There has been a power cut. <ul style="list-style-type: none"> Carrying out initial configuration again
The settings on the appliance cannot be configured.  lights up in the display.	Childproof lock is activated. <ul style="list-style-type: none"> Use the  button to deactivate the childproof lock.
The appliance door cannot be opened;  lights up in the display.	Childproof lock is activated. <ul style="list-style-type: none"> Use the  button to deactivate the childproof lock.
The appliance door cannot be opened;  lights up in the display.	The cleaning function locks the appliance door. <ul style="list-style-type: none"> Allow the appliance to cool down until  goes out in the display. → "Pyrolytic self-cleaning", Page 22
The appliance does not heat up; the display shows the  symbol.	Demo mode is activated. <ul style="list-style-type: none"> Disconnect the appliance from the power supply. Then deactivate demo mode in the basic settings within the next five minutes.
Maximum operating time reached	The maximum cooking time has been reached. To prevent an unwanted permanent operation, the appliance automatically stops heating after several hours if the settings are unchanged. <ul style="list-style-type: none"> Switch off the appliance. You can configure new settings if required. <p>Tip: To prevent the appliance from switching off when you do not want it to, e.g. for an extremely long preparation time, set a cooking time. → "Time-setting options", Page 13</p>
A message with "E" appears in the display, e.g. E0502	Electronics fault <ol style="list-style-type: none"> Press the  button. - If required, reset the time. If the fault was a one-off, the error message disappears. If the error message appears again, call the after-sales service. Quote the exact error message and the E no. of your appliance. → "Customer Service", Page 30
HomeConnect is not working correctly.	Different causes are possible. <ul style="list-style-type: none"> Go to www.home-connect.com.

21.2 Replacing the oven light bulb

If the light in the cooking compartment fails, change the oven light bulb.

Note: Heat-resistant, 40-watt, 230 V halogen bulbs are available from the after-sales service or specialist retailers. Only use these bulbs. Hold the new halogen bulbs only with a clean, dry towel. This increases the service life of the bulb.

WARNING – Risk of burns!

The appliance and its parts that can be touched become hot during use.

- Caution should be exercised here in order to avoid touching heating elements.
- Young children under 8 years of age must be kept away from the appliance.

WARNING – Risk of electric shock!

When changing the bulb, the bulb socket contacts are live.

- Before replacing the bulb, ensure that the appliance is switched off in order to prevent a potential electric shock.
- Also unplug the appliance from the mains or switch off the circuit breaker in the fuse box.

Requirements

- The appliance is disconnected from the power supply.
 - The cooking compartment has cooled down.
 - You have a new halogen bulb to replace the old one.
- Place a tea towel in the cooking compartment to prevent damage.
 - Turn the glass cover anti-clockwise to remove it .

3. Pull out the halogen bulb without turning it ②.

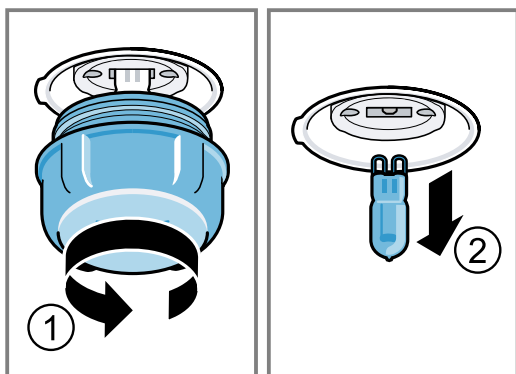

4. Insert the new halogen lamp and press it firmly into the socket.
Make sure the pins are positioned correctly.
5. Depending on the appliance model, the glass cover may have a sealing ring. Put the sealing ring in position.
6. Screw the glass cover on.
7. Take the tea towel out of the cooking compartment.
8. Connect the appliance to the power supply.

22 Disposal

22.1 Disposing of old appliance

Valuable raw materials can be reused by recycling.

1. Unplug the appliance from the mains.
2. Cut through the power cord.
3. Dispose of the appliance in an environmentally friendly manner.
Information about current disposal methods are available from your specialist dealer or local authority.



This appliance is labelled in accordance with European Directive 2012/19/EU concerning used electrical and electronic appliances (waste electrical and electronic equipment - WEEE).

The guideline determines the framework for the return and recycling of used appliances as applicable throughout the EU.

23 Declaration of Conformity

BSH Hausgeräte GmbH hereby declares that the appliance with Home Connect functionality conforms to the basic requirements and other relevant provisions of Directive 2014/53/EU.

A detailed RED Declaration of Conformity can be found online at www.bosch-home.com among the additional documents on the product page for your appliance.

Hereby, BSH Hausgeräte GmbH declares that the appliance with Home Connect functionality is in compliance with relevant statutory requirements.¹

A detailed Declaration of Conformity can be found online at www.bosch-home.co.uk among the additional documents on the product page for your appliance.¹



2.4 GHz band (2400–2483.5 MHz): Max. 100 mW
5-GHz band (5150–5350 MHz + 5470–5725 MHz):
max. 50 mW



BE	BG	CZ	DK	DE	EE	IE	EL	ES
FR	HR	IT	CY	LI	LV	LT	LU	HU
MT	NL	AT	PL	PT	RO	SI	SK	FI
SE	NO	CH	TR	IS	UK (NI)			

5 GHz WLAN (Wi-Fi): For indoor use only.

AL	BA	MD	ME	MK	RS	UK	UA
----	----	----	----	----	----	----	----

5 GHz WLAN (Wi-Fi): For indoor use only.

¹ Only applies to Great Britain

23.1 Statement of Compliance for Great Britain

Product type

This statement of compliance covers the products described in this information for use whose model identifier group is seen on the title page. The full model identifier is made up of the characters before the slash in the product number (E no.) which can be found on the rating plate. Alternatively, you can also find the model identifier in the first line of the UK Energy Label.

Name and address of manufacturer

BSH Hausgeräte GmbH, Carl-Wery-Strasse 34, 81739 München, Germany

This statement of compliance is prepared by the manufacturer.

The manufacturer, BSH Hausgeräte GmbH deems that it has complied with

- provision 5.1-1 of ETSI EN 303 645 v2.1.1 and, where relevant, provision 5.1-2 of ETSI EN 303 645 v2.1.1;
- provision 5.2-1 of ETSI EN 303 645 v2.1.1;
- provision 5.3-13 of ETSI EN 303 645 v2.1.1.

Support period

BSH Hausgeräte GmbH will provide security updates that are necessary to maintain the main functions free of charge until at least 28/02/2034.

24 Customer Service

Function-relevant genuine spare parts according to the corresponding Ecodesign Order can be obtained from Customer Service for a period of at least 10 years from the date on which your appliance was placed on the market within the European Economic Area.

Note: Under the terms of the manufacturer's warranty the use of Customer Service is free of charge.

Detailed information on the warranty period and terms of warranty in your country is available from our after-sales service, your retailer or on our website.

If you contact Customer Service, you will require the product number (E-Nr.) and the production number (FD) of your appliance.

The contact details for Customer Service can be found in the enclosed Customer Service directory or on our website.

This product contains light sources from energy efficiency class G.

24.1 Product number (E-Nr.) and production number (FD)

You can find the product number (E-Nr.) and the production number (FD) on the appliance's rating plate. You will see the rating plate with these numbers if you open the appliance door.

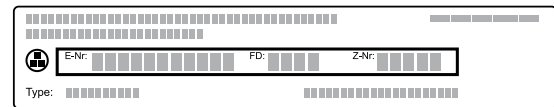

Make a note of your appliance's details and the Customer Service telephone number to find them again quickly.

25 How it works

Here, you can find the ideal settings for various types of food as well as the best accessories and cookware. We have perfectly tailored these recommendations to your appliance.

25.1 Cooking tips

Observe this information when preparing food.

- The temperature and cooking time depend on the amount of food and the recipe. Settings ranges are specified for this reason. Try using the lower values to start with.
- The setting values apply to food placed in the cooking compartment while the cooking compartment is still cold. Do not slide the accessory into the cooking compartment until it has finished preheating.
- Remove any accessories that are not being used from the cooking compartment.

25.2 Notes on baking

When baking, use the shelf positions indicated.

Baking on one level	Height
Deep baked goods or tin on wire rack	2
Flat baked goods or goods in a baking tray	3

Baking on two levels	Height
Universal pan	3
Baking tray	1
Baking tins/dishes on the wire rack:	Height
First wire rack	3
Second wire rack	1

Baking on three levels	Height
Baking tray	5
Universal pan	3
Baking tray	1

Notes

- When baking on several layers, always use hot air. Baked goods that are placed in the oven at the same time will not necessarily be ready at the same time.

- Position baking tins/dishes either next to one another or offset on different shelves so that they are not directly one above the other in the cooking compartment.
- For best results, we recommend using dark-coloured metal bakeware.

25.3 Notes on roasting and grilling

The setting values are based on the assumption that unstuffed, chilled, ready-to-roast poultry, meat or fish is placed into a cold cooking compartment.

ATTENTION!

Acidic food may damage the grid

- ▶ Do not place acidic food, such as fruit or food with an acidic marinade directly on the pan support.
- The larger the poultry, meat or fish, the lower the cooking temperature and the longer the cooking time.
- Turn the poultry, meat or fish after approx. 1/2 to 2/3 of the time listed.
- Add a little liquid to the poultry in the cookware. Cover the bottom of the cookware with approx. 1–2 cm of liquid.
- When you turn poultry, ensure that the breast side or skin side is underneath to begin with.
- Cooking time calculation (e.g. 20 + 35): To calculate the cooking time, assume 20 minutes per 500 g of meat plus an extra 35 minutes. For 1.5 kg, the cooking time is then 95 minutes.
- Cooking time range (e.g. 10–15): Your food will be ready within the specified range of time.

Information for those allergic to nickel

In rare cases, small amounts of nickel may pass into the food.

Roasting and grilling on the wire rack

Roasting on the wire rack works particularly well for large poultry or for multiple pieces at the same time.

- Depending on the size and type of the food to be roasted, add up to 1/2 litre water to the universal pan. You can make a sauce from the juices that are collected. This also means that less smoke is produced and the cooking compartment does not become as dirty.
- Keep the appliance door closed when using the grill. Never grill with the appliance door open.
- Place the food to be grilled on the wire rack. In addition, slide the universal pan in at least one shelf position lower, with the slanted edge facing the appliance door. This means that any dripping fat is caught.

Roasting in cookware

When preparing food in cookware with a lid, the cooking compartment remains cleaner.

Follow the manufacturer's instructions for your roasting dishes. Glass cookware is best.

Cookware without lid

- Use a deep roasting dish.
- Place the cookware onto the wire rack.
- If you do not have any suitable cookware, use the universal pan.

Cookware with lid

- Place the cookware onto the wire rack.
- Meat, poultry and fish can also become crispy in a covered roasting dish. Use a roasting dish with a glass lid. Set a higher temperature.

⚠ WARNING – Risk of injury!

If hot glass cookware is placed on a wet or cold surface, the glass may shatter.



- ▶ Place hot glass ovenware on a dry mat after cooking.

⚠ WARNING – Risk of scalding!

Very hot steam may escape when the lid is opened after cooking. Steam may not be visible, depending on the temperature.

- ▶ Lift the lid in such a way that the hot steam can escape away from you.
- ▶ Keep children away from the appliance.

25.4 Food selection

Food	Accessories/cookware	Shelf position	Type of heating	Temperature in °C/grill setting	Cooking time in mins
Sponge cake, delicate	Loaf tin	2		150-170	60-80
Sponge cake, on 2 levels	Loaf tin	3+1		140-150	70-85
Fruit tart or cheesecake with shortcrust pastry base	Springform cake tin, diameter 26 cm	2		160-180	70-90

¹ Preheat the appliance.























² Turn the dish between halfway and two-thirds through the cooking time.

³ At the start, add liquid to the cookware so that at least 2/3 of the joint is covered in liquid

⁴ Turn the dish 2/3 of the way through the cooking time.

⁵ Do not turn the food. Cover the base with water.

⁶ Slide the universal pan underneath the wire rack.

Food	Accessories/cookware	Shelf position	Type of heating	Temperature in °C/grill setting	Cooking time in mins
Sponge flan, 6 eggs	Springform cake tin Ø 28 cm	2		150-160 ¹	30-40
Swiss roll	Baking tray	3		180-200 ¹	10-15
Shortcrust tart with moist topping	Universal pan	3		170-180	50-60
Yeast cake with moist topping	Universal pan	3		180-200	30-55
Muffins	Muffin tray on wire rack	2		170-190	20-40
Small yeast cakes	Baking tray	3		150-170	20-30
Biscuits	Baking tray	3		140-160	15-25
Biscuits, 2 or 3 levels	Universal pan Baking tray	3+1 5+3+1		140-160	15-25
Bread, 1000 g (in a loaf tin or free-form)	Universal pan Loaf tin	2		200-220	35-50
Pizza, fresh	Baking tray	3		190-210	20-30
Pizza, fresh, thin-crust	Round pizza tray	2		250-270 ¹	8-13
Quiche	Tart dish or tin	1		190-210	40-50
Bake, savoury, cooked ingredients	Ovenproof dish	2		200-220	30-60
Chicken, 1.3 kg, unstuffed	Cookware without lid	2		200-220	60-70
Small chicken portions, 250 g each	Cookware without lid	3		220-230	30-35
Goose, unstuffed, 3 kg	Cookware without lid	2		1. 140 2. 160	1. 130-140 2. 50-60
Joint of pork without rind, e.g. neck, 1.5 kg	Cookware without lid	2		160-170	150-160
Fillet of beef, medium, 1 kg	Pan support Universal pan	3		210-220	40-50 ²
Pot-roasted beef, 1.5 kg	Cookware with lid	2		200-220	130-150 ³
Sirloin, medium, 1.5 kg	Pan support Universal pan	3		200-220	60-70 ²
Burger, 3–4 cm thick	Pan support	4		3	25-30 ⁴
Leg of lamb, boned, medium, 1.0 kg	Cookware without lid	2		170-190	70-80 ⁵
Fish, grilled, whole, 300 g, e.g. trout	Pan support	2		160-180	20-30 ⁶

¹ Preheat the appliance.

² Turn the dish between halfway and two-thirds through the cooking time.

³ At the start, add liquid to the cookware so that at least 2/3 of the joint is covered in liquid

⁴ Turn the dish 2/3 of the way through the cooking time.

⁵ Do not turn the food. Cover the base with water.

⁶ Slide the universal pan underneath the wire rack.

25.5 Steam assistance











If you are using steam-assisted cooking, steam is produced in the cooking compartment. This gives the food a crispy crust and a shiny surface. Furthermore, the food becomes tender and juicy inside and there is only a minimal reduction in its volume.

Recommended settings for steam-assisted cooking

The water tank must always contain the recommended amount of water when placed on the base of the appliance.

Food	Accessory/cookware	Shelf position	Volume of water in ml	Type of heating	Temperature in °C	Cooking time in mins
(White) bread	Loaf tin (1 x 900 g or 2 x 450 g)	2	100		200-210	25-35

¹ Preheat the appliance with the water bowl filled with water.

Food	Accessory/cookware	Shelf position	Volume of water in ml	Type of heating	Temperature in °C	Cooking time in mins
Part-cooked rolls or baguette, pre-baked ¹	Pan support	3	100		190-200	8-10
Victoria sponge cake	2 x cake tin, 20 cm diameter	2	100		150-160	25-35
Light fruit cake	Deep tin, 20 cm diameter	2	150		150-160	70-90
Pizza, frozen, thin-crust, x 1	Pan support	2	100		190-200	15-20
Chicken drumsticks, 150 g each	Cookware without lid	2	100		220-230	20-30
Small chicken portions, 250 g each	Cookware without lid	2	150		220-230	30-40
Chicken, 1.3 kg, unstuffed	Cookware without lid	2	200		200-220	65-75
Pork, gammon joint, 1.5 kg	Cookware without lid	2	250		160-170	120-140
Fish, baked, whole, 300 g, e.g. trout	Cookware without lid	2	100		180-190	25-35
Pizza, baked, reheating ¹	Pan support	2	100		170-180	7-10
Bread rolls, baguette, reheating ¹	Pan support	2	100		150-160	6-8

¹ Preheat the appliance with the water bowl filled with water.

25.6 Yoghurt

You can use your appliance to make your own yoghurt.

Preparing yoghurt

1. Remove the accessories and shelf supports from the cooking compartment.
2. Pour the previously prepared yoghurt mixture into small containers, e.g. into cups or small jars.

3. Cover the containers with foil, e. g. with cling film.
4. Place the containers on the cooking compartment floor.
5. Set the appliance according to the recommended setting.
6. After making the yoghurt, leave it to cool in the refrigerator.

Recommended settings for yoghurt

Food	Accessories/cookware	Shelf position	Type of heating	Temperature in °C	Cooking time in mins
Yoghurt	Individual moulds	Cooking compartment floor		40-45	8-9 hrs

25.7 Slow cooking

Slow cooking is a technique for cooking food over a long period at low temperatures. For this reason, it is also called "low-temperature cooking".







Slow cooking food

Requirements

- Only use fresh, clean and hygienic meat without bones.
- Only start operation when the cooking compartment has fully cooled down.

1. Preheat the cooking compartment and cookware for approx. 15 minutes.
2. Sear the meat on all sides on the cooking zone at a very high heat.
3. Immediately place the meat into the pre-warmed cookware in the cooking compartment.
4. Keep the appliance door closed in order to maintain an even cooking climate.

Recommended settings for slow cooking

Food	Accessories/cook-ware	Shelf position	Type of heating	Searing time in mins	Temperature in °C	Cooking time in mins
Duck breast, 300 g each	Cookware without lid	2		6-8	95 ¹	60-70
Fillet of pork, whole	Cookware without lid	2		4-6	85 ¹	75-100
Beef topside, 6–7 cm thick, 1.5 kg	Cookware without lid	2		6-8	100 ¹	160-220
Fillet of beef, 4–6 cm thick, 1 kg	Cookware without lid	2		6-8	85 ¹	90-150
Veal medallions, 4 cm thick	Cookware without lid	2		4	80 ¹	50-70
Saddle of lamb, boneless, 200 g each	Cookware without lid	2		4	85 ¹	30-70

¹ Preheat the appliance.

25.8 Test dishes

These overviews have been produced for test institutes to facilitate appliance testing in accordance with EN 60350-1.

Baking

Observe this information when baking test dishes.

General information

- The settings apply to food that is placed into a cold cooking compartment.
- Observe the notes about preheating in the tables. These setting values apply without rapid heating.
- When baking, use the lower of the listed temperatures to begin with.

Shelf positions

Shelf positions for baking on two levels:

Note: Items that are placed in the oven on baking trays or in baking tins/dishes at the same time will not necessarily be ready at the same time.

- Universal pan: Level 3
Baking tray: Level 1

- Baking tins/dishes on the wire rack
First wire rack: Level 3
Second wire rack: Level 1

Shelf positions for baking on three levels:





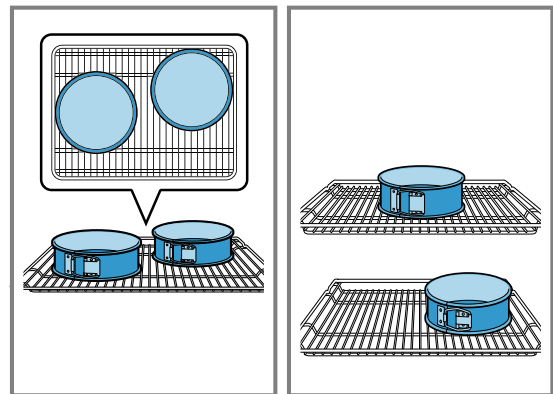

- Baking tray: Level 5
Universal pan: Level 3
Baking tray: Level 1

Baking with two springform cake tins:

Position baking tins/dishes either next to one another or offset on different shelves so that they are not directly one above the other in the cooking compartment.



Recommended settings for baking

Food	Accessories/cook-ware	Shelf position	Type of heating	Temperature in °C	Cooking time in mins
Viennese whirls	Baking tray	3		140-150 ¹	25-35
Viennese whirls	Baking tray	3		140-150 ¹	20-30
Viennese whirls, 2 levels	Universal pan + Baking tray	3 + 1		140-150 ¹	25-35
Viennese whirls, 3 levels	Universal pan + Baking tray	5 + 3 + 1		130-140 ¹	35-55
Small cakes	Baking tray	3		150 ¹	25-35
Small cakes	Baking tray	3		150 ¹	20-30

¹ Preheat the appliance for five minutes. Do not use the rapid heating function.

² Preheat the appliance. Do not use the rapid heating function.

Food	Accessories/cook-ware	Shelf position	Type of heating	Temperature in °C	Cooking time in mins
Small cakes, 2 levels	Universal pan + Baking tray	3 + 1	☼	140 ¹	25-35
Small cakes, 3 levels	Universal pan + Baking tray	5 + 3 + 1	☼	140 ¹	25-35
Hot water sponge cake	Springform cake tin, diameter 26 cm	2	☐	160-170 ²	25-35
Hot water sponge cake	Springform cake tin, diameter 26 cm	2	☼	160-170	30-35
Hot water sponge cake, 2 levels	Springform cake tin, diameter 26 cm	3 + 1	☼	150-160 ²	35-50

¹ Preheat the appliance for five minutes. Do not use the rapid heating function.

² Preheat the appliance. Do not use the rapid heating function.

Recommended settings for grilling

Food	Accessories/cook-ware	Shelf position	Type of heating	Temperature in °C/grill setting	Cooking time in mins
Toasting bread	Pan support	5	☐	3	5-6

26 Installation instructions



Observe this information when installing the appliance.



⚠ 26.1 General installation instructions

Follow these instructions before you start with the installation of the appliance.

- The safe operation of this appliance can only be guaranteed if it has been installed to a professional standard in accordance with these installation instructions. The installer shall be liable for damages incurred as a result of incorrect installation.
- Check the appliance for damage after unpacking it. Do not connect the appliance if it has been damaged in transit.
- Before starting up the appliance, remove any packaging material and adhesive film from the cooking compartment and the door.
- Proceed in accordance with the installation sheets for installing accessories.
- Fitted units must be heat-resistant up to 95 °C, and adjacent unit fronts up to 70 °C.

- Do not install the appliance behind a decorative door or the door of a kitchen unit. There is a risk of overheating.
- Cut-out work on the units should be carried out before installing the appliance. Remove any shavings. Otherwise, the correct operation of electrical components may be adversely affected.
- The mains socket for the appliance must either be located in the hatched area  or outside of the area where the appliance is installed. Any unsecured units must be secured to the wall using a standard bracket .

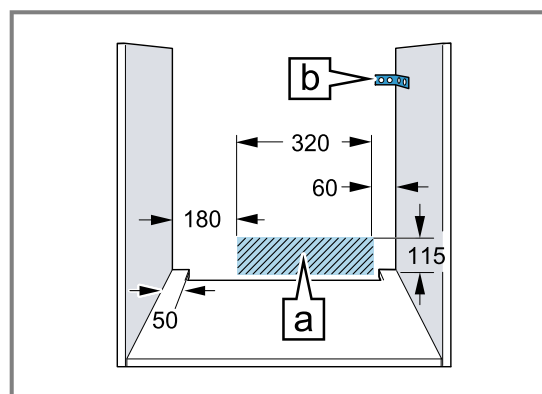

- Wear protective gloves so that you do not cut yourself. Parts that are accessible during installation may have sharp edges.
- Dimensions of the figures in mm.

⚠ WARNING – Risk of fire!

It is dangerous to use an extended power cord and non-approved adapters.

- ▶ Do not use multiple socket strips.
- ▶ Only use extension cables that are certified, have a minimum cross section of 1.5 mm² and comply with the applicable national safety requirements.
- ▶ If the power cord is too short, contact customer service.
- ▶ Only use adapters approved by the manufacturer.

ATTENTION!

Carrying the appliance by the door handle could break it. The door handle cannot support the weight of the appliance.

- ▶ Do not carry or hold the appliance by the door handle.

26.2 Appliance dimensions

You will find the dimensions of the appliance here

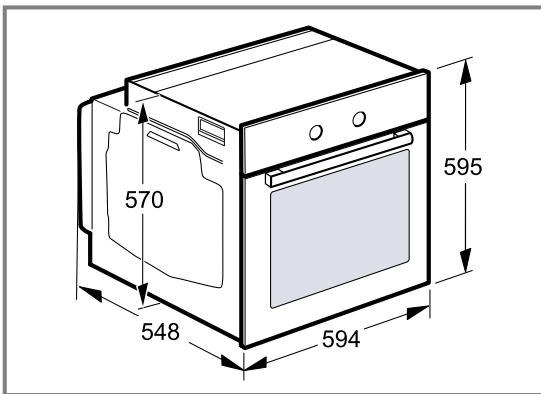

26.3 Installation below a worktop

Observe the installation dimensions and the installation instructions when installing below a worktop.

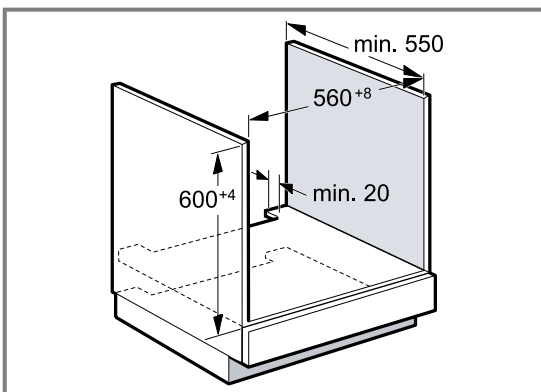

- To ventilate the appliance, the intermediate floor must have a ventilation cut-out.
- In combination with induction hobs, the gap between the worktop and appliance must not be sealed using additional strips.
- The worktop must be secured to the fitted unit.

- Observe any available installation instructions for the hob.
- Observe different national installation instructions for the hob.

26.4 Installation in a tall unit

Observe the installation dimensions and the installation instructions when installing in a tall unit.

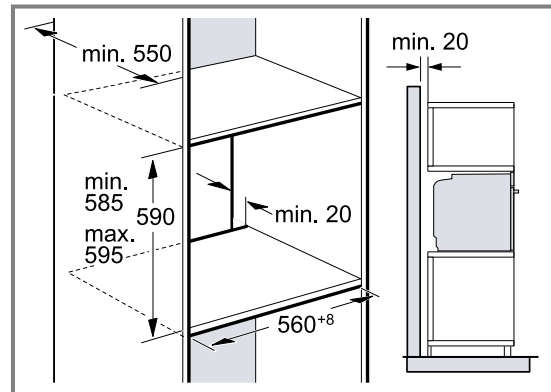

- To ventilate the appliance, the intermediate floors must have a ventilation cut-out.
- If the tall unit has another back panel in addition to the element back panels, this must be removed.
- Only fit the appliance up to a height which allows accessories to be easily removed.

26.5 Installing two appliances on top of each other

Your appliance can also be installed above or below another appliance. Observe the installation dimensions and the installation instructions when installing appliances on top of each other.

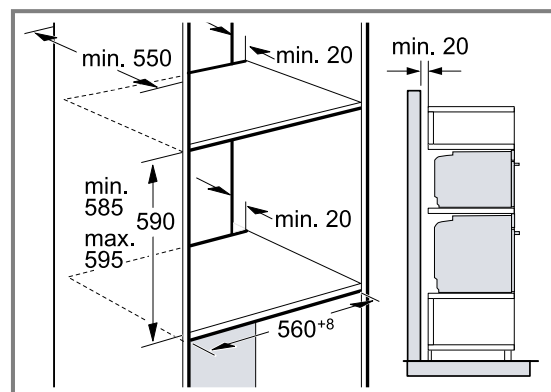

- To ventilate the appliances, the intermediate floor must have a ventilation cut-out.
- To ensure sufficient ventilation of the two appliances, there must be a ventilation opening of at least 200 cm² in the base area. To do this, trim the base panel or fit a ventilation grille.

- Ensure that air exchange is guaranteed in accordance with the diagram.

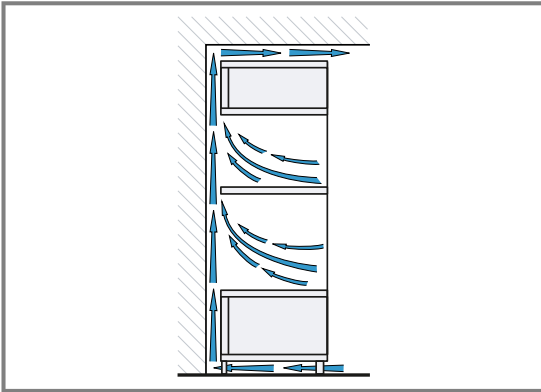

- Only fit appliances up to a height that allows accessories to be easily removed.

26.6 Corner installation

Observe the installation dimensions and the installation instructions when installing in a corner.

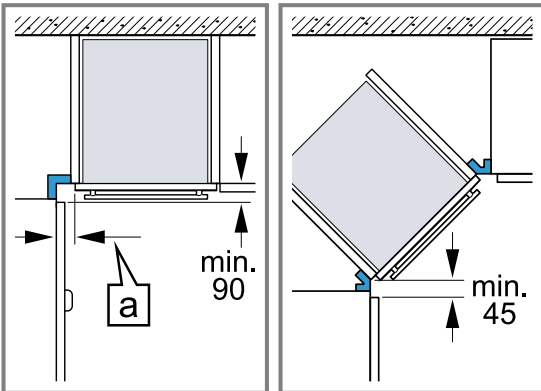

- To ensure that the appliance door can be opened, you must take the minimum dimensions into consideration when installing in a corner. The dimension **a** is dependent on the thickness of the unit front and the handle.

26.7 Electrical connection

In order to safely connect the appliance to the electrical system, follow these instructions.

- The appliance corresponds to protection class I and must only be operated with a protective earth connection.
- The fuse protection must correspond to the power rating specified on the appliance's rating plate and to the local regulations.
- The appliance must be disconnected from the power supply whenever installation work is being carried out.
- The appliance must only be connected using the power cable provided.
- The power cable must be plugged in at the rear of the appliance until you hear a clicking sound. A 3 m power cable can be obtained from the after-sales service.
- The power cable must only be replaced with a cable from the original manufacturer. This is available from after-sales service.

- Contact protection must be guaranteed by the installation.

Electrically connect the appliance with the protective contact plug

Note: The appliance must only be connected to a protective contact socket that has been correctly installed.

- ▶ Insert the plug into the protective contact socket. When the appliance is installed, the mains plug of the power cord must be freely accessible. If free access is not possible, an isolating switch must be integrated into the permanent electrical installation according to the installation regulations.

Electrically connecting an appliance without a protective contact plug

Note: Only licensed specialists may connect the appliance. Damage caused by incorrect connection is not covered under the warranty.

An isolating switch must be integrated into the permanent electrical installation according to the installation regulations.

1. Identify the phase and neutral conductors in the socket. The appliance may be damaged if it is not connected correctly.
2. Connect the hob in accordance with the connection diagram. See the rating plate for the voltage.
3. Connect the wires of the mains power cable according to the colour coding:
 - Green/yellow = Protective conductor \oplus
 - Blue = Neutral conductor
 - Brown = Phase (external conductor)

26.8 Installing the appliance

1. Slide the appliance in fully and centre it.

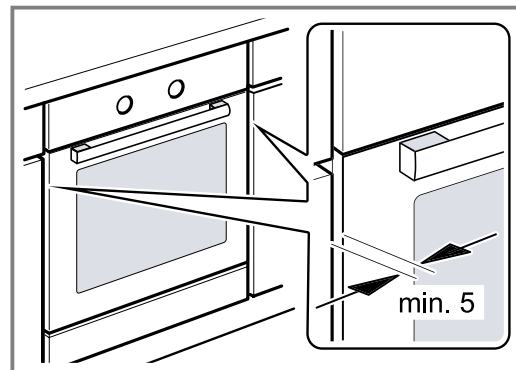

2. Screw the appliance into place.

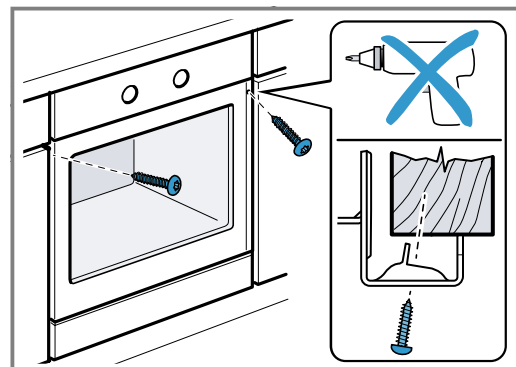

3. For handleless kitchens with vertical bar handle strips:
- Attach a suitable filling piece ① in order to cover any sharp edges and to guarantee a safe installation.
 - Pre-drill aluminium profiles to establish a screw connection ②.
 - Secure the appliance using a suitable screw ③.

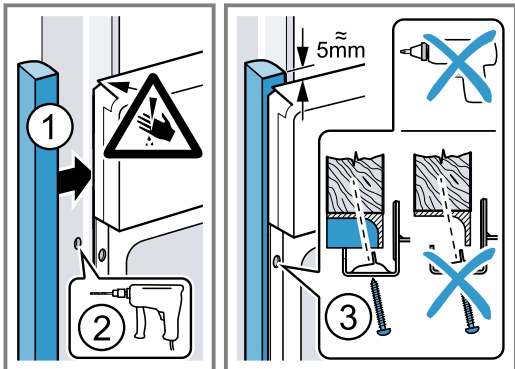

Note: The gap between the worktop and the appliance must not be closed by additional battens. Thermal insulation strips must not be fitted to the side panels of the surround unit.

26.9 Removing the appliance

1. Disconnect the appliance from the power supply.
2. Undo the fastening screws.
3. Lift the appliance slightly and pull it out completely.



A series of horizontal lines spanning the width of the page, providing a template for writing. The lines are evenly spaced and extend from the left margin to the right edge of the page.



Thank you for buying a Bosch Home Appliance!

Register your new device on MyBosch now and profit directly from:

- **Expert tips & tricks for your appliance**
- **Warranty extension options**
- **Discounts for accessories & spare-parts**
- **Digital manual and all appliance data at hand**
- **Easy access to Bosch Home Appliances Service**

Free and easy registration – also on mobile phones:

www.bosch-home.com/welcome

BOSCH
HOME APPLIANCES
SERVICE

Looking for help? You'll find it here.

Expert advice for your Bosch home appliances, help with problems or a repair from Bosch experts.

Find out everything about the many ways Bosch can support you:

www.bosch-home.com/service

Contact data of all countries are listed in the attached service directory.

BSH Hausgeräte GmbH

Carl-Wery-Straße 34
81739 München, GERMANY
www.bosch-home.com

A Bosch Company



9001682680 (040409)

en

Valid within Great Britain:
Imported to Great Britain by
BSH Home Appliances Ltd.
Grand Union House
Old Wolverton Road
Wolverton, Milton Keynes
MK12 5PT
United Kingdom