





# SELF-REPAIR HINTS

[bg]	Съвети за ремонт .....	2
[hr]	Savjeti za popravak.....	29
[cs]	Poznámky k opravě .....	56
[da]	Tip til reparation .....	83
[nl]	Reparatie informatie.....	110
[en]	Self-repair hints.....	137
[et]	Remonditeave.....	164
[fi]	Korjausvinkit.....	191
[fr]	Conseils de réparation .....	218
[de]	Reparatur Hinweise .....	245
[el]	Υποδείξεις επισκευής .....	272
[hu]	Javítási útmutató .....	299
[it]	Consigli di riparazione.....	326
[lv]	Informācija par remontu .....	353
[lt]	Informacija apie remontą .....	380
[no]	Reparasjonstips .....	407
[pl]	Wskazówki naprawy .....	434
[pt]	Dicas de resolução .....	461
[ro]	Indicii pentru reparații.....	488
[sk]	Poznámky k opravám .....	515
[sl]	Nasveti za popravilo.....	542
[es]	Consejos de reparación.....	569
[sv]	Reparationsinformation.....	596
[tr]	Onarım İpuçları .....	623

# Съвети за ремонт - Уред за охлаждане и замразяване

 <b>Относно този документ</b> .....	<b>3</b>	4.8.1 Отстраняване на променлив рафт.....	16
1.1 Важна информация.....	3	4.8.2 Монтиране на променливия рафт.....	16
1.1.1 Цел.....	3	4.9 Смяна на променливия рафт.....	17
1.2 Обяснение на символите.....	3	4.9.1 Отстраняване на променливия рафт.....	17
1.2.1 Нива на опасност.....	3	4.9.2 Монтиране на гъвкавия рафт.....	17
1.2.2 Символи за опасност.....	3	4.10 Смяна на комплекта за закуска.....	18
1.2.3 Структура на предупрежденията.....	4	4.10.1 Премахване на комплекта за закуска.....	18
1.2.4 Общи символи.....	4	4.10.2 Монтиране на комплекта за закуска.....	18
 <b>Безопасност</b> .....	<b>5</b>	4.11 Смяна на табличката за бутилки.....	19
2.1 Общи инструкции за безопасност.....	5	4.11.1 Сваляне на табличката за бутилки.....	19
2.1.1 Всички домашни уреди.....	5	4.11.2 Монтиране на табличката за бутилки.....	19
 <b>Инструменти и помощни средства</b> .....	<b>6</b>	4.12 Смяна на стелажа на вратата.....	20
 <b>Ремонт</b> .....	<b>7</b>	4.12.1 Изваждане на стелажа на вратата.....	20
4.1 Смяна на уплътнителя на вратата.....	7	4.12.2 Монтиране на стелажа на вратата.....	20
4.2 Смяна на дръжката на вратата.....	8	4.13 Смяна на контейнера за замразени хранителни продукти.....	21
4.2.1 Изваждане на дръжката на вратата.....	8	4.13.1 Изваждане на контейнера за замразени хранителни продукти.....	21
4.2.2 Монтиране на дръжката на вратата.....	8	4.13.2 Монтиране на контейнера за замразени хранителни продукти.....	21
4.3 Смяна на горната панта на вратата.....	9	4.14 Смяна на контейнера.....	22
4.3.1 Сваляне на горната панта на вратата.....	9	4.14.1 Изваждане на контейнера.....	22
4.3.2 Монтиране на горната панта на вратата.....	10	4.14.2 Монтиране на контейнера.....	22
4.4 Смяна на горната панта на вратата (врата с дисплей).....	11	4.15 Смяна на разтегателния контейнер.....	23
4.4.1 Сваляне на горната панта на вратата.....	11	4.15.1 Изваждане на разтегателния контейнер.....	23
4.4.2 Монтиране на горната панта на вратата.....	12	4.15.2 Монтиране на разтегателния контейнер.....	23
4.5 Смяна на средната панта на вратата.....	13	4.16 Смяна на LED спот лампата.....	24
4.5.1 Сваляне на средната панта на вратата.....	13	4.16.1 Сваляне на LED спот лампата.....	24
4.5.2 Монтиране на средната панта на вратата.....	13	4.16.2 Монтиране на LED спот лампата.....	24
4.6 Смяна на долната панта на вратата.....	14	4.17 Смяна на LED осветлението отгоре.....	25
4.6.1 Сваляне на долната панта на вратата.....	14	4.17.1 Сваляне на LED осветлението.....	25
4.6.2 Монтиране на долната панта на вратата.....	14	4.17.2 Монтиране на LED осветлението отгоре.....	26
4.7 Смяна на рафта.....	15	4.18 Смяна на LED светлината на страничната лента.....	27
4.7.1 Изваждане на рафта.....	15	4.18.1 Сваляне на LED светлината на страничната лента.....	27
4.7.2 Монтиране на рафта.....	15	4.18.2 Монтиране на LED светлината на страничната лента.....	28
4.8 Смяна на променлив рафт.....	16		

# **i** Относно този документ

## 1.1 Важна информация

### 1.1.1 Цел

Тези съвети за ремонт помагат на потребителя да ремонтира сам уреди в съответствие с регламента за екологосъобразно проектиране на уредите (от 03.2021 г.).

Те съдържат информация как да сменят определени резервни части, включително предупреждения и рискове.

Ако имате някакви въпроси, моля свържете се с нашия отдел за обслужване на клиенти. Носим отговорност за щети, само ако съветите за ремонт са спазени правилно.

## 1.2 Обяснение на символите

### 1.2.1 Нива на опасност

Предупредителните нива се състоят от символ и сигнална дума. Сигналната дума показва сериозността на опасността.





Ниво на предупреждение	Значение
 <b>ОПАСНОСТ</b>	Неспазването на предупредителното съобщение ще доведе до смърт или сериозни наранявания.
 <b>ПРЕДУПРЕЖДЕНИЕ</b>	Неспазването на предупредителното съобщение може да доведе до смърт или сериозни наранявания.
 <b>ВНИМАТЕЛНО</b>	Неспазването на предупредителното съобщение може да доведе до леки наранявания.
<b>ВНИМАНИЕ!</b>	Неспазването на предупредителното съобщение може да доведе до имуществени щети.

Таблица 1: Нива на опасност

### 1.2.2 Символи за опасност

Символите за опасност са символични изображения, които дават индикация за вида опасност.

В този документ се използват следните символи за опасност:

Символ за опасност	Значение
	Общо предупредително съобщение
	Опасност от електрическо напрежение
	Риск от експлозия
	Опасност от порязвания

## **i** Относно този документ





Символ за опасност	Значение
	Опасност от премазване
	Опасност от горещи повърхности
	Опасност от силно магнитно поле
	Опасност от нейонизиращо лъчение

Таблица 2: Символи за опасност

### 1.2.3 Структура на предупрежденията

Предупрежденията в този документ имат стандартизиран външен вид и стандартизирана структура.

	<p><b>ОПАСНОСТ</b></p> <p><b>Вид и източник на опасността!</b> Възможни последици от игнориране на опасността/предупреждението.</p> <ul style="list-style-type: none"> <li>▶ Мерки и забрани за предотвратяване на опасността.</li> </ul>
--	---

Следният пример показва предупреждение, което уведомява за токов удар, предизвикан от части под напрежение. Споменава се мярката за избягване на опасността.

	<p><b>ОПАСНОСТ</b></p> <p><b>Риск от токов удар поради части под напрежение!</b> Смърт от токов удар</p> <ul style="list-style-type: none"> <li>▶ Изключете уредите от електрическото захранване поне 60 секунди преди започване на ремонта.</li> </ul>
--	---

### 1.2.4 Общи символи

В този документ се използват следните общи символи:







Общ символ	Значение
	Идентифициране на специален съвет (текст и/или графика)
	Идентифициране на прост съвет (само текст)
	Идентифициране на връзка към видео урок
	Идентифициране на необходимите инструменти
	Идентифициране на необходимите предварителни условия
	Идентифициране на условие (ако ..., тогава ...)
	Идентифициране на резултат
Старт	Идентифициране на ключ или бутон
[00123456]	Идентифициране на каталожен номер
Статус	Идентифициране на показания текст/прозорец (на дисплея на уреда)

Таблица 3: Общи символи

## **2.1 Общи инструкции за безопасност**

### **2.1.1 Всички домашни уреди**

#### **Риск от токов удар поради части под напрежение!**

- Грешки при ремонти, включващи електрически компоненти, могат да доведат до токов удар!
- Разкачете уреда от електрическата мрежа за поне 60 секунди, преди да започнете работа.
- След ремонта трябва да се извърши проверка за безопасност съгласно VDE 0701 или в съответствие със специфичните за страната разпоредби.

#### **Риск от нараняване от остри ръбове!**

- Носете предпазни ръкавици.

#### **Риск от премазване по време на ремонт, поддръжка, отстраняване на неизправности и сервиз поради тежки и движещи се компоненти**

- Носете защитни обувки.
- Закрепете тежките компоненти, така че да не паднат.
- Не позволявайте контакт на части от тялото с движещи се компоненти.

#### **Риск за безопасността/функцията на уреда!**

- Използвайте само оригинални резервни части.

#### **Риск от повреда на електростатично чувствителни компоненти (ESD)!**

- Не докосвайте модулите, включително връзки и проводникови пътища.

## Инструменти и помощни средства

посочване	Подробности	Изображения
Защитна кърпа [00342013]	60 см x 50 см	
Комплект накрайници за отвертка [00341820]	9 накрайника, 2,0 mm, 2,4 mm, 3,0 mm, PH0, PH00, PH1, TX6, TX8, TX9	
Помощен инструмент [00342180]	Инструмент за разхлабване на пластмасови части "magic tool"	
Смукателна чаша [00342224]	Ø 50 mm	
Накрайник Torx TX20 [00340865]	6,3 mm (1/4")	
Плоска отвертка	Врърх 10 mm x 1,6 mm x 200 mm	



#### 4.1 Смяна на уплътнителя на вратата

**Изискване:**



- Вратата е отворена.

## 4.2 Смяна на дръжката на вратата

### Специални инструменти:

-  Накрайник Torx TX20      6,3 мм (1/4")      [00340865]
-  Плоска отвертка      Врѝх 10 мм x 1,6 мм x 200 мм

### Изискване:

-  Уредѝт е изключен от захранването.
-  Вратата е отворена.

### 4.2.1 Изваждане на дръжката на вратата

- ▶ 1. Свалете двете капачки на винтовете (1).
- ▶ 2. Развийте двата винта (2).
- ▶ 3. Свалете дръжката на вратата (3).

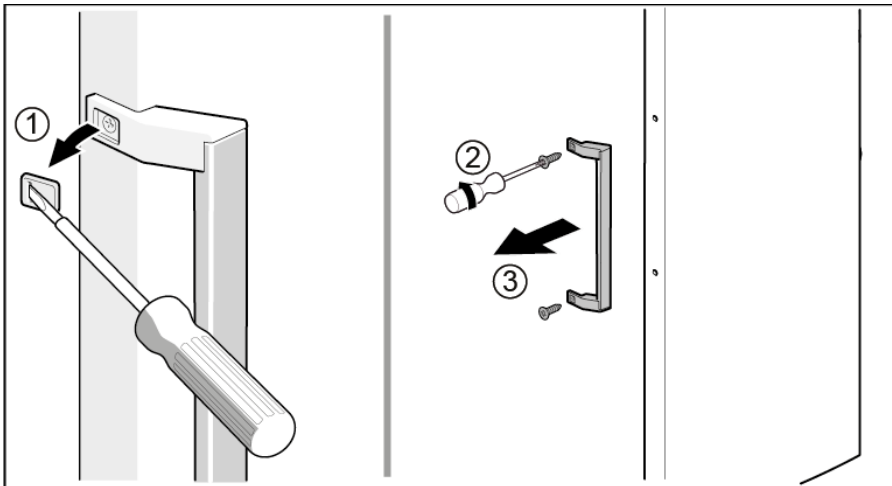

 Дръжката на вратата е свалена.



Дръжката на втората врата може да бъде свалена по същия начин.

### 4.2.2 Монтиране на дръжката на вратата

- ▶ Монтирайте в обратен ред.

### 4.3 Смяна на горната панта на вратата

Специални инструменти:

 Накрайник Torx TX20      6,3 мм (1/4")      [00340865]

	<b>⚠ ПРЕДУПРЕЖДЕНИЕ</b>
	<p><b>Тежки, обемисти уреди!</b> Травми на гърба и мускулите</p> <ul style="list-style-type: none"> <li>▶ Операцията по отстраняване на вратите на уреда трябва да се извършва само от обучени специалисти.</li> <li>▶ За преместването на уреда са необходими двама души.</li> <li>▶ Използвайте само подходящи инструменти и оборудване.</li> </ul>



	<b>⚠ ВНИМАТЕЛНО</b>
	<p><b>Остри ръбове!</b> Наранявания от порязване</p> <ul style="list-style-type: none"> <li>▶ Носете предпазни ръкавици.</li> </ul>

	<b>⚠ ПРЕДУПРЕЖДЕНИЕ</b>
	<p><b>Приплъзване на наклонени уреди!</b> Костни фрактури/наранявания от премазване</p> <ul style="list-style-type: none"> <li>▶ Укрепете уредите срещу приплъзване.</li> </ul>

	<b>⚠ ВНИМАТЕЛНО</b>
	<p><b>Риск от падащи части поради разхлабени винтове!</b> Нараняване поради падащи части.</p> <ul style="list-style-type: none"> <li>▶ Закрепете компонента, така че да не падне.</li> </ul>

	<b>ВНИМАНИЕ!</b>
	<p><b>Риск от падащи части поради разхлабени винтове!</b> Повреда на други части на уреда или в дома на клиента, напр. дъното.</p> <ul style="list-style-type: none"> <li>▶ Закрепете компонента, така че да не падне.</li> </ul>

Изискване:

-  Уредът е изключен от захранването.
-  Вътрешните фитинги на уреда са отстранени.

#### 4.3.1 Сваляне на горната панта на вратата

1. Поставете уреда легнал на задната си страна.

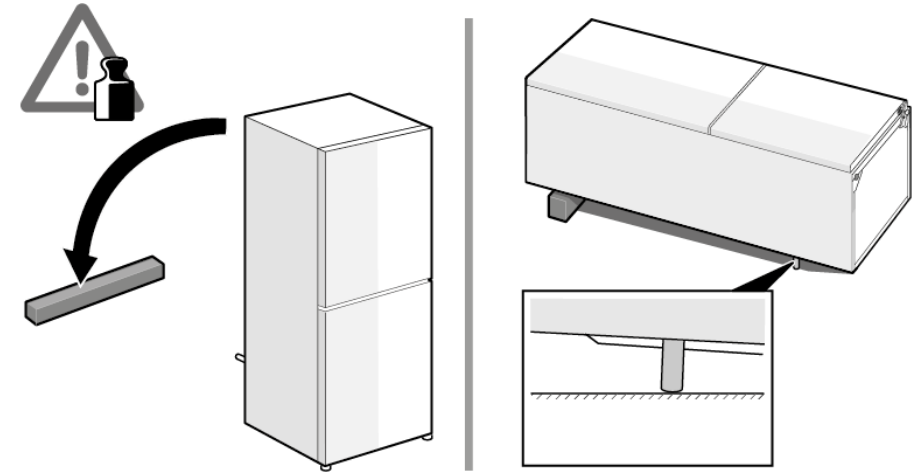

2. 1. Натиснете капачето на горната панта от двете страни (1).
2. Извадете капачето на горната панта (2).
3. Завъртете капачето на пантата (3).
4. Свалете капачето на горната панта (4).
5. Развийте двата винта (5).
6. Свалете горната панта (6)/

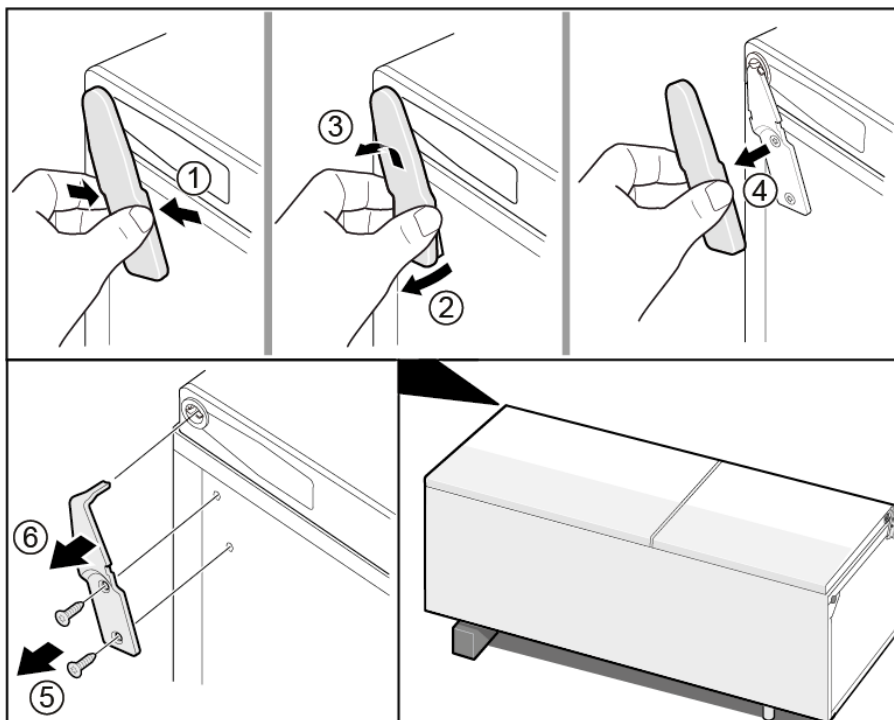

 Горната панта е свалена.

#### 4.3.2 Монтиране на горната панта на вратата

- ▶ Монтирайте в обратен ред.

## 4.4 Смяна на горната панта на вратата (врата с дисплей)

Специални инструменти:

 Накрайник Torx TX20      6,3 мм (1/4")      [00340865]

	<b>⚠ ПРЕДУПРЕЖДЕНИЕ</b>
	<p><b>Тежки, обемисти уреди!</b> Травми на гърба и мускулите</p> <ul style="list-style-type: none"> <li>▶ Операцията по отстраняване на вратите на уреда трябва да се извършва само от обучени специалисти.</li> <li>▶ За преместването на уреда са необходими двама души.</li> <li>▶ Използвайте само подходящи инструменти и оборудване.</li> </ul>

	<b>⚠ ВНИМАТЕЛНО</b>
	<p><b>Остри ръбове!</b> Наранявания от порязване</p> <ul style="list-style-type: none"> <li>▶ Носете предпазни ръкавици.</li> </ul>

	<b>⚠ ПРЕДУПРЕЖДЕНИЕ</b>
	<p><b>Приплъзване на наклонени уреди!</b> Костни фрактури/наранявания от премазване</p> <ul style="list-style-type: none"> <li>▶ Укрепете уредите срещу приплъзване.</li> </ul>



	<b>⚠ ВНИМАТЕЛНО</b>
	<p><b>Риск от падащи части поради разхлабени винтове!</b> Нараняване поради падащи части.</p> <ul style="list-style-type: none"> <li>▶ Закрепете компонента, така че да не падне.</li> </ul>

	<b>ВНИМАНИЕ!</b>
	<p><b>Риск от падащи части поради разхлабени винтове!</b> Повреда на други части на уреда или в дома на клиента, напр. дъното.</p> <ul style="list-style-type: none"> <li>▶ Закрепете компонента, така че да не падне.</li> </ul>

	<b>⚠ ОПАСНОСТ</b>
	<p><b>Риск от токов удар поради части под напрежение!</b> Опасност за живота от токов удар в случай на неправилен ремонт</p> <ul style="list-style-type: none"> <li>▶ Електрическите части трябва да се ремонтират от квалифицирани електротехници.</li> <li>▶ След ремонта трябва да се извърши проверка за безопасност съгласно VDE 0701 или в съответствие със специфичните за страната разпоредби.</li> </ul>

	<b>⚠ ОПАСНОСТ</b>
	<p><b>Риск от токов удар поради части под напрежение!</b> Смърт от токов удар</p> <ul style="list-style-type: none"> <li>▶ Изключете уредите от електрическото захранване поне 60 секунди преди започване на ремонта.</li> </ul>

Изискване:

-  Уредът е изключен от захранването.
-  Вътрешните фитинги на уреда са отстранени.

### 4.4.1 Сваляне на горната панта на вратата

1. Поставете уреда легнал на задната си страна.

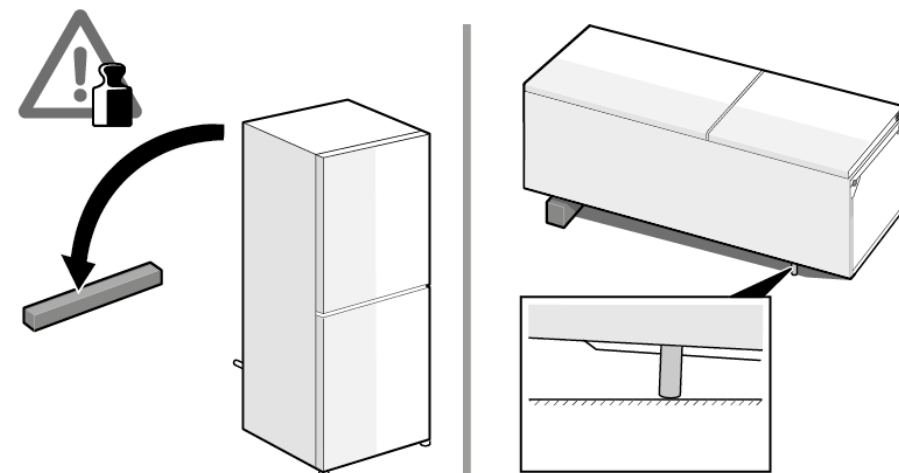

2. 1. Свалете капачето на горната панта (1).
2. Свалете капака на кабелната кутия (2).
3. Изключете електрическата връзка (3).
4. Развийте винта за заземяващата връзка (4).
5. Свалете кабелната защита (5).
6. Развийте винта (6).

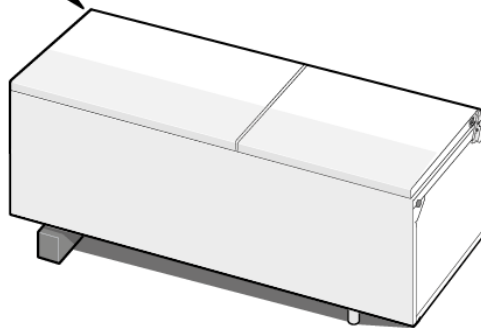
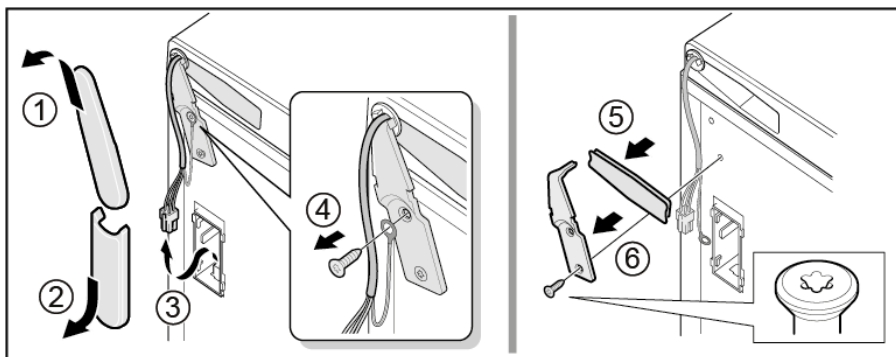

➡ Горната панта е свалена.

#### 4.4.2 Монтиране на горната панта на вратата

- ▶ Монтирайте в обратен ред.

## 4.5 Смяна на средната панта на вратата

Специални инструменти:

 Накрайник Torx TX20      6,3 мм (1/4")      [00340865]

	<b>⚠ ПРЕДУПРЕЖДЕНИЕ</b>
	<p><b>Тежки, обемисти уреди!</b> Травми на гърба и мускулите</p> <ul style="list-style-type: none"> <li>▶ Операцията по отстраняване на вратите на уреда трябва да се извършва само от обучени специалисти.</li> <li>▶ За преместването на уреда са необходими двама души.</li> <li>▶ Използвайте само подходящи инструменти и оборудване.</li> </ul>



	<b>⚠ ВНИМАТЕЛНО</b>
	<p><b>Остри ръбове!</b> Наранявания от порязване</p> <ul style="list-style-type: none"> <li>▶ Носете предпазни ръкавици.</li> </ul>

	<b>⚠ ПРЕДУПРЕЖДЕНИЕ</b>
	<p><b>Приплъзване на наклонени уреди!</b> Костни фрактури/наранявания от премазване</p> <ul style="list-style-type: none"> <li>▶ Укрепете уредите срещу приплъзване.</li> </ul>

	<b>⚠ ВНИМАТЕЛНО</b>
	<p><b>Риск от падащи части поради разхлабени винтове!</b> Нараняване поради падащи части.</p> <ul style="list-style-type: none"> <li>▶ Закрепете компонента, така че да не падне.</li> </ul>

	<b>ВНИМАНИЕ!</b>
	<p><b>Риск от падащи части поради разхлабени винтове!</b> Повреда на други части на уреда или в дома на клиента, напр. дъното.</p> <ul style="list-style-type: none"> <li>▶ Закрепете компонента, така че да не падне.</li> </ul>

Изискване:

-  Уредът е изключен от захранването.
-  Вътрешните фитинги на уреда са отстранени.
-  Горната панта на вратата е свалена.

 Горната врата е отстранена.

### 4.5.1 Сваляне на средната панта на вратата

- ▶ 1. Свалете вратата на хладилното отделение (1).
- ▶ 2. Развийте двата винта (2).
- ▶ 3. Свалете средната панта (3).

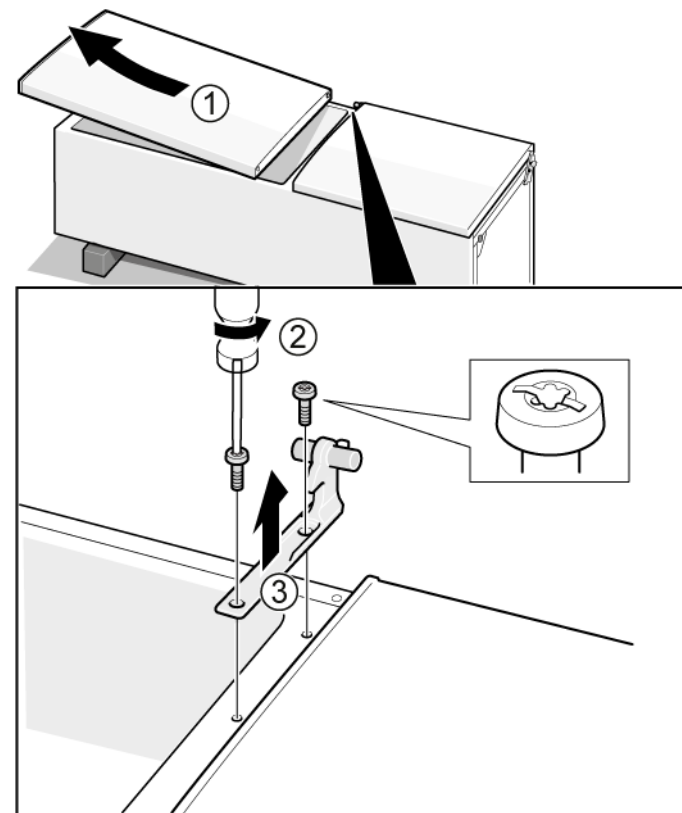

 Средната панта е свалена.

### 4.5.2 Монтиране на средната панта на вратата

- ▶ Монтирайте в обратен ред.

## 4.6 Смяна на долната панта на вратата

Специални инструменти:

 Накрайник Torx TX20      6,3 мм (1/4")      [00340865]

	<b>⚠ ПРЕДУПРЕЖДЕНИЕ</b>
	<p><b>Тежки, обемисти уреди!</b> Травми на гърба и мускулите</p> <ul style="list-style-type: none"> <li>▶ Операцията по отстраняване на вратите на уреда трябва да се извършва само от обучени специалисти.</li> <li>▶ За преместването на уреда са необходими двама души.</li> <li>▶ Използвайте само подходящи инструменти и оборудване.</li> </ul>



	<b>⚠ ВНИМАТЕЛНО</b>
	<p><b>Остри ръбове!</b> Наранявания от порязване</p> <ul style="list-style-type: none"> <li>▶ Носете предпазни ръкавици.</li> </ul>

	<b>⚠ ПРЕДУПРЕЖДЕНИЕ</b>
	<p><b>Приплъзване на наклонени уреди!</b> Костни фрактури/наранявания от премазване</p> <ul style="list-style-type: none"> <li>▶ Укрепете уредите срещу приплъзване.</li> </ul>

	<b>⚠ ВНИМАТЕЛНО</b>
	<p><b>Риск от падащи части поради разхлабени винтове!</b> Нараняване поради падащи части.</p> <ul style="list-style-type: none"> <li>▶ Закрепете компонента, така че да не падне.</li> </ul>

	<b>ВНИМАНИЕ!</b>
	<p><b>Риск от падащи части поради разхлабени винтове!</b> Повреда на други части на уреда или в дома на клиента, напр. дъното.</p> <ul style="list-style-type: none"> <li>▶ Закрепете компонента, така че да не падне.</li> </ul>

Изискване:

-  Уредът е изключен от захранването.
-  Вътрешните фитинги на уреда са отстранени.
-  Горната панта е свалена.

 Средната панта е свалена.

### 4.6.1 Сваляне на долната панта на вратата

- ▶ 1. Свалете вратата на фризерното отделение (1).
- ▶ 2. Развийте винта (2).
- ▶ 3. Извъртете долната панта навън (3).
- ▶ 4. Свалете долната панта (4).

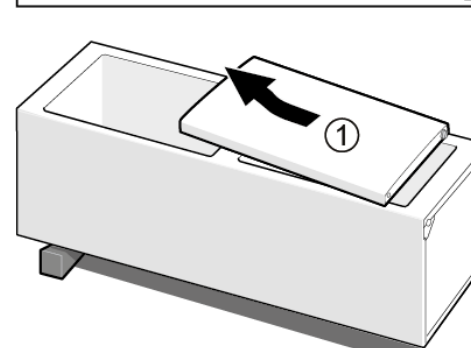
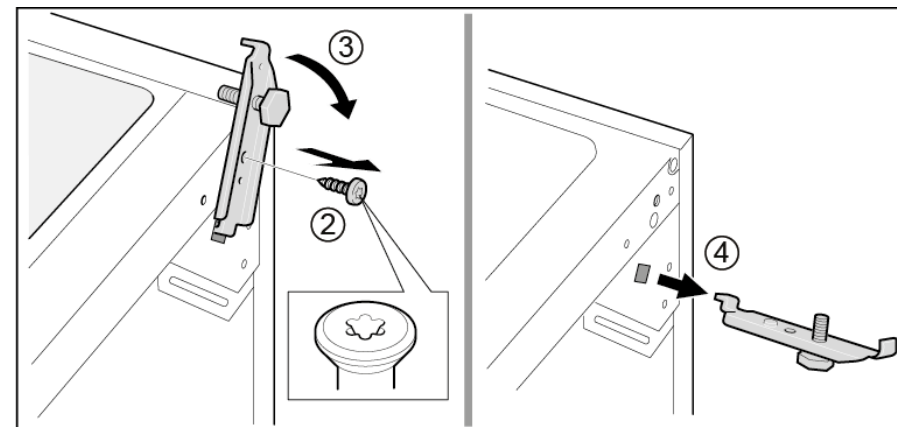

 Долната панта на вратата е свалена.

### 4.6.2 Монтиране на долната панта на вратата

- ▶ Монтирайте в обратен ред.

## 4.7 Смяна на рафта

### Изискване:

- ✔ Вратата е отворена.

### 4.7.1 Изваждане на рафта

- ▶ Издърпайте рафта.

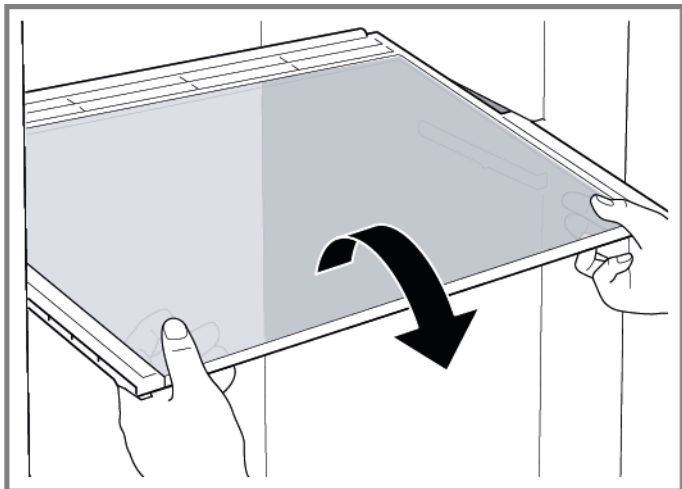

- ➡ Рафтът е свален.

### 4.7.2 Монтиране на рафта

- ▶ Монтирайте в обратен ред.

## 4.8 Смяна на променлив рафт

### Изискване:

- ✔ Вратата е отворена.

### 4.8.1 Отстраняване на променлив рафт

1. Издърпайте дясната секция на променливия рафт напред (1).
2. Отстранете дясната секция на променливия рафт (2).

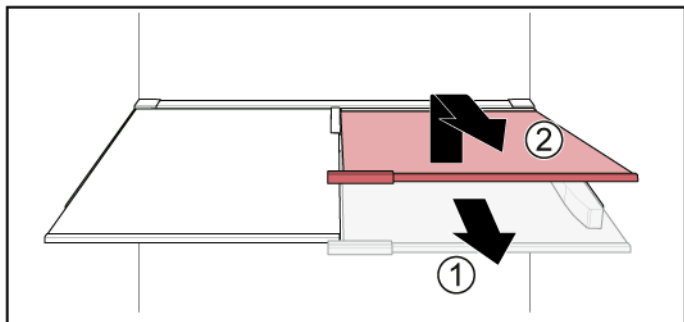

2. Отстранете лявата секция на променливия рафт по същия начин.

- ➡ Променливият рафт е отстранен.

### 4.8.2 Монтиране на променливия рафт

- ▶ Монтирайте в обратен ред.

## 4.9 Смяна на променливия рафт

Изискване:

- ✔ Вратата е отворена.

### 4.9.1 Отстраняване на променливия рафт

- ▶ 1. Отстранете стъкления рафт (1).
- ▶ 2. Повдигнете гъвкавия рафт и го издърпайте навън (2).

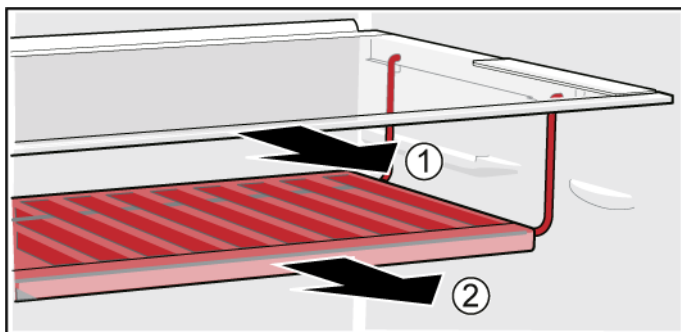

- ➡ Гъвкавият рафт е отстранен.

### 4.9.2 Монтиране на гъвкавия рафт

- ▶ Монтирайте в обратен ред.

## 4.10 Смяна на комплекта за закуска

### Изискване:

- ✔ Вратата е отворена.

### 4.10.1 Премахване на комплекта за закуска

- ▶ Вдигнете комплекта за закуска и го извадете.

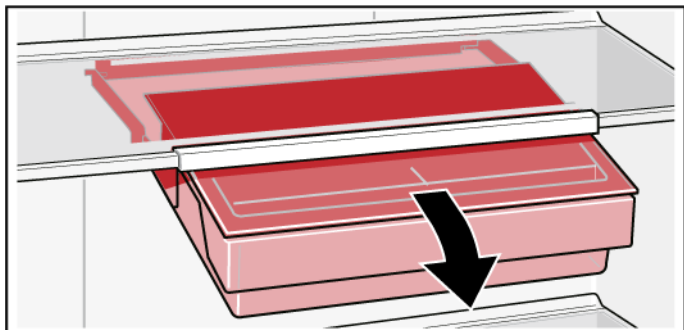

- ➡ Комплектът за закуска е отстранен.

### 4.10.2 Монтиране на комплекта за закуска

- ▶ Монтирайте в обратен ред.

## 4.11 Смяна на табличката за бутилки

### Изискване:

- ✔ Вратата е отворена.

### 4.11.1 Сваляне на табличката за бутилки

- ▶ Издърпайте табличката за бутилки.

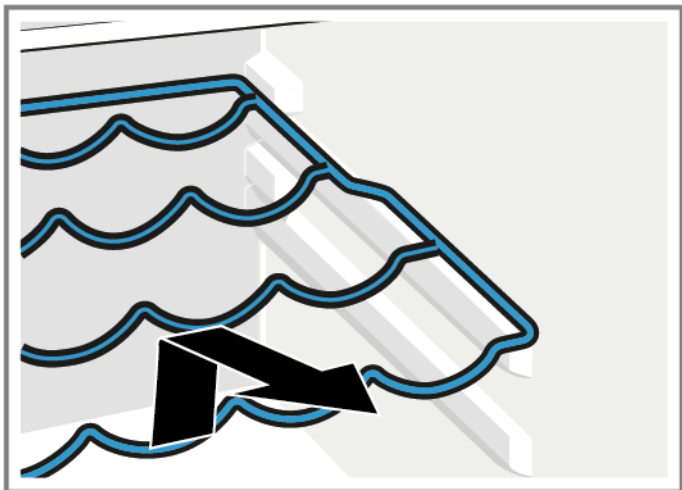

- ➡ Табличката за бутилки е свалена.

### 4.11.2 Монтиране на табличката за бутилки

- ▶ Монтирайте в обратен ред.

## 4.12 Смяна на стелажа на вратата

### Изискване:

- ✔ Вратата е отворена.

### 4.12.1 Изваждане на стелажа на вратата

- ▶ Повдигнете стелажа на вратата нагоре.

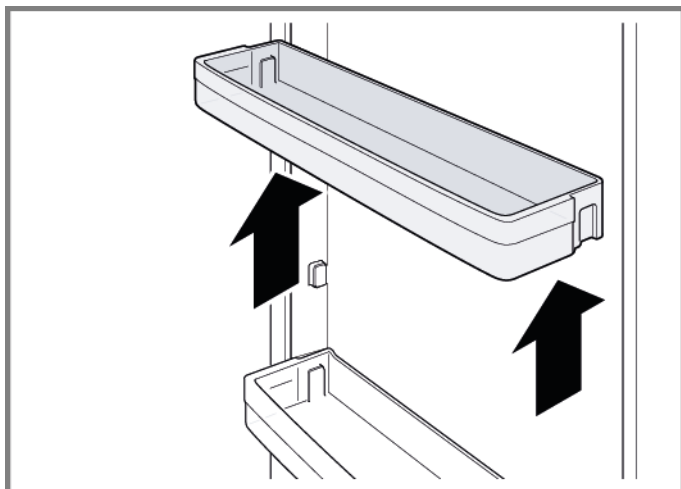

- ➡ Стелажът на вратата е свален.

### 4.12.2 Монтиране на стелажа на вратата

- ▶ Монтирайте в обратен ред.

## 4.13 Смяна на контейнера за замразени хранителни продукти

### Изискване:

- ✔ Вратата е отворена.

### 4.13.1 Изваждане на контейнера за замразени хранителни продукти

- ▶ 1. Издърпайте докрай контейнера за замразени хранителни продукти (1).
- ▶ 2. Извадете контейнера за хранителни продукти (2).

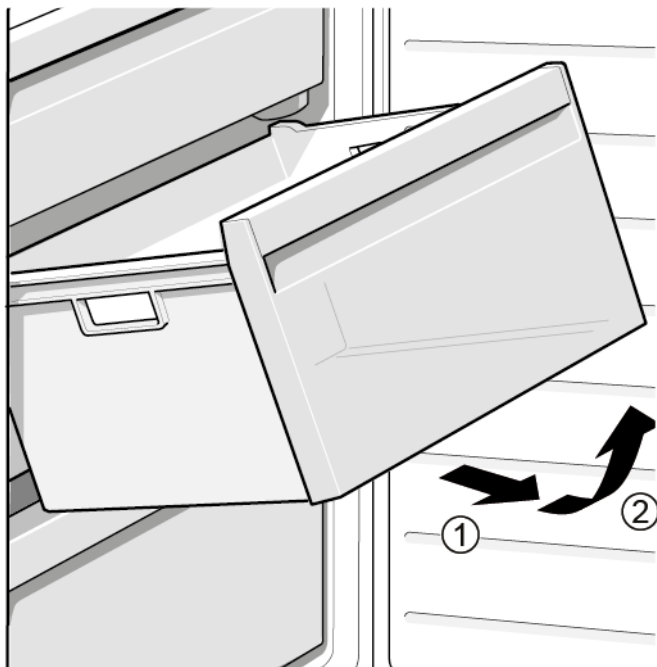

- ➡ Контейнерът за замразени хранителни продукти е изваден.

### 4.13.2 Монтиране на контейнера за замразени хранителни продукти

- ▶ Монтирайте в обратен ред.

## 4.14 Смяна на контейнера

### Изискване:

- ✔ Вратата е отворена.

### 4.14.1 Изваждане на контейнера

- ▶ 1. Преместете долния контейнер на хладилника (1).
- ▶ 2. Преместете горния контейнер на хладилника (2).

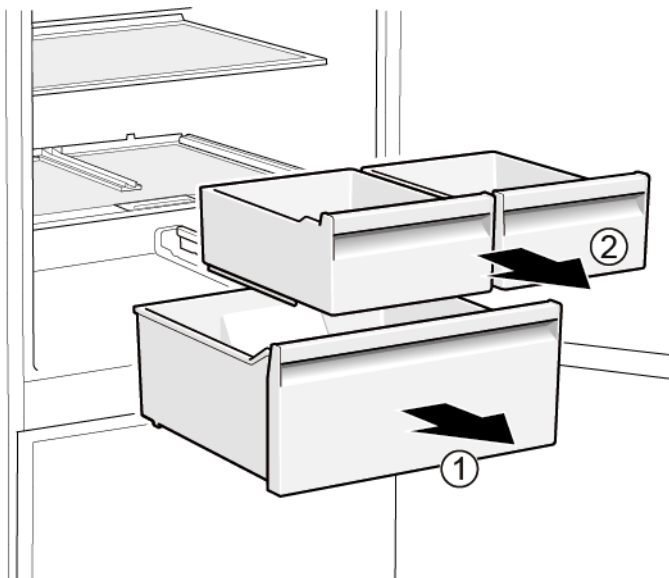

- ➡ Контейнерите са извадени.

### 4.14.2 Монтиране на контейнера

- ▶ Монтирайте в обратен ред.

## 4.15 Смяна на разтегателния контейнер

### Изискване:

- ✔ Вратата е отворена.

### 4.15.1 Изваждане на разтегателния контейнер

- ▶ 1. Издърпайте напълно разтегателния контейнер (1).
- ▶ 2. Извадете разтегателния контейнер (2).

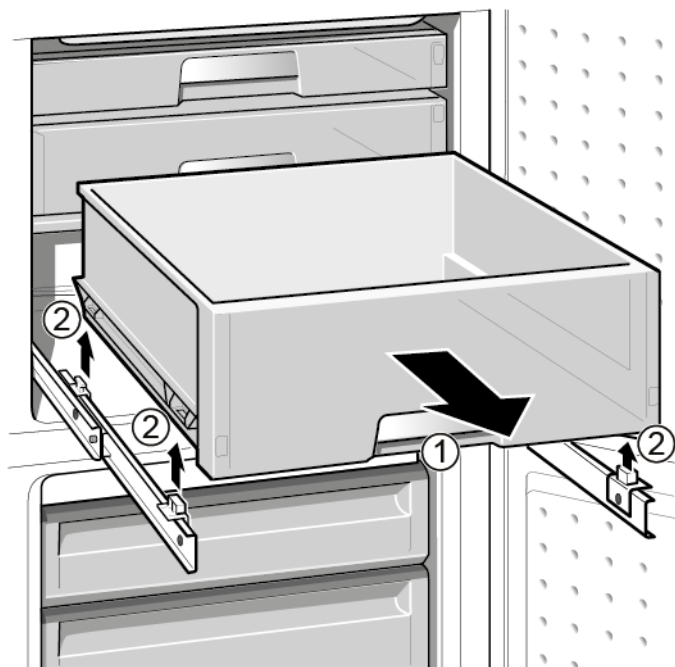

- ➡ Разтегателният контейнер е изваден.

### 4.15.2 Монтиране на разтегателния контейнер

- ▶ Монтирайте в обратен ред.

## 4.16 Смяна на LED спот лампата

### Специални инструменти:

Специален инструмент

[00342180]



Вашият уред е снабден с LED осветление, което не изисква поддръжка.

Това осветление може да бъде ремонтирано само от специалисти от службата за обслужване на клиенти или от квалифицирани техници!



### ОПАСНОСТ

#### Риск от токов удар поради части под напрежение!

Опасност за живота от токов удар в случай на неправилен ремонт

- ▶ Електрическите части трябва да се ремонтират от квалифицирани електротехници.
- ▶ След ремонта трябва да се извърши проверка за безопасност съгласно VDE 0701 или в съответствие със специфичните за страната разпоредби.



### ОПАСНОСТ

#### Риск от токов удар поради части под напрежение!

Смърт от токов удар

- ▶ Изключете уредите от електрическото захранване поне 60 секунди преди започване на ремонта.



### ВНИМАТЕЛНО

#### Остри ръбове!

Наранявания от порязване

- ▶ Носете предпазни ръкавици.

### Изискване:

- ✔ Уредът е изключен от захранването.
- ✔ Вратата е отворена.

## 4.16.1 Сваляне на LED спот лампата

1. Използвайте специален инструмент, за да извадите LED спот лампата (1).

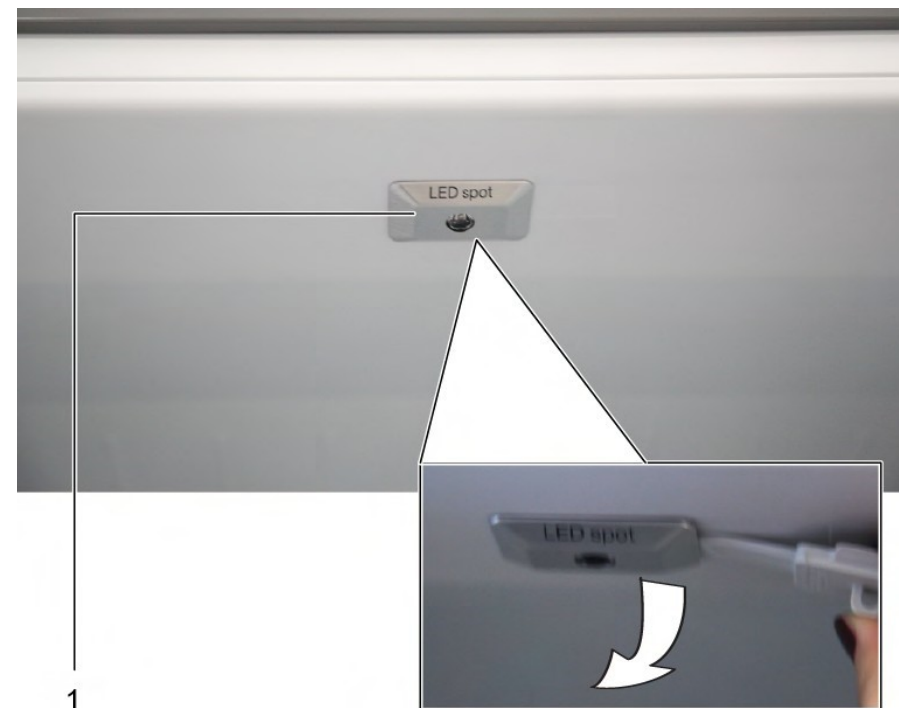

2. Изключете електрическите връзки на LED спот лампата.

LED спот лампата е свалена.

## 4.16.2 Монтиране на LED спот лампата

- ▶ Монтирайте в обратен ред.



## 4.17 Смяна на LED осветлението отгоре



### Специални инструменти:

-  Плоска отвертка      Врѝх 2,4 мм x 0,4 мм x 60 мм, в комплекта [00341820]



	<p>Вашият уред е снабден с LED осветление, което не изисква поддръжка.</p> <p>Това осветление може да бъде ремонтирано само от специалисти от службата за обслужване на клиенти или от квалифицирани техници!</p>
---	---

	 <b>ОПАСНОСТ</b>
	<p><b>Риск от токов удар поради части под напрежение!</b></p> <p>Опасност за живота от токов удар в случай на неправилен ремонт</p> <ul style="list-style-type: none"> <li>▶ Електрическите части трябва да се ремонтират от квалифицирани електротехници.</li> <li>▶ След ремонта трябва да се извърши проверка за безопасност съгласно VDE 0701 или в съответствие със специфичните за страната разпоредби.</li> </ul>

	 <b>ОПАСНОСТ</b>
	<p><b>Риск от токов удар поради части под напрежение!</b></p> <p>Смърт от токов удар</p> <ul style="list-style-type: none"> <li>▶ Изключете уредите от електрическото захранване поне 60 секунди преди започване на ремонта.</li> </ul>

	 <b>ВНИМАТЕЛНО</b>
	<p><b>Остри ръбове!</b></p> <p>Наранявания от порязване</p> <ul style="list-style-type: none"> <li>▶ Носете предпазни ръкавици.</li> </ul>

### Изискване:

-  Уредът е изключен от захранването.
-  Вратата е отворена.
-  Горните вътрешни фитинги се отстраняват.

### 4.17.1 Сваляне на LED осветлението

1. Преместете LED осветлението наляво.

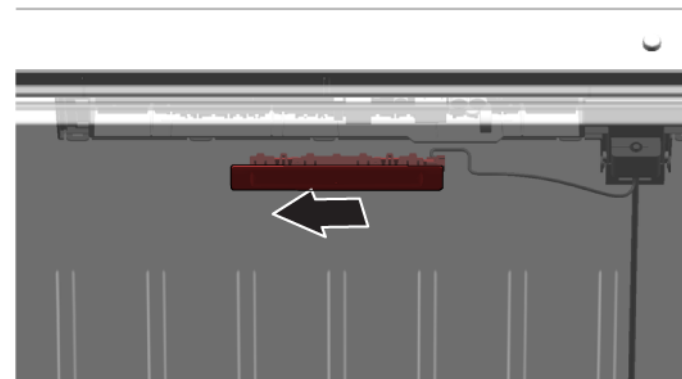

-  Свързването към електрическата мрежа на LED осветлението е прекъснато.

2. Освободете куките на LED осветлението.

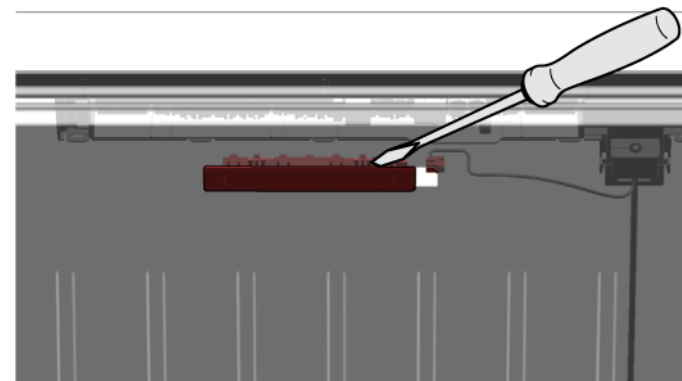

3. Свалете LED осветлението, придвижвайки го напред.



- ➡ LED осветлението е свалено.

#### 4.17.2 Монтиране на LED осветлението отгоре

- ▶ Монтирайте в обратен ред.

## 4.18 Смяна на LED светлината на страничната лента



### Специални инструменти:

 Смукателна чаша Ø50 мм [00342224]



	<p>Вашият уред е снабден с LED осветление, което не изисква поддръжка.</p> <p>Това осветление може да бъде ремонтирано само от специалисти от службата за обслужване на клиенти или от квалифицирани техници!</p>
---	---

	<p style="text-align: center;"> <b>ОПАСНОСТ</b></p> <p><b>Риск от токов удар поради части под напрежение!</b></p> <p>Опасност за живота от токов удар в случай на неправилен ремонт</p> <ul style="list-style-type: none"> <li>▶ Електрическите части трябва да се ремонтират от квалифицирани електротехници.</li> <li>▶ След ремонта трябва да се извърши проверка за безопасност съгласно VDE 0701 или в съответствие със специфичните за страната разпоредби.</li> </ul>
--	---

	<p style="text-align: center;"> <b>ОПАСНОСТ</b></p> <p><b>Риск от токов удар поради части под напрежение!</b></p> <p>Смърт от токов удар</p> <ul style="list-style-type: none"> <li>▶ Изключете уредите от електрическото захранване поне 60 секунди преди започване на ремонта.</li> </ul>
--	--

	<p style="text-align: center;"> <b>ВНИМАТЕЛНО</b></p> <p><b>Остри ръбове!</b></p> <p>Наранявания от порязване</p> <ul style="list-style-type: none"> <li>▶ Носете предпазни ръкавици.</li> </ul>
--	---

### Изискване:

-  Уредът е изключен от захранването.
-  Вратата е отворена.
-  Рафтовете на хладилното отделение са извадени.

### 4.18.1 Сваляне на LED светлината на страничната лента

1. Поставете смукателната чаша върху горната трета на LED светлината на страничната лента.



2. Издърпайте смукателната чаша с предната LED светлина на страничната лента с едно въртливо движение.

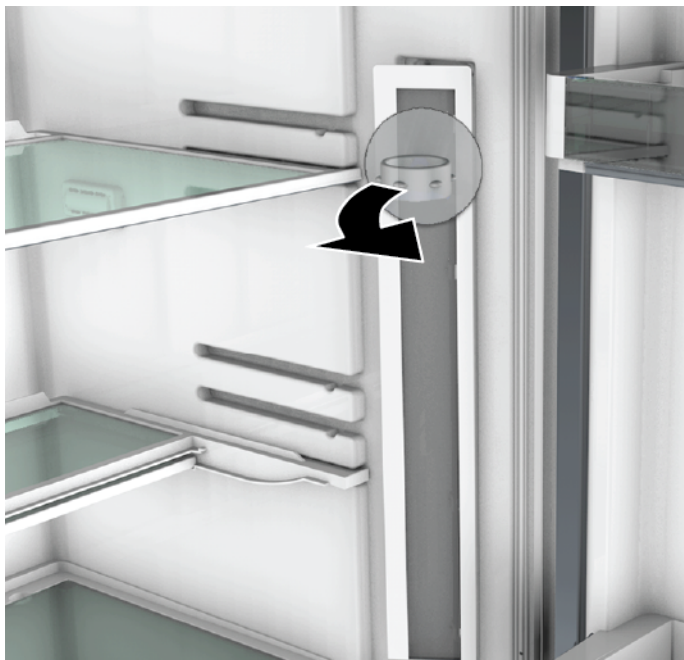





3. Изключете електрическата връзка на LED светлината на страничната лента.  
➡ LED светлина на страничната лента е свалена.

#### 4.18.2 Монтиране на LED светлината на страничната лента

1. Свържете електрическата връзка на LED светлината на страничната лента.
  2. Фиксирайте LED светлината на страничната лента на нейното място на стената на отделениято (куките щракват).
- ➡ LED светлината на страничната лента е монтирана.

# Savjeti za popravak - Hladnjak i zamrzivač

 <b>O ovom dokumentu</b> .....	<b>30</b>		
1.1 Važne informacije .....	30		
1.1.1 Svrha .....	30		
1.2 objašnjenje oznaka .....	30		
1.2.1 Stupnjevi opasnosti .....	30		
1.2.2 Oznake opasnosti .....	30		
1.2.3 Struktura upozorenja .....	31		
1.2.4 Opće oznake .....	31		
 <b>Sigurnost</b> .....	<b>32</b>		
2.1 Opće sigurnosne upute .....	32		
2.1.1 Svi kućanski uređaji .....	32		
 <b>Alat i pomagala</b> .....	<b>33</b>		
 <b>Popravak</b> .....	<b>34</b>		
4.1 Zamjena brtve vrata .....	34		
4.2 Zamjena ručke za vrata .....	35		
4.2.1 Uklanjanje ručke za vrata .....	35		
4.2.2 Postavljanje ručke za vrata .....	35		
4.3 Zamjena gornjeg zgloba vrata .....	36		
4.3.1 Uklanjanje gornjeg zgloba vrata .....	36		
4.3.2 Postavljanje gornjeg zgloba vrata .....	37		
4.4 Zamjena gornjeg zgloba vrata (vrata sa zaslonom) .....	38		
4.4.1 Uklanjanje gornjeg zgloba vrata .....	38		
4.4.2 Postavljanje gornjeg zgloba vrata .....	39		
4.5 Zamjena srednjeg zgloba vrata .....	40		
4.5.1 Uklanjanje srednjeg zgloba vrata .....	40		
4.5.2 Postavljanje srednjeg zgloba vrata .....	40		
4.6 Zamjena donjeg zgloba vrata .....	41		
4.6.1 Uklanjanje donjeg zgloba vrata .....	41		
4.6.2 Postavljanje donjeg zgloba vrata .....	41		
4.7 Zamjena police .....	42		
4.7.1 Uklanjanje police .....	42		
4.7.2 Postavljanje police .....	42		
4.8 Zamjena podesive police .....	43		
4.8.1 Uklanjanje podesive police .....	43		
4.8.2 Postavljanje podesive police .....	43		
4.9 Zamjena fleksibilne police .....	44		
4.9.1 Skidanje fleksibilne police .....	44		
4.9.2 Postavljanje fleksibilne police .....	44		
4.10 Zamjena kompleta za doručak .....	45		
4.10.1 Skidanje kompleta za doručak .....	45		
4.10.2 Postavljanje kompleta za doručak .....	45		
4.11 Zamjena police za boce .....	46		
4.11.1 Uklanjanje police za boce .....	46		
4.11.2 Postavljanje police za boce .....	46		
4.12 Zamjena posude za vrata .....	47		
4.12.1 Uklanjanje posude za vrata .....	47		
4.12.2 Postavljanje posude za vrata .....	47		
4.13 Zamjena spremnika za zamrznute namirnice .....	48		
4.13.1 Uklanjanje spremnika za zamrznute namirnice .....	48		
4.13.2 Postavljanje spremnika za zamrznute namirnice .....	48		
4.14 Zamjena spremnika .....	49		
4.14.1 Uklanjanje spremnika .....	49		
4.14.2 Postavljanje spremnika .....	49		
4.15 Zamjena izvlačnog spremnika .....	50		
4.15.1 Uklanjanje izvlačnog spremnika .....	50		
4.15.2 Postavljanje izvlačnog spremnika .....	50		
4.16 Zamjena LED usmjerenog svjetla .....	51		
4.16.1 Uklanjanje LED usmjerenog svjetla .....	51		
4.16.2 Postavljanje LED usmjerenog svjetla .....	51		
4.17 Zamjena LED gornjeg svjetla .....	52		
4.17.1 Uklanjanje LED svjetla .....	52		
4.17.2 Postavljanje gornjeg LED svjetla .....	53		
4.18 Zamjena LED svjetlosne šipke .....	54		
4.18.1 Uklanjanje LED svjetlosne šipke .....	54		
4.18.2 Postavljanje LED svjetlosne šipke .....	55		

# **i** O ovom dokumentu

## 1.1 Važne informacije

### 1.1.1 Svrha

Ove upute za popravak služe kao podrška korisnicima prilikom samostalnog popravljivanja uređaja u skladu s primjenjivom Direktivom o ekološkom dizajnu (od ožujka 2021.).

One sadrže informacije o zamjeni određenih rezervnih dijelova, kao i napomene o upozorenjima i opasnostima.

Ako imate dodatna pitanja, obratite se našoj službi za korisnike. Mi snosimo odgovornost za oštećenja samo u slučaju pridržavanja uputa za popravak.

## 1.2 Objašnjenje oznaka

### 1.2.1 Stupnjevi opasnosti

Stupnjevi upozorenja sastoje se od oznake i signalne riječi. Signalna riječ ukazuje na ozbiljnost opasnosti.





Stupanj upozorenja	Značenje
 <b>OPASNOST</b>	Nepridržavanje poruke upozorenja rezultirat će smrtnim ili teškim ozljedama.
 <b>UPOZORENJE</b>	Nepridržavanje poruke upozorenja može rezultirati smrtnim ili teškim ozljedama.
 <b>OPREZ</b>	Nepridržavanje poruke upozorenja može rezultirati lakšim ozljedama.
 <b>POZORI!</b>	Nepridržavanje poruke upozorenja može rezultirati oštećenjem imovine.

Tablica 1: Stupnjevi opasnosti



### 1.2.2 Oznake opasnosti

Oznake opasnosti simbolička su reprezentacija s oznakom vrste opasnosti.

U ovom dokumentu koriste se sljedeće oznake opasnosti:

Oznaka opasnosti	Značenje
	Opća poruka upozorenja
	Opasnost od električnog napona
	Opasnost od eksplozije
	Opasnost od porezotina
	Opasnost od prignječenja

## O ovom dokumentu

Oznaka opasnosti	Značenje
	Opasnost od vrućih površina
	Opasnost od jakog magnetskog polja
	Opasnost od neionizirajućeg zračenja

Tablica 2: Oznake opasnosti

### 1.2.3 Struktura upozorenja

Upozorenja u ovom dokumentu imaju normirani izgled i strukturu.



	<div style="background-color: red; color: white; padding: 2px; text-align: center;"> <b>OPASNOST</b></div> <p><b>Vrsta i izvor opasnosti!</b> Moguće posljedice zanemarivanja opasnosti/upozorenja.</p> <ul style="list-style-type: none"> <li>▶ Mjere i zabrane za sprječavanje opasnosti.</li> </ul>
--	---





Sljedeći primjer pokazuje upozorenje na strujni udar od dijelova koji provode struju. Spominje se mjera za izbjegavanje opasnosti.

	<div style="background-color: red; color: white; padding: 2px; text-align: center;"> <b>OPASNOST</b></div> <p><b>Opasnost od strujnog udara zbog dijelova koji provode struju!</b> Smrt od strujnog udara</p> <ul style="list-style-type: none"> <li>▶ Isključite uređaj iz električnog napajanja najmanje 60 sekundi prije izvođenja popravaka.</li> </ul>
---	--

### 1.2.4 Opće oznake

U ovom dokumentu koriste se sljedeće opće oznake:

Opća znaka	Značenje
	Oznaka posebnog savjeta (tekst i/ili grafika)
	Oznaka jednostavnog savjeta (samo tekst)
	Oznaka veze na videovodič

Opća znaka	Značenje
	Oznaka potrebnog alata
	Oznaka potrebnih preduvjeta
	Oznaka uvjeta (ako ..., tad ...)
	Oznaka rezultata
Početak	Oznaka tipke ili gumba
[00123456]	Oznaka broja materijala
Status	Oznaka prikazanog teksta / prozor (na zaslonu uređaja)

Tablica 3: Opće oznake

## 2.1 Opće sigurnosne upute

### 2.1.1 Svi kućanski uređaji

#### **Opasnost od strujnog udara zbog dijelova koji provode struju!**

- Pogreške izazvane popravcima električnih sastavnih dijelova mogu dovesti do strujnog udara!
- Isključite uređaj iz struje na najmanje 60 sekundi prije početka radova.
- Nakon popravka provedite sigurnosni test u skladu s VDE 0701 ili nacionalnim propisima.

#### **Opasnost od ozljeda zbog oštih rubova!**

- Nosite zaštitne rukavice.

#### **Opasnost od prignječenja tijekom izvođenja radova na popravcima, održavanju, rješavanju problema i servisiranju teških i pokretnih sastavnih dijelova**

- Nosite zaštitnu obuću.
- Osigurajte teške sastavne dijelove od pada.
- Nemojte umetati dijelove tijela u pokretne sastavne dijelove.

#### **Opasnost za sigurnost/rad uređaja!**

- Koristite samo originalne rezervne dijelove.

#### **Opasnost od oštećenja elektrostatički osjetljivih sastavnih dijelova (ESD)!**

- Nemojte dodirivati module, uključujući priključke i rute vodiča.

## Alat i pomagala

Oznaka	Pojedinosti	Slike
Zaštitna navlaka [00342013]	60 cm x 50 cm	
Komplet preciznih odvijača [00341820]	9 kom., 2,0 mm, 2,4 mm, 3,0 mm, PH0, PH00, PH1, TX6, TX8, TX9	
Pomoćni alat [00342180]	Alat za otpuštanje plastičnih dijelova "magic tool"	
Ušisna čašica [00342224]	Ø 50 mm	
Nastavak Torx TX20 [00340865]	6,3 mm (1/4")	
Odvijač s utorom	Nož 10 mm x 1,6 mm x 200 mm	



## 4.1 Zamjena brtve vrata

### Zahtjev:



- Vrata su otvorena.

## 4.2 Zamjena ručke za vrata

### Specijalni alati:

-  Nastavak Torx TX20      6,3 mm (1/4")      [00340865]
-  Odvijač s utorom      Nož 10 mm x 1,6 mm x 200 mm

### Zahtjev:

-  Uređaj je isključen iz napajanja.
-  Vrata su otvorena.

### 4.2.1 Uklanjanje ručke za vrata

- ▶ 1. Uklonite dva navojna čepa (1).
- ▶ 2. Odvijte dva vijka (2).
- ▶ 3. Uklonite ručku za vrata (3).

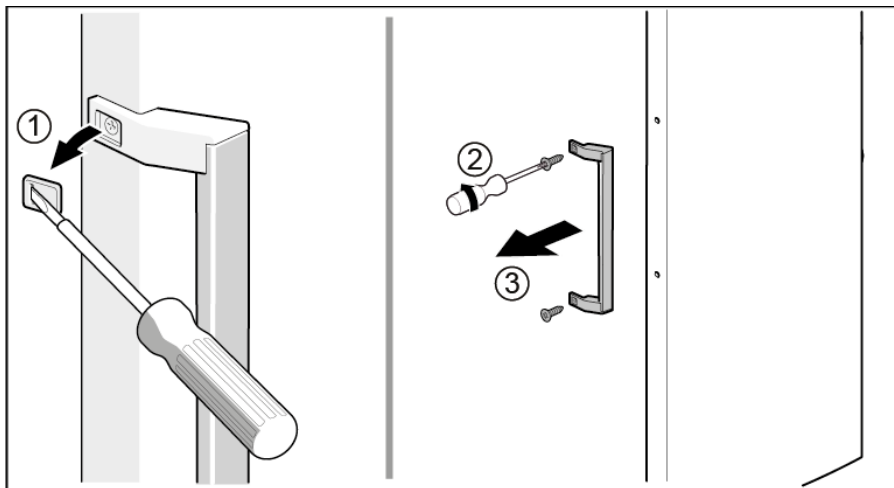

-  Ručka za vrata je uklonjena.



Ručka za druga vrata može se ukloniti na isti način.

### 4.2.2 Postavljanje ručke za vrata

- ▶ Postavite obratnim redoslijedom.

## 4.3 Zamjena gornjeg zgloba vrata

### Specijalni alati:

🔧 Nastavak Torx TX20      6,3 mm (1/4")      [00340865]

	<b>⚠️ UPOZORENJE</b>
	<p><b>Teški, veliki uređaji!</b> Ozljede leđa i kralježnice</p> <ul style="list-style-type: none"> <li>▶ Uklanjanje vrata uređaja smiju obavljati samo obučeni stručnjaci.</li> <li>▶ Za pomicanje uređaja potrebne su dvije osobe.</li> <li>▶ Koristite samo prikladan alat i opremu.</li> </ul>

	<b>⚠️ OPREZ</b>
	<p><b>Oštri rubovi!</b> Porezotine</p> <ul style="list-style-type: none"> <li>▶ Nosite zaštitne rukavice.</li> </ul>

	<b>⚠️ UPOZORENJE</b>
	<p><b>Isklizavanje nagnutih uređaja!</b> Puknuća kostiju / ozljede od prignječenja</p> <ul style="list-style-type: none"> <li>▶ Osigurajte uređaje od isklizavanja.</li> </ul>

	<b>⚠️ OPREZ</b>
	<p><b>Opasnost od padanja dijelova zbog otpuštenih vijaka!</b> Ozljeda od dijelova koji padaju.</p> <ul style="list-style-type: none"> <li>▶ Osigurajte sastavne dijelove od pada.</li> </ul>

	<b>POZOR!</b>
	<p><b>Opasnost od padanja dijelova zbog otpuštenih vijaka!</b> Oštećenje drugih dijelova uređaja ili objekta klijenta, npr. poda.</p> <ul style="list-style-type: none"> <li>▶ Osigurajte sastavne dijelove od pada.</li> </ul>

### Zahtjev:

- ✔ Uređaj je isključen iz napajanja.
- ✔ Unutarnja oprema uređaja je uklonjena.

## 4.3.1 Uklanjanje gornjeg zgloba vrata

1. Postavite uređaj na poledinu.

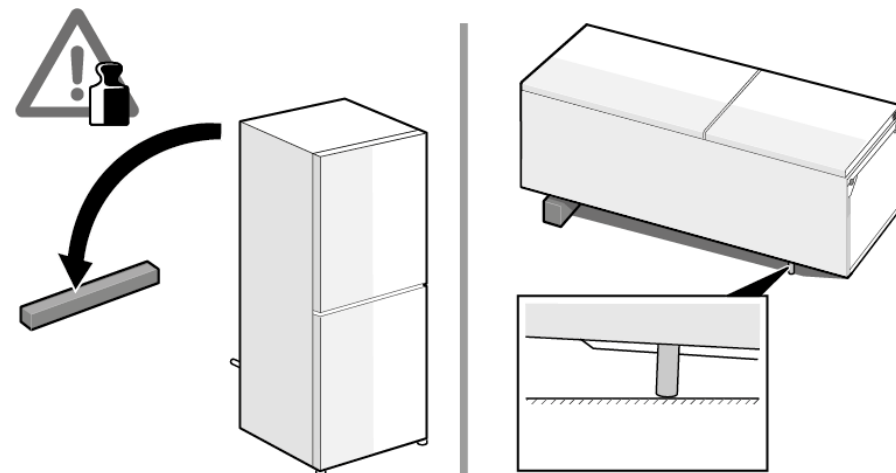

## Popravak

2. 1. Pritisnite poklopac gornjeg zgloba s obje strane (1).
2. Izvadite poklopac gornjeg zgloba (2).
3. Okrenite poklopac zgloba (3).
4. Uklonite poklopac gornjeg zgloba (4).
5. Odvijte dva vijka (5).
6. Uklonite gornji zglob (6)/

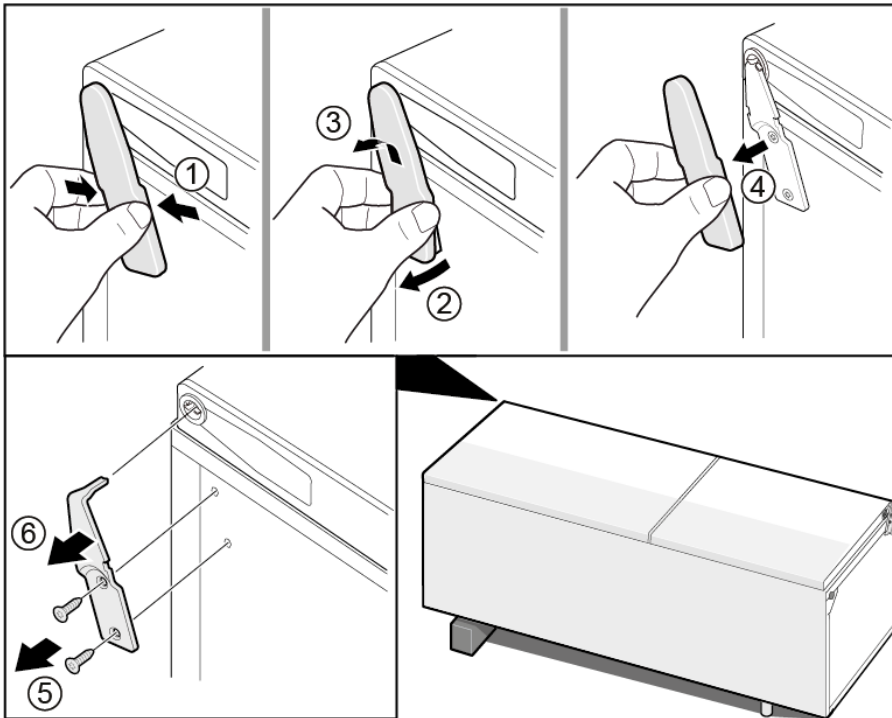

 Gornji je zglob uklonjen.

### 4.3.2 Postavljanje gornjeg zgloba vrata

- ▶ Postavite obratnim redoslijedom.

## 4.4 Zamjena gornjeg zgloba vrata (vrata sa zaslonom)

### Specijalni alati:

🌀 Nastavak Torx TX20      6,3 mm (1/4")      [00340865]

	<b>⚠️ UPOZORENJE</b>
	<p><b>Teški, veliki uređaji!</b> Ozljede leđa i kralježnice</p> <ul style="list-style-type: none"> <li>▶ Uklanjanje vrata uređaja smiju obavljati samo obučeni stručnjaci.</li> <li>▶ Za pomicanje uređaja potrebne su dvije osobe.</li> <li>▶ Koristite samo prikladan alat i opremu.</li> </ul>

	<b>⚠️ OPREZ</b>
	<p><b>Oštri rubovi!</b> Porezotine</p> <ul style="list-style-type: none"> <li>▶ Nosite zaštitne rukavice.</li> </ul>

	<b>⚠️ UPOZORENJE</b>
	<p><b>Isklizavanje nagnutih uređaja!</b> Puknuća kostiju / ozljede od prignječenja</p> <ul style="list-style-type: none"> <li>▶ Osigurajte uređaje od isklizavanja.</li> </ul>

	<b>⚠️ OPREZ</b>
	<p><b>Opasnost od padanja dijelova zbog otpuštenih vijaka!</b> Ozljeda od dijelova koji padaju.</p> <ul style="list-style-type: none"> <li>▶ Osigurajte sastavne dijelove od pada.</li> </ul>

	<b>POZOR!</b>
	<p><b>Opasnost od padanja dijelova zbog otpuštenih vijaka!</b> Oštećenje drugih dijelova uređaja ili objekta klijenta, npr. poda.</p> <ul style="list-style-type: none"> <li>▶ Osigurajte sastavne dijelove od pada.</li> </ul>

	<b>⚠️ OPASNOST</b>
	<p><b>Opasnost od strujnog udara zbog dijelova koji provode struju!</b> U slučaju nepravilnog popravka može doći do opasnosti za život od strujnog udara</p> <ul style="list-style-type: none"> <li>▶ Električne dijelove mora popraviti kvalificirani električar.</li> <li>▶ Nakon popravka provedite sigurnosni test u skladu s VDE 0701 ili nacionalnim propisima.</li> </ul>

	<b>⚠️ OPASNOST</b>
	<p><b>Opasnost od strujnog udara zbog dijelova koji provode struju!</b> Smrt od strujnog udara</p> <ul style="list-style-type: none"> <li>▶ Isključite uređaj iz električnog napajanja najmanje 60 sekundi prije izvođenja popravaka.</li> </ul>

### Zahtjev:

- ✅ Uređaj je isključen iz napajanja.
- ✅ Unutarnja oprema uređaja je uklonjena.

### 4.4.1 Uklanjanje gornjeg zgloba vrata

1. Postavite uređaj na poleđinu.

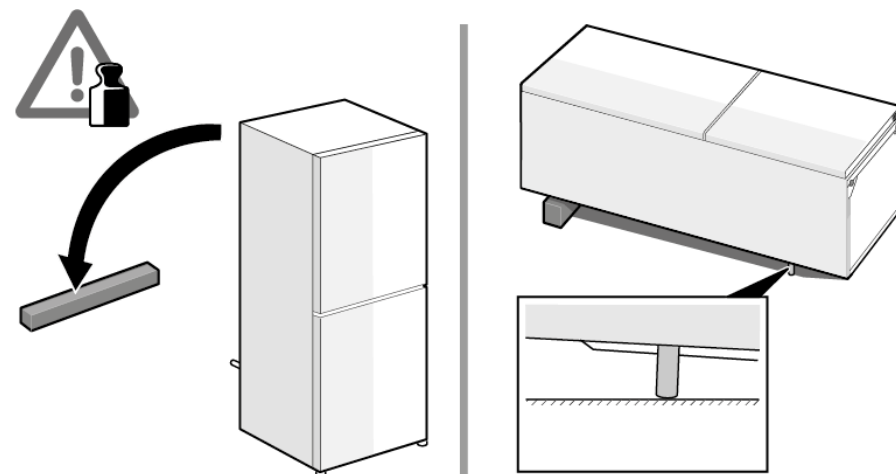

## Popravak

2. 1. Uklonite poklopac gornjeg zgloba (1).
2. Uklonite poklopac kutije za kabele (2).
3. Odvojite električni priključak (3).
4. Odvijte vijak priključka za uzemljenje (4).
5. Uklonite zaštitu kabela (5).
6. Odvijte vijak (6)

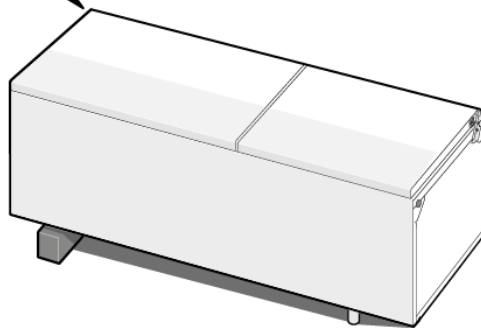
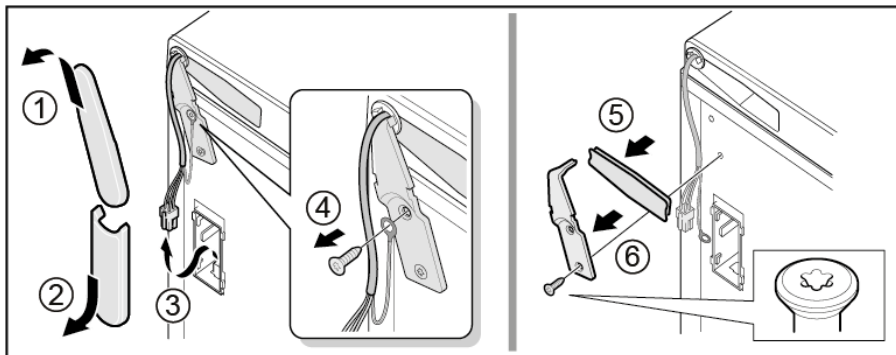

 Gornji je zglob uklonjen.

### 4.4.2 Postavljanje gornjeg zgloba vrata

- ▶ Postavite obratnim redoslijedom.

## 4.5 Zamjena srednjeg zgloba vrata

### Specijalni alati:

🔧 Nastavak Torx TX20      6,3 mm (1/4")      [00340865]

	<b>⚠️ UPOZORENJE</b>
	<p><b>Teški, veliki uređaji!</b> Ozljede leđa i kralježnice</p> <ul style="list-style-type: none"> <li>▶ Uklanjanje vrata uređaja smiju obavljati samo obučeni stručnjaci.</li> <li>▶ Za pomicanje uređaja potrebne su dvije osobe.</li> <li>▶ Koristite samo prikladan alat i opremu.</li> </ul>

	<b>⚠️ OPREZ</b>
	<p><b>Oštri rubovi!</b> Porezotine</p> <ul style="list-style-type: none"> <li>▶ Nosite zaštitne rukavice.</li> </ul>

	<b>⚠️ UPOZORENJE</b>
	<p><b>Isklizavanje nagnutih uređaja!</b> Puknuća kostiju / ozljede od prignječenja</p> <ul style="list-style-type: none"> <li>▶ Osigurajte uređaje od isklizavanja.</li> </ul>

	<b>⚠️ OPREZ</b>
	<p><b>Opasnost od padanja dijelova zbog otpuštenih vijaka!</b> Ozljeda od dijelova koji padaju.</p> <ul style="list-style-type: none"> <li>▶ Osigurajte sastavne dijelove od pada.</li> </ul>

	<b>POZOR!</b>
	<p><b>Opasnost od padanja dijelova zbog otpuštenih vijaka!</b> Oštećenje drugih dijelova uređaja ili objekta klijenta, npr. poda.</p> <ul style="list-style-type: none"> <li>▶ Osigurajte sastavne dijelove od pada.</li> </ul>

### Zahtjev:

- ✔ Uređaj je isključen iz napajanja.
- ✔ Unutarnja oprema uređaja je uklonjena.
- ✔ Gornji zglob vrata je skinut.
- ✔ Gornja vrata su skinuta.

### 4.5.1 Uklanjanje srednjeg zgloba vrata

- ▶ 1. Uklonite vrata odjeljka hladnjaka (1).
- ▶ 2. Odvijte dva vijka (2).
- ▶ 3. Uklonite srednji zglob (3).

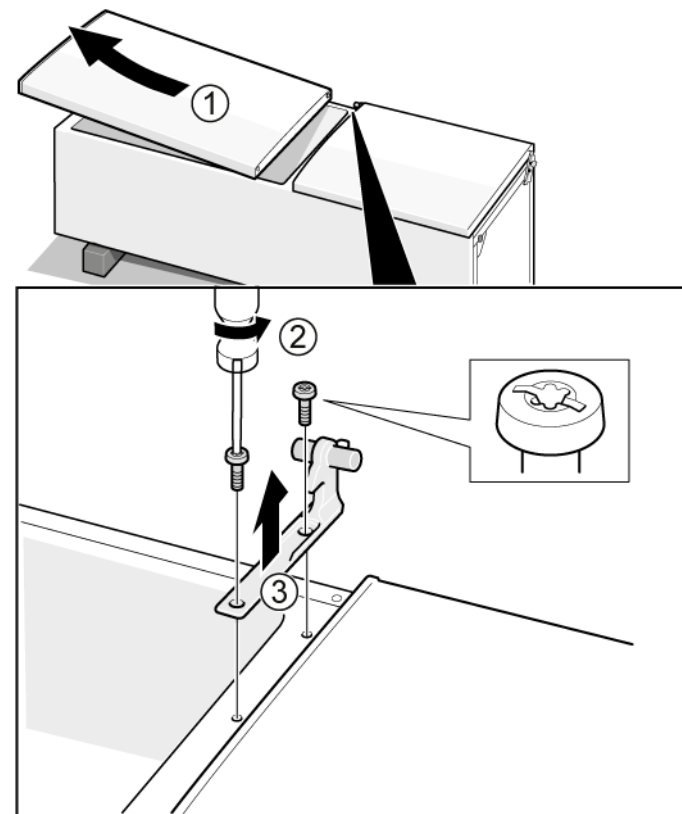

➡ Srednji je zglob uklonjen.

### 4.5.2 Postavljanje srednjeg zgloba vrata

- ▶ Postavite obratnim redoslijedom.

## 4.6 Zamjena donjeg zgloba vrata

### Specijalni alati:

🌀 Nastavak Torx TX20      6,3 mm (1/4")      [00340865]

	<b>⚠️ UPOZORENJE</b>
	<p><b>Teški, veliki uređaji!</b> Ozljede leđa i kralježnice</p> <ul style="list-style-type: none"> <li>▶ Uklanjanje vrata uređaja smiju obavljati samo obučeni stručnjaci.</li> <li>▶ Za pomicanje uređaja potrebne su dvije osobe.</li> <li>▶ Koristite samo prikladan alat i opremu.</li> </ul>

	<b>⚠️ OPREZ</b>
	<p><b>Oštri rubovi!</b> Porezotine</p> <ul style="list-style-type: none"> <li>▶ Nosite zaštitne rukavice.</li> </ul>

	<b>⚠️ UPOZORENJE</b>
	<p><b>Isklizavanje nagnutih uređaja!</b> Puknuća kostiju / ozljede od prignječenja</p> <ul style="list-style-type: none"> <li>▶ Osigurajte uređaje od isklizavanja.</li> </ul>

	<b>⚠️ OPREZ</b>
	<p><b>Opasnost od padanja dijelova zbog otpuštenih vijaka!</b> Ozljeda od dijelova koji padaju.</p> <ul style="list-style-type: none"> <li>▶ Osigurajte sastavne dijelove od pada.</li> </ul>

	<b>POZOR!</b>
	<p><b>Opasnost od padanja dijelova zbog otpuštenih vijaka!</b> Oštećenje drugih dijelova uređaja ili objekta klijenta, npr. poda.</p> <ul style="list-style-type: none"> <li>▶ Osigurajte sastavne dijelove od pada.</li> </ul>

### Zahtjev:

- ✔ Uređaj je isključen iz napajanja.
- ✔ Unutarnja oprema uređaja je uklonjena.
- ✔ Gornji je zglob uklonjen.
- ✔ Srednji je zglob uklonjen.

### 4.6.1 Uklanjanje donjeg zgloba vrata

- ▶ 1. Uklonite vrata odjeljka zamrzivača (1).
- ▶ 2. Odvijte vijak (2).
- ▶ 3. Izvadite donji zglob (3).
- ▶ 4. Uklonite donji zglob (4).

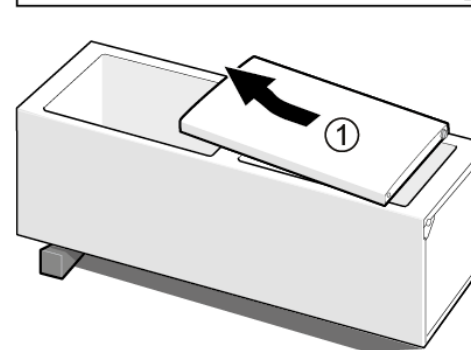
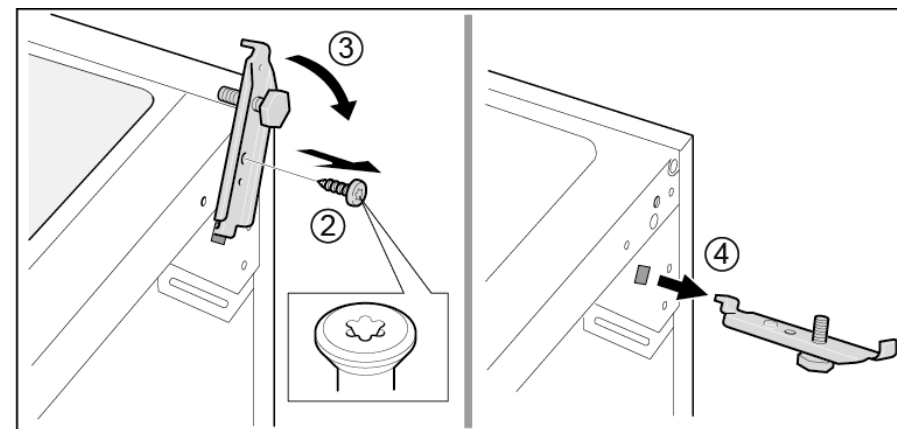

➡ Donji je zglob vrata uklonjen.

### 4.6.2 Postavljanje donjeg zgloba vrata

- ▶ Postavite obratnim redoslijedom.

## 4.7 Zamjena police

### Zahtjev:

- ✔ Vrata su otvorena.

### 4.7.1 Uklanjanje police

- ▶ Izvucite policu.

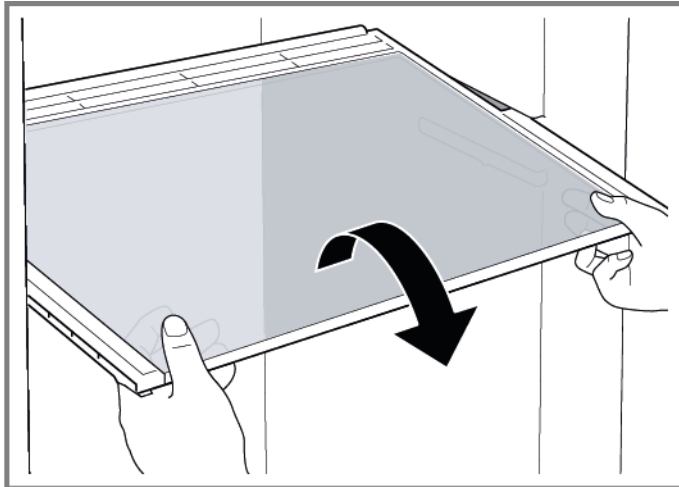

- ➡ Polica je uklonjena.

### 4.7.2 Postavljanje police

- ▶ Postavite obratnim redoslijedom.

## 4.8 Zamjena podesive police

### Zahtjev:

- ✔ Vrata su otvorena.

### 4.8.1 Uklanjanje podesive police

1. Povucite desni dio podesive police prema naprijed (1).
2. Skinite desni dio podesive police (2).

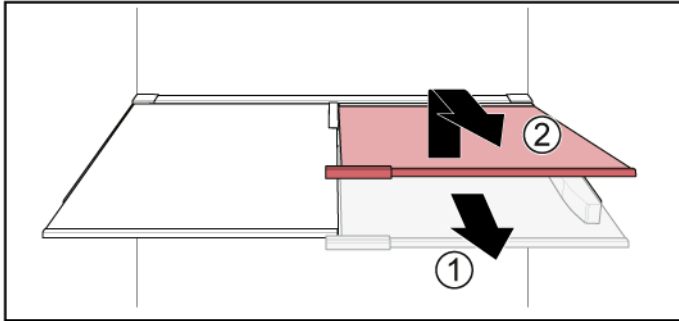

2. Na isti način skinite lijevi dio podesive police.

- ➡ Podesiva polica je skinuta.

### 4.8.2 Postavljanje podesive police

- ▶ Postavite obratnim redoslijedom.

## 4.9 Zamjena fleksibilne police

### Zahtjev:

- ✔ Vrata su otvorena.

### 4.9.1 Skidanje fleksibilne police

- ▶ 1. Skinite staklenu policu (1).
- ▶ 2. Podignite fleksibilnu policu i izvucite je (2).

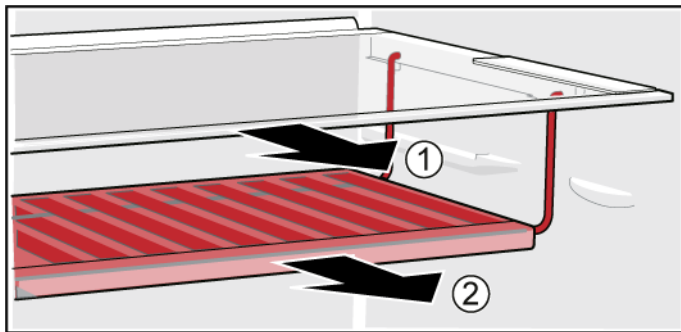

- ➡ Fleksibilna polica je skinuta.

### 4.9.2 Postavljanje fleksibilne police

- ▶ Postavite obratnim redoslijedom.

## 4.10 Zamjena kompleta za doručak

### Zahtjev:

- ✔ Vrata su otvorena.

### 4.10.1 Skidanje kompleta za doručak

- ▶ Podignite komplet za doručak i izvucite ga.

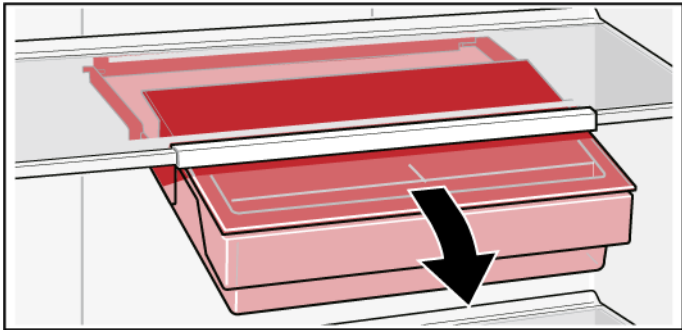

- ➡ Komplet za doručak je skinut.

### 4.10.2 Postavljanje kompleta za doručak

- ▶ Postavite obratnim redoslijedom.

## 4.11 Zamjena police za boce

### Zahtjev:

- ✔ Vrata su otvorena.

### 4.11.1 Uklanjanje police za boce

- ▶ Izvucite policu za boce.

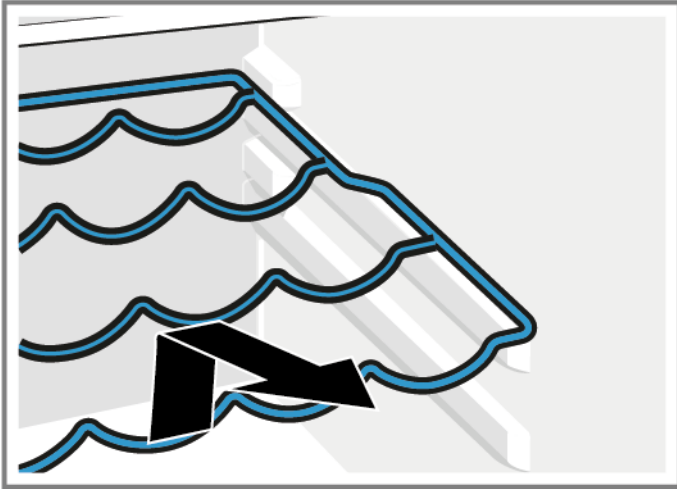

- ➡ Polica za boce je uklonjena.

### 4.11.2 Postavljanje police za boce

- ▶ Postavite obratnim redoslijedom.

## 4.12 Zamjena posude za vrata

### Zahtjev:

- ✔ Vrata su otvorena.

### 4.12.1 Uklanjanje posude za vrata

- ▶ Podignite posudu za vrata prema gore.

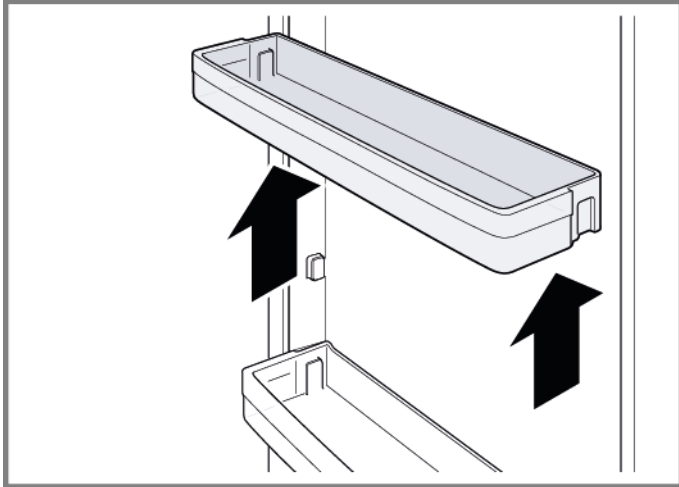

- ➡ Posuda za vrata je uklonjena.

### 4.12.2 Postavljanje posude za vrata

- ▶ Postavite obratnim redoslijedom.

## 4.13 Zamjena spremnika za zamrznute namirnice

### Zahtjev:

- ✔ Vrata su otvorena.

### 4.13.1 Uklanjanje spremnika za zamrznute namirnice

- ▶ 1. Potpuno izvucite spremnik za zamrznute namirnice (1).
- ▶ 2. Uklonite spremnik za hranu (2).

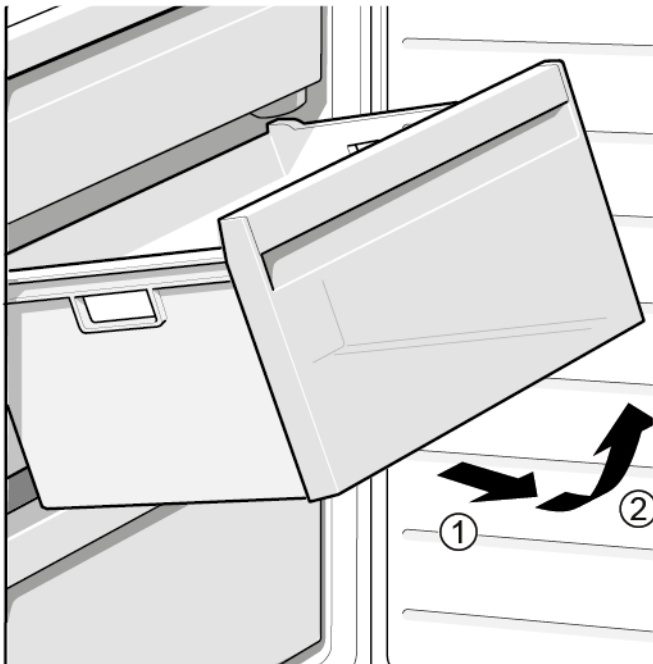

- ➡ Spremnik za zamrznute namirnice je uklonjen.

### 4.13.2 Postavljanje spremnika za zamrznute namirnice

- ▶ Postavite obratnim redoslijedom.

## 4.14 Zamjena spremnika

### Zahtjev:

- ✔ Vrata su otvorena.

### 4.14.1 Uklanjanje spremnika

- ▶ 1. Izvadite donji spremnik hladnjaka (1).
- ▶ 2. Izvadite gornji spremnik hladnjaka (2).

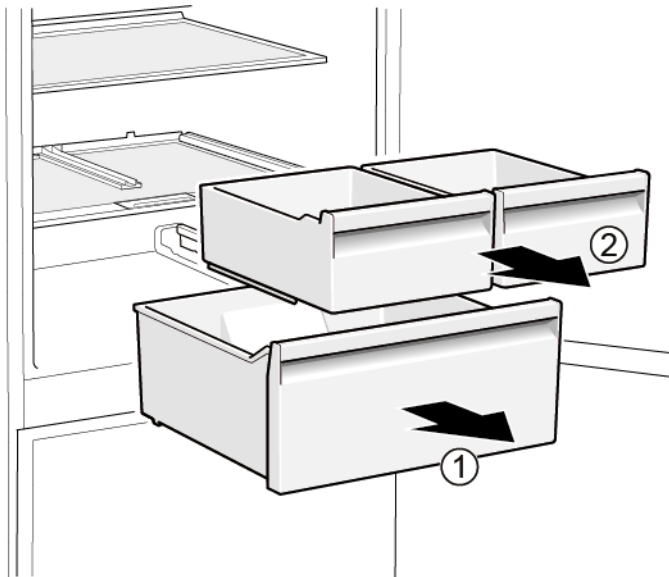

- ➡ Spremnici su uklonjeni.

### 4.14.2 Postavljanje spremnika

- ▶ Postavite obratnim redoslijedom.

## 4.15 Zamjena izvlačnog spremnika

### Zahtjev:

- ✔ Vrata su otvorena.

### 4.15.1 Uklanjanje izvlačnog spremnika

- ▶ 1. Potpuno izvucite izvlačni spremnik (1).
- ▶ 2. Uklonite izvlačni spremnik (2).

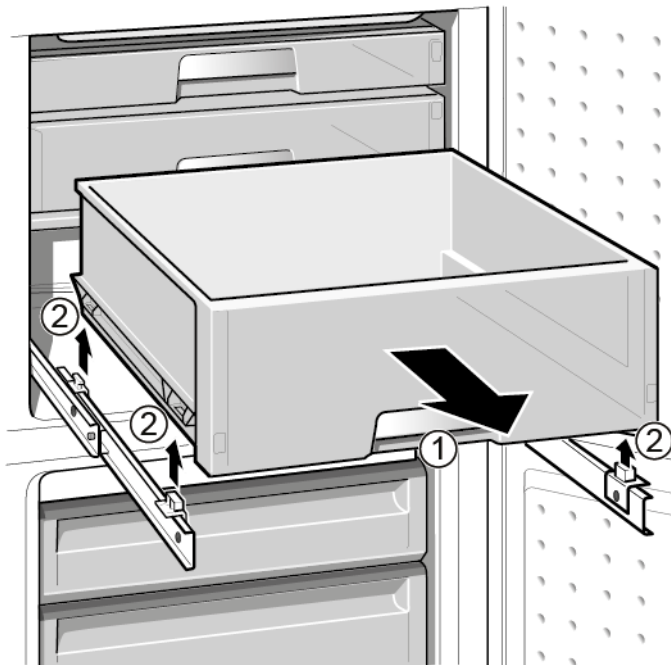

- ➡ Izvlačni spremnik je uklonjen.

### 4.15.2 Postavljanje izvlačnog spremnika

- ▶ Postavite obratnim redoslijedom.

## 4.16 Zamjena LED usmjerenog svjetla

### Specijalni alati:

🔧 Specijalni alat [00342180]

**i** Uređaj ima svjetlo LED koje ne zahtijeva održavanje.  
Ta svjetla smije popravljati samo osoblje iz službe za korisnike ili ovlašteni tehničari!

**⚠️ OPASNOST**  
**Opasnost od strujnog udara zbog dijelova koji provode struju!**  
U slučaju nepravilnog popravka može doći do opasnosti za život od strujnog udara

- ▶ Električne dijelove mora popraviti kvalificirani električar.
- ▶ Nakon popravka provedite sigurnosni test u skladu s VDE 0701 ili nacionalnim propisima.

**⚠️ OPASNOST**  
**Opasnost od strujnog udara zbog dijelova koji provode struju!**  
Smrt od strujnog udara

- ▶ Isključite uređaj iz električnog napajanja najmanje 60 sekundi prije izvođenja popravaka.

**⚠️ OPREZ**  
**Oštri rubovi!**  
Porezotine

- ▶ Nosite zaštitne rukavice.

### Zahtjev:

- ✔ Uređaj je isključen iz napajanja.
- ✔ Vrata su otvorena.

### 4.16.1 Uklanjanje LED usmjerenog svjetla

1. S pomoću specijalnog alata izvucite LED usmjerenog svjetla (1).

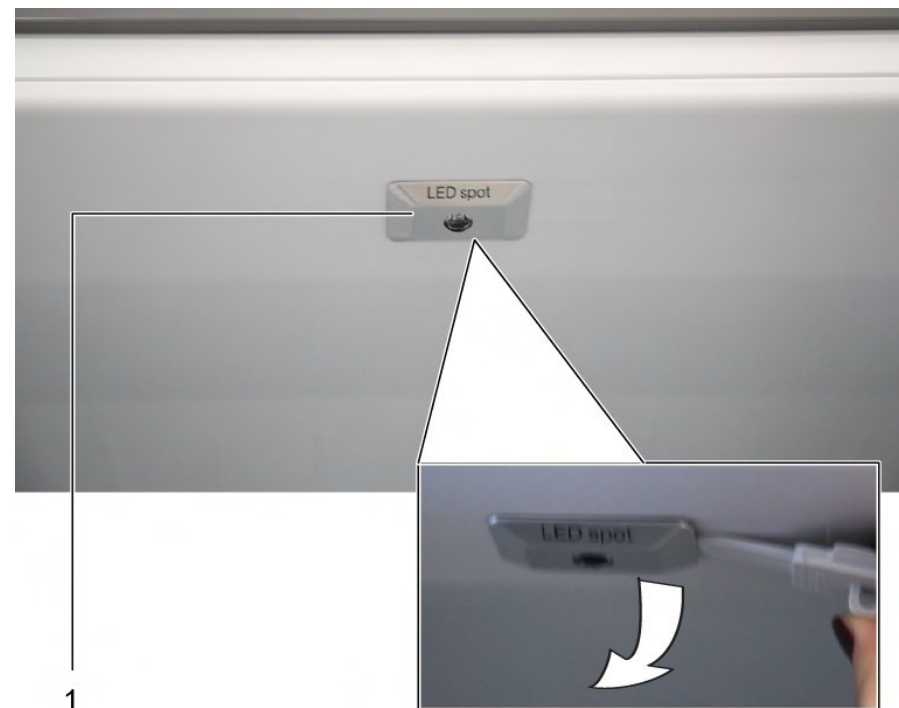

2. Odvojite električne priključke LED usmjerenog svjetla.  
➡ LED usmjerenog svjetla je uklonjeno.

### 4.16.2 Postavljanje LED usmjerenog svjetla

- ▶ Postavite obratnim redoslijedom.

## 4.17 Zamjena LED gornjeg svjetla

### Specijalni alati:

- 🔧 Odvijač s utorom      Nož 2,4 mm x 0,4 mm x 60 mm, u kompletu [00341820]



Uređaj ima svjetlo LED koje ne zahtijeva održavanje.  
Ta svjetla smije popravljati samo osoblje iz službe za korisnike ili ovlašteni tehničari!



### ⚠️ OPASNOST

#### Opasnost od strujnog udara zbog dijelova koji provode struju!

U slučaju nepravilnog popravka može doći do opasnosti za život od strujnog udara

- ▶ Električne dijelove mora popraviti kvalificirani električar.
- ▶ Nakon popravka provedite sigurnosni test u skladu s VDE 0701 ili nacionalnim propisima.



### ⚠️ OPASNOST

#### Opasnost od strujnog udara zbog dijelova koji provode struju!

Smrt od strujnog udara

- ▶ Isključite uređaj iz električnog napajanja najmanje 60 sekundi prije izvođenja popravaka.



### ⚠️ OPREZ

#### Oštri rubovi!

Porezotine

- ▶ Nosite zaštitne rukavice.

### Zahtjev:

- ✔ Uređaj je isključen iz napajanja.
- ✔ Vrata su otvorena.
- ✔ Gornja unutarnja oprema je uklonjena.

## 4.17.1 Uklanjanje LED svjetla

1. Pomaknite LED svjetlo ulijevo.

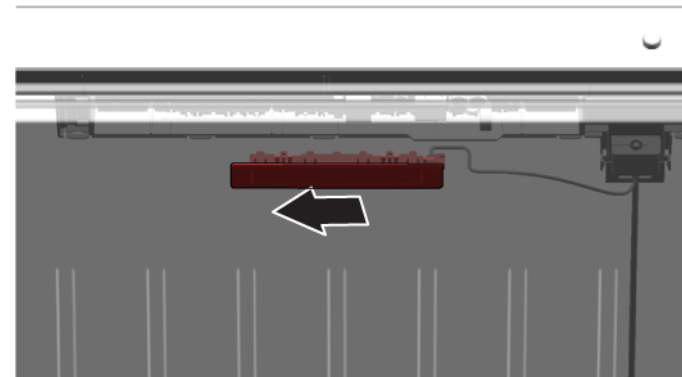

- ➡ Električni priključak LED svjetla je odvojen.

2. Otpustite kuke LED svjetla.

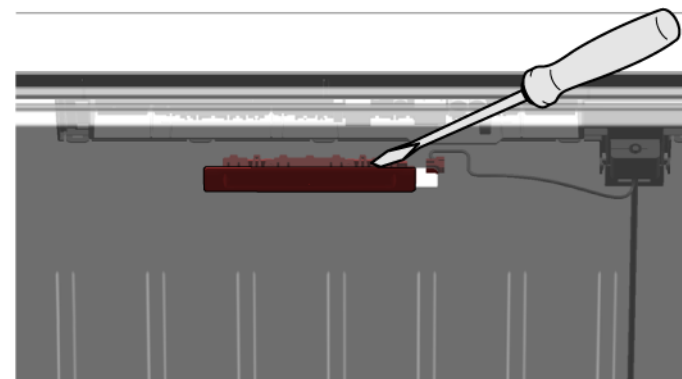

3. Uklonite LED svjetlo tako da ga pomaknete prema naprijed.

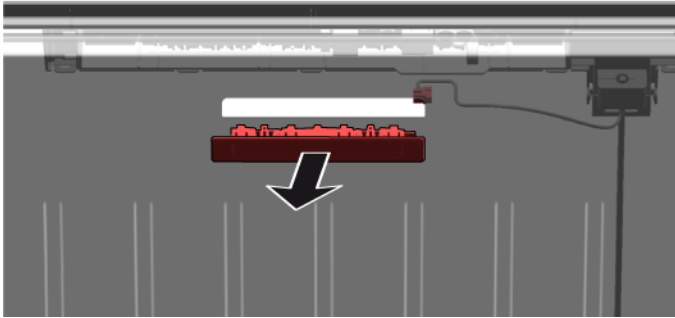

- ➔ LED svjetlo je uklonjeno.

### 4.17.2 Postavljanje gornjeg LED svjetla

- ▶ Postavite obratnim redoslijedom.

## 4.18 Zamjena LED svjetlosne šipke

### Specijalni alati:

🌀 Usisna čašica Ø50 mm [00342224]



Uređaj ima svjetlo LED koje ne zahtijeva održavanje.  
Ta svjetla smije popravljati samo osoblje iz službe za korisnike ili ovlaštene tehničari!



### ⚠️ OPASNOST

#### Opasnost od strujnog udara zbog dijelova koji provode struju!

U slučaju nepravilnog popravka može doći do opasnosti za život od strujnog udara

- ▶ Električne dijelove mora popraviti kvalificirani električar.
- ▶ Nakon popravka provedite sigurnosni test u skladu s VDE 0701 ili nacionalnim propisima.



### ⚠️ OPASNOST

#### Opasnost od strujnog udara zbog dijelova koji provode struju!

Smrt od strujnog udara

- ▶ Isključite uređaj iz električnog napajanja najmanje 60 sekundi prije izvođenja popravaka.



### ⚠️ OPREZ

#### Oštri rubovi!

Porezotine

- ▶ Nosite zaštitne rukavice.

### Zahtjev:

- ✓ Uređaj je isključen iz napajanja.
- ✓ Vrata su otvorena.
- ✓ Police odjeljka hladnjaka su uklonjene.

## 4.18.1 Uklanjanje LED svjetlosne šipke

1. Postavite usisnu čašicu na gornju trećinu LED svjetlosne šipke.



2. Povucite usisnu čašicu prema naprijed sa LED svjetlosnom šipkom jednim okretom.







3. Odvojite električni priključak od LED svjetlosne šipke.  
➡ LED svjetlosna šipka je uklonjena.

### 4.18.2 Postavljanje LED svjetlosne šipke

1. Priključite električni priključak LED svjetlosne šipke.
  2. Pričvrstite LED svjetlosnu šipku na mjesto na stijenci odjeljka (kuke će se uklopiti).
- ➡ LED svjetlosna šipka je postavljena.

# Poznámky k opravě - Kombinovaná chladnička a mraznička

 <b>O tomto dokumentu</b> .....	<b>57</b>		
1.1 Důležité informace .....	57		
1.1.1 Účel .....	57		
1.2 Vysvětlení symbolů .....	57		
1.2.1 Úroveň nebezpečí .....	57		
1.2.2 Symboly nebezpečí .....	57		
1.2.3 Struktura výstrah .....	58		
1.2.4 Obecné symboly .....	58		
 <b>Bezpečnost</b> .....	<b>59</b>		
2.1 Všeobecné bezpečnostní pokyny .....	59		
2.1.1 Všechny domácí spotřebiče .....	59		
 <b>Nástroje a pomůcky</b> .....	<b>60</b>		
 <b>Oprava</b> .....	<b>61</b>		
4.1 Výměna těsnění dvířek .....	61		
4.2 Výměna madla dvířek .....	62		
4.2.1 Vyjmutí madla dvířek .....	62		
4.2.2 Montáž madla dvířek .....	62		
4.3 Výměna horního závěsu dvířek .....	63		
4.3.1 Vyjmutí horního závěsu dvířek .....	63		
4.3.2 Montáž horního závěsu .....	64		
4.4 Výměna horního závěsu dvířek (dvířka s ukazatelem) .....	65		
4.4.1 Vyjmutí horního závěsu dvířek .....	65		
4.4.2 Montáž horního závěsu .....	66		
4.5 Výměna středního závěsu dvířek .....	67		
4.5.1 Vyjmutí středního závěsu dvířek .....	67		
4.5.2 Montáž středního závěsu dvířek .....	67		
4.6 Výměna dolního závěsu dvířek .....	68		
4.6.1 Vyjmutí spodního závěsu dvířek .....	68		
4.6.2 Montáž spodního závěsu dvířek .....	68		
4.7 Výměna odkládací plochy .....	69		
4.7.1 Vyjmutí odkládací plochy .....	69		
4.7.2 Montáž odkládací plochy .....	69		
4.8 Výměna variabilní odkládací plochy .....	70		
4.8.1 Vyjmutí variabilní odkládací plochy .....	70		
4.8.2 Montáž variabilní odkládací plochy .....	70		
4.9 Výměna flexibilní odkládací plochy .....	71		
4.9.1 Vyjmutí flexibilní odkládací plochy .....	71		
4.9.2 Montáž flexibilní odkládací plochy .....	71		
4.10 Výměna snídaňové sady .....	72		
4.10.1 Vyjmutí snídaňové sady .....	72		
4.10.2 Montáž snídaňové sady .....	72		
4.11 Výměna držáku na láhve .....	73		
4.11.1 Vyjmutí držáku na láhve .....	73		
4.11.2 Montáž držáku na láhve .....	73		
4.12 Výměna dveřní přihrádky .....	74		
4.12.1 Vyjmutí dveřní přihrádky .....	74		
4.12.2 Montáž dveřní přihrádky .....	74		
4.13 Výměna zásobníku na zmrazené potraviny .....	75		
4.13.1 Vyjmutí zásobníku na zmrazené potraviny .....	75		
4.13.2 Montáž zásobníku na zmrazené potraviny .....	75		
4.14 Výměna zásobníku .....	76		
4.14.1 Vyjmutí zásobníku .....	76		
4.14.2 Montáž zásobníku .....	76		
4.15 Výměna výsuvného zásobníku .....	77		
4.15.1 Vyjmutí výsuvného zásobníku .....	77		
4.15.2 Montáž výsuvného zásobníku .....	77		
4.16 Výměna LED bodového osvětlení .....	78		
4.16.1 Vyjmutí LED bodového osvětlení .....	78		
4.16.2 Montáž LED bodového osvětlení .....	78		
4.17 Výměna LED horního osvětlení .....	79		
4.17.1 Vyjmutí LED osvětlení .....	79		
4.17.2 Montáž horního LED osvětlení .....	80		
4.18 Výměna LED osvětlení boční lišty .....	81		
4.18.1 Vyjmutí LED osvětlení boční lišty .....	81		
4.18.2 Montáž LED osvětlení boční lišty .....	82		

# **i** O tomto dokumentu

## 1.1 Důležité informace

### 1.1.1 Účel

Tyto pokyny k opravě pomáhají spotřebiteli při vlastnoruční opravě spotřebičů v souladu s platnými předpisy o ekodesignu (platnými k 03/2021).



Obsahují informace o výměně některých náhradních dílů včetně příslušných výstrah a nebezpečí.

V případě dotazů se obraťte na náš zákaznický servis. Za škody ručíme pouze v případě, že budou správně dodrženy pokyny k opravě.

## 1.2 Vysvětlení symbolů

### 1.2.1 Úroveň nebezpečí

Jednotlivé úrovně výstrah se skládají ze symbolu a signálního slova. Signální slova uvádějí závažnost nebezpečí.





Úroveň výstrahy	Význam
 <b>NEBEZPEČÍ</b>	Nedodržení výstražného upozornění způsobí smrt nebo vážná zranění.
 <b>VÝSTRAHA</b>	Nedodržení výstražného upozornění může způsobit smrt nebo vážná zranění.
 <b>POZOR</b>	Nedodržení výstražného upozornění může způsobit lehká zranění.
<b>POZOR!</b>	Nedodržení výstražného upozornění může způsobit škody na majetku.

Tabulka 1: Úroveň nebezpečí



### 1.2.2 Symboly nebezpečí

Symboly nebezpečí jsou symbolická znázornění určující druh nebezpečí.

V tomto dokumentu jsou použity následující symboly nebezpečí:

Symbol nebezpečí	Význam
	Obecné výstražné upozornění
	Nebezpečí vycházející z elektrického napětí
	Nebezpečí výbuchu
	Nebezpečí pořezání
	Nebezpečí rozdrcení

## **i** O tomto dokumentu

Symbol nebezpečí	Význam
	Nebezpečí spojené s horkými povrchy
	Nebezpečí vycházející ze silného elektromagnetického pole
	Nebezpečí z neionizujícího záření

Tabulka 2: Symboly nebezpečí

### 1.2.3 Struktura výstrah

Výstrahy použité v tomto dokumentu mají standardizovaný vzhled a strukturu.



	<div style="background-color: red; color: white; padding: 2px; text-align: center;"><b>⚠ NEBEZPEČÍ</b></div> <p><b>Typ a zdroj nebezpečí!</b> Možné důsledky nedodržení výstražného upozornění.</p> <ul style="list-style-type: none"> <li>▶ Opatření a zákazy eliminující nebezpečí.</li> </ul>
--	--





Následující příklad ukazuje výstrahu, která varuje před zásahem elektrickým proudem při dotyku dílů pod proudem. Je uvedeno opatření pro zabránění rizika.

	<div style="background-color: red; color: white; padding: 2px; text-align: center;"><b>⚠ NEBEZPEČÍ</b></div> <p><b>Nebezpečí úrazu elektrickým proudem při dotyku dílů pod proudem!</b> Usmrcení elektrickým proudem</p> <ul style="list-style-type: none"> <li>▶ Odpojte spotřebič od přívodu elektrického proudu alespoň 60 sekund před zahájením opravy.</li> </ul>
---	--

### 1.2.4 Obecné symboly

V tomto dokumentu jsou použity následující obecné symboly:

Obecný symbol	Význam
	Uvedení zvláštního tipu (text nebo grafické vyjádření)
	Uvedení jednoduchého tipu (pouze text)
	Uvedení odkazu k videonávodu

Obecný symbol	Význam
	Uvedení požadovaných nástrojů
	Uvedení požadovaných podmínek
	Uvedení podmínky (když, pak atd.)
	Uvedení výsledku
[Start]	Uvedení klávesy nebo tlačítka
[00123456]	Uvedení čísla materiálu
Status	Uvedení zobrazeného textu / okna (na ukazateli spotřebiče)

Tabulka 3: Obecné symboly

## **2.1 Všeobecné bezpečnostní pokyny**

### **2.1.1 Všechny domácí spotřebiče**

#### **Nebezpečí úrazu elektrickým proudem při dotyku dílů pod proudem!**

- Chyby při opravě elektrických součástí mohou vést k úrazu elektrickým proudem!
- Odpojte spotřebič ze sítě alespoň 60 sekund před zahájením prací.
- Po opravě nechte provést bezpečnostní zkoušku podle VDE 0701 nebo specifických předpisů dané země.

#### **Nebezpečí poranění o ostré hrany!**

- Používejte ochranné rukavice.

#### **Nebezpečí rozdrčení během opravy, údržby, odstranění závad a servisu těžkými a pohyblivými součástmi**

- Používejte bezpečnostní obuv.
- Zajistěte těžké součásti před pádem.
- Nesahejte na pohyblivé součásti.

#### **Nebezpečí z hlediska bezpečnosti / funkce spotřebiče!**

- Používejte pouze originální náhradní díly.

#### **Nebezpečí poškození elektrostaticky citlivých součástí (elektrostatický výboj)!**

- Nedotýkejte se modulů, včetně přípojek a vodičů.

## Nástroje a pomůcky

Označení	Detaily	Snímky
Ochranná tkanina [00342013]	60 cm x 50 cm	
Sada přesných šroubováků [00341820]	9 kusů, 2,0 mm, 2,4 mm, 3,0 mm, PH0, PH00, PH1, TX6, TX8, TX9	
Pomocný nástroj [00342180]	Nástroj pro uvolnění plastových dílů "magic tool"	
Přísavka [00342224]	Ø 50 mm	
Torx Bit TX20 [00340865]	6,3 mm (1/4")	
Plochý šroubovák	Čepel 10 mm x 1,6 mm x 200 mm	



## 4.1 Výměna těsnění dvířek

### Požadavek:



- Dvířka jsou otevřená.

## 4.2 Výměna madla dvířek

### Speciální nástroje:

-  Torx Bit TX20 6,3 mm (1/4") [00340865]
-  Plochý šroubovák Čepel 10 mm x 1,6 mm x 200 mm

### Požadavek:

-  Spotřebič je odpojený od přívodu elektrické energie.
-  Dvířka jsou otevřená.

### 4.2.1 Vyjmutí madla dvířek

- ▶ 1. Odstraňte dvě krytky šroubů (1).
- ▶ 2. Vyšroubujte dva šrouby (2).
- ▶ 3. Vyjměte madlo dvířek (3).

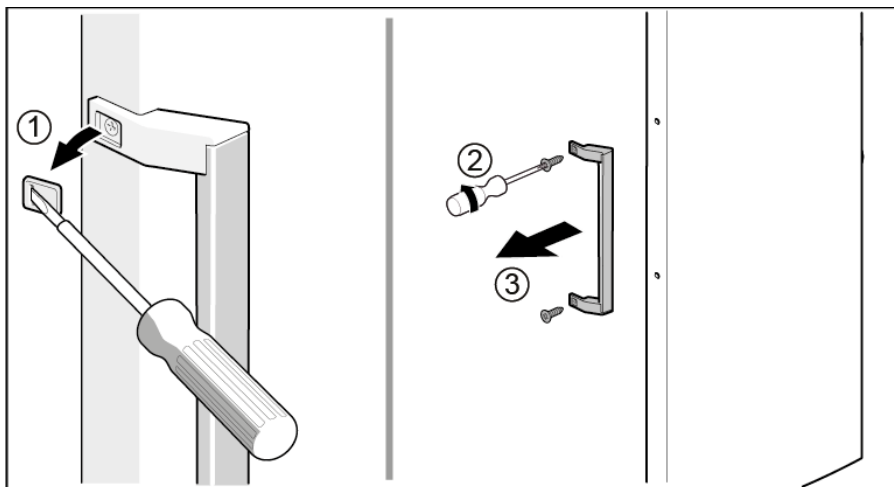

 Madlo dvířek je vyjmuté.



Madlo druhých dvířek může být vyjmuto stejným způsobem.

### 4.2.2 Montáž madla dvířek

- ▶ Montáž proveďte v opačném sledu.



### 4.3 Výměna horního závěsu dvířek



Speciální nástroje:



 Torx Bit TX20



6,3 mm (1/4")

[00340865]

	 <b>VÝSTRAHA</b>
	<p><b>Těžké, objemné spotřebiče!</b> Poranění zad a svalů</p> <ul style="list-style-type: none"> <li>▶ Odstranění dvířek spotřebiče by měl provádět výhradně školený odborník.</li> <li>▶ Pro manipulaci se spotřebičem jsou nutní dva lidé.</li> <li>▶ Použijte pouze vhodné nástroje a zařízení.</li> </ul>



	 <b>POZOR</b>
	<p><b>Ostré hrany!</b> Nebezpečí řezných poranění</p> <ul style="list-style-type: none"> <li>▶ Používejte ochranné rukavice.</li> </ul>

	 <b>VÝSTRAHA</b>
	<p><b>Sklouznutí nakloněných spotřebičů!</b> Zlomeniny / poranění rozdrcením</p> <ul style="list-style-type: none"> <li>▶ Zajistěte spotřebiče proti sklouznutí.</li> </ul>

	 <b>POZOR</b>
	<p><b>Nebezpečí padajících dílů kvůli uvolněným šroubům!</b> Poranění padajícími díly.</p> <ul style="list-style-type: none"> <li>▶ Zajistěte jednotlivé součásti před pádem.</li> </ul>

	<b>POZOR!</b>
	<p><b>Nebezpečí padajících dílů kvůli uvolněným šroubům!</b> Poškození jiných částí spotřebiče nebo prvků domácnosti zákazníka, např. podlahy.</p> <ul style="list-style-type: none"> <li>▶ Zajistěte jednotlivé součásti před pádem.</li> </ul>

Požadavek:

-  Spotřebič je odpojený od přívodu elektrické energie.
-  Vnitřní kování spotřebiče je odstraněno.

#### 4.3.1 Vyjmutí horního závěsu dvířek

1. Položte spotřebič na zadní stranu.

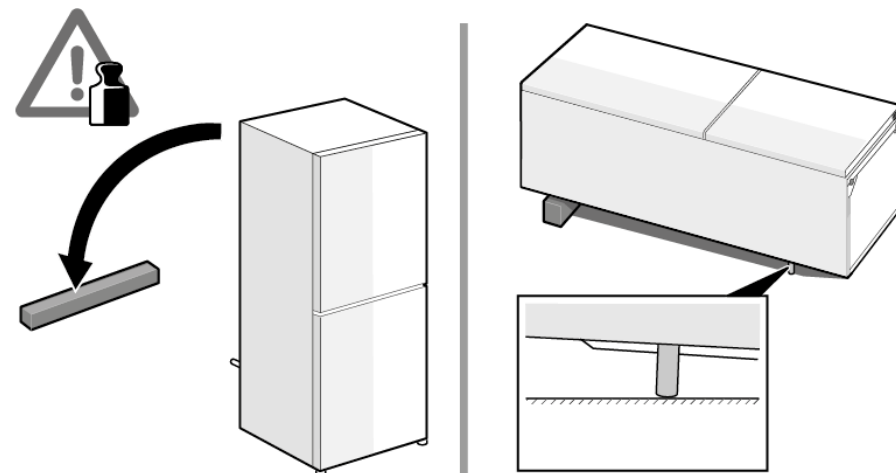

## Oprava

2. 1. Na obou stranách stiskněte kryt horního závěsu (1).
2. Vysuňte kryt horního závěsu (2).
3. Otočte kryt závěsu (3).
4. Odstraňte kryt horního závěsu (4).
5. Vyšroubujte dva šrouby (5).
6. Vyjměte horní závěs (6).

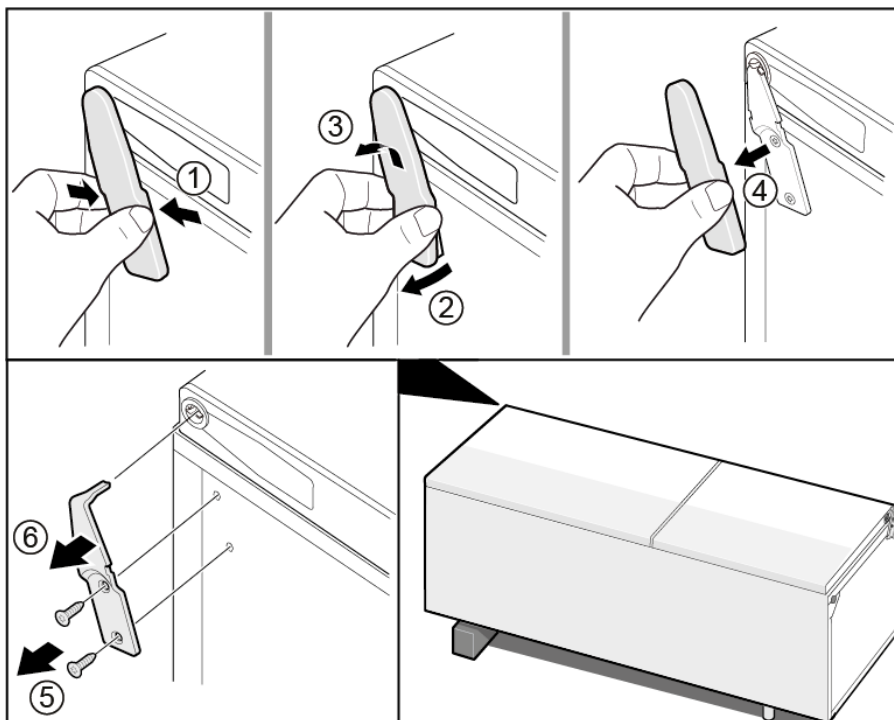

 Horní závěs je vyjmutý.

### 4.3.2 Montáž horního závěsu

- ▶ Montáž proveďte v opačném sledu.

## 4.4 Výměna horního závěsu dvířek (dvířka s ukazatelem)

Speciální nástroje:

 Torx Bit TX20      6,3 mm (1/4")      [00340865]

	<b>⚠ VÝSTRAHA</b>
	<p><b>Těžké, objemné spotřebiče!</b> Poranění zad a svalů</p> <ul style="list-style-type: none"> <li>▶ Odstranění dvířek spotřebiče by měl provádět výhradně školený odborník.</li> <li>▶ Pro manipulaci se spotřebičem jsou nutní dva lidé.</li> <li>▶ Použijte pouze vhodné nástroje a zařízení.</li> </ul>

	<b>⚠ POZOR</b>
	<p><b>Ostré hrany!</b> Nebezpečí řezných poranění</p> <ul style="list-style-type: none"> <li>▶ Používejte ochranné rukavice.</li> </ul>

	<b>⚠ VÝSTRAHA</b>
	<p><b>Sklouznutí nakloněných spotřebičů!</b> Zlomeniny / poranění rozdrcením</p> <ul style="list-style-type: none"> <li>▶ Zajistěte spotřebiče proti sklouznutí.</li> </ul>



	<b>⚠ POZOR</b>
	<p><b>Nebezpečí padajících dílů kvůli uvolněným šroubům!</b> Poranění padajícími díly.</p> <ul style="list-style-type: none"> <li>▶ Zajistěte jednotlivé součásti před pádem.</li> </ul>

	<b>POZOR!</b>
	<p><b>Nebezpečí padajících dílů kvůli uvolněným šroubům!</b> Poškození jiných částí spotřebiče nebo prvků domácnosti zákazníka, např. podlahy.</p> <ul style="list-style-type: none"> <li>▶ Zajistěte jednotlivé součásti před pádem.</li> </ul>

	<b>⚠ NEBEZPEČÍ</b>
	<p><b>Nebezpečí úrazu elektrickým proudem při dotyku dílů pod proudem!</b> V případě neodborné opravy hrozí nebezpečí smrtelného úrazu elektrickým proudem</p> <ul style="list-style-type: none"> <li>▶ Opravu elektrického zařízení smí provádět jen kvalifikovaný elektrikář.</li> <li>▶ Po opravě nechte provést bezpečnostní zkoušku podle VDE 0701 nebo specifických předpisů dané země.</li> </ul>

	<b>⚠ NEBEZPEČÍ</b>
	<p><b>Nebezpečí úrazu elektrickým proudem při dotyku dílů pod proudem!</b> Usmrcení elektrickým proudem</p> <ul style="list-style-type: none"> <li>▶ Odpojte spotřebič od přívodu elektrického proudu alespoň 60 sekund před zahájením opravy.</li> </ul>

**Požadavek:**

-  Spotřebič je odpojený od přívodu elektrické energie.
-  Vnitřní kování spotřebiče je odstraněno.

### 4.4.1 Vyjmutí horního závěsu dvířek

1. Položte spotřebič na zadní stranu.

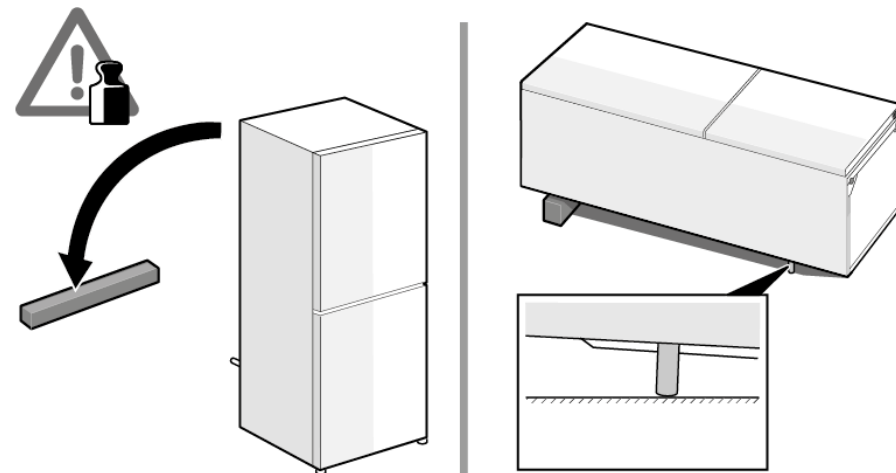

## Oprava

2. 1. Odstraňte kryt horního závěsu (1).
2. Odstraňte kryt kabelové skříně (2).
3. Odpojte elektrické připojení (3).
4. Vyšroubujte šroub zemnicí přípojky (4).
5. Odstraňte ochranu kabelu (5).
6. Vyšroubujte šroub (6).

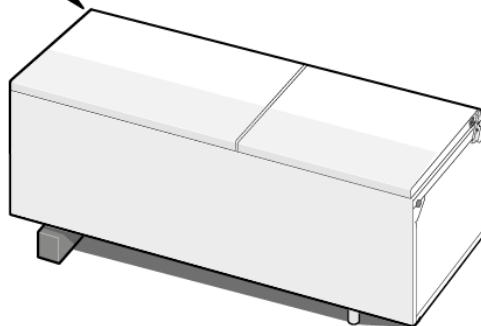
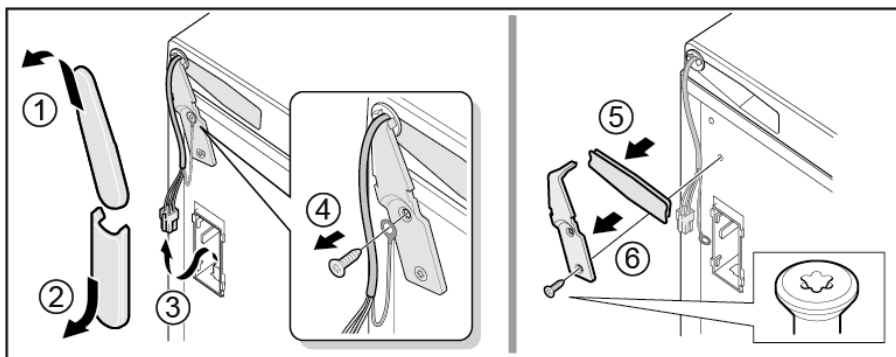

 Horní závěs je vyjmutý.

### 4.4.2 Montáž horního závěsu

- ▶ Montáž proveďte v opačném sledu.

## 4.5 Výměna středního závěsu dvířek

Speciální nástroje:

 Torx Bit TX20                      6,3 mm (1/4")                      [00340865]

	<b>⚠ VÝSTRAHA</b>
	<p><b>Těžké, objemné spotřebiče!</b> Poranění zad a svalů</p> <ul style="list-style-type: none"> <li>▶ Odstranění dvířek spotřebiče by měl provádět výhradně školený odborník.</li> <li>▶ Pro manipulaci se spotřebičem jsou nutní dva lidé.</li> <li>▶ Použijte pouze vhodné nástroje a zařízení.</li> </ul>



	<b>⚠ POZOR</b>
	<p><b>Ostré hrany!</b> Nebezpečí řezných poranění</p> <ul style="list-style-type: none"> <li>▶ Používejte ochranné rukavice.</li> </ul>

	<b>⚠ VÝSTRAHA</b>
	<p><b>Sklouznutí nakloněných spotřebičů!</b> Zlomeniny / poranění rozdrcením</p> <ul style="list-style-type: none"> <li>▶ Zajistěte spotřebiče proti sklouznutí.</li> </ul>

	<b>⚠ POZOR</b>
	<p><b>Nebezpečí padajících dílů kvůli uvolněným šroubům!</b> Poranění padajícími díly.</p> <ul style="list-style-type: none"> <li>▶ Zajistěte jednotlivé součásti před pádem.</li> </ul>

	<b>POZOR!</b>
	<p><b>Nebezpečí padajících dílů kvůli uvolněným šroubům!</b> Poškození jiných částí spotřebiče nebo prvků domácnosti zákazníka, např. podlahy.</p> <ul style="list-style-type: none"> <li>▶ Zajistěte jednotlivé součásti před pádem.</li> </ul>

Požadavek:

-  Spotřebič je odpojený od přívodu elektrické energie.
-  Vnitřní kování spotřebiče je odstraněno.
-  Horní závěs dvířek je vyjmutý.

 Horní dvířka jsou vyjmutá.

### 4.5.1 Vyjmutí středního závěsu dvířek

- ▶ 1. Vyjměte dvířka chladicí přihrádky (1).
- ▶ 2. Vyšroubujte dva šrouby (2).
- ▶ 3. Vyjměte střední závěs (3).

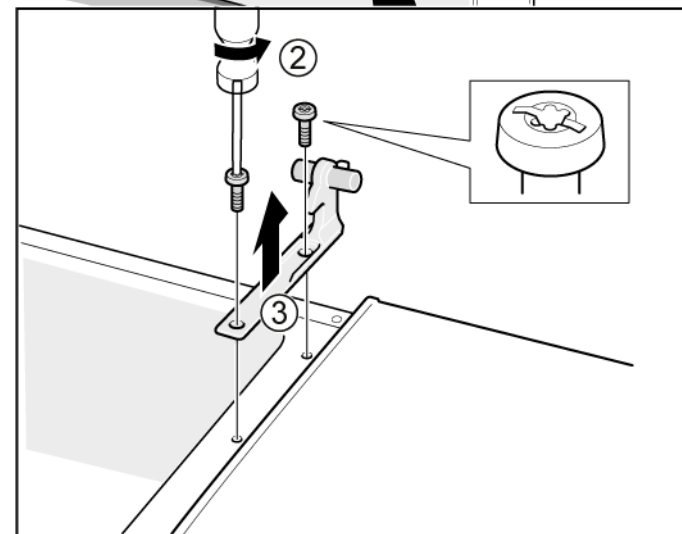
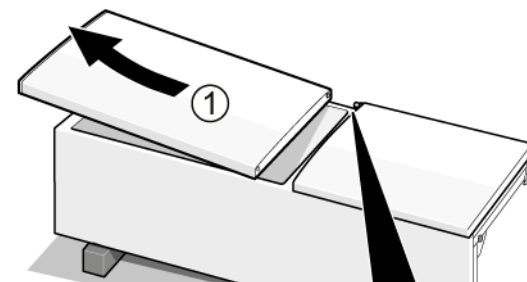

 Střední závěs je vyjmutý.

### 4.5.2 Montáž středního závěsu dvířek

- ▶ Montáž proveďte v opačném sledu.

## 4.6 Výměna dolního závěsu dvířek

Speciální nástroje:

Torx Bit TX20 6,3 mm (1/4") [00340865]

	<b>⚠ VÝSTRAHA</b>
	<p><b>Těžké, objemné spotřebiče!</b> Poranění zad a svalů</p> <ul style="list-style-type: none"> <li>▶ Odstranění dvířek spotřebiče by měl provádět výhradně školený odborník.</li> <li>▶ Pro manipulaci se spotřebičem jsou nutní dva lidé.</li> <li>▶ Použijte pouze vhodné nástroje a zařízení.</li> </ul>

	<b>⚠ POZOR</b>
	<p><b>Ostré hrany!</b> Nebezpečí řezných poranění</p> <ul style="list-style-type: none"> <li>▶ Používejte ochranné rukavice.</li> </ul>

	<b>⚠ VÝSTRAHA</b>
	<p><b>Sklouznutí nakloněných spotřebičů!</b> Zlomeniny / poranění rozdrcením</p> <ul style="list-style-type: none"> <li>▶ Zajistěte spotřebiče proti sklouznutí.</li> </ul>

	<b>⚠ POZOR</b>
	<p><b>Nebezpečí padajících dílů kvůli uvolněným šroubům!</b> Poranění padajícími díly.</p> <ul style="list-style-type: none"> <li>▶ Zajistěte jednotlivé součásti před pádem.</li> </ul>

	<b>POZOR!</b>
	<p><b>Nebezpečí padajících dílů kvůli uvolněným šroubům!</b> Poškození jiných částí spotřebiče nebo prvků domácnosti zákazníka, např. podlahy.</p> <ul style="list-style-type: none"> <li>▶ Zajistěte jednotlivé součásti před pádem.</li> </ul>

Požadavek:

- ✔ Spotřebič je odpojený od přívodu elektrické energie.
- ✔ Vnitřní kování spotřebiče je odstraněno.
- ✔ Horní závěs je vyjmutý.

✔ Střední závěs je vyjmutý.

### 4.6.1 Vyjmutí spodního závěsu dvířek

- ▶ 1. Vyjměte dvířka mrazicí přihrádky (1).
- ▶ 2. Vyšroubujte šrouby (2).
- ▶ 3. Vytočte spodní závěs (3).
- ▶ 4. Vyjměte spodní závěs (4).

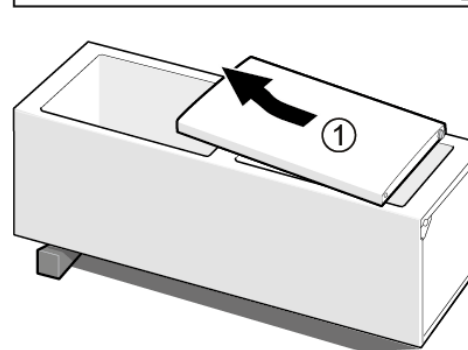
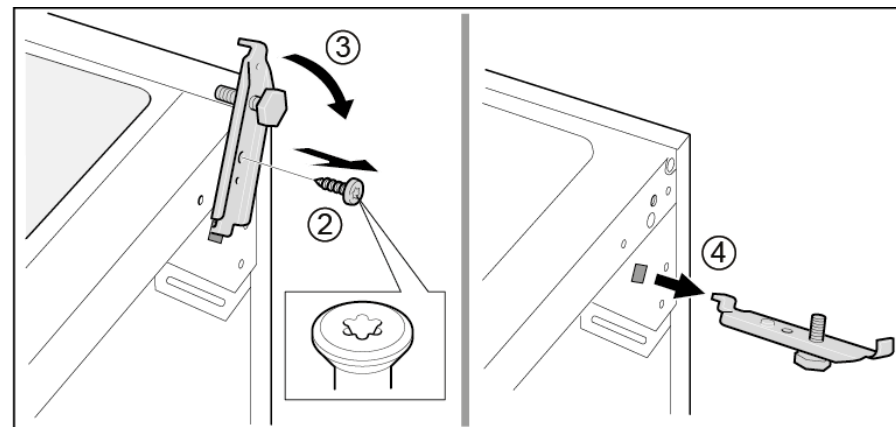

➡ Spodní závěs dvířek je vyjmutý.

### 4.6.2 Montáž spodního závěsu dvířek

- ▶ Montáž proveďte v opačném sledu.

## 4.7 Výměna odkládací plochy

### Požadavek:

- ✔ Dvířka jsou otevřená.

### 4.7.1 Vyjmutí odkládací plochy

- ▶ Vytáhněte odkládací plochu.

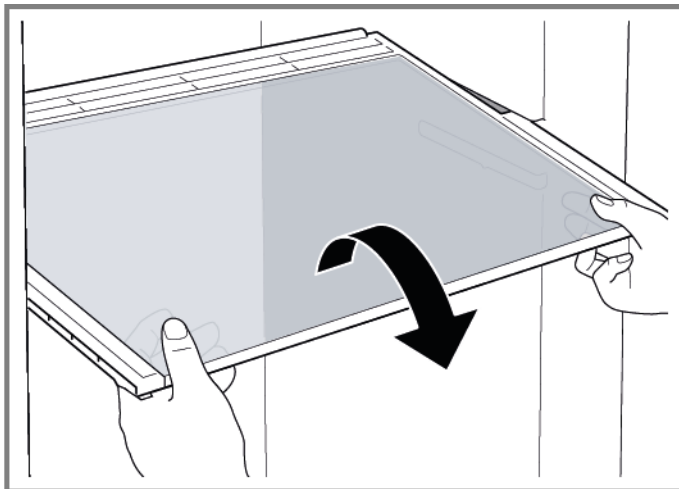

- ➡ Odkládací plocha je vyjmutá.

### 4.7.2 Montáž odkládací plochy

- ▶ Montáž proveďte v opačném sledu.

## 4.8 Výměna variabilní odkládací plochy

### Požadavek:

- ✔ Dvířka jsou otevřená.

### 4.8.1 Vyjmutí variabilní odkládací plochy

1. Pravou část variabilní odkládací plochy vytáhněte dopředu (1).
2. Vyjměte pravou část variabilní odkládací plochy (2).

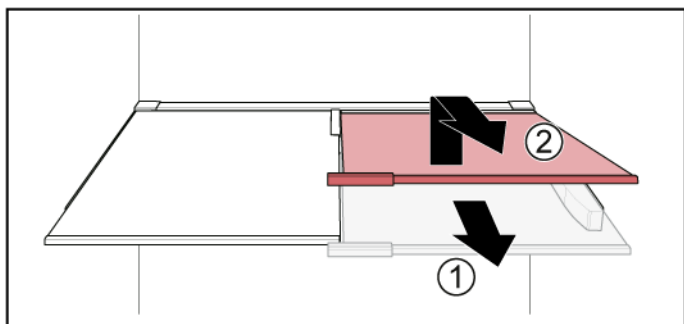

2. Stejným způsobem vyjměte levou část variabilní odkládací plochy.

- ➡ Variabilní odkládací plocha je vyjmutá.

### 4.8.2 Montáž variabilní odkládací plochy

- ▶ Montáž provedte v opačném sledu.

## 4.9 Výměna flexibilní odkládací plochy

### Požadavek:

- ✔ Dvířka jsou otevřená.

### 4.9.1 Vyjmutí flexibilní odkládací plochy

- ▶ 1. Vyjměte skleněnou polici (1).
- ▶ 2. Zvedněte variabilní odkládací plochu a vytáhněte ji ven (2).

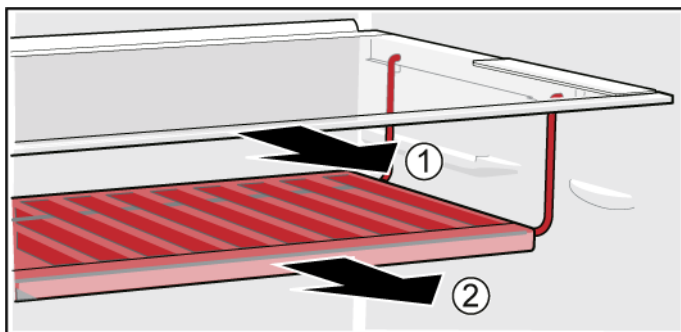

- ➡ Flexibilní odkládací plocha je vyjmutá.

### 4.9.2 Montáž flexibilní odkládací plochy

- ▶ Montáž proveďte v opačném sledu.

## 4.10 Výměna snídaňové sady

### Požadavek:

- ✔ Dvířka jsou otevřená.

### 4.10.1 Vyjmutí snídaňové sady

- ▶ Zvedněte snídaňovou sadu a vytáhněte ji.

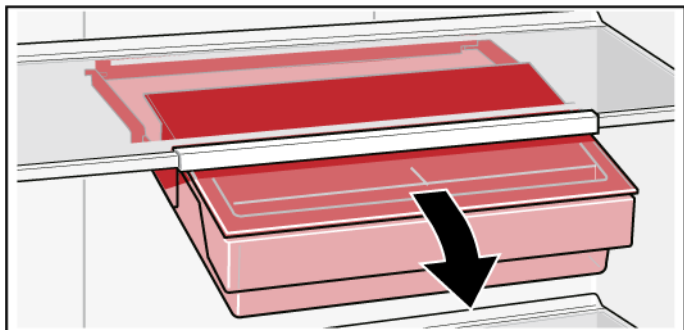

- ➡ Snídaňová sada je vyjmutá.

### 4.10.2 Montáž snídaňové sady

- ▶ Montáž proveďte v opačném sledu.

## 4.11 Výměna držáku na láhve

### Požadavek:

- ✔ Dvířka jsou otevřená.

### 4.11.1 Vyjmutí držáku na láhve

- ▶ Vytáhněte držák na láhve.

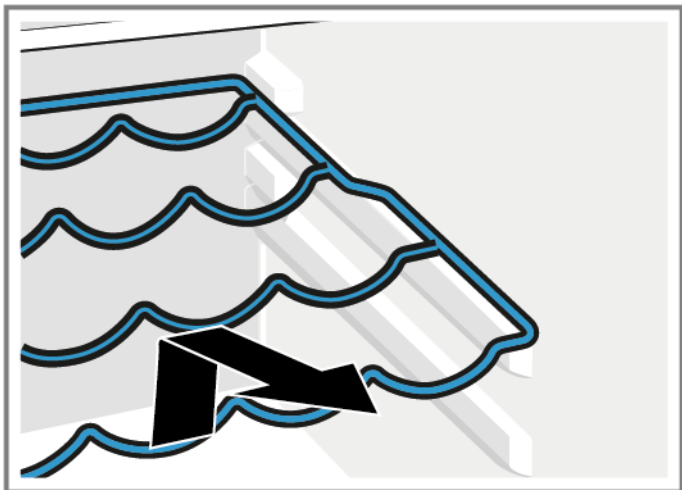

- ➡ Držák na láhve je vyjmutý.

### 4.11.2 Montáž držáku na láhve

- ▶ Montáž provedte v opačném sledu.

## 4.12 Výměna dveřní přihrádky

### Požadavek:

- ✔ Dvířka jsou otevřená.

### 4.12.1 Vyjmutí dveřní přihrádky

- ▶ Zvedněte dveřní přihrádku nahoru.

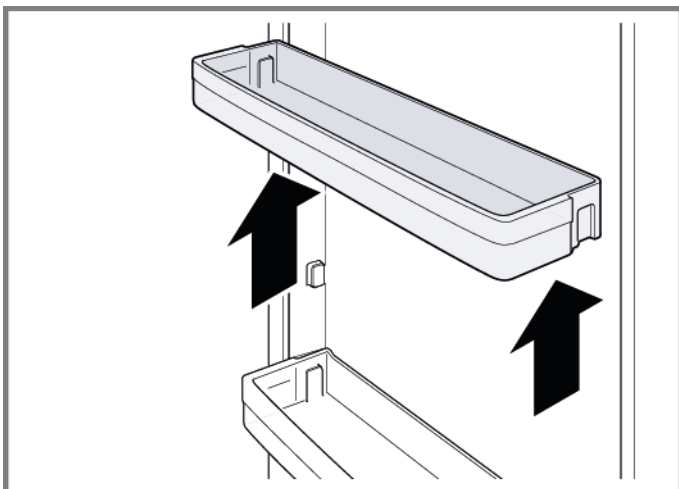

- ➡ Dveřní přihrádka je vyjmutá.

### 4.12.2 Montáž dveřní přihrádky

- ▶ Montáž proveďte v opačném sledu.

## 4.13 Výměna zásobníku na zmrazené potraviny

### Požadavek:

- ✔ Dvířka jsou otevřená.

### 4.13.1 Vyjmutí zásobníku na zmrazené potraviny

- ▶ 1. Úplně vytáhněte zásobník na zmrazené potraviny (1).
- ▶ 2. Vyjměte zásobník na potraviny (2).

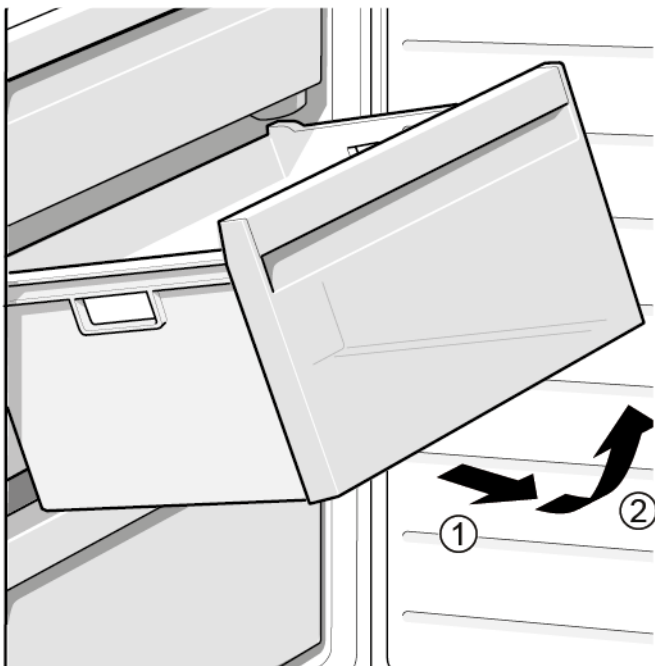

- ➡ Zásobník na zmrazené potraviny je vyjmutý.

### 4.13.2 Montáž zásobníku na zmrazené potraviny

- ▶ Montáž proveďte v opačném sledu.

## 4.14 Výměna zásobníku

### Požadavek:

- ✔ Dvířka jsou otevřená.

### 4.14.1 Vyjmutí zásobníku

- ▶ 1. Vytáhněte spodní zásobník chladničky (1).
- ▶ 2. Vytáhněte horní zásobník chladničky (2).

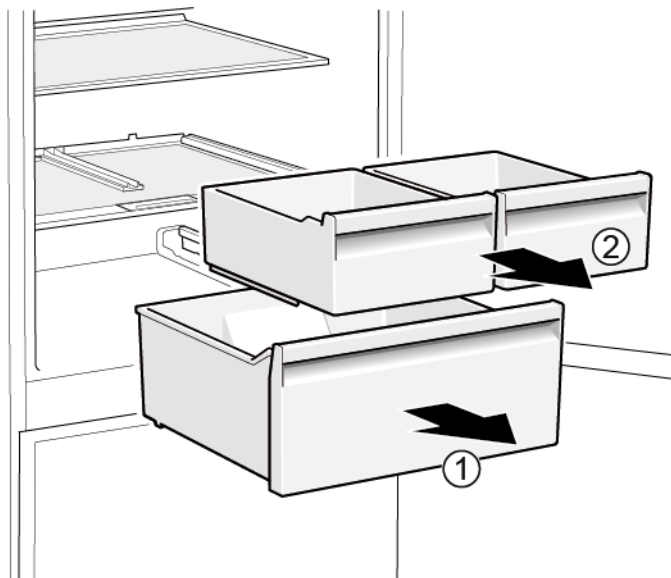

- ➡ Zásobníky jsou vyjmuté.

### 4.14.2 Montáž zásobníku

- ▶ Montáž proveďte v opačném sledu.

## 4.15 Výměna výsuvného zásobníku

### Požadavek:

- ✔ Dvířka jsou otevřená.

### 4.15.1 Vyjmutí výsuvného zásobníku

- ▶ 1. Úplně vytáhněte výsuvný zásobník (1).
- ▶ 2. Vyjměte výsuvný zásobník (2).

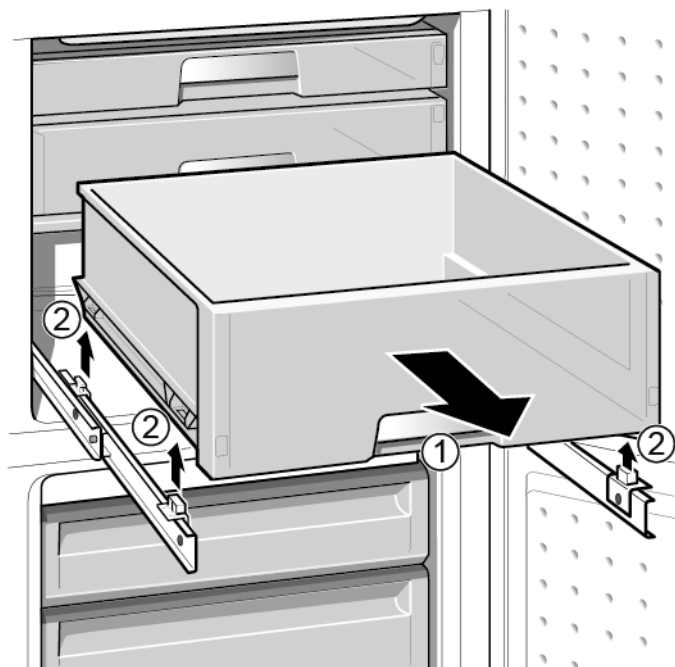

- ➡ Výsuvný zásobník je vyjmutý.

### 4.15.2 Montáž výsuvného zásobníku

- ▶ Montáž proveďte v opačném sledu.

## 4.16 Výměna LED bodového osvětlení

### Speciální nástroje:

Speciální nástroj [00342180]



Váš spotřebič je vybaven bezúdržbovým LED osvětlením.  
Tato osvětlení smí být opravena pouze zákaznickým servisem nebo oprávněným technikem!



### NEBEZPEČÍ

**Nebezpečí úrazu elektrickým proudem při dotyku dílů pod proudem!**  
V případě neodborné opravy hrozí nebezpečí smrtelného úrazu elektrickým proudem

- ▶ Opravu elektrického zařízení smí provádět jen kvalifikovaný elektrikář.
- ▶ Po opravě nechte provést bezpečnostní zkoušku podle VDE 0701 nebo specifických předpisů dané země.



### NEBEZPEČÍ

**Nebezpečí úrazu elektrickým proudem při dotyku dílů pod proudem!**  
Usmrcení elektrickým proudem

- ▶ Odpojte spotřebič od přívodu elektrického proudu alespoň 60 sekund před zahájením opravy.



### POZOR

**Ostré hrany!**  
Nebezpečí řezných poranění

- ▶ Používejte ochranné rukavice.

### Požadavek:

- ✔ Spotřebič je odpojený od přívodu elektrické energie.
- ✔ Dvířka jsou otevřená.

### 4.16.1 Vyjmutí LED bodového osvětlení

1. Pro vytažení LED bodového osvětlení použijte speciální nástroj (1).

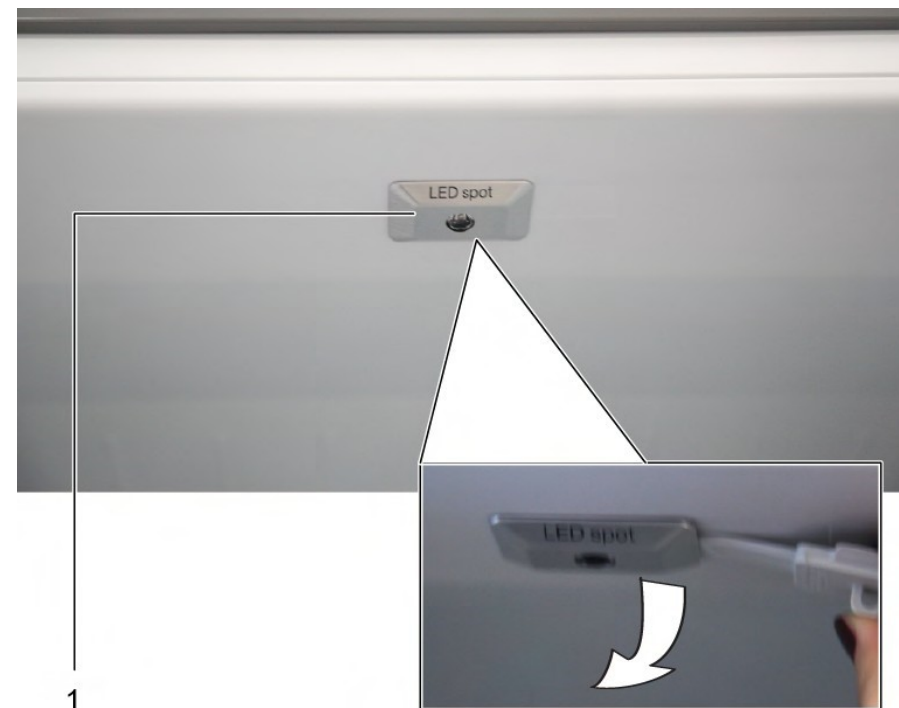

2. Odpojte elektrické připojení LED bodového osvětlení.  
➡ LED bodové osvětlení je vyjmuté.

### 4.16.2 Montáž LED bodového osvětlení

- ▶ Montáž proveďte v opačném sledu.

## 4.17 Výměna LED horního osvětlení

### Speciální nástroje:

-  Plochý šroubovák
- Čepel 2,4 mm x 0,4 mm x 60 mm, v sadě [00341820]



Váš spotřebič je vybaven bezúdržbovým LED osvětlením. Tato osvětlení smí být opravena pouze zákaznickým servisem nebo oprávněným technikem!



### NEBEZPEČÍ

**Nebezpečí úrazu elektrickým proudem při dotyku dílů pod proudem!**  
V případě neodborné opravy hrozí nebezpečí smrtelného úrazu elektrickým proudem

- ▶ Opravu elektrického zařízení smí provádět jen kvalifikovaný elektrikář.
- ▶ Po opravě nechte provést bezpečnostní zkoušku podle VDE 0701 nebo specifických předpisů dané země.



### NEBEZPEČÍ

**Nebezpečí úrazu elektrickým proudem při dotyku dílů pod proudem!**  
Usmrcení elektrickým proudem

- ▶ Odpojte spotřebič od přívodu elektrického proudu alespoň 60 sekund před zahájením opravy.





### POZOR

**Ostré hrany!**  
Nebezpečí řezných poranění

- ▶ Používejte ochranné rukavice.

### Požadavek:

-  Spotřebič je odpojený od přívodu elektrické energie.
-  Dvířka jsou otevřená.
-  Horní vnitřní kování je vyjmuto.

### 4.17.1 Vyjmutí LED osvětlení

1. Posuňte LED osvětlení k levé straně.



-  Elektrické připojení LED osvětlení je odpojené.

2. Uvolněte háky LED osvětlení.

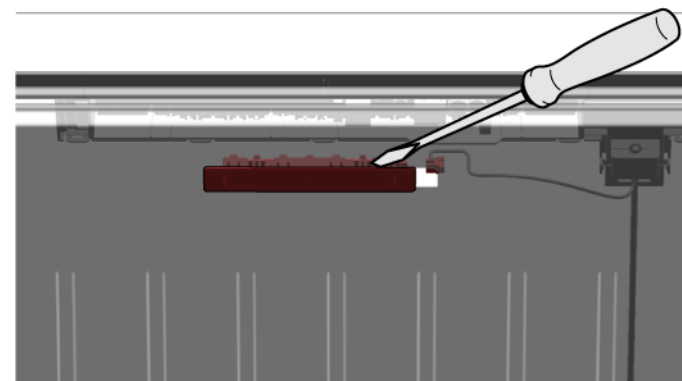

3. Odstraňte LED osvětlení jeho posunutím dopředu.

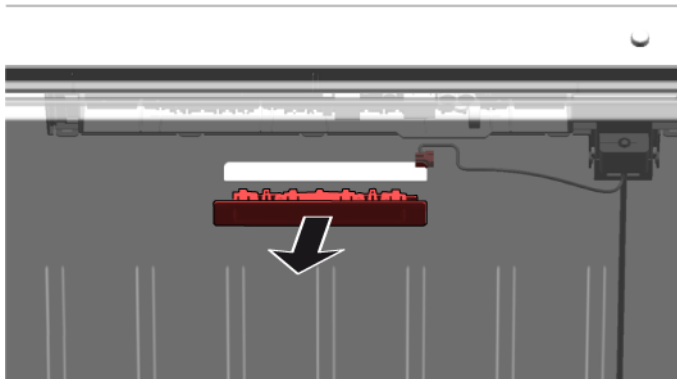

- ➔ LED osvětlení je vyjmuté.

### 4.17.2 Montáž horního LED osvětlení

- ▶ Montáž proveďte v opačném sledu.

## 4.18 Výměna LED osvětlení boční lišty

### Speciální nástroje:

 Přísavka Ø50 mm [00342224]



Váš spotřebič je vybaven bezúdržbovým LED osvětlením.  
Tato osvětlení smí být opravena pouze zákaznickým servisem nebo oprávněným technikem!



### NEBEZPEČÍ

**Nebezpečí úrazu elektrickým proudem při dotyku dílů pod proudem!**  
V případě neodborné opravy hrozí nebezpečí smrtelného úrazu elektrickým proudem

- ▶ Opravu elektrického zařízení smí provádět jen kvalifikovaný elektrikář.
- ▶ Po opravě nechte provést bezpečnostní zkoušku podle VDE 0701 nebo specifických předpisů dané země.



### NEBEZPEČÍ

**Nebezpečí úrazu elektrickým proudem při dotyku dílů pod proudem!**  
Usmrcení elektrickým proudem

- ▶ Odpojte spotřebič od přívodu elektrického proudu alespoň 60 sekund před zahájením opravy.





### POZOR

**Ostré hrany!**  
Nebezpečí řezných poranění

- ▶ Používejte ochranné rukavice.

### Požadavek:

-  Spotřebič je odpojený od přívodu elektrické energie.
-  Dvířka jsou otevřená.
-  Odkládací plochy chladicí přihrádky jsou vyjmuté.

### 4.18.1 Vyjmutí LED osvětlení boční lišty

1. Přilepte přísavku na horní třetinu LED boční lišty.



2. Otočením vytáhněte dopředu přísavku s LED osvětlením boční lišty.







3. Odpojte elektrické připojení LED osvětlení boční lišty.  
➡ LED osvětlení boční lišty je vyjmuté.

### 4.18.2 Montáž LED osvětlení boční lišty

1. Zapojte elektrické připojení LED osvětlení boční lišty.
  2. Upevněte LED osvětlení boční lišty na své místo ve stěně přihrádky (háky musí zaklapnout).
- ➡ LED osvětlení boční lišty je namontované.

# Tip til reparation - Køle-/frysekombination

 <b>Om dette dokument</b> .....	<b>84</b>
1.1 Vigtig information.....	84
1.1.1 Formål.....	84
1.2 Forklaring af symboler .....	84
1.2.1 Fareniveauer .....	84
1.2.2 Faresymboler.....	84
1.2.3 Advarslernes opbygning .....	85
1.2.4 Generelle symboler .....	85
 <b>Sikkerhed</b> .....	<b>86</b>
2.1 Generelle sikkerhedsanvisninger .....	86
2.1.1 Alle husholdningsapparater .....	86
 <b>Værktøjer og hjælpemidler</b> .....	<b>87</b>
 <b>Reparation</b> .....	<b>88</b>
4.1 Udskiftning af dørpakning.....	88
4.2 Udskiftning af dørhåndtag .....	89
4.2.1 Fjernelse af dørhåndtag .....	89
4.2.2 Montering af dørhåndtag .....	89
4.3 Udskiftning af øverste dørhængsel .....	90
4.3.1 Fjernelse af øverste dørhængsel.....	90
4.3.2 Montering af øverste dørhængsel .....	91
4.4 Udskiftning af det øverste dørhængsel (dør med display).....	92
4.4.1 Fjernelse af øverste dørhængsel.....	92
4.4.2 Montering af øverste dørhængsel .....	93
4.5 Udskiftning af midterste dørhængsel.....	94
4.5.1 Fjernelse af midterste dørhængsel.....	94
4.5.2 Montering af midterste dørhængsel.....	94
4.6 Udskiftning af nederste dørhængsel .....	95
4.6.1 Fjernelse af nederste dørhængsel.....	95
4.6.2 Montering af nederste dørhængsel.....	95
4.7 Udskiftning af hylde .....	96
4.7.1 Fjernelse af hylde.....	96
4.7.2 Montering af hylde .....	96
4.8 Udskiftning af indstillelig hylde.....	97

4.8.1 Fjernelse af indstillelig hylde.....	97
4.8.2 Montering af indstillelig hylde.....	97
4.9 Udskiftning af fleksibel hylde .....	98
4.9.1 Fjernelse af fleksibel hylde .....	98
4.9.2 Montering af fleksibel hylde .....	98
4.10 Udskiftning af morgenmadssæt.....	99
4.10.1 Fjernelse morgenmadssæt.....	99
4.10.2 Montering af morgenmadssæt.....	99
4.11 Udskiftning af flaskehylde .....	100
4.11.1 Fjernelse af flaskehylde .....	100
4.11.2 Montering af flaskehylde .....	100
4.12 Udskiftning af dørhylde.....	101
4.12.1 Fjernelse af dørhylde .....	101
4.12.2 Montering af dørhylde .....	101
4.13 Udskiftning af frostvarebeholder.....	102
4.13.1 Fjernelse af frostvarebeholder .....	102
4.13.2 Montering af frostvarebeholder .....	102
4.14 Udskiftning af beholder.....	103
4.14.1 Fjernelse af beholder .....	103
4.14.2 Montering af beholder .....	103
4.15 Udskiftning af udtrækkelig beholder.....	104
4.15.1 Fjernelse af udtrækkelig beholder.....	104
4.15.2 Montering af udtrækkelig beholder.....	104
4.16 Udskiftning af LED-spotlampe.....	105
4.16.1 Fjernelse af LED-spotlampe .....	105
4.16.2 Montering af LED-spotlampe.....	105
4.17 Udskiftning af LED-lampe foroven .....	106
4.17.1 Fjernelse af LED-lampe .....	106
4.17.2 Montering af LED-lampe foroven .....	107
4.18 Udskiftning af LED-sidebjælkelampe .....	108
4.18.1 Fjernelse LED-sidebjælkelampe .....	108
4.18.2 Montering af LED-sidebjælkelampe .....	109

# **i** Om dette dokument

## 1.1 Vigtig information

### 1.1.1 Formål

Disse reparationsanvisninger hjælper kunden til selv at kunne reparere apparater i henhold til den gældende lovgivning om miljøvenligt design (fra 03/2021).





De indeholder information om, hvordan der udskiftes bestemte reservedele, herunder advarsler og risici.

Kontakt kundeservice i tilfælde af spørgsmål. Vi påtager os kun ansvar for skader, hvis reparationsanvisningerne er fuldt korrekt.

## 1.2 Forklaring af symboler

### 1.2.1 Fareniveauer

Advarselsniveauerne består af et symbol og et signalford. Signalfordene indikerer farens alvor.





Advarselsniveau	Betydning
 <b>FARE</b>	Manglende overholdelse af advarselsmeddelelsen vil medføre død eller alvorlige kvæstelser.
 <b>ADVARSEL</b>	Manglende overholdelse af advarselsmeddelelsen kan medføre død eller alvorlige kvæstelser.
 <b>PAS PÅ!</b>	Manglende overholdelse af advarselsmeddelelsen kan medføre mindre kvæstelser.
 <b>BEMÆRK!</b>	Manglende overholdelse af advarselsmeddelelsen kan medføre materiel beskadigelse.

Tabel 1: Fareniveauer





### 1.2.2 Faresymboler

Faresymboler er symbolske visninger, der giver en indikation af faretypen.

Der anvendes følgende faresymboler i dette dokument:

Faresymbol	Betydning
	Generel advarselsmeddelelse
	Fare for elektrisk spænding
	Eksplussionsfare
	Fare for at skære sig

## i Om dette dokument

Faresymbol	Betydning
	Fare for klemning
	Fare pga. varme overflader
	Fare pga. kraftigt magnetfelt
	Fare pga. ikke-ioniserende stråling

Tabel 2: Faresymboler

### 1.2.3 Advarslernes opbygning

Advarsler i dette dokument har et standardiseret udseende og en standardiseret opbygning.

	<div style="background-color: red; color: white; padding: 2px; text-align: center;"><b>FARE</b></div> <p><b>Farens type og kilde!</b>            Mulige følger, hvis faren/advarslen ignoreres.</p> <ul style="list-style-type: none"> <li>▶ Foranstaltninger og forbud for at forhindre faren.</li> </ul>
--	--

De følgende eksempler viser en advarsel, der advarer mod elektrisk stød pga. spændingsførende dele. Foranstaltningen til at undgå faren er nævnt.

	<div style="background-color: red; color: white; padding: 2px; text-align: center;"><b>FARE</b></div> <p><b>Fare for elektrisk stød pga. spændingsførende dele!</b>            Død ved elektrisk stød</p> <ul style="list-style-type: none"> <li>▶ Afbryd apparater fra strømforsyningen i mindst 60 sekunder, før reparationer påbegyndes.</li> </ul>
--	--

### 1.2.4 Generelle symboler

Der anvendes følgende generelle symboler i dette dokument:

Generelt symbol	Betydning
	Angivelse af et særligt tip (tekst og/eller grafik)
	Angivelse af et simpelt tip (kun tekst)
	Angivelse af et link til en videotutorial
	Angivelse af nødvendige værktøjer
	Angivelse af krævede forudsætninger
	Angivelse af en betingelse (hvis..., så...)
	Angivelse af et resultat
[Start]	Angivelse af en tast eller knap
[00123456]	Angivelse af et materialenummer
Status	Angivelse af en vist tekst/et vist vindue (i apparatets display)

Tabel 3: Generelle symboler

## 2.1 Generelle sikkerhedsanvisninger

### 2.1.1 Alle husholdningsapparater

#### **Fare for elektrisk stød pga. spændingsførende dele!**

- Fejl i forbindelse med reparationer, der involverer elektriske komponenter, kan medføre elektrisk stød!
- Afbryd apparatet fra strømnettet i mindst 60 sekunder, før arbejdet påbegyndes.
- Få efter reparationen udført en sikkerhedstest i henhold til VDE 0701 eller landespecifikke forskrifter.

#### **Fare for tilskadekomst pga. skarpe kanter!**

- Brug beskyttelseshandsker.

#### **Fare for klemning i forbindelse med reparation, vedligeholdelse, fejlafhjælpning og service på grund af tunge og bevægelige komponenter**

- Brug sikkerhedssko.
- Sørg for at sikre tunge komponenter mod at falde ned.
- Stik kropsdele ind i bevægelige komponenter.

#### **Fare for apparatets sikkerhed/funktion!**

- Brug kun originale reservedele.

#### **Fare for beskadigelse af elektrostatisk følsomme komponenter (elektrostatiske afladninger)!**

- Berør ikke modulerne, herunder forbindelser og ledningsbaner.

## Værktøjer og hjælpemidler

Betegnelse	Detaljer	Billeder
Beskyttelsesklud [00342013]	60 cm x 50 cm	
Sæt med præcisionskruetrækkere [00341820]	9 stk., 2,0 mm, 2,4 mm, 3,0 mm, PH0, PH00, PH1, TX6, TX8, TX9	
Hjælpeværktøj [00342180]	Værktøj til at løsne plastikdele ud "magic tool"	
Sugekop [00342224]	Ø 50 mm	
Torx-bit TX20 [00340865]	6,3 mm (1/4")	
Kærnskruetrækker	Blad 10 mm x 1,6 mm x 200 mm	



## **4.1 Udskiftning af dørpakning**

### **Preindstilling:**



- Døren er åben.

## 4.2 Udskiftning af dørhåndtag

### Nødvendig værktøj:

-  Torx-bit TX20                      6,3 mm (1/4")                      [00340865]
-  Kærviskruetrækker                      Blad 10 mm x 1,6 mm x 200 mm

### Preindstilling:

-  Apparatet er afbrudt fra strømforsyningen.
-  Døren er åben.

### 4.2.1 Fjernelse af dørhåndtag

- ▶ 1. Fjern de to skruehætter (1).
- ▶ 2. Skru de to skruer ud (2).
- ▶ 3. Fjern dørhåndtaget (3).

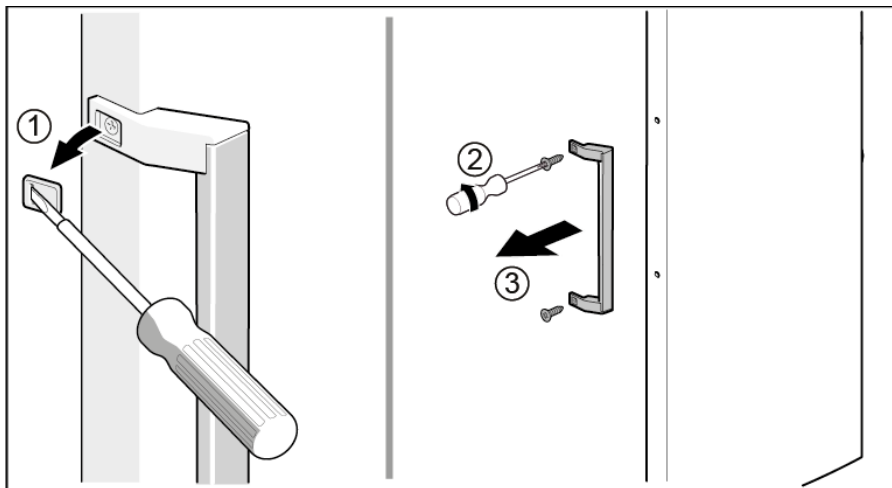

 Dørhåndtaget er fjernet.



Dørhåndtaget til den anden dør kan fjernes på samme måde.

### 4.2.2 Montering af dørhåndtag

- ▶ Montér i omvendt rækkefølge.

## 4.3 Udskiftning af øverste dørhængsel

### Nødvendig værktøj:

🌀 Torx-bit TX20

6,3 mm (1/4")

[00340865]



#### ⚠️ ADVARSEL

##### Tunge, store apparater!

Ryg- og muskelskader

- ▶ Arbejde til fjernelse af apparatets dør bør kun udføres af uddannede specialister.
- ▶ Der skal være to personer om at flytte apparatet.
- ▶ Brug kun egnet værktøj og udstyr.



#### ⚠️ PAS PÅ!

##### Skarpe kanter!

Snitlæsioner

- ▶ Brug beskyttelseshandsker.



#### ⚠️ ADVARSEL

##### Apparater på skrå kan glide!

Knoglebrud/klemskader

- ▶ Sørg for at sikre apparater mod at glide.



#### ⚠️ PAS PÅ!

##### Fare for nedfaldende dele pga. løsnede skruer!

Personskade pga. nedfaldende dele.

- ▶ Sørg for at sikre komponenten mod at falde ned.



#### 📌 BEMÆRK!

##### Fare for nedfaldende dele pga. løsnede skruer!

Beskadigelse af andre apparatdele eller kundens hjem, f.eks. gulvet.

- ▶ Sørg for at sikre komponenten mod at falde ned.

### Preindstilling:

- ✔️ Apparatet er afbrudt fra strømforsyningen.
- ✔️ Indvendigt tilbehør i apparatet er fjernet.

## 4.3.1 Fjernelse af øverste dørhængsel

1. Læg apparatet med bagsiden nedad.

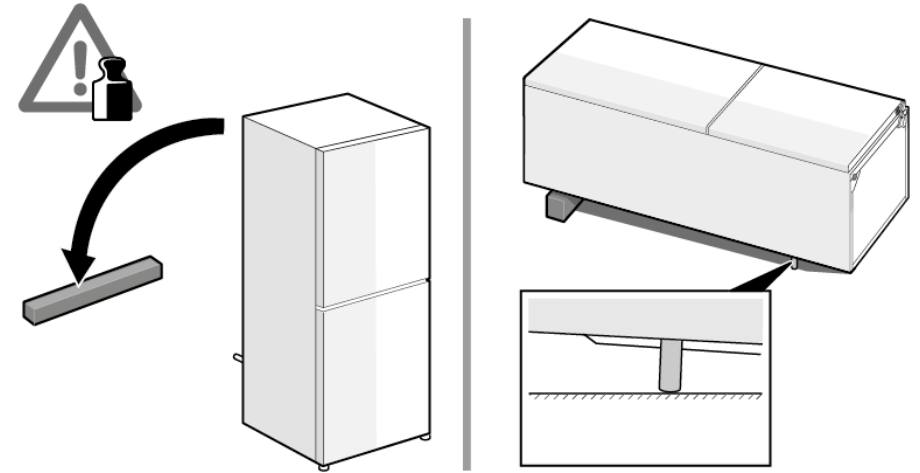

## Reparation

2. 1. Tryk det øverste hængsels afdækning på begge sider (1).
2. Bevæg det øverste hængsels afdækning ud (2).
3. Drej hængslets afdækning (3).
4. Fjern det øverste hængsels afdækning (4).
5. Skru de to skruer ud (5).
6. Fjern det øverste hængsel (6).

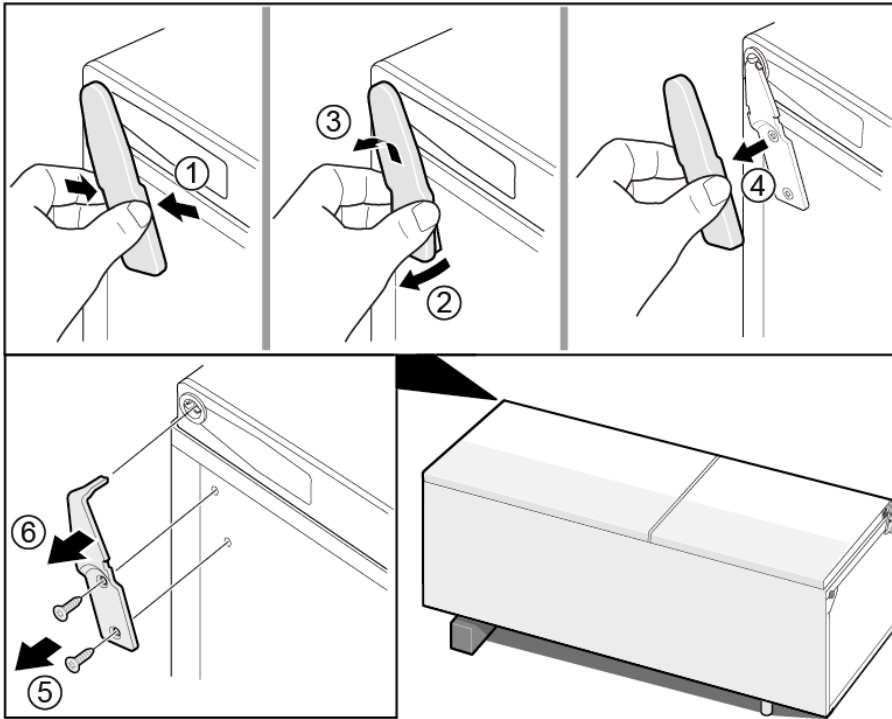

 Det øverste hængsel er fjernet.

### 4.3.2 Montering af øverste dørhængsel

- ▶ Montér i omvendt rækkefølge.

## 4.4 Udskiftning af det øverste dørhængsel (dør med display)

Nødvendig værktøj:

Torx-bit TX20 6,3 mm (1/4") [00340865]

	<b>⚠ ADVARSEL</b>
	<p><b>Tunge, store apparater!</b> Ryg- og muskelskader</p> <ul style="list-style-type: none"> <li>▶ Arbejde til fjernelse af apparatets dør bør kun udføres af uddannede specialister.</li> <li>▶ Der skal være to personer om at flytte apparatet.</li> <li>▶ Brug kun egnet værktøj og udstyr.</li> </ul>

	<b>⚠ PAS PÅ!</b>
	<p><b>Skarpe kanter!</b> Snitlæsioner</p> <ul style="list-style-type: none"> <li>▶ Brug beskyttelseshandsker.</li> </ul>

	<b>⚠ ADVARSEL</b>
	<p><b>Apparater på skrå kan glide!</b> Knoglebrud/klemskader</p> <ul style="list-style-type: none"> <li>▶ Sørg for at sikre apparater mod at glide.</li> </ul>

	<b>⚠ PAS PÅ!</b>
	<p><b>Fare for nedfaldende dele pga. løsnede skruer!</b> Personskade pga. nedfaldende dele.</p> <ul style="list-style-type: none"> <li>▶ Sørg for at sikre komponenten mod at falde ned.</li> </ul>

	<b>BEMÆRK!</b>
	<p><b>Fare for nedfaldende dele pga. løsnede skruer!</b> Beskadigelse af andre apparatdele eller kundens hjem, f.eks. gulvet.</p> <ul style="list-style-type: none"> <li>▶ Sørg for at sikre komponenten mod at falde ned.</li> </ul>

	<b>⚠ FARE</b>
	<p><b>Fare for elektrisk stød pga. spændingsførende dele!</b> Livsfare pga. elektrisk stød i tilfælde af ukorrekt reparation</p> <ul style="list-style-type: none"> <li>▶ Elektriske dele skal repareres af kvalificerede elektrikere.</li> <li>▶ Få efter reparationen udført en sikkerhedstest i henhold til VDE 0701 eller landespecifikke forskrifter.</li> </ul>

	<b>⚠ FARE</b>
	<p><b>Fare for elektrisk stød pga. spændingsførende dele!</b> Død ved elektrisk stød</p> <ul style="list-style-type: none"> <li>▶ Afbryd apparater fra strømforsyningen i mindst 60 sekunder, før reparationer påbegyndes.</li> </ul>

Preindstilling:

- ✓ Apparatet er afbrudt fra strømforsyningen.
- ✓ Indvendigt tilbehør i apparatet er fjernet.

### 4.4.1 Fjernelse af øverste dørhængsel

1. Læg apparatet med bagsiden nedad.

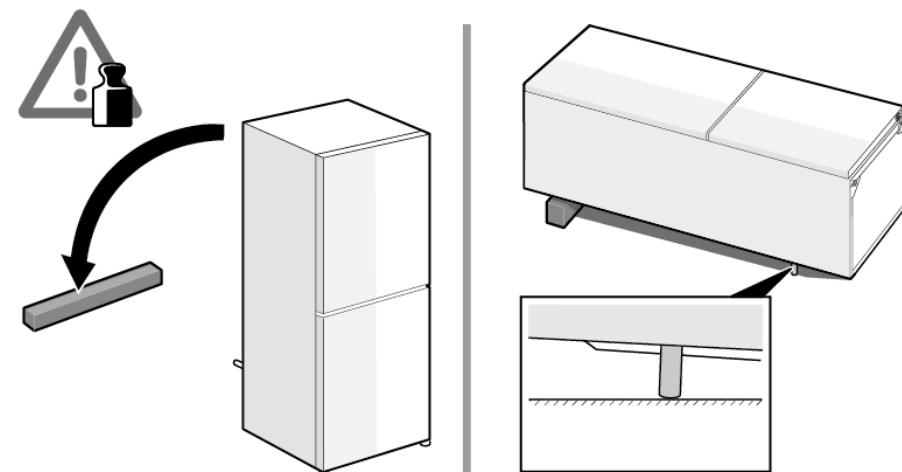

## Reparation

2. 1. Fjern det øverste hængsels afdækning (1).
2. Fjern kabelboksens afdækning (2).
3. Afbryd den elektriske tilslutning (3).
4. Skru jordforbindelsesskruen ud (4).
5. Fjern kabelbeskyttelsen (5).
6. Skru skruen ud (6).

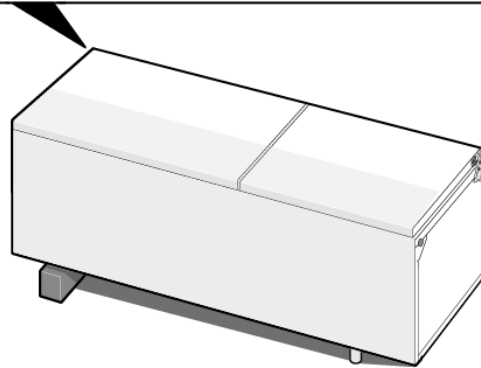
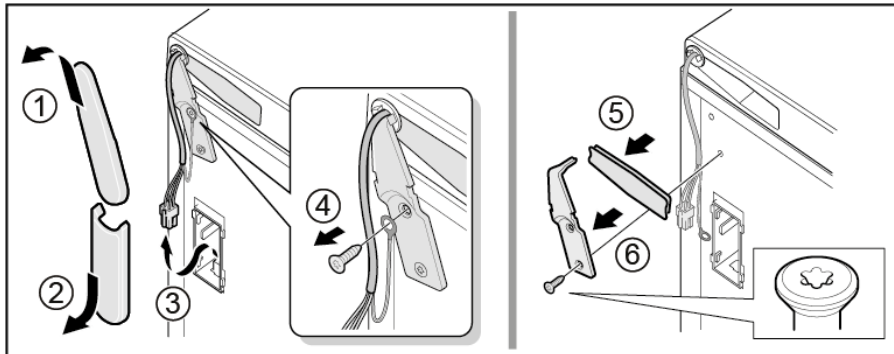

 Det øverste hængsel er fjernet.

### 4.4.2 Montering af øverste dørhængsel

- ▶ Montér i omvendt rækkefølge.

## 4.5 Udskiftning af midterste dørhængsel

### Nødvendig værktøj:

🌀 Torx-bit TX20

6,3 mm (1/4")

[00340865]

	<b>⚠ ADVARSEL</b>
	<p><b>Tunge, store apparater!</b> Ryg- og muskelskader</p> <ul style="list-style-type: none"> <li>▶ Arbejde til fjernelse af apparatets dør bør kun udføres af uddannede specialister.</li> <li>▶ Der skal være to personer om at flytte apparatet.</li> <li>▶ Brug kun egnet værktøj og udstyr.</li> </ul>

	<b>⚠ PAS PÅ!</b>
	<p><b>Skarpe kanter!</b> Snitlæsioner</p> <ul style="list-style-type: none"> <li>▶ Brug beskyttelseshandsker.</li> </ul>

	<b>⚠ ADVARSEL</b>
	<p><b>Apparater på skrå kan glide!</b> Knoglebrud/klemskader</p> <ul style="list-style-type: none"> <li>▶ Sørg for at sikre apparater mod at glide.</li> </ul>

	<b>⚠ PAS PÅ!</b>
	<p><b>Fare for nedfaldende dele pga. løsnede skruer!</b> Personskade pga. nedfaldende dele.</p> <ul style="list-style-type: none"> <li>▶ Sørg for at sikre komponenten mod at falde ned.</li> </ul>

	<b>BEMÆRK!</b>
	<p><b>Fare for nedfaldende dele pga. løsnede skruer!</b> Beskadigelse af andre apparatdele eller kundens hjem, f.eks. gulvet.</p> <ul style="list-style-type: none"> <li>▶ Sørg for at sikre komponenten mod at falde ned.</li> </ul>

### Preindstilling:

- ✔ Apparatet er afbrudt fra strømforsyningen.
- ✔ Indvendigt tilbehør i apparatet er fjernet.
- ✔ Det øverste dørhængsel er fjernet.
- ✔ Den øverste dør er fjernet.

### 4.5.1 Fjernelse af midterste dørhængsel

- ▶ 1. Fjern køleafdelingens dør (1).
- ▶ 2. Skru de to skruer ud (2).
- ▶ 3. Fjern det midterste hængsel (3).

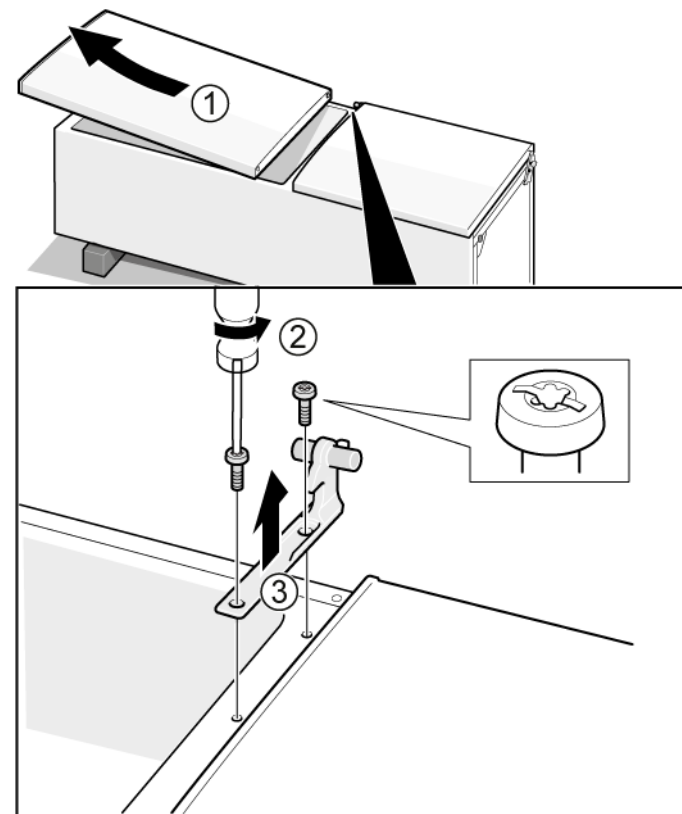

➡ Det midterste hængsel er fjernet.

### 4.5.2 Montering af midterste dørhængsel

- ▶ Montér i omvendt rækkefølge.

## 4.6 Udskiftning af nederste dørhængsel

### Nødvendig værktøj:

Torx-bit TX20 6,3 mm (1/4") [00340865]

	<b>ADVARSEL</b>
<b>Tunge, store apparater!</b>	
Ryg- og muskelskader	
<ul style="list-style-type: none"> <li>▶ Arbejde til fjernelse af apparatets dør bør kun udføres af uddannede specialister.</li> <li>▶ Der skal være to personer om at flytte apparatet.</li> <li>▶ Brug kun egnet værktøj og udstyr.</li> </ul>	

	<b>PAS PÅ!</b>
<b>Skarpe kanter!</b>	
Snitlæsioner	
<ul style="list-style-type: none"> <li>▶ Brug beskyttelseshandsker.</li> </ul>	

	<b>ADVARSEL</b>
<b>Apparater på skrå kan glide!</b>	
Knoglebrud/klemskader	
<ul style="list-style-type: none"> <li>▶ Sørg for at sikre apparater mod at glide.</li> </ul>	

	<b>PAS PÅ!</b>
<b>Fare for nedfaldende dele pga. løsnede skruer!</b>	
Personskade pga. nedfaldende dele.	
<ul style="list-style-type: none"> <li>▶ Sørg for at sikre komponenten mod at falde ned.</li> </ul>	

	<b>BEMÆRK!</b>
<b>Fare for nedfaldende dele pga. løsnede skruer!</b>	
Beskadigelse af andre apparatdele eller kundens hjem, f.eks. gulvet.	
<ul style="list-style-type: none"> <li>▶ Sørg for at sikre komponenten mod at falde ned.</li> </ul>	

### Preindstilling:

- ✔ Apparatet er afbrudt fra strømforsyningen.
- ✔ Indvendigt tilbehør i apparatet er fjernet.
- ✔ Det øverste hængsel er fjernet.
- ✔ Det midterste hængsel er fjernet.

### 4.6.1 Fjernelse af nederste dørhængsel

- ▶ 1. Fjern fryseafdelingens dør (1).
- ▶ 2. Skru skruen ud (2).
- ▶ 3. Drej det nederste hængsel ud (3).
- ▶ 4. Fjern det nederste hængsel (4).

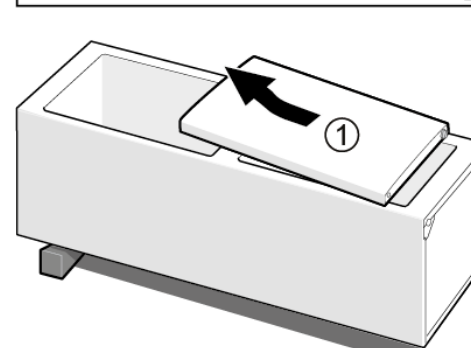
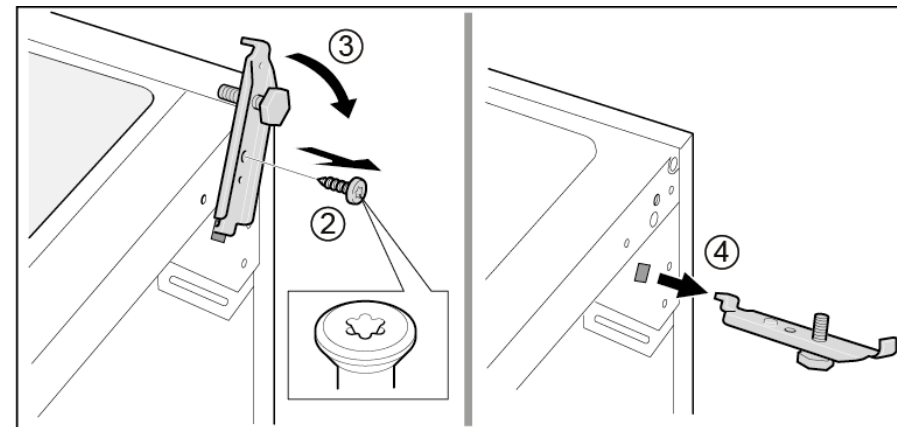

- ➡ Det nederste dørhængsel er fjernet.

### 4.6.2 Montering af nederste dørhængsel

- ▶ Montér i omvendt rækkefølge.

## 4.7 Udskiftning af hylde

### Preindstilling:

- ✔ Døren er åben.

### 4.7.1 Fjernelse af hylde

- ▶ Træk hylde ud.

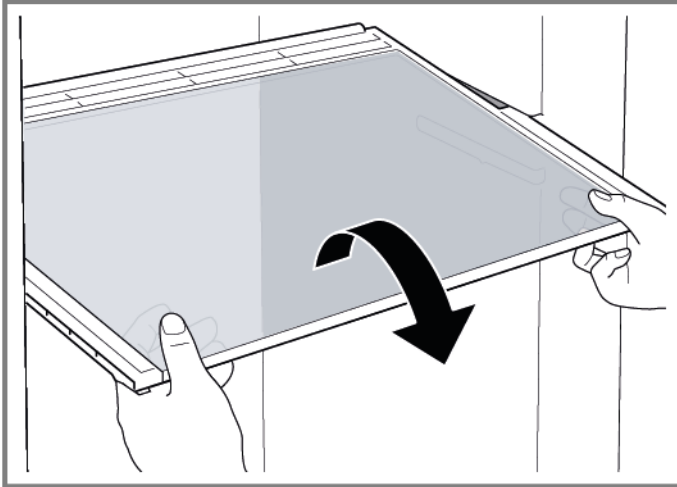

- ➡ Hylde er fjernet.

### 4.7.2 Montering af hylde

- ▶ Montér i omvendt rækkefølge.

## 4.8 Udskiftning af indstillelig hylde

### Preindstilling:

- ✔ Døren er åben.

### 4.8.1 Fjernelse af indstillelig hylde

1. Træk den indstillelige hylde højre sektion fremad (1).
2. Fjern den indstillelige hylde højre sektion (2).

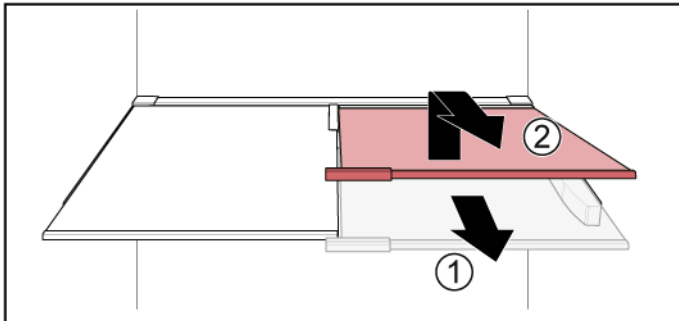

2. Fjern den indstillelige hylde venstre sektion på samme måde.

- ➡ Den indstillelige hylde er fjernet.

### 4.8.2 Montering af indstillelig hylde

- ▶ Montér i omvendt rækkefølge.

## 4.9 Udskiftning af fleksibel hylde

### Preindstilling:

- ✔ Døren er åben.

### 4.9.1 Fjernelse af fleksibel hylde

- ▶ 1. Fjern glashylden (1).
- ▶ 2. Løft den fleksible hylde, og træk den ud (2).

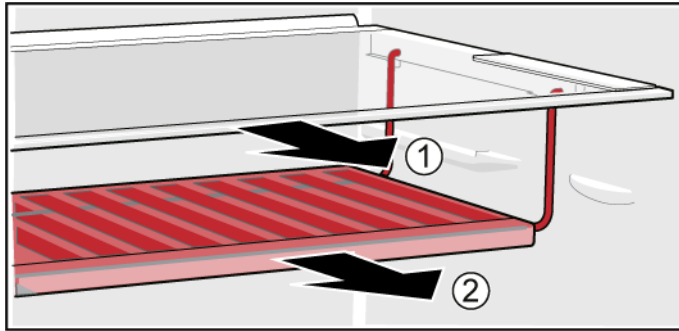

- ➡ Den fleksible hylde er fjernet.

### 4.9.2 Montering af fleksibel hylde

- ▶ Montér i omvendt rækkefølge.

## 4.10 Udskiftning af morgenmadssæt

### Preindstilling:

- ✔ Døren er åben.

### 4.10.1 Fjernelse morgenmadssæt

- ▶ Løft morgenmadssættet, og træk det ud.

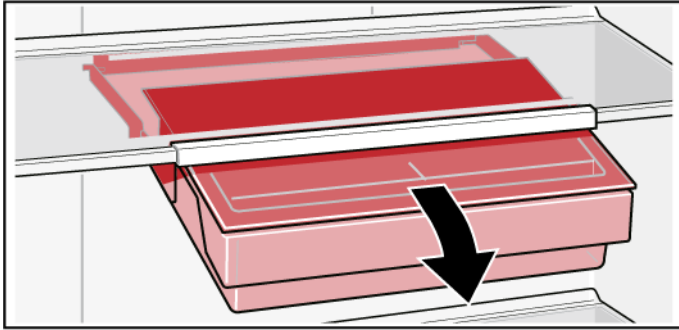

- ➡ Morgenmadssættet er fjernet.

### 4.10.2 Montering af morgenmadssæt

- ▶ Montér i omvendt rækkefølge.

## 4.11 Udskiftning af flaskehylde

### Preindstilling:

- ✔ Døren er åben.

### 4.11.1 Fjernelse af flaskehylde

- ▶ Træk flaskehylde ud.

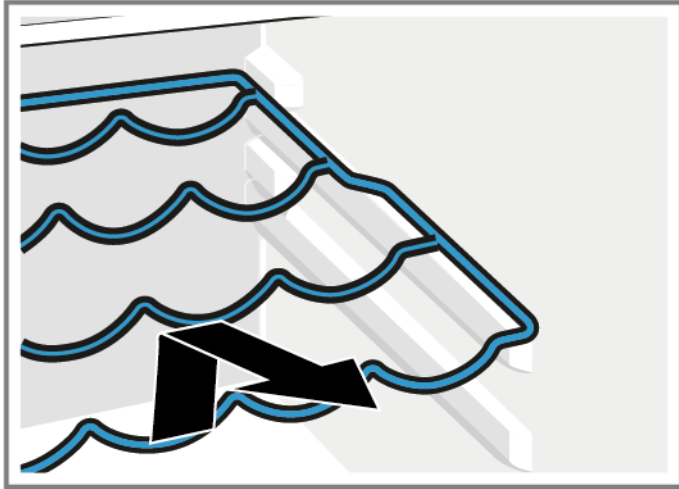

- ➡ Flaskehylde er fjernet.

### 4.11.2 Montering af flaskehylde

- ▶ Montér i omvendt rækkefølge.

## 4.12 Udskiftning af dørhylde

### Preindstilling:

- ✔ Døren er åben.

### 4.12.1 Fjernelse af dørhylde

- ▶ Løft dørhylden opad.

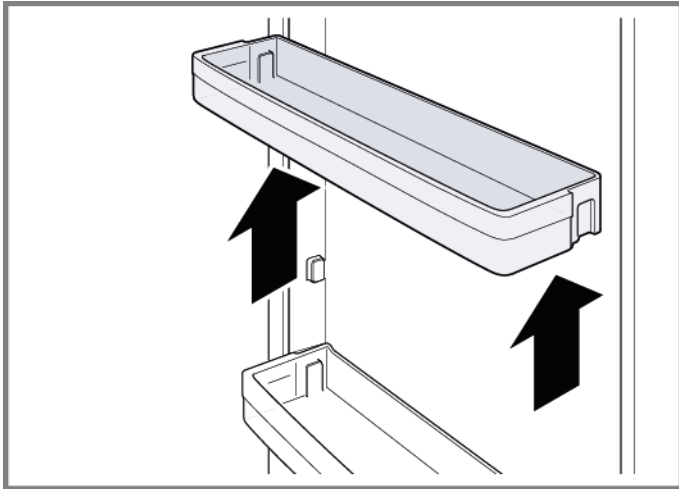

- ➡ Dørhylden er fjernet.

### 4.12.2 Montering af dørhylde

- ▶ Montér i omvendt rækkefølge.

## 4.13 Udskiftning af frostvarebeholder

### Preindstilling:

- ✔ Døren er åben.

### 4.13.1 Fjernelse af frostvarebeholder

- ▶ 1. Træk frostvarebeholderen hele vejen ud (1).
- ▶ 2. Fjern frostvarebeholderen (2).

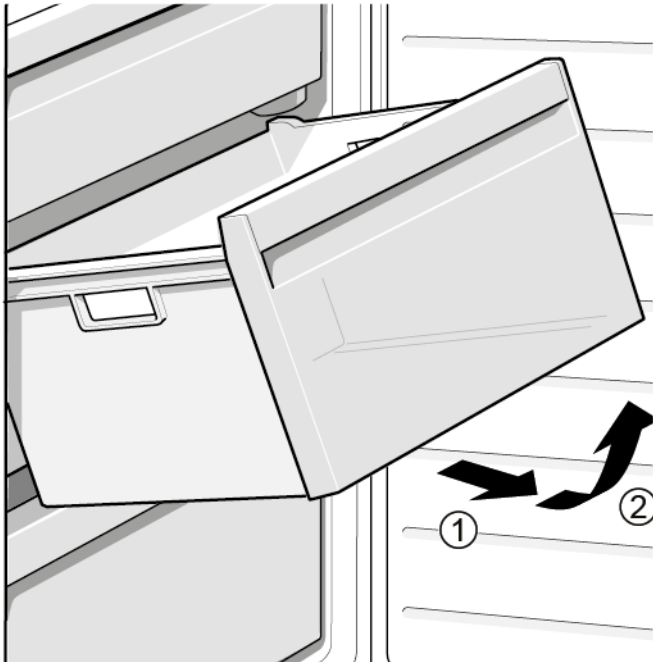

- ➡ Frostvarebeholderen er fjernet.

### 4.13.2 Montering af frostvarebeholder

- ▶ Montér i omvendt rækkefølge.

## 4.14 Udskiftning af beholder

### Preindstilling:

- ✔ Døren er åben.

### 4.14.1 Fjernelse af beholder

- ▶ 1. Bevæg den nederste køleskabsbeholder ud (1).
- ▶ 2. Bevæg den øverste køleskabsbeholder ud (2).

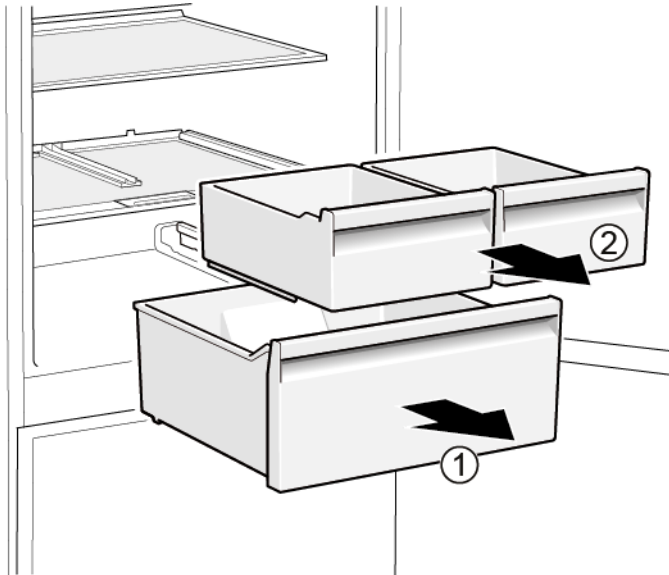

- ➡ Beholderne er fjernet.

### 4.14.2 Montering af beholder

- ▶ Montér i omvendt rækkefølge.

## 4.15 Udskiftning af udtrækkelig beholder

### Preindstilling:

- ✔ Døren er åben.

### 4.15.1 Fjernelse af udtrækkelig beholder

- ▶ 1. Træk den udtrækkelige beholder hele vejen ud (1).
- ▶ 2. Fjern den udtrækkelige beholder (2).

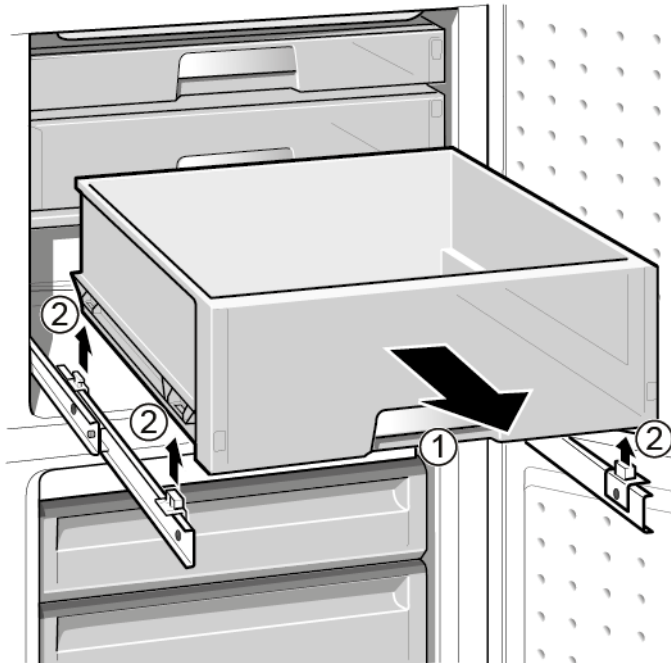

- ➡ Den udtrækkelige beholder er fjernet.

### 4.15.2 Montering af udtrækkelig beholder

- ▶ Montér i omvendt rækkefølge.

## 4.16 Udskiftning af LED-spotlampe

### Nødvendig værktøj:

Specialværktøj [00342180]

**i** Dit apparat er udstyret med en vedligeholdelsesfri LED-lampe. Denne lampe må kun repareres af kundeservice eller autoriserede teknikere!

**FARE**  
**Fare for elektrisk stød pga. spændingsførende dele!**  
Livsfare pga. elektrisk stød i tilfælde af ukorrekt reparation

- ▶ Elektriske dele skal repareres af kvalificerede elektrikere.
- ▶ Få efter reparationen udført en sikkerhedstest i henhold til VDE 0701 eller landespecifikke forskrifter.

**FARE**  
**Fare for elektrisk stød pga. spændingsførende dele!**  
Død ved elektrisk stød

- ▶ Afbryd apparater fra strømforsyningen i mindst 60 sekunder, før reparationer påbegyndes.

**PAS PÅ!**  
**Skarpe kanter!**  
Snitlæsioner

- ▶ Brug beskyttelseshandsker.

### Preindstilling:

- ✓ Apparatet er afbrudt fra strømforsyningen.
- ✓ Døren er åben.

### 4.16.1 Fjernelse af LED-spotlampe

1. Brug specialværktøj til at trække LED-spotlampen ud (1).

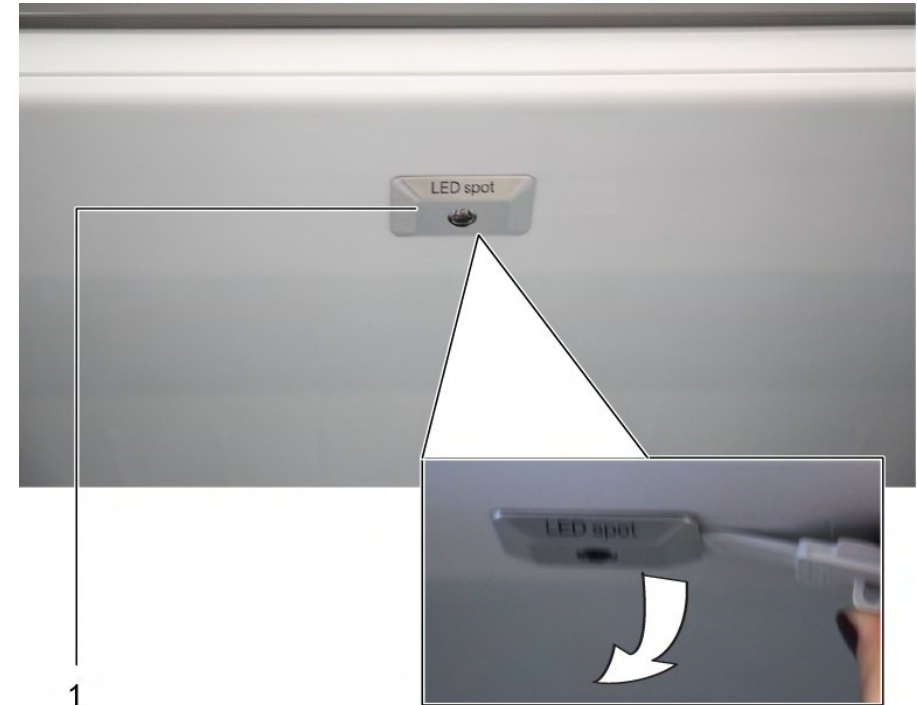

2. Afbryd LED-spotlampens elektriske tilslutninger.
- ➡ LED-spotlampen er fjernet.

### 4.16.2 Montering af LED-spotlampe

- ▶ Montér i omvendt rækkefølge.

## 4.17 Udskiftning af LED-lampe foroven

### Nødvendig værktøj:

- 🔧 Kærviskruetrækker Blad 2,4 mm x 0,4 mm x 60 mm i sættet [00341820]

**i** Dit apparat er udstyret med en vedligeholdelsesfri LED-lampe. Denne lampe må kun repareres af kundeservice eller autoriserede teknikere!



### ⚠️ FARE

#### Fare for elektrisk stød pga. spændingsførende dele!

Livsfare pga. elektrisk stød i tilfælde af ukorrekt reparation

- ▶ Elektriske dele skal repareres af kvalificerede elektrikere.
- ▶ Få efter reparationen udført en sikkerhedstest i henhold til VDE 0701 eller landespecifikke forskrifter.



### ⚠️ FARE

#### Fare for elektrisk stød pga. spændingsførende dele!

Død ved elektrisk stød

- ▶ Afbryd apparater fra strømforsyningen i mindst 60 sekunder, før reparationer påbegyndes.



### ⚠️ PAS PÅ!

#### Skarpe kanter!

Snitlæsioner

- ▶ Brug beskyttelseshandsker.

### Preindstilling:

- ✔️ Apparatet er afbrudt fra strømforsyningen.
- ✔️ Døren er åben.
- ✔️ Indvendigt tilbehør foroven er fjernet.

## 4.17.1 Fjernelse af LED-lampe

1. Bevæg LED-lampen mod venstre.

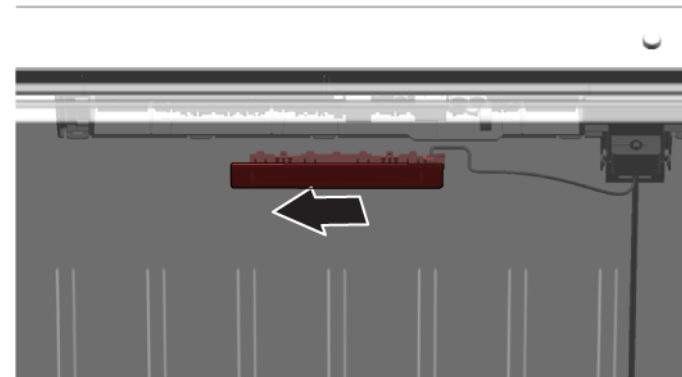

- ➡️ LED-lampens elektriske tilslutning er afbrudt.

2. Frigør LED-lampens kroge.

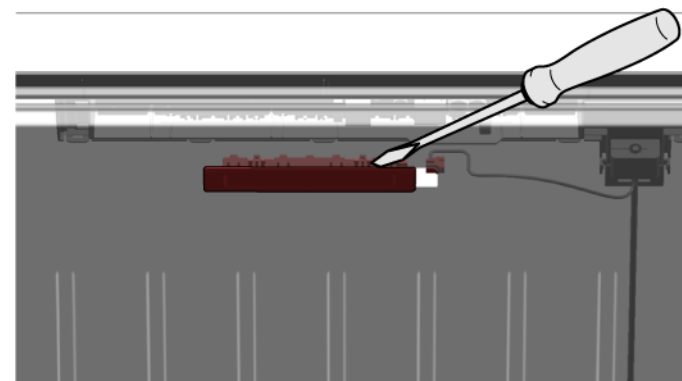

## Reparation

3. Fjern LED-lampen ved at bevæge den fremad.

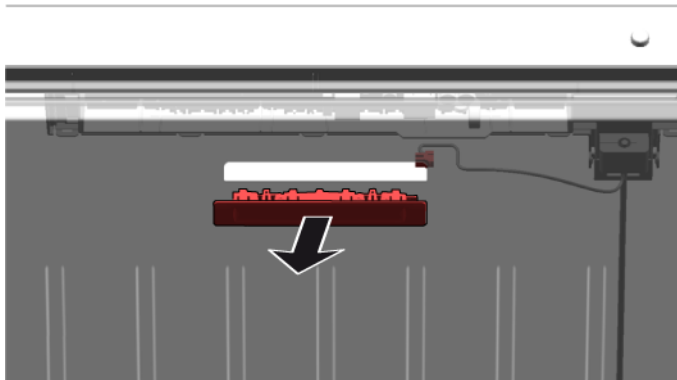

-  LED-lampen er fjernet.

### 4.17.2 Montering af LED-lampe foroven

- ▶ Montér i omvendt rækkefølge.

## 4.18 Udskiftning af LED-sidebjælkelampe

### Nødvendig værktøj:

☞ Sugekop Ø50 mm [00342224]

 Dit apparat er udstyret med en vedligeholdelsesfri LED-lampe. Denne lampe må kun repareres af kundeservice eller autoriserede teknikere!

 **FARE**  
**Fare for elektrisk stød pga. spændingsførende dele!**  
Livsfare pga. elektrisk stød i tilfælde af ukorrekt reparation

- ▶ Elektriske dele skal repareres af kvalificerede elektrikere.
- ▶ Få efter reparationen udført en sikkerhedstest i henhold til VDE 0701 eller landespecifikke forskrifter.

 **FARE**  
**Fare for elektrisk stød pga. spændingsførende dele!**  
Død ved elektrisk stød

- ▶ Afbryd apparater fra strømforsyningen i mindst 60 sekunder, før reparationer påbegyndes.

 **PAS PÅ!**  
**Skarpe kanter!**  
Snitlæsioner

- ▶ Brug beskyttelseshandsker.

### Preindstilling:

- ✓ Apparatet er afbrudt fra strømforsyningen.
- ✓ Døren er åben.
- ✓ Hyldeerne i køleafdelingen er fjernet.

### 4.18.1 Fjernelse LED-sidebjælkelampe

1. Sæt sugekoppen fast på den øverste tredjedel af LED-sidebjælkelampen.



## Reparation

2. Træk sugekoppen fremad med LED-sidebjælkelampen i en drejende bevægelse.

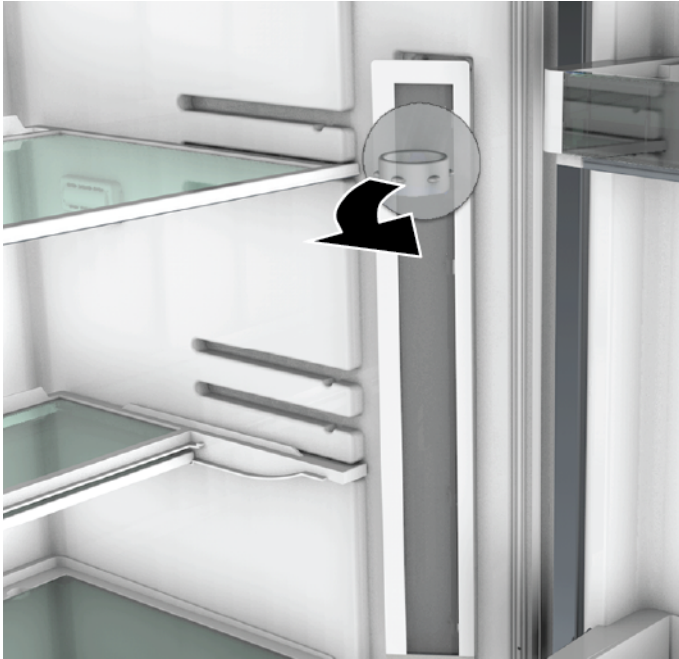





3. Afbryd LED-sidebjælkelampens elektriske tilslutning.  
➡ LED-sidebjælkelampen er fjernet.

### 4.18.2 Montering af LED-sidebjælkelampe

1. Forbind LED-sidebjælkelampens elektriske tilslutning.
  2. Fastgør LED-sidebjælkelampen i dens placering på afdelingens væg (krogene klikker).
- ➡ LED-sidebjælkelampen er monteret.

# Reparatie informatie - Koel-vriescombinatie

 <b>Over dit document</b> .....	<b>111</b>		
1.1 Belangrijke informatie .....	111		
1.1.1 Doel .....	111		
1.2 Verklaring van symbolen .....	111		
1.2.1 Gevarenniveaus .....	111		
1.2.2 Gevarensymbolen .....	111		
1.2.3 Structuur van de waarschuwingen .....	112		
1.2.4 Algemene symbolen .....	112		
 <b>Veiligheid</b> .....	<b>113</b>		
2.1 Algemene veiligheidsinstructies .....	113		
2.1.1 Alle huishoudelijke apparaten .....	113		
 <b>Gereedschappen en hulpmiddelen</b> .....	<b>114</b>		
 <b>Reparatie</b> .....	<b>115</b>		
4.1 Deurafdichting vervangen .....	115		
4.2 Deurgreep vervangen .....	116		
4.2.1 Deurgreep verwijderen .....	116		
4.2.2 Deurgreep monteren .....	116		
4.3 Bovenste deurscharnier vervangen .....	117		
4.3.1 Bovenste deurscharnier verwijderen .....	117		
4.3.2 Bovenste deurscharnier monteren .....	118		
4.4 Bovenste deurscharnier vervangen (deur met display) .....	119		
4.4.1 Bovenste deurscharnier verwijderen .....	119		
4.4.2 Bovenste deurscharnier monteren .....	120		
4.5 Middelste deurscharnier vervangen .....	121		
4.5.1 Middelste deurscharnier verwijderen .....	121		
4.5.2 Middelste deurscharnier monteren .....	121		
4.6 Onderste deurscharnier vervangen .....	122		
4.6.1 Onderste deurscharnier verwijderen .....	122		
4.6.2 Onderste deurscharnier monteren .....	122		
4.7 Plateau vervangen .....	123		
4.7.1 Plateau verwijderen .....	123		
4.7.2 Plateau monteren .....	123		
4.8 Variabel legplateau vervangen .....	124		
4.8.1 Variabel legplateau verwijderen .....	124		
4.8.2 Variabel legplateau plaatsen .....	124		
4.9 Flexibel legplateau vervangen .....	125		
4.9.1 Flexibel legplateau verwijderen .....	125		
4.9.2 Flexibel legplateau plaatsen .....	125		
4.10 Ontbijtset vervangen .....	126		
4.10.1 Ontbijtset verwijderen .....	126		
4.10.2 Ontbijtset plaatsen .....	126		
4.11 Flessenrek vervangen .....	127		
4.11.1 Flessenrek verwijderen .....	127		
4.11.2 Flessenrek monteren .....	127		
4.12 Deurrek vervangen .....	128		
4.12.1 Deurrek verwijderen .....	128		
4.12.2 Deurrek monteren .....	128		
4.13 Vrieslade vervangen .....	129		
4.13.1 Vrieslade verwijderen .....	129		
4.13.2 Vrieslade installeren .....	129		
4.14 Lade vervangen .....	130		
4.14.1 Lade verwijderen .....	130		
4.14.2 Lade installeren .....	130		
4.15 Uittrekbare lade vervangen .....	131		
4.15.1 Uittrekbare lade verwijderen .....	131		
4.15.2 Uittrekbare lade monteren .....	131		
4.16 LED-spot vervangen .....	132		
4.16.1 LED-verlichting verwijderen .....	132		
4.16.2 LED-verlichting installeren .....	132		
4.17 LED-bovenlicht vervangen .....	133		
4.17.1 LED-verlichting verwijderen .....	133		
4.17.2 LED-bovenlicht installeren .....	134		
4.18 LED-zijlichtbalk vervangen .....	135		
4.18.1 LED-zijlichtbalk verwijderen .....	135		
4.18.2 LED-zijlichtbalk installeren .....	136		

# **i** Over dit document

## 1.1 Belangrijke informatie

### 1.1.1 Doel

Met deze reparatieaanwijzingen wordt de klant geholpen zelf apparaten te repareren conform de toepasselijke verordening inzake ecologisch ontwerp (met ingang van 03/2021).





Ze bevatten informatie over hoe gedefinieerde reserveonderdelen kunnen worden vervangen met inbegrip van waarschuwingen en gevaren.

Neem bij vragen contact op met onze klantenservice. We stellen ons alleen aansprakelijk voor schade als de reparatieaanwijzingen correct zijn opgevolgd.

## 1.2 Verklaring van symbolen

### 1.2.1 Gevarenniveaus

De waarschuwningsniveaus worden aangegeven met een symbool en een signaalwoord. Het signaalwoord geeft de ernst van het gevaar aan.





Waarschuwningsniveau	Betekenis
	Als de waarschuwing niet in acht wordt genomen, leidt dat tot ernstig of dodelijk letsel.
	Als de waarschuwing niet in acht wordt genomen, kan dat tot ernstig of dodelijk letsel leiden.
	Als de waarschuwing niet in acht wordt genomen, kan dat tot licht letsel leiden.
	Als de waarschuwing niet in acht wordt genomen, kan dat tot materiële schade leiden.

Tabel 1: Gevarenniveaus

### 1.2.2 Gevarensymbolen

Gevarensymbolen zijn symbolische afbeeldingen die een indicatie geven van het soort gevaar.

De volgende gevarensymbolen worden in dit document gebruikt:

Gevarensymbool	Betekenis
	Algemene waarschuwing
	Gevaar voor elektrische spanning
	Ontploffingsgevaar
	Snijgevaar

## **i** Over dit document

Gevarensymbool	Betekenis
	Beknellingsgevaar
	Gevaar voor hete oppervlakken
	Gevaar voor sterke magnetische velden
	Gevaar voor niet-ioniserende straling

Tabel 2: Gevarensymbolen

### 1.2.3 Structuur van de waarschuwingen

Waarschuwingen in dit document hebben een gestandaardiseerd uiterlijk en een gestandaardiseerde structuur.







	<div style="background-color: red; color: white; padding: 2px; text-align: center;"><b>⚠ GEVAAR</b></div> <p><b>Soort gevaar en bron van het gevaar!</b> Mogelijke gevolgen van het negeren van het gevaar / de waarschuwing.</p> <ul style="list-style-type: none"> <li>▶ Maatregelen en verboden om het gevaar te voorkomen.</li> </ul>
--	---

In het volgende voorbeeld is een waarschuwing te zien waarmee voor een elektrische schok aan stroomvoerende onderdelen wordt gewaarschuwd. De maatregel om het gevaar te vermijden wordt vermeld.

	<div style="background-color: red; color: white; padding: 2px; text-align: center;"><b>⚠ GEVAAR</b></div> <p><b>Gevaar voor een elektrische schok aan stroomvoerende onderdelen!</b> Dood door elektrocutie</p> <ul style="list-style-type: none"> <li>▶ Haal apparaten minstens 60 seconden voor u met reparaties begint van de stroomvoorziening af.</li> </ul>
--	---

### 1.2.4 Algemene symbolen

De volgende algemene symbolen worden in dit document gebruikt:

Alg. symbool	Betekenis
	Identificatie van een speciale tip (tekst en/of afbeelding)
	Identificatie van een eenvoudige tip (tekst)
	Identificatie van een link naar een video-instructie
	Identificatie van vereiste gereedschappen
	Identificatie van vereiste voorwaarden
	Identificatie van een voorwaarde (als ..., dan ...)
	Identificatie van een resultaat
[Start]	Identificatie van een toets of knop
[00123456]	Identificatie van een materiaalnummer
Status	Identificatie van weergegeven tekst / venster (in het display van het apparaat)

Tabel 3: Algemene symbolen

## 2.1 Algemene veiligheidsinstructies

### 2.1.1 Alle huishoudelijke apparaten

#### **Gevaar voor een elektrische schok aan stroomvoerende onderdelen!**

- Fouten bij reparaties aan elektrische componenten kunnen tot een elektrische schok leiden!
- Koppel het apparaat minstens 60 seconden los van het stroomnet voordat u met de werkzaamheden begint.
- Laat na de reparatie een veiligheidstest conform VDE 0701 of de landspecifieke regelgeving uitvoeren.

#### **Gevaar voor letsel aan scherpe randen!**

- Draag veiligheidshandschoenen.

#### **Beknellingsgevaar tijdens reparatie, onderhoud, probleemoplossing en service vanwege zware en bewegende componenten**

- Draag veiligheidsschoenen.
- Beveilig zware componenten tegen vallen.
- Steek geen lichaamsdelen in bewegende componenten.

#### **Gevaar voor de veiligheid / werking van het apparaat!**

- Gebruik uitsluitend originele reserveonderdelen.

#### **Gevaar voor schade aan elektrostatisch gevoelige componenten (ESD's)!**

- Raak de modules met inbegrip van de aansluitingen en geleiderbanen niet aan.

## Gereedschappen en hulpmiddelen

Benaming	Details	Afbeeldingen
Beschermdoek [00342013]	60 cm x 50 cm	
Precisie-schroeven- draaierset [00341820]	9 stuks, 2,0 mm, 2,4 mm, 3,0 mm, PH0, PH00, PH1, TX6, TX8, TX9	
Hulpgereedschap [00342180]	Gereedschap voor loshalen uit kunststof onderdelen, "magic tool"	
Zuignap [00342224]	Ø 50 mm	
Torxbit TX20 [00340865]	6,3 mm (1/4")	
Sleufschroeven- draaier	Kop 10 mm x 1,6 mm x 200 mm	



## 4.1 Deurafdichting vervangen

Voorwaarde:



- Deur is open.

## 4.2 Deurgreep vervangen

### Voorgestelde tools:

-  Torxbit TX20                      6,3 mm (1/4")                      [00340865]
-  Sleufschroevendraaier              Kop 10 mm x 1,6 mm x 200 mm

### Voorwaarde:

-  Apparaat is losgekoppeld is van de stroomvoorziening.
-  Deur is open.

### 4.2.1 Deurgreep verwijderen

- ▶ 1. Verwijder twee schroefkappen (1).
- ▶ 2. Draai de twee schroeven los (2).
- ▶ 3. Verwijder de deurgreep (3).

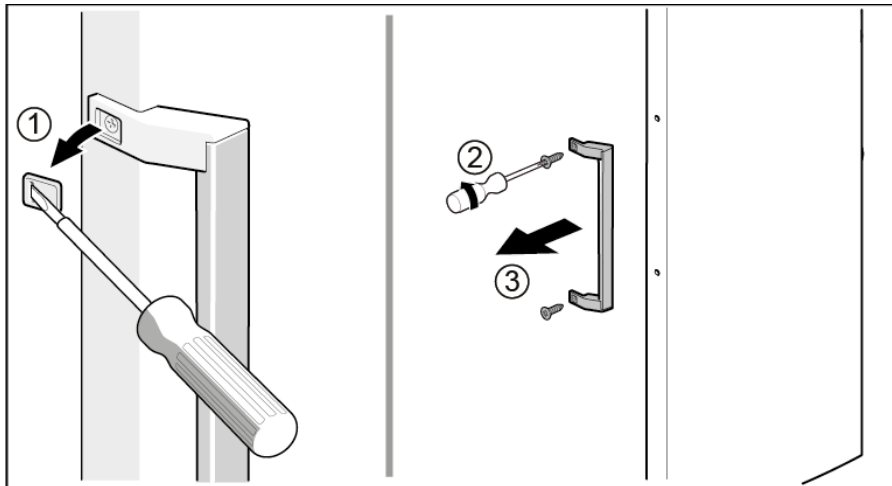

 Deurgreep wordt verwijderd.



Deurgreep voor de tweede deur kan op dezelfde manier worden verwijderd.





### 4.2.2 Deurgreep monteren

- ▶ Monteer in omgekeerde volgorde.

## 4.3 Bovenste deurscharnier vervangen

Voorgestelde tools:

Torxbit TX20 6,3 mm (1/4") [00340865]

	<b>WAARSCHUWING</b> <b>Zware, omvangrijke apparaten!</b> Rug- en spierletsel <ul style="list-style-type: none"><li>▶ De werkzaamheid van het verwijderen van de apparaatdeur mag alleen worden uitgevoerd door speciaal opgeleid personeel.</li><li>▶ Om het apparaat te verplaatsen zijn twee mensen nodig.</li><li>▶ Gebruik alleen geschikte gereedschappen en apparatuur.</li></ul>
	<b>VOORZICHTIG</b> <b>Scherpe randen!</b> Snijletsel <ul style="list-style-type: none"><li>▶ Draag veiligheidshandschoenen.</li></ul>
	<b>WAARSCHUWING</b> <b>Weggliden van schuin staande apparaten!</b> Botbreuken / beknellingsletsel <ul style="list-style-type: none"><li>▶ Beveilig apparaten tegen wegglijden.</li></ul>
	<b>VOORZICHTIG</b> <b>Gevaar voor vallende onderdelen als gevolg van losgeraakte schroeven!</b> Letsel als gevolg van vallende onderdelen. <ul style="list-style-type: none"><li>▶ Beveilig component tegen vallen.</li></ul>
	<b>LET OP!</b> <b>Gevaar voor vallende onderdelen als gevolg van losgeraakte schroeven!</b> Schade aan andere onderdelen van het apparaat of bij de klant thuis bijvoorbeeld aan de vloer. <ul style="list-style-type: none"><li>▶ Beveilig component tegen vallen.</li></ul>

Voorwaarde:

- ✓ Apparaat is losgekoppeld van de stroomvoorziening.
- ✓ Het interieur van het apparaat is verwijderd.

### 4.3.1 Bovenste deurscharnier verwijderen

1. Leg het apparaat op zijn achterkant.

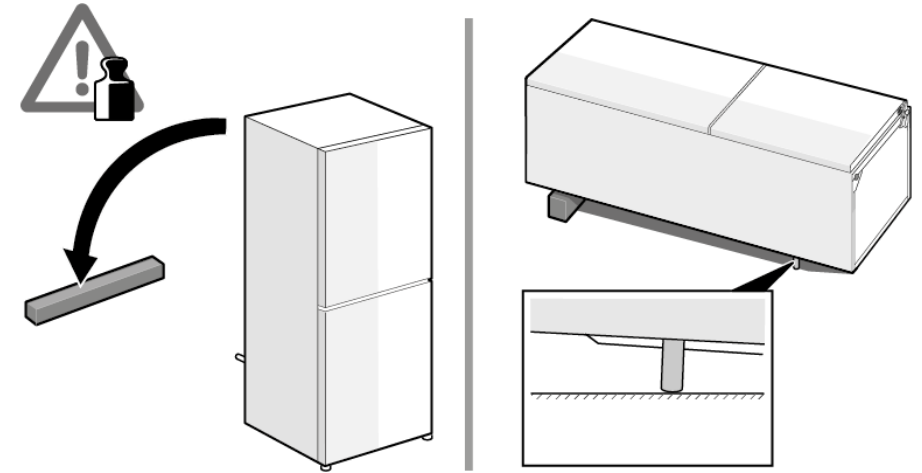

## Reparatie

2. 1. Druk aan beide kanten op de bovenste scharnierafdekking (1).
2. Haal de bovenste scharnierafdekking eruit (2).
3. Draai de scharnierafdekking (3).
4. Verwijder de bovenste scharnierafdekking (4).
5. Draai de twee schroeven los (5).
6. Verwijder het bovenste scharnier (6).

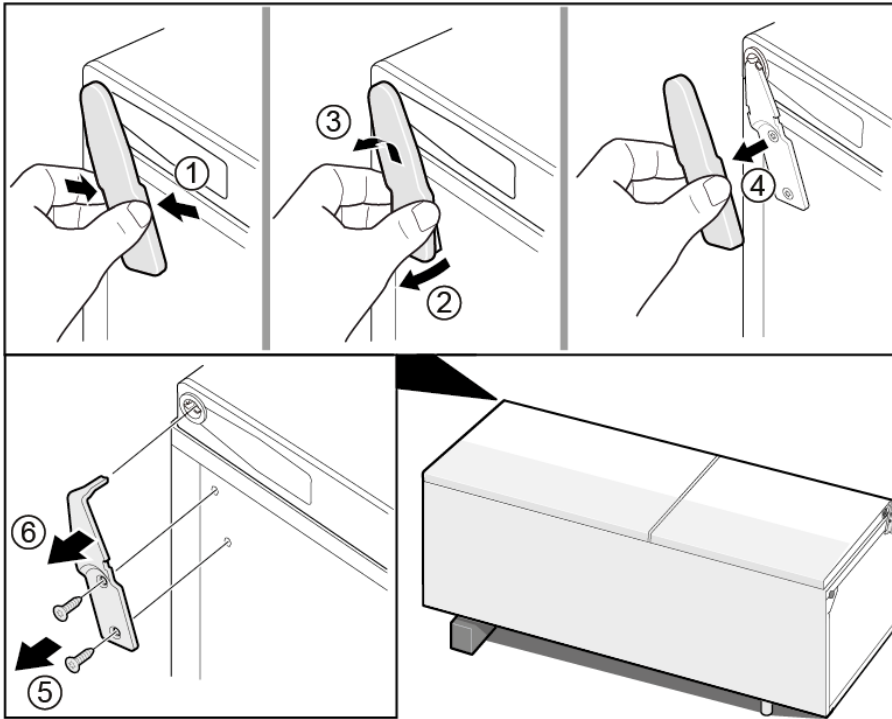

 Het bovenste scharnier wordt verwijderd.

### 4.3.2 Bovenste deurscharnier monteren

- ▶ Monteer in omgekeerde volgorde.

## 4.4 Bovenste deurscharnier vervangen (deur met display)

Voorgestelde tools:

Torxbit TX20 6,3 mm (1/4") [00340865]

	<b>WAARSCHUWING</b>
	<p><b>Zware, omvangrijke apparaten!</b> Rug- en spierletsel</p> <ul style="list-style-type: none"> <li>▶ De werkzaamheid van het verwijderen van de apparaatdeur mag alleen worden uitgevoerd door speciaal opgeleid personeel.</li> <li>▶ Om het apparaat te verplaatsen zijn twee mensen nodig.</li> <li>▶ Gebruik alleen geschikte gereedschappen en apparatuur.</li> </ul>

	<b>VOORZICHTIG</b>
	<p><b>Scherpe randen!</b> Snijletsel</p> <ul style="list-style-type: none"> <li>▶ Draag veiligheidshandschoenen.</li> </ul>

	<b>WAARSCHUWING</b>
	<p><b>Weggliden van schuin staande apparaten!</b> Botbreuken / beknellingsletsel</p> <ul style="list-style-type: none"> <li>▶ Beveilig apparaten tegen wegglijden.</li> </ul>

	<b>VOORZICHTIG</b>
	<p><b>Gevaar voor vallende onderdelen als gevolg van losgeraakte schroeven!</b> Letsel als gevolg van vallende onderdelen.</p> <ul style="list-style-type: none"> <li>▶ Beveilig component tegen vallen.</li> </ul>

	<b>LET OP!</b>
	<p><b>Gevaar voor vallende onderdelen als gevolg van losgeraakte schroeven!</b> Schade aan andere onderdelen van het apparaat of bij de klant thuis bijvoorbeeld aan de vloer.</p> <ul style="list-style-type: none"> <li>▶ Beveilig component tegen vallen.</li> </ul>

	<b>GEVAAR</b>
	<p><b>Gevaar voor een elektrische schok aan stroomvoerende onderdelen!</b> Levensgevaar door elektrische schokken in geval van een ondeskundige reparatie</p> <ul style="list-style-type: none"> <li>▶ Elektrische onderdelen moeten door gekwalificeerde elektriciens worden gerepareerd.</li> <li>▶ Laat na de reparatie een veiligheidstest conform VDE 0701 of de landspecifieke regelgeving uitvoeren.</li> </ul>

	<b>GEVAAR</b>
	<p><b>Gevaar voor een elektrische schok aan stroomvoerende onderdelen!</b> Dood door elektrocutie</p> <ul style="list-style-type: none"> <li>▶ Haal apparaten minstens 60 seconden voor u met reparaties begint van de stroomvoorziening af.</li> </ul>

Voorwaarde:

- ✔ Apparaat is losgekoppeld is van de stroomvoorziening.
- ✔ Het interieur van het apparaat is verwijderd.

### 4.4.1 Bovenste deurscharnier verwijderen

1. Leg het apparaat op zijn achterkant.

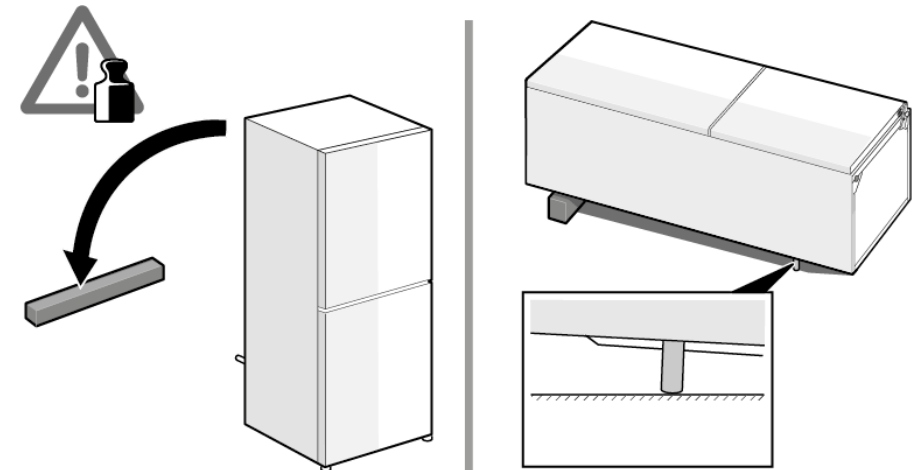

## Reparatie

2. 1. Verwijder de bovenste scharnierafdekking (1).
2. Verwijder de afdekking van de aansluitdoos (2).
3. Haal de elektrische aansluiting los (3).
4. Draai de aardverbindingsschroef los (4).
5. Verwijder de kabelbeschermer (5).
6. Draai de schroef (6) los.

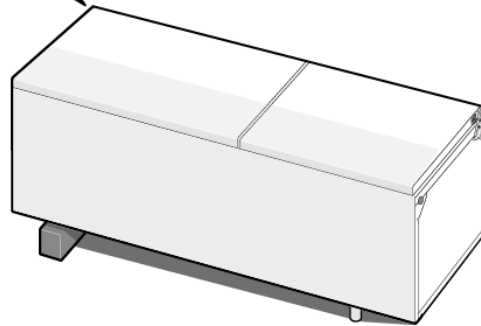
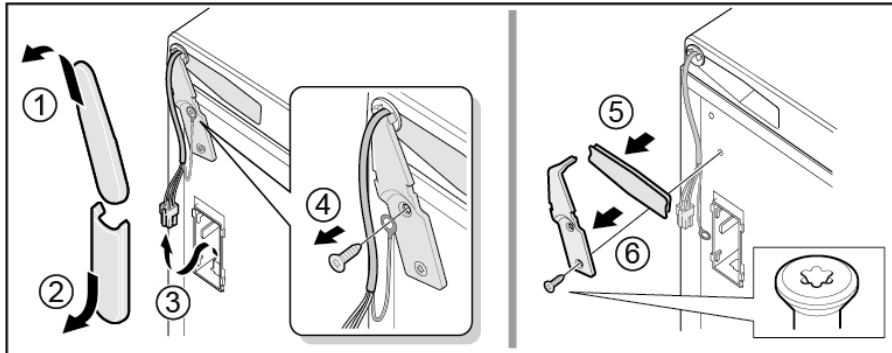

 Het bovenste scharnier wordt verwijderd.

### 4.4.2 Bovenste deurscharnier monteren

- ▶ Monteer in omgekeerde volgorde.

## 4.5 Middelste deurscharnier vervangen

### Voorgestelde tools:

Torxbit TX20 6,3 mm (1/4") [00340865]

	<b>WAARSCHUWING</b>
	<p><b>Zware, omvangrijke apparaten!</b> Rug- en spierletsel</p> <ul style="list-style-type: none"> <li>▶ De werkzaamheid van het verwijderen van de apparaatdeur mag alleen worden uitgevoerd door speciaal opgeleid personeel.</li> <li>▶ Om het apparaat te verplaatsen zijn twee mensen nodig.</li> <li>▶ Gebruik alleen geschikte gereedschappen en apparatuur.</li> </ul>

	<b>VOORZICHTIG</b>
	<p><b>Scherpe randen!</b> Snijletsel</p> <ul style="list-style-type: none"> <li>▶ Draag veiligheidshandschoenen.</li> </ul>

	<b>WAARSCHUWING</b>
	<p><b>Weggliden van schuin staande apparaten!</b> Botbreuken / beknellingsletsel</p> <ul style="list-style-type: none"> <li>▶ Beveilig apparaten tegen wegglijden.</li> </ul>

	<b>VOORZICHTIG</b>
	<p><b>Gevaar voor vallende onderdelen als gevolg van losgeraakte schroeven!</b> Letsel als gevolg van vallende onderdelen.</p> <ul style="list-style-type: none"> <li>▶ Beveilig component tegen vallen.</li> </ul>

	<b>LET OP!</b>
	<p><b>Gevaar voor vallende onderdelen als gevolg van losgeraakte schroeven!</b> Schade aan andere onderdelen van het apparaat of bij de klant thuis bijvoorbeeld aan de vloer.</p> <ul style="list-style-type: none"> <li>▶ Beveilig component tegen vallen.</li> </ul>

### Voorwaarde:

- ✔ Apparaat is losgekoppeld is van de stroomvoorziening.
- ✔ De interieurdelen van het apparaat worden verwijderd.

- ✔ Het bovenste deurscharnier wordt verwijderd.
- ✔ Bovendeur word verwijderd.

### 4.5.1 Middelste deurscharnier verwijderen

- ▶ 1. Verwijder de deur van het koelvak (1).
- ▶ 2. Draai de twee schroeven los (2).
- ▶ 3. Verwijder het middelste scharnier (3).

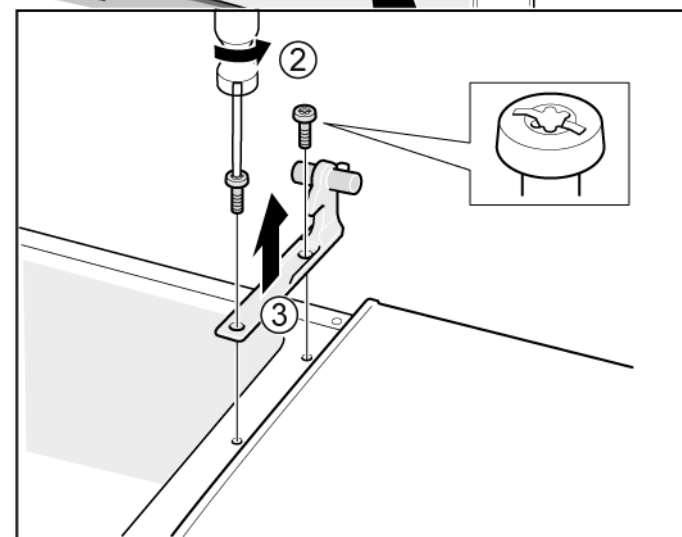
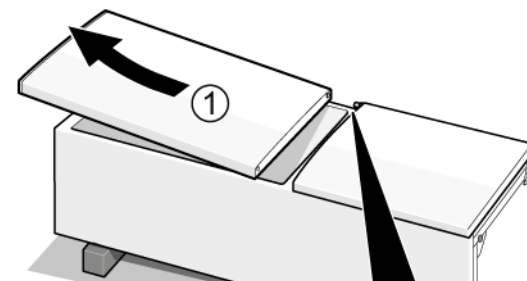

- ➡ Het middelste scharnier wordt verwijderd.

### 4.5.2 Middelste deurscharnier monteren

- ▶ Monteer in omgekeerde volgorde.

## 4.6 Onderste deurscharnier vervangen

### Voorgestelde tools:

Torxbit TX20 6,3 mm (1/4") [00340865]

	<b>WAARSCHUWING</b>
	<p><b>Zware, omvangrijke apparaten!</b> Rug- en spierletsel</p> <ul style="list-style-type: none"> <li>▶ De werkzaamheid van het verwijderen van de apparaatdeur mag alleen worden uitgevoerd door speciaal opgeleid personeel.</li> <li>▶ Om het apparaat te verplaatsen zijn twee mensen nodig.</li> <li>▶ Gebruik alleen geschikte gereedschappen en apparatuur.</li> </ul>

	<b>VOORZICHTIG</b>
	<p><b>Scherpe randen!</b> Snijletsel</p> <ul style="list-style-type: none"> <li>▶ Draag veiligheidshandschoenen.</li> </ul>

	<b>WAARSCHUWING</b>
	<p><b>Weggliden van schuin staande apparaten!</b> Botbreuken / beknellingsletsel</p> <ul style="list-style-type: none"> <li>▶ Beveilig apparaten tegen wegglijden.</li> </ul>

	<b>VOORZICHTIG</b>
	<p><b>Gevaar voor vallende onderdelen als gevolg van losgeraakte schroeven!</b> Letsel als gevolg van vallende onderdelen.</p> <ul style="list-style-type: none"> <li>▶ Beveilig component tegen vallen.</li> </ul>

	<b>LET OP!</b>
	<p><b>Gevaar voor vallende onderdelen als gevolg van losgeraakte schroeven!</b> Schade aan andere onderdelen van het apparaat of bij de klant thuis bijvoorbeeld aan de vloer.</p> <ul style="list-style-type: none"> <li>▶ Beveilig component tegen vallen.</li> </ul>

### Voorwaarde:

- ✔ Apparaat is losgekoppeld is van de stroomvoorziening.
- ✔ Het interieur van het apparaat is verwijderd.

- ✔ Het bovenste scharnier wordt verwijderd.
- ✔ Het middelste scharnier wordt verwijderd.

### 4.6.1 Onderste deurscharnier verwijderen

- ▶ 1. Verwijder de deur van het vriesvak (1).
- ▶ 2. Draai de schroef (2) los.
- ▶ 3. Draai het onderste scharnier eruit (3).
- ▶ 4. Verwijder het onderste scharnier (4).

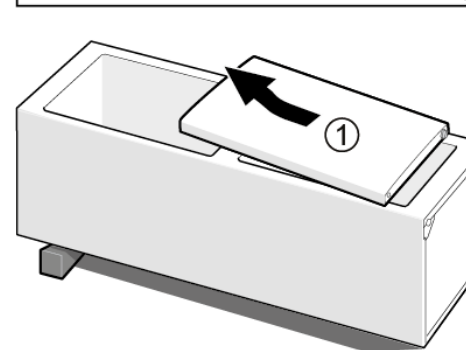
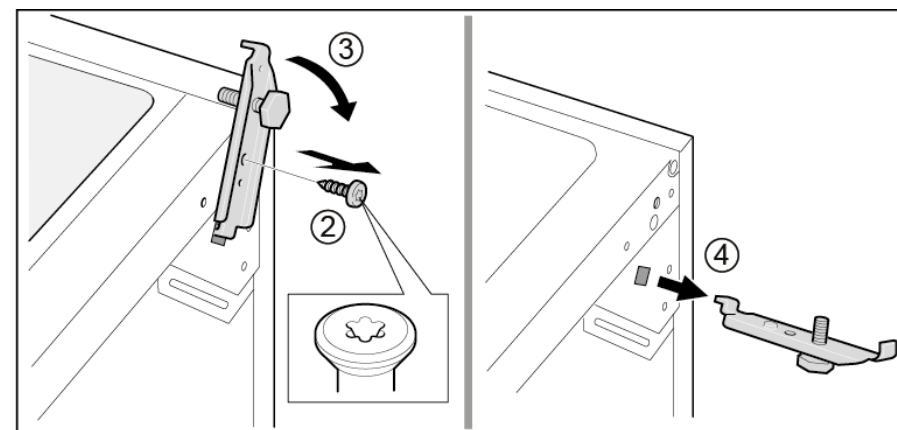

- ➡ Het onderste deurscharnier wordt verwijderd.

### 4.6.2 Onderste deurscharnier monteren

- ▶ Monteer in omgekeerde volgorde.

## 4.7 Plateau vervangen

Voorwaarde:

- ✔ Deur is open.

### 4.7.1 Plateau verwijderen

- ▶ Trek het plateau eruit.

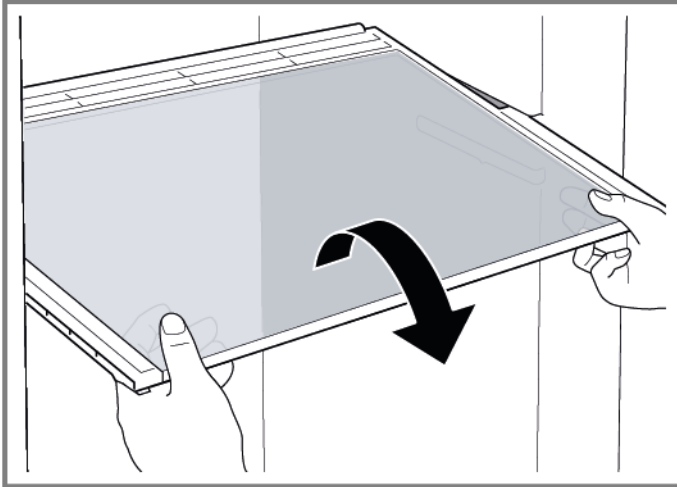

➡ Plateau wordt verwijderd.

### 4.7.2 Plateau monteren

- ▶ Monteer in omgekeerde volgorde.

## 4.8 Variabel legplateau vervangen

Voorwaarde:

- ✔ Deur is open.

### 4.8.1 Variabel legplateau verwijderen

1. Trek het rechtergedeelte van het variabele legplateau naar voren (1).
2. Verwijder het rechtergedeelte van het variabele legplateau (2).

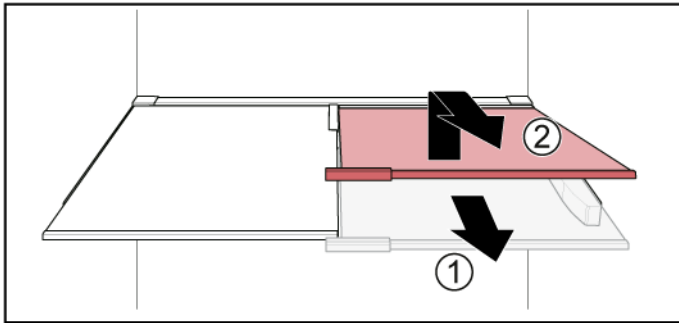

2. Verwijder het linkergedeelte van het variabele legplateau op dezelfde wijze.

➡ Variabel legplateau wordt verwijderd.

### 4.8.2 Variabel legplateau plaatsen

- ▶ Monteer in omgekeerde volgorde.

## 4.9 Flexibel legplateau vervangen

Voorwaarde:

- ✔ Deur is open.

### 4.9.1 Flexibel legplateau verwijderen

- ▶ 1. Verwijder glasplateau (1).
- ▶ 2. Licht het flexibele legplateau op en trek het eruit (2).

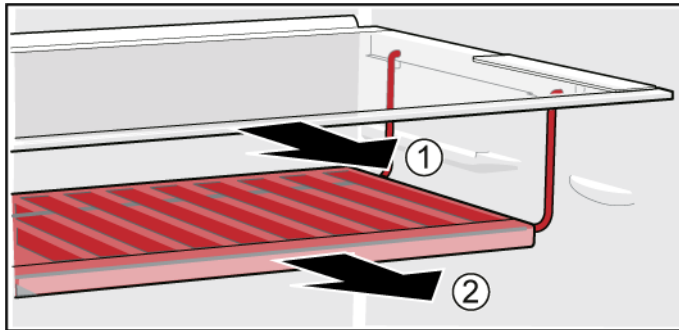

- ➡ Flexibel legplateau wordt verwijderd.

### 4.9.2 Flexibel legplateau plaatsen

- ▶ Monteer in omgekeerde volgorde.

## 4.10 Ontbijtset vervangen

Voorwaarde:

- ✔ Deur is open.

### 4.10.1 Ontbijtset verwijderen

- ▶ Licht de ontbijtset op en trek hem eruit.

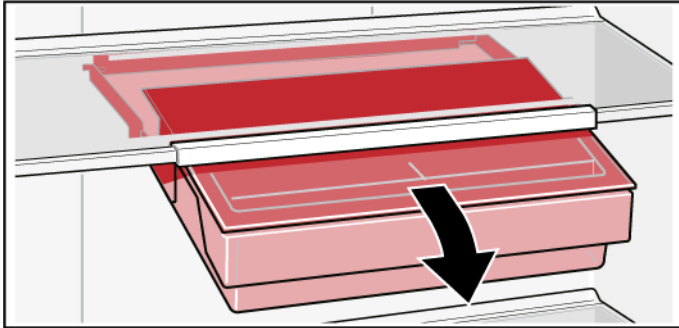

- ➡ Ontbijtset wordt verwijderd.

### 4.10.2 Ontbijtset plaatsen

- ▶ Monteer in omgekeerde volgorde.

## 4.11 Flessenrek vervangen

Voorwaarde:

- ✔ Deur is open.

### 4.11.1 Flessenrek verwijderen

- ▶ Trek het flessenrek eruit.

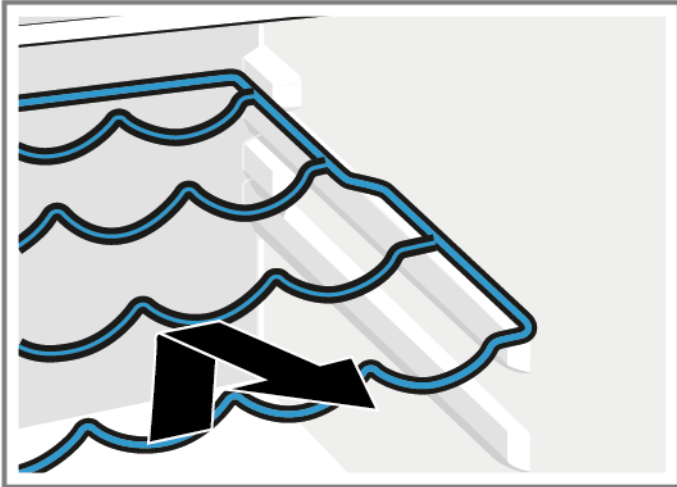

- ➡ Flessenrek wordt verwijderd.

### 4.11.2 Flessenrek monteren

- ▶ Monteer in omgekeerde volgorde.

## 4.12 Deurrek vervangen

Voorwaarde:

- ✔ Deur is open.

### 4.12.1 Deurrek verwijderen

- ▶ Licht het deurrek omhoog.

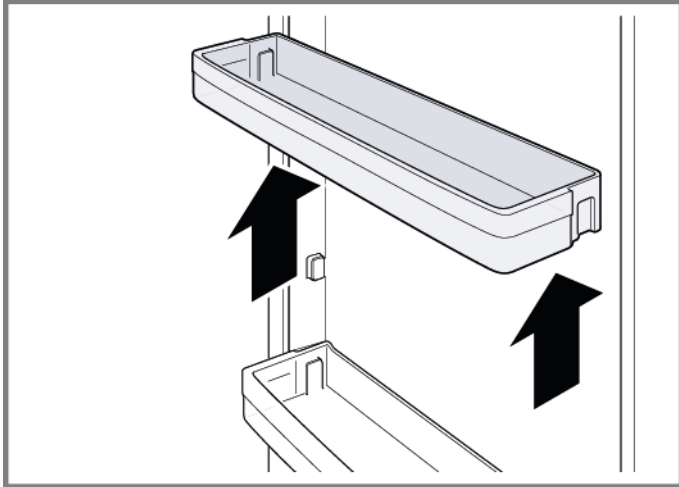

➡ Deurrek wordt verwijderd.

### 4.12.2 Deurrek monteren

- ▶ Monteer in omgekeerde volgorde.

## 4.13 Vrieslade vervangen

### Voorwaarde:

- ✔ Deur is open.

### 4.13.1 Vrieslade verwijderen

- ▶ 1. Trek de vrieslade er helemaal uit (1).
- ▶ 2. Verwijder de vrieslade (2).

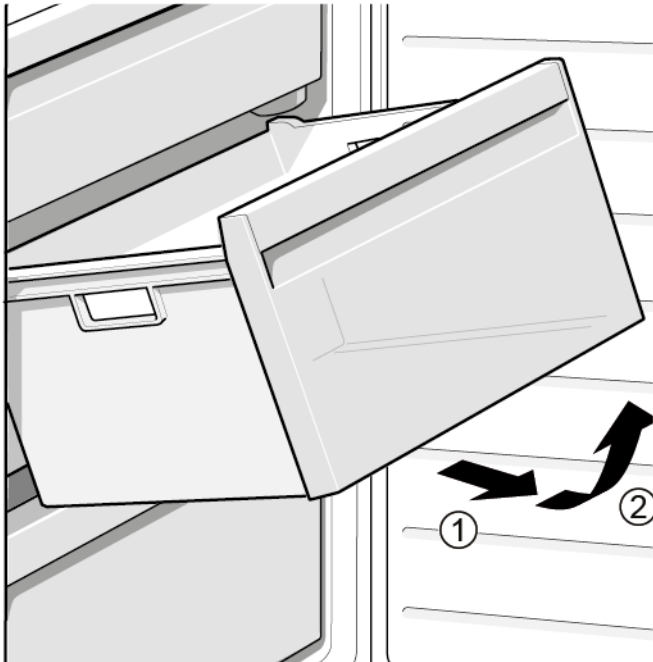

- ➡ Vrieslade wordt verwijderd.

### 4.13.2 Vrieslade installeren

- ▶ Monteer in omgekeerde volgorde.

## 4.14 Lade vervangen

### Voorwaarde:

- ✔ Deur is open.

### 4.14.1 Lade verwijderen

- ▶ 1. Haal de onderste koellade eruit (1).
- ▶ 2. Haal de bovenste koellade eruit (2).

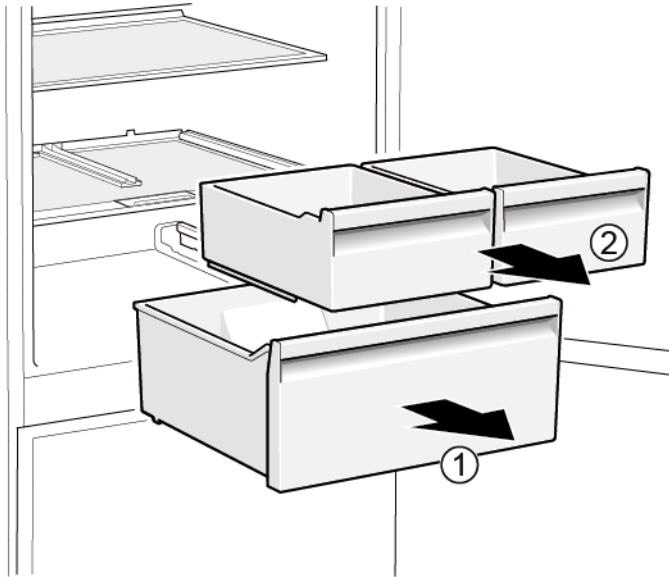

- ➡ De lades worden verwijderd.

### 4.14.2 Lade installeren

- ▶ Monteer in omgekeerde volgorde.

## 4.15 Uittrekbare lade vervangen

### Voorwaarde:

- ✔ Deur is open.

### 4.15.1 Uittrekbare lade verwijderen

- ▶ 1. Trek de uittrekbare lade er helemaal uit (1).
- ▶ 2. Verwijder de uittrekbare lade (2).

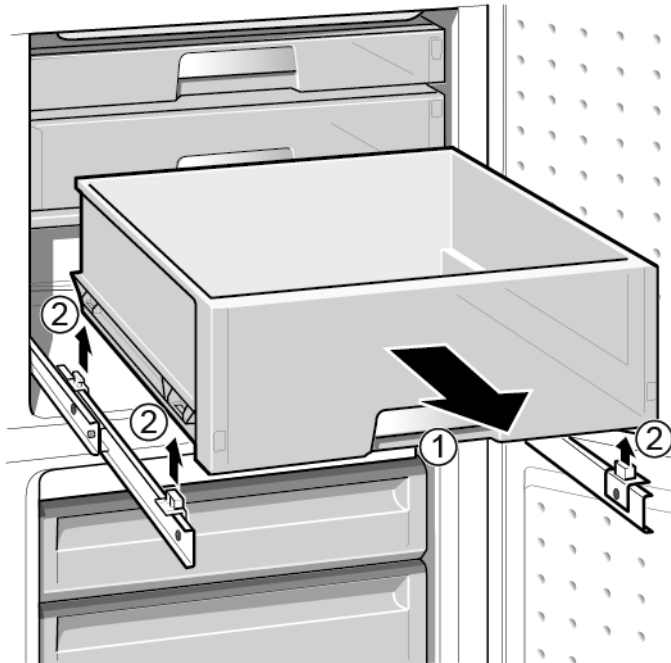

- ➡ Uittrekbare lade wordt verwijderd.

### 4.15.2 Uittrekbare lade monteren

- ▶ Monteer in omgekeerde volgorde.

## 4.16 LED-spot vervangen

### Voorgestelde tools:

Speciaal gereedschap

[00342180]



Uw apparaat heeft een onderhoudsvrije LED-verlichting. Deze verlichting mag alleen maar door de klantenservice of geautoriseerde monteurs worden vervangen!



### GEVAAR

#### Gevaar voor een elektrische schok aan stroomvoerende onderdelen!

Levensgevaar door elektrische schokken in geval van een ondeskundige reparatie

- ▶ Elektrische onderdelen moeten door gekwalificeerde elektriciens worden gerepareerd.
- ▶ Laat na de reparatie een veiligheidstest conform VDE 0701 of de landspecifieke regelgeving uitvoeren.



### GEVAAR

#### Gevaar voor een elektrische schok aan stroomvoerende onderdelen!

Dood door elektrocutie

- ▶ Haal apparaten minstens 60 seconden voor u met reparaties begint van de stroomvoorziening af.



### VOORZICHTIG

#### Scherpe randen!

Snijletsel

- ▶ Draag veiligheidshandschoenen.

### Voorwaarde:

- ✔ Apparaat is losgekoppeld is van de stroomvoorziening.
- ✔ Deur is open.

## 4.16.1 LED-verlichting verwijderen

1. Gebruik het speciale gereedschap om de LED-verlichting te vervangen (1).



2. Haal de stekker van de elektrische aansluitingen van de LED-verlichting eruit.  
➡ LED-verlichting wordt verwijderd.

## 4.16.2 LED-verlichting installeren

- ▶ Monteer in omgekeerde volgorde.

## 4.17 LED-bovenlicht vervangen

### Voorgestelde tools:

- Sleufschroevendraaier Kop 2,4 mm x 0,4 mm x 60 mm, in de set [00341820]

**i** Uw apparaat heeft een onderhoudsvrije LED-verlichting. Deze verlichting mag alleen maar door de klantenservice of geautoriseerde monteurs worden vervangen!

**⚠ GEVAAR**  
**Gevaar voor een elektrische schok aan stroomvoerende onderdelen!**  
Levensgevaar door elektrische schokken in geval van een ondeskundige reparatie

- Elektrische onderdelen moeten door gekwalificeerde elektriciens worden gerepareerd.
- Laat na de reparatie een veiligheidstest conform VDE 0701 of de landspecifieke regelgeving uitvoeren.

**⚠ GEVAAR**  
**Gevaar voor een elektrische schok aan stroomvoerende onderdelen!**  
Dood door elektrocutie

- Haal apparaten minstens 60 seconden voor u met reparaties begint van de stroomvoorziening af.

**⚠ VOORZICHTIG**  
**Scherpe randen!**  
Snijletsel

- Draag veiligheidshandschoenen.

### Voorwaarde:

- ✓ Apparaat is losgekoppeld is van de stroomvoorziening.
- ✓ Deur is open.
- ✓ Het intrieur is verwijderd.

## 4.17.1 LED-verlichting verwijderen

1. Verplaats de LED-verlichting naar de linkerkant.

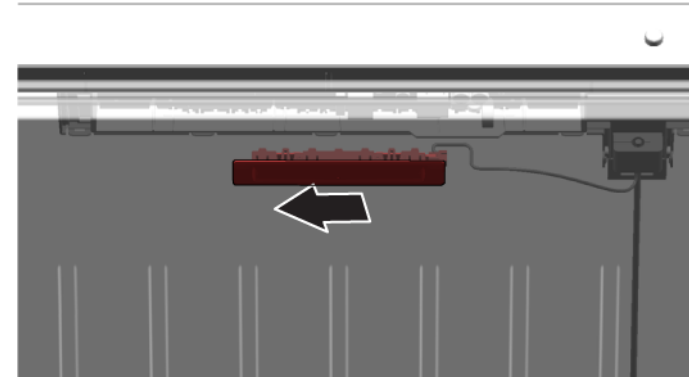

2. De elektrische aansluiting van de LED-verlichting wordt losgemaakt.

2. Haal de haken van de LED-verlichting los.

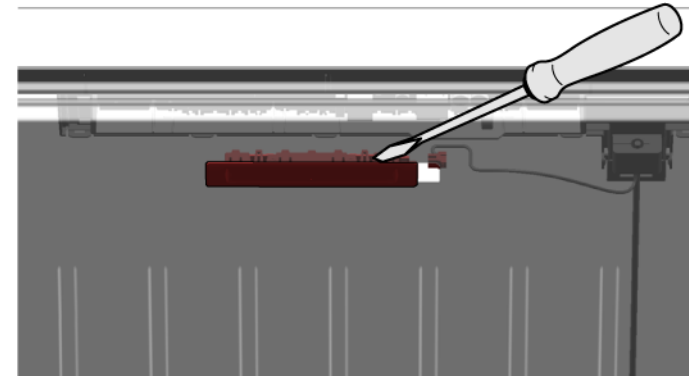

## Reparatie

3. Verwijder de LED-verlichting door het naar voren te bewegen.

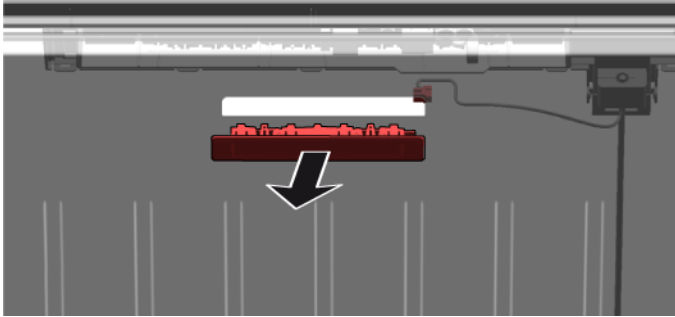

- ➔ LED-verlichting wordt verwijderd.

### 4.17.2 LED-bovenlicht installeren

- ▶ Monteer in omgekeerde volgorde.

## 4.18 LED-zijlichtbalk vervangen

### Voorgestelde tools:

Zuignap Ø50 mm [00342224]

 Uw apparaat heeft een onderhoudsvrije LED-verlichting. Deze lichten mogen alleen maar door de klantenservice of geautoriseerde monteurs worden vervangen!

 **GEVAAR**  
**Gevaar voor een elektrische schok aan stroomvoerende onderdelen!**  
Levensgevaar door elektrische schokken in geval van een ondeskundige reparatie

- ▶ Elektrische onderdelen moeten door gekwalificeerde elektriciens worden gerepareerd.
- ▶ Laat na de reparatie een veiligheidstest conform VDE 0701 of de landspecifieke regelgeving uitvoeren.

 **GEVAAR**  
**Gevaar voor een elektrische schok aan stroomvoerende onderdelen!**  
Dood door elektrocutie

- ▶ Haal apparaten minstens 60 seconden voor u met reparaties begint van de stroomvoorziening af.

 **VOORZICHTIG**  
**Scherpe randen!**  
Snijletsel

- ▶ Draag veiligheidshandschoenen.

### Voorwaarde:

- ✓ Apparaat is losgekoppeld is van de stroomvoorziening.
- ✓ Deur is open.
- ✓ Koelvakplateaus worden verwijderd.

## 4.18.1 LED-zijlichtbalk verwijderen

1. Plak de zuignap op het bovenste derde deel van de LED-zijlichtbalk.



## Reparatie

2. Trek de zuignap met LED-zijlichtbalk in één draaiende beweging naar voren.

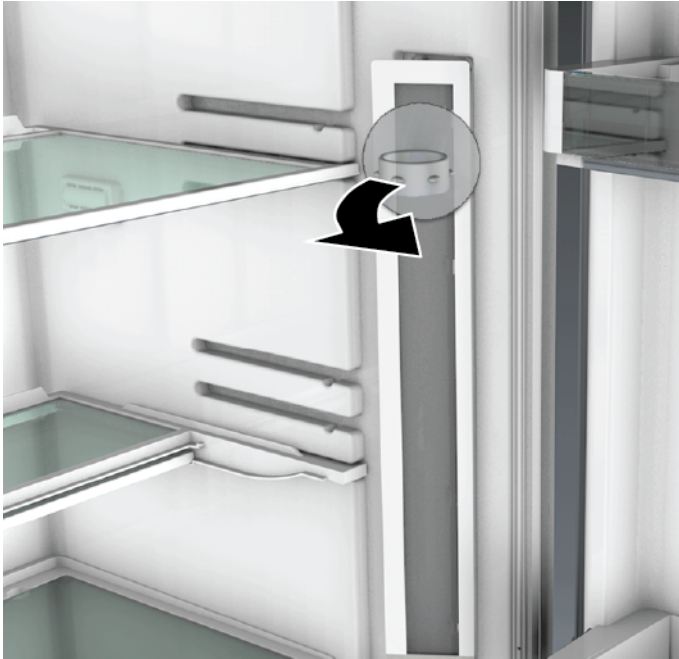





3. Haal de elektrische aansluiting van de LED-zijlichtbalk los.  
 LED-zijlichtbalk wordt verwijderd.

### 4.18.2 LED-zijlichtbalk installeren

1. Verbind de elektrische aansluiting van de LED-zijlichtbalk.
  2. Zet de LED-zijlichtbalk op zijn plaats vast aan de wand van het vak (haak klikt vast).
-  LED-zijlichtbalk wordt geïnstalleerd.

# Self-repair hints - Fridge-freezer combination

 <b>Concerning this document</b> .....	<b>138</b>
1.1 Important information .....	138
1.1.1 Purpose.....	138
1.2 Explanation of symbols .....	138
1.2.1 Danger levels.....	138
1.2.2 Hazard symbols .....	138
1.2.3 Structure of the warnings.....	139
1.2.4 General symbols.....	139
 <b>Safety</b> .....	<b>140</b>
2.1 General Safety instructions .....	140
2.1.1 All domestic appliances .....	140
 <b>Tools and aids</b> .....	<b>141</b>
 <b>Repair</b> .....	<b>142</b>
4.1 Replacing door gasket .....	142
4.2 Replacing door handle .....	143
4.2.1 Removing door handle .....	143
4.2.2 Installing door handle .....	143
4.3 Replacing door upper hinge .....	144
4.3.1 Removing door upper hinge.....	144
4.3.2 Installing door upper hinge.....	145
4.4 Replacing door upper hinge (door with display) .....	146
4.4.1 Removing door upper hinge.....	146
4.4.2 Installing door upper hinge.....	147
4.5 Replacing door middle hinge .....	148
4.5.1 Removing door middle hinge .....	148
4.5.2 Installing door middle hinge .....	148
4.6 Replacing door lower hinge .....	149
4.6.1 Removing door lower hinge .....	149
4.6.2 Installing door lower hinge .....	149
4.7 Replacing shelf.....	150
4.7.1 Removing shelf.....	150
4.7.2 Installing shelf.....	150
4.8 Replacing variable shelf.....	151

4.8.1 Removing variable shelf.....	151
4.8.2 Installing variable shelf.....	151
4.9 Replacing flexible shelf.....	152
4.9.1 Removing flexible shelf .....	152
4.9.2 Installing flexible shelf .....	152
4.10 Replacing breakfast set.....	153
4.10.1 Removing breakfast set .....	153
4.10.2 Installing breakfast set .....	153
4.11 Replacing bottle tray .....	154
4.11.1 Removing bottle tray.....	154
4.11.2 Installing bottle tray.....	154
4.12 Replacing door rack .....	155
4.12.1 Removing door rack.....	155
4.12.2 Installing door rack .....	155
4.13 Replacing frozen food container.....	156
4.13.1 Removing frozen food container .....	156
4.13.2 Installing frozen food container .....	156
4.14 Replacing container .....	157
4.14.1 Removing container.....	157
4.14.2 Installing container.....	157
4.15 Replacing extendable container .....	158
4.15.1 Removing extendable container .....	158
4.15.2 Installing extendable container .....	158
4.16 Replacing LED spot light .....	159
4.16.1 Removing LED spot light.....	159
4.16.2 Installing LED spot light.....	159
4.17 Replacing LED top light.....	160
4.17.1 Removing LED light.....	160
4.17.2 Installing top LED light .....	161
4.18 Replacing LED side bar light.....	162
4.18.1 Removing LED side bar light.....	162
4.18.2 Installing LED side bar light.....	163

# **i** Concerning this document

## 1.1 Important information

### 1.1.1 Purpose

These repair hints support consumer to repair appliances by himself according to the applicable eco-design regulation (as of 03/2021).

They contain information how to exchange defined spare parts including warnings and risks.

In case of questions, please contact our customer service. We will only be liable for damages if the repair hints have been followed properly.

## 1.2 Explanation of symbols

### 1.2.1 Danger levels

The warning levels consist of a symbol and a signal word. The signal word indicates the severity of the danger.









Warning level	Meaning
 <b>Danger</b>	Non-observance of the warning message will result in death or serious injuries.
 <b>Warning</b>	Non-observance of the warning message could result in death or serious injuries.
 <b>Caution</b>	Non-observance of the warning message could result in minor injuries.
 <b>Notice</b>	Non-observance of the warning message could result in damage to property.

Table 1: Danger levels

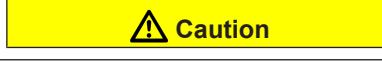
### 1.2.2 Hazard symbols

Hazard symbols are symbolic representations which give an indication of the kind of danger.

The following hazard symbols are used in this document:

Hazard symbol	Meaning
	General warning message
	Danger from electrical voltage
	Risk of explosion
	Danger of cuts
	Danger of crushing

## **i** Concerning this document



Hazard symbol	Meaning
	Danger from hot surfaces
	Danger from strong magnetic field
	Danger from non-ionizing radiation

Table 2: Hazard symbols

### 1.2.3 Structure of the warnings

Warnings in this document have a standardised appearance and a standardised structure.



	<div style="background-color: red; color: white; padding: 2px; text-align: center;"> <b>Danger</b></div> <p><b>Type and source of danger!</b> Possible consequences of ignoring the danger / warning.</p> <ul style="list-style-type: none"> <li>▶ Measures and prohibitions for preventing the danger.</li> </ul>
--	---

The following example shows a warning that warns against electric shock due to live parts. The measure for avoiding the danger is mentioned.

	<div style="background-color: red; color: white; padding: 2px; text-align: center;"> <b>Danger</b></div> <p><b>Risk of electric shock due to live parts!</b> Death by electrocution</p> <ul style="list-style-type: none"> <li>▶ Disconnect appliances from electrical supply at least 60 seconds before starting repairs.</li> </ul>
---	---

### 1.2.4 General symbols

The following general symbols are used in this document:

Gen. symbol	Meaning
	Identification of a special tip (text and/or graphic)
	Identification of a simple tip (only text)
	Identification of a link to a video tutorial





Gen. symbol	Meaning
	Identification of required tools
	Identification of required preconditions
	Identification of a condition (if ..., then ...)
	Identification of a result
[Start]	Identification of a key or button
[00123456]	Identification of a material number
Status	Identification of displayed text / window (in the appliance's display)

Table 3: General symbols

## 2.1 General Safety instructions

### 2.1.1 All domestic appliances

#### **Risk of electric shock due to live parts!**

- Errors by repairs involving electrical components can lead to electrical shock!
- Disconnect the appliance from the mains for at least 60 seconds before starting work.
- After the repair have a safety test according VDE 0701 or country-specific regulations performed.

#### **Risk of injury from sharp edges!**

- Wear protective gloves.

#### **Risk of crushing during repair, maintenance, troubleshooting and service due to heavy and moving components**

- Wear protective shoes.
- Secure heavy components from falling down.
- Do not stick body parts into moving components.

#### **Risk to the appliance's safety / function!**

- Only use original spare parts.

#### **Risk of damage to electrostatically sensitive components (ESDs)!**

- Do not touch the modules, including connections and conductor paths.

## Tools and aids

Designation	Details	Images
Protection cloth [00342013]	60 cm x 50 cm	
Precision screwdriver set [00341820]	9 pieces, 2.0 mm, 2.4 mm, 3.0 mm, PH0, PH00, PH1, TX6, TX8, TX9	
Auxiliary tool [00342180]	For disassembly of plastic parts, "magic tool"	
Suction cup [00342224]	Ø 50 mm	
Torx Bit TX20 [00340865]	6,3 mm (1/4")	
Slotted screwdriver	Blade 10 mm x 1.6 mm x 200 mm	

## Repair



### 4.1 Replacing door gasket

#### Prerequisite:



- Door is open.

## 4.2 Replacing door handle

### Suggested tools:

-  Torx Bit TX20                      6,3 mm (1/4")                      [00340865]
-  Slotted screwdriver                      Blade 10 mm x 1.6 mm x 200 mm

### Prerequisite:

-  Appliance is disconnected from power supply.
-  Door is open.

### 4.2.1 Removing door handle

- ▶ 1. Remove two screw caps (1).
- ▶ 2. Unscrew two screws (2).
- ▶ 3. Remove door handle (3).

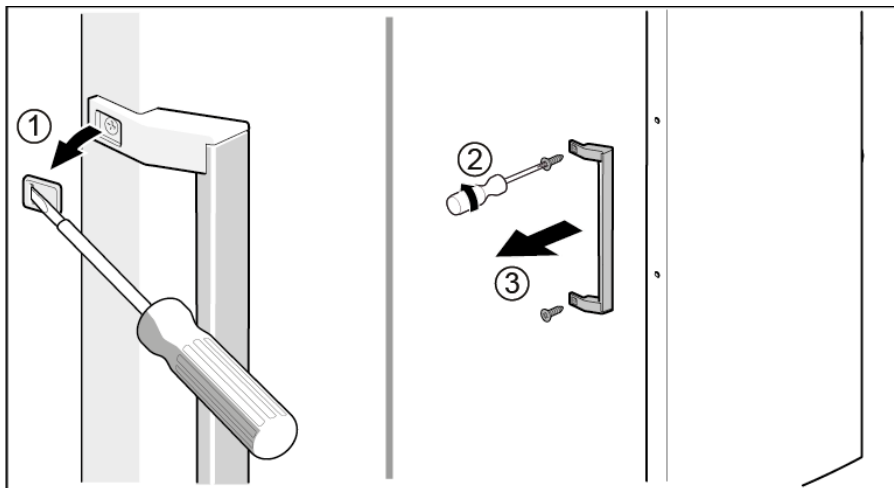

 Door handle is removed.



Door handle for the second door can be removed in the same manner.





### 4.2.2 Installing door handle

- ▶ Install in reverse order.



## 4.3 Replacing door upper hinge

### Suggested tools:

 Torx Bit TX20      6,3 mm (1/4")      [00340865]

	<p style="text-align: center;"><b>Warning</b></p> <p><b>Heavy, bulky appliances!</b> Back and muscle injuries</p> <ul style="list-style-type: none"> <li>▶ Appliance door removal operation should only be carried out by trained specialists.</li> <li>▶ To move the appliance, two people are required.</li> <li>▶ Use only suitable tools and equipment.</li> </ul>
	<p style="text-align: center;"><b>Caution</b></p> <p><b>Sharp edges!</b> Cut injuries</p> <ul style="list-style-type: none"> <li>▶ Wear protective gloves.</li> </ul>
	<p style="text-align: center;"><b>Warning</b></p> <p><b>Slipping of tilted appliances!</b> Bone fractures / crush injuries</p> <ul style="list-style-type: none"> <li>▶ Secure appliances against slipping.</li> </ul>
	<p style="text-align: center;"><b>Caution</b></p> <p><b>Risk of falling parts due to released screws!</b> Injury because of falling parts.</p> <ul style="list-style-type: none"> <li>▶ Secure component from falling down.</li> </ul>
	<p style="text-align: center;"><b>Notice</b></p> <p><b>Risk of falling parts due to released screws!</b> Damage to other parts of the appliance or at customers home e.g. bottom.</p> <ul style="list-style-type: none"> <li>▶ Secure component from falling down.</li> </ul>

### Prerequisite:

-  Appliance is disconnected from power supply.
-  Appliance interior fittings are removed.

### 4.3.1 Removing door upper hinge

1. Place appliance on the back side.

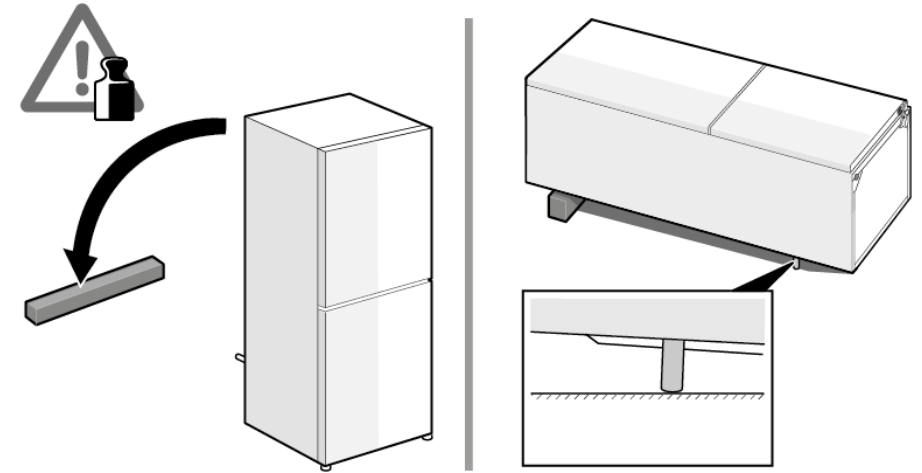

## Repair

2. 1. Press upper hinge cover on both sides (1).
2. Move out upper hinge cover (2).
3. Rotate hinge cover (3).
4. Remove upper hinge cover (4).
5. Unscrew two screws (5).
6. Remove upper hinge (6).

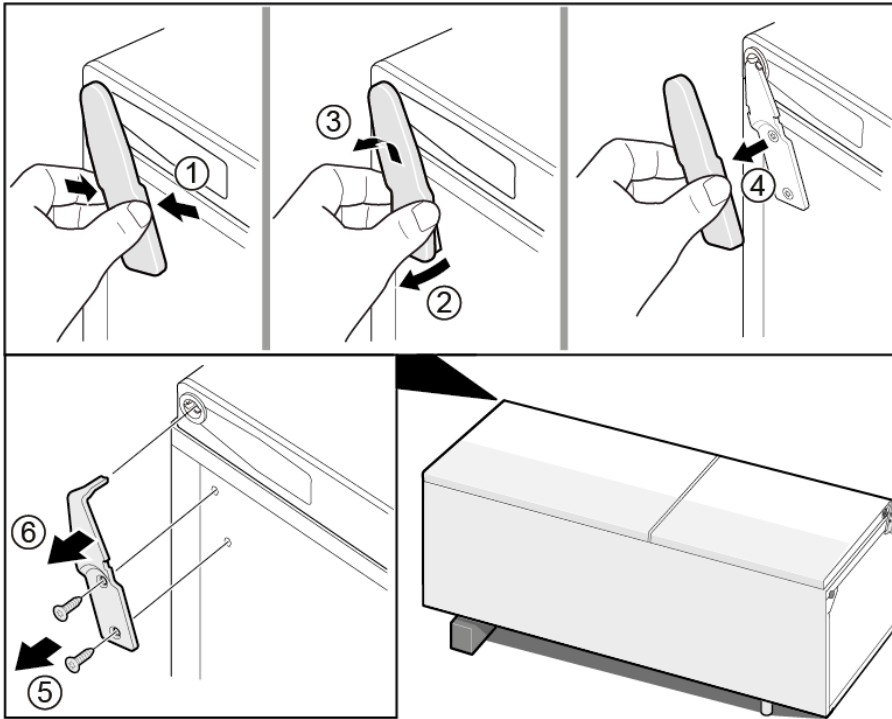

 Upper hinge is removed.

### 4.3.2 Installing door upper hinge

- ▶ Install in reverse order.

## 4.4 Replacing door upper hinge (door with display)

### Suggested tools:

 Torx Bit TX20      6,3 mm (1/4")      [00340865]

	<b>Warning</b>
	<p><b>Heavy, bulky appliances!</b> Back and muscle injuries</p> <ul style="list-style-type: none"> <li>▶ Appliance door removal operation should only be carried out by trained specialists.</li> <li>▶ To move the appliance, two people are required.</li> <li>▶ Use only suitable tools and equipment.</li> </ul>

	<b>Caution</b>
	<p><b>Sharp edges!</b> Cut injuries</p> <ul style="list-style-type: none"> <li>▶ Wear protective gloves.</li> </ul>

	<b>Warning</b>
	<p><b>Slipping of tilted appliances!</b> Bone fractures / crush injuries</p> <ul style="list-style-type: none"> <li>▶ Secure appliances against slipping.</li> </ul>



	<b>Caution</b>
	<p><b>Risk of falling parts due to released screws!</b> Injury because of falling parts.</p> <ul style="list-style-type: none"> <li>▶ Secure component from falling down.</li> </ul>

	<b>Notice</b>
	<p><b>Risk of falling parts due to released screws!</b> Damage to other parts of the appliance or at customers home e.g. bottom.</p> <ul style="list-style-type: none"> <li>▶ Secure component from falling down.</li> </ul>

	<b>Danger</b>
	<p><b>Risk of electric shock due to live parts!</b> Danger to life through electric shock in case of improper repair</p> <ul style="list-style-type: none"> <li>▶ Electric parts should be repaired by a qualified electricians.</li> <li>▶ After the repair have a safety test according VDE 0701 or country-specific regulations performed.</li> </ul>

	<b>Danger</b>
	<p><b>Risk of electric shock due to live parts!</b> Death by electrocution</p> <ul style="list-style-type: none"> <li>▶ Disconnect appliances from electrical supply at least 60 seconds before starting repairs.</li> </ul>

### Prerequisite:

-  Appliance is disconnected from power supply.
-  Appliance interior fittings are removed.

### 4.4.1 Removing door upper hinge

1. Place appliance on the back side.

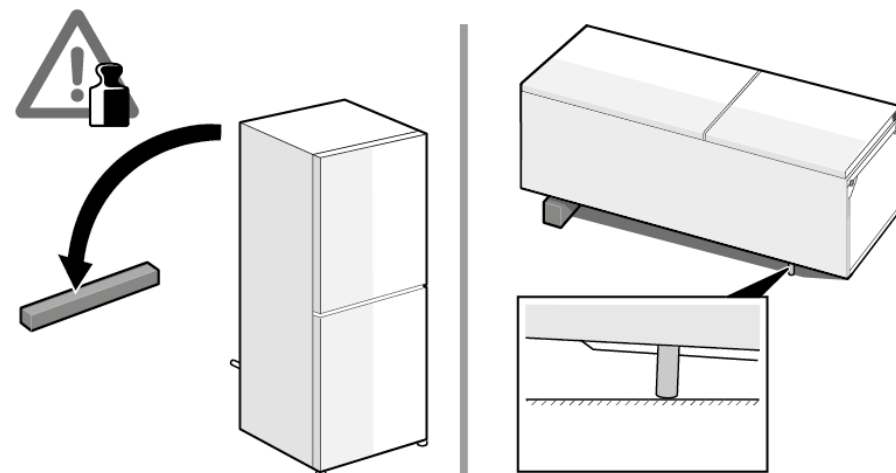

## Repair

2. 1. Remove upper hinge cover (1).
2. Remove cable box cover (2).
3. Disconnect electrical connection (3).
4. Unscrew ground connection screw (4).
5. Remove cable protection (5).
6. Unscrew the screw (6)

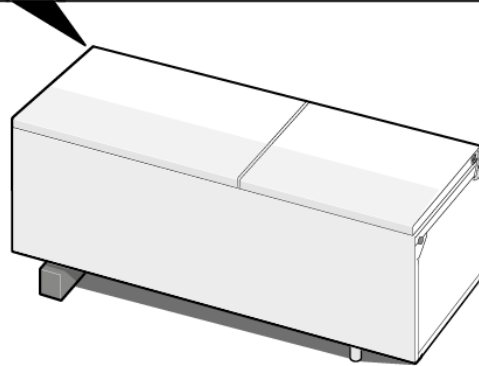
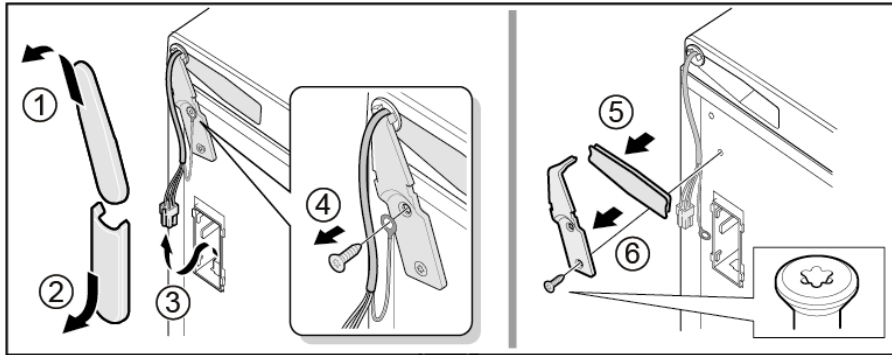

 Upper hinge is removed.

### 4.4.2 Installing door upper hinge

- ▶ Install in reverse order.

## 4.5 Replacing door middle hinge

### Suggested tools:

 Torx Bit TX20      6,3 mm (1/4")      [00340865]



#### Warning

##### Heavy, bulky appliances!

Back and muscle injuries

- ▶ Appliance door removal operation should only be carried out by trained specialists.
- ▶ To move the appliance, two people are required.
- ▶ Use only suitable tools and equipment.



#### Caution

##### Sharp edges!

Cut injuries

- ▶ Wear protective gloves.



#### Warning

##### Slipping of tilted appliances!

Bone fractures / crush injuries

- ▶ Secure appliances against slipping.



#### Caution

##### Risk of falling parts due to released screws!

Injury because of falling parts.

- ▶ Secure component from falling down.





#### Notice

##### Risk of falling parts due to released screws!

Damage to other parts of the appliance or at customers home e.g. bottom.

- ▶ Secure component from falling down.

### Prerequisite:

-  Appliance is disconnected from power supply.
-  Appliance interior fittings are removed.
-  Door upper hinge is removed.

-  Upper door is removed.

### 4.5.1 Removing door middle hinge

- ▶ 1. Remove fridge compartment door (1).
- ▶ 2. Unscrew two screws (2).
- ▶ 3. Remove middle hinge (3).

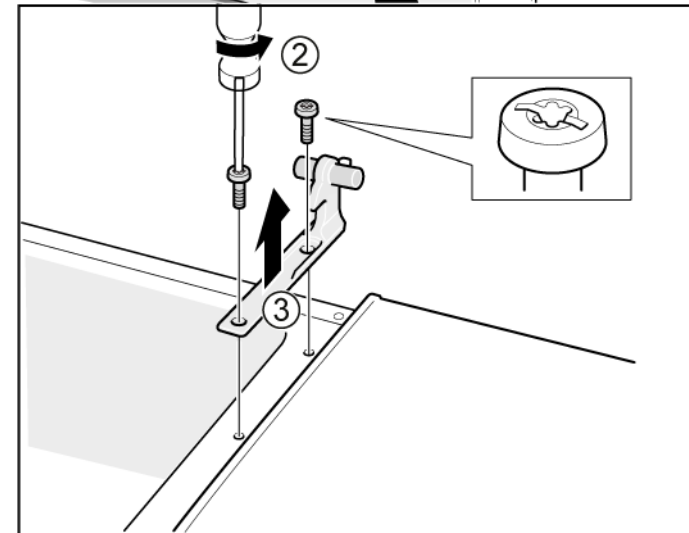
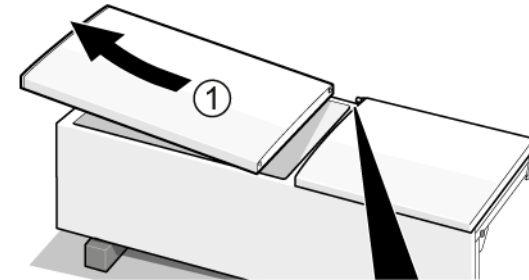

-  Middle hinge is removed.

### 4.5.2 Installing door middle hinge

- ▶ Install in reverse order.

## 4.6 Replacing door lower hinge

### Suggested tools:

 Torx Bit TX20      6,3 mm (1/4")      [00340865]

	<b>Warning</b>
	<p><b>Heavy, bulky appliances!</b> Back and muscle injuries</p> <ul style="list-style-type: none"> <li>▶ Appliance door removal operation should only be carried out by trained specialists.</li> <li>▶ To move the appliance, two people are required.</li> <li>▶ Use only suitable tools and equipment.</li> </ul>



	<b>Caution</b>
	<p><b>Sharp edges!</b> Cut injuries</p> <ul style="list-style-type: none"> <li>▶ Wear protective gloves.</li> </ul>

	<b>Warning</b>
	<p><b>Slipping of tilted appliances!</b> Bone fractures / crush injuries</p> <ul style="list-style-type: none"> <li>▶ Secure appliances against slipping.</li> </ul>

	<b>Caution</b>
	<p><b>Risk of falling parts due to released screws!</b> Injury because of falling parts.</p> <ul style="list-style-type: none"> <li>▶ Secure component from falling down.</li> </ul>

	<b>Notice</b>
	<p><b>Risk of falling parts due to released screws!</b> Damage to other parts of the appliance or at customers home e.g. bottom.</p> <ul style="list-style-type: none"> <li>▶ Secure component from falling down.</li> </ul>

### Prerequisite:

-  Appliance is disconnected from power supply.
-  Appliance interior fittings are removed.
-  Upper hinge is removed.

 Middle hinge is removed.

### 4.6.1 Removing door lower hinge

- ▶ 1. Remove freezer compartment door (1).
- ▶ 2. Unscrew the screw (2).
- ▶ 3. Turn lower hinge out (3).
- ▶ 4. Remove lower hinge (4).

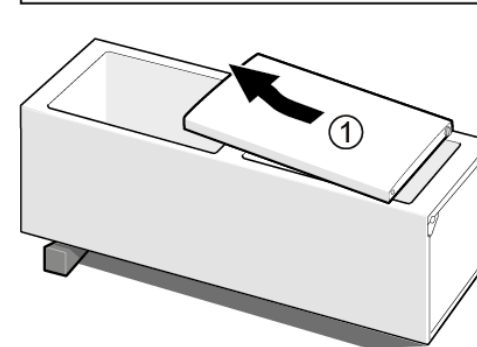
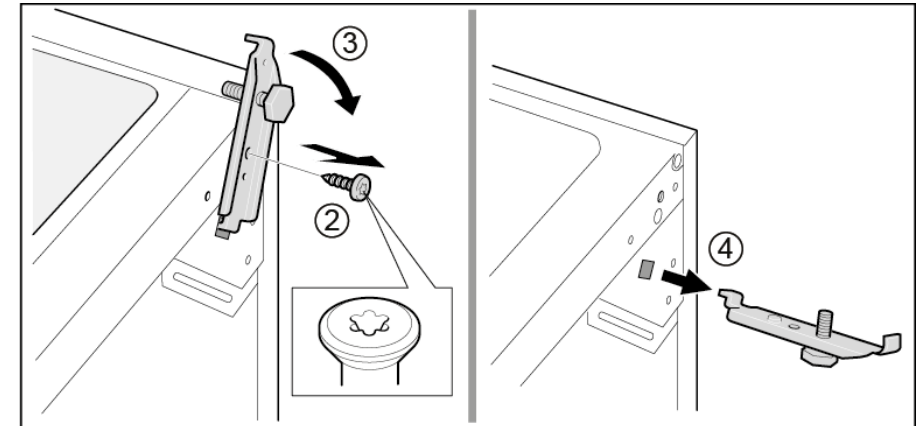

 Door lower hinge is removed.

### 4.6.2 Installing door lower hinge

- ▶ Install in reverse order.

## 4.7 Replacing shelf

### Prerequisite:

- ✔ Door is open.

### 4.7.1 Removing shelf

- ▶ Pull out shelf.

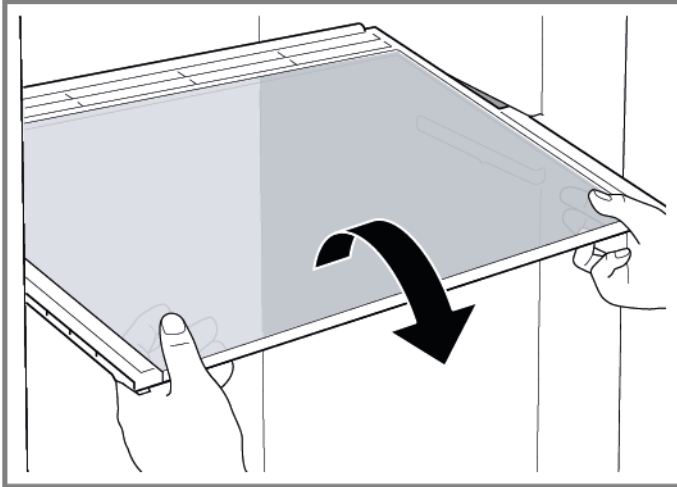

- ➡ Shelf is removed.

### 4.7.2 Installing shelf

- ▶ Install in reverse order.

## 4.8 Replacing variable shelf

### Prerequisite:

- ✔ Door is open.

### 4.8.1 Removing variable shelf

1. Pull the right-hand section of variable shelf forwards (1).
2. Remove right-hand section of variable shelf (2).

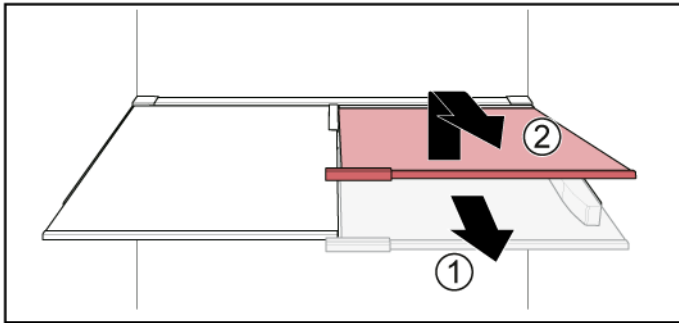

2. Remove left-hand section of variable shelf in the same manner.

- ➡ Variable shelf is removed.

### 4.8.2 Installing variable shelf

- ▶ Install in reverse order.

## 4.9 Replacing flexible shelf

### Prerequisite:

- ✔ Door is open.

### 4.9.1 Removing flexible shelf

- ▶ 1. Remove glass shelf (1).
- ▶ 2. Lift flexible shelf and pull it out (2).

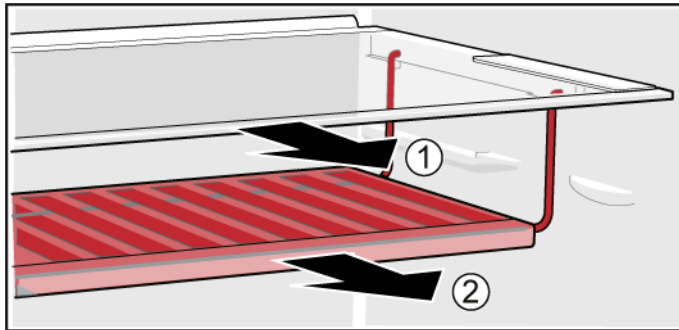

- ➡ Flexible shelf is removed.

### 4.9.2 Installing flexible shelf

- ▶ Install in reverse order.

## 4.10 Replacing breakfast set

### Prerequisite:

- ✔ Door is open.

### 4.10.1 Removing breakfast set

- ▶ Lift breakfast set and pull it out.

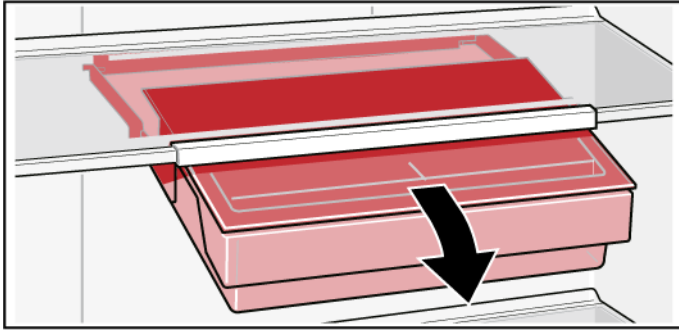

- ➡ Breakfast set is removed.

### 4.10.2 Installing breakfast set

- ▶ Install in reverse order.

## 4.11 Replacing bottle tray

### Prerequisite:

- ✔ Door is open.

### 4.11.1 Removing bottle tray

- ▶ Pull out bottle tray.

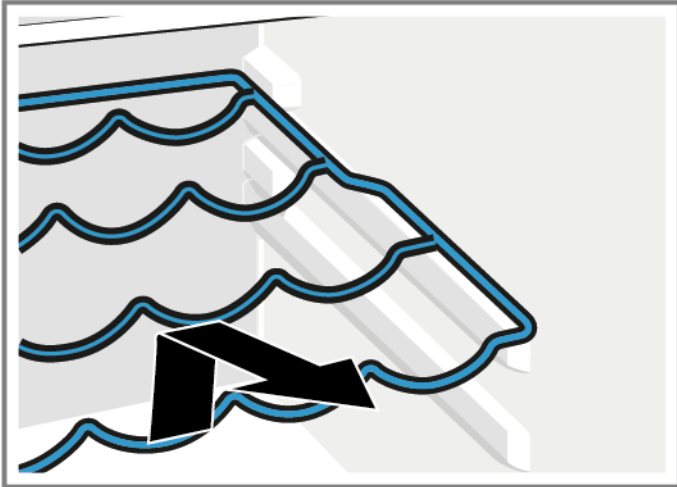

- ➡ Bottle tray is removed.

### 4.11.2 Installing bottle tray

- ▶ Install in reverse order.

## 4.12 Replacing door rack

### Prerequisite:

- ✔ Door is open.

### 4.12.1 Removing door rack

- ▶ Lift door rack upwards.

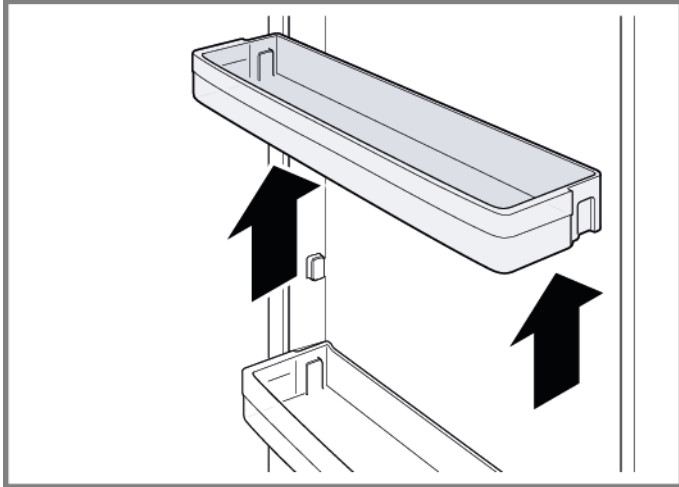

- ➡ Door rack is removed.

### 4.12.2 Installing door rack

- ▶ Install in reverse order.

### 4.13 Replacing frozen food container

**Prerequisite:**

- ✔ Door is open.

#### 4.13.1 Removing frozen food container

- ▶ 1. Pull out frozen food container all the way (1).
- ▶ 2. Remove food container (2).

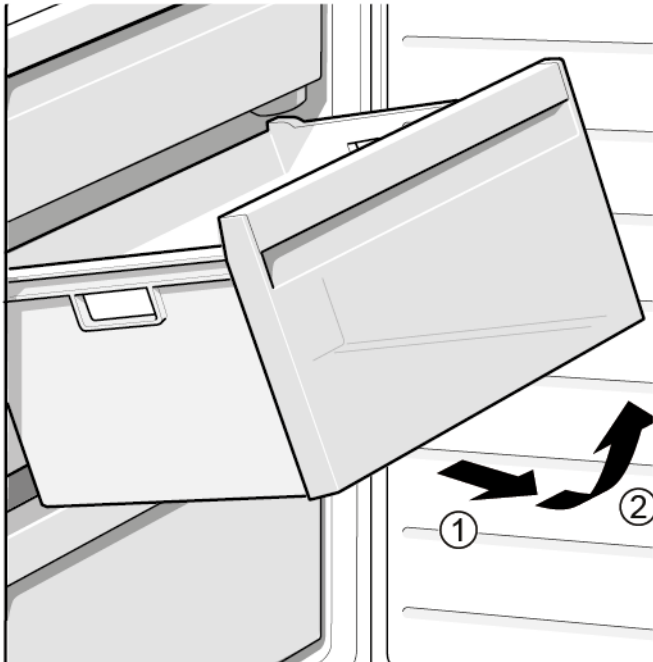

- ➡ Frozen food container is removed.

#### 4.13.2 Installing frozen food container

- ▶ Install in reverse order.

## 4.14 Replacing container

### Prerequisite:

- ✔ Door is open.

### 4.14.1 Removing container

- ▶ 1. Move out lower fridge container (1).
- ▶ 2. Move out upper fridge container (2).

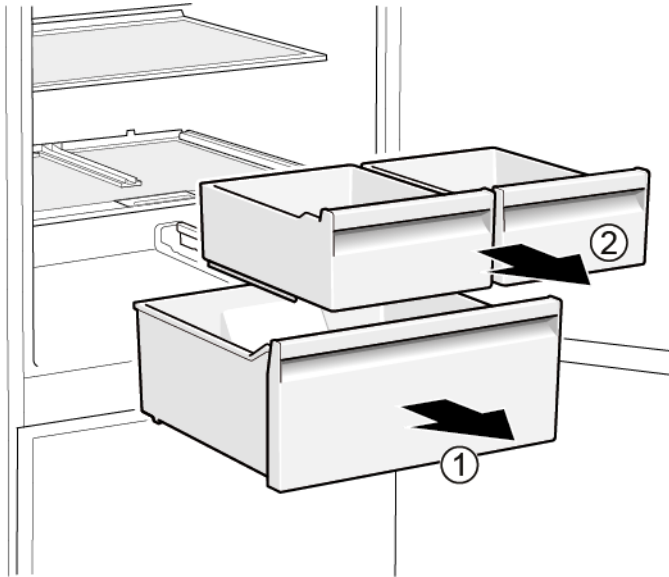

- ➡ Containers are removed.

### 4.14.2 Installing container

- ▶ Install in reverse order.

## 4.15 Replacing extendable container

### Prerequisite:

- ✔ Door is open.

### 4.15.1 Removing extendable container

- ▶ 1. Pull extendable container out all the way (1).
- ▶ 2. Remove extendable container (2).

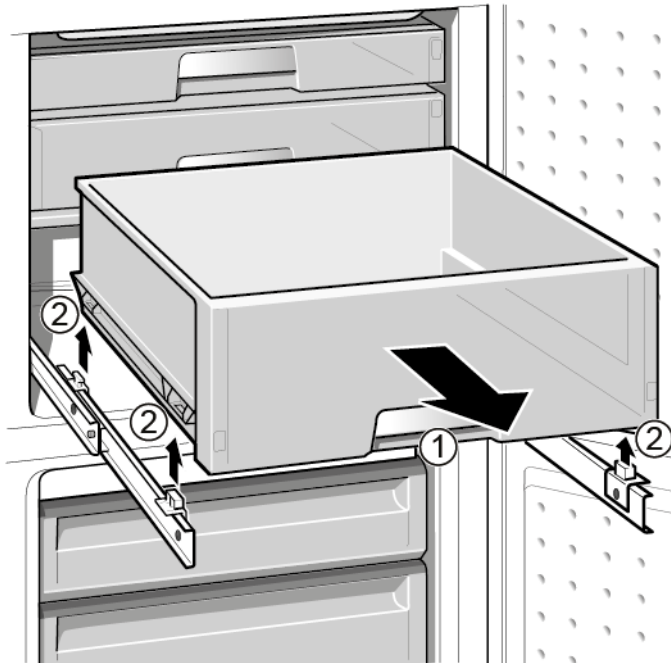

- ➡ Extendable container is removed.

### 4.15.2 Installing extendable container

- ▶ Install in reverse order.

## 4.16 Replacing LED spot light

### Suggested tools:

 Special tool [00342180]

 Your appliance features a maintenance-free LED light. These lights may be repaired by customer service or authorised technicians only!

 **Danger**  
**Risk of electric shock due to live parts!**  
Danger to life through electric shock in case of improper repair

- ▶ Electric parts should be repaired by a qualified electrician.
- ▶ After the repair have a safety test according VDE 0701 or country-specific regulations performed.



 **Danger**  
**Risk of electric shock due to live parts!**  
Death by electrocution

- ▶ Disconnect appliances from electrical supply at least 60 seconds before starting repairs.

 **Caution**  
**Sharp edges!**  
Cut injuries

- ▶ Wear protective gloves.

### Prerequisite:

-  Appliance is disconnected from power supply.
-  Door is open.

### 4.16.1 Removing LED spot light

1. Use special tool to pull out LED spot light (1).

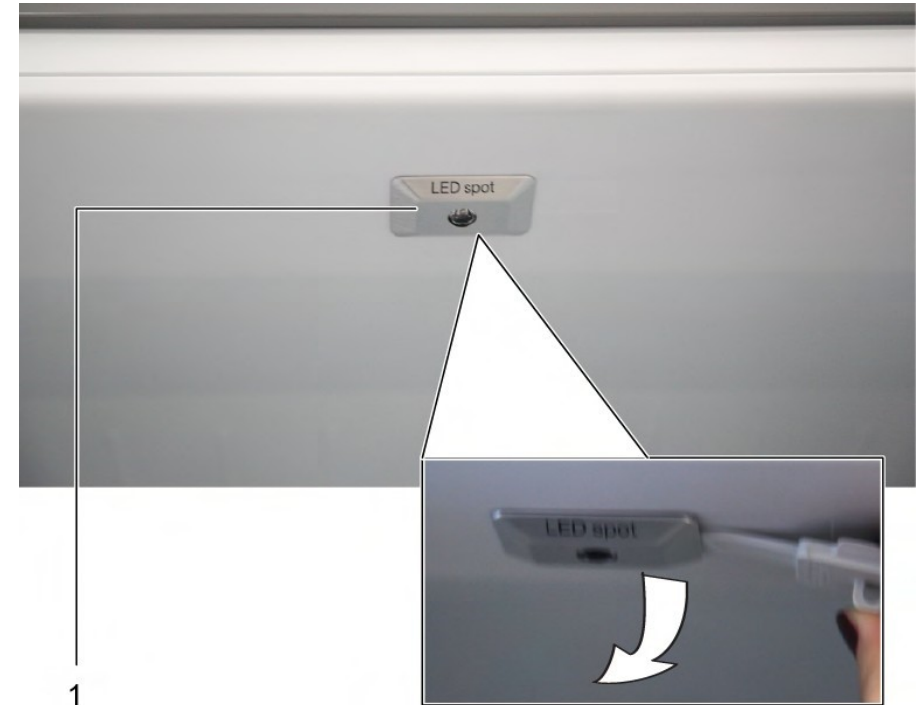

2. Unplug electrical connections of LED spot light.
-  LED spot light is removed.

### 4.16.2 Installing LED spot light

- ▶ Install in reverse order.

## 4.17 Replacing LED top light

### Suggested tools:

- Slotted screwdriver Blade 2.4 mm x 0.4 mm x 60 mm, in the kit [00341820]

**i** Your appliance features a maintenance-free LED light. These lights may be repaired by customer service or authorised technicians only!

**⚠ Danger**  
**Risk of electric shock due to live parts!**  
 Danger to life through electric shock in case of improper repair

- ▶ Electric parts should be repaired by a qualified electrician.
- ▶ After the repair have a safety test according VDE 0701 or country-specific regulations performed.

**⚠ Danger**  
**Risk of electric shock due to live parts!**  
 Death by electrocution

- ▶ Disconnect appliances from electrical supply at least 60 seconds before starting repairs.

**⚠ Caution**  
**Sharp edges!**  
 Cut injuries

- ▶ Wear protective gloves.

### Prerequisite:

- ✔ Appliance is disconnected from power supply.
- ✔ Door is open.
- ✔ Upper interior fittings are removed.

### 4.17.1 Removing LED light

1. Move the LED light to the left side.

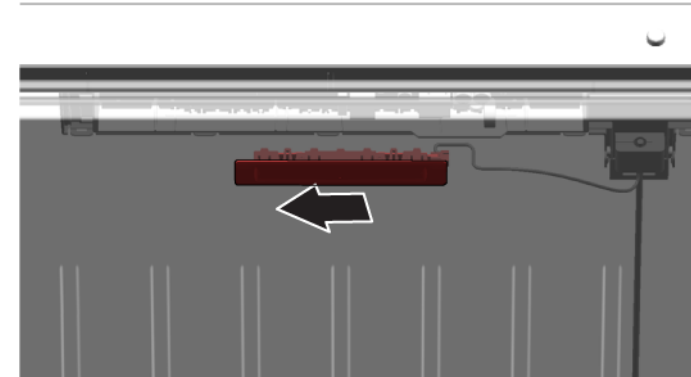

- ➡ LED light electrical connection is disconnected.

2. Release LED light hooks.

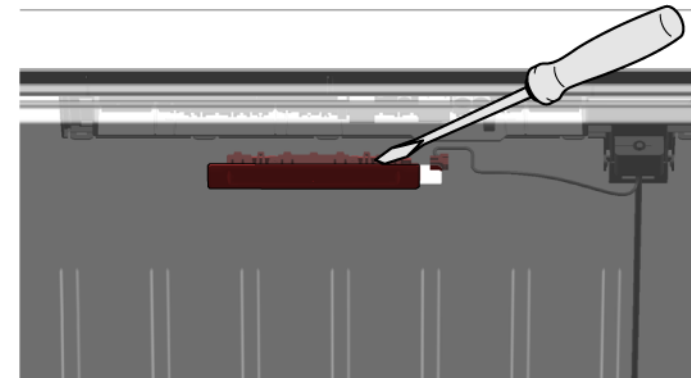

3. Remove LED light moving it forward.

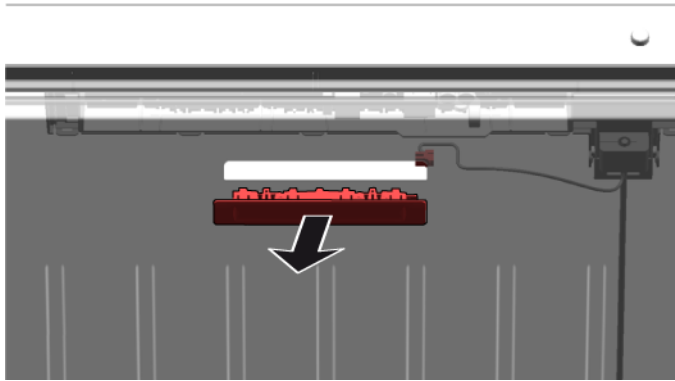

- ➔ LED light is removed.

### 4.17.2 Installing top LED light



- ▶ Install in reverse order.

## 4.18 Replacing LED side bar light



### Suggested tools:

 Suction cup Ø50 mm [00342224]



	Your appliance features a maintenance-free LED light. These lights may be repaired by customer service or authorised technicians only!
---	---

	 <b>Danger</b>
	<b>Risk of electric shock due to live parts!</b> Danger to life through electric shock in case of improper repair <ul style="list-style-type: none"><li>▶ Electric parts should be repaired by a qualified electrician.</li><li>▶ After the repair have a safety test according VDE 0701 or country-specific regulations performed.</li></ul>

	 <b>Danger</b>
	<b>Risk of electric shock due to live parts!</b> Death by electrocution <ul style="list-style-type: none"><li>▶ Disconnect appliances from electrical supply at least 60 seconds before starting repairs.</li></ul>

	 <b>Caution</b>
	<b>Sharp edges!</b> Cut injuries <ul style="list-style-type: none"><li>▶ Wear protective gloves.</li></ul>

### Prerequisite:

-  Appliance is disconnected from power supply.
-  Door is open.
-  Fridge compartment shelves are removed.

### 4.18.1 Removing LED side bar light

1. Stick the suction cup on the upper third of LED side bar light.



2. Pull suction cup with forward LED side bar light in one rotary movement.

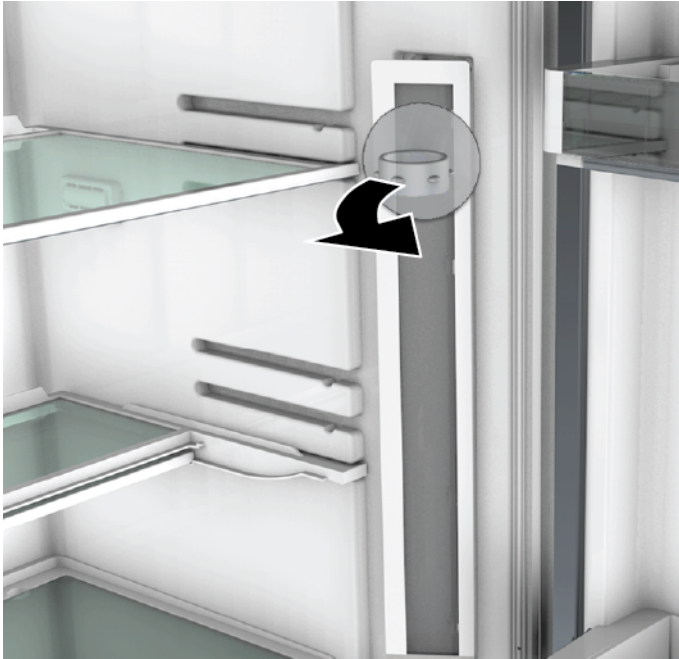



3. Disconnect electrical connection of LED side bar light.  
➡ LED side bar light is removed.

### 4.18.2 Installing LED side bar light

1. Connect electrical connection of LED side bar light.
  2. Fix LED side bar light into it's location on compartment wall (hooks click).
- ➡ LED side bar light is installed.

# Remonditeave - Külmik-sügavkülmik

 <b>Selle dokumendiga seoses .....</b>	<b>165</b>
1.1 Tähtis teave .....	165
1.1.1 Eesmärk.....	165
1.2 Sümbolite selgitus .....	165
1.2.1 Ohutasemed.....	165
1.2.2 Ohusümbolid .....	165
1.2.3 Hoiatuste struktuur.....	166
1.2.4 Üldised sümbolid.....	166
 <b>Ohutus.....</b>	<b>167</b>
2.1 Üldised ohutusjuhised.....	167
2.1.1 Kõik kodumasinad.....	167
 <b>Tööriistad ja abinõud.....</b>	<b>168</b>
 <b>Remont.....</b>	<b>169</b>
4.1 Uksetihendi vahetamine.....	169
4.2 Käepideme vahetamine .....	170
4.2.1 Käepideme eemaldamine .....	170
4.2.2 Käepideme paigaldamine .....	170
4.3 Ülemise uksehinge vahetamine .....	171
4.3.1 Ülemise uksehinge eemaldamine.....	171
4.3.2 Ülemise uksehinge paigaldamine.....	172
4.4 Ülemise uksehinge vahetamine (üks koos kuvaga).....	173
4.4.1 Ülemise uksehinge eemaldamine.....	173
4.4.2 Ülemise uksehinge paigaldamine.....	174
4.5 Keskmise uksehinge vahetamine.....	175
4.5.1 Keskmise uksehinge eemaldamine .....	175
4.5.2 Keskmise uksehinge paigaldamine .....	175
4.6 Alumise uksehinge vahetamine .....	176
4.6.1 Alumise uksehinge eemaldamine.....	176
4.6.2 Alumise uksehinge paigaldamine .....	176
4.7 Riiuli vahetamine .....	177
4.7.1 Riiuli eemaldamine.....	177
4.7.2 Riiuli paigaldamine.....	177
4.8 Reguleeritava riiuli vahetamine.....	178

4.8.1 Reguleeritava riiuli eemaldamine .....	178
4.8.2 Reguleeritava riiuli paigaldamine .....	178
4.9 Paindliku riiuli vahetamine .....	179
4.9.1 Paindliku riiuli eemaldamine .....	179
4.9.2 Paindliku riiuli paigaldamine .....	179
4.10 Hommikusöögikomplekti vahetamine .....	180
4.10.1 Hommikusöögikomplekti eemaldamine .....	180
4.10.2 Hommikusöögikomplekti paigaldamine .....	180
4.11 Pudelialuse vahetamine .....	181
4.11.1 Pudelialuse eemaldamine .....	181
4.11.2 Pudelialuse paigaldamine .....	181
4.12 Ukseraami vahetamine .....	182
4.12.1 Ukseraami eemaldamine .....	182
4.12.2 Ukseraami paigaldamine.....	182
4.13 Külmutatud toidu mahuti vahetamine.....	183
4.13.1 Külmutatud toidu mahuti eemaldamine .....	183
4.13.2 Külmutatud toidu mahuti paigaldamine.....	183
4.14 Mahuti vahetamine.....	184
4.14.1 Mahuti eemaldamine .....	184
4.14.2 Mahuti paigaldamine.....	184
4.15 Laiendatava mahuti vahetamine.....	185
4.15.1 Laiendatava mahuti eemaldamine .....	185
4.15.2 Laiendatava mahuti paigaldamine .....	185
4.16 LED-kohtvalgusti vahetamine .....	186
4.16.1 LED-kohtvalgusti eemaldamine .....	186
4.16.2 LED-kohtvalgusti paigaldamine .....	186
4.17 Ülemise LED-tule vahetamine.....	187
4.17.1 LED-tule eemaldamine .....	187
4.17.2 Ülemise LED-tule paigaldamine.....	188
4.18 Külgmise LED-valgusriba vahetamine .....	189
4.18.1 Külgmise LED-valgusriba eemaldamine.....	189
4.18.2 Külgmise LED-valgusriba paigaldamine .....	190

# **i** Selle dokumendiga seoses

## 1.1 Tähtis teave

### 1.1.1 Eesmärk

Need remondinõuanded toetavad tarbijat seadmete iseseisval remontimisel vastavalt kehtivale ökodisaini määrusele (03/2021).



Need sisaldavad teavet selle kohta, kuidas vahetada teatud varuosi, samuti hoiatusi ning ohtusid.

Küsimuste korral võtke ühendust meie klienditeenindusega. Meie vastutame kahjustuste eest ainult siis, kui remondinõuandeid on õigesti järgitud.

## 1.2 Sümbolite selgitus

### 1.2.1 Ohutasemed

Ohutasemed koosnevad sümbolist ja märksõnast. Märksõna viitab ohu raskusastmele.

Hoiatustase	Tähendus
 <b>OHT</b>	Hoiatusteadete eiramine põhjustab surma või raskeid kehavigastusi.
 <b>HOIATUS</b>	Hoiatusteadete eiramine võib põhjustada surma või raskeid kehavigastusi.
 <b>ETTEVAATUST!</b>	Hoiatusteadete eiramine võib põhjustada kergeid kehavigastusi.
 <b>TÄHELEPANU!</b>	Hoiatusteadete eiramine võib põhjustada varakahju.

Tabel 1: Ohutasemed



### 1.2.2 Ohusümbolid

Ohusümbolid on sümboolsed kujutised, mis viitavad ohu laadile.

Selles dokumendis kasutatakse alljärgnevaid ohusümboleid.

Ohusümbol	Tähendus
	Üldine ohuteade
	Elektripingest tingitud oht
	Plahvatusoht
	Lõikeoht
	Muljumisoht

## **i** Selle dokumendiga seoses

Ohusümbol	Tähendus
	Kuumadest pindadest tingitud oht
	Tugevast magnetväljast tingitud oht
	Mitteioniseerivast kiirgusest tingitud oht

Tabel 2: Ohusümbolid

### 1.2.3 Hoiatuste struktuur

Selles dokumendis olevatel hoiatustel on standardiseeritud väljanägemine ja standardiseeritud struktuur.



	<div style="background-color: red; color: white; padding: 2px; display: inline-block;"><b>⚠ OHT</b></div> <b>Ohu tüüp ja allikas!</b> Ohu/hoiatuse eiramise võimalikud tagajärjed. ▶ Meetmed ja ettevaatusabinõud ohu vältimiseks.
--	---





Alljärgnevas näiteks on näidatud hoiatust, millega hoiatatakse liikuvatest osadest tingitud elektrilöögiuht. Nimetatud on meetet ohu vältimiseks.

	<div style="background-color: red; color: white; padding: 2px; display: inline-block;"><b>⚠ OHT</b></div> <b>Liikuvatest osadest tingitud elektrilöögi oht!</b> Elektrilöögist tingitud surm ▶ Enne remonditöödega alustamist ühendage seadmed elektrivõrgust lahti vähemalt 60 sekundit varem.
---	--

### 1.2.4 Üldised sümbolid

Selles dokumendis kasutatakse alljärgnevaid üldisi sümboleid.

Üld. sümbol	Tähendus
	Erinõuande tunnus (tekst ja/või graafik)
	Lihtsa nõuande tunnus (ainult tekst)
	Videojuhendi lingi tunnus

Üld. sümbol	Tähendus
	Vajalike tööriistade tunnus
	Vajalike eeltingimuste tunnus
	Seisukorra tunnus (kui..., siis...)
	Tulemuse tunnus
[Start]	Klahvi või nupu tunnus
[00123456]	Materjalinumbriga tunnus
Olek	Kuvatava teksti/akna tunnus (seadme ekraanil)

Tabel 3: Üldised sümbolid

## 2.1 Üldised ohutusjuhised

### 2.1.1 Kõik kodumasinad

#### **Liikuvatest osadest tingitud elektrilöögi oht!**

- Elektriliste osade remondil tehtud vead võivad põhjustada elektrilööki!
- Lahutage seade vooluvõrgust vähemalt 60 sekundit enne tööle hakkamist.
- Pärast remonti peab olema tehtud ohutuskatse vastavalt standardile VDE 0701 või riiklikele määrustele.

#### **Teravatest servadest tingitud vigastusoht!**

- Kandke kaitsekindaid.

#### **Rasketest ja liikuvatest osadest tingitud muljumisoht remondi-, puhastustööde, tõrkeotsingu ja hoolduse käigus**

- Kandke turvakingi.
- Kinnitage rasked osad allakukkumise vastu.
- Ärge toppige kehaosi liikuvate osade vahele.

#### **Oht seadme ohutusele/talitlusele!**

- Kasutage ainult originaalvaruosasid.

#### **Elektrostaatiliselt tundlike osade (ESD) kahjustamise oht!**

- Ärge puudutage moduleid, kaasa arvatud ühendusi ega transportöörlinte.

## Tööriistad ja abinõud

Määramine	Üksikasjad	Kujutised
Kaitseriie [00342013]	60 cm × 50 cm	
Täppiskruvikeerajate komplekt [00341820]	9 tükki, 2,0 mm, 2,4 mm, 3,0 mm, PH0, PH00, PH1, TX6, TX8, TX9	
Abitööriist [00342180]	Tööriist plastosade lahtitegemiseks "magic tool"	
Iminapp [00342224]	Ø 50 mm	
Tähtotsik TX20 [00340865]	6,3 mm (1/4 tolli)	
Lapik kruvikeeraja	Tera 10 mm × 1,6 mm × 200 mm	

## 4.1 Uksetihendi vahetamine

Nõue:

- Uks on lahti.

## 4.2 Käepideme vahetamine

### Eritööriistad:

- ☞ Tähtsük TX20 6,3 mm (1/4 tolli) [00340865]
- ☞ Lapik kruvikeeraja Tera 10 mm × 1,6 mm × 200 mm

### Nõue:

- ✔ Seade on toitest lahutatud.
- ✔ Uks on lahti.

### 4.2.1 Käepideme eemaldamine

- ▶ 1. Eemaldage kaks kruvikatet (1).
- ▶ 2. Keerake lahti kaks kruvi (2).
- ▶ 3. Eemaldage käepide (3).

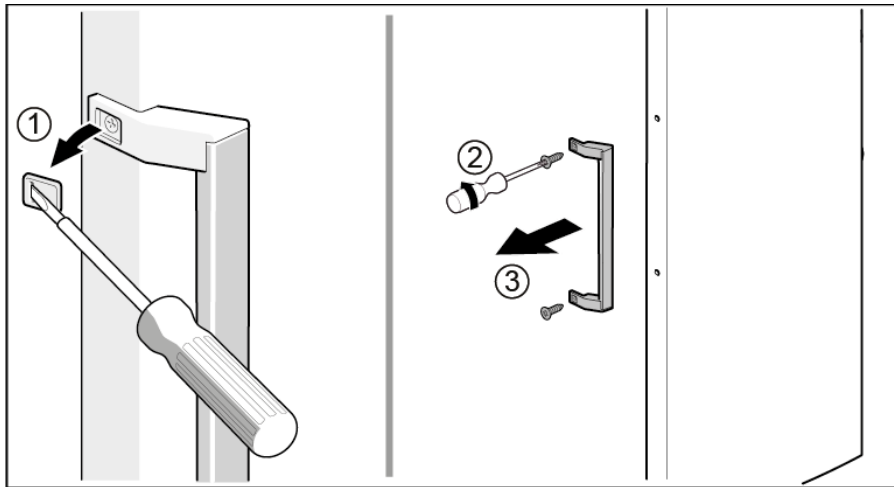

- ➔ Ukse käepide on eemaldatud.



Teise ukse käepidet saab eemaldada samamoodi.

### 4.2.2 Käepideme paigaldamine

- ▶ Paigaldage vastupidises järjekorras.

## 4.3 Ülemise uksehinge vahetamine

Eritööriistad:

Tähtotsik TX20

6,3 mm (1/4 tolli)

[00340865]

	<p style="text-align: center;"><b>HOIATUS</b></p> <p><b>Masked, kogukad seadmed!</b> Selja- ja lihasevigastused</p> <ul style="list-style-type: none"> <li>▶ Seadme ust tohivad eemaldada vaid vastava väljaõppe saanud spetsialistid.</li> <li>▶ Seadme liigutamiseks on vaja kaht inimest.</li> <li>▶ Kasutage vaid sobivaid tööriistu ja varustust.</li> </ul>
	<p style="text-align: center;"><b>ETTEVAATUST!</b></p> <p><b>Teravad servad!</b> Lõikehaavad</p> <ul style="list-style-type: none"> <li>▶ Kandke kaitsekindaid.</li> </ul>
	<p style="text-align: center;"><b>HOIATUS</b></p> <p><b>Viltuses asendis seadmete libisemisoht!</b> Luumurrud/muljumised</p> <ul style="list-style-type: none"> <li>▶ Kindlustage seadmed libisemise vastu.</li> </ul>
	<p style="text-align: center;"><b>ETTEVAATUST!</b></p> <p><b>Lahtikeeratud poltidest tingitud osade kukkumisoht!</b> Kukkuvatest osadest tingitud vigastused.</p> <ul style="list-style-type: none"> <li>▶ Kinnitage osa allakukkumise vastu.</li> </ul>
	<p style="text-align: center;"><b>TÄHELEPANU!</b></p> <p><b>Lahtikeeratud poltidest tingitud osade kukkumisoht!</b> Seadme teiste osade kahjustused või klientide vara kahjustused.</p> <ul style="list-style-type: none"> <li>▶ Kinnitage osa allakukkumise vastu.</li> </ul>

Nõue:

- ✔ Seade on toitest lahutatud.
- ✔ Seadme sisearmatuur on eemaldatud.

### 4.3.1 Ülemise uksehinge eemaldamine

1. Pange seade tagaküljele.

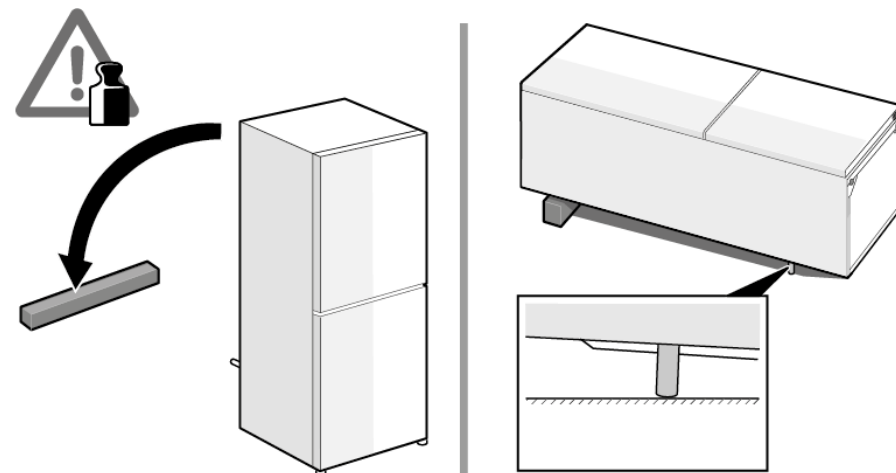

2. 1. Vajutage ülemise hinge katet mõlemal pool (1).
2. Nihutage ülemise hinge kate välja (2).
3. Pöörake hinge katet (3).
4. Eemaldage ülemise hinge kate (4).
5. Eemaldage kaks kruvi (5).
6. Eemaldage ülemine hing (6).

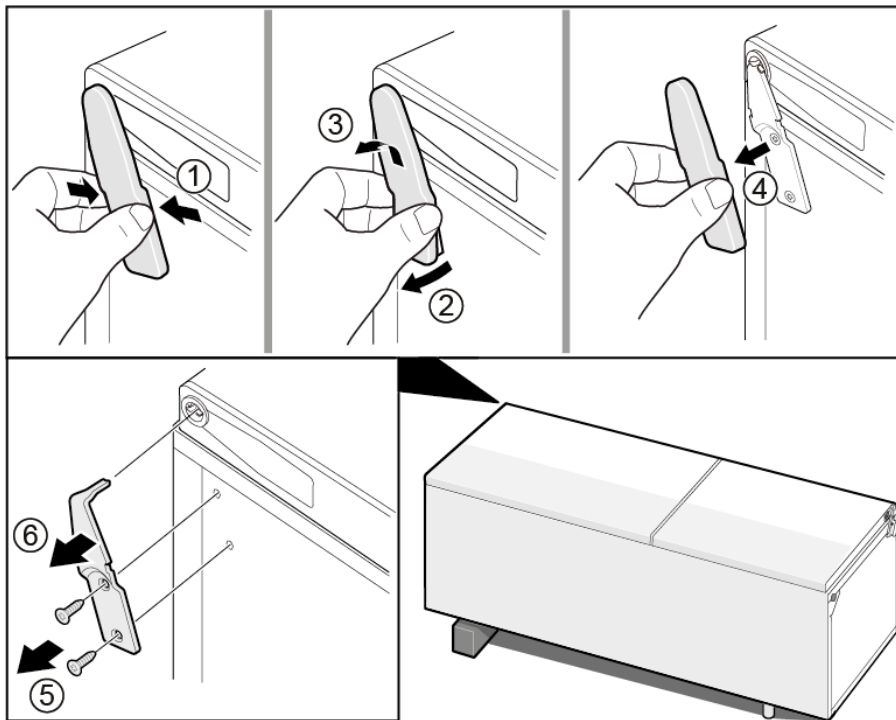

 Ülemine hing on eemaldatud.

### 4.3.2 Ülemise uksehinge paigaldamine

- ▶ Paigaldage vastupidises järjekorras.

## 4.4 Ülemise uksehinge vahetamine (uks koos kuvaga)

### Eritööriistad:

Tähtotsik TX20

6,3 mm (1/4 tolli)

[00340865]

	<b>⚠ HOIATUS</b>
	<p><b>Rasked, kogukad seadmed!</b> Selja- ja lihasevigastused</p> <ul style="list-style-type: none"> <li>▶ Seadme ust tohivad eemaldada vaid vastava väljaõppe saanud spetsialistid.</li> <li>▶ Seadme liigutamiseks on vaja kaht inimest.</li> <li>▶ Kasutage vaid sobivaid tööriistu ja varustust.</li> </ul>

	<b>⚠ ETTEVAATUST!</b>
	<p><b>Teravad servad!</b> Lõikehaavad</p> <ul style="list-style-type: none"> <li>▶ Kandke kaitsekindaid.</li> </ul>

	<b>⚠ HOIATUS</b>
	<p><b>Viltuses asendis seadmete libisemisoht!</b> Luumurrud/muljumised</p> <ul style="list-style-type: none"> <li>▶ Kindlustage seadmed libisemise vastu.</li> </ul>

	<b>⚠ ETTEVAATUST!</b>
	<p><b>Lahtikeeratud poltidest tingitud osade kukkumisoht!</b> Kukkuvatest osadest tingitud vigastused.</p> <ul style="list-style-type: none"> <li>▶ Kinnitage osa allakukkumise vastu.</li> </ul>

	<b>TÄHELEPANU!</b>
	<p><b>Lahtikeeratud poltidest tingitud osade kukkumisoht!</b> Seadme teiste osade kahjustused või klientide vara kahjustused.</p> <ul style="list-style-type: none"> <li>▶ Kinnitage osa allakukkumise vastu.</li> </ul>

	<b>⚠ OHT</b>
	<p><b>Liikuvatest osadest tingitud elektrilöögi oht!</b> Kui remonditööd on valesti tehtud, esineb elektrilöögist tingitud eluohu.</p> <ul style="list-style-type: none"> <li>▶ Elektrilisi osasid peavad parandama kvalifitseeritud elektrikud.</li> <li>▶ Pärast remonti peab olema tehtud ohutuskatse vastavalt standardile VDE 0701 või riiklikele määrustele.</li> </ul>

	<b>⚠ OHT</b>
	<p><b>Liikuvatest osadest tingitud elektrilöögi oht!</b> Elektrilöögist tingitud surm</p> <ul style="list-style-type: none"> <li>▶ Enne remonditöödega alustamist ühendage seadmed elektrivõrgust lahti vähemalt 60 sekundit varem.</li> </ul>

### Nõue:

- ✓ Seade on toitest lahutatud.
- ✓ Seadme sisearmatuur on eemaldatud.

### 4.4.1 Ülemise uksehinge eemaldamine

1. Pange seade tagaküljele.

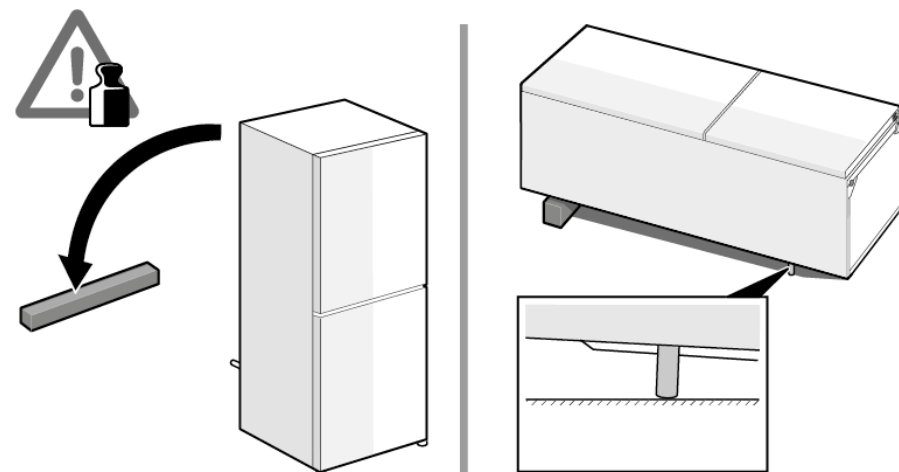

2. 1. Eemaldage ülemise hinge kate (1).
2. Eemaldage kaablikarbi kate (2).
3. Lahutage elektriühendus (3).
4. Keerake lahti maaühenduse kruvi (4).
5. Eemaldage kaablikaitse (5).
6. Keerake kruvi lahti (6).

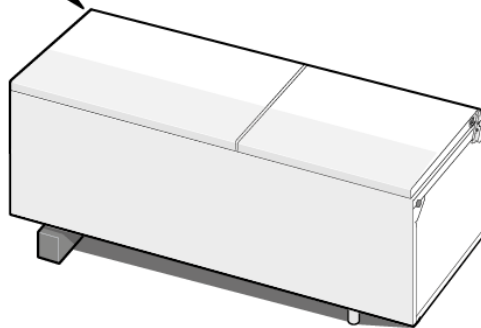
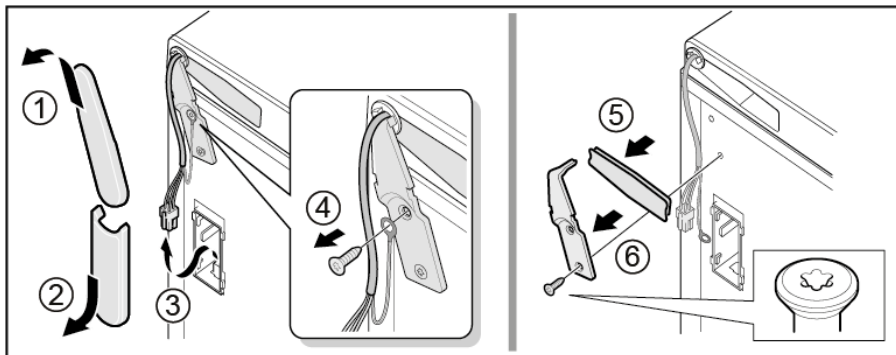

 Ülemine hing on eemaldatud.

### 4.4.2 Ülemise uksehinge paigaldamine

- ▶ Paigaldage vastupidises järjekorras.

## 4.5 Keskmise uksehinge vahetamine

### Eritööriistad:

Tähtotsik TX20

6,3 mm (1/4 tolli)

[00340865]

	<p style="text-align: center;"><b>HOIATUS</b></p> <p><b>Masked, kogukad seadmed!</b> Selja- ja lihasevigastused</p> <ul style="list-style-type: none"> <li>▶ Seadme ust tohivad eemaldada vaid vastava väljaõppe saanud spetsialistid.</li> <li>▶ Seadme liigutamiseks on vaja kaht inimest.</li> <li>▶ Kasutage vaid sobivaid tööriistu ja varustust.</li> </ul>
	<p style="text-align: center;"><b>ETTEVAATUST!</b></p> <p><b>Teravad servad!</b> Lõikehaavad</p> <ul style="list-style-type: none"> <li>▶ Kandke kaitsekindaid.</li> </ul>
	<p style="text-align: center;"><b>HOIATUS</b></p> <p><b>Viltuses asendis seadmete libisemisoht!</b> Luumurrud/muljumised</p> <ul style="list-style-type: none"> <li>▶ Kindlustage seadmed libisemise vastu.</li> </ul>
	<p style="text-align: center;"><b>ETTEVAATUST!</b></p> <p><b>Lahtikeeratud poltidest tingitud osade kukkumisoht!</b> Kukkuvatest osadest tingitud vigastused.</p> <ul style="list-style-type: none"> <li>▶ Kinnitage osa allakukkumise vastu.</li> </ul>
	<p style="text-align: center;"><b>TÄHELEPANU!</b></p> <p><b>Lahtikeeratud poltidest tingitud osade kukkumisoht!</b> Seadme teiste osade kahjustused või klientide vara kahjustused.</p> <ul style="list-style-type: none"> <li>▶ Kinnitage osa allakukkumise vastu.</li> </ul>

### Nõue:

- ✔ Seade on toitest lahutatud.
- ✔ Seadme sisearmatuur on eemaldatud.
- ✔ Ülemine uksehing on eemaldatud.
- ✔ Ülemine uks on eemaldatud.

### 4.5.1 Keskmise uksehinge eemaldamine

- ▶ 1. Eemaldage külmikuosa uks (1).
- ▶ 2. Keerake lahti kaks kruvi (2).
- ▶ 3. Eemaldage keskmine hing (3).

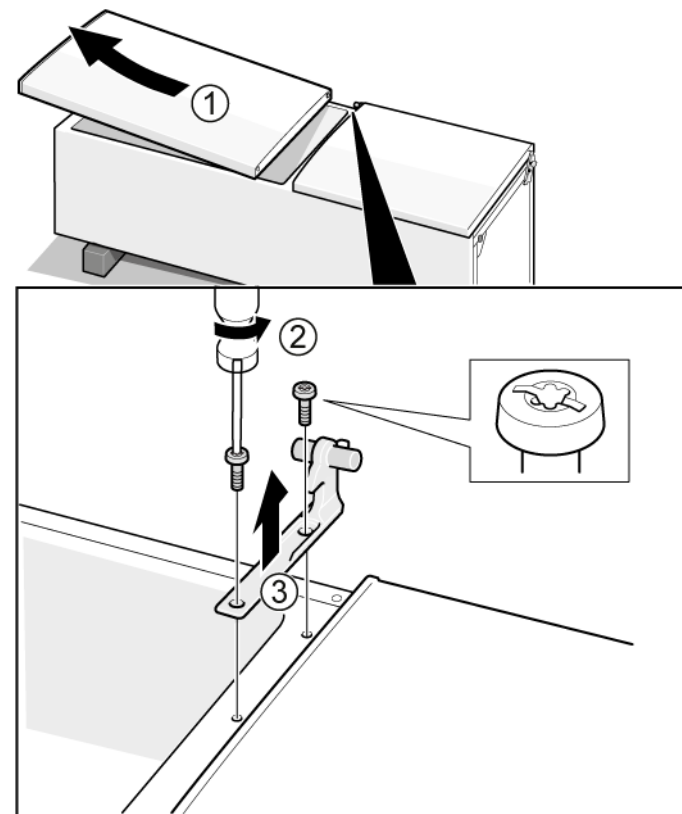

- ➡ Keskmise hing on eemaldatud.

### 4.5.2 Keskmise uksehinge paigaldamine

- ▶ Paigaldage vastupidises järjekorras.

## 4.6 Alumise uksehinge vahetamine

### Eritööriistad:

Tähtotsik TX20

6,3 mm (1/4 tolli)

[00340865]

	<p style="text-align: center;"><b>⚠ HOIATUS</b></p> <p><b>Masked, kogukad seadmed!</b> Selja- ja lihasevigastused</p> <ul style="list-style-type: none"> <li>▶ Seadme ust tohivad eemaldada vaid vastava väljaõppe saanud spetsialistid.</li> <li>▶ Seadme liigutamiseks on vaja kaht inimest.</li> <li>▶ Kasutage vaid sobivaid tööriistu ja varustust.</li> </ul>
	<p style="text-align: center;"><b>⚠ ETTEVAATUST!</b></p> <p><b>Teravad servad!</b> Lõikehaavad</p> <ul style="list-style-type: none"> <li>▶ Kandke kaitsekindaid.</li> </ul>
	<p style="text-align: center;"><b>⚠ HOIATUS</b></p> <p><b>Viltuses asendis seadmete libisemisoht!</b> Luumurrud/muljumised</p> <ul style="list-style-type: none"> <li>▶ Kindlustage seadmed libisemise vastu.</li> </ul>
	<p style="text-align: center;"><b>⚠ ETTEVAATUST!</b></p> <p><b>Lahtikeeratud poltidest tingitud osade kukkumisoht!</b> Kukkuvatest osadest tingitud vigastused.</p> <ul style="list-style-type: none"> <li>▶ Kinnitage osa allakukkumise vastu.</li> </ul>
	<p style="text-align: center;"><b>TÄHELEPANU!</b></p> <p><b>Lahtikeeratud poltidest tingitud osade kukkumisoht!</b> Seadme teiste osade kahjustused või klientide vara kahjustused.</p> <ul style="list-style-type: none"> <li>▶ Kinnitage osa allakukkumise vastu.</li> </ul>

### Nõue:

- ✔ Seade on toitest lahutatud.
- ✔ Seadme sisearmatuur on eemaldatud.
- ✔ Ülemine hing on eemaldatud.
- ✔ Keskmine hing on eemaldatud.

### 4.6.1 Alumise uksehinge eemaldamine

- ▶ 1. Eemaldage sügavkülmikuosa uks (1).
- ▶ 2. Keerake kruvi lahti (2).
- ▶ 3. Keerake alumine hing välja (3).
- ▶ 4. Eemaldage alumine hing (4).

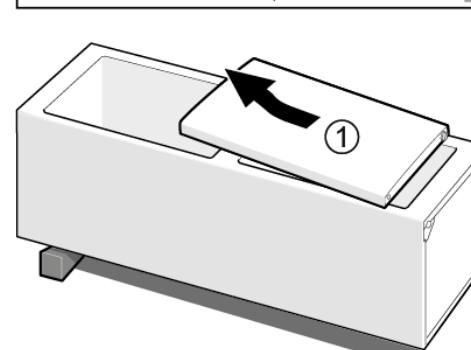
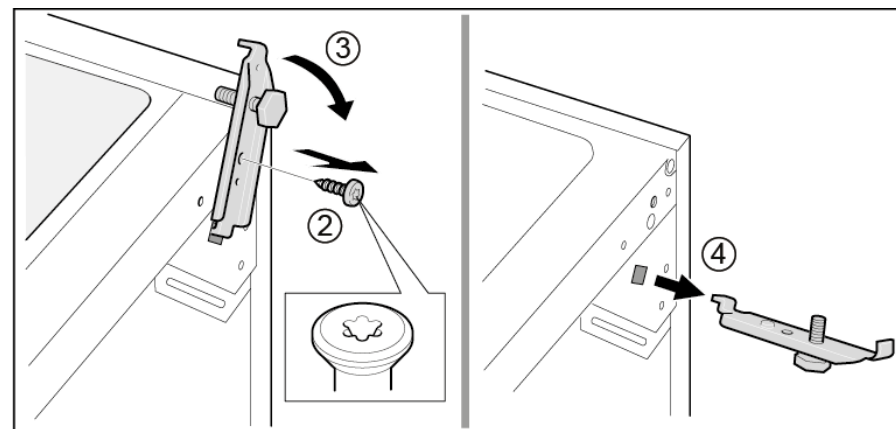

- ➡ Alumine uksehing on eemaldatud.

### 4.6.2 Alumise uksehinge paigaldamine

- ▶ Paigaldage vastupidises järjekorras.

## 4.7 Riiuli vahetamine

Nõue:

- ✔ Uks on lahti.

### 4.7.1 Riiuli eemaldamine

- ▶ Tõmmake riiul välja.

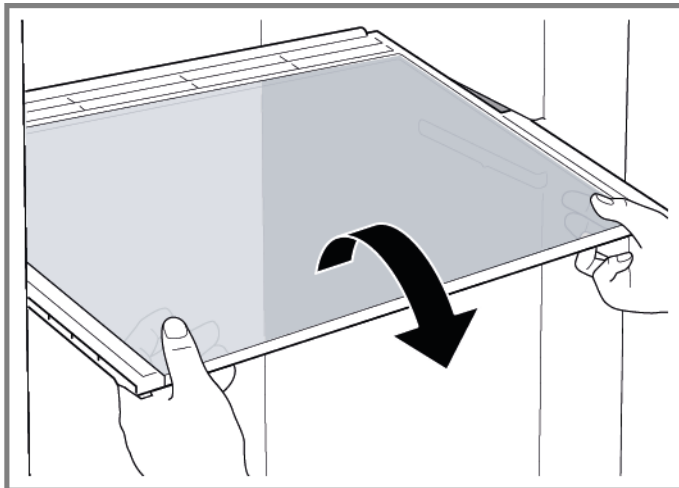

➡ Riiul on eemaldatud.

### 4.7.2 Riiuli paigaldamine

- ▶ Paigaldage vastupidises järjekorras.

## 4.8 Reguleeritava riuli vahetamine

Nõue:

- ✓ Uks on lahti.

### 4.8.1 Reguleeritava riuli eemaldamine

1. Tõmmake reguleeritava riuli parempoolset osa ettepoole (1).
2. Eemaldage reguleeritava riuli parempoolne osa (2).

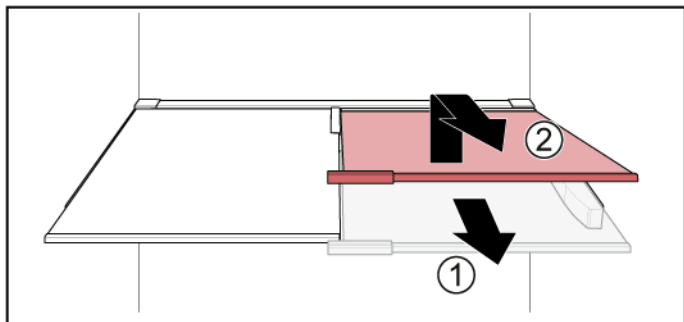

2. Eemaldage reguleeritava riuli vasakpoolne osa samamoodi.

➡ Reguleeritav riul on eemaldatud.

### 4.8.2 Reguleeritava riuli paigaldamine

- ▶ Paigaldage vastupidises järjekorras.

## 4.9 Paindliku riuli vahetamine

Nõue:

- ✓ Uks on lahti.

### 4.9.1 Paindliku riuli eemaldamine

- ▶ 1. Eemaldage klaasriiul (1).
- ▶ 2. Tõstke paindlikku riulit ja tõmmake see välja (2).

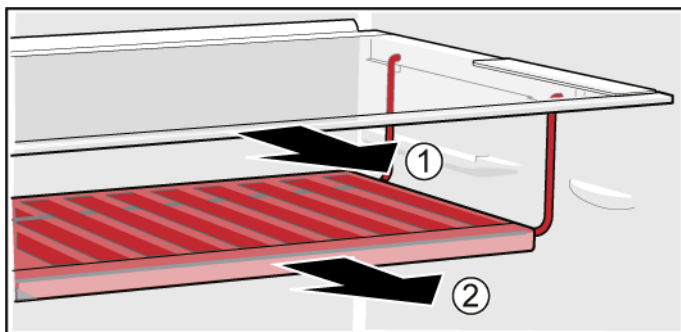

- ➡ Paindlik riul on eemaldatud.

### 4.9.2 Paindliku riuli paigaldamine

- ▶ Paigaldage vastupidises järjekorras.

## 4.10 Hommikusöögikomplekti vahetamine

Nõue:

- ✓ Uks on lahti.

### 4.10.1 Hommikusöögikomplekti eemaldamine

- ▶ Tõstke hommikusöögikomplekti ja tõmmake see välja.

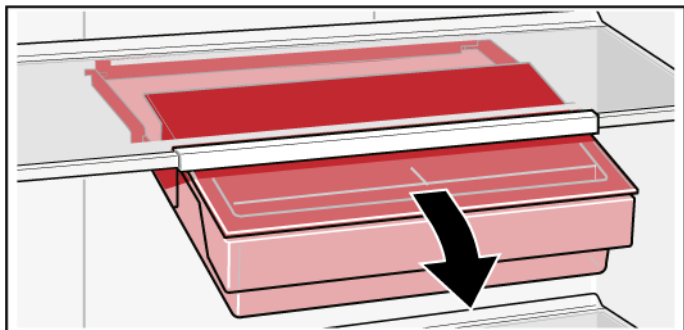

- ➡ Hommikusöögikomplekt on eemaldatud.

### 4.10.2 Hommikusöögikomplekti paigaldamine

- ▶ Paigaldage vastupidises järjekorras.

## 4.11 Pudelialuse vahetamine

Nõue:

- ✓ Uks on lahti.

### 4.11.1 Pudelialuse eemaldamine

- ▶ Tõmmake pudelialus välja.

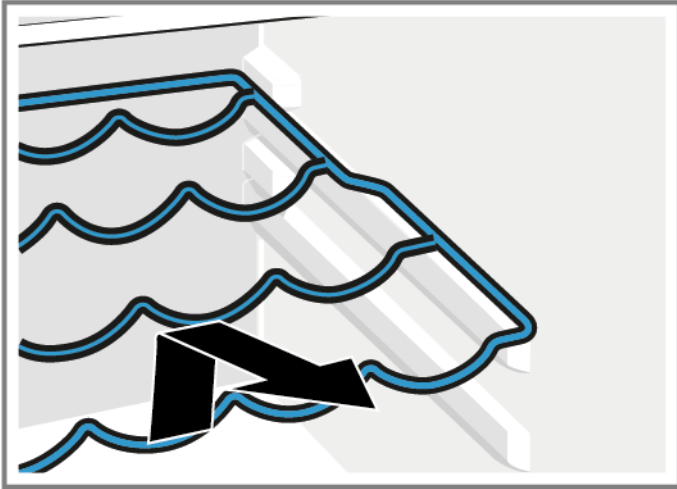

➡ Pudelialus on eemaldatud.

### 4.11.2 Pudelialuse paigaldamine

- ▶ Paigaldage vastupidises järjekorras.

## 4.12 Ukseraami vahetamine

Nõue:

- ✓ Uks on lahti.

### 4.12.1 Ukseraami eemaldamine

- ▶ Tõstke ukseraam üles.

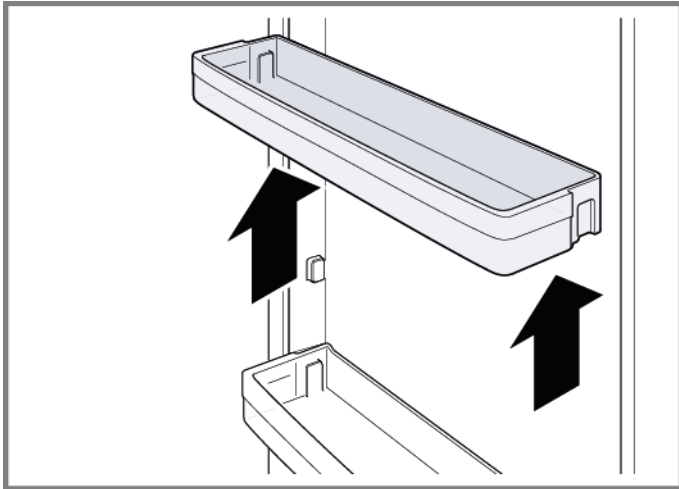

➡ Ukseraam on eemaldatud.

### 4.12.2 Ukseraami paigaldamine

- ▶ Paigaldage vastupidises järjekorras.

## 4.13 Külmutatud toidu mahuti vahetamine

Nõue:

- ✔ Uks on lahti.

### 4.13.1 Külmutatud toidu mahuti eemaldamine

- ▶ 1. Tõmmake külmutatud toidu mahuti täielikult välja (1).
- ▶ 2. Eemaldage toidumahuti (2).

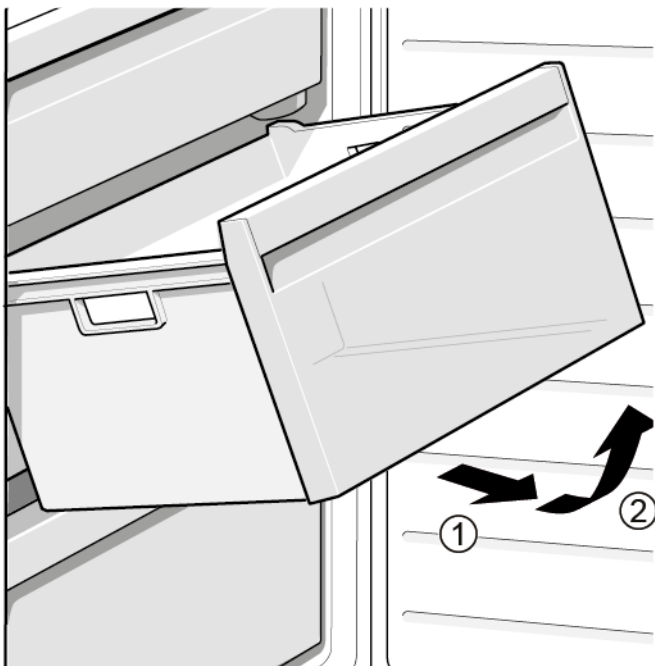

- ➡ Külmutatud toidu mahuti on eemaldatud.

### 4.13.2 Külmutatud toidu mahuti paigaldamine

- ▶ Paigaldage vastupidises järjekorras.

## 4.14 Mahuti vahetamine

Nõue:

- ✓ Uks on lahti.

### 4.14.1 Mahuti eemaldamine

- ▶ 1. Tõmmake alumine külmpakimahuti välja (1).
- ▶ 2. Tõmmake ülemine külmpakimahuti välja (2).

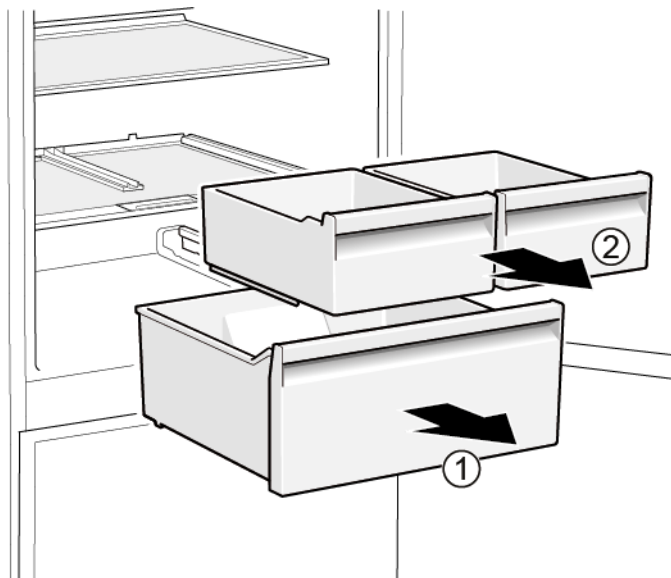

- ➡ Mahutid on eemaldatud.

### 4.14.2 Mahuti paigaldamine

- ▶ Paigaldage vastupidises järjekorras.

## 4.15 Laiendatava mahuti vahetamine

Nõue:

- ✔ Uks on lahti.

### 4.15.1 Laiendatava mahuti eemaldamine

- ▶ 1. Tõmmake laiendatav mahuti täielikult välja (1).
- ▶ 2. Eemaldage laiendatav mahuti (2).

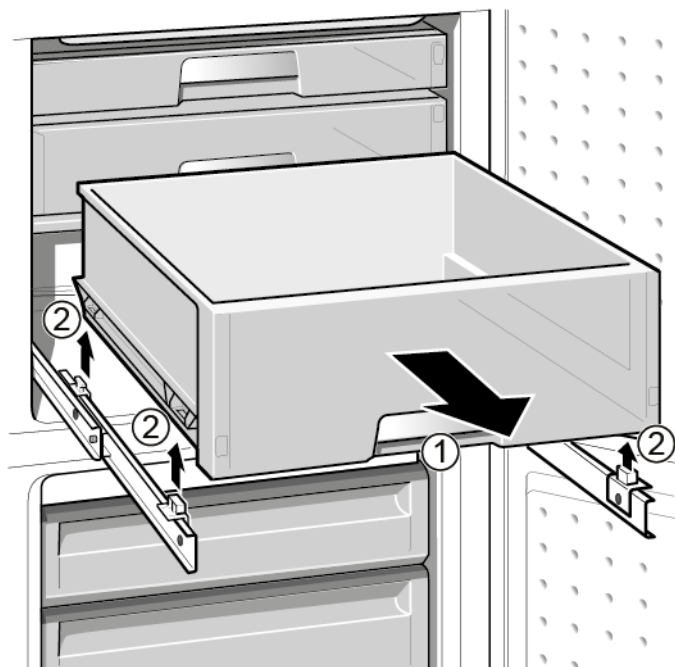

- ➡ Laiendatav mahuti on eemaldatud.

### 4.15.2 Laiendatava mahuti paigaldamine

- ▶ Paigaldage vastupidises järjekorras.

## 4.16 LED-kohtvalgusti vahetamine

### Eritööriistad:

Eritööriist [00342180]

 Teie seadmel on LED-tuli, mis ei vaja hooldust.  
Seda tuld tohib parandada ainult klienditeenindus või volitatud tehnik!

 **OHT**  
**Liikuvatest osadest tingitud elektrilöögi oht!**  
Kui remonditööd on valesti tehtud, esineb elektrilöögist tingitud eluoht.  
▶ Elektrilisi osadid peavad parandama kvalifitseeritud elektrikud.  
▶ Pärast remonti peab olema tehtud ohutuskatse vastavalt standardile VDE 0701 või riiklikele määrustele.

 **OHT**  
**Liikuvatest osadest tingitud elektrilöögi oht!**  
Elektrilöögist tingitud surm  
▶ Enne remonditöödega alustamist ühendage seadmed elektrivõrgust lahti vähemalt 60 sekundit varem.

 **ETTEVAATUST!**  
**Teravad servad!**  
Lõikehaavad  
▶ Kandke kaitsekindaid.

### Nõue:

- ✔ Seade on toitest lahutatud.
- ✔ Uks on lahti.

### 4.16.1 LED-kohtvalgusti eemaldamine

1. Kasutage LED-kohtvalgusti väljatõmbamiseks eritööriista (1).

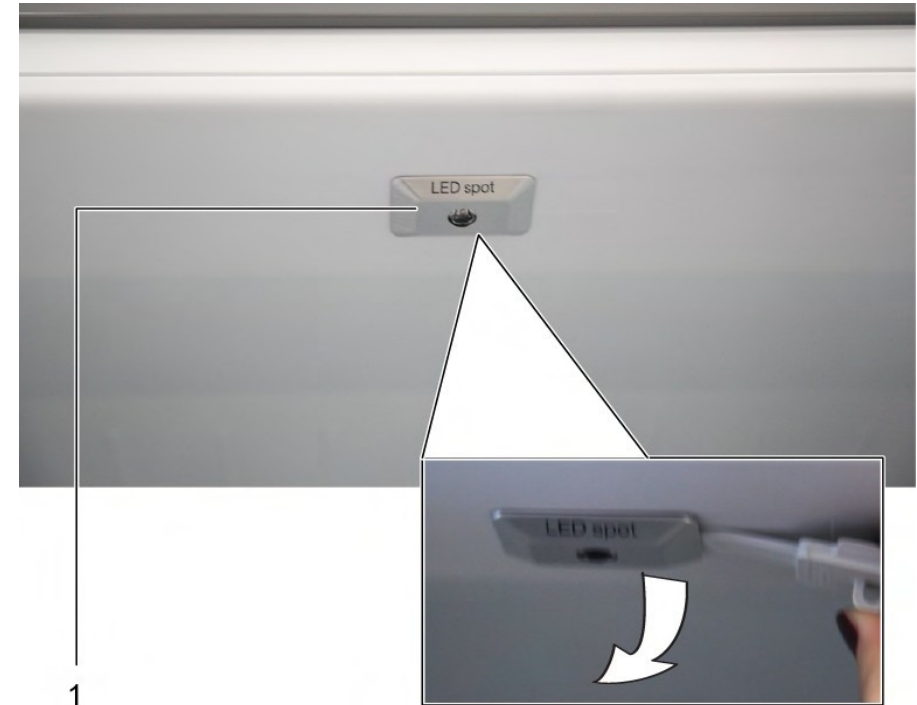

2. Ühendage lahti LED-kohtvalgusti elektriühendused.  
 LED-kohtvalgusti on eemaldatud.

### 4.16.2 LED-kohtvalgusti paigaldamine

- ▶ Paigaldage vastupidises järjekorras.

## 4.17 Ülemise LED-tule vahetamine

### Eritööriistad:

- Lapik kruvikeeraja Tera 2,4 mm × 0,4 mm × 60 mm, komplektis [00341820]

**i** Teie seadmel on LED-tuli, mis ei vaja hooldust. Seda tuld tohib parandada ainult klienditeenindus või volitatud tehnik!

**!** **OHT**  
**Liikuvatest osadest tingitud elektrilöögi oht!**  
Kui remonditööd on valesti tehtud, esineb elektrilöögist tingitud eluoht.  
▶ Elektrilisi osadid peavad parandama kvalifitseeritud elektrikud.  
▶ Pärast remonti peab olema tehtud ohutuskatse vastavalt standardile VDE 0701 või riiklikele määrustele.

**!** **OHT**  
**Liikuvatest osadest tingitud elektrilöögi oht!**  
Elektrilöögist tingitud surm  
▶ Enne remonditöödega alustamist ühendage seadmed elektrivõrgust lahti vähemalt 60 sekundit varem.

**!** **ETTEVAATUST!**  
**Teravad servad!**  
Lõikehaavad  
▶ Kandke kaitsekindaid.

### Nõue:

- ✓ Seade on toitest lahutatud.
- ✓ Uks on lahti.
- ✓ Ülemine sisearmatuur on eemaldatud.

### 4.17.1 LED-tule eemaldamine

- Liigutage LED-tuld vasakule.



- LED-tule elektrihendus on lahutatud.

- Vabastage LED-tule haagid.



3. Eemaldage LED-tuli, liigutades seda ettepoole.

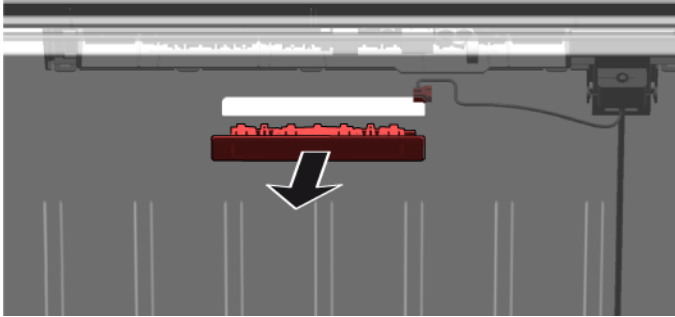

- ➔ LED-tuli on eemaldatud.

## 4.17.2 Ülemise LED-tule paigaldamine

- ▶ Paigaldage vastupidises järjekorras.

## 4.18 Külgmise LED-valgusriba vahetamine

### Eritööriistad:

Iminapp Ø50 mm [00342224]



Teie seadmel on LED-tuli, mis ei vaja hooldust.  
Seda tuld tohib parandada ainult klienditeenindus või volitatud tehnik!



#### **OHT**

##### **Liikuvatest osadest tingitud elektrilöögi oht!**

Kui remonditööd on valesti tehtud, esineb elektrilöögist tingitud eluohu.

- ▶ Elektrilisi osadid peavad parandama kvalifitseeritud elektrikud.
- ▶ Pärast remonti peab olema tehtud ohutuskatse vastavalt standardile VDE 0701 või riiklikele määrustele.



#### **OHT**

##### **Liikuvatest osadest tingitud elektrilöögi oht!**

Elektrilöögist tingitud surm

- ▶ Enne remonditöödega alustamist ühendage seadmed elektrivõrgust lahti vähemalt 60 sekundit varem.



#### **ETTEVAATUST!**

##### **Teravad servad!**

Lõikehaavad

- ▶ Kandke kaitsekindaid.

### Nõue:

- ✓ Seade on toitest lahutatud.
- ✓ Uks on lahti.
- ✓ Külmuosa riiulid on eemaldatud.

## 4.18.1 Külgmise LED-valgusriba eemaldamine

1. Kleepige iminapp külgmise LED-valgusriba ülemise kolmandiku külge.



2. Tõmmake iminapp koos külgmise LED-valgusribaga ühe keerava liigutusega ettepoole.

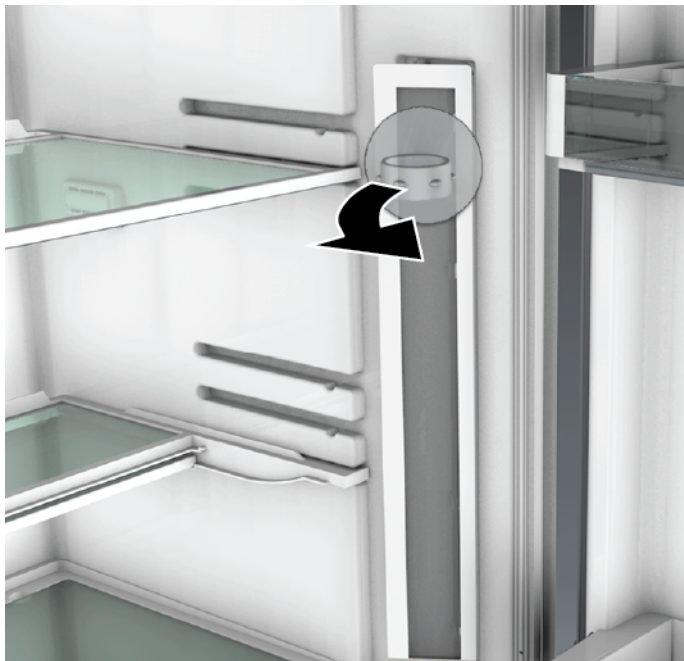



3. Lahutage külgmise LED-valgusriba elektriühendus.  
➡ Külgmise LED-valgusriba on eemaldatud.

### 4.18.2 Külgmise LED-valgusriba paigaldamine

1. Ühendage külgmise LED-valgusriba elektriühendus.
  2. Kinnitage külgmise LED-valgusriba selle kohale külmkapi seinal (haagid lähevad klõpsuga paika).
- ➡ Külgmise LED-valgusriba on paigaldatud.

# Korjausvinkit - Jääkaappi- ja pakastinyhdistelmä

 <b>Tämä asiakirja</b> .....	<b>192</b>
1.1 Tärkeitä tietoja.....	192
1.1.1 Tarkoitus .....	192
1.2 Symboleiden merkitys.....	192
1.2.1 Vaaratasot.....	192
1.2.2 Varoitusmerkit.....	192
1.2.3 Varoitusten rakenne .....	193
1.2.4 Yleiset symbolit.....	193
 <b>Turvallisuus</b> .....	<b>194</b>
2.1 Yleiset turvallisuusohjeet.....	194
2.1.1 Kaikki kotitalouskoneet.....	194
 <b>Työkalut ja apuvälineet</b> .....	<b>195</b>
 <b>Korjaus</b> .....	<b>196</b>
4.1 Oven tiivisteen vaihtaminen.....	196
4.2 Ovenkahvan vaihtaminen.....	197
4.2.1 Ovenkahvan poistaminen .....	197
4.2.2 Ovenkahvan asennus.....	197
4.3 Oven yläsaranan vaihtaminen .....	198
4.3.1 Oven yläsaranan poistaminen.....	198
4.3.2 Oven yläsaranan asennus .....	199
4.4 Oven yläsaranan vaihtaminen (näytöllä varustettu ovi).....	200
4.4.1 Oven yläsaranan poistaminen.....	200
4.4.2 Oven yläsaranan asennus .....	201
4.5 Oven keskisaranan vaihtaminen .....	202
4.5.1 Oven keskisaranan poistaminen .....	202
4.5.2 Oven keskisaranan asennus.....	202
4.6 Oven alasaranan vaihtaminen .....	203
4.6.1 Oven alasaranan poistaminen.....	203
4.6.2 Oven alasaranan asennus .....	203
4.7 Hyllyn vaihtaminen .....	204
4.7.1 Hyllyn poistaminen.....	204
4.7.2 Hyllyn asennus .....	204
4.8 Muuttuvan hyllyn vaihtaminen .....	205

4.8.1 Muuttuvan hyllyn poistaminen .....	205
4.8.2 Muuttuvan hyllyn asentaminen .....	205
4.9 Joustavan hyllyn vaihtaminen .....	206
4.9.1 Joustavan hyllyn poistaminen.....	206
4.9.2 Joustavan hyllyn asentaminen.....	206
4.10 Aamiaissetin vaihtaminen .....	207
4.10.1 Aamiaissetin poistaminen.....	207
4.10.2 Aamiaissetin asentaminen .....	207
4.11 Pullohyllyn vaihtaminen .....	208
4.11.1 Pullohyllyn poistaminen.....	208
4.11.2 Pullohyllyn asennus .....	208
4.12 Ovihyllyn vaihtaminen .....	209
4.12.1 Ovihyllyn poistaminen .....	209
4.12.2 Ovihyllyn asennus .....	209
4.13 Pakastelokeron vaihtaminen .....	210
4.13.1 Pakastelokeron poistaminen .....	210
4.13.2 Pakastelokeron asennus.....	210
4.14 Lokeron vaihtaminen .....	211
4.14.1 Lokeron poistaminen .....	211
4.14.2 Lokeron asennus.....	211
4.15 Ulosvedettävän lokeron vaihtaminen .....	212
4.15.1 Ulosvedettävän lokeron poistaminen.....	212
4.15.2 Ulosvedettävän lokeron asennus .....	212
4.16 LED-kohdevalon vaihtaminen .....	213
4.16.1 LED-kohdevalon poistaminen.....	213
4.16.2 LED-kohdevalon asennus .....	213
4.17 LED-ylävalon vaihtaminen .....	214
4.17.1 LED-valon poistaminen .....	214
4.17.2 LED-ylävalon asennus .....	215
4.18 LED-sivupalkkivalon vaihtaminen .....	216
4.18.1 LED-sivupalkkivalon poistaminen .....	216
4.18.2 LED-sivupalkkivalon asennus.....	217

# Tämä asiakirja

## 1.1 Tärkeitä tietoja

### 1.1.1 Tarkoitus

Näiden korjausohjeiden tarkoituksena on auttaa kuluttajaa korjaamaan laitteita itse ekologista suunnittelua koskevan asetuksen (päivitys 03/2021) mukaisesti.



Ne sisältävät tietoja siitä, miten määrätyt varaosat voidaan vaihtaa. Lisäksi niihin sisältyy tietoja varoituksista ja riskeistä.

Ota yhteyttä huoltopalveluun, jos sinulla on kysyttävää. Vastamme vahingoista vain, jos korjausohjeita on noudatettu oikein.

## 1.2 Symboleiden merkitys

### 1.2.1 Vaaratasot

Varoitustasot koostuvat symbolista ja huomiosanasta. Huomiosanat ilmoittava vaaran vakavuuden.

Varoitustaso	Merkitys
 <b>VAARA</b>	Varoituksen laiminlyönti johtaa kuolemaan tai vakaviin loukkaantumisiin.
 <b>VAROITUS</b>	Varoituksen laiminlyönti voi johtaa kuolemaan tai vakaviin loukkaantumisiin.
 <b>HUOMAA</b>	Varoituksen laiminlyönti voi johtaa lieviin loukkaantumisiin.
<b>HUOMIO!</b>	Varoituksen laiminlyönti voi johtaa omaisuusvahinkoihin.

Taulukko 1: Vaaratasot

### 1.2.2 Varoitusmerkit

Varoitusmerkit ovat symboleita sisältäviä esityksiä, jotka osoittavat vaaran tyyppin.

Tässä asiakirjassa käytetään seuraavia varoitusmerkkejä:

Varoitusmerkki	Merkitys
	Yleinen varoitus
	Sähköjännitteestä aiheutuva vaara
	Räjähdysvaara
	Viiltohaavojen vaara
	Murskautumisen vaara

# Tämä asiakirja

Varoitusmerkki	Merkitys
	Kuumista pinnoista aiheutuva vaara
	Voimakkaasta magneettikentästä aiheutuva vaara
	Ionisoimattomasta säteilystä aiheutuva vaara



Taulukko 2: Varoitusmerkit

## 1.2.3 Varoitusten rakenne

Tämän asiakirjan sisältämällä varoituksilla on standardoitu ulkonäkö ja rakenne.



	<div style="background-color: red; color: white; padding: 2px; text-align: center;"> <b>VAARA</b></div> <p><b>Vaaran tyyppi ja lähde!</b> Vaaran/varoituksen laiminlyönnistä mahdollisesti aiheutuvat seuraukset.</p> <ul style="list-style-type: none"><li>▶ Vaaran ehkäisemiseen liittyvät toimenpiteet ja kiellot.</li></ul>
--	--

Seuraavassa esimerkissä näytetään varoitus, joka varoittaa jännitteisten osien aiheuttamasta sähköiskusta. Vaaran välttämiseksi suoritettava toimenpide mainitaan.

	<div style="background-color: red; color: white; padding: 2px; text-align: center;"> <b>VAARA</b></div> <p><b>Jännitteisten osien aiheuttama sähköiskun vaara!</b> Sähköiskun aiheuttama kuolema</p> <ul style="list-style-type: none"><li>▶ Erotta laitteet sähkövirrasta vähintään 60 sekuntia ennen korjaustöiden aloittamista.</li></ul>
---	---

## 1.2.4 Yleiset symbolit

Tässä asiakirjassa käytetään seuraavia yleisiä symboleja:

Yl. symboli	Merkitys
	Erikoisohjeen tunniste (teksti ja/tai kaavio)
	Yksinkertaisen ohjeen tunniste (vain teksti)

Yl. symboli	Merkitys
	Video-opetusohjelmaan johtavan linkin tunniste
	Tarvittavien työkalujen tunniste
	Tarvittavien edellytysten tunniste
	Ehdon (jos ..., sitten ...) tunniste
	Tuloksen tunniste
	Näppäimen tai painikkeen tunniste
	Materiaalinumeron tunniste
	Näytetyn tekstin/ikkunan (laitteen näytössä) tunniste

Taulukko 3: Yleiset symbolit

## 2.1 Yleiset turvallisuusohjeet

### 2.1.1 Kaikki kotitalouskoneet

#### Jännitteisten osien aiheuttama sähköiskun vaara!

- Virheet sähkökomponentteja sisältävissä korjauksissa voivat johtaa sähköiskuun!
- Kytke kone irti verkkovirrasta vähintään 60 sekuntia ennen töiden aloittamista.
- Pyydä korjauksen jälkeen suorittamaan VDE 0701 -säädöksen tai maakohtaisten säädösten mukainen turvallisuustesti.

#### Terävistä reunoista aiheutuva loukkaantumisvaara!

- Käytä suojakäsineitä.

#### Painavista ja liikkuvista komponenteista aiheutuva murskautumisen riski korjauksen, kunnossapidon, vianetsinnän ja huollon aikana

- Käytä suojakenkiä.
- Estä painavien komponenttien putoaminen.
- Älä koske liikkuviin komponentteihin.

#### Laitteen turvallisuudelle/toiminnalle aiheutuva riski!

- Käytä vain alkuperäisiä varaosia.

#### Staattiselle sähkölle herkkien komponenttien (ESDS) vaurioitumisen riski!

- Älä koske moduuleihin, liitännät ja johdinreitit mukaan luettuna.

## Työkalut ja apuvälineet

Nimitys	Yksityiskohdat	Kuvat
Suojapeite [00342013]	60 cm x 50 cm	
Tarkkuusruuvimeisselisarja [00341820]	9 kappaletta, 2,0 mm, 2,4 mm, 3,0 mm, PH0, PH00, PH1, TX6, TX8, TX9	
Lisätyökalu [00342180]	Työkalu, jota käytetään muoviosien irrottamiseen "magic tool"	
Imukuppi [00342224]	Ø 50 mm	
Torx-kärki TX20 [00340865]	6,3 mm (1/4")	
Uraruuvimeisseli	Terä 10 mm x 1,6 mm x 200 mm	

## 4.1 Oven tiivisteiden vaihtaminen

### Vaatus:

- Ovi on auki.

## 4.2 Ovenkahvan vaihtaminen

### Erikoistyökalut:

- Torx-kärki TX20 6,3 mm (1/4") [00340865]
- Uruuvimeisseli Terä 10 mm x 1,6 mm x 200 mm

### Vaatus:

- ✓ Kone on erotettu tehollisesta.
- ✓ Ovi on auki.

### 4.2.1 Ovenkahvan poistaminen

- 1. Poista kaksi ruuvia suojusta (1).
- 2. Kierrä kaksi ruuvia auki (2).
- 3. Poista ovenkahva (3).

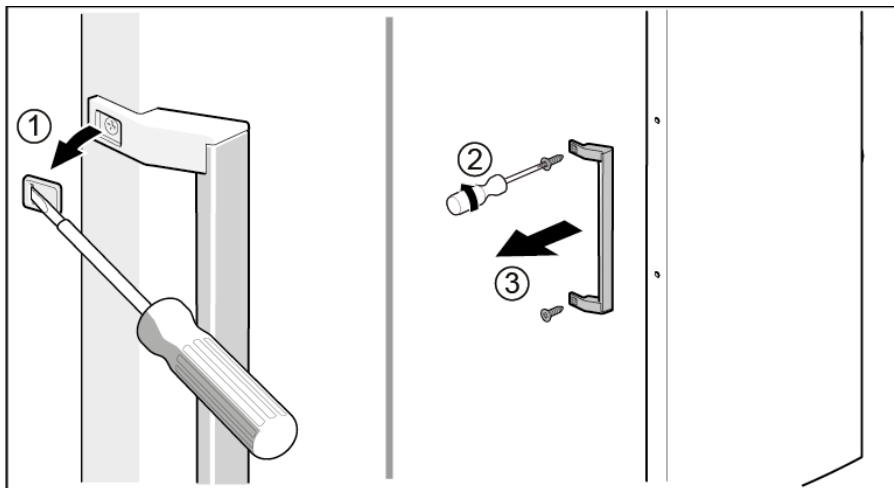

➡ Ovenkahva on poistettu.



Toisen oven ovenkahva voidaan poistaa samalla tavalla.

### 4.2.2 Ovenkahvan asennus

- Asenna vastakkaisessa järjestyksessä.





## 4.3 Oven yläsaranan vaihtaminen

### Erikoistyökalut:

Torx-kärki TX20

6,3 mm (1/4")

[00340865]

	<p><b>VAROITUS</b></p> <p><b>Painavat, isokokoiset laitteet!</b> Selän ja lihasten vammat</p> <ul style="list-style-type: none"><li>▶ Vain koulutettujen ammattilaisten tulisi suorittaa laitteen oven poistamiseen liittyvät vaiheet.</li><li>▶ Laitteen siirtämiseen tarvitaan kahta ihmistä.</li><li>▶ Käytä vain soveltuvia työkaluja ja välineitä.</li></ul>
	<p><b>HUOMAA</b></p> <p><b>Terävät reunat!</b> Viiltovammat</p> <ul style="list-style-type: none"><li>▶ Käytä suojakäsineitä.</li></ul>
	<p><b>VAROITUS</b></p> <p><b>Kallistetun koneen luiskahtaminen.!</b> Luunmurtumat/murskavammat</p> <ul style="list-style-type: none"><li>▶ Estä koneiden luiskahtaminen.</li></ul>
	<p><b>HUOMAA</b></p> <p><b>Ruuvien avaamisesta aiheutuva osien putoamisen riski!</b> Loukkaantuminen putoavien osien vuoksi.</p> <ul style="list-style-type: none"><li>▶ Estä komponentin putoaminen.</li></ul>
	<p><b>HUOMIO!</b></p> <p><b>Ruuvien avaamisesta aiheutuva osien putoamisen riski!</b> Vauriot koneen muille osille tai asiakkaan kodille, esim. lattia.</p> <ul style="list-style-type: none"><li>▶ Estä komponentin putoaminen.</li></ul>

### Vaatus:

- ✓ Kone on erotettu teholähteestä.
- ✓ Laitteen sisällä olevat lisävarusteet on poistettu.

## 4.3.1 Oven yläsaranan poistaminen

1. Aseta laite selälleen.

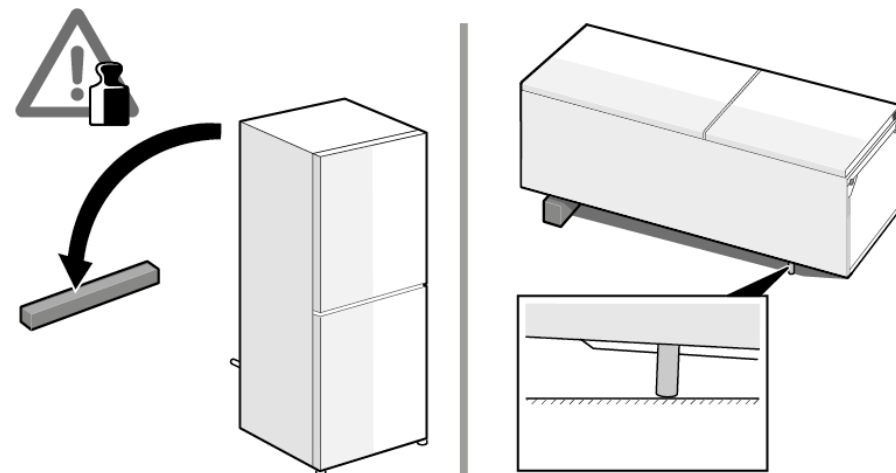

1. Paina yläsaranan suojusta kummallakin puolella (1).
2. Ota yläsaranan suojus ulos (2).
3. Pyöritä saranan suojusta (3).
4. Poista yläsaranan suojus (4).
5. Kierrä kaksi ruuvia auki (5).
6. Poista yläsarana (6).

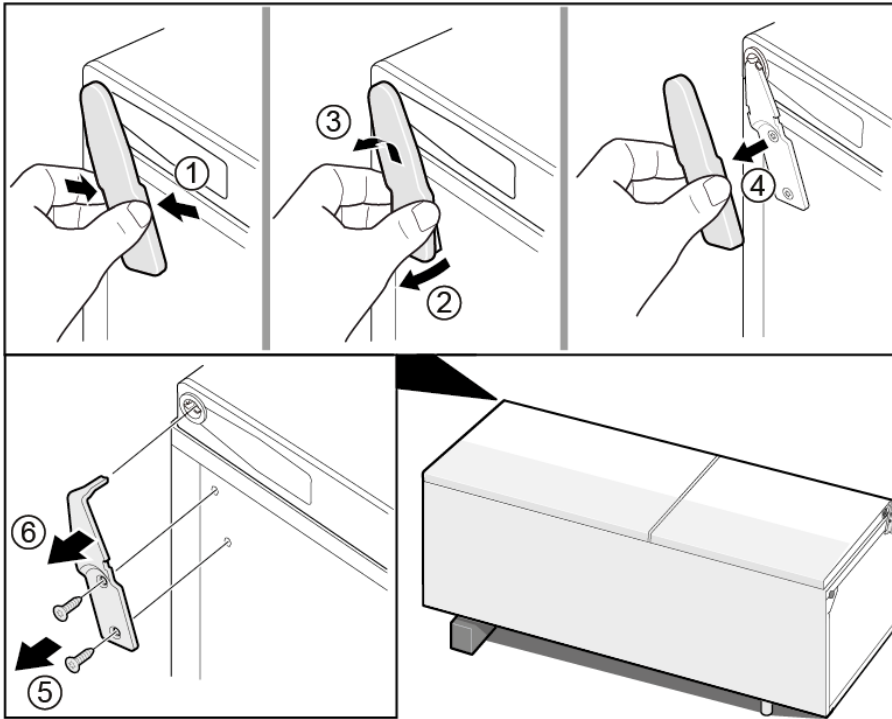

 Yläsarana on poistettu.

### 4.3.2 Oven yläsaranan asennus

- ▶ Asenna vastakkaisessa järjestyksessä.

## 4.4 Oven yläsaranan vaihtaminen (näytöllä varustettu ovi)

### Erikoistyökalut:

Torx-kärki TX20 6,3 mm (1/4") [00340865]

	<b>VAROITUS</b>
<b>Painavat, isokokoiset laitteet!</b>	
Selän ja lihasten vammat	
<ul style="list-style-type: none"> <li>▶ Vain koulutettujen ammattilaisten tulisi suorittaa laitteen oven poistamiseen liittyvät vaiheet.</li> <li>▶ Laitteen siirtämiseen tarvitaan kahta ihmistä.</li> <li>▶ Käytä vain soveltuvia työkaluja ja välineitä.</li> </ul>	

	<b>HUOMAA</b>
<b>Terävät reunat!</b>	
Viiltovammat	
<ul style="list-style-type: none"> <li>▶ Käytä suojakäsineitä.</li> </ul>	

	<b>VAROITUS</b>
<b>Kallistetun koneen luiskahtaminen.!</b>	
Luunmurtumat/murskavammat	
<ul style="list-style-type: none"> <li>▶ Estä koneiden luiskahtaminen.</li> </ul>	

	<b>HUOMAA</b>
<b>Ruuvien avaamisesta aiheutuva osien putoamisen riski!</b>	
Loukkaantuminen putoavien osien vuoksi.	
<ul style="list-style-type: none"> <li>▶ Estä komponentin putoaminen.</li> </ul>	

	<b>HUOMIO!</b>
<b>Ruuvien avaamisesta aiheutuva osien putoamisen riski!</b>	
Vauriot koneen muille osille tai asiakkaan kodille, esim. lattia.	
<ul style="list-style-type: none"> <li>▶ Estä komponentin putoaminen.</li> </ul>	

	<b>VAARA</b>
<b>Jännitteisten osien aiheuttama sähköiskun vaara!</b>	
Sähköiskusta aiheutuva hengenvaara väärän korjauksen tapauksessa	
<ul style="list-style-type: none"> <li>▶ Sähköosien korjaus tulisi antaa pätevien sähköasentajien suoritettavaksi.</li> <li>▶ Pyydä korjauksen jälkeen suorittamaan VDE 0701 -säädöksen tai maakohtaisten säädösten mukainen turvallisuustesti.</li> </ul>	

	<b>VAARA</b>
<b>Jännitteisten osien aiheuttama sähköiskun vaara!</b>	
Sähköiskun aiheuttama kuolema	
<ul style="list-style-type: none"> <li>▶ Erotä laitteet sähkövirrasta vähintään 60 sekuntia ennen korjaustöiden aloittamista.</li> </ul>	

### Vaatus:

- ✓ Kone on erotettu teholahteesta.
- ✓ Laitteen sisällä olevat lisävarusteet on poistettu.

### 4.4.1 Oven yläsaranan poistaminen

1. Aseta laite selälleen.

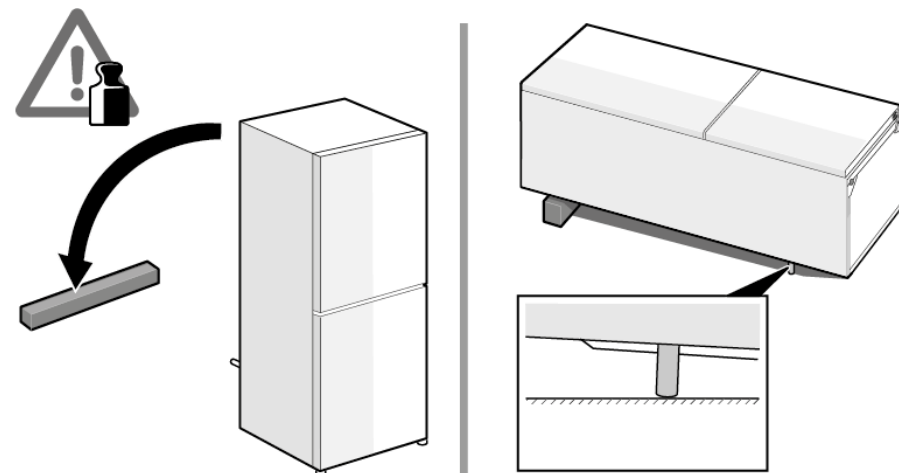

2. 1. Poista yläsaranan suojuus (1).
2. Poista kaapelirasian suojuus (2).
3. Irrota sähköliitäntä (3).
4. Kierrä maadoitusliitännän ruuvi auki (4).
5. Poista kaapelisuojaus (5).
6. Kierrä ruuvi auki (6).

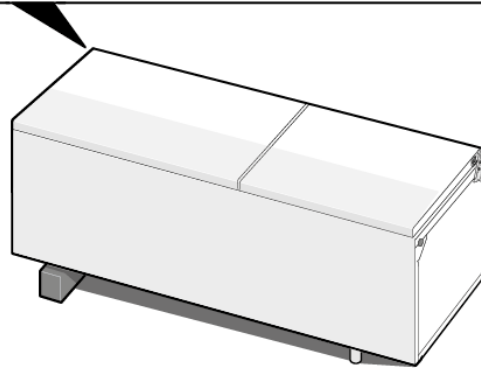
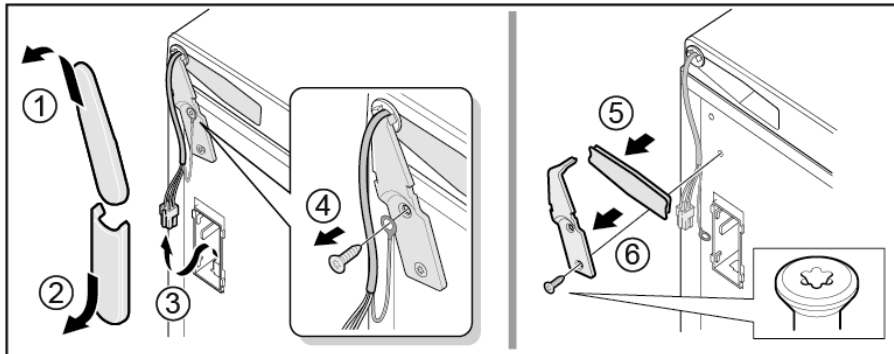

 Yläsarana on poistettu.

#### 4.4.2 Oven yläsaranan asennus

- ▶ Asenna vastakkaisessa järjestyksessä.

## 4.5 Oven keskisaranan vaihtaminen

### Erikoistyökalut:

Torx-kärki TX20

6,3 mm (1/4")

[00340865]

	<b>VAROITUS</b>
<b>Painavat, isokokoiset laitteet!</b>	
Selän ja lihasten vammat	
<ul style="list-style-type: none"> <li>▶ Vain koulutettujen ammattilaisten tulisi suorittaa laitteen oven poistamiseen liittyvät vaiheet.</li> <li>▶ Laitteen siirtämiseen tarvitaan kahta ihmistä.</li> <li>▶ Käytä vain soveltuvia työkaluja ja välineitä.</li> </ul>	

	<b>HUOMAA</b>
<b>Terävät reunat!</b>	
Viiltovammat	
<ul style="list-style-type: none"> <li>▶ Käytä suojakäsineitä.</li> </ul>	

	<b>VAROITUS</b>
<b>Kallistetun koneen luiskahtaminen.!</b>	
Luunmurtumat/murskavammat	
<ul style="list-style-type: none"> <li>▶ Estä koneiden luiskahtaminen.</li> </ul>	

	<b>HUOMAA</b>
<b>Ruuvien avaamisesta aiheutuva osien putoamisen riski!</b>	
Loukkaantuminen putoavien osien vuoksi.	
<ul style="list-style-type: none"> <li>▶ Estä komponentin putoaminen.</li> </ul>	

	<b>HUOMIO!</b>
<b>Ruuvien avaamisesta aiheutuva osien putoamisen riski!</b>	
Vauriot koneen muille osille tai asiakkaan kodille, esim. lattia.	
<ul style="list-style-type: none"> <li>▶ Estä komponentin putoaminen.</li> </ul>	

### Vaatus:

- ✔ Kone on erotettu tehollähteestä.
- ✔ Laitteen sisällä olevat lisävarusteet on poistettu.
- ✔ Oven yläsarana on poistettu.
- ✔ Yläovi on poistettu.

### 4.5.1 Oven keskisaranan poistaminen

- ▶ 1. Pois jääkaappiosan ovi (1).
- ▶ 2. Kierrä kaksi ruuvia auki (2).
- ▶ 3. Poista keskisarana (3).

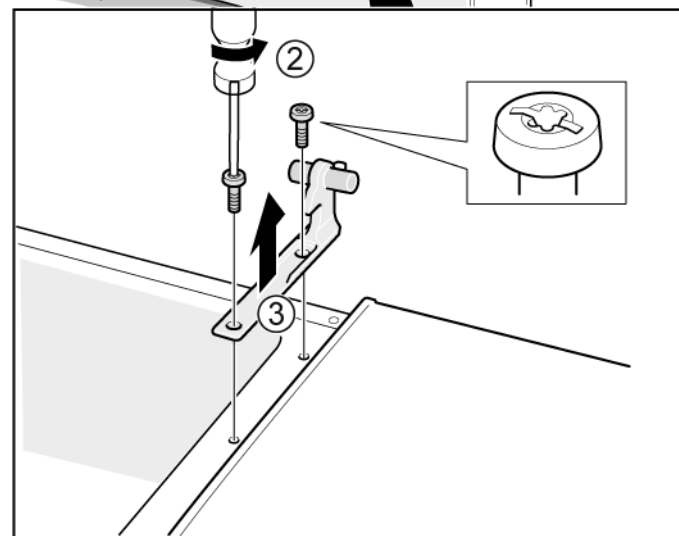
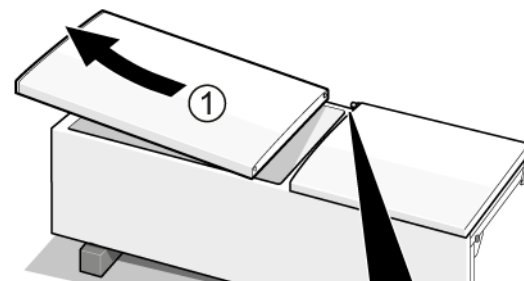

➡ Keskisarana on poistettu.

### 4.5.2 Oven keskisaranan asennus

- ▶ Asenna vastakkaisessa järjestyksessä.





## 4.6 Oven alasaranan vaihtaminen

### Erikoistyökalut:

Torx-kärki TX20

6,3 mm (1/4")

[00340865]

	<p><b>VAROITUS</b></p> <p><b>Painavat, isokokoiset laitteet!</b> Selän ja lihasten vammat</p> <ul style="list-style-type: none"> <li>▶ Vain koulutettujen ammattilaisten tulisi suorittaa laitteen oven poistamiseen liittyvät vaiheet.</li> <li>▶ Laitteen siirtämiseen tarvitaan kahta ihmistä.</li> <li>▶ Käytä vain soveltuvia työkaluja ja välineitä.</li> </ul>
	<p><b>HUOMAA</b></p> <p><b>Terävät reunat!</b> Viiltovammat</p> <ul style="list-style-type: none"> <li>▶ Käytä suojakäsineitä.</li> </ul>
	<p><b>VAROITUS</b></p> <p><b>Kallistetun koneen luiskahtaminen!</b> Luunmurtumat/murskavammat</p> <ul style="list-style-type: none"> <li>▶ Estä koneiden luiskahtaminen.</li> </ul>
	<p><b>HUOMAA</b></p> <p><b>Ruuvien avaamisesta aiheutuva osien putoamisen riski!</b> Loukkaantuminen putoavien osien vuoksi.</p> <ul style="list-style-type: none"> <li>▶ Estä komponentin putoaminen.</li> </ul>
	<p><b>HUOMIO!</b></p> <p><b>Ruuvien avaamisesta aiheutuva osien putoamisen riski!</b> Vauriot koneen muille osille tai asiakkaan kodille, esim. lattia.</p> <ul style="list-style-type: none"> <li>▶ Estä komponentin putoaminen.</li> </ul>

### Vaatus:

- ✓ Kone on erotettu teholähteestä.
- ✓ Laitteen sisällä olevat lisävarusteet on poistettu.
- ✓ Yläsarana on poistettu.
- ✓ Keskisarana on poistettu.

### 4.6.1 Oven alasaranan poistaminen

- ▶ 1. Poista pakastinosan ovi (1).
- ▶ 2. Kierrä ruuvi auki (2).
- ▶ 3. Kierrä alasarana ulos (3).
- ▶ 4. Poista alasarana (4).

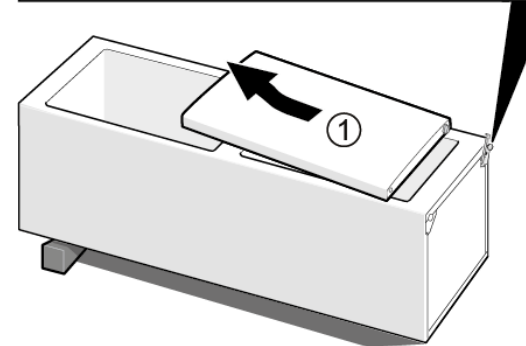
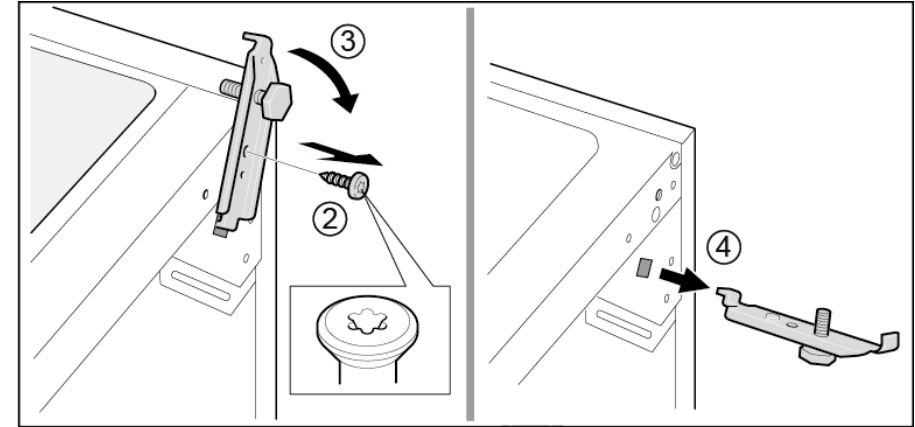

- ➡ Oven alasarana on poistettu.

### 4.6.2 Oven alasaranan asennus

- ▶ Asenna vastakkaisessa järjestyksessä.

## 4.7 Hyllyn vaihtaminen

### Vaatus:

- ✔ Ovi on auki.

### 4.7.1 Hyllyn poistaminen

- ▶ Vedä hylly ulos.

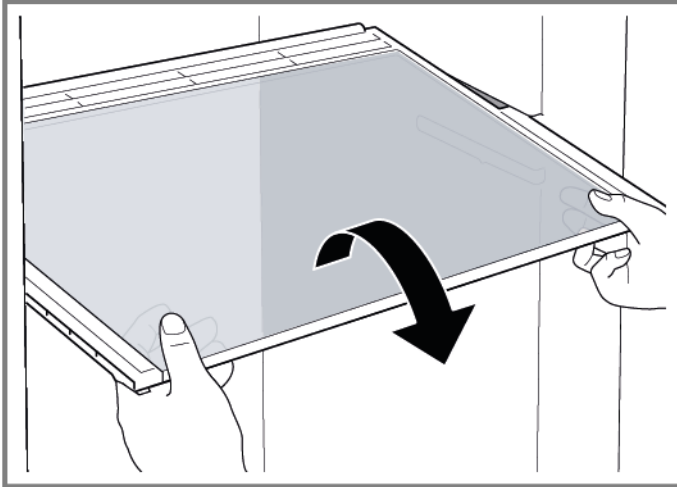

- ➡ Hylly on poistettu.

### 4.7.2 Hyllyn asennus

- ▶ Asenna vastakkaisessa järjestyksessä.

## 4.8 Muuttuvan hyllyn vaihtaminen

### Vaatus:

- ✓ Ovi on auki.

### 4.8.1 Muuttuvan hyllyn poistaminen

1. Siirrä muuttuvan hyllyn oikeanpuoleista osaa eteenpäin (1).
2. Poista muuttuvan hyllyn oikeanpuoleinen osa (2).

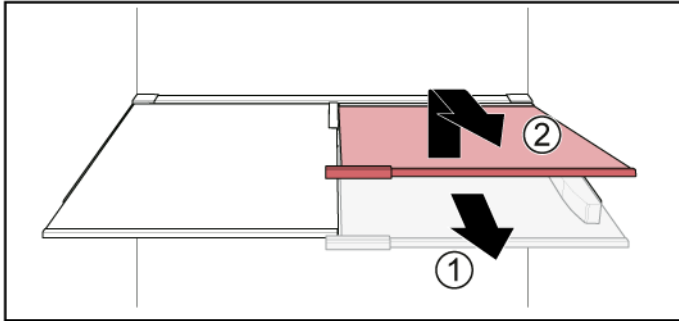

2. Poista muuttuvan hyllyn vasemmanpuoleinen osa samalla tavoin.

➡ Muuttuva hylly on poistettu.

### 4.8.2 Muuttuvan hyllyn asentaminen

- ▶ Asenna vastakkaisessa järjestyksessä.

## 4.9 Joustavan hyllyn vaihtaminen

### Vaatus:

- ✔ Ovi on auki.

### 4.9.1 Joustavan hyllyn poistaminen

- ▶ 1. Poista lasihylly (1).
- ▶ 2. Nosta joustavaa hyllyä ja vedä se ulos (2).

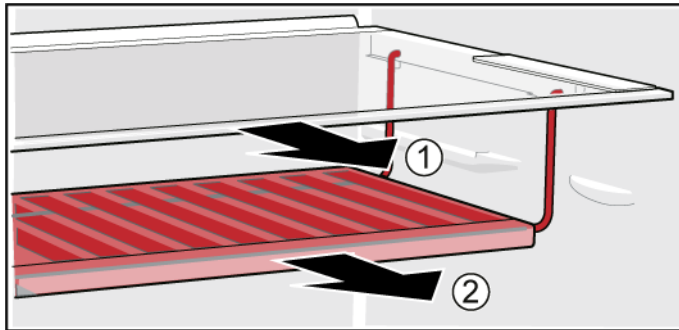

- ➡ Joustava hylly on poistettu.

### 4.9.2 Joustavan hyllyn asentaminen

- ▶ Asenna vastakkaisessa järjestyksessä.

## 4.10 Aamiaissetin vaihtaminen

### Vaatus:

- ✔ Ovi on auki.

### 4.10.1 Aamiaissetin poistaminen

- ▶ Nosta aamiaissetti ja vedä se ulos.

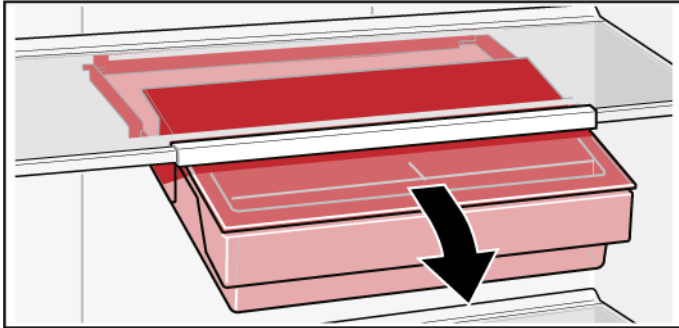

- ➡ Aamiaissetti on poistettu.

### 4.10.2 Aamiaissetin asentaminen

- ▶ Asenna vastakkaisessa järjestyksessä.

## 4.11 Pullohyllyn vaihtaminen

### Vaatus:

- ✔ Ovi on auki.

### 4.11.1 Pullohyllyn poistaminen

- ▶ Vedä pullohylly ulos.

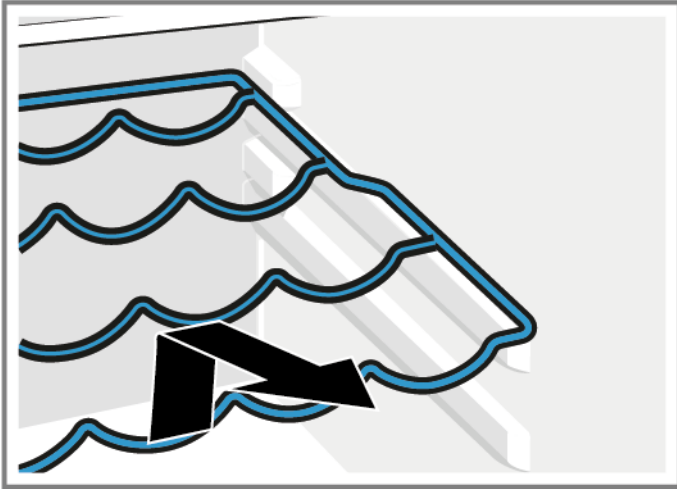

- ➡ Pullohylly on poistettu.

### 4.11.2 Pullohyllyn asennus

- ▶ Asenna vastakkaisessa järjestyksessä.

## 4.12 Ovihyllyn vaihtaminen

### Vaatus:

- ✔ Ovi on auki.

### 4.12.1 Ovihyllyn poistaminen

- ▶ Nosta ovihylly pois yläsuuntaan.

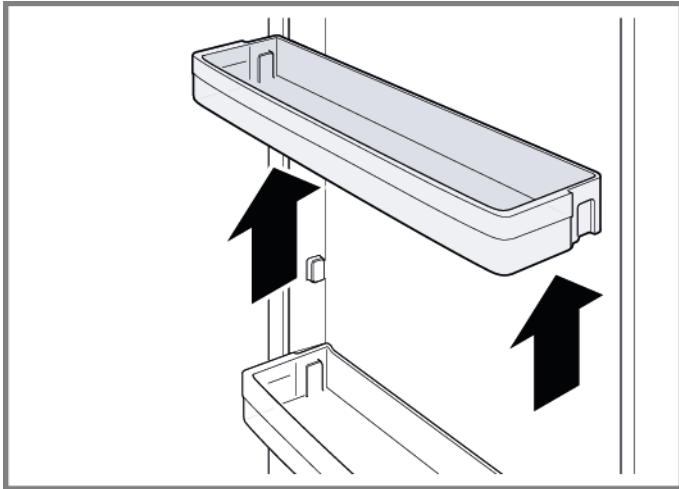

- ➡ Ovihylly on poistettu.

### 4.12.2 Ovihyllyn asennus

- ▶ Asenna vastakkaisessa järjestyksessä.

## 4.13 Pakastelokeron vaihtaminen

### Vaatus:

- ✔ Ovi on auki.

### 4.13.1 Pakastelokeron poistaminen

- ▶ 1. Vedä pakastelokero kokonaan ulos (1).
- ▶ 2. Poista lokero (2).

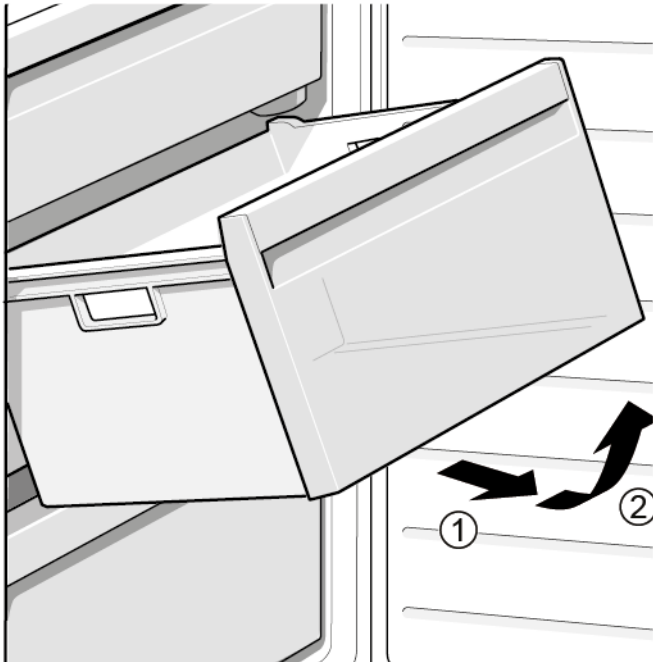

- ➡ Pakastelokero on poistettu.

### 4.13.2 Pakastelokeron asennus

- ▶ Asenna vastakkaisessa järjestyksessä.

## 4.14 Lokeron vaihtaminen

### Vaatus:

- ✔ Ovi on auki.

### 4.14.1 Lokeron poistaminen

- ▶ 1. Ota alempi jääkaapin lokeri ulos (1).
- ▶ 2. Ota ylempi jääkaapin lokeri ulos (2).

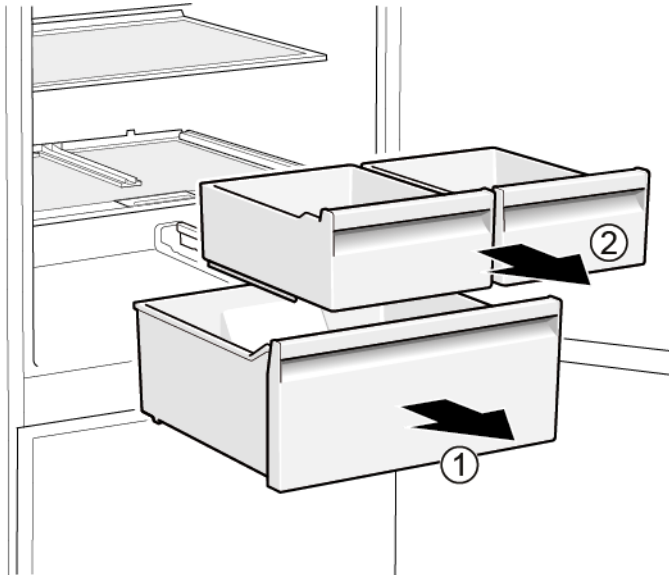

- ➡ Lokerot on poistettu.

### 4.14.2 Lokeron asennus

- ▶ Asenna vastakkaisessa järjestyksessä.

## 4.15 Ulosvedettävän lokeron vaihtaminen

### Vaatus:

- ✔ Ovi on auki.

### 4.15.1 Ulosvedettävän lokeron poistaminen

- ▶ 1. Vedä ulosvedettävä lokero kokonaan ulos (1).
- ▶ 2. Poista ulosvedettävä lokero (2).

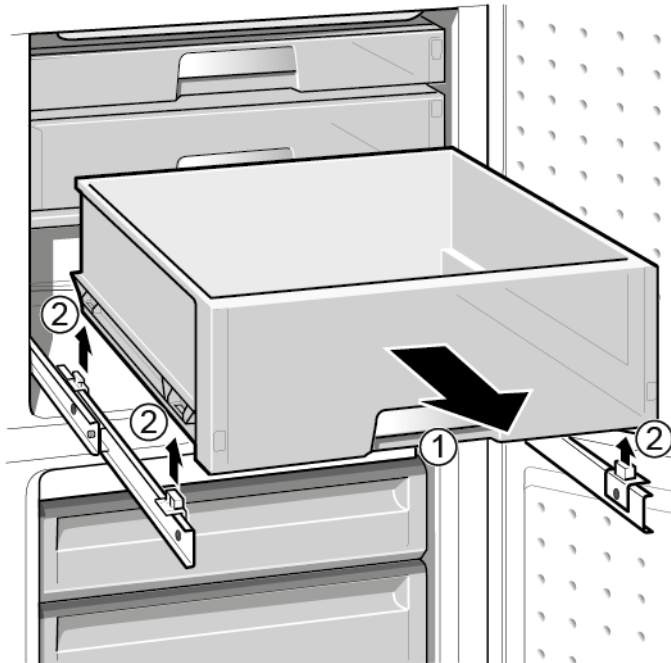

- ➡ Ulosvedettävä lokero on poistettu.

### 4.15.2 Ulosvedettävän lokeron asennus

- ▶ Asenna vastakkaisessa järjestyksessä.

## 4.16 LED-kohdevalon vaihtaminen

### Erikoistyökalut:

Erikoistyökalu [00342180]

**i** Laite on varustettu huoltovapaalla LED-valolla.  
Vain huoltopalvelu tai valtuutetut teknikot saavat korjata nämä valot!

**VAARA**  
**Jännitteisten osien aiheuttama sähköiskun vaara!**  
Sähköiskusta aiheutuva hengenvaara väärän korjauksen tapauksessa

- ▶ Sähköosien korjaus tulisi antaa pätevien sähköasentajien suoritettavaksi.
- ▶ Pyydä korjauksen jälkeen suorittamaan VDE 0701 -säädöksen tai maakohtaisten säädösten mukainen turvallisuustesti.

**VAARA**  
**Jännitteisten osien aiheuttama sähköiskun vaara!**  
Sähköiskun aiheuttama kuolema

- ▶ Erotta laitteet sähkövirrasta vähintään 60 sekuntia ennen korjaustöiden aloittamista.

**HUOMAA**  
**Terävät reunat!**  
Viiltovammat

- ▶ Käytä suojakäsineitä.

### Vaatus:

- ✔ Kone on erotettu teholahteesta.
- ✔ Ovi on auki.

### 4.16.1 LED-kohdevalon poistaminen

1. Vedä LED-kohdevalo ulos erikoistyökalua käyttämällä (1).

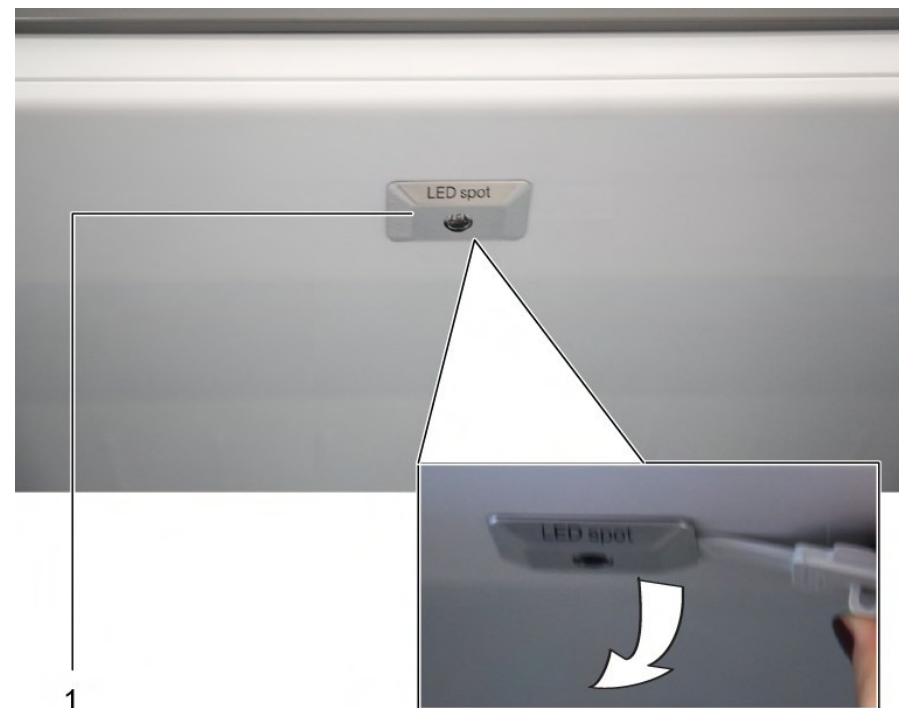

2. Irrota LED-kohdevalon sähköliitännät.

➔ LED-kohdevalo on poistettu.

### 4.16.2 LED-kohdevalon asennus

- ▶ Asenna vastakkaisessa järjestyksessä.

## 4.17 LED-ylävalon vaihtaminen

### Erikoistyökalut:

-  Uraruuvimeisseli
- Terä 2,4 mm x 0,4 mm x 60 mm, pakkauksessa [00341820]

 Laite on varustettu huoltovapaalla LED-valolla.  
Vain huoltopalvelu tai valtuutetut teknikot saavat korjata nämä valot!

 **VAARA**  
**Jännitteisten osien aiheuttama sähköiskun vaara!**  
Sähköiskusta aiheutuva hengenvaara väärän korjauksen tapauksessa

- ▶ Sähköosien korjaus tulisi antaa pätevien sähköasentajien suoritettavaksi.
- ▶ Pyydä korjauksen jälkeen suorittamaan VDE 0701 -säädöksen tai maakontaisten säädösten mukainen turvallisuustesti.



 **VAARA**  
**Jännitteisten osien aiheuttama sähköiskun vaara!**  
Sähköiskun aiheuttama kuolema

- ▶ Erotta laitteet sähkövirrasta vähintään 60 sekuntia ennen korjaustöiden aloittamista.

 **HUOMAA**  
**Terävät reunat!**  
Viiltovammat

- ▶ Käytä suojakäsineitä.

### Vaatus:

-  Kone on erotettu tehollähteestä.
-  Ovi on auki.
-  Sisällä olevat ylemmät lisävarusteet on poistettu.

### 4.17.1 LED-valon poistaminen

1. Siirrä LED-valo vasemmalle sivulle.



-  LED-valon sähköliitäntä on erotettu.

2. Avaa LED-valon lukitukset.

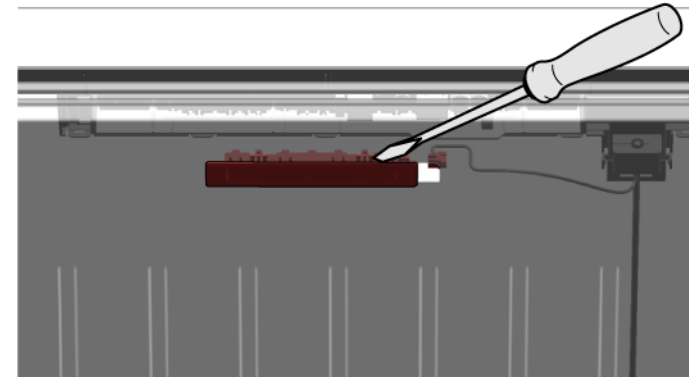

3. Poista LED-valo siirtämällä sitä etusuuntaan.

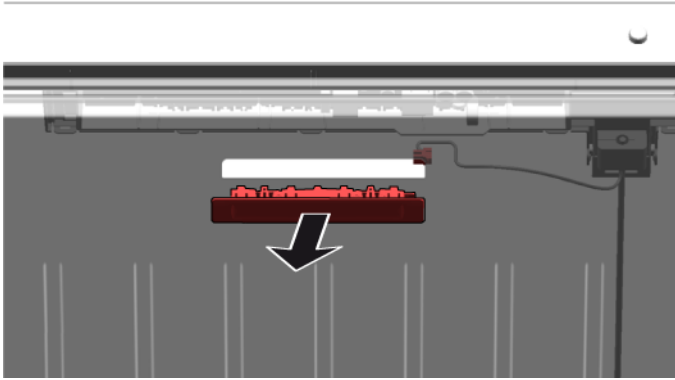

- ➔ LED-valo on poistettu.

## 4.17.2 LED-ylävalon asennus

- ▶ Asenna vastakkaisessa järjestyksessä.

## 4.18 LED-sivupalkkivalon vaihtaminen

### Erikoistyökalut:

Imukuppi Ø50 mm [00342224]

 Laite on varustettu huoltovapaalla LED-valolla.  
Vain huoltopalvelu tai valtuutetut teknikot saavat korjata nämä valot!

 **VAARA**  
**Jännitteisten osien aiheuttama sähköiskun vaara!**  
Sähköiskusta aiheutuva hengenvaara väärän korjauksen tapauksessa

- ▶ Sähköosien korjaus tulisi antaa pätevien sähköasentajien suorittavaksi.
- ▶ Pyydä korjauksen jälkeen suorittamaan VDE 0701 -säädöksen tai maakohtaisten säädösten mukainen turvallisuustesti.

 **VAARA**  
**Jännitteisten osien aiheuttama sähköiskun vaara!**  
Sähköiskun aiheuttama kuolema

- ▶ Erotta laitteet sähkövirrasta vähintään 60 sekuntia ennen korjaustöiden aloittamista.

 **HUOMAA**  
**Terävät reunat!**  
Viiltovammat

- ▶ Käytä suojakäsineitä.

### Vaatus:

- ✔ Kone on erotettu teholahteesta.
- ✔ Ovi on auki.
- ✔ Jääkaappiosan hyllyt on poistettu.

## 4.18.1 LED-sivupalkkivalon poistaminen

1. Kiinnitä imukuppi LED-sivupalkkivalon ylemmän kolmanneksen kohdalle.



2. Vedä imukuppi yhdessä LED-sivupalkkivalon kanssa yhdellä pyörivällä liikkeellä.

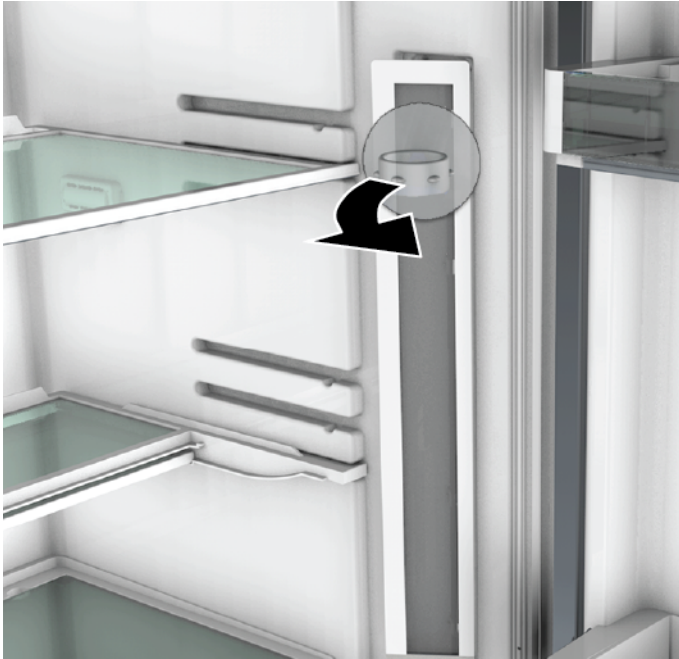





3. Irrota LED-sivupalkkivalon sähköliitäntä.  
➡ LED-sivupalkkivalo on poistettu.

### 4.18.2 LED-sivupalkkivalon asennus

1. Kytke LED-sivupalkkivalon sähköliitäntä.
  2. Kiinnitä LED-sivupalkkivalo paikoilleen jääkaappiosan seinään (lukitukset napsahtavat).
- ➡ LED-sivupalkkivalo on asennettu.

# Conseils de réparation - Combiné réfrigérateur-congélateur

 <b>A propos de ce document.....</b>	<b>219</b>
1.1 Informations importantes.....	219
1.1.1 Objectif.....	219
1.2 Explication des symboles.....	219
1.2.1 Niveaux de risque.....	219
1.2.2 Symboles de danger.....	219
1.2.3 Structure des indications d'avertissement.....	220
1.2.4 Symboles généraux.....	220
 <b>Sécurité.....</b>	<b>221</b>
2.1 Consignes de sécurité générales.....	221
2.1.1 Tous les appareils électroménagers.....	221
 <b>Outils et aides.....</b>	<b>222</b>
 <b>Réparation.....</b>	<b>223</b>
4.1 Remplacer le joint de porte.....	223
4.2 Remplacer la poignée de porte.....	224
4.2.1 Retirer la poignée de porte.....	224
4.2.2 Monter la poignée de porte.....	224
4.3 Remplacer la charnière supérieure de la porte.....	225
4.3.1 Retirer la charnière supérieure de la porte.....	225
4.3.2 Monter la charnière supérieure de la porte.....	226
4.4 Remplacer la charnière supérieure de la porte (porte avec afficheur).....	227
4.4.1 Retirer la charnière supérieure de la porte.....	227
4.4.2 Monter la charnière supérieure de la porte.....	228
4.5 Remplacer la charnière intermédiaire de la porte.....	229
4.5.1 Retirer la charnière intermédiaire de la porte.....	229
4.5.2 Monter la charnière intermédiaire de la porte.....	229
4.6 Remplacer la charnière de porte inférieure.....	230
4.6.1 Retirer la charnière intermédiaire de la porte.....	230
4.6.2 Monter la charnière de porte inférieure.....	230
4.7 Remplacer la tablette.....	231
4.7.1 Retirer la tablette.....	231
4.7.2 Monter la tablette.....	231
4.8 Remplacer la tablette variable.....	232
4.8.1 Retirer la tablette variable.....	232
4.8.2 Monter la tablette variable.....	232
4.9 Remplacer la tablette flexible.....	233
4.9.1 Retirer la tablette flexible.....	233
4.9.2 Monter la tablette flexible.....	233
4.10 Remplacer le set petit-déjeuner.....	234
4.10.1 Retirer le set petit-déjeuner.....	234
4.10.2 Monter le set petit-déjeuner.....	234
4.11 Remplacer le casier à bouteilles.....	235
4.11.1 Retirer le casier à bouteilles.....	235
4.11.2 Monter le casier à bouteilles.....	235
4.12 Remplacer l'étagère de la porte.....	236
4.12.1 Retirer l'étagère de la porte.....	236
4.12.2 Monter l'étagère de la porte.....	236
4.13 Remplacer le bac d'aliments congelés.....	237
4.13.1 Retirer le bac d'aliments congelés.....	237
4.13.2 Monter le bac d'aliments congelés.....	237
4.14 Remplacer le bac.....	238
4.14.1 Retirer le bac.....	238
4.14.2 Monter le bac.....	238
4.15 Remplacer le bac télescopique.....	239
4.15.1 Extraire le bac télescopique.....	239
4.15.2 Monter le bac télescopique.....	239
4.16 Changer le projecteur LED.....	240
4.16.1 Démontage du projecteur LED.....	240
4.16.2 Monter le projecteur LED.....	240
4.17 Remplacer l'éclairage LED supérieur.....	241
4.17.1 Retirer l'éclairage LED.....	241
4.17.2 Monter l'éclairage LED supérieur.....	242
4.18 Echange de l'éclairage LED latéral.....	243
4.18.1 Démontage de l'éclairage LED latéral.....	243
4.18.2 Montage de l'éclairage LED latéral.....	244

# **i** A propos de ce document

## 1.1 Informations importantes

### 1.1.1 Objectif

Les conseils de réparation qui suivent aident le consommateur à réparer l'appareil par lui-même, conformément au règlement sur l'écoconception (en vigueur en 03/2021).

Ils contiennent des informations sur l'échange de certaines pièces détachées, ainsi que des avertissements et risques.

Pour toute question, veuillez contacter notre service après-vente. Nous ne serons responsables des dommages que si les indications de réparation ont été suivies correctement.

## 1.2 Explication des symboles

### 1.2.1 Niveaux de risque

Les niveaux de risque se composent d'un symbole et d'un terme d'avertissement. Le mot d'avertissement caractérise la gravité du danger.









Niveau de dangerosité	Signification
 <b>DANGER</b>	Le non respect de la consigne d'avertissement provoque la mort ou des blessures graves.
 <b>AVERTISSEMENT</b>	Le non respect de la consigne d'avertissement peut provoquer la mort ou des blessures graves.
 <b>PRUDENCE</b>	Le non respect de la consigne d'avertissement peut provoquer des blessures légères.
 <b>ATTENTION !</b>	Le non respect de la consigne d'avertissement peut provoquer des dégâts matériels.

Tableau 1: Niveaux de risque

### 1.2.2 Symboles de danger

Les symboles de danger sont des représentations figuratives renseignant sur la nature du danger.

Ce document utilise les symboles de danger suivants:

Symbole de danger	Signification
	Consigne d'avertissement générale
	Danger engendré par la tension électrique
	Risque d'explosion
	Risque de blessures par coupure

## **i** A propos de ce document





Symbole de danger	Signification
	Risque de blessures par écrasement
	Danger engendré par des surfaces très chaudes
	Danger engendré par un champ magnétique puissant
	Danger engendré par un rayonnement non ionisant

Tableau 2: Symboles de danger

### 1.2.3 Structure des indications d'avertissement

Les consignes d'avertissement figurant dans ce document ont un aspect uniforme et une structure uniforme.

	<div style="background-color: red; color: white; padding: 2px; text-align: center;"><b>⚠ DANGER</b></div> <p><b>Type et source du danger !</b> Conséquences possibles en cas de non-respect du danger / de l'avertissement.</p> <ul style="list-style-type: none"> <li>▶ Mesures et interdictions pour éviter le danger.</li> </ul>
--	---

L'exemple suivant montre une consigne d'avertissement mettant en garde contre le risque d'électrocution. La mesure permettant d'éviter le danger est nommée.

	<div style="background-color: red; color: white; padding: 2px; text-align: center;"><b>⚠ DANGER</b></div> <p><b>Risque d'électrocution par des pièces conductrices de tension !</b> Mort par électrocution.</p> <ul style="list-style-type: none"> <li>▶ Débrancher l'appareil du secteur minimum 60 secondes avant de démarrer la réparation.</li> </ul>
--	---

### 1.2.4 Symboles généraux

Ce document utilise les symboles généraux suivants:







Symbole général	Signification
	Caractérisation d'une astuce particulière (texte et/ou graphique)
	Caractérisation d'une astuce simple (texte seul)
	Caractérisation d'un lien vers une vidéo
	Caractérisation d'outils nécessaires
	Caractérisation de conditions nécessaires
	Caractérisation d'une condition (si... , alors ...)
	Caractérisation d'un résultat
Start	Caractérisation d'une touche ou surface de commande
[00123456]	Caractérisation d'une référence de pièce
Statut	Caractérisation d'un texte affiché / fenêtre (sur l'afficheur)

Tableau 3: Symboles généraux

## 2.1 Consignes de sécurité générales

### 2.1.1 Tous les appareils électroménagers

#### **Risque d'électrocution en raison de pièces sous tension!**

- Des erreurs lors de réparations impliquant des composants électriques peuvent entraîner une décharge électrique!
- Débrancher l'appareil du secteur minimum 60 secondes avant de démarrer la réparation.
- Après la réparation, effectuer un test de sécurité selon VDE 0701 ou les réglementations spécifiques nationales.

#### **Risque de blessures par coupure sur des bords tranchants!**

- Porter des gants de protection.

#### **Risque de casse durant la réparation, maintenance, dépannage et SAV en raison de composants lourds et mobiles**

- Porter des chaussures de protection.
- Sécuriser les composants lourds contre le risque de chute.
- Ne pas coller les pièces du châssis sur les composants mobiles.

#### **Risque lié à la sécurité / fonction de l'appareil!**

- Utiliser uniquement des pièces détachées d'origine.

#### **Risque d'endommagement des composants sensibles aux décharges électrostatiques!**

- Ne pas toucher les modules, ni leur connexions et pistes conductrices.

## Outils et aides

Désignation	Détails	Images
Tissu de protection [00342013]	60 cm x 50 cm	
Kit de tournevis de précision [00341820]	9 pièces, 2.0 mm, 2.4 mm, 3.0 mm, PH0, PH00, PH1, TX6, TX8, TX9	
Outil auxiliaire [00342180]	Pour le démontage de pièces plastique, "outil magique"	
Ventouse [00342224]	Ø 50 mm	
Embout Torx TX20 [00340865]	6,3 mm (1/4")	
Tournevis plat	Lame 10 mm x 1,6 mm x 200 mm	



## 4.1 Remplacer le joint de porte

### Pré-requis:



- La porte est ouverte.

## 4.2 Remplacer la poignée de porte

### Outillage suggéré:

-  Embout Torx TX20                      6,3 mm (1/4")                      [00340865]
-  Tournevis plat                      Lame 10 mm x 1,6 mm x 200 mm

### Pré-requis:

-  Appareil est déconnecté de l'alimentation.
-  La porte est ouverte.

### 4.2.1 Retirer la poignée de porte

- ▶ 1. Retirer deux capuchons de vis (1).
- ▶ 2. Dévisser deux vis (2).
- ▶ 3. Retirer la poignée de porte (3).

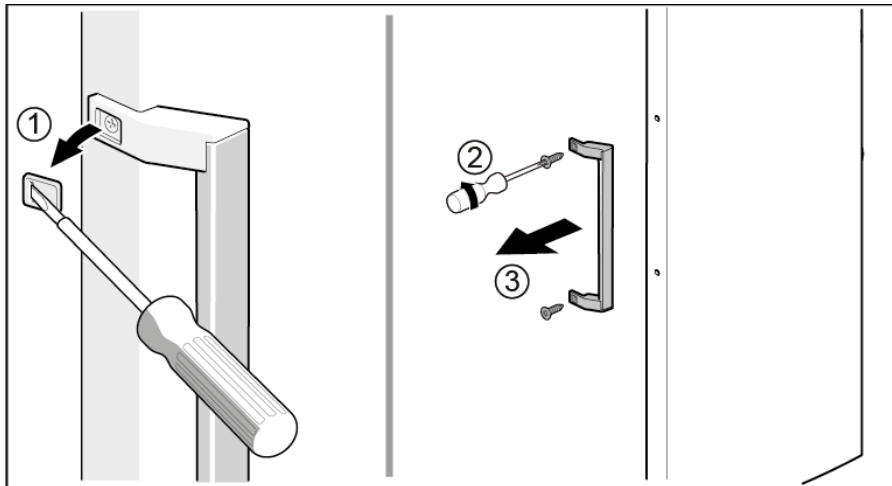

 La poignée de porte est retirée.



La poignée de la deuxième porte peut être retirée de la même manière.

### 4.2.2 Monter la poignée de porte

- ▶ Le montage s'effectue dans l'ordre chronologique inverse.

## 4.3 Remplacer la charnière supérieure de la porte

Outillage suggéré:

🌀 Embout Torx TX20      6,3 mm (1/4")      [00340865]

	<b>⚠️ AVERTISSEMENT</b> <b>Appareils lourds et volumineux !</b> Blessures dorsales et musculaires <ul style="list-style-type: none"><li>▶ Seuls des spécialistes dûment formés devraient retirer la porte de l'appareil.</li><li>▶ Pour déplacer l'appareil, deux personnes sont nécessaires.</li><li>▶ Utiliser seulement des outils et de l'équipement appropriés.</li></ul>
--	--

	<b>⚠️ PRUDENCE</b> <b>Arêtes vives !</b> Blessures par coupure <ul style="list-style-type: none"><li>▶ Porter des gants de protection.</li></ul>
--	--

	<b>⚠️ AVERTISSEMENT</b> <b>Chute d'appareils inclinés !</b> Fractures/blessures d'écrasement <ul style="list-style-type: none"><li>▶ Sécuriser les appareils contre le risque de chute.</li></ul>
--	---

	<b>⚠️ PRUDENCE</b> <b>Risque de pièces qui chutent en raison de vis trop lâches !</b> Blessures dues à des pièces qui chutent. <ul style="list-style-type: none"><li>▶ Sécuriser les composants contre le risque de chute.</li></ul>
---	--

	<b>⚠️ ATTENTION !</b> <b>Risque de pièces qui chutent en raison de vis trop lâches !</b> Dommages à d'autres parties de l'appareil ou à la propriété du client, p. ex. au plancher. <ul style="list-style-type: none"><li>▶ Sécuriser les composants contre le risque de chute.</li></ul>
--	---

Pré-requis:

- ✔ Appareil est déconnecté de l'alimentation.
- ✔ Les équipements intérieurs de l'appareil sont retirés.

### 4.3.1 Retirer la charnière supérieure de la porte

1. Placer l'appareil sur le dos.

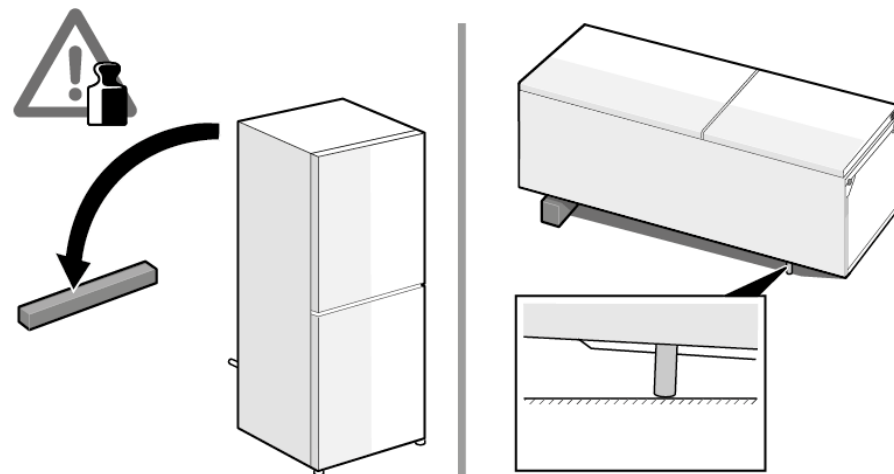

## Réparation

2. 1. Appuyer sur le cache de charnière supérieure des deux côtés (1).
2. Sortir le cache de charnière supérieure (2).
3. Faire pivoter le cache de la charnière (3).
4. Retirer le cache de la charnière supérieure (4).
5. Dévisser deux vis (5).
6. Retirer la charnière supérieure (6).

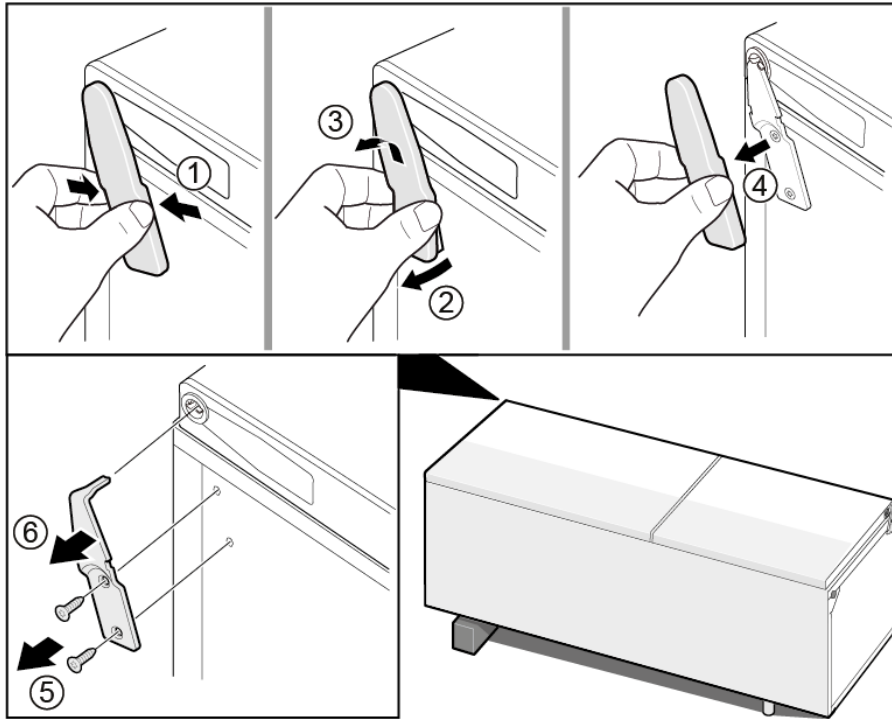

 La charnière supérieure est retirée.

### 4.3.2 Monter la charnière supérieure de la porte

- ▶ Le montage s'effectue dans l'ordre chronologique inverse.

## 4.4 Remplacer la charnière supérieure de la porte (porte avec afficheur)

Outillage suggérée:

🌀 Embout Torx TX20      6,3 mm (1/4")      [00340865]

	<b>⚠️ AVERTISSEMENT</b>
	<p><b>Appareils lourds et volumineux !</b> Blessures dorsales et musculaires</p> <ul style="list-style-type: none"> <li>▶ Seuls des spécialistes dûment formés devraient retirer la porte de l'appareil.</li> <li>▶ Pour déplacer l'appareil, deux personnes sont nécessaires.</li> <li>▶ Utiliser seulement des outils et de l'équipement appropriés.</li> </ul>

	<b>⚠️ PRUDENCE</b>
	<p><b>Arêtes vives !</b> Blessures par coupure</p> <ul style="list-style-type: none"> <li>▶ Porter des gants de protection.</li> </ul>

	<b>⚠️ AVERTISSEMENT</b>
	<p><b>Chute d'appareils inclinés !</b> Fractures/blessures d'écrasement</p> <ul style="list-style-type: none"> <li>▶ Sécuriser les appareils contre le risque de chute.</li> </ul>

	<b>⚠️ PRUDENCE</b>
	<p><b>Risque de pièces qui chutent en raison de vis trop lâches !</b> Blessures dues à des pièces qui chutent.</p> <ul style="list-style-type: none"> <li>▶ Sécuriser les composants contre le risque de chute.</li> </ul>

	<b>ATTENTION !</b>
	<p><b>Risque de pièces qui chutent en raison de vis trop lâches !</b> Dommages à d'autres parties de l'appareil ou à la propriété du client, p. ex. au plancher.</p> <ul style="list-style-type: none"> <li>▶ Sécuriser les composants contre le risque de chute.</li> </ul>

	<b>⚠️ DANGER</b>
	<p><b>Risque d'électrocution en raison de pièces sous tension !</b> Risque d'électrocution en cas de réparation non conforme</p> <ul style="list-style-type: none"> <li>▶ Les pièces électriques doivent être réparées par des techniciens qualifiés.</li> <li>▶ Après la réparation, effectuer un test de sécurité selon VDE 0701 ou les réglementations spécifiques nationales.</li> </ul>

	<b>⚠️ DANGER</b>
	<p><b>Risque d'électrocution par des pièces conductrices de tension !</b> Mort par électrocution.</p> <ul style="list-style-type: none"> <li>▶ Débrancher l'appareil du secteur minimum 60 secondes avant de démarrer la réparation.</li> </ul>

Pré-requis:

- ✓ Appareil est déconnecté de l'alimentation.
- ✓ Les équipements intérieurs de l'appareil sont retirés.

### 4.4.1 Retirer la charnière supérieure de la porte

1. Placer l'appareil sur le dos.

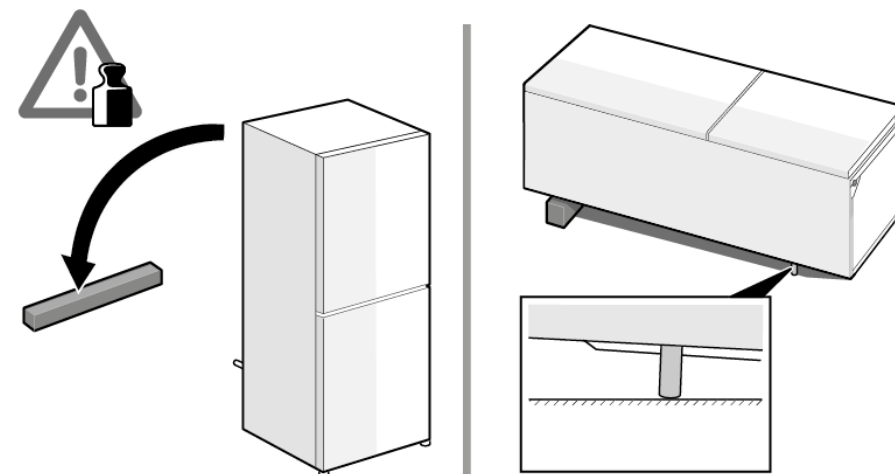

## Réparation

2. 1. Retirer le cache de la charnière supérieure (1).
2. Retirer le couvercle de la boîte de câbles (2).
3. Débrancher la connexion électrique (3).
4. Dévisser la vis de mise à la terre (4).
5. Retirer la protection du câble (5).
6. Dévisser la vis (6).

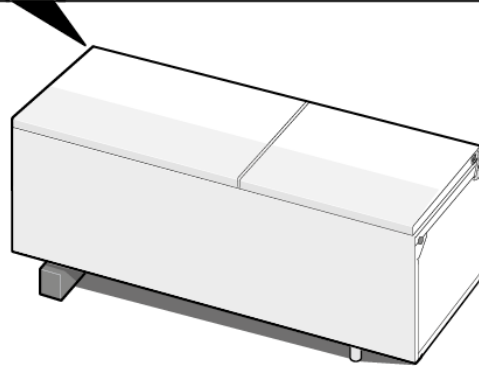
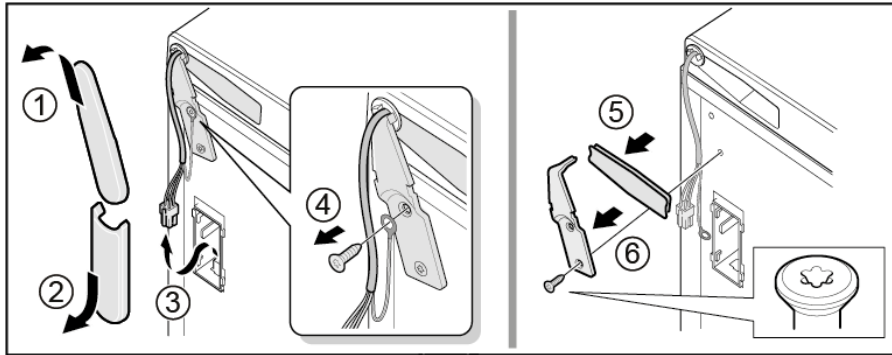

 La charnière supérieure est retirée.

### 4.4.2 Monter la charnière supérieure de la porte

- ▶ Le montage s'effectue dans l'ordre chronologique inverse.

## 4.5 Remplacer la charnière intermédiaire de la porte

Outillage suggéré:

🌀 Embout Torx TX20      6,3 mm (1/4")      [00340865]

	<b>⚠️ AVERTISSEMENT</b>
	<p><b>Appareils lourds et volumineux !</b> Blessures dorsales et musculaires</p> <ul style="list-style-type: none"> <li>▶ Seuls des spécialistes dûment formés devraient retirer la porte de l'appareil.</li> <li>▶ Pour déplacer l'appareil, deux personnes sont nécessaires.</li> <li>▶ Utiliser seulement des outils et de l'équipement appropriés.</li> </ul>

	<b>⚠️ PRUDENCE</b>
	<p><b>Arêtes vives !</b> Blessures par coupure</p> <ul style="list-style-type: none"> <li>▶ Porter des gants de protection.</li> </ul>

	<b>⚠️ AVERTISSEMENT</b>
	<p><b>Chute d'appareils inclinés !</b> Fractures/blessures d'écrasement</p> <ul style="list-style-type: none"> <li>▶ Sécuriser les appareils contre le risque de chute.</li> </ul>

	<b>⚠️ PRUDENCE</b>
	<p><b>Risque de pièces qui chutent en raison de vis trop lâches !</b> Blessures dues à des pièces qui chutent.</p> <ul style="list-style-type: none"> <li>▶ Sécuriser les composants contre le risque de chute.</li> </ul>

	<b>ATTENTION !</b>
	<p><b>Risque de pièces qui chutent en raison de vis trop lâches !</b> Dommages à d'autres parties de l'appareil ou à la propriété du client, p. ex. au plancher.</p> <ul style="list-style-type: none"> <li>▶ Sécuriser les composants contre le risque de chute.</li> </ul>

Pré-requis:

- ✅ Appareil est déconnecté de l'alimentation.
- ✅ Les équipements intérieurs de l'appareil sont retirés.
- ✅ La charnière supérieure de la porte est retirée.

✅ La porte supérieure est retirée.

### 4.5.1 Retirer la charnière intermédiaire de la porte

- ▶ 1. Retirer la porte du compartiment réfrigérateur (1).
- ▶ 2. Dévisser deux vis (2).
- ▶ 3. Retirer la charnière intermédiaire (3).

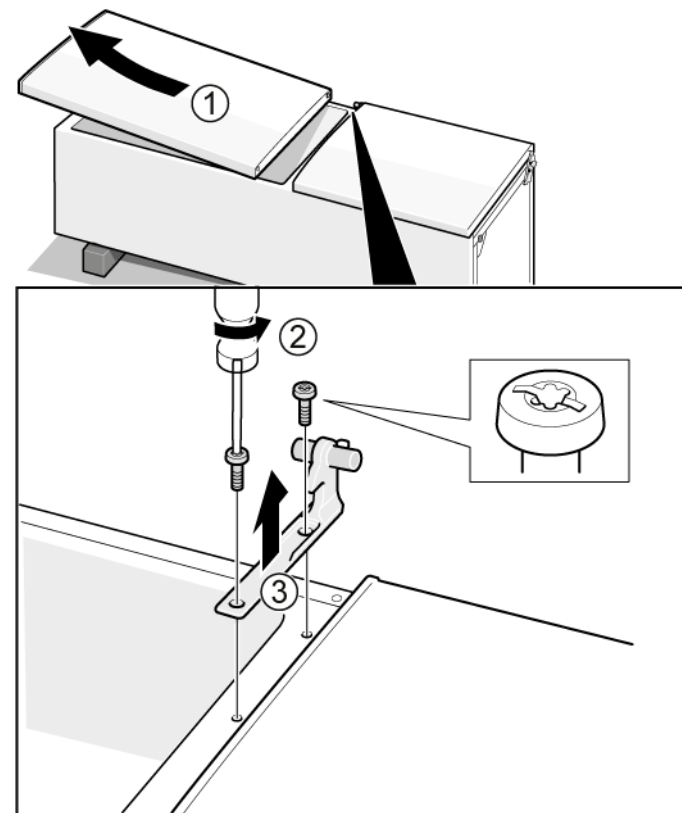

➡ La charnière intermédiaire est retirée.

### 4.5.2 Monter la charnière intermédiaire de la porte

- ▶ Le montage s'effectue dans l'ordre chronologique inverse.

## 4.6 Remplacer la charnière de porte inférieure

Outillage suggérée:

🔧 Embout Torx TX20      6,3 mm (1/4")      [00340865]

	<b>⚠️ AVERTISSEMENT</b>
	<p><b>Appareils lourds et volumineux !</b> Blessures dorsales et musculaires</p> <ul style="list-style-type: none"> <li>▶ Seuls des spécialistes dûment formés devraient retirer la porte de l'appareil.</li> <li>▶ Pour déplacer l'appareil, deux personnes sont nécessaires.</li> <li>▶ Utiliser seulement des outils et de l'équipement appropriés.</li> </ul>

	<b>⚠️ PRUDENCE</b>
	<p><b>Arêtes vives !</b> Blessures par coupure</p> <ul style="list-style-type: none"> <li>▶ Porter des gants de protection.</li> </ul>

	<b>⚠️ AVERTISSEMENT</b>
	<p><b>Chute d'appareils inclinés !</b> Fractures/blessures d'écrasement</p> <ul style="list-style-type: none"> <li>▶ Sécuriser les appareils contre le risque de chute.</li> </ul>

	<b>⚠️ PRUDENCE</b>
	<p><b>Risque de pièces qui chutent en raison de vis trop lâches !</b> Blessures dues à des pièces qui chutent.</p> <ul style="list-style-type: none"> <li>▶ Sécuriser les composants contre le risque de chute.</li> </ul>

	<b>ATTENTION !</b>
	<p><b>Risque de pièces qui chutent en raison de vis trop lâches !</b> Dommages à d'autres parties de l'appareil ou à la propriété du client, p. ex. au plancher.</p> <ul style="list-style-type: none"> <li>▶ Sécuriser les composants contre le risque de chute.</li> </ul>

Pré-requis:

- ✔️ Appareil est déconnecté de l'alimentation.
- ✔️ Les équipements intérieurs de l'appareil sont retirés.
- ✔️ La charnière supérieure est retirée.

✔️ La charnière intermédiaire est retirée.

### 4.6.1 Retirer la charnière intermédiaire de la porte

- ▶ 1. Retirer la porte du compartiment congélateur (1).
- ▶ 2. Dévisser la vis (2).
- ▶ 3. Extraire la charnière inférieure en la tournant (3).
- ▶ 4. Retirer la charnière inférieure (4).

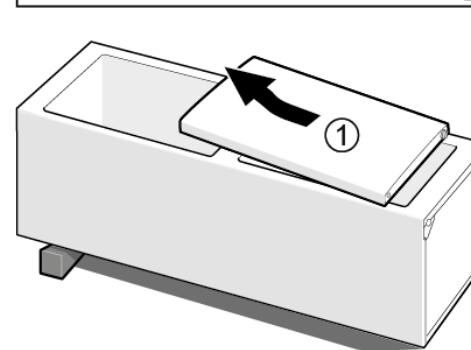
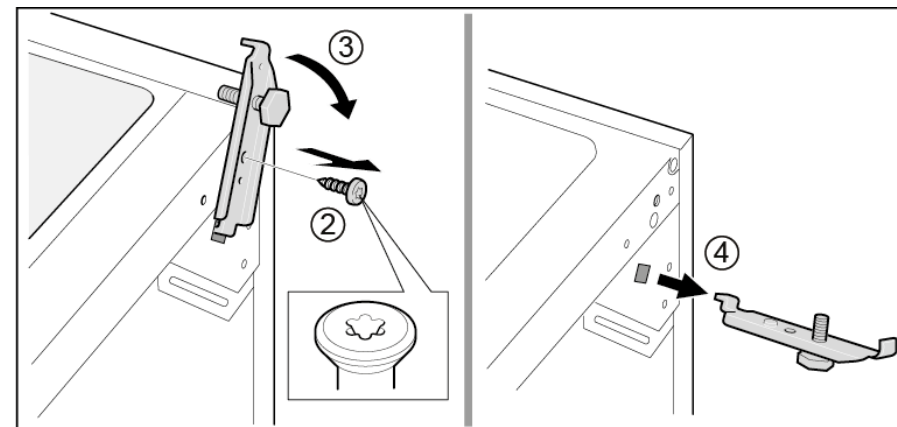

➡️ La charnière inférieure de la porte est retirée.

### 4.6.2 Monter la charnière de porte inférieure

- ▶ Le montage s'effectue dans l'ordre chronologique inverse.

## 4.7 Remplacer la tablette

### Pré-requis:

- ✔ La porte est ouverte.

### 4.7.1 Retirer la tablette

- ▶ Extraire la tablette.

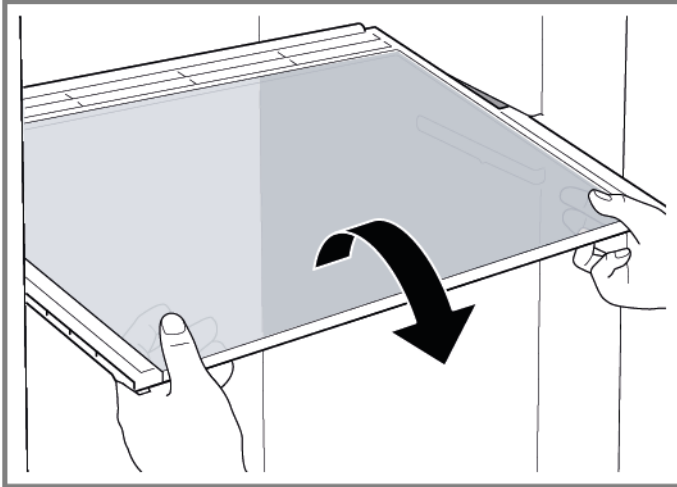

- ➡ La tablette est retirée.

### 4.7.2 Monter la tablette

- ▶ Le montage s'effectue dans l'ordre chronologique inverse.

## 4.8 Remplacer la tablette variable

### Pré-requis:

- ✔ La porte est ouverte.

### 4.8.1 Retirer la tablette variable

1. Tirer la section de droite de la tablette variable vers l'avant (1).
2. Retirer la section de droite de la tablette variable (2).

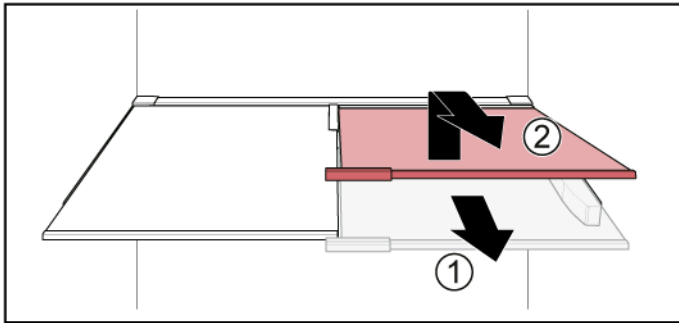

2. Retirer la section de gauche de la tablette variable en procédant de la même façon.

- ➡ La tablette variable est retirée.

### 4.8.2 Monter la tablette variable

- ▶ Le montage s'effectue dans l'ordre chronologique inverse.

## 4.9 Remplacer la tablette flexible

### Pré-requis:

- ✔ La porte est ouverte.

### 4.9.1 Retirer la tablette flexible

- ▶ 1. Retirer la clayette en verre (1).
- ▶ 2. Soulever et extraire la clayette flexible (2).

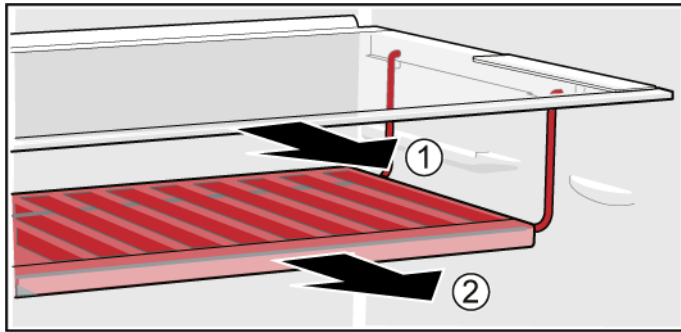

- ➡ La clayette flexible est retirée.

### 4.9.2 Monter la tablette flexible

- ▶ Le montage s'effectue dans l'ordre chronologique inverse.

## 4.10 Remplacer le set petit-déjeuner

### Pré-requis:

- ✔ La porte est ouverte.

### 4.10.1 Retirer le set petit-déjeuner

- ▶ Soulever et extraire le set petit-déjeuner.

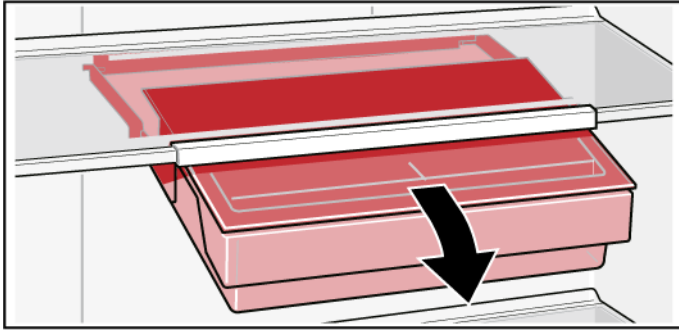

- ➡ Le set petit-déjeuner est retiré.

### 4.10.2 Monter le set petit-déjeuner

- ▶ Le montage s'effectue dans l'ordre chronologique inverse.

## 4.11 Remplacer le casier à bouteilles

### Pré-requis:

- ✔ La porte est ouverte.

### 4.11.1 Retirer le casier à bouteilles

- ▶ Extraire le casier à bouteilles.

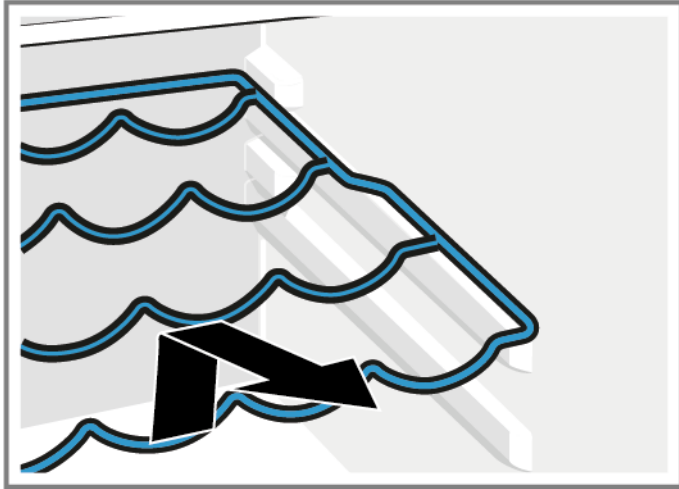

- ➡ Le casier à bouteilles est retiré.

### 4.11.2 Monter le casier à bouteilles

- ▶ Le montage s'effectue dans l'ordre chronologique inverse.

## 4.12 Remplacer l'étagère de la porte

### Pré-requis:

- ✔ La porte est ouverte.

### 4.12.1 Retirer l'étagère de la porte

- ▶ Soulever l'étagère de la porte.

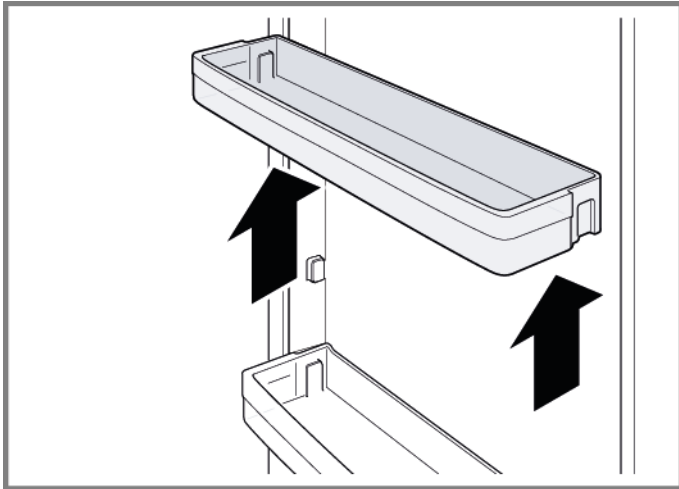

- ➡ L'étagère de la porte est retirée.

### 4.12.2 Monter l'étagère de la porte

- ▶ Le montage s'effectue dans l'ordre chronologique inverse.

## 4.13 Remplacer le bac d'aliments congelés

### Pré-requis:

- ✔ La porte est ouverte.

### 4.13.1 Retirer le bac d'aliments congelés

- ▶ 1. Extraire complètement le bac d'aliments congelés (1).
- ▶ 2. Retirer le bac d'aliments (2).

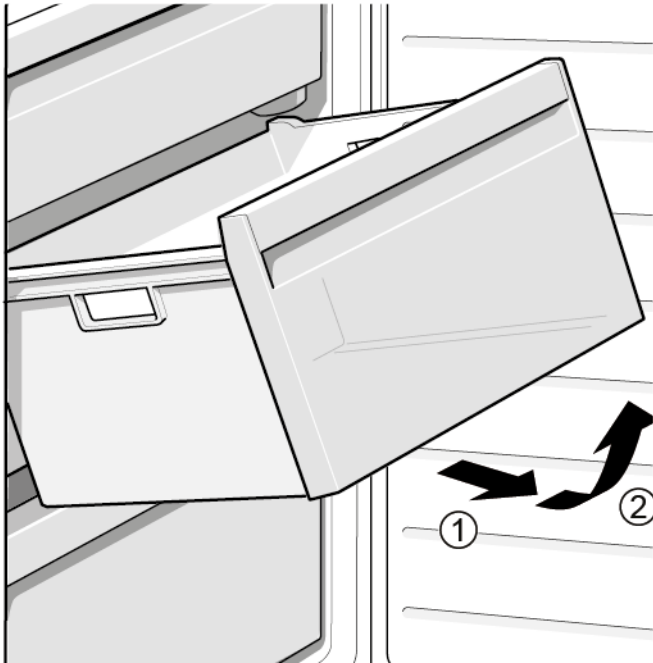

- ➡ Le bac d'aliments congelés est retiré.

### 4.13.2 Monter le bac d'aliments congelés

- ▶ Le montage s'effectue dans l'ordre chronologique inverse.

## 4.14 Remplacer le bac

### Pré-requis:

- ✔ La porte est ouverte.

### 4.14.1 Retirer le bac

- ▶ 1. Extraire le bac inférieur du réfrigérateur (1).
- ▶ 2. Extraire le bac supérieur du réfrigérateur (2).

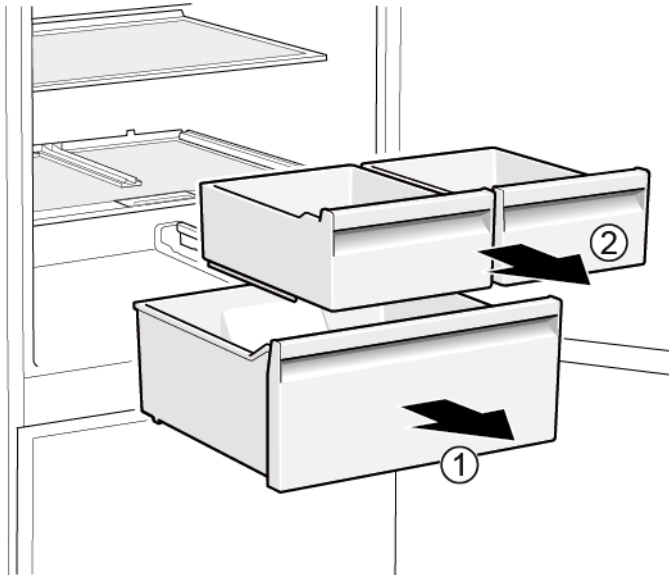

- ➡ Les bacs sont retirés.

### 4.14.2 Monter le bac

- ▶ Le montage s'effectue dans l'ordre chronologique inverse.

## 4.15 Remplacer le bac télescopique

### Pré-requis:

- ✔ La porte est ouverte.

### 4.15.1 Extraire le bac télescopique

- ▶ 1. Extraire complètement le bac télescopique (1).
- ▶ 2. Retirer le bac télescopique (2).

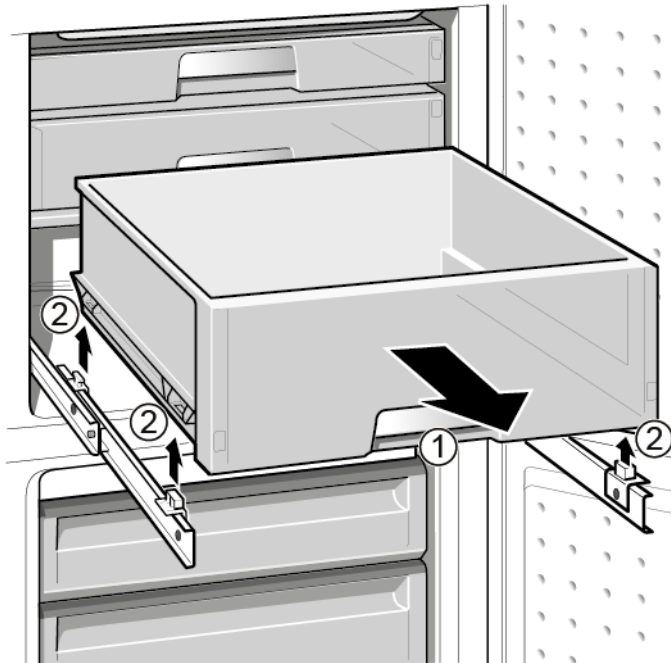

- ➡ Le bac télescopique est retiré.

### 4.15.2 Monter le bac télescopique

- ▶ Le montage s'effectue dans l'ordre chronologique inverse.

## 4.16 Changer le projecteur LED

Outillage suggérée:

🔧 Outil spécial [00342180]

**i** Votre appareil est équipé d'un éclairage LED ne demandant pas d'entretien.  
Les réparations de cet éclairage sont exclusivement réservées au service après-vente ou à des spécialistes autorisés!

**⚠️ DANGER**  
**Risque d'électrocution en raison de pièces sous tension !**  
Risque d'électrocution en cas de réparation non conforme

- ▶ Les pièces électriques doivent être réparées par des techniciens qualifiés.
- ▶ Après la réparation, effectuer un test de sécurité selon VDE 0701 ou les réglementations spécifiques nationales.

**⚠️ DANGER**  
**Risque d'électrocution par des pièces conductrices de tension !**  
Mort par électrocution.

- ▶ Débrancher l'appareil du secteur minimum 60 secondes avant de démarrer la réparation.

**⚠️ PRUDENCE**  
**Arêtes vives !**  
Blessures par coupure

- ▶ Porter des gants de protection.

Pré-requis:

- ✔ Appareil est déconnecté de l'alimentation.
- ✔ La porte est ouverte.

### 4.16.1 Démontage du projecteur LED

1. Retirer le projecteur LED à l'aide d'un outil spécial (1).

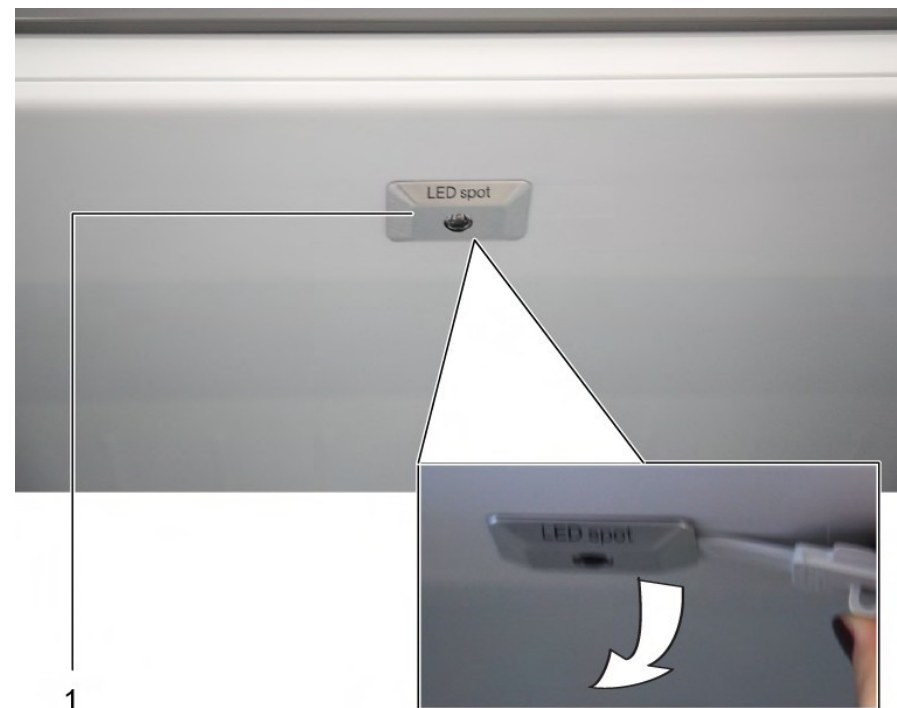

2. Retirer les raccords électriques du projecteur LED.

➡ Le projecteur LED est retiré.

### 4.16.2 Monter le projecteur LED

- ▶ Le montage s'effectue dans l'ordre chronologique inverse.

## 4.17 Remplacer l'éclairage LED supérieur

### Outillage suggérée:

-  Tournevis plat      Lame 2.4 mm x 0.4 mm x 60 mm, dans le kit [00341820]



Votre appareil comprend un éclairage LED sans maintenance. Ces lampes peuvent être réparées exclusivement par le service après-vente ou un technicien autorisé.



### DANGER

#### Risque d'électrocution en raison de pièces sous tension !

Risque d'électrocution en cas de réparation non conforme

- ▶ Les pièces électriques doivent être réparées par des techniciens qualifiés.
- ▶ Après la réparation, effectuer un test de sécurité selon VDE 0701 ou les réglementations spécifiques nationales.



### DANGER

#### Risque d'électrocution par des pièces conductrices de tension !

Mort par électrocution.

- ▶ Débrancher l'appareil du secteur minimum 60 secondes avant de démarrer la réparation.





### PRUDENCE

#### Arêtes vives !

Blessures par coupure

- ▶ Porter des gants de protection.

### Pré-requis:

-  Appareil est déconnecté de l'alimentation.
-  La porte est ouverte.
-  Les équipements intérieurs supérieurs de l'appareil sont retirés.

## 4.17.1 Retirer l'éclairage LED

1. Déplacer l'éclairage LED vers la gauche.

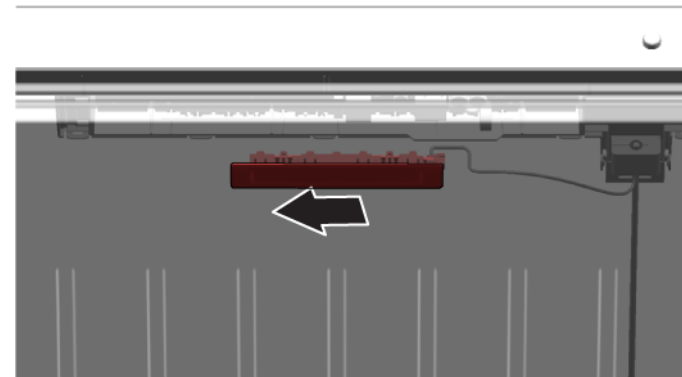

-  Connexion électrique de l'éclairage LED est débranchée.

2. Libérer les crochets de l'éclairage LED.

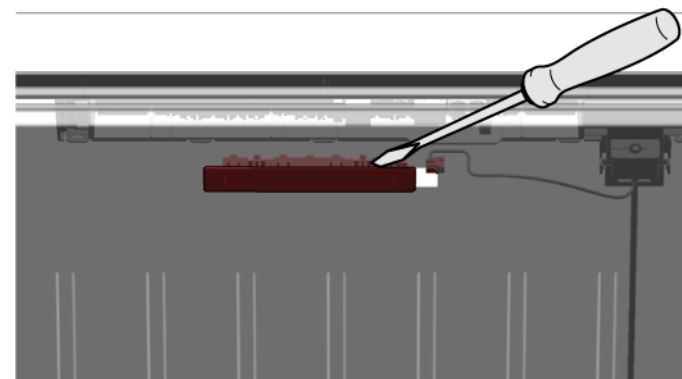

3. Retirer l'éclairage LED par l'avant.

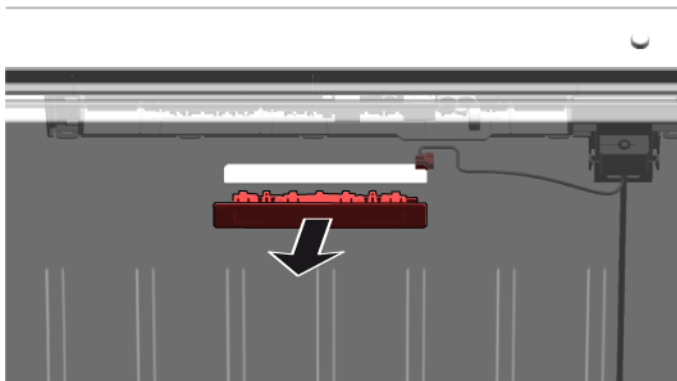

- ➔ L'éclairage LED est retiré.

### 4.17.2 Monter l'éclairage LED supérieur

- ▶ Le montage s'effectue dans l'ordre chronologique inverse.

## 4.18 Echange de l'éclairage LED latéral

Outillage suggéré:

 Ventouse Ø50 mm [00342224]

 Votre appareil est équipé d'un éclairage LED ne demandant pas d'entretien.  
Les réparations de cet éclairage sont exclusivement réservées au service après-vente ou à des spécialistes autorisés!

 **DANGER**  
**Risque d'électrocution en raison de pièces sous tension !**  
Risque d'électrocution en cas de réparation non conforme

- ▶ Les pièces électriques doivent être réparées par des techniciens qualifiés.
- ▶ Après la réparation, effectuer un test de sécurité selon VDE 0701 ou les réglementations spécifiques nationales.

 **DANGER**  
**Risque d'électrocution par des pièces conductrices de tension !**  
Mort par électrocution.

- ▶ Débrancher l'appareil du secteur minimum 60 secondes avant de démarrer la réparation.

 **PRUDENCE**  
**Arêtes vives !**  
Blessures par coupure

- ▶ Porter des gants de protection.

Pré-requis:

- ✓ Appareil est déconnecté de l'alimentation.
- ✓ La porte est ouverte.
- ✓ Les clayettes du réfrigérateur sont retirées.

### 4.18.1 Démontage de l'éclairage LED latéral

1. Fixer la ventouse dans le tiers supérieur de l'éclairage LED latéral.



- Retirer l'éclairage LED latéral en tournant vers l'avant avec la ventouse.

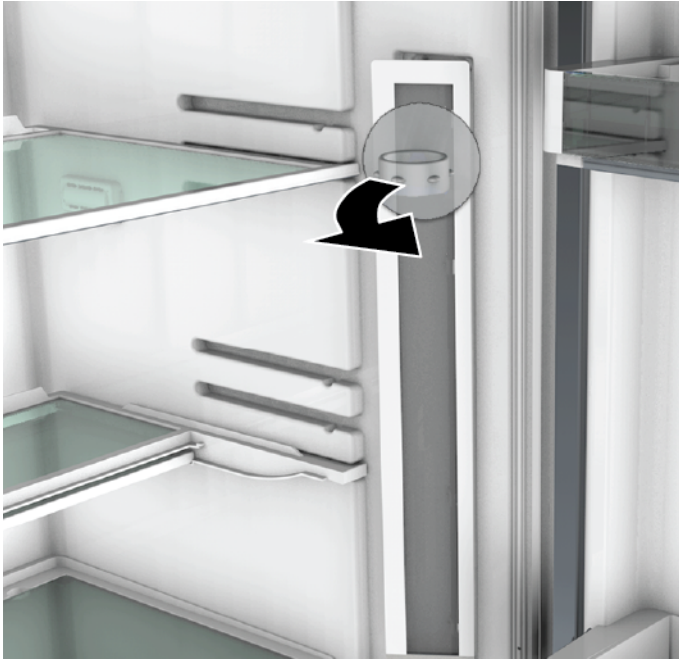

- Retirer le raccord électrique de l'éclairage LED latéral.  
➡ L'éclairage LED latéral est retiré.

### 4.18.2 Montage de l'éclairage LED latéral

- Rétablir le raccord électrique de l'éclairage LED latéral.
  - Monter l'éclairage LED latéral sur la position correspondante contre la paroi du compartiment réfrigérateur (fixer les crochets).
- ➡ L'éclairage LED latéral est monté.

# Reparatur Hinweise - Kühl- und Gefriergerät

 <b>Zu diesem Dokument</b> .....	<b>246</b>
1.1 Wichtige Hinweise: .....	246
1.1.1 Zweck .....	246
1.2 Zeichenerklärung.....	246
1.2.1 Gefahrenstufen .....	246
1.2.2 Gefahrensymbole.....	246
1.2.3 Struktur der Warnhinweise.....	247
1.2.4 Allgemeine Symbole .....	247
 <b>Sicherheit</b> .....	<b>248</b>
2.1 Allgemeine Sicherheitshinweise .....	248
2.1.1 Alle Hausgeräte .....	248
 <b>Werkzeuge und Hilfsmittel</b> .....	<b>249</b>
 <b>Instandsetzen</b> .....	<b>250</b>
4.1 Austauschen der Türdichtung.....	250
4.2 Austauschen des Türgriffs.....	251
4.2.1 Ausbauen des Türgriffs .....	251
4.2.2 Einbauen des Türgriffs .....	251
4.3 Austauschen des oberen Türscharniers .....	252
4.3.1 Ausbauen des oberen Türscharniers.....	252
4.3.2 Einbauen des oberen Türscharniers.....	253
4.4 Austauschen des oberen Türscharniers (Tür mit Anzeige) .....	254
4.4.1 Ausbauen des oberen Türscharniers.....	254
4.4.2 Einbauen des oberen Türscharniers.....	255
4.5 Austauschen des mittleren Türscharniers.....	256
4.5.1 Ausbauen des mittleren Türscharniers .....	256
4.5.2 Einbauen des mittleren Türscharniers .....	256
4.6 Austauschen des unteren Türscharniers .....	257
4.6.1 Ausbauen des unteren Türscharniers.....	257
4.6.2 Einbauen des unteren Türscharniers.....	257
4.7 Austauschen der Ablage .....	258
4.7.1 Ausbauen der Ablage.....	258
4.7.2 Einbauen der Ablage.....	258
4.8 Austauschen der variablen Ablage .....	259

4.8.1 Ausbauen der variablen Ablage.....	259
4.8.2 Einbauen der variablen Ablage.....	259
4.9 Austauschen der variablen Ablage .....	260
4.9.1 Ausbauen der flexiblen Ablage .....	260
4.9.2 Einbauen der flexiblen Ablage .....	260
4.10 Austauschen der Frühstücksbox .....	261
4.10.1 Ausbauen der Frühstücksbox .....	261
4.10.2 Einbauen der Frühstücksbox.....	261
4.11 Austauschen der Flaschenablage .....	262
4.11.1 Ausbauen der Flaschenablage .....	262
4.11.2 Einbauen der Flaschenablage .....	262
4.12 Austauschen des Türabstellers .....	263
4.12.1 Ausbauen des Türabstellers.....	263
4.12.2 Einbauen des Türabstellers.....	263
4.13 Austauschen des Gefriergutbehälters.....	264
4.13.1 Ausbauen des Gefriergutbehälters .....	264
4.13.2 Einbauen des Gefriergutbehälters .....	264
4.14 Austauschen des Behälters .....	265
4.14.1 Ausbauen des Behälters .....	265
4.14.2 Einbauen des Behälters .....	265
4.15 Austauschen des ausziehbaren Behälters .....	266
4.15.1 Ausbauen des ausziehbaren Behälters.....	266
4.15.2 Einbauen des ausziehbaren Behälters.....	266
4.16 Austauschen des LED-Strahlers .....	267
4.16.1 Ausbauen des LED-Strahlers .....	267
4.16.2 Einbauen des LED-Strahlers .....	267
4.17 Austauschen des LED-Oberlichts.....	268
4.17.1 Ausbauen der LED-Beleuchtung .....	268
4.17.2 Einbauen des LED-Oberlichts .....	269
4.18 Austauschen der seitlichen LED-Beleuchtung.....	270
4.18.1 Ausbauen der seitlichen LED-Beleuchtung.....	270
4.18.2 Einbauen der seitlichen LED-Beleuchtung .....	271

# Zu diesem Dokument

## 1.1 Wichtige Hinweise:

### 1.1.1 Zweck

Diese Reparaturhinweise dienen zur Unterstützung des Kunden bei der selbständigen Gerätereparatur gemäß der entsprechenden Ökodesign-Richtlinie (ab 03/2021).

Sie enthalten Informationen zum Austausch bestimmter Ersatzteile sowie Warn- und Gefahrenhinweise.

Bitte wenden Sie sich in Zweifelsfällen an unseren Kundendienst. Bei nicht ordnungsgemäßer Befolgung der Reparaturhinweise ist die Schadenshaftung ausgeschlossen.

## 1.2 Zeichenerklärung

### 1.2.1 Gefahrenstufen

Die Gefahrenstufen bestehen aus einem Symbol und einem Signalwort. Das Signalwort kennzeichnet die Schwere der Gefahr.









Gefahrenstufe	Bedeutung
	Nichtbeachtung des Warnhinweises führt zu Tod oder schweren Verletzungen.
	Nichtbeachtung des Warnhinweises kann zu Tod oder schweren Verletzungen führen.
	Nichtbeachtung des Warnhinweises kann zu leichten Verletzungen führen.
	Nichtbeachtung des Warnhinweises kann zu Sachschäden führen.

Tabelle 1: Gefahrenstufen

### 1.2.2 Gefahrensymbole

Gefahrensymbole sind sinnbildliche Darstellungen, die einen Hinweis auf die Art der Gefahr geben.

In diesem Dokument werden folgende Gefahrensymbole verwendet:

Gefahrensymbol	Bedeutung
	Allgemeiner Warnhinweis
	Gefahr durch elektrische Spannung
	Gefahr durch Explosion
	Gefahr von Schnittverletzungen
	Gefahr von Quetschverletzungen

## Zu diesem Dokument





Gefahrensymbol	Bedeutung
	Gefahr durch heiße Oberflächen
	Gefahr durch starkes Magnetfeld
	Gefahr durch nicht ionisierende Strahlung

Tabelle 2: Gefahrensymbole

### 1.2.3 Struktur der Warnhinweise

Warnhinweise haben in diesem Dokument ein einheitliches Aussehen und eine einheitliche Struktur.



	 <b>GEFAHR</b>
	<p><b>Art und Quelle der Gefahr!</b> Mögliche Folgen bei Nichtbeachtung der Gefahr / des Warnhinweises.</p> <ul style="list-style-type: none"> <li>▶ Maßnahmen und Verbote zur Vermeidung der Gefahr.</li> </ul>

Das folgende Beispiel zeigt einen Warnhinweis, der vor Stromschlaggefahr durch spannungsführende Teile warnt. Die Maßnahme zur Vermeidung der Gefahr wird genannt.

	 <b>GEFAHR</b>
	<p><b>Stromschlaggefahr durch spannungsführende Teile!</b> Tod durch Stromschlag</p> <ul style="list-style-type: none"> <li>▶ Gerät mindestens 60 Sekunden vor Reparaturbeginn vom Netz trennen.</li> </ul>

### 1.2.4 Allgemeine Symbole

In diesem Dokument werden folgende allgemeine Symbole verwendet:

Allg. Symbol	Bedeutung
	Kennzeichnung eines besonderen (Text und/oder Grafik) Tipps
	Kennzeichnung eines einfachen (nur Text) Tipps

Allg. Symbol	Bedeutung
	Kennzeichnung eines Links zu einer Videoanleitung
	Kennzeichnung erforderlicher Werkzeuge
	Kennzeichnung erforderlicher Voraussetzungen
	Kennzeichnung einer Bedingung (Wenn ..., dann ...)
	Kennzeichnung eines Ergebnisses
[Start]	Kennzeichnung einer Taste oder Schaltfläche
[00123456]	Kennzeichnung einer Materialnummer
Status	Kennzeichnung eines angezeigten Textes / Fensters (im Gerätedisplay)

Tabelle 3: Allgemeine Symbole

## 2.1 Allgemeine Sicherheitshinweise

### 2.1.1 Alle Hausgeräte

#### **Stromschlaggefahr durch spannungsführende Teile!**

- Wenn elektrische Komponenten fehlerhaft repariert werden, besteht Stromschlaggefahr!
- Das Gerät mindestens 60 Sekunden vor Beginn der Arbeiten vom Netz trennen.
- Nach der Reparatur muss eine Sicherheitsprüfung nach VDE 0701 oder länderspezifischen Vorschriften durchgeführt werden.

#### **Verletzungsgefahr durch scharfe Kanten!**

- Schutzhandschuhe tragen.

#### **Quetschgefahr während Reparatur-, Wartungs-, Fehlersuche- und Servicearbeiten durch schwere sich bewegende Bauteile**

- Schutzhandschuhe tragen.
- Schwere Bauteile gegen Herabfallen sichern.
- Körperteile nicht in sich bewegende Bauteile stecken.

#### **Gefährdung der Gerätesicherheit/-funktion!**

- Ausschließlich Originalersatzteile verwenden.

#### **Gefahr der Beschädigung elektrostatisch gefährdeter Bauteile (elektrostatische Entladungen)!**

- Die Module, einschließlich ihrer Anschlüsse und Leiterbahnen, keinesfalls berühren.

## Werkzeuge und Hilfsmittel

Bezeichnung	Details	Bilder
Schutztuch [00342013]	60 cm x 50 cm	
Präzisions-Schraubendreher-Satz [00341820]	9 Teile, 2,0 mm, 2,4 mm, 3,0 mm, PH0, PH00, PH1, TX6, TX8, TX9	
Hilfswerkzeug [00342180]	Für die Demontage von Kunststoffteilen, "Magic Tool"	
Saugnapf [00342224]	Ø 50 mm	
Torx-Bit TX20 [00340865]	6,3 mm (1/4")	
Schlitzschraubendreher	Klinge 10 mm x 1,6 mm x 200 mm	

## 4.1 Austauschen der Türdichtung

### Voraussetzung:



- Die Tür ist offen.

## 4.2 Austauschen des Türgriffs

### Vorgeschlagene Hilfsmittel:

-  Torx-Bit TX20                      6,3 mm (1/4")                      [00340865]
-  Schlitzschraubendreher              Klinge 10 mm x 1,6 mm x 200 mm

### Voraussetzung:

-  Das Gerät ist spannungsfrei.
-  Die Tür ist offen.

### 4.2.1 Ausbauen des Türgriffs

- ▶ 1. Die beiden Schraubkappen entfernen (1).
- ▶ 2. Die beiden Schrauben herausschrauben (2).
- ▶ 3. Den Türgriff entfernen (3).

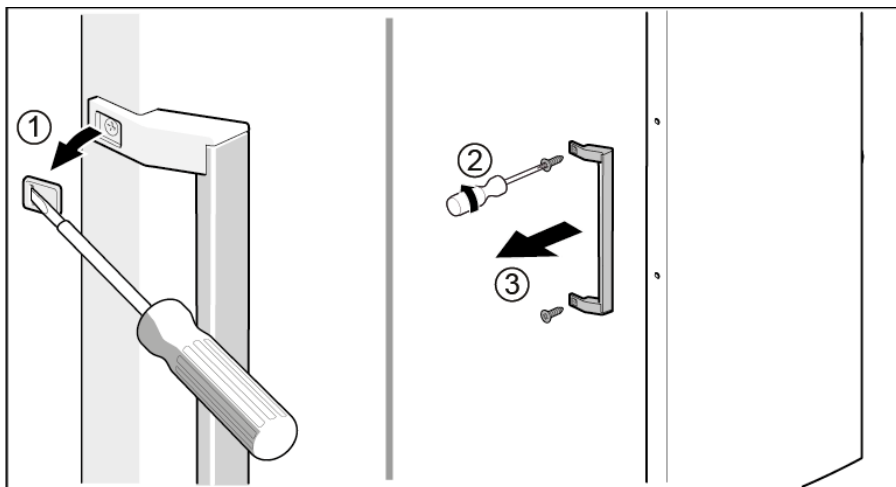

 Der Türgriff ist entfernt.



Der Türgriff für die zweite Tür kann auf die gleiche Art und Weise entfernt werden.

### 4.2.2 Einbauen des Türgriffs

- ▶ Der Einbau erfolgt in umgekehrter Reihenfolge.



## 4.3 Austauschen des oberen Türscharniers

Vorgeschlagene Hilfsmittel:

 Torx-Bit TX20      6,3 mm (1/4")      [00340865]

	<p style="text-align: center;"><b>⚠️ WARNUNG</b></p> <p><b>Schwere, unhandliche Geräte!</b> Rücken- und Muskelverletzungen</p> <ul style="list-style-type: none"> <li>▶ Der Ausbau der Gerätetür sollte nur von geschulten Spezialisten durchgeführt werden.</li> <li>▶ Zum Bewegen des Geräts sind zwei Personen erforderlich.</li> <li>▶ Nur geeignete Werkzeuge und Vorrichtungen verwenden.</li> </ul>
	<p style="text-align: center;"><b>⚠️ VORSICHT</b></p> <p><b>Scharfe Kanten!</b> Schnittverletzungen</p> <ul style="list-style-type: none"> <li>▶ Schutzhandschuhe tragen.</li> </ul>
	<p style="text-align: center;"><b>⚠️ WARNUNG</b></p> <p><b>Wegrutschen des gekippten Gerätes!</b> Knochenbrüche / Quetschungen</p> <ul style="list-style-type: none"> <li>▶ Gerät gegen Wegrutschen sichern.</li> </ul>
	<p style="text-align: center;"><b>⚠️ VORSICHT</b></p> <p><b>Risiko herabfallender Teile durch gelöste Schrauben!</b> Verletzungsgefahr durch herabfallende Teile.</p> <ul style="list-style-type: none"> <li>▶ Die Komponenten gegen Herunterfallen sichern.</li> </ul>
	<p style="text-align: center;"><b>⚠️ ACHTUNG</b></p> <p><b>Risiko herabfallender Teile durch gelöste Schrauben!</b> Gefahr der Beschädigung anderer Geräteteile bzw. von Beschädigungen im Haushalt des Kunden, z. B. des Bodens.</p> <ul style="list-style-type: none"> <li>▶ Die Komponenten gegen Herunterfallen sichern.</li> </ul>

Voraussetzung:

-  Das Gerät ist spannungsfrei.
-  Die Innenausstattungsteile des Geräts sind entfernt.

## 4.3.1 Ausbauen des oberen Türscharniers

1. Das Gerät auf die Rückseite legen.

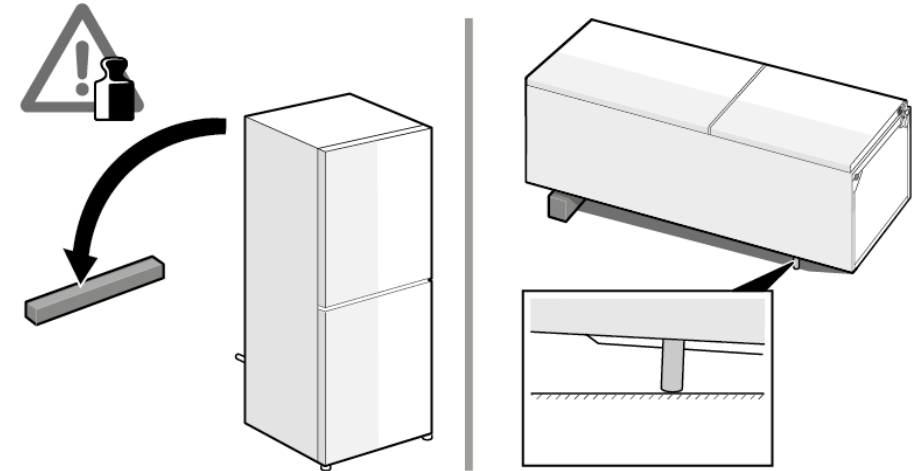

## Instandsetzen

2. 1. Auf beide Seiten der oberen Scharnierabdeckung Druck ausüben (1).
2. Die obere Scharnierabdeckung abziehen (2).
3. Die Scharnierabdeckung drehen (3).
4. Die obere Scharnierabdeckung entfernen (4).
5. Die beiden Schrauben heraus-schrauben (5).
6. Das obere Scharnier entfernen (6).

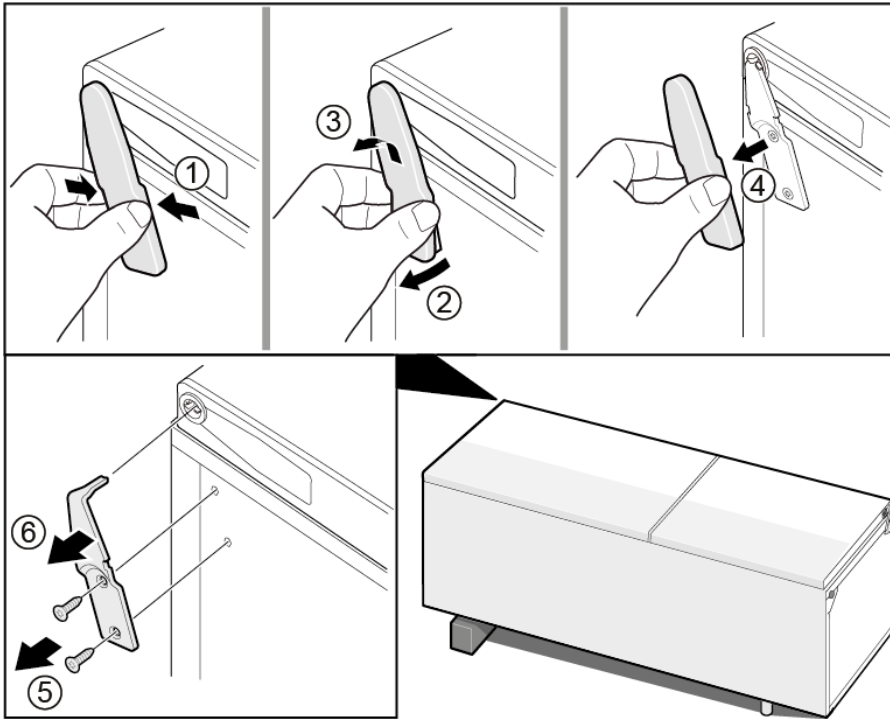

 Das obere Scharnier ist entfernt.

### 4.3.2 Einbauen des oberen Türscharniers

- ▶ Der Einbau erfolgt in umgekehrter Reihenfolge.

## 4.4 Austauschen des oberen Türscharniers (Tür mit Anzeige)

Vorgeschlagene Hilfsmittel:

🌀 Torx-Bit TX20      6,3 mm (1/4")      [00340865]

	<b>⚠️ WARNUNG</b>
	<p><b>Schwere, unhandliche Geräte!</b> Rücken- und Muskelverletzungen</p> <ul style="list-style-type: none"> <li>▶ Der Ausbau der Gerätetür sollte nur von geschulten Spezialisten durchgeführt werden.</li> <li>▶ Zum Bewegen des Geräts sind zwei Personen erforderlich.</li> <li>▶ Nur geeignete Werkzeuge und Vorrichtungen verwenden.</li> </ul>

	<b>⚠️ VORSICHT</b>
	<p><b>Scharfe Kanten!</b> Schnittverletzungen</p> <ul style="list-style-type: none"> <li>▶ Schutzhandschuhe tragen.</li> </ul>

	<b>⚠️ WARNUNG</b>
	<p><b>Wegrutschen des gekippten Gerätes!</b> Knochenbrüche / Quetschungen</p> <ul style="list-style-type: none"> <li>▶ Gerät gegen Wegrutschen sichern.</li> </ul>

	<b>⚠️ VORSICHT</b>
	<p><b>Risiko herabfallender Teile durch gelöste Schrauben!</b> Verletzungsgefahr durch herabfallende Teile.</p> <ul style="list-style-type: none"> <li>▶ Die Komponenten gegen Herunterfallen sichern.</li> </ul>

	<b>ACHTUNG</b>
	<p><b>Risiko herabfallender Teile durch gelöste Schrauben!</b> Gefahr der Beschädigung anderer Geräteteile bzw. von Beschädigungen im Haushalt des Kunden, z. B. des Bodens.</p> <ul style="list-style-type: none"> <li>▶ Die Komponenten gegen Herunterfallen sichern.</li> </ul>

	<b>⚠️ GEFAHR</b>
	<p><b>Stromschlaggefahr durch spannungsführende Teile!</b> Lebensgefahr durch Stromschlag bei unsachgemäßer Reparatur</p> <ul style="list-style-type: none"> <li>▶ Elektroteile sollten von einer Elektrofachkraft repariert werden.</li> <li>▶ Nach der Reparatur muss eine Sicherheitsprüfung nach VDE 0701 oder länderspezifischen Vorschriften durchgeführt werden.</li> </ul>

	<b>⚠️ GEFAHR</b>
	<p><b>Stromschlaggefahr durch spannungsführende Teile!</b> Tod durch Stromschlag</p> <ul style="list-style-type: none"> <li>▶ Gerät mindestens 60 Sekunden vor Reparaturbeginn vom Netz trennen.</li> </ul>

**Voraussetzung:**

- ✅ Das Gerät ist spannungsfrei.
- ✅ Die Innenausstattungsteile des Geräts sind entfernt.

### 4.4.1 Ausbauen des oberen Türscharniers

1. Das Gerät auf die Rückseite legen.

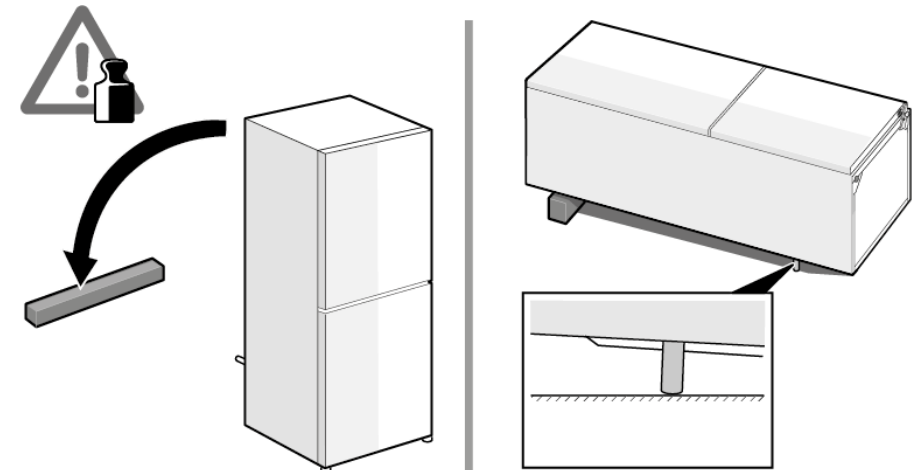

## Instandsetzen

2. 1. Die obere Scharnierabdeckung entfernen (1).
2. Die Kabelboxabdeckung entfernen (2).
3. Den elektrischen Anschluss trennen (3).
4. Die Erdanschlussschraube herausschrauben (4).
5. Den Kabelschutz entfernen (5).
6. Die Schraube herausschrauben (6).

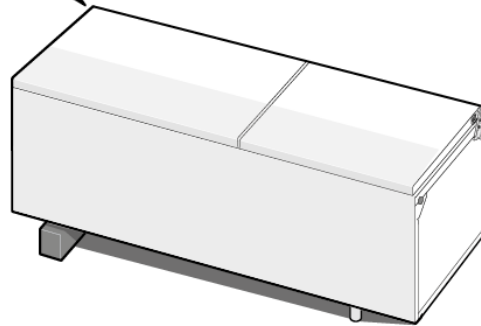
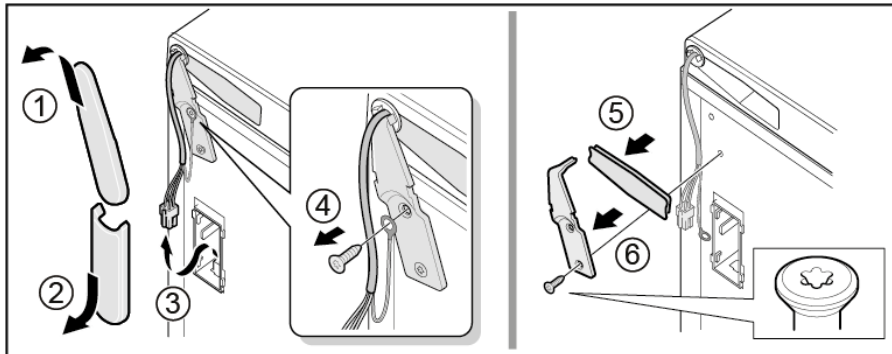

 Das obere Scharnier ist entfernt.

### 4.4.2 Einbauen des oberen Türscharniers

- ▶ Der Einbau erfolgt in umgekehrter Reihenfolge.

## 4.5 Austauschen des mittleren Türscharniers

### Vorgeschlagene Hilfsmittel:

🔧 Torx-Bit TX20      6,3 mm (1/4")      [00340865]

	<b>⚠️ WARNUNG</b>
	<p><b>Schwere, unhandliche Geräte!</b> Rücken- und Muskelverletzungen</p> <ul style="list-style-type: none"> <li>▶ Der Ausbau der Gerätetür sollte nur von geschulten Spezialisten durchgeführt werden.</li> <li>▶ Zum Bewegen des Geräts sind zwei Personen erforderlich.</li> <li>▶ Nur geeignete Werkzeuge und Vorrichtungen verwenden.</li> </ul>

	<b>⚠️ VORSICHT</b>
	<p><b>Scharfe Kanten!</b> Schnittverletzungen</p> <ul style="list-style-type: none"> <li>▶ Schutzhandschuhe tragen.</li> </ul>

	<b>⚠️ WARNUNG</b>
	<p><b>Wegrutschen des gekippten Gerätes!</b> Knochenbrüche / Quetschungen</p> <ul style="list-style-type: none"> <li>▶ Gerät gegen Wegrutschen sichern.</li> </ul>

	<b>⚠️ VORSICHT</b>
	<p><b>Risiko herabfallender Teile durch gelöste Schrauben!</b> Verletzungsgefahr durch herabfallende Teile.</p> <ul style="list-style-type: none"> <li>▶ Die Komponenten gegen Herunterfallen sichern.</li> </ul>

	<b>ACHTUNG</b>
	<p><b>Risiko herabfallender Teile durch gelöste Schrauben!</b> Gefahr der Beschädigung anderer Geräteteile bzw. von Beschädigungen im Haushalt des Kunden, z. B. des Bodens.</p> <ul style="list-style-type: none"> <li>▶ Die Komponenten gegen Herunterfallen sichern.</li> </ul>

### Voraussetzung:

- ✔ Das Gerät ist spannungsfrei.
- ✔ Die Innenausstattungssteile des Geräts sind entfernt.
- ✔ Das obere Scharnier ist entfernt.

✔ Die obere Tür ist entfernt.

### 4.5.1 Ausbauen des mittleren Türscharniers

- ▶ 1. Die Kühlraumtür entfernen (1).
- ▶ 2. Die beiden Schrauben herausschrauben (2).
- ▶ 3. Das mittlere Scharnier entfernen (3).

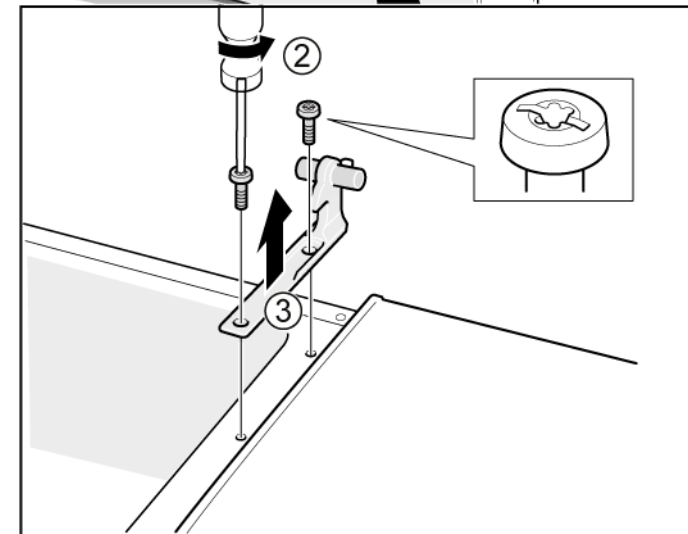
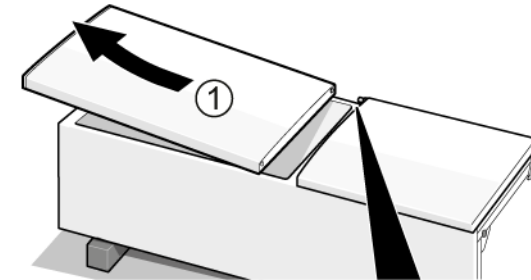

➡ Das mittlere Scharnier ist entfernt.

### 4.5.2 Einbauen des mittleren Türscharniers

- ▶ Der Einbau erfolgt in umgekehrter Reihenfolge.

## 4.6 Austauschen des unteren Türscharniers

Vorgeschlagene Hilfsmittel:

Torx-Bit TX20 6,3 mm (1/4") [00340865]

	<p><b>⚠️ WARNUNG</b></p> <p><b>Schwere, unhandliche Geräte!</b> Rücken- und Muskelverletzungen</p> <ul style="list-style-type: none"> <li>▶ Der Ausbau der Gerätetür sollte nur von geschulten Spezialisten durchgeführt werden.</li> <li>▶ Zum Bewegen des Geräts sind zwei Personen erforderlich.</li> <li>▶ Nur geeignete Werkzeuge und Vorrichtungen verwenden.</li> </ul>
	<p><b>⚠️ VORSICHT</b></p> <p><b>Scharfe Kanten!</b> Schnittverletzungen</p> <ul style="list-style-type: none"> <li>▶ Schutzhandschuhe tragen.</li> </ul>
	<p><b>⚠️ WARNUNG</b></p> <p><b>Wegrutschen des gekippten Geräts!</b> Knochenbrüche / Quetschungen</p> <ul style="list-style-type: none"> <li>▶ Gerät gegen Wegrutschen sichern.</li> </ul>
	<p><b>⚠️ VORSICHT</b></p> <p><b>Risiko herabfallender Teile durch gelöste Schrauben!</b> Verletzungsgefahr durch herabfallende Teile.</p> <ul style="list-style-type: none"> <li>▶ Die Komponenten gegen Herunterfallen sichern.</li> </ul>
	<p><b>⚠️ ACHTUNG</b></p> <p><b>Risiko herabfallender Teile durch gelöste Schrauben!</b> Gefahr der Beschädigung anderer Geräteteile bzw. von Beschädigungen im Haushalt des Kunden, z. B. des Bodens.</p> <ul style="list-style-type: none"> <li>▶ Die Komponenten gegen Herunterfallen sichern.</li> </ul>

Voraussetzung:

- ✔ Das Gerät ist spannungsfrei.
- ✔ Die Innenausstattungsstücke des Geräts sind entfernt.
- ✔ Das obere Scharnier ist entfernt.

✔ Das mittlere Scharnier ist entfernt.

### 4.6.1 Ausbauen des unteren Türscharniers

- ▶ 1. Die Gefrierraumtür entfernen (1).
- ▶ 2. Die Schraube herausschrauben (2).
- ▶ 3. Das untere Scharnier nach außen drehen (3).
- ▶ 4. Das untere Scharnier entfernen (4).

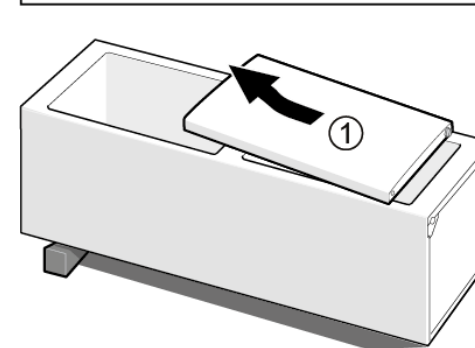
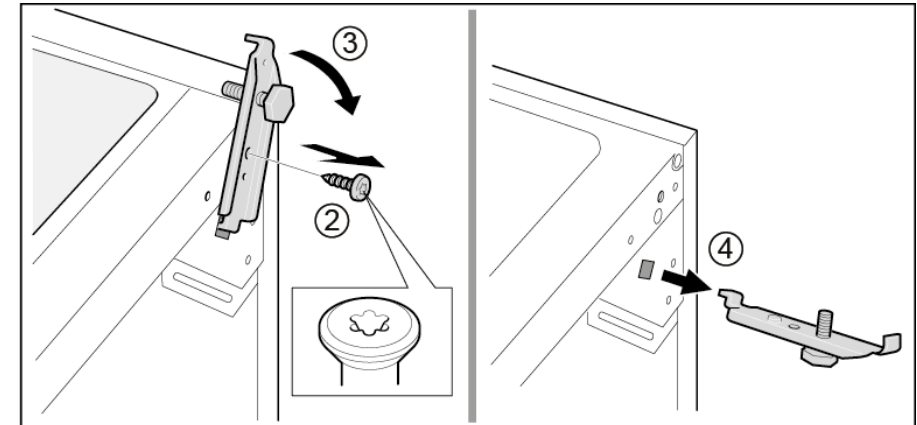

➡ Das untere Türscharnier ist entfernt.

### 4.6.2 Einbauen des unteren Türscharniers

- ▶ Der Einbau erfolgt in umgekehrter Reihenfolge.

## 4.7 Austauschen der Ablage

### Voraussetzung:

- ✔ Die Tür ist offen.

### 4.7.1 Ausbauen der Ablage

- ▶ Die Ablage herausziehen.

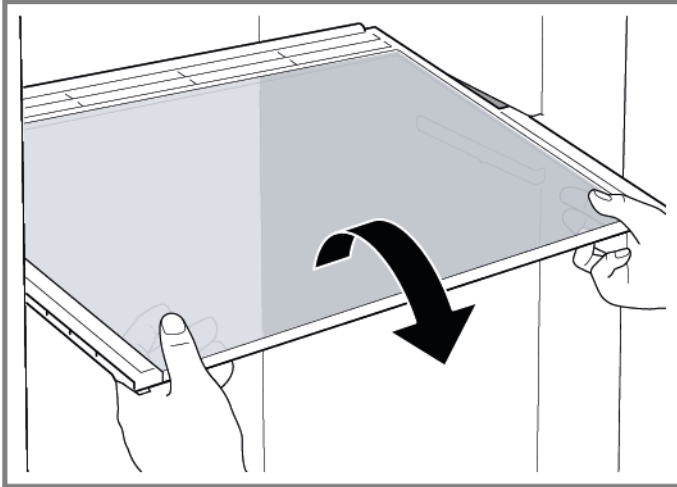

- ➡ Die Ablage ist entfernt.

### 4.7.2 Einbauen der Ablage

- ▶ Der Einbau erfolgt in umgekehrter Reihenfolge.

## 4.8 Austauschen der variablen Ablage

### Voraussetzung:

- ✔ Die Tür ist offen.

### 4.8.1 Ausbauen der variablen Ablage

1. Den rechten Teil der variablen Ablage nach vorn ziehen (1).
2. Den rechten Teil der variablen Ablage entfernen (2).

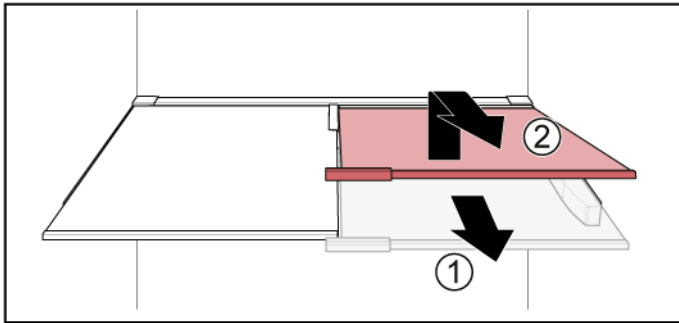

2. Den linken Teil der variablen Ablage auf die gleiche Art und Weise entfernen.

- ➡ Die variable Ablage ist entfernt.

### 4.8.2 Einbauen der variablen Ablage

- ▶ Der Einbau erfolgt in umgekehrter Reihenfolge.

## 4.9 Austauschen der variablen Ablage

### Voraussetzung:

- ✔ Die Tür ist offen.

### 4.9.1 Ausbauen der flexiblen Ablage

- ▶ 1. Das Glastablar entfernen (1).
- ▶ 2. Die flexible Ablage anheben und herausziehen (2).

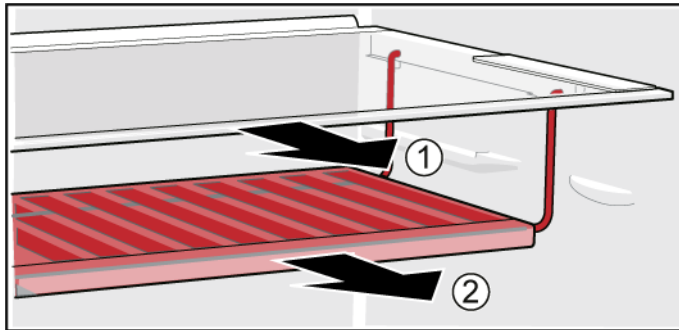

- ➡ Die flexible Ablage ist entfernt.

### 4.9.2 Einbauen der flexiblen Ablage

- ▶ Der Einbau erfolgt in umgekehrter Reihenfolge.

## 4.10 Austauschen der Frühstückstubsbox

### Voraussetzung:

- ✔ Die Tür ist offen.

### 4.10.1 Ausbauen der Frühstückstubsbox

- ▶ Die Frühstückstubsbox anheben und herausziehen.

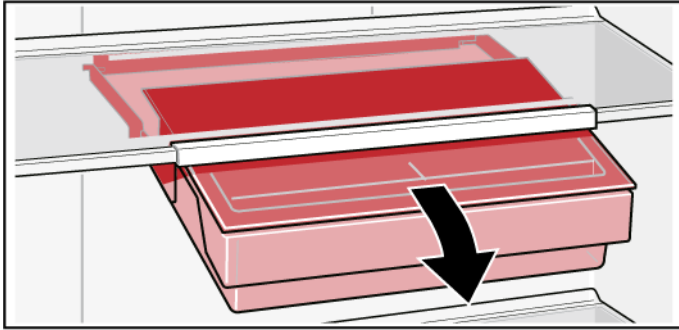

- ➡ Die Frühstückstubsbox ist entfernt.

### 4.10.2 Einbauen der Frühstückstubsbox

- ▶ Der Einbau erfolgt in umgekehrter Reihenfolge.

## 4.11 Austauschen der Flaschenablage

### Voraussetzung:

- ✔ Die Tür ist offen.

### 4.11.1 Ausbauen der Flaschenablage

- ▶ Die Flaschenablage herausziehen.

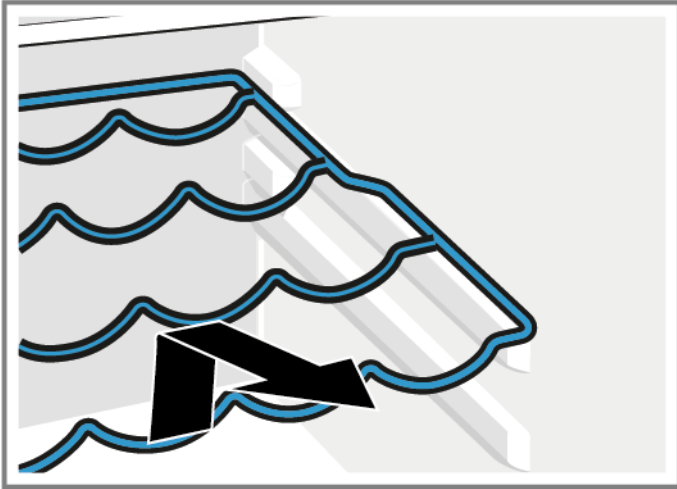

- ➡ Die Flaschenablage ist entfernt.

### 4.11.2 Einbauen der Flaschenablage

- ▶ Der Einbau erfolgt in umgekehrter Reihenfolge.

## 4.12 Austauschen des Türabstellers

### Voraussetzung:

- ✔ Die Tür ist offen.

### 4.12.1 Ausbauen des Türabstellers

- ▶ Den Türabsteller anheben.

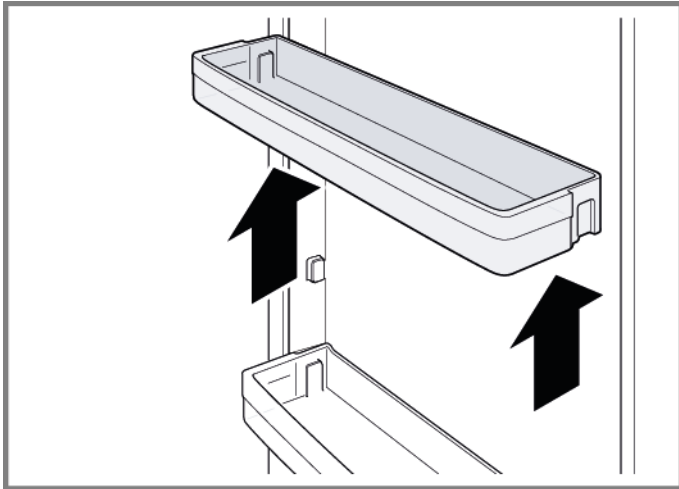

- ➡ Der Türabsteller ist entfernt.

### 4.12.2 Einbauen des Türabstellers

- ▶ Der Einbau erfolgt in umgekehrter Reihenfolge.

## 4.13 Austauschen des Gefriergutbehälters

### Voraussetzung:

- ✔ Die Tür ist offen.

### 4.13.1 Ausbauen des Gefriergutbehälters

- ▶ 1. Den Gefriergutbehälter vollständig herausziehen (1).
- ▶ 2. Den Gefriergutbehälter entfernen (2).

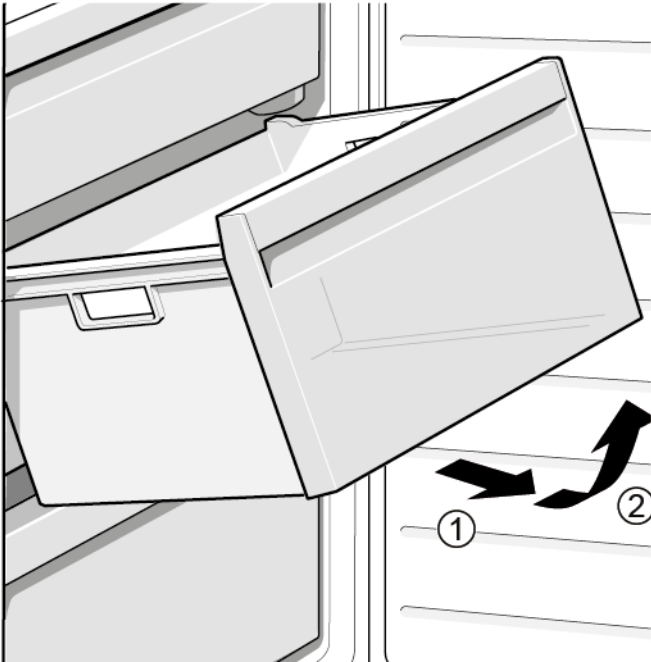

- ➡ Der Gefriergutbehälter ist entfernt.

### 4.13.2 Einbauen des Gefriergutbehälters

- ▶ Der Einbau erfolgt in umgekehrter Reihenfolge.

## 4.14 Austauschen des Behälters

### Voraussetzung:

- ✔ Die Tür ist offen.

### 4.14.1 Ausbauen des Behälters

- ▶ 1. Den unteren Kühlschrankbehälter entnehmen (1).
- ▶ 2. Den oberen Kühlschrankbehälter entnehmen (2).

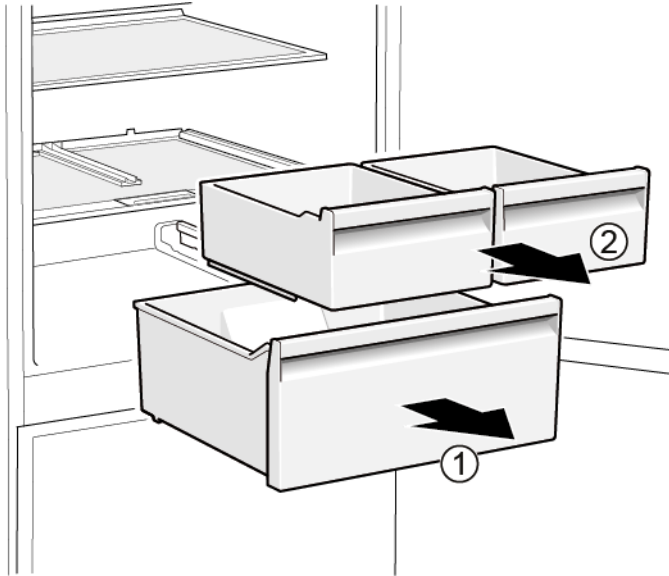

- ➡ Die Behälter sind entfernt.

### 4.14.2 Einbauen des Behälters

- ▶ Der Einbau erfolgt in umgekehrter Reihenfolge.

## 4.15 Austauschen des ausziehbaren Behälters

### Voraussetzung:

- ✔ Die Tür ist offen.

### 4.15.1 Ausbauen des ausziehbaren Behälters

- ▶ 1. Den ausziehbaren Behälter vollständig herausziehen (1).
- ▶ 2. Den ausziehbaren Behälter entfernen (2).

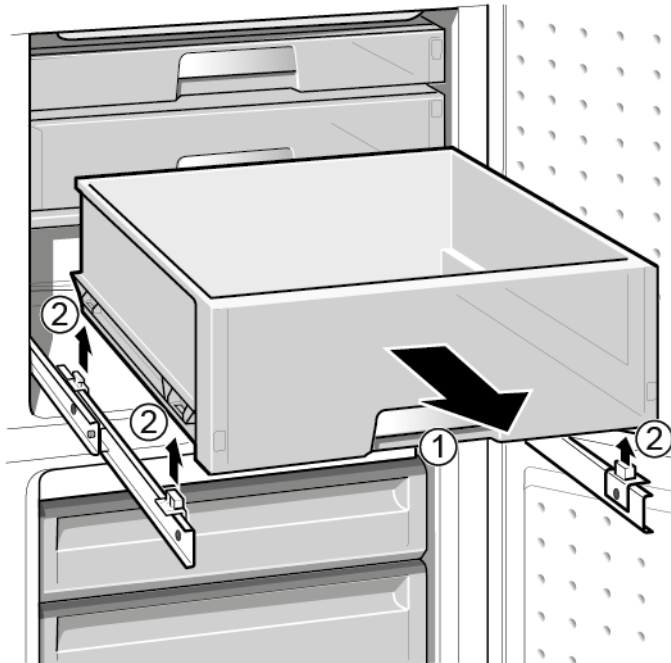

- ➡ Der ausziehbare Behälter ist entfernt.

### 4.15.2 Einbauen des ausziehbaren Behälters

- ▶ Der Einbau erfolgt in umgekehrter Reihenfolge.

## 4.16 Austauschen des LED-Strahlers

### Vorgeschlagene Hilfsmittel:

 Spezialwerkzeug

[00342180]

 Ihr Gerät ist mit einer wartungsfreien LED-Beleuchtung ausgestattet. Reparaturen an dieser Beleuchtung dürfen nur vom Kundendienst oder von autorisierten Fachkräften ausgeführt werden!

 **GEFAHR**  
**Stromschlaggefahr durch spannungsführende Teile!**  
 Lebensgefahr durch Stromschlag bei unsachgemäßer Reparatur

- ▶ Elektroteile sollten von einer Elektrofachkraft repariert werden.
- ▶ Nach der Reparatur muss eine Sicherheitsprüfung nach VDE 0701 oder länderspezifischen Vorschriften durchgeführt werden.



 **GEFAHR**  
**Stromschlaggefahr durch spannungsführende Teile!**  
 Tod durch Stromschlag

- ▶ Gerät mindestens 60 Sekunden vor Reparaturbeginn vom Netz trennen.

 **VORSICHT**  
**Scharfe Kanten!**  
 Schnittverletzungen

- ▶ Schutzhandschuhe tragen.

### Voraussetzung:

-  Das Gerät ist spannungsfrei.
-  Die Tür ist offen.

### 4.16.1 Ausbauen des LED-Strahlers

- Den LED-Strahler mithilfe von Spezialwerkzeug herausziehen (1).

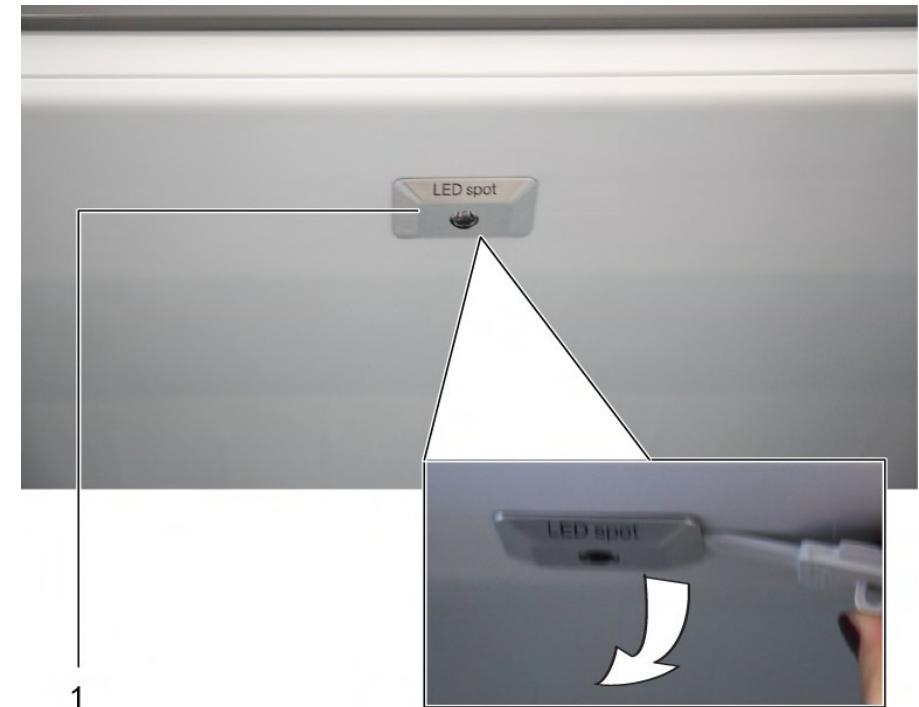

- Die elektrischen Anschlüsse des LED-Strahlers abziehen.
-  Der LED-Strahler ist entfernt.

### 4.16.2 Einbauen des LED-Strahlers

- ▶ Der Einbau erfolgt in umgekehrter Reihenfolge.

## 4.17 Austauschen des LED-Oberlichts

### Vorgeschlagene Hilfsmittel:

- 🔧 Schlitzschraubendreher Klinge 2,4 mm x 0,4 mm x 60 mm, im Set [00341820]

	Ihr Gerät ist mit einer wartungsfreien LED-Beleuchtung ausgestattet. Reparaturen an dieser Beleuchtung dürfen nur vom Kundendienst oder von autorisierten Fachkräften ausgeführt werden!
---	--

	<b>⚠️ GEFAHR</b>
	<p><b>Stromschlaggefahr durch spannungsführende Teile!</b>          Lebensgefahr durch Stromschlag bei unsachgemäßer Reparatur</p> <ul style="list-style-type: none"> <li>▶ Elektroteile sollten von einer Elektrofachkraft repariert werden.</li> <li>▶ Nach der Reparatur muss eine Sicherheitsprüfung nach VDE 0701 oder länderspezifischen Vorschriften durchgeführt werden.</li> </ul>

	<b>⚠️ GEFAHR</b>
	<p><b>Stromschlaggefahr durch spannungsführende Teile!</b>          Tod durch Stromschlag</p> <ul style="list-style-type: none"> <li>▶ Gerät mindestens 60 Sekunden vor Reparaturbeginn vom Netz trennen.</li> </ul>

	<b>⚠️ VORSICHT</b>
	<p><b>Scharfe Kanten!</b>          Schnittverletzungen</p> <ul style="list-style-type: none"> <li>▶ Schutzhandschuhe tragen.</li> </ul>

### Voraussetzung:

- ✅ Das Gerät ist spannungsfrei.
- ✅ Die Tür ist offen.
- ✅ Die oberen Innenausstattungssteile sind entfernt.

### 4.17.1 Ausbauen der LED-Beleuchtung

1. Die LED-Beleuchtung nach links schieben.

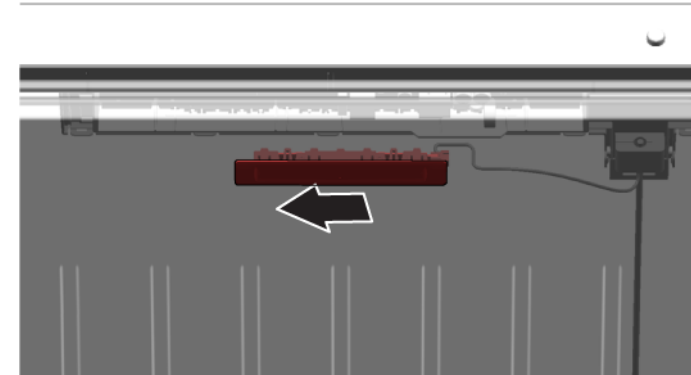

- ➡ Der elektrische Anschluss der LED-Beleuchtung ist getrennt.

2. Die Haken der LED-Beleuchtung lösen.

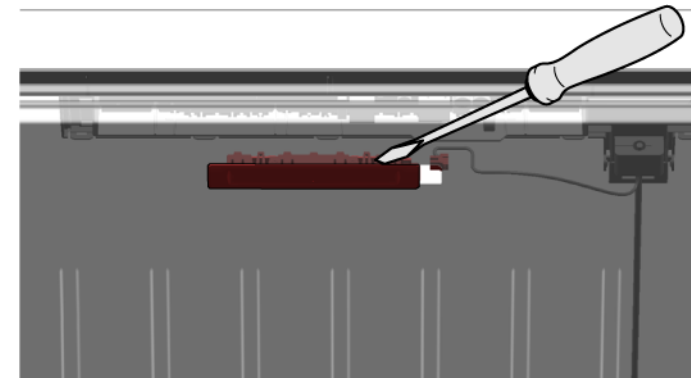

3. Die LED-Beleuchtung nach vorn entnehmen.

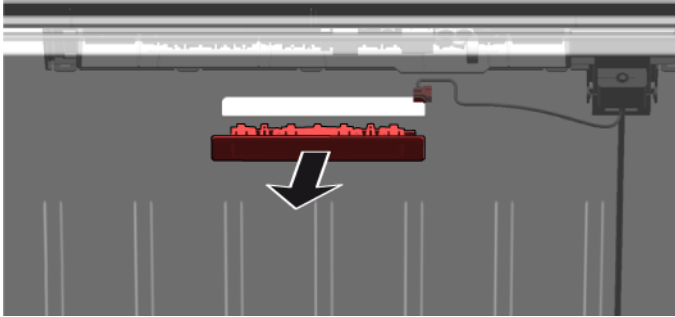

- ➡ Die LED-Beleuchtung ist entfernt.

### 4.17.2 Einbauen des LED-Oberlichts



- ▶ Der Einbau erfolgt in umgekehrter Reihenfolge.

## 4.18 Austauschen der seitlichen LED-Beleuchtung



Vorgeschlagene Hilfsmittel:

 Saugnapf Ø50 mm [00342224]



	Ihr Gerät ist mit einer wartungsfreien LED-Beleuchtung ausgestattet. Reparaturen an dieser Beleuchtung dürfen nur vom Kundendienst oder von autorisierten Fachkräften ausgeführt werden!
---	--

	<b> GEFAHR</b>
	<b>Stromschlaggefahr durch spannungsführende Teile!</b> Lebensgefahr durch Stromschlag bei unsachgemäßer Reparatur <ul style="list-style-type: none"><li>▶ Elektroteile sollten von einer Elektrofachkraft repariert werden.</li><li>▶ Nach der Reparatur muss eine Sicherheitsprüfung nach VDE 0701 oder länderspezifischen Vorschriften durchgeführt werden.</li></ul>

	<b> GEFAHR</b>
	<b>Stromschlaggefahr durch spannungsführende Teile!</b> Tod durch Stromschlag <ul style="list-style-type: none"><li>▶ Gerät mindestens 60 Sekunden vor Reparaturbeginn vom Netz trennen.</li></ul>

	<b> VORSICHT</b>
	<b>Scharfe Kanten!</b> Schnittverletzungen <ul style="list-style-type: none"><li>▶ Schutzhandschuhe tragen.</li></ul>

**Voraussetzung:**

-  Das Gerät ist spannungsfrei.
-  Die Tür ist offen.
-  Die Kühlraumablagen sind entfernt.

### 4.18.1 Ausbauen der seitlichen LED-Beleuchtung

1. Den Saugnapf im oberen Drittel der seitlichen LED-Beleuchtung befestigen.



## Instandsetzen

- Die seitliche LED-Beleuchtung mit dem Saugnapf in einer Drehbewegung nach vorn abziehen.

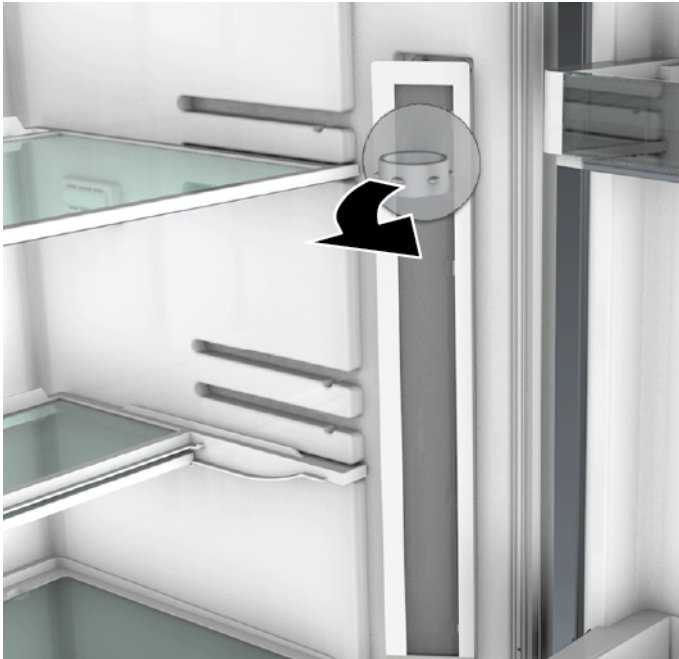





- Den elektrischen Anschluss der seitlichen LED-Beleuchtung trennen.  
➡ Die seitliche LED-Beleuchtung ist entfernt.

### 4.18.2 Einbauen der seitlichen LED-Beleuchtung

- Den elektrischen Anschluss der seitlichen LED-Beleuchtung herstellen.
  - Die seitliche LED-Beleuchtung an der entsprechenden Position an der Kühlraumwand montieren (Haken einrasten).
- ➡ Die seitliche LED-Beleuchtung ist eingebaut.

# Υποδείξεις επισκευής - Ψυγειοκαταψύκτης

 <b>Σχετικά με αυτό το έγγραφο</b> .....	<b>273</b>
1.1 Σημαντικές πληροφορίες.....	273
1.1.1 Σκοπός.....	273
1.2 Επεξήγηση συμβόλων.....	273
1.2.1 Επίπεδα κινδύνου.....	273
1.2.2 Σύμβολα κινδύνου.....	273
1.2.3 Δομή των προειδοποιήσεων.....	274
1.2.4 Γενικά σύμβολα.....	274
 <b>Ασφάλεια</b> .....	<b>275</b>
2.1 Γενικές οδηγίες ασφαλείας.....	275
2.1.1 Όλες οι οικιακές συσκευές.....	275
 <b>Εργαλεία και βοηθήματα</b> .....	<b>276</b>
 <b>Επισκευή</b> .....	<b>277</b>
4.1 Αντικατάσταση στεγανοποιητικού πόρτας.....	277
4.2 Αντικατάσταση λαβής πόρτας.....	278
4.2.1 Αφαίρεση λαβής πόρτας.....	278
4.2.2 Τοποθέτηση λαβής πόρτας.....	278
4.3 Αντικατάσταση επάνω μεντεσέ πόρτας.....	279
4.3.1 Αφαίρεση επάνω μεντεσέ πόρτας.....	279
4.3.2 Τοποθέτηση επάνω μεντεσέ πόρτας.....	280
4.4 Αντικατάσταση επάνω μεντεσέ πόρτας (πόρτα με οθόνη).....	281
4.4.1 Αφαίρεση επάνω μεντεσέ πόρτας.....	281
4.4.2 Τοποθέτηση επάνω μεντεσέ πόρτας.....	282
4.5 Αντικατάσταση μεσαίου μεντεσέ πόρτας.....	283
4.5.1 Αφαίρεση μεσαίου μεντεσέ πόρτας.....	283
4.5.2 Τοποθέτηση μεσαίου μεντεσέ πόρτας.....	283
4.6 Αντικατάσταση κάτω μεντεσέ πόρτας.....	284
4.6.1 Αφαίρεση κάτω μεντεσέ πόρτας.....	284
4.6.2 Τοποθέτηση κάτω μεντεσέ πόρτας.....	284
4.7 Αντικατάσταση ραφιού.....	285
4.7.1 Αφαίρεση ραφιού.....	285
4.7.2 Τοποθέτηση ραφιού.....	285
4.8 Αντικατάσταση ραφιού πολλαπλών χρήσεων.....	286

4.8.1 Αφαίρεση ραφιού πολλαπλών χρήσεων.....	286
4.8.2 Τοποθέτηση ραφιού πολλαπλών χρήσεων.....	286
4.9 Αντικατάσταση εύκαμπτου ραφιού.....	287
4.9.1 Αφαίρεση εύκαμπτου ραφιού.....	287
4.9.2 Τοποθέτηση εύκαμπτου ραφιού.....	287
4.10 Αντικατάσταση σετ πρωινού.....	288
4.10.1 Αφαίρεση σετ πρωινού.....	288
4.10.2 Τοποθέτηση σετ πρωινού.....	288
4.11 Αντικατάσταση επιφάνειας εναπόθεσης φιαλών.....	289
4.11.1 Αφαίρεση επιφάνειας εναπόθεσης φιαλών.....	289
4.11.2 Τοποθέτηση επιφάνειας εναπόθεσης φιαλών.....	289
4.12 Αντικατάσταση ραφιού πόρτας.....	290
4.12.1 Αφαίρεση ραφιού πόρτας.....	290
4.12.2 Τοποθέτηση ραφιού πόρτας.....	290
4.13 Αντικατάσταση συρταριού κατεψυγμένων τροφίμων.....	291
4.13.1 Αφαίρεση συρταριού κατεψυγμένων τροφίμων.....	291
4.13.2 Τοποθέτηση συρταριού κατεψυγμένων τροφίμων.....	291
4.14 Αντικατάσταση συρταριού.....	292
4.14.1 Αφαίρεση συρταριού.....	292
4.14.2 Τοποθέτηση συρταριού.....	292
4.15 Αντικατάσταση τηλεσκοπικού συρταριού.....	293
4.15.1 Αφαίρεση τηλεσκοπικού συρταριού.....	293
4.15.2 Τοποθέτηση τηλεσκοπικού συρταριού.....	293
4.16 Αντικατάσταση spot φωτισμού LED.....	294
4.16.1 Αφαίρεση spot φωτισμού LED.....	294
4.16.2 Τοποθέτηση spot φωτισμού LED.....	294
4.17 Αντικατάσταση επάνω φωτός LED.....	295
4.17.1 Αφαίρεση φωτός LED.....	295
4.17.2 Τοποθέτηση επάνω φωτισμού LED.....	296
4.18 Αντικατάσταση πλευρικής ράβδου φωτισμού LED.....	297
4.18.1 Αφαίρεση πλευρικής ράβδου φωτισμού LED.....	297
4.18.2 Τοποθέτηση πλευρικής ράβδου φωτισμού LED.....	298

# **i** Σχετικά με αυτό το έγγραφο

## 1.1 Σημαντικές πληροφορίες

### 1.1.1 Σκοπός

Αυτές οι συμβουλές επισκευών υποστηρίζουν τους καταναλωτές στην επισκευή των συσκευών από τους ίδιους, σύμφωνα με τον ισχύοντα κανονισμό οικολογικού σχεδιασμού (από τις 03/2021).





Περιέχουν πληροφορίες για την αντικατάσταση ορισμένων ανταλλακτικών, συμπεριλαμβανομένων προειδοποιήσεων και κινδύνων.

Σε περίπτωση ερωτήσεων, επικοινωνήστε με το τμήμα εξυπηρέτησης πελατών της εταιρείας μας. Φέρουμε ευθύνη για τις ζημιές εάν οι συμβουλές επισκευής έχουν ακολουθηθεί σωστά.

## 1.2 Επεξήγηση συμβόλων

### 1.2.1 Επίπεδα κινδύνου

Τα επίπεδα προειδοποίησης ασφάλειας αποτελούνται από ένα σύμβολο και μια λέξη. Η λέξη προειδοποίησης προσδιορίζει τη σοβαρότητα του κινδύνου.





Επίπεδο προειδοποίησης	Σημασία
 <b>ΚΙΝΔΥΝΟΣ</b>	Η μη τήρηση του προειδοποιητικού μηνύματος θα οδηγήσει σε θάνατο ή σε σοβαρούς τραυματισμούς.
 <b>ΠΡΟΕΙΔΟΠΟΙΗΣΗ</b>	Η μη τήρηση του προειδοποιητικού μηνύματος θα μπορούσε να οδηγήσει σε θάνατο ή σε σοβαρούς τραυματισμούς.
 <b>ΠΡΟΣΟΧΗ</b>	Η μη τήρηση του προειδοποιητικού μηνύματος θα μπορούσε να οδηγήσει σε μικρούς τραυματισμούς.
 <b>ΠΡΟΣΟΧΗ!</b>	Η μη τήρηση του προειδοποιητικού μηνύματος θα μπορούσε να οδηγήσει σε υλικές ζημιές της ιδιοκτησίας.

Πίνακας 1: Επίπεδα κινδύνου





### 1.2.2 Σύμβολα κινδύνου

Τα σύμβολα κινδύνου είναι συμβολικές αναπαραστάσεις που δίνουν μια ένδειξη για το είδος του κινδύνου.

Τα ακόλουθα σύμβολα κινδύνου χρησιμοποιούνται στο παρόν έγγραφο:

Σύμβολο κινδύνου	Σημασία
	Γενικό προειδοποιητικό μήνυμα
	Κίνδυνος από ηλεκτρική τάση
	Κίνδυνος έκρηξης
	Κίνδυνος κοψίματος

## **i** Σχετικά με αυτό το έγγραφο

Σύμβολο κινδύνου	Σημασία
	Κίνδυνος σύνθλιψης
	Κίνδυνος από καυτές επιφάνειες
	Κίνδυνος από ισχυρό μαγνητικό πεδίο
	Κίνδυνος από μη ιονίζουσα ακτινοβολία

Πίνακας 2: Σύμβολα κινδύνου

### 1.2.3 Δομή των προειδοποιήσεων

.Οι προειδοποιήσεις σε αυτό το έγγραφο έχουν μια τυποποιημένη εμφάνιση και μια τυποποιημένη δομή.











	<b>⚠ ΚΙΝΔΥΝΟΣ</b>
<b>Είδος και πηγή κινδύνου!</b>	
Πιθανές συνέπειες εάν αγνοήσετε τον κίνδυνο/την προειδοποίηση.	
▶ Μέτρα και απαγορεύσεις για την πρόληψη του κινδύνου.	

Το παρακάτω παράδειγμα δείχνει μια προειδοποίηση που προειδοποιεί κατά της ηλεκτροπληξίας λόγω ηλεκτροφόρων μερών. Αναφέρεται το μέτρο για την αποφυγή του κινδύνου.

	<b>⚠ ΚΙΝΔΥΝΟΣ</b>
<b>Κίνδυνος ηλεκτροπληξίας λόγω ηλεκτροφόρων μερών!</b>	
Θάνατος από ηλεκτροπληξία	
▶ Αποσυνδέετε τις συσκευές από την παροχή ηλεκτρικού ρεύματος τουλάχιστον 60 δευτερόλεπτα πριν ξεκινήσετε τις επισκευές.	

### 1.2.4 Γενικά σύμβολα

Τα ακόλουθα γενικά σύμβολα χρησιμοποιούνται στο παρόν έγγραφο:

Γεν. σύμβολο	Σημασία
	Ταυτοποίηση μιας ειδικής συμβουλής (κειμένου ή/και γραφικών)
	Ταυτοποίηση μιας ειδικής συμβουλής (μόνο κειμένου)
	Ταυτοποίηση συνδέσμου ή εκπαιδευτικού βίντεο
	Ταυτοποίηση απαραίτητων εργαλείων
	Ταυτοποίηση απαραίτητων προϋποθέσεων
	Ταυτοποίηση μιας συνθήκης (αν ..., κατόπιν ...)
	Ταυτοποίηση αποτελέσματος
	Ταυτοποίηση ενός πλήκτρου ή κουμπιού
	Ταυτοποίηση ενός κωδικού ανταλλακτικού
	Ταυτοποίηση εμφανιζόμενου κειμένου/παραθύρου (στην οθόνη της συσκευής)

Πίνακας 3: Γενικά σύμβολα

## 2.1 Γενικές οδηγίες ασφαλείας

### 2.1.1 Όλες οι οικιακές συσκευές

#### **Κίνδυνος ηλεκτροπληξίας λόγω ηλεκτροφόρων μερών!**

- Τα σφάλματα από επισκευές σε ηλεκτρικά εξαρτήματα μπορεί να προκαλέσουν ηλεκτροπληξία!
- Αποσυνδέστε τη συσκευή από την πρίζα για τουλάχιστον 60 δευτερόλεπτα πριν από την έναρξη των εργασιών.
- Μετά την επισκευή πραγματοποιήστε έλεγχο ασφαλείας σύμφωνα με το VDE 0701 ή κανονισμούς της συγκεκριμένης χώρας.

#### **Κίνδυνος τραυματισμού από κοφτερές άκρες!**

- Φοράτε προστατευτικά γάντια.

#### **Κίνδυνος σύνθλιψης κατά την επισκευή, συντήρηση, αντιμετώπιση προβλημάτων και το σέρβις από βαριά και κινούμενα μέρη**

- Φοράτε προστατευτικά υποδήματα.
- Ασφαλίστε τα βαριά μέρη από πτώση.
- Μην προσαρτάτε μέρη του πλαισίου στα κινούμενα μέρη.

#### **Κίνδυνος για την ασφάλεια/τη λειτουργία της συσκευής!**

- Χρησιμοποιείτε μόνο γνήσια ανταλλακτικά.

#### **Κίνδυνος πρόκλησης βλάβης σε μέρη ευαίσθητα στον στατικό ηλεκτρισμό (ESDs)!**

- Μην αγγίζετε τις μονάδες, συμπεριλαμβανομένων των συνδέσεων και των αγωγών των πλακετών.

## Εργαλεία και βοηθήματα

Όνομασία	Λεπτομέριες	Εικόνες
Πανάκι προστασίας [00342013]	60 cm x 50 cm	
Σετ κατσαβιδιών ακριβείας [00341820]	9 τεμάχια, 2,0 mm, 2,4 mm, 3,0 mm, PH0, PH00, PH1, TX6, TX8, TX9	
Βοηθητικό εργαλείο [00342180]	Εργαλείο λυσίματος πλαστικών τμημάτων, "magic tool"	
Βεντούζα [00342224]	Ø 50 mm	
Μύτη Torx TX20 [00340865]	6,3 mm (1/4")	
Πλακέ κατσαβίδι	Λεπίδα 10 mm x 1,6 mm x 200 mm	



#### **4.1 Αντικατάσταση στεγανοποιητικού πόρτας**

**Προϋπόθεση:**



- Η πόρτα είναι ανοιχτή.

## 4.2 Αντικατάσταση λαβής πόρτας

### Προτεινόμενα εργαλεία:

-  Μύτη Torx TX20                      6,3 mm (1/4")                      [00340865]
-  Πλακέ κατσαβίδι                      Λεπίδα 10 mm x 1,6 mm x 200 mm

### Προϋπόθεση:

-  Η συσκευή είναι αποσυνδεδεμένη από την παροχή τροφοδοσίας.
-  Η πόρτα είναι ανοιχτή.

### 4.2.1 Αφαίρεση λαβής πόρτας

- ▶ 1. Αφαιρέστε τα δύο πώματα βίδας (1).
- ▶ 2. Ξεβιδώστε δύο βίδες (2).
- ▶ 3. Αφαιρέστε τη λαβή της πόρτας (3).

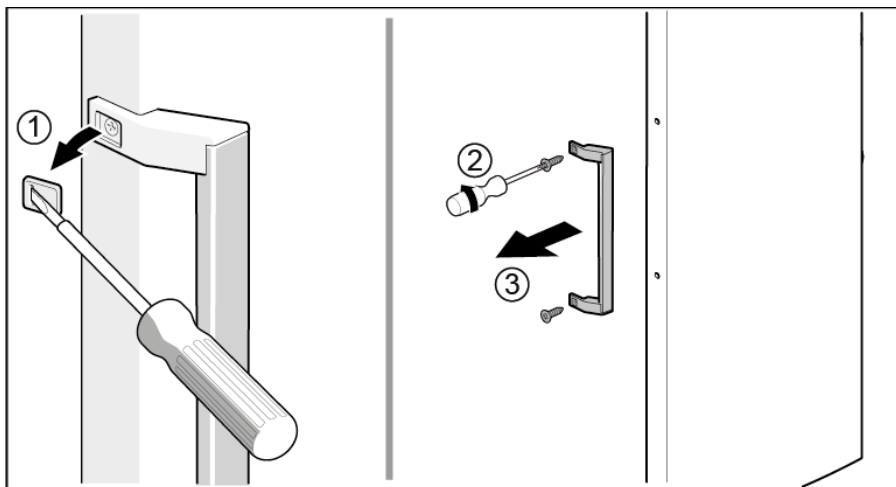

 Η λαβή της πόρτας έχει αφαιρεθεί.



Η λαβή πόρτας για τη δεύτερη πόρτα μπορεί να αφαιρεθεί με τον ίδιο τρόπο.

### 4.2.2 Τοποθέτηση λαβής πόρτας

- ▶ Εγκαταστήστε με την αντίθετη σειρά.

### 4.3 Αντικατάσταση επάνω μεντεσέ πόρτας

Προτεινόμενα εργαλεία:

 Μύτη Torx TX20      6,3 mm (1/4")      [00340865]

	<p style="text-align: center;"><b>⚠ ΠΡΟΕΙΔΟΠΟΙΗΣΗ</b></p> <p><b>Βαριές, ογκώδεις συσκευές!</b> Τραυματισμοί μέσης και μυών</p> <ul style="list-style-type: none"> <li>▶ Η διαδικασία αφαίρεσης της πόρτας της συσκευής πρέπει να εκτελείται μόνο από εκπαιδευμένους ειδικούς.</li> <li>▶ Η μετακίνηση της συσκευής πρέπει να εκτελείται από δύο άτομα.</li> <li>▶ Χρησιμοποιείτε μόνο κατάλληλα εργαλεία και εξοπλισμό.</li> </ul>
--	--



	<p style="text-align: center;"><b>⚠ ΠΡΟΣΟΧΗ</b></p> <p><b>Αιχμηρές ακμές!</b> Τραυματισμοί από κοπή</p> <ul style="list-style-type: none"> <li>▶ Φοράτε προστατευτικά γάντια.</li> </ul>
--	--

	<p style="text-align: center;"><b>⚠ ΠΡΟΕΙΔΟΠΟΙΗΣΗ</b></p> <p><b>Ολίσθηση κεκλιμένων συσκευών!</b> Κατάγματα οστών/τραυματισμοί σύνθλιψης</p> <ul style="list-style-type: none"> <li>▶ Ασφαλίστε τις συσκευές από ολίσθηση.</li> </ul>
--	---

	<p style="text-align: center;"><b>⚠ ΠΡΟΣΟΧΗ</b></p> <p><b>Κίνδυνοι από πτώση μερών εξαιτίας χαλαρών βιδών!</b> Τραυματισμός εξαιτίας πτώσης τμημάτων.</p> <ul style="list-style-type: none"> <li>▶ Ασφαλίστε τα εξαρτήματα από πτώση.</li> </ul>
---	--

	<p style="text-align: center;"><b>ΠΡΟΣΟΧΗ!</b></p> <p><b>Κίνδυνων από πτώση εξαρτημάτων εξαιτίας χαλαρών βιδών!</b> Ζημιά σε άλλα μέρη της συσκευής ή στην οικία του πελάτη, π.χ. δάπεδο.</p> <ul style="list-style-type: none"> <li>▶ Ασφαλίστε τα εξαρτήματα από πτώση.</li> </ul>
--	--

Προϋπόθεση:

-  Η συσκευή είναι αποσυνδεδεμένη από την παροχή τροφοδοσίας.
-  Αφαιρούνται τα εσωτερικά εξαρτήματα συσκευής.

#### 4.3.1 Αφαίρεση επάνω μεντεσέ πόρτας

1. Τοποθετήστε τη συσκευή στην πίσω πλευρά.

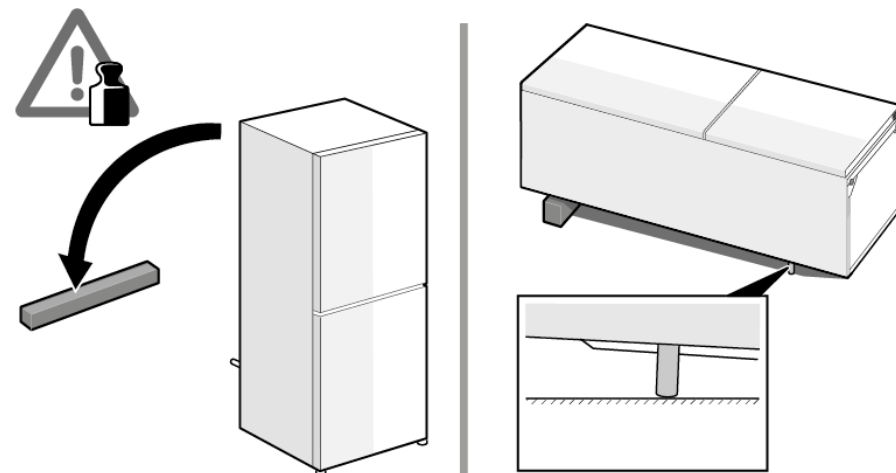

1. Πιέστε το επάνω κάλυμμα μεντεσέ και στις δύο πλευρές (1).
2. Μετακινήστε και αφαιρέστε το κάλυμμα επάνω μεντεσέ (2).
3. Περιστρέψτε το κάλυμμα μεντεσέ (3).
4. Αφαιρέστε το κάλυμμα επάνω μεντεσέ (4).
5. Ξεβιδώστε δύο βίδες (5).
6. Αφαιρέστε τον επάνω μεντεσέ (6).

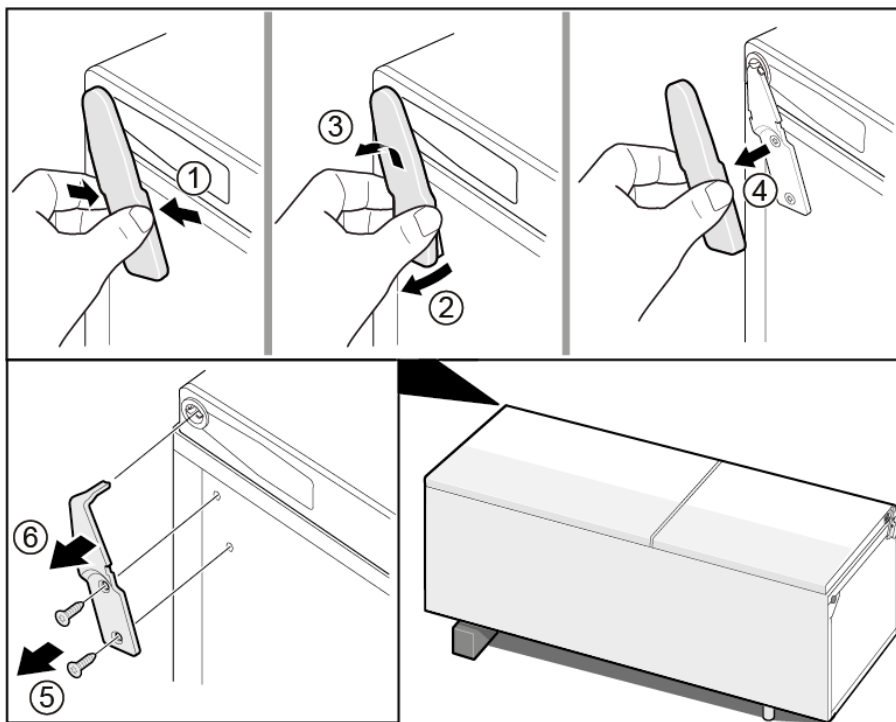

 Ο επάνω μεντεσές έχει αφαιρεθεί.

### 4.3.2 Τοποθέτηση επάνω μεντεσέ πόρτας

- ▶ Εγκαταστήστε με την αντίθετη σειρά.

#### 4.4 Αντικατάσταση επάνω μεντεσέ πόρτας (πόρτα με θόνη)

Προτεινόμενα εργαλεία:

 Μύτη Torx TX20      6,3 mm (1/4")      [00340865]

	<b>⚠ ΠΡΟΕΙΔΟΠΟΙΗΣΗ</b>
	<p><b>Βαριές, ογκώδεις συσκευές!</b> Τραυματισμοί μέσης και μυών</p> <ul style="list-style-type: none"> <li>▶ Η διαδικασία αφαίρεσης της πόρτας της συσκευής πρέπει να εκτελείται μόνο από εκπαιδευμένους ειδικούς.</li> <li>▶ Η μετακίνηση της συσκευής πρέπει να εκτελείται από δύο άτομα.</li> <li>▶ Χρησιμοποιείτε μόνο κατάλληλα εργαλεία και εξοπλισμό.</li> </ul>

	<b>⚠ ΠΡΟΣΟΧΗ</b>
	<p><b>Αιχμηρές ακμές!</b> Τραυματισμοί από κοπή</p> <ul style="list-style-type: none"> <li>▶ Φοράτε προστατευτικά γάντια.</li> </ul>

	<b>⚠ ΠΡΟΕΙΔΟΠΟΙΗΣΗ</b>
	<p><b>Ολίσθηση κεκλιμένων συσκευών!</b> Κατάγματα οστών/τραυματισμοί σύνθλιψης</p> <ul style="list-style-type: none"> <li>▶ Ασφαλίστε τις συσκευές από ολίσθηση.</li> </ul>



	<b>⚠ ΠΡΟΣΟΧΗ</b>
	<p><b>Κίνδυνοι από πτώση μερών εξαιτίας χαλαρών βιδών!</b> Τραυματισμός εξαιτίας πτώσης τμημάτων.</p> <ul style="list-style-type: none"> <li>▶ Ασφαλίστε τα εξαρτήματα από πτώση.</li> </ul>

	<b>ΠΡΟΣΟΧΗ!</b>
	<p><b>Κίνδυνων από πτώση εξαρτημάτων εξαιτίας χαλαρών βιδών!</b> Ζημιά σε άλλα μέρη της συσκευής ή στην οικία του πελάτη, π.χ. δάπεδο.</p> <ul style="list-style-type: none"> <li>▶ Ασφαλίστε τα εξαρτήματα από πτώση.</li> </ul>

	<b>⚠ ΚΙΝΔΥΝΟΣ</b>
	<p><b>Κίνδυνος ηλεκτροπληξίας λόγω ηλεκτροφόρων μερών!</b> Κίνδυνος για τη ζωή από ηλεκτροπληξία σε περίπτωση ακατάλληλης επισκευής</p> <ul style="list-style-type: none"> <li>▶ Τα ηλεκτρικά μέρη πρέπει να επισκευάζονται από εκπαιδευμένους ηλεκτρολόγους.</li> <li>▶ Μετά την επισκευή πραγματοποιήστε έλεγχο ασφαλείας σύμφωνα με το VDE 0701 ή κανονισμούς της συγκεκριμένης χώρας.</li> </ul>

	<b>⚠ ΚΙΝΔΥΝΟΣ</b>
	<p><b>Κίνδυνος ηλεκτροπληξίας λόγω ηλεκτροφόρων μερών!</b> Θάνατος από ηλεκτροπληξία</p> <ul style="list-style-type: none"> <li>▶ Αποσυνδέετε τις συσκευές από την παροχή ηλεκτρικού ρεύματος τουλάχιστον 60 δευτερόλεπτα πριν ξεκινήσετε τις επισκευές.</li> </ul>

**Προϋπόθεση:**

-  Η συσκευή είναι αποσυνδεδεμένη από την παροχή τροφοδοσίας.
-  Αφαιρούνται τα εσωτερικά εξαρτήματα συσκευής.

##### 4.4.1 Αφαίρεση επάνω μεντεσέ πόρτας

1. Τοποθετήστε τη συσκευή στην πίσω πλευρά.

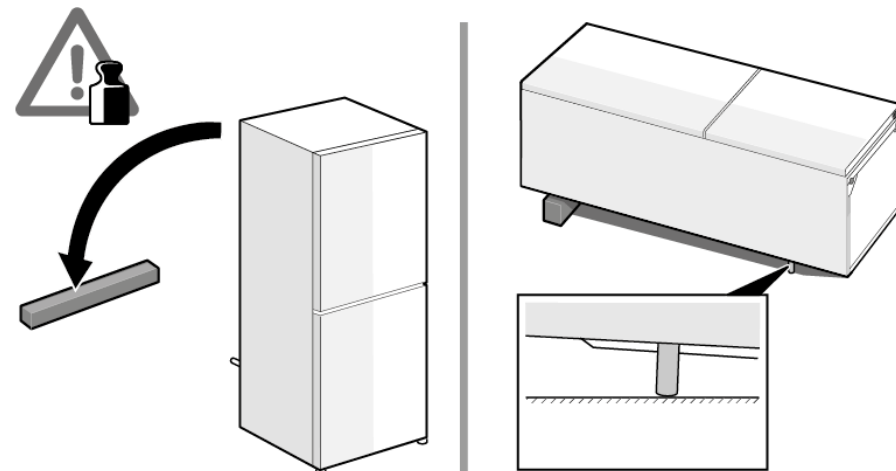

2. 1. Αφαιρέστε το κάλυμμα επάνω μεντεσέ (1).
2. Αφαιρέστε το κάλυμμα του κουτιού καλωδίων (2).
3. Αποσυνδέστε την ηλεκτρική σύνδεση (3).
4. Ξεβιδώστε τη βίδα σύνδεσης γείωσης (4).
5. Αφαιρέστε την προστασία καλωδίων (5).
6. Ξεβιδώστε τη βίδα (6).

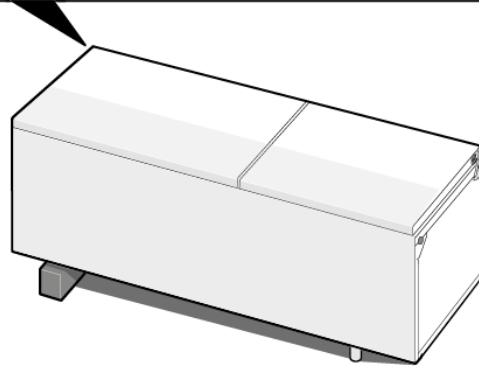
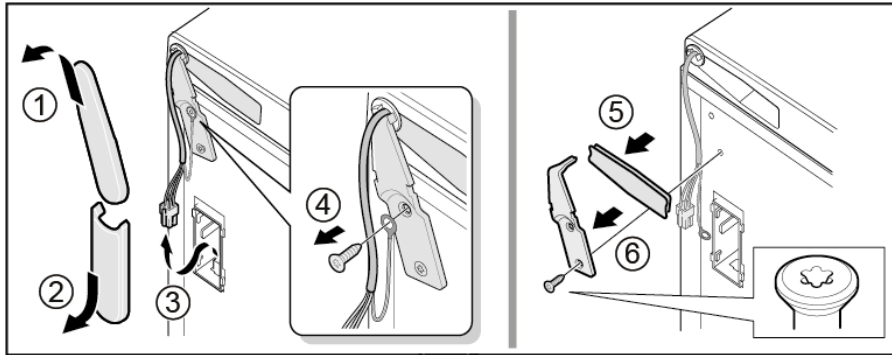

 Ο επάνω μεντεσές έχει αφαιρεθεί.

#### 4.4.2 Τοποθέτηση επάνω μεντεσέ πόρτας

- ▶ Εγκαταστήστε με την αντίθετη σειρά.

## 4.5 Αντικατάσταση μεσαίου μεντεσέ πόρτας

Προτεινόμενα εργαλεία:

 Μύτη Torx TX20      6,3 mm (1/4")      [00340865]

	<b>⚠ ΠΡΟΕΙΔΟΠΟΙΗΣΗ</b>
	<p><b>Βαριές, ογκώδεις συσκευές!</b> Τραυματισμοί μέσης και μυών</p> <ul style="list-style-type: none"> <li>▶ Η διαδικασία αφαίρεσης της πόρτας της συσκευής πρέπει να εκτελείται μόνο από εκπαιδευμένους ειδικούς.</li> <li>▶ Η μετακίνηση της συσκευής πρέπει να εκτελείται από δύο άτομα.</li> <li>▶ Χρησιμοποιείτε μόνο κατάλληλα εργαλεία και εξοπλισμό.</li> </ul>





	<b>⚠ ΠΡΟΣΟΧΗ</b>
	<p><b>Αιχμηρές ακμές!</b> Τραυματισμοί από κοπή</p> <ul style="list-style-type: none"> <li>▶ Φοράτε προστατευτικά γάντια.</li> </ul>

	<b>⚠ ΠΡΟΕΙΔΟΠΟΙΗΣΗ</b>
	<p><b>Ολίσθηση κεκλιμένων συσκευών!</b> Κατάγματα οστών/τραυματισμοί σύνθλιψης</p> <ul style="list-style-type: none"> <li>▶ Ασφαλίστε τις συσκευές από ολίσθηση.</li> </ul>

	<b>⚠ ΠΡΟΣΟΧΗ</b>
	<p><b>Κίνδυνοι από πτώση μερών εξαιτίας χαλαρών βιδών!</b> Τραυματισμός εξαιτίας πτώσης τμημάτων.</p> <ul style="list-style-type: none"> <li>▶ Ασφαλίστε τα εξαρτήματα από πτώση.</li> </ul>

	<b>ΠΡΟΣΟΧΗ!</b>
	<p><b>Κίνδυνων από πτώση εξαρτημάτων εξαιτίας χαλαρών βιδών!</b> Ζημιά σε άλλα μέρη της συσκευής ή στην οικία του πελάτη, π.χ. δάπεδο.</p> <ul style="list-style-type: none"> <li>▶ Ασφαλίστε τα εξαρτήματα από πτώση.</li> </ul>

Προϋπόθεση:

-  Η συσκευή είναι αποσυνδεδεμένη από την παροχή τροφοδοσίας.
-  Αφαιρούνται τα εσωτερικά εξαρτήματα συσκευής.
-  Ο επάνω μεντεσές της πόρτας έχει αφαιρεθεί.
-  Η επάνω πόρτα έχει αφαιρεθεί.

### 4.5.1 Αφαίρεση μεσαίου μεντεσέ πόρτας

- ▶ 1. Αφαιρέστε την πόρτα χώρου ψυγείου (1).
- ▶ 2. Ξεβιδώστε δύο βίδες (2).
- ▶ 3. Αφαιρέστε τον μεσαίο μεντεσέ (3).

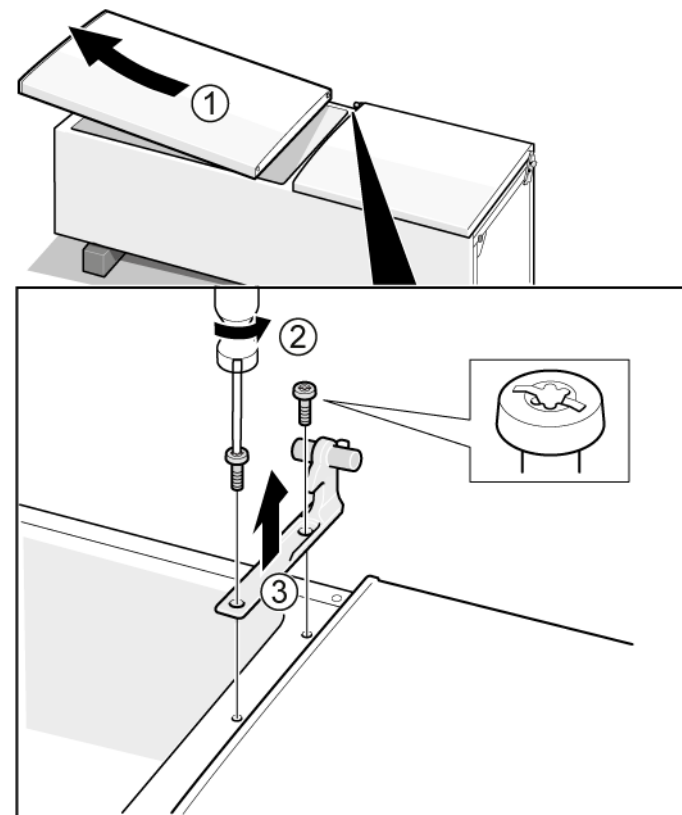

 Ο μεσαίος μεντεσές έχει αφαιρεθεί.

### 4.5.2 Τοποθέτηση μεσαίου μεντεσέ πόρτας

- ▶ Εγκαταστήστε με την αντίθετη σειρά.

## 4.6 Αντικατάσταση κάτω μεντεσέ πόρτας

Προτεινόμενα εργαλεία:

 Μύτη Torx TX20      6,3 mm (1/4")      [00340865]

	<b>⚠ ΠΡΟΕΙΔΟΠΟΙΗΣΗ</b>
	<p><b>Βαριές, ογκώδεις συσκευές!</b> Τραυματισμοί μέσης και μυών</p> <ul style="list-style-type: none"> <li>▶ Η διαδικασία αφαίρεσης της πόρτας της συσκευής πρέπει να εκτελείται μόνο από εκπαιδευμένους ειδικούς.</li> <li>▶ Η μετακίνηση της συσκευής πρέπει να εκτελείται από δύο άτομα.</li> <li>▶ Χρησιμοποιείτε μόνο κατάλληλα εργαλεία και εξοπλισμό.</li> </ul>





	<b>⚠ ΠΡΟΣΟΧΗ</b>
	<p><b>Αιχμηρές ακμές!</b> Τραυματισμοί από κοπή</p> <ul style="list-style-type: none"> <li>▶ Φοράτε προστατευτικά γάντια.</li> </ul>

	<b>⚠ ΠΡΟΕΙΔΟΠΟΙΗΣΗ</b>
	<p><b>Ολίσθηση κεκλιμένων συσκευών!</b> Κατάγματα οστών/τραυματισμοί σύνθλιψης</p> <ul style="list-style-type: none"> <li>▶ Ασφαλίστε τις συσκευές από ολίσθηση.</li> </ul>

	<b>⚠ ΠΡΟΣΟΧΗ</b>
	<p><b>Κίνδυνοι από πτώση μερών εξαιτίας χαλαρών βιδών!</b> Τραυματισμός εξαιτίας πτώσης τμημάτων.</p> <ul style="list-style-type: none"> <li>▶ Ασφαλίστε τα εξαρτήματα από πτώση.</li> </ul>

	<b>ΠΡΟΣΟΧΗ!</b>
	<p><b>Κίνδυνων από πτώση εξαρτημάτων εξαιτίας χαλαρών βιδών!</b> Ζημιά σε άλλα μέρη της συσκευής ή στην οικία του πελάτη, π.χ. δάπεδο.</p> <ul style="list-style-type: none"> <li>▶ Ασφαλίστε τα εξαρτήματα από πτώση.</li> </ul>

Προϋπόθεση:

-  Η συσκευή είναι αποσυνδεδεμένη από την παροχή τροφοδοσίας.
-  Αφαιρούνται τα εσωτερικά εξαρτήματα συσκευής.
-  Ο επάνω μεντεσές έχει αφαιρεθεί.
-  Ο μεσαίος μεντεσές έχει αφαιρεθεί.

### 4.6.1 Αφαίρεση κάτω μεντεσέ πόρτας

- ▶ 1. Αφαιρέστε την πόρτα χώρου κατάψυξης (1).
- ▶ 2. Ξεβιδώστε τη βίδα (2).
- ▶ 3. Γυρίστε τον κάτω μεντεσέ προς τα έξω (3).
- ▶ 4. Αφαιρέστε τον κάτω μεντεσέ (4).

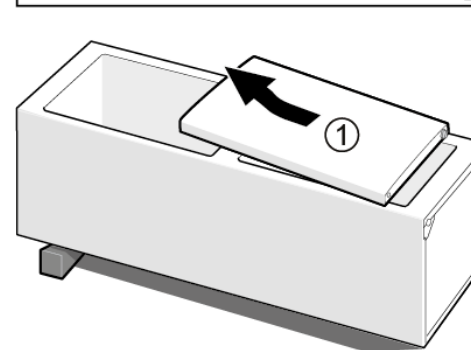
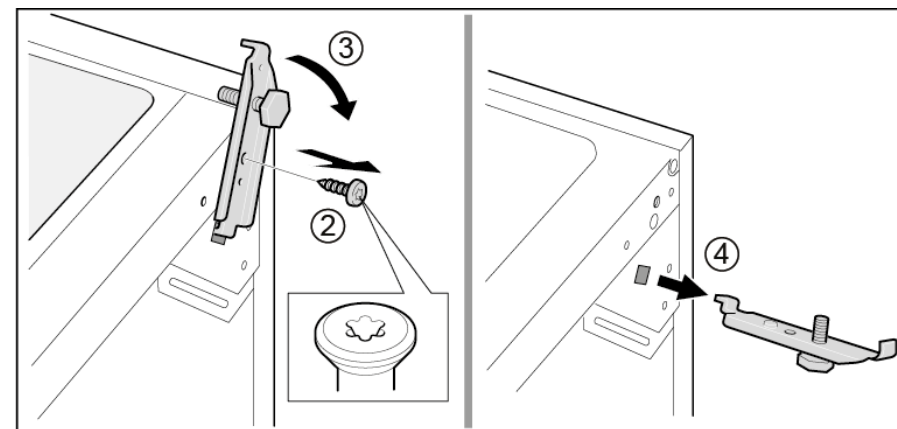

 Ο κάτω μεντεσές πόρτας έχει αφαιρεθεί.

### 4.6.2 Τοποθέτηση κάτω μεντεσέ πόρτας

- ▶ Εγκαταστήστε με την αντίθετη σειρά.

## 4.7 Αντικατάσταση ραφιού

Προϋπόθεση:

- ✔ Η πόρτα είναι ανοιχτή.

### 4.7.1 Αφαίρεση ραφιού

- ▶ Τραβήξτε το ράφι προς τα έξω.

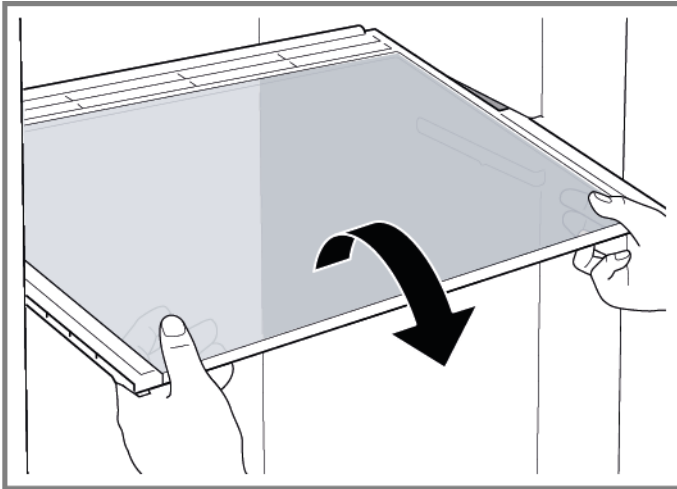

- ➡ Το ράφι αφαιρέθηκε.

### 4.7.2 Τοποθέτηση ραφιού

- ▶ Εγκαταστήστε με την αντίθετη σειρά.

## 4.8 Αντικατάσταση ραφιού πολλαπλών χρήσεων

Προϋπόθεση:

- ✔ Η πόρτα είναι ανοιχτή.

### 4.8.1 Αφαίρεση ραφιού πολλαπλών χρήσεων

1. Τραβήξτε το δεξί τμήμα του ραφιού πολλαπλών χρήσεων προς τα εμπρός (1).
2. Αφαιρέστε το δεξί τμήμα του ραφιού πολλαπλών χρήσεων (2).

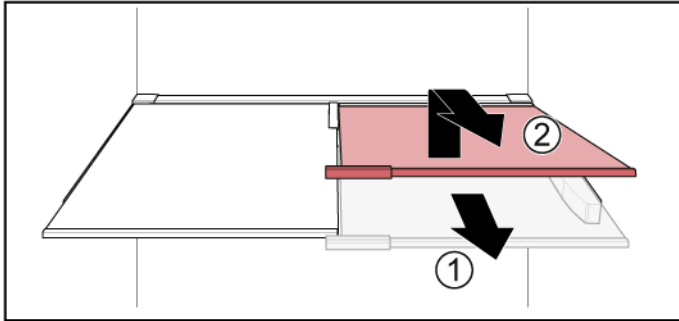

2. Αφαιρέστε το αριστερό τμήμα του ραφιού πολλαπλών χρήσεων με τον ίδιο τρόπο.

➡ Το ράφι πολλαπλών χρήσεων αφαιρέθηκε.

### 4.8.2 Τοποθέτηση ραφιού πολλαπλών χρήσεων

- ▶ Εγκαταστήστε με την αντίθετη σειρά.

## 4.9 Αντικατάσταση εύκαμπτου ραφιού

Προϋπόθεση:

- ✔ Η πόρτα είναι ανοιχτή.

### 4.9.1 Αφαίρεση εύκαμπτου ραφιού

- ▶ 1. Αφαιρέστε το γυάλινο ράφι (1).
- ▶ 2. Σηκώστε το εύκαμπτο ράφι και τραβήξτε το προς τα έξω (2).

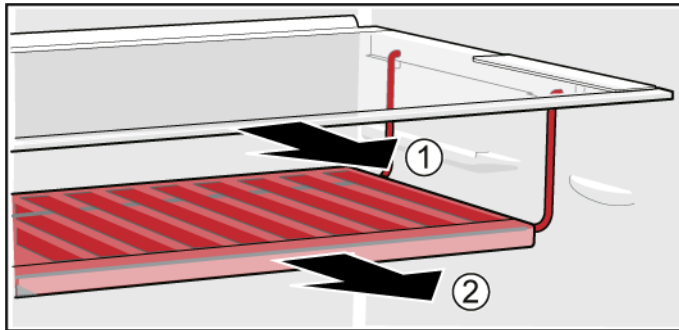

- ➡ Το εύκαμπτο ράφι αφαιρέθηκε.

### 4.9.2 Τοποθέτηση εύκαμπτου ραφιού

- ▶ Εγκαταστήστε με την αντίθετη σειρά.

## 4.10 Αντικατάσταση σετ πρωινού

Προϋπόθεση:

- ✔ Η πόρτα είναι ανοιχτή.

### 4.10.1 Αφαίρεση σετ πρωινού

- ▶ Σηκώστε το σετ πρωινού και τραβήξτε το έξω.

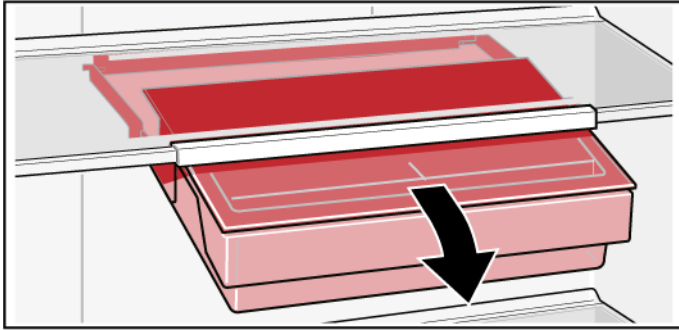

- ➡ Το σετ πρωινού αφαιρέθηκε.

### 4.10.2 Τοποθέτηση σετ πρωινού

- ▶ Εγκαταστήστε με την αντίθετη σειρά.

## 4.11 Αντικατάσταση επιφάνειας εναπόθεσης φιαλών

Προϋπόθεση:

- ✔ Η πόρτα είναι ανοιχτή.

### 4.11.1 Αφαίρεση επιφάνειας εναπόθεσης φιαλών

- ▶ Τραβήξτε προς τα έξω την επιφάνεια εναπόθεσης φιαλών.

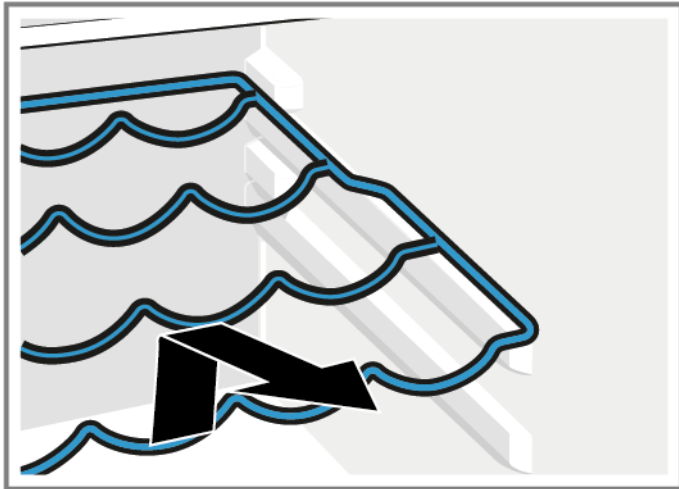

- ➡ Η επιφάνεια εναπόθεσης φιαλών έχει αφαιρεθεί.

### 4.11.2 Τοποθέτηση επιφάνειας εναπόθεσης φιαλών

- ▶ Εγκαταστήστε με την αντίθετη σειρά.

## 4.12 Αντικατάσταση ραφιού πόρτας

Προϋπόθεση:

- ✔ Η πόρτα είναι ανοιχτή.

### 4.12.1 Αφαίρεση ραφιού πόρτας

- ▶ Ανασηκώστε το ράφι πόρτας προς τα επάνω.

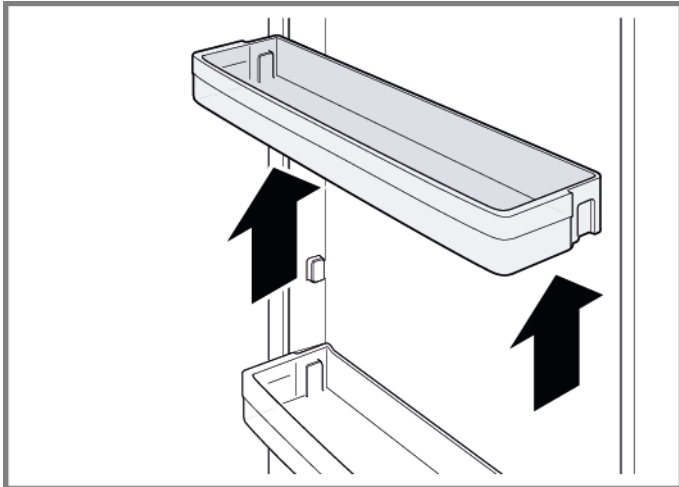

- ➡ Το ράφι πόρτας έχει αφαιρεθεί.

### 4.12.2 Τοποθέτηση ραφιού πόρτας

- ▶ Εγκαταστήστε με την αντίθετη σειρά.

### 4.13 Αντικατάσταση συρταριού κατεψυγμένων τροφίμων

Προϋπόθεση:

- ✔ Η πόρτα είναι ανοιχτή.

#### 4.13.1 Αφαίρεση συρταριού κατεψυγμένων τροφίμων

- ▶ 1. Τραβήξτε προς τα έξω ολόκληρο το συρτάρι κατεψυγμένων τροφίμων (1).
- ▶ 2. Αφαιρέστε το συρτάρι τροφίμων (2).

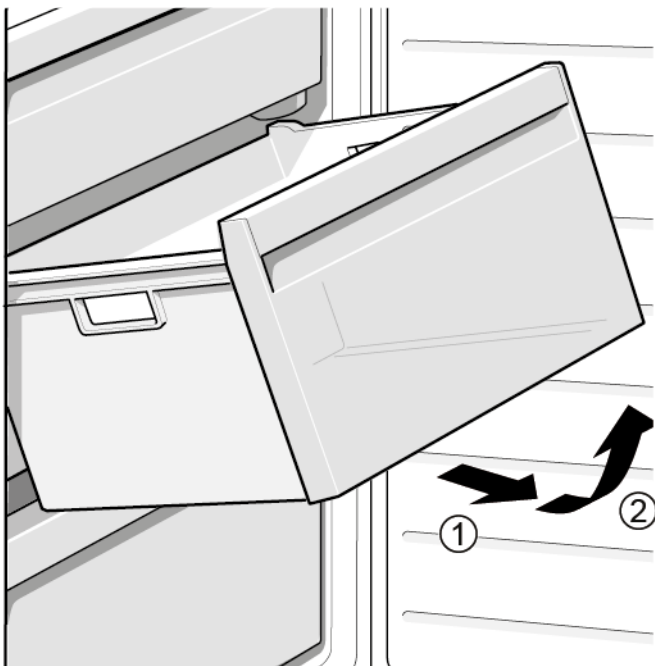

- ➡ Το συρτάρι κατεψυγμένων τροφίμων έχει αφαιρεθεί.

#### 4.13.2 Τοποθέτηση συρταριού κατεψυγμένων τροφίμων

- ▶ Εγκαταστήστε με την αντίθετη σειρά.

## 4.14 Αντικατάσταση συρταριού

**Προϋπόθεση:**

- ✔ Η πόρτα είναι ανοιχτή.

### 4.14.1 Αφαίρεση συρταριού

- ▶ 1. Μετακινήστε προς τα έξω το κάτω συρτάρι ψυγείου (1).
- ▶ 2. Μετακινήστε προς τα έξω το επάνω συρτάρι ψυγείου (2).

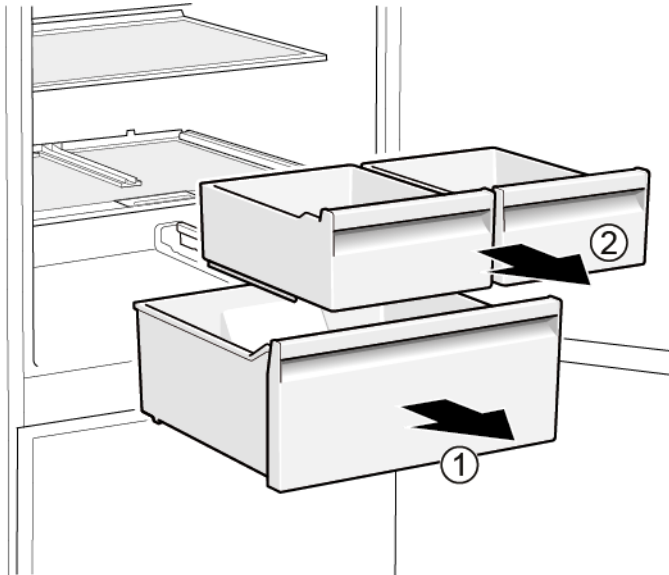

- ➡ Τα συρτάρια έχουν αφαιρεθεί.

### 4.14.2 Τοποθέτηση συρταριού

- ▶ Εγκαταστήστε με την αντίθετη σειρά.

## 4.15 Αντικατάσταση τηλεσκοπικού συρταριού

Προϋπόθεση:

- ✔ Η πόρτα είναι ανοιχτή.

### 4.15.1 Αφαίρεση τηλεσκοπικού συρταριού

- ▶ 1. Τραβήξτε προς τα έξω ολόκληρο το τηλεσκοπικό συρτάρι (1).
- ▶ 2. Αφαιρέστε το τηλεσκοπικό συρτάρι (2).

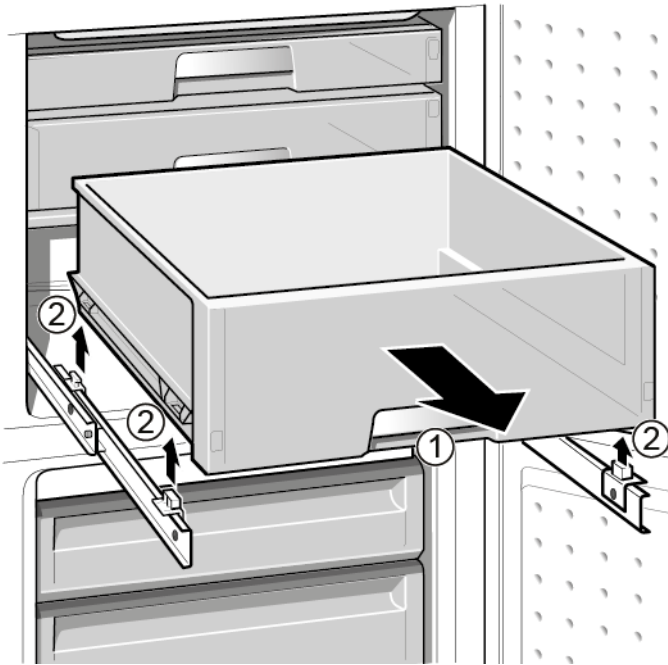

- ➡ Το τηλεσκοπικό συρτάρι αφαιρέθηκε.

### 4.15.2 Τοποθέτηση τηλεσκοπικού συρταριού

- ▶ Εγκαταστήστε με την αντίθετη σειρά.

## 4.16 Αντικατάσταση spot φωτισμού LED

### Προτεινόμενα εργαλεία:

Ειδικό εργαλείο [00342180]

**i** Η συσκευή διαθέτει ένα φως LED που δεν χρειάζεται συντήρηση. Αυτά τα φώτα μπορούν να επισκευαστούν μόνο από την εξυπηρέτηση πελατών ή από εξουσιοδοτημένους τεχνικούς!

**⚠ ΚΙΝΔΥΝΟΣ**  
**Κίνδυνος ηλεκτροπληξίας λόγω ηλεκτροφόρων μερών!**  
Κίνδυνος για τη ζωή από ηλεκτροπληξία σε περίπτωση ακατάλληλης επισκευής

- ▶ Τα ηλεκτρικά μέρη πρέπει να επισκευάζονται από εκπαιδευμένους ηλεκτρολόγους.
- ▶ Μετά την επισκευή πραγματοποιήστε έλεγχο ασφάλειας σύμφωνα με το VDE 0701 ή κανονισμούς της συγκεκριμένης χώρας.

**⚠ ΚΙΝΔΥΝΟΣ**  
**Κίνδυνος ηλεκτροπληξίας λόγω ηλεκτροφόρων μερών!**  
Θάνατος από ηλεκτροπληξία

- ▶ Αποσυνδέετε τις συσκευές από την παροχή ηλεκτρικού ρεύματος τουλάχιστον 60 δευτερόλεπτα πριν ξεκινήσετε τις επισκευές.

**⚠ ΠΡΟΣΟΧΗ**  
**Αιχμηρές ακμές!**  
Τραυματισμοί από κοπή

- ▶ Φοράτε προστατευτικά γάντια.

### Προϋπόθεση:

- ✓ Η συσκευή είναι αποσυνδεδεμένη από την παροχή τροφοδοσίας.
- ✓ Η πόρτα είναι ανοιχτή.

### 4.16.1 Αφαίρεση spot φωτισμού LED

1. Χρησιμοποιήστε ειδικό εργαλείο για να τραβήξετε προς τα έξω το spot φωτισμού LED (1).

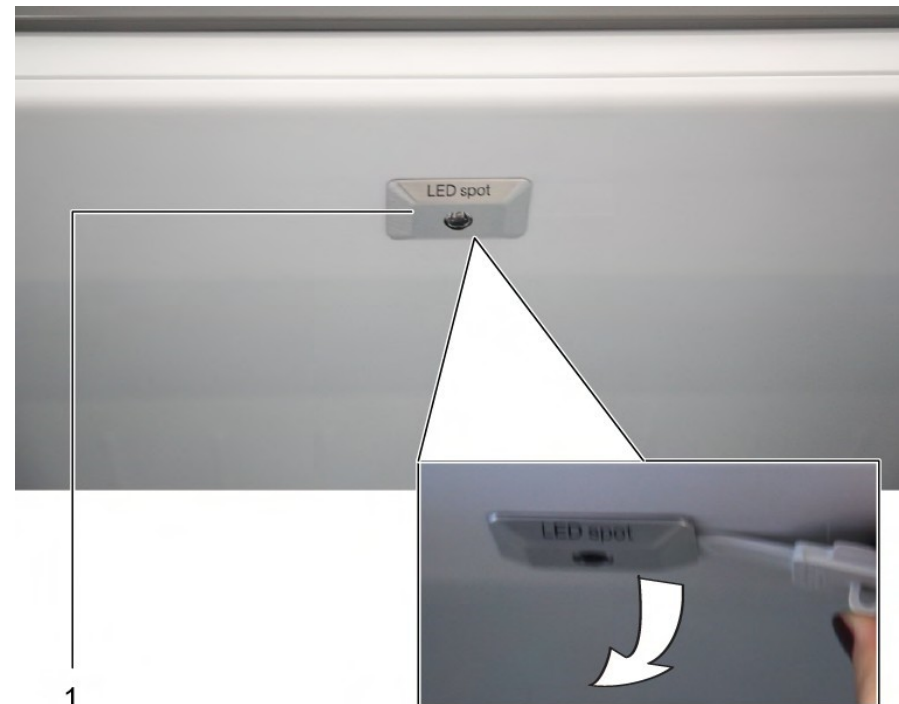

2. Αποσυνδέστε τις ηλεκτρικές συνδέσεις του spot φωτισμού LED.
- ➡ Το spot φωτισμού LED αφαιρέθηκε.

### 4.16.2 Τοποθέτηση spot φωτισμού LED

- ▶ Εγκαταστήστε με την αντίθετη σειρά.

## 4.17 Αντικατάσταση επάνω φωτός LED

### Προτεινόμενα εργαλεία:

-  Πλακέ κατσαβίδι
- Λεπίδα 2,4 mm x 0,4 mm x 60 mm, στο κιτ [00341820]



Η συσκευή διαθέτει ένα φως LED που δεν χρειάζεται συντήρηση. Αυτά τα φώτα μπορούν να επισκευαστούν μόνο από την εξυπηρέτηση πελατών ή από εξουσιοδοτημένους τεχνικούς!



### ΚΙΝΔΥΝΟΣ

#### Κίνδυνος ηλεκτροπληξίας λόγω ηλεκτροφόρων μερών!

Κίνδυνος για τη ζωή από ηλεκτροπληξία σε περίπτωση ακατάλληλης επισκευής

- ▶ Τα ηλεκτρικά μέρη πρέπει να επισκευάζονται από εκπαιδευμένους ηλεκτρολόγους.
- ▶ Μετά την επισκευή πραγματοποιήστε έλεγχο ασφάλειας σύμφωνα με το VDE 0701 ή κανονισμούς της συγκεκριμένης χώρας.



### ΚΙΝΔΥΝΟΣ

#### Κίνδυνος ηλεκτροπληξίας λόγω ηλεκτροφόρων μερών!

Θάνατος από ηλεκτροπληξία

- ▶ Αποσυνδέετε τις συσκευές από την παροχή ηλεκτρικού ρεύματος τουλάχιστον 60 δευτερόλεπτα πριν ξεκινήσετε τις επισκευές.





### ΠΡΟΣΟΧΗ

#### Αιχμηρές ακμές!

Τραυματισμοί από κοπή

- ▶ Φοράτε προστατευτικά γάντια.

### Προϋπόθεση:

-  Η συσκευή είναι αποσυνδεδεμένη από την παροχή τροφοδοσίας.
-  Η πόρτα είναι ανοιχτή.
-  Αφαιρούνται τα επάνω εσωτερικά εξαρτήματα.

## 4.17.1 Αφαίρεση φωτός LED

1. Μετακινήστε το φως LED στην αριστερή πλευρά.

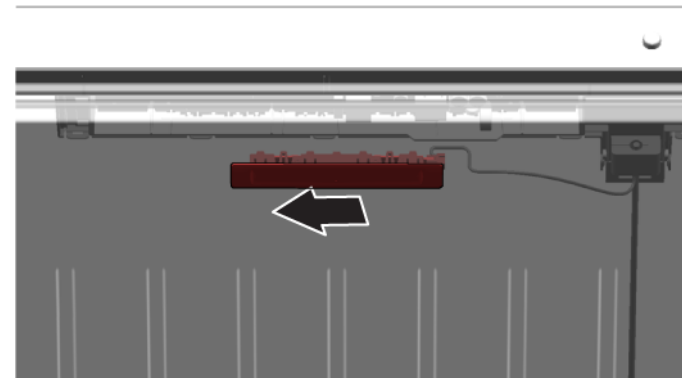

-  Η ηλεκτρική σύνδεση φωτισμού LED είναι αποσυνδεδεμένη.

2. Απελευθερώστε τα άγκιστρα φωτισμού LED.

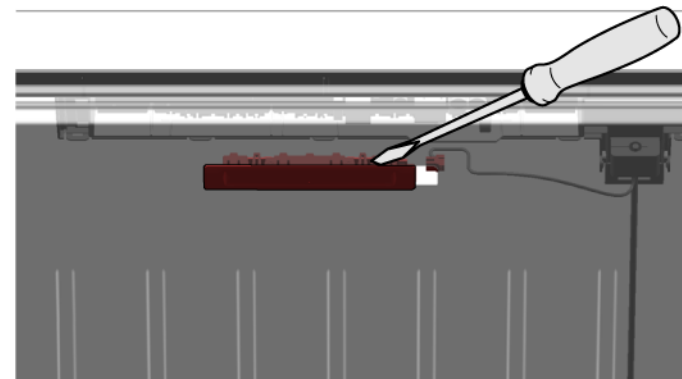

3. Αφαιρέστε το φως LED, μετακινώντας το προς τα εμπρός.

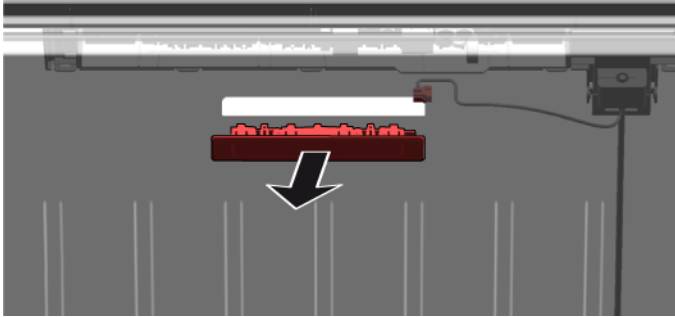

- ➔ Το φως LED αφαιρέθηκε.

### 4.17.2 Τοποθέτηση επάνω φωτισμού LED

- ▶ Εγκαταστήστε με την αντίθετη σειρά.

## 4.18 Αντικατάσταση πλευρικής ράβδου φωτισμού LED

### Προτεινόμενα εργαλεία:

Βεντούζα Ø50 mm [00342224]



Η συσκευή διαθέτει ένα φως LED που δεν χρειάζεται συντήρηση. Αυτά τα φώτα μπορούν να επισκευαστούν μόνο από την εξυπηρέτηση πελατών ή από εξουσιοδοτημένους τεχνικούς!



### ΚΙΝΔΥΝΟΣ

#### Κίνδυνος ηλεκτροπληξίας λόγω ηλεκτροφόρων μερών!

Κίνδυνος για τη ζωή από ηλεκτροπληξία σε περίπτωση ακατάλληλης επισκευής

- ▶ Τα ηλεκτρικά μέρη πρέπει να επισκευάζονται από εκπαιδευμένους ηλεκτρολόγους.
- ▶ Μετά την επισκευή πραγματοποιήστε έλεγχο ασφάλειας σύμφωνα με το VDE 0701 ή κανονισμούς της συγκεκριμένης χώρας.



### ΚΙΝΔΥΝΟΣ

#### Κίνδυνος ηλεκτροπληξίας λόγω ηλεκτροφόρων μερών!

Θάνατος από ηλεκτροπληξία

- ▶ Αποσυνδέετε τις συσκευές από την παροχή ηλεκτρικού ρεύματος τουλάχιστον 60 δευτερόλεπτα πριν ξεκινήσετε τις επισκευές.



### ΠΡΟΣΟΧΗ

#### Αιχμηρές ακμές!

Τραυματισμοί από κοπή

- ▶ Φοράτε προστατευτικά γάντια.

### Προϋπόθεση:

- ✓ Η συσκευή είναι αποσυνδεδεμένη από την παροχή τροφοδοσίας.
- ✓ Η πόρτα είναι ανοιχτή.
- ✓ Τα ράφια χώρου ψυγείου έχουν αφαιρεθεί.

## 4.18.1 Αφαίρεση πλευρικής ράβδου φωτισμού LED

1. Κολλήστε τη βεντούζα στο επάνω ένα τρίτο της πλευρικής ράβδου φωτισμού LED.



2. Τραβήξτε τη βεντούζα προς το μέρος σας με την πλευρική ράβδο φωτισμού LED με μια περιστροφική κίνηση.

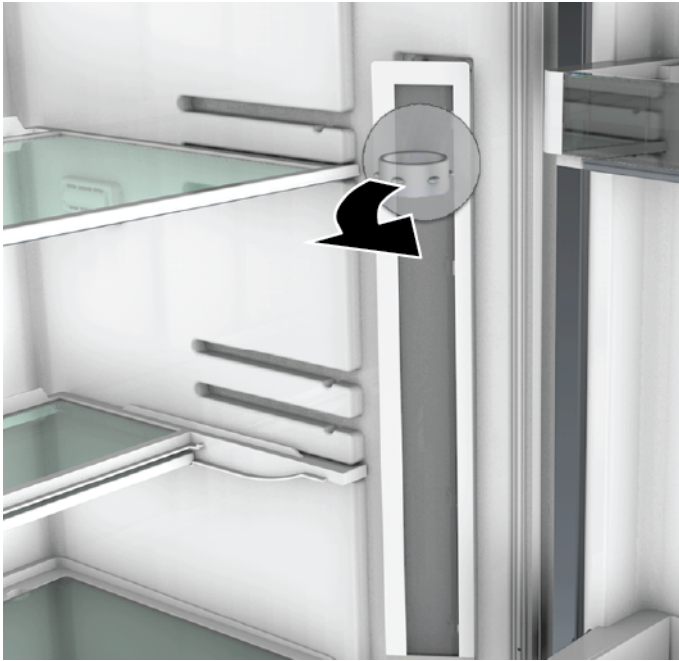

3. Αποσυνδέστε την ηλεκτρική σύνδεση της πλευρικής ράβδου φωτισμού LED.  
➡ Η πλευρική ράβδος φωτισμού LED αφαιρέθηκε.

### 4.18.2 Τοποθέτηση πλευρικής ράβδου φωτισμού LED

1. Συνδέστε την ηλεκτρική σύνδεση της πλευρικής ράβδου φωτισμού LED.
  2. Στερεώστε την πλευρική ράβδο φωτισμού LED στη θέση της στο τοίχωμα του χώρου (τα άγκιστρα κουμπώνουν με χαρακτηριστικό ήχο).
- ➡ Η πλευρική ράβδος φωτισμού LED τοποθετήθηκε.

# Javítási útmutató - Hűtő- és fagyasztókészülék

## **A dokumentummal kapcsolatos információk..... 300**

1.1	Fontos tudnivalók .....	300
1.1.1	Cél .....	300
1.2	Szimbólummagyarázat .....	300
1.2.1	Veszélyességi szintek .....	300
1.2.2	Veszélyt jelző szimbólumok .....	300
1.2.3	A figyelmeztetések felépítése .....	301
1.2.4	Általános szimbólumok.....	301

## **Biztonság ..... 302**

2.1	Általános biztonsági utasítások.....	302
2.1.1	Összes háztartási készülék .....	302

## **Szerszámok és segédanyagok..... 303**

## **Javítás ..... 304**

4.1	A gumitömítés cseréje .....	304
4.2	A fogantyú cseréje.....	305
4.2.1	A fogantyú eltávolítása .....	305
4.2.2	A fogantyú felszerelése .....	305
4.3	A felső ajtózsanér cseréje .....	306
4.3.1	A felső ajtózsanér eltávolítása.....	306
4.3.2	A felső ajtózsanér felhelyezése .....	307
4.4	A felső ajtózsanér cseréje (kijelzős ajtó).....	308
4.4.1	A felső ajtózsanér eltávolítása.....	308
4.4.2	A felső ajtózsanér felhelyezése .....	309
4.5	A középső ajtózsanér cseréje.....	310
4.5.1	A középső ajtózsanér eltávolítása .....	310
4.5.2	A középső ajtózsanér felhelyezése .....	310
4.6	Az alsó ajtózsanér cseréje .....	311
4.6.1	Az alsó ajtózsanér eltávolítása.....	311
4.6.2	Az alsó ajtózsanér felhelyezése .....	311
4.7	A polc cseréje .....	312
4.7.1	A polc eltávolítása .....	312
4.7.2	A polc beszerelése.....	312
4.8	Állítható polc cseréje.....	313

4.8.1	Állítható polc eltávolítása .....	313
4.8.2	Állítható polc beszerelése .....	313
4.9	Rugalmas polc cseréje .....	314
4.9.1	Rugalmas polc eltávolítása .....	314
4.9.2	A rugalmas polc beszerelése.....	314
4.10	A reggelizőkészlet cseréje .....	315
4.10.1	A reggelizőkészlet eltávolítása .....	315
4.10.2	A reggelizőkészlet beszerelése .....	315
4.11	A palacktartó cseréje.....	316
4.11.1	A palacktartó eltávolítása .....	316
4.11.2	A palacktartó telepítése.....	316
4.12	Az ajtópolc cseréje .....	317
4.12.1	Az ajtópolc eltávolítása .....	317
4.12.2	Az ajtópolc felhelyezése.....	317
4.13	Fagyasztódoboz cseréje.....	318
4.13.1	Fagyasztódoboz eltávolítása .....	318
4.13.2	A fagyasztódoboz behelyezése .....	318
4.14	Tároló cseréje.....	319
4.14.1	Tároló eltávolítása .....	319
4.14.2	A tároló behelyezése .....	319
4.15	A kihúzható tároló cseréje .....	320
4.15.1	A kihúzható tároló eltávolítása.....	320
4.15.2	A kihúzható tároló behelyezése .....	320
4.16	LED-es oldalsó spotvilágítás cseréje .....	321
4.16.1	LED-es spotvilágítás eltávolítása .....	321
4.16.2	A LED-es spotvilágítás beszerelése.....	321
4.17	Felső LED-világítás cseréje .....	322
4.17.1	LED-világítás eltávolítása.....	322
4.17.2	A felső LED-világítás beszerelése .....	323
4.18	A LED-es oldalvilágítás cseréje.....	324
4.18.1	LED-es oldalvilágítás eltávolítása .....	324
4.18.2	A LED-es oldalvilágítás beszerelése .....	325

# **i** A dokumentummal kapcsolatos információk

## 1.1 Fontos tudnivalók

### 1.1.1 Cél

Ezek a javítási tanácsok támogatják a fogyasztót a készülékek otthoni megjavításában a környezettudatos tervezésről szóló rendeletnek (2021 márciusától alkalmazandó) megfelelően.



Információkat tartalmaznak bizonyos pótalkatrészek cseréjével kapcsolatban, ideértve a figyelmeztetéseket és a kockázatokat is.

Ha kérdése van, vegye fel a kapcsolatot a vevőszolgálattal. A károkért kizárólag akkor vállalunk felelősséget, ha a javítási tanácsokat pontosan betartották.

## 1.2 Szimbólummagyarázat

### 1.2.1 Veszélyességi szintek

A veszélyességi szintek egy szimbólumból és egy figyelmeztető mondatból állnak. A figyelmeztető mondat utal a veszély súlyosságára.





Veszélyességi szint	Jelentés
 <b>VESZÉLY</b>	A figyelmeztető üzenet figyelmen kívül hagyása halált vagy súlyos sérüléseket okoz.
 <b>FIGYELMEZTETÉS</b>	A figyelmeztető üzenet figyelmen kívül hagyása halált vagy súlyos sérüléseket okozhat.
 <b>VIGYÁZAT</b>	A figyelmeztető üzenet figyelmen kívül hagyása kisebb sérüléseket okozhat.
<b>FIGYELEM!</b>	A figyelmeztető üzenet figyelmen kívül hagyása anyagi károkat okozhat.

Táblázat 1: Veszélyességi szintek

### 1.2.2 Veszélyt jelző szimbólumok

A veszélyt jelző szimbólumok a veszélyt ábrázoló szimbolikus ábrázolások.

A jelen dokumentumban az alábbi veszélyt jelző szimbólumok használatosak:

Veszélyt jelző szimbólum	Jelentés
	Általános figyelmeztető üzenet
	Elektromos feszültség veszélye
	Robbanásveszély
	Vágásveszély
	Zúzódásveszély

## **i** A dokumentummal kapcsolatos információk

Veszélyt jelző szimbólum	Jelentés
	Forró felületek miatt fennálló veszély
	Erős mágneses mező miatt fennálló veszély
	Nem ionizáló sugárzás veszélye

Táblázat 2: Veszélyt jelző szimbólumok

### 1.2.3 A figyelmeztetések felépítése

A jelen dokumentumban lévő figyelmeztetések szabványosított megjelenésűek és felépítésűek.

	<p><b>⚠ VESZÉLY</b></p> <p><b>A veszély típusa és forrása!</b> A veszély / figyelmeztetés figyelmen kívül hagyásának lehetséges következményei.</p> <ul style="list-style-type: none"> <li>▶ A veszély megelőzésére szolgáló intézkedések és tiltások.</li> </ul>
--	---

Az alábbi példa egy olyan figyelmeztetést mutat be, amely az áram alatt lévő alkatrészek okozta áramütésre figyelmeztet. Megemlíti a veszély elkerülésére szolgáló intézkedést.

	<p><b>⚠ VESZÉLY</b></p> <p><b>Áramütés veszélye áram alatt lévő alkatrészek miatt!</b> Halálos áramütés</p> <ul style="list-style-type: none"> <li>▶ A javítás megkezdése előtt legalább 60 másodperccel válassza le a készülékeket az elektromos hálózatról.</li> </ul>
--	--

### 1.2.4 Általános szimbólumok

A jelen dokumentumban az alábbi általános szimbólumok használatosak:

Ált. szimbólum	Jelentés
	Különleges tanács (szöveg és/vagy grafika)

Ált. szimbólum	Jelentés
	Egyszerű tanács (csak szöveg)
	Videós oktatóanyagra mutató hivatkozás
	A szükséges eszközök
	A szükséges feltételek
	Feltétel (ha..., akkor...)
	Eredmény
[Indítás]	Billentyű vagy gomb
[00123456]	Anyagszám azonosítója
Állapot	Megjelenített szöveg / ablak (a készülék kijelzőjén)

Táblázat 3: Általános szimbólumok

## 2.1 Általános biztonsági utasítások

### 2.1.1 Összes háztartási készülék

#### **Áramütés veszélye áram alatt lévő alkatrészek miatt!**

- Az elektromos alkatrészek hibás javítása áramütéshez vezethet!
- A javítás megkezdése előtt legalább 60 másodperccel válassza le a készüléket az elektromos hálózatról.
- A javítás után végeztesse a VDE 0701-nek vagy az országspecifikus szabályozásoknak megfelelő vizsgálatot.

#### **Éles peremek miatt fennálló sérülésveszély!**

- Viseljen védőkesztyűt.

#### **Zúzódásveszély a javítás, karbantartás, hibaelhárítás és szervizelés során a nehéz és mozgó alkatrészek miatt**

- Viseljen védőcipőt.
- Biztosítsa leesés ellen a nehéz alkatrészeket.
- Ne dugja be a testrészeit a mozgó alkatrészek közé.

#### **Sérülhet a készülék biztonsága / működése!**

- Kizárólag eredeti pótalkatrészeket használjon.

#### **Elektrosztatikailag érzékeny alkatrészek (ESD-k) károsodásának veszélye!**

- Ne érintse meg a modulokat, ideértve a csatlakozásokat és a vezetőket.

## Szerszámok és segédanyagok

Kijelölés	Részletek	Képek
Védőrongy [00342013]	60 cm x 50 cm	
Precíziós csavarhúzó készlet [00341820]	9 darab, 2 mm, 2,4 mm, 3 mm, PH0, PH00, PH1, TX6, TX8, TX9	
Segédeszköz [00342180]	Műanyag alkatrészek meglazítására szolgáló szerszám "magic tool"	
Tapadókorong [00342224]	Ø 50 mm	
TX20 Torx bithegy [00340865]	6,3 mm (1/4")	
Laposfejű csavarhúzó	Hegyző 10 mm x 1,6 mm x 200 mm	

## 4.1 A gumitömítés cseréje

### Követelmény:

- Az ajtó nyitva van

## 4.2 A fogantyú cseréje

### Különleges eszközök

- TX20 Torx bithegy 6,3 mm (1/4") [00340865]
- Laposfejű csavarhúzó Hegy 10 mm x 1,6 mm x 200 mm

### Követelmény:

- ✓ A készüléket leválasztotta az áramellátásról.
- ✓ Az ajtó nyitva van

### 4.2.1 A fogantyú eltávolítása

- ▶ 1. Távolítsa el a két csavarfedelelet (1).
- ▶ 2. Csavarja ki a két csavart (2).
- ▶ 3. Távolítsa el a fogantyút (3).

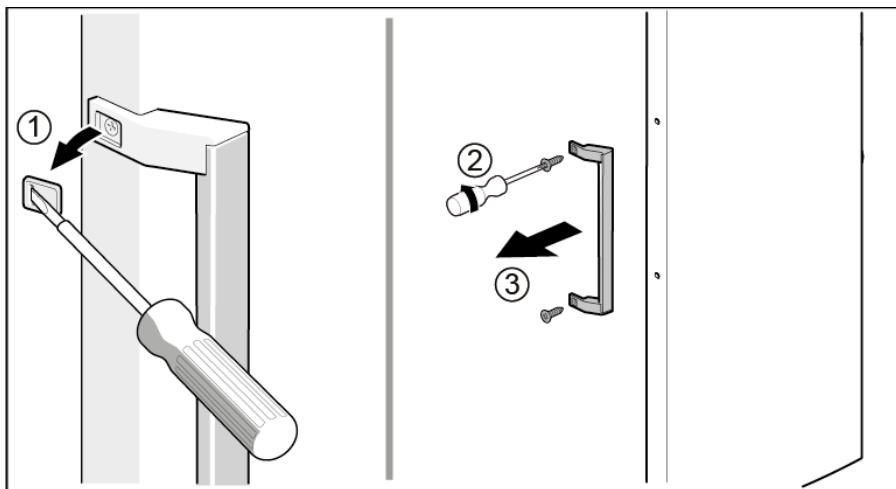

➔ Eltávolította a fogantyút.



A második ajtó fogantyújának eltávolítása ugyanígy történik.

### 4.2.2 A fogantyú felszerelése

- ▶ Az elhelyezést fordított sorrendben végezze.

### 4.3 A felső ajtózsanér cseréje

#### Különleges eszközök

 TX20 Torx bithegy

6,3 mm (1/4")

[00340865]

	<p style="text-align: center;"><b>⚠ FIGYELMEZTETÉS</b></p> <p><b>Nehéz, nagy készülékek!</b> Hát- és izomsérülések</p> <ul style="list-style-type: none"> <li>▶ A készülék ajtajának eltávolítását kizárólag szakemberrel végeztesse.</li> <li>▶ A készülék elmozdításához két emberre van szükség.</li> <li>▶ Kizárólag megfelelő eszközöket és berendezéseket használjon.</li> </ul>
--	--



	<p style="text-align: center;"><b>⚠ VIGYÁZAT</b></p> <p><b>Éles szélek!</b> Vágási sérülések</p> <ul style="list-style-type: none"> <li>▶ Viseljen védőkesztyűt.</li> </ul>
--	---

	<p style="text-align: center;"><b>⚠ FIGYELMEZTETÉS</b></p> <p><b>Megdöntött készülékek elcsúszása!</b> Csonttörés / zúzódási sérülések</p> <ul style="list-style-type: none"> <li>▶ Biztosítsa a készülékeket elcsúszás ellen.</li> </ul>
--	---

	<p style="text-align: center;"><b>⚠ VIGYÁZAT</b></p> <p><b>Leeső alkatrészek veszélye a kioldott csavarok miatt!</b> Leeső alkatrészek miatti sérülés.</p> <ul style="list-style-type: none"> <li>▶ Biztosítsa az alkatrészt leesés ellen.</li> </ul>
---	---

	<p style="text-align: center;"><b>FIGYELEM!</b></p> <p><b>Leeső alkatrészek veszélye a kioldott csavarok miatt!</b> A készülék többi részeinek vagy az ügyfél lakásának (pl. padló) károsodása.</p> <ul style="list-style-type: none"> <li>▶ Biztosítsa az alkatrészt leesés ellen.</li> </ul>
--	--

#### Követelmény:

-  A készüléket leválasztotta az áramellátásról.
-  Eltávolította a készülék belső szerelvényeit.

#### 4.3.1 A felső ajtózsanér eltávolítása

1. Fordítsa a készüléket a hátára.

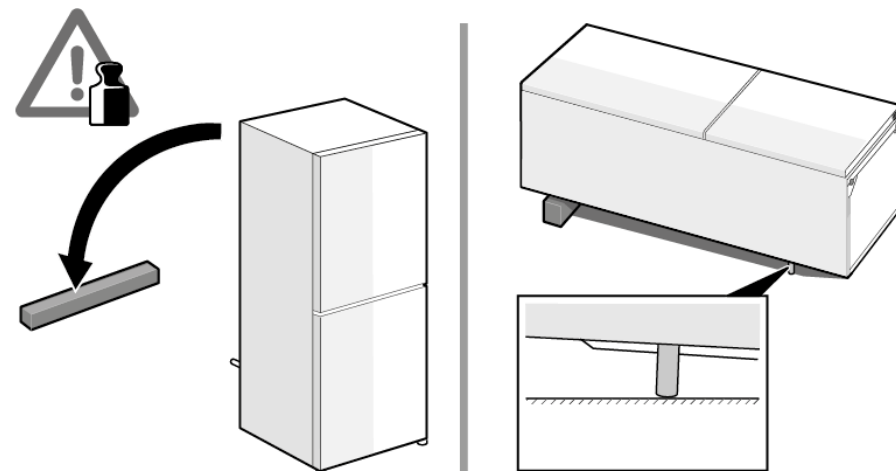

2. 1. Nyomja meg mindkét oldalon a felső zsanér burkolatát (1).
2. Húzza el a felső zsanér burkolatát (2).
3. Fordítsa el a zsanérburkolatot (3).
4. Távolítsa el a felső zsanér burkolatát (4).
5. Csavarja ki a két csavart (5).
6. Távolítsa el a felső zsanért (6)/.

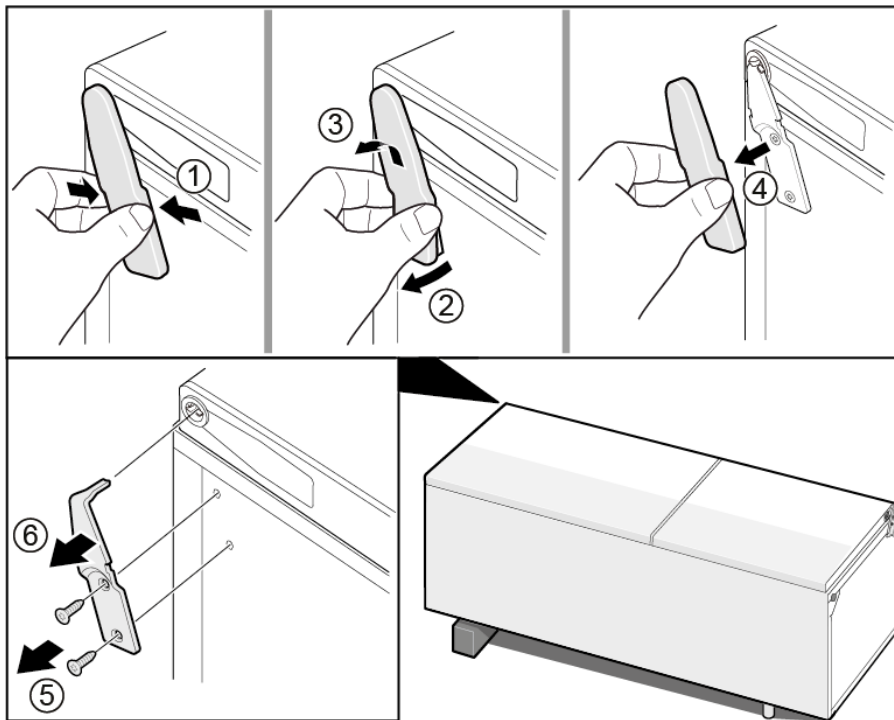

 Eltávolította a felső zsanért.

### 4.3.2 A felső ajtózsánér felhelyezése

- ▶ Az elhelyezést fordított sorrendben végezze.

## 4.4 A felső ajtózsanér cseréje (kijelzős ajtó)

### Különleges eszközök

TX20 Torx bithegy 6,3 mm (1/4") [00340865]

	<b>⚠ FIGYELMEZTETÉS</b>
	<p><b>Nehéz, nagy készülékek!</b> Hát- és izomsérülések</p> <ul style="list-style-type: none"> <li>▶ A készülék ajtajának eltávolítását kizárólag szakemberrel végeztesse.</li> <li>▶ A készülék elmozdításához két emberre van szükség.</li> <li>▶ Kizárólag megfelelő eszközöket és berendezéseket használjon.</li> </ul>

	<b>⚠ VIGYÁZAT</b>
	<p><b>Éles szélek!</b> Vágási sérülések</p> <ul style="list-style-type: none"> <li>▶ Viseljen védőkesztyűt.</li> </ul>

	<b>⚠ FIGYELMEZTETÉS</b>
	<p><b>Megdöntött készülékek elcsúszása!</b> Csonttörés / zúzódási sérülések</p> <ul style="list-style-type: none"> <li>▶ Biztosítsa a készülékeket elcsúszás ellen.</li> </ul>

	<b>⚠ VIGYÁZAT</b>
	<p><b>Leeső alkatrészek veszélye a kioldott csavarok miatt!</b> Leeső alkatrészek miatti sérülés.</p> <ul style="list-style-type: none"> <li>▶ Biztosítsa az alkatrészt leesés ellen.</li> </ul>

	<b>FIGYELEM!</b>
	<p><b>Leeső alkatrészek veszélye a kioldott csavarok miatt!</b> A készülék többi részeinek vagy az ügyfél lakásának (pl. padló) károsodása.</p> <ul style="list-style-type: none"> <li>▶ Biztosítsa az alkatrészt leesés ellen.</li> </ul>

	<b>⚠ VESZÉLY</b>
	<p><b>Áramütés veszélye áram alatt lévő alkatrészek miatt!</b> Életveszély a nem megfelelő javítás okozta áramütés miatt</p> <ul style="list-style-type: none"> <li>▶ Az elektromos alkatrészek javítását kizárólag képzett elektroműszerész végezheti.</li> <li>▶ A javítás után végeztesse a VDE 0701-nek vagy az országspecifikus szabályozásoknak megfelelő vizsgálatot.</li> </ul>

	<b>⚠ VESZÉLY</b>
	<p><b>Áramütés veszélye áram alatt lévő alkatrészek miatt!</b> Halálos áramütés</p> <ul style="list-style-type: none"> <li>▶ A javítás megkezdése előtt legalább 60 másodperccel válassza le a készülékeket az elektromos hálózatról.</li> </ul>

### Követelmény:

- ✓ A készüléket leválasztotta az áramellátásról.
- ✓ Eltávolította a készülék belső szerelvényeit.

### 4.4.1 A felső ajtózsanér eltávolítása

1. Fordítsa a készüléket a hátára.

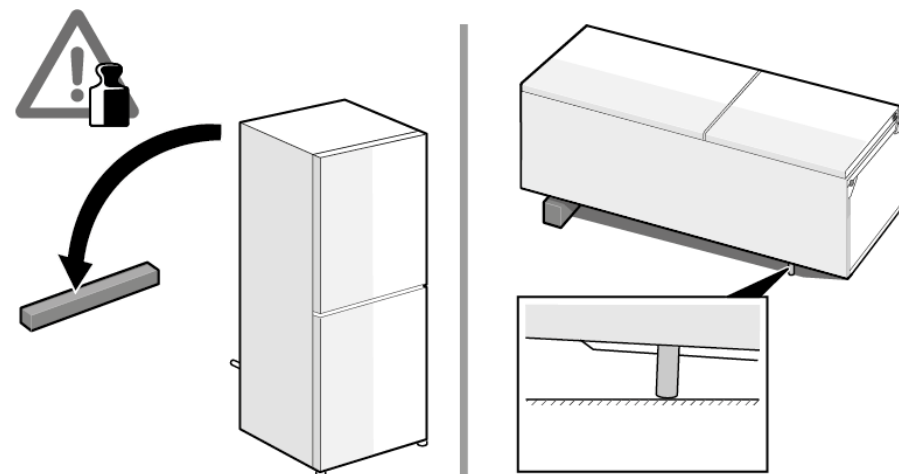

2. 1. Távolítsa el a felső zsanér burkolatát (1).
2. Távolítsa el a kábeldoboz fedelét (2).
3. Válassza le az elektromos csatlakozást (3).
4. Csavarja ki a földelő csatlakozás csavarját (4).
5. Távolítsa el a kábelburkolatot (5).
6. Csavarja ki a csavart (6).

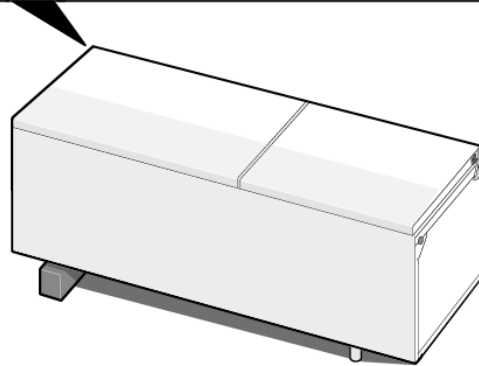
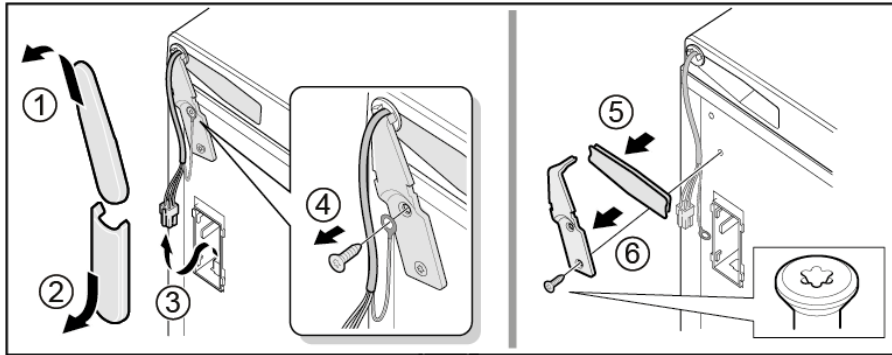

 Eltávolította a felső zsanért.

### 4.4.2 A felső ajtózsánér felhelyezése

- ▶ Az elhelyezést fordított sorrendben végezze.

## 4.5 A középső ajtózsanér cseréje

### Különleges eszközök

 TX20 Torx bithegy 6,3 mm (1/4") [00340865]

	<b>⚠ FIGYELMEZTETÉS</b>
	<p><b>Nehéz, nagy készülékek!</b> Hát- és izomsérülések</p> <ul style="list-style-type: none"> <li>▶ A készülék ajtajának eltávolítását kizárólag szakemberrel végeztesse.</li> <li>▶ A készülék elmozdításához két emberre van szükség.</li> <li>▶ Kizárólag megfelelő eszközöket és berendezéseket használjon.</li> </ul>



	<b>⚠ VIGYÁZAT</b>
	<p><b>Éles szélek!</b> Vágási sérülések</p> <ul style="list-style-type: none"> <li>▶ Viseljen védőkesztyűt.</li> </ul>

	<b>⚠ FIGYELMEZTETÉS</b>
	<p><b>Megdöntött készülékek elcsúszása!</b> Csonttörés / zúzódási sérülések</p> <ul style="list-style-type: none"> <li>▶ Biztosítsa a készülékeket elcsúszás ellen.</li> </ul>

	<b>⚠ VIGYÁZAT</b>
	<p><b>Leeső alkatrészek veszélye a kioldott csavarok miatt!</b> Leeső alkatrészek miatti sérülés.</p> <ul style="list-style-type: none"> <li>▶ Biztosítsa az alkatrészt leesés ellen.</li> </ul>

	<b>FIGYELEM!</b>
	<p><b>Leeső alkatrészek veszélye a kioldott csavarok miatt!</b> A készülék többi részeinek vagy az ügyfél lakásának (pl. padló) károsodása.</p> <ul style="list-style-type: none"> <li>▶ Biztosítsa az alkatrészt leesés ellen.</li> </ul>

### Követelmény:

-  A készüléket leválasztotta az áramellátásról.
-  Eltávolította a készülék belső szerelvényeit.
-  Eltávolította az ajtó felső zsanérját.

-  Eltávolította a felső ajtót.

### 4.5.1 A középső ajtózsanér eltávolítása

- ▶ 1. Távolítsa el a hűtőrekesz ajtaját (1).
- ▶ 2. Csavarja ki a két csavart (2).
- ▶ 3. Távolítsa el a középső zsanért (3).

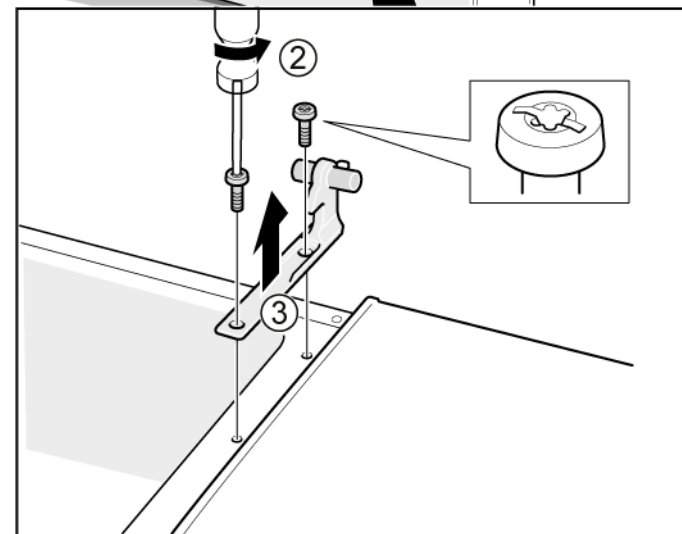
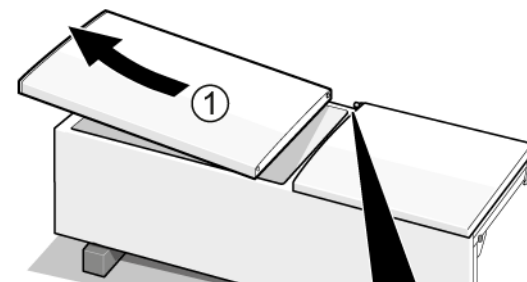

-  Eltávolította a középső zsanért.

### 4.5.2 A középső ajtózsanér felhelyezése

- ▶ Az elhelyezést fordított sorrendben végezze.

## 4.6 Az alsó ajtózanér cseréje

### Különleges eszközök

TX20 Torx bithegy

6,3 mm (1/4")

[00340865]

	<b>⚠ FIGYELMEZTETÉS</b>
<b>Nehéz, nagy készülékek!</b>	
Hát- és izomsérülések	
<ul style="list-style-type: none"> <li>▶ A készülék ajtajának eltávolítását kizárólag szakemberrel végeztesse.</li> <li>▶ A készülék elmozdításához két emberre van szükség.</li> <li>▶ Kizárólag megfelelő eszközöket és berendezéseket használjon.</li> </ul>	

	<b>⚠ VIGYÁZAT</b>
<b>Éles szélek!</b>	
Vágási sérülések	
<ul style="list-style-type: none"> <li>▶ Viseljen védőkesztyűt.</li> </ul>	

	<b>⚠ FIGYELMEZTETÉS</b>
<b>Megdöntött készülékek elcsúszása!</b>	
Csonttörés / zúzódási sérülések	
<ul style="list-style-type: none"> <li>▶ Biztosítsa a készülékeket elcsúszás ellen.</li> </ul>	

	<b>⚠ VIGYÁZAT</b>
<b>Leeső alkatrészek veszélye a kioldott csavarok miatt!</b>	
Leeső alkatrészek miatti sérülés.	
<ul style="list-style-type: none"> <li>▶ Biztosítsa az alkatrészt leesés ellen.</li> </ul>	

	<b>FIGYELEM!</b>
<b>Leeső alkatrészek veszélye a kioldott csavarok miatt!</b>	
A készülék többi részeinek vagy az ügyfél lakásának (pl. padló) károsodása.	
<ul style="list-style-type: none"> <li>▶ Biztosítsa az alkatrészt leesés ellen.</li> </ul>	

### Követelmény:

- ✔ A készüléket leválasztotta az áramellátásról.
- ✔ Eltávolította a készülék belső szerelvényeit.
- ✔ Eltávolította a felső zsanért.

- ✔ Eltávolította a középső zsanért.

### 4.6.1 Az alsó ajtózanér eltávolítása

- ▶ 1. Távolítsa el a fagyasztórekesz ajtaját (1).
- ▶ 2. Csavarja ki a csavart (2).
- ▶ 3. Fordítsa ki az alsó zsanért (3).
- ▶ 4. Távolítsa el az alsó zsanért (4).

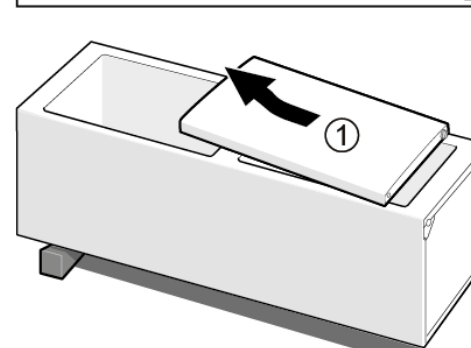
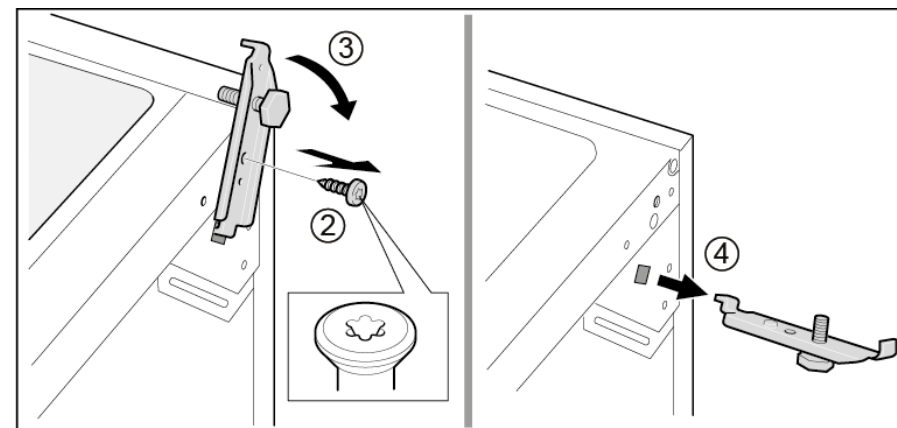

- ➡ Eltávolította az alsó ajtózanért.

### 4.6.2 Az alsó ajtózanér felhelyezése

- ▶ Az elhelyezést fordított sorrendben végezze.

## 4.7 A polc cseréje

### Követelmény:

- ✔ Az ajtó nyitva van

### 4.7.1 A polc eltávolítása

- ▶ Húzza ki a polcot.

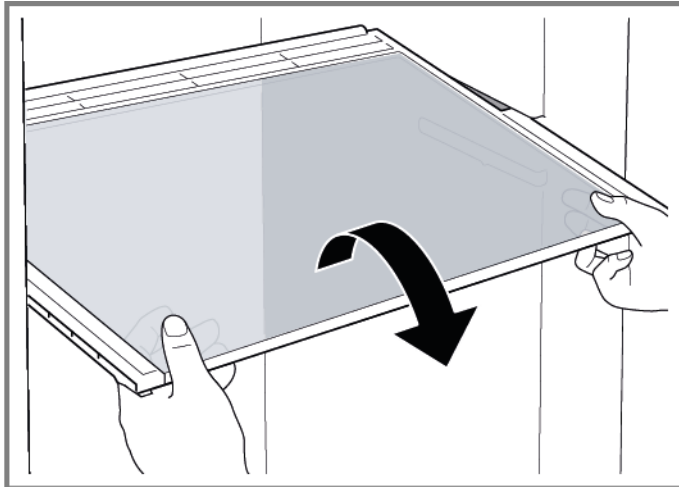

- ➡ Eltávolította a polcot.

### 4.7.2 A polc beszerelése

- ▶ Az elhelyezést fordított sorrendben végezze.

## 4.8 Állítható polc cseréje

### Követelmény:

- ✓ Az ajtó nyitva van

### 4.8.1 Állítható polc eltávolítása

1. Húzza előre az állítható polc jobb oldali részét (1).
2. Emelje ki az állítható polc jobb oldali részét (2).

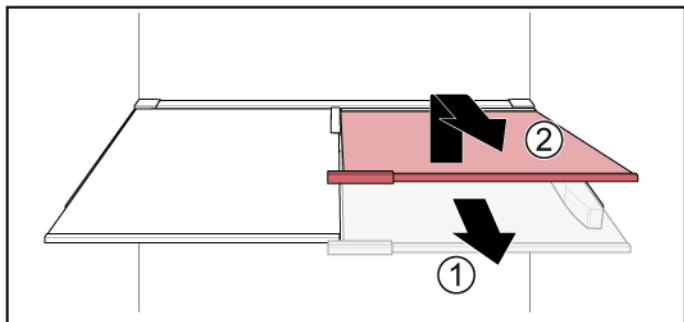

2. Hasonló módon emelje ki az állítható polc bal oldali részét.

- ➡ Eltávolította az állítható polcot.

### 4.8.2 Állítható polc beszerelése

- ▶ Az elhelyezést fordított sorrendben végezze.

## 4.9 Rugalmas polc cseréje

### Követelmény:

- ✓ Az ajtó nyitva van

### 4.9.1 Rugalmas polc eltávolítása

- ▶ 1. Vegye ki az üvegpalcot (1).
- ▶ 2. Emelje fel a rugalmas polcot, és húzza ki teljesen (2).

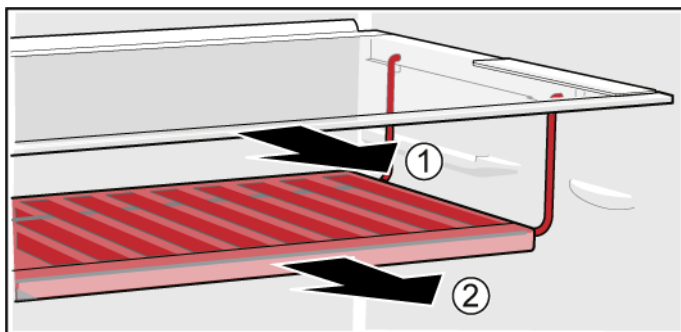

- ➡ Eltávolította a rugalmas polcot.

### 4.9.2 A rugalmas polc beszerelése

- ▶ Az elhelyezést fordított sorrendben végezze.

## 4.10 A reggelizőkészlet cseréje

### Követelmény:

- ✔ Az ajtó nyitva van

### 4.10.1 A reggelizőkészlet eltávolítása

- ▶ Emelje fel a reggelizőkészletet, és húzza ki teljesen.

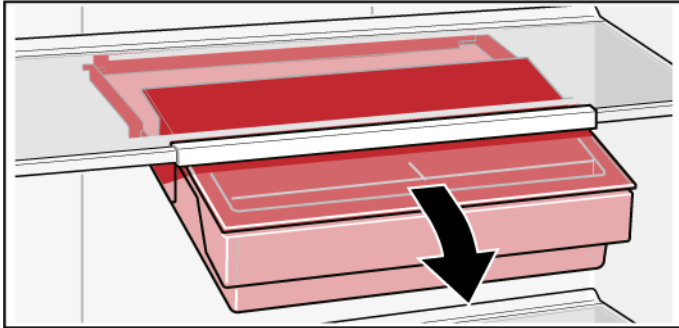

- ➡ Eltávolított a reggelizőkészletet.

### 4.10.2 A reggelizőkészlet beszerelése

- ▶ Az elhelyezést fordított sorrendben végezze.

## 4.11 A palacktartó cseréje

### Követelmény:

- ✔ Az ajtó nyitva van

### 4.11.1 A palacktartó eltávolítása

- ▶ Húzza ki a palacktartót.

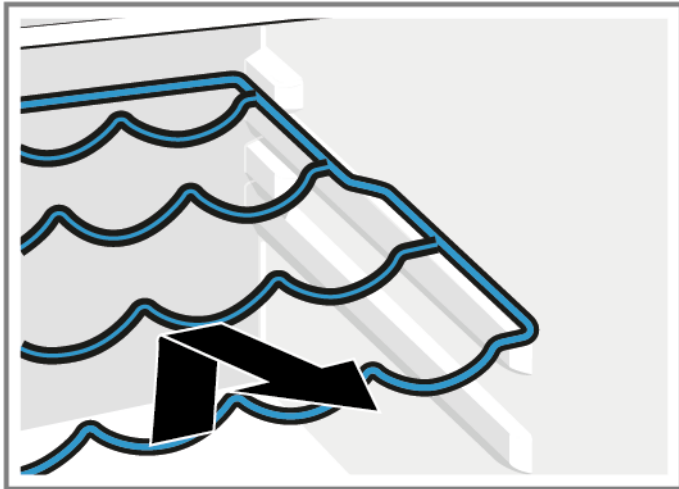

- ➡ Eltávolította a palacktartót.

### 4.11.2 A palacktartó telepítése

- ▶ Az elhelyezést fordított sorrendben végezze.

## 4.12 Az ajtópolc cseréje

### Követelmény:

- ✔ Az ajtó nyitva van

### 4.12.1 Az ajtópolc eltávolítása

- ▶ Emelje fel az ajtópolcot.

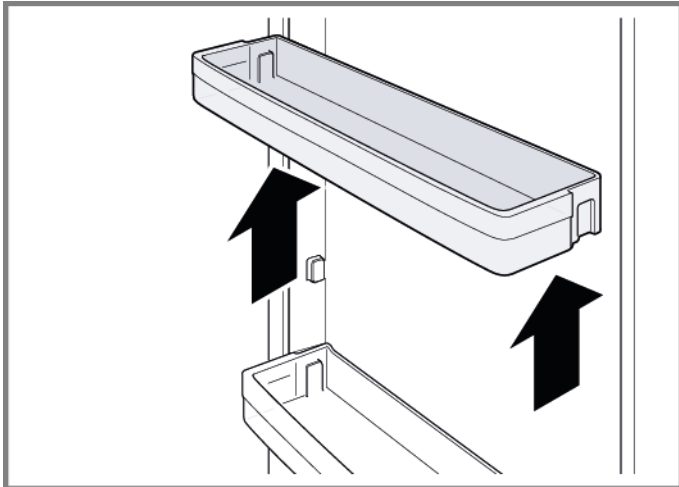

- ➡ Eltávolította az ajtópolcot.

### 4.12.2 Az ajtópolc felhelyezése

- ▶ Az elhelyezést fordított sorrendben végezze.

## 4.13 Fagyasztódoboz cseréje

### Követelmény:

- ✔ Az ajtó nyitva van

### 4.13.1 Fagyasztódoboz eltávolítása

- ▶ 1. Húzza ki teljesen a fagyasztódobozt (1).
- ▶ 2. Távolítsa el a fagyasztódobozt (2).

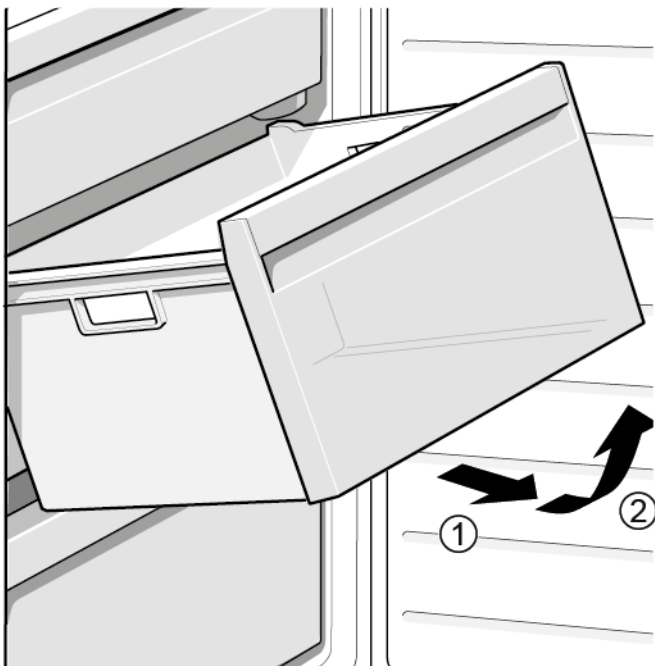

- ➡ Eltávolította a fagyasztódobozt.

### 4.13.2 A fagyasztódoboz behelyezése

- ▶ Az elhelyezést fordított sorrendben végezze.

## 4.14 Tároló cseréje

### Követelmény:

- ✔ Az ajtó nyitva van

### 4.14.1 Tároló eltávolítása

- ▶ 1. Húzza ki az alsó tárolót (1).
- ▶ 2. Húzza ki a felső tárolót (2).

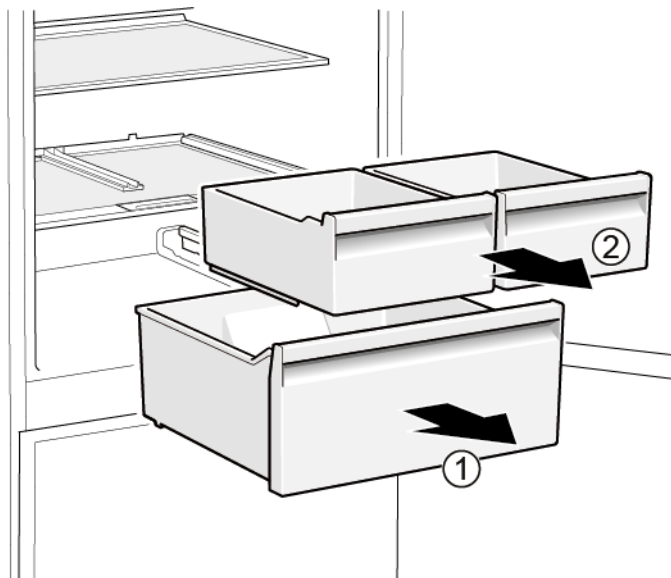

- ➡ Eltávolította a tárolókat.

### 4.14.2 A tároló behelyezése

- ▶ Az elhelyezést fordított sorrendben végezze.

## 4.15 A kihúzható tároló cseréje

### Követelmény:

- ✔ Az ajtó nyitva van

### 4.15.1 A kihúzható tároló eltávolítása

- ▶ 1. Húzza ki teljesen a kihúzható tárolót (1).
- ▶ 2. Távolítsa el a kihúzható tárolót (2).

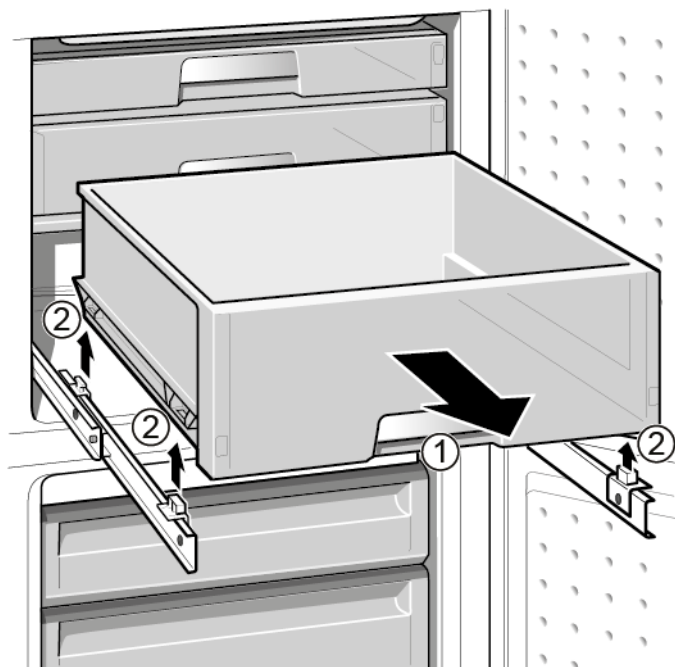

- ➡ Eltávolította a kihúzható tárolót.

### 4.15.2 A kihúzható tároló behelyezése

- ▶ Az elhelyezést fordított sorrendben végezze.

## 4.16 LED-es oldalsó spotvilágítás cseréje

### Különleges eszközök

 Különleges szerszám [00342180]

 A készüléke karbantartásmentes LED-világítással rendelkezik.  
A világítást kizárólag az ügyfélszolgálat vagy szakképzett technikusok javíthatják meg!

 **VESZÉLY**  
**Áramütés veszélye áram alatt lévő alkatrészek miatt!**  
Életveszély a nem megfelelő javítás okozta áramütés miatt

- ▶ Az elektromos alkatrészek javítását kizárólag képzett elektroműszerész végezheti.
- ▶ A javítás után végeztesen a VDE 0701-nek vagy az országspecifikus szabályozásoknak megfelelő vizsgálatot.



 **VESZÉLY**  
**Áramütés veszélye áram alatt lévő alkatrészek miatt!**  
Halálos áramütés

- ▶ A javítás megkezdése előtt legalább 60 másodperccel válassza le a készülékeket az elektromos hálózatról.

 **VIGYÁZAT**  
**Éles szélek!**  
Vágási sérülések

- ▶ Viseljen védőkesztyűt.

### Követelmény:

-  A készüléket leválasztotta az áramellátásról.
-  Az ajtó nyitva van

### 4.16.1 LED-es spotvilágítás eltávolítása

1. Speciális szerszámmal húzza ki a LED-es spotvilágítást (1).



2. Válassza le a LED-es spotvilágítás elektromos csatlakozóit.
-  Eltávolította a LED-es spotvilágítást.

### 4.16.2 A LED-es spotvilágítás beszerelése

- ▶ Az elhelyezést fordított sorrendben végezze.

## 4.17 Felső LED-világítás cseréje

### Különleges eszközök

- Laposfejű csavarhúzó Hegy 2,4 mm x 0,4 mm x 60 mm, a készletben [00341820]

**i** A készüléke karbantartásmentes LED-világítással rendelkezik. A világítást kizárólag az ügyfélszolgálat vagy szakképzett technikusok javíthatják meg!



### ⚠ VESZÉLY

#### Áramütés veszélye áram alatt lévő alkatrészek miatt!

Életveszély a nem megfelelő javítás okozta áramütés miatt

- ▶ Az elektromos alkatrészek javítását kizárólag képzett elektroműszerész végezheti.
- ▶ A javítás után végeztesse a VDE 0701-nek vagy az országspecifikus szabályozásoknak megfelelő vizsgálatot.



### ⚠ VESZÉLY

#### Áramütés veszélye áram alatt lévő alkatrészek miatt!

Halálos áramütés

- ▶ A javítás megkezdése előtt legalább 60 másodperccel válassza le a készülékeket az elektromos hálózatról.



### ⚠ VIGYÁZAT

#### Éles szélek!

Vágási sérülések

- ▶ Viseljen védőkesztyűt.

### Követelmény:

- ✓ A készüléket leválasztotta az áramellátásról.
- ✓ Az ajtó nyitva van
- ✓ Eltávolította a készülék felső szerelvényeit.

### 4.17.1 LED-világítás eltávolítása

- Vigye a LED-világítást a bal oldalra.

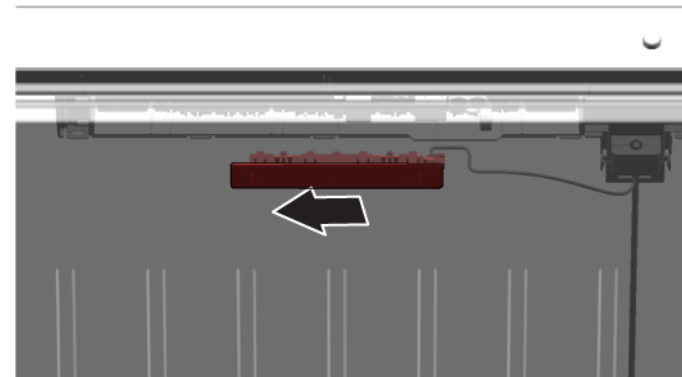

- Leválasztotta a LED-világítás elektromos csatlakozását.

- Oldja ki a LED-világításhoz kapcsolódó horgokat.

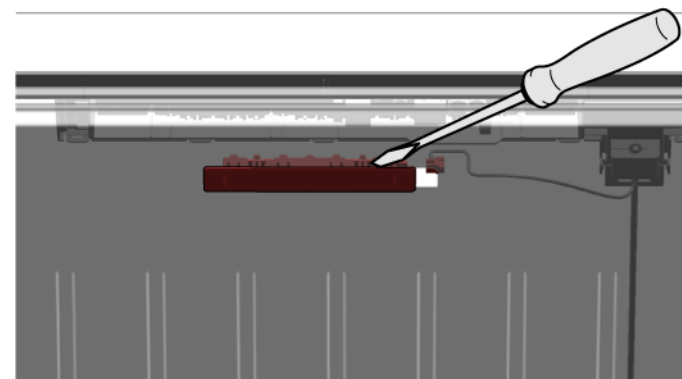

3. Emelje el a készüléktől a LED-világítást.

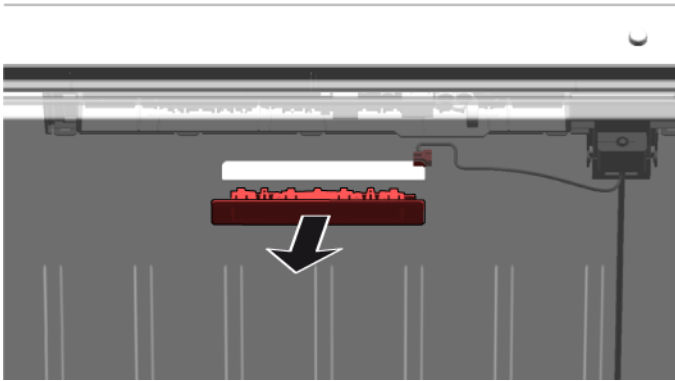

- ➔ Eltávolította a LED-világítást.

### 4.17.2 A felső LED-világítás beszerelése

- ▶ Az elhelyezést fordított sorrendben végezze.

## 4.18 A LED-es oldalvilágítás cseréje

### Különleges eszközök

Tapadókorong Ø50 mm [00342224]



A készüléke karbantartásmentes LED-világítással rendelkezik.  
A világítást kizárólag az ügyfélszolgálat vagy szakképzett technikusok javíthatják meg!



### **⚠ VESZÉLY**

#### Áramütés veszélye áram alatt lévő alkatrészek miatt!

Életveszély a nem megfelelő javítás okozta áramütés miatt

- ▶ Az elektromos alkatrészek javítását kizárólag képzett elektroműszerész végezheti.
- ▶ A javítás után végeztesen a VDE 0701-nek vagy az országspecifikus szabályozásoknak megfelelő vizsgálatot.



### **⚠ VESZÉLY**

#### Áramütés veszélye áram alatt lévő alkatrészek miatt!

Halálos áramütés

- ▶ A javítás megkezdése előtt legalább 60 másodperccel válassza le a készülékeket az elektromos hálózatról.



### **⚠ VIGYÁZAT**

#### Éles szélek!

Vágási sérülések

- ▶ Viseljen védőkesztyűt.

### Követelmény:

- ✓ A készüléket leválasztotta az áramellátásról.
- ✓ Az ajtó nyitva van
- ✓ eltávolította a hűtőszekrény polcait.

## 4.18.1 LED-es oldalvilágítás eltávolítása

1. Nyomja a tapadókorongot a LED-es oldalvilágítás felső harmadára.



- Húzza maga felé a tapadókorongot a LED-es oldalvilágítással együtt egyetlen forgó mozdulattal.

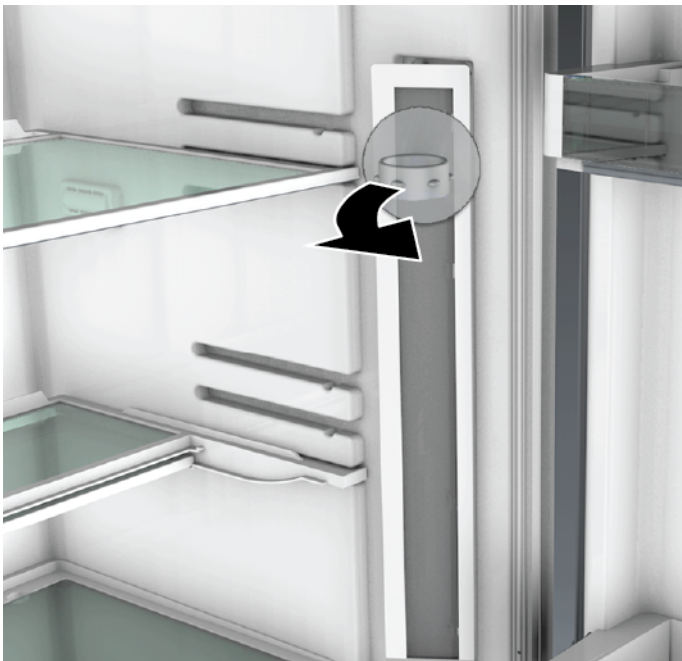





- Váltsza le az elektromos csatlakozást a LED-es oldalvilágításról.  
➡ Eltávolította a LED-es oldalvilágítást.

### 4.18.2 A LED-es oldalvilágítás beszerelése

- Csatlakoztassa az elektromos csatlakozást a LED-es oldalvilágításhoz.
  - Rögzítse a LED-es oldalvilágítást a helyére a rekeszfalon (kattanó hang).
- ➡ Beszerelte a LED-es oldalvilágítást.

# Consigli di riparazione - Frigorifero e congelatore

 <b>Utilizzo del documento</b> .....	<b>327</b>		
1.1 Avvertenze importanti .....	327		
1.1.1 Scopo.....	327		
1.2 Spiegazione dei simboli .....	327		
1.2.1 Livelli di pericolo .....	327		
1.2.2 Simboli di pericolo .....	327		
1.2.3 Struttura degli avvertimenti .....	328		
1.2.4 Simboli generici .....	328		
 <b>Sicurezza</b> .....	<b>329</b>		
2.1 Note generali sulla sicurezza.....	329		
2.1.1 Tutti gli elettrodomestici.....	329		
 <b>Strumenti e ausili</b> .....	<b>330</b>		
 <b>Riparazione</b> .....	<b>331</b>		
4.1 Sostituzione della guarnizione della porta .....	331		
4.2 Sostituzione della maniglia della porta .....	332		
4.2.1 Smontaggio della maniglia della porta .....	332		
4.2.2 Montaggio della maniglia della porta .....	332		
4.3 Sostituzione della cerniera superiore della porta.....	333		
4.3.1 Smontaggio della cerniera superiore della porta.....	333		
4.3.2 Montaggio della cerniera superiore della porta.....	334		
4.4 Sostituzione della cerniera superiore della porta (porta con display) .....	335		
4.4.1 Smontaggio della cerniera superiore della porta.....	335		
4.4.2 Montaggio della cerniera superiore della porta.....	336		
4.5 Sostituzione della cerniera centrale della porta.....	337		
4.5.1 Smontaggio della cerniera centrale della porta.....	337		
4.5.2 Montaggio della cerniera centrale della porta .....	337		
4.6 Sostituzione della cerniera inferiore della porta.....	338		
4.6.1 Smontaggio della cerniera inferiore della porta .....	338		
4.6.2 Montaggio della cerniera inferiore della porta.....	338		
4.7 Sostituzione del ripiano .....	339		
4.7.1 Smontaggio del ripiano.....	339		
4.7.2 Montaggio del ripiano .....	339		
4.8 Sostituzione del ripiano variabile .....	340		
4.8.1 Smontaggio del ripiano variabile.....	340		
4.8.2 Montaggio del ripiano variabile .....	340		
4.9 Sostituzione del ripiano flessibile.....	341		
4.9.1 Smontaggio del ripiano flessibile .....	341		
4.9.2 Montaggio del ripiano flessibile.....	341		
4.10 Sostituzione del set colazione .....	342		
4.10.1 Smontaggio del set colazione.....	342		
4.10.2 Montaggio del set colazione .....	342		
4.11 Sostituzione del portabottiglie .....	343		
4.11.1 Smontaggio del portabottiglie .....	343		
4.11.2 Montaggio del portabottiglie .....	343		
4.12 Sostituzione del balconcino della porta .....	344		
4.12.1 Smontaggio del balconcino della porta.....	344		
4.12.2 Montaggio del balconcino della porta .....	344		
4.13 Sostituzione del cassetto surgelati .....	345		
4.13.1 Rimozione del cassetto surgelati .....	345		
4.13.2 Inserimento del cassetto surgelati.....	345		
4.14 Sostituzione del cassetto .....	346		
4.14.1 Estrazione del cassetto .....	346		
4.14.2 Inserimento del cassetto .....	346		
4.15 Sostituzione del cassetto estraibile.....	347		
4.15.1 Rimozione del cassetto estraibile.....	347		
4.15.2 Inserimento del cassetto estraibile .....	347		
4.16 Sostituzione del faretto a LED.....	348		
4.16.1 Smontaggio del faretto a LED.....	348		
4.16.2 Montaggio del faretto a LED .....	348		
4.17 Sostituzione della luce a LED superiore.....	349		
4.17.1 Smontaggio della luce a LED .....	349		
4.17.2 Montaggio della luce a LED superiore.....	350		
4.18 Sostituzione della luce a barra laterale a LED .....	351		
4.18.1 Smontaggio della luce a barra laterale a LED .....	351		
4.18.2 Montaggio della luce a barra laterale a LED .....	352		

# **i** Utilizzo del documento

## 1.1 Avvertenze importanti

### 1.1.1 Scopo

Queste istruzioni di riparazione spiegano ai clienti come riparare da soli gli elettrodomestici in conformità alle regole sull'Ecodesign vigenti (al 03/2021).

Contengono informazioni sulla sostituzione di pezzi di ricambio specifici e sulle avvertenze e i rischi correlati.

In caso di domande, contattare l'assistenza tecnica. Il mancato rispetto di tali istruzioni da parte dei clienti ci esonera da qualsiasi responsabilità.

## 1.2 Spiegazione dei simboli

### 1.2.1 Livelli di pericolo

I livelli di avvertimento corrispondono a un simbolo accompagnato da una parola di allerta. La parola di allerta identifica il livello di pericolo.





Livello di avvertimento	Significato
 <b>PERICOLO</b>	Ignorare questo messaggio di avvertimento comporta rischio di morte o ferite gravi.
 <b>AVVERTENZA</b>	Ignorare questo messaggio di avvertimento può comportare rischio di morte o ferite gravi.
 <b>ATTENZIONE</b>	Ignorare questo messaggio di avvertimento può comportare ferite di minore gravità.
 <b>ATTENZIONE!</b>	Ignorare questo messaggio di avvertimento può comportare danni materiali.

Tabella 1: Livelli di pericolo

### 1.2.2 Simboli di pericolo

I simboli di pericolo sono illustrazioni che specificano la tipologia di rischio.

Nella presente documentazione vengono utilizzati i seguenti simboli di pericolo:

Simbolo di pericolo	Significato
	Messaggio di avvertimento generico
	Pericolo di scossa elettrica
	Pericolo di esplosione
	Rischio di ferite da taglio

## Utilizzo del documento







Simbolo di pericolo	Significato
	Pericolo di schiacciamento
	Pericolo derivante da superfici calde
	Pericolo derivante da forti campi magnetici
	Pericolo derivante da radiazioni non ionizzanti

Tabella 2: Simboli di pericolo

### 1.2.3 Struttura degli avvertimenti

Gli avvertimenti presenti in questo manuale hanno una forma e una struttura standardizzati.

	<div style="background-color: red; color: white; padding: 2px; text-align: center;"> <b>PERICOLO</b></div> <p><b>Tipo e origine del pericolo!</b> Possibili conseguenze in caso di pericolo/avvertimento ignorato.</p> <ul style="list-style-type: none"> <li>▸ Misure e divieti volti a prevenire il pericolo.</li> </ul>
--	---

L'esempio seguente mostra un avvertimento con rischio di folgorazione dovuto a componenti sotto tensione. È riportata la misura di precauzione per evitare il pericolo.

	<div style="background-color: red; color: white; padding: 2px; text-align: center;"> <b>PERICOLO</b></div> <p><b>Rischio di scossa elettrica dovuto a componenti sotto tensione!</b> Morte per folgorazione</p> <ul style="list-style-type: none"> <li>▸ Scollegare l'apparecchio dall'alimentazione per almeno 60 secondi prima di iniziare la riparazione.</li> </ul>
--	--

### 1.2.4 Simboli generici

Nel presente manuale vengono utilizzati i seguenti simboli generici:





Simbolo generico	Significato
	Identificazione di un suggerimento speciale (testo e/o grafica)
	Identificazione di un suggerimento semplice (solo testo)
	Identificazione di un link per un video tutorial
	Identificazione degli strumenti necessari
	Identificazione delle condizioni preve necessarie
	Identificazione di una condizione (se ..., allora ...)
	Identificazione di un risultato
[Avvio]	Identificazione di un tasto o di un pulsante
[00123456]	Identificazione di un codice articolo
Stato	Identificazione di un testo/finestra visualizzati (sul display dell'apparecchio)

Tabella 3: Simboli generici

## 2.1 Note generali sulla sicurezza

### 2.1.1 Tutti gli elettrodomestici

#### **Rischio di scosse elettriche dovute a componenti sotto tensione!**

- La riparazione non conforme dei componenti elettrici può causare scosse elettriche!
- Scollegare l'apparecchio dall'alimentazione per almeno 60 secondi prima di iniziare il lavoro.
- Ultimata la riparazione, occorre eseguire un test di sicurezza conforme alla norma VDE 0701 o alle norme specifiche del Paese.

#### **Rischio di lesioni causate da bordi taglienti!**

- Indossare guanti di protezione.

#### **Rischio di schiacciamento dovuto a componenti pesanti e in movimento durante la riparazione, la manutenzione, la ricerca dei guasti e l'assistenza**

- Indossare calzature antinfortunistiche.
- Fissare i componenti pesanti per impedire che cadano.
- Non inserire parti del corpo nei componenti in movimento.

#### **Rischio per il funzionamento o la sicurezza dell'apparecchio!**

- Utilizzare solo ricambi originali.

#### **Rischio di danneggiamento di componenti sensibili a carica elettrostatica (ESD)!**

- Non toccare i moduli, inclusi i collegamenti e le piste conduttive.

## Strumenti e ausili

Designazione	Dettagli	Immagini
Panno di protezione [00342013]	60 cm x 50 cm	
Set di cacciaviti di precisione [00341820]	9 pezzi, 2,0 mm, 2,4 mm, 3,0 mm, PH0, PH00, PH1, TX6, TX8, TX9	
Strumento ausiliario [00342180]	Per lo smontaggio di parti in plastica, "strumento magico".	
Ventosa [00342224]	Ø 50 mm	
Punta Torx TX20 [00340865]	6,3 mm (1/4")	
Cacciavite a taglio	Lama 10 mm x 1,6 mm x 200 mm	



## 4.1 Sostituzione della guarnizione della porta

### Prerequisiti:



- La porta è aperta.

## 4.2 Sostituzione della maniglia della porta

### Attrezzi suggeriti:

-  Punta Torx TX20                      6,3 mm (1/4")                      [00340865]
-  Cacciavite a taglio                      Lama 10 mm x 1,6 mm x 200 mm

### Prerequisiti:

-  L'apparecchio è scollegato dalla rete elettrica.
-  La porta è aperta.

### 4.2.1 Smontaggio della maniglia della porta

- ▶ 1. Togliere i due tappi delle viti (1).
- ▶ 2. Svitare le due viti (2).
- ▶ 3. Smontare la maniglia della porta (3).

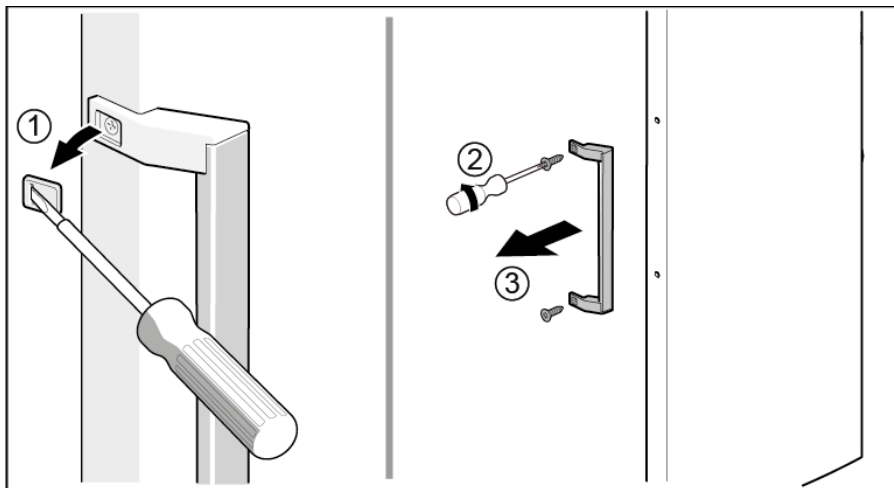

 La maniglia della porta è rimossa.



La maniglia della seconda porta può essere rimossa nello stesso modo.

### 4.2.2 Montaggio della maniglia della porta

- ▶ Per il montaggio, seguire la procedura sopra descritta in senso opposto.

## 4.3 Sostituzione della cerniera superiore della porta

### Attrezzi suggeriti:

🔧 Punta Torx TX20      6,3 mm (1/4")      [00340865]

	<b>⚠️ AVVERTENZA</b>
<b>Apparecchi pesanti, ingombranti!</b>	
Rischio di infortuni muscolari e alla schiena	
<ul style="list-style-type: none"> <li>▶ L'operazione di smontaggio della porta dell'apparecchio deve essere eseguita soltanto da tecnici addestrati.</li> <li>▶ Spostare l'apparecchio in due persone.</li> <li>▶ Usare solo utensili e attrezzature idonei.</li> </ul>	

	<b>⚠️ ATTENZIONE</b>
<b>Bordi taglienti!</b>	
Ferite da taglio	
<ul style="list-style-type: none"> <li>▶ Indossare guanti di protezione.</li> </ul>	

	<b>⚠️ AVVERTENZA</b>
<b>Gli apparecchi inclinati possono scivolare!</b>	
Fratture / lesioni da schiacciamento	
<ul style="list-style-type: none"> <li>▶ Fissare gli apparecchi in modo che non scivolino.</li> </ul>	

	<b>⚠️ ATTENZIONE</b>
<b>Rischio di caduta di componenti a causa di viti allentate!</b>	
Lesioni provocate dalla caduta di componenti.	
<ul style="list-style-type: none"> <li>▶ Fissare i componenti in modo che non cadano.</li> </ul>	

	<b>ATTENZIONE!</b>
<b>Rischio di caduta di componenti a causa di viti allentate!</b>	
Danni a altre parti dell'apparecchio o all'abitazione del cliente, ad es. parte inferiore.	
<ul style="list-style-type: none"> <li>▶ Fissare i componenti in modo che non cadano.</li> </ul>	

### Prerequisiti:

- ✔️ L'apparecchio è scollegato dalla rete elettrica.
- ✔️ Gli accessori interni dell'apparecchio sono stati rimossi.

### 4.3.1 Smontaggio della cerniera superiore della porta

1. Coricare l'apparecchio sul retro.

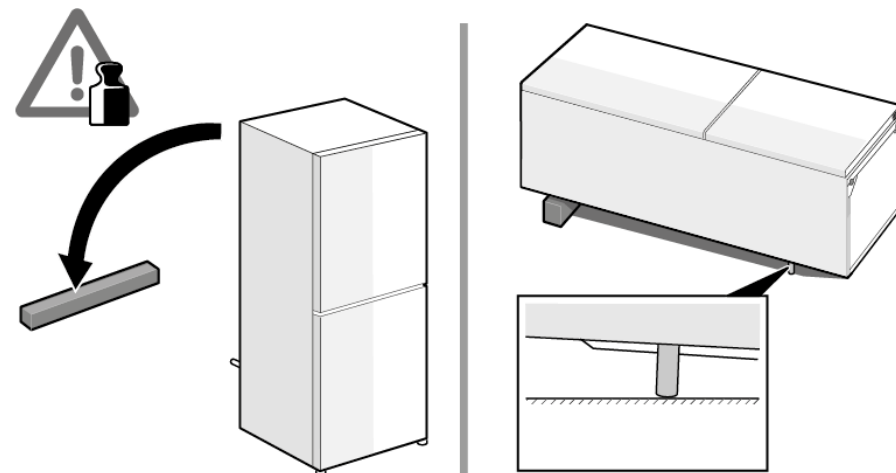

## Riparazione

2. 1. Premere la copertura della cerniera superiore su entrambi i lati (1).
2. Tirare la copertura della cerniera superiore verso l'esterno (2).
3. Ruotare la copertura della cerniera (3).
4. Togliere la copertura superiore della cerniera (4).
5. Svitare le due viti (5).
6. Togliere la cerniera superiore (6)

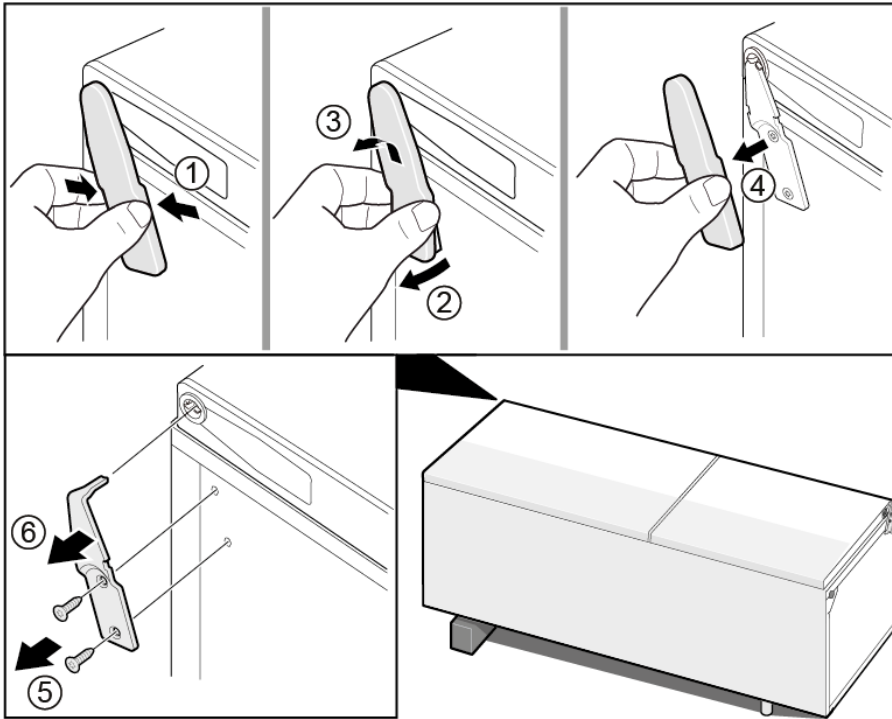

 La cerniera superiore è rimossa.

### 4.3.2 Montaggio della cerniera superiore della porta

- ▶ Per il montaggio, seguire la procedura sopra descritta in senso opposto.

## 4.4 Sostituzione della cerniera superiore della porta (porta con display)

Attrezzi suggeriti:

 Punta Torx TX20      6,3 mm (1/4")      [00340865]

	<b>⚠ AVVERTENZA</b>
	<p><b>Apparecchi pesanti, ingombranti!</b> Rischio di infortuni muscolari e alla schiena</p> <ul style="list-style-type: none"> <li>▶ L'operazione di smontaggio della porta dell'apparecchio deve essere eseguita soltanto da tecnici addestrati.</li> <li>▶ Spostare l'apparecchio in due persone.</li> <li>▶ Usare solo utensili e attrezzature idonei.</li> </ul>

	<b>⚠ ATTENZIONE</b>
	<p><b>Bordi taglienti!</b> Ferite da taglio</p> <ul style="list-style-type: none"> <li>▶ Indossare guanti di protezione.</li> </ul>

	<b>⚠ AVVERTENZA</b>
	<p><b>Gli apparecchi inclinati possono scivolare!</b> Fratture / lesioni da schiacciamento</p> <ul style="list-style-type: none"> <li>▶ Fissare gli apparecchi in modo che non scivolino.</li> </ul>



	<b>⚠ ATTENZIONE</b>
	<p><b>Rischio di caduta di componenti a causa di viti allentate!</b> Lesioni provocate dalla caduta di componenti.</p> <ul style="list-style-type: none"> <li>▶ Fissare i componenti in modo che non cadano.</li> </ul>

	<b>ATTENZIONE!</b>
	<p><b>Rischio di caduta di componenti a causa di viti allentate!</b> Danni a altre parti dell'apparecchio o all'abitazione del cliente, ad es. parte inferiore.</p> <ul style="list-style-type: none"> <li>▶ Fissare i componenti in modo che non cadano.</li> </ul>

	<b>⚠ PERICOLO</b>
	<p><b>Rischio di scosse elettriche dovute a componenti sotto tensione!</b> Pericolo di morte dovuto a scosse elettriche in caso di riparazione non conforme</p> <ul style="list-style-type: none"> <li>▶ Le parti elettriche devono essere riparate da elettricisti qualificati.</li> <li>▶ Ultimata la riparazione, occorre eseguire un test di sicurezza conforme alla norma VDE 0701 o alle norme specifiche del Paese.</li> </ul>

	<b>⚠ PERICOLO</b>
	<p><b>Rischio di scossa elettrica dovuto a componenti sotto tensione!</b> Morte per folgorazione</p> <ul style="list-style-type: none"> <li>▶ Scollegare l'apparecchio dall'alimentazione per almeno 60 secondi prima di iniziare la riparazione.</li> </ul>

Prerequisiti:

-  L'apparecchio è scollegato dalla rete elettrica.
-  Gli accessori interni dell'apparecchio sono stati rimossi.

### 4.4.1 Smontaggio della cerniera superiore della porta

1. Coricare l'apparecchio sul retro.

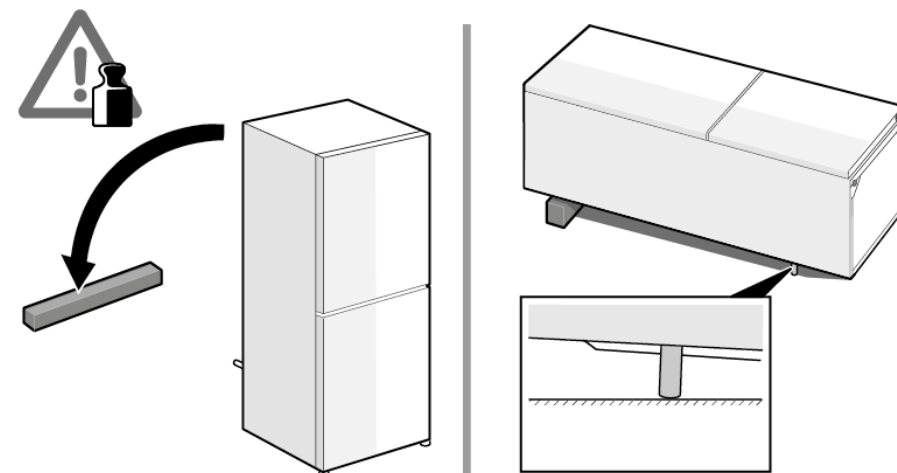

## Riparazione

2. 1. Togliere la copertura superiore della cerniera (1).
2. Togliere il coperchio del cavo (2).
3. Staccare il collegamento elettrico (3).
4. Svitare la vite del collegamento di messa a terra (4).
5. Togliere la protezione del cavo (5).
6. Svitare la vite (6).

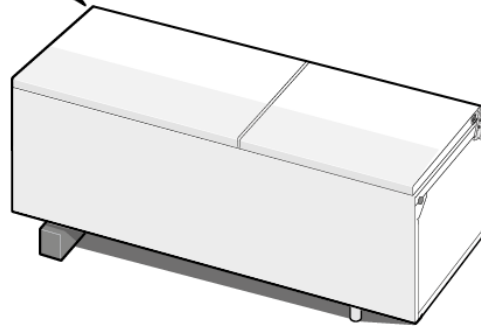
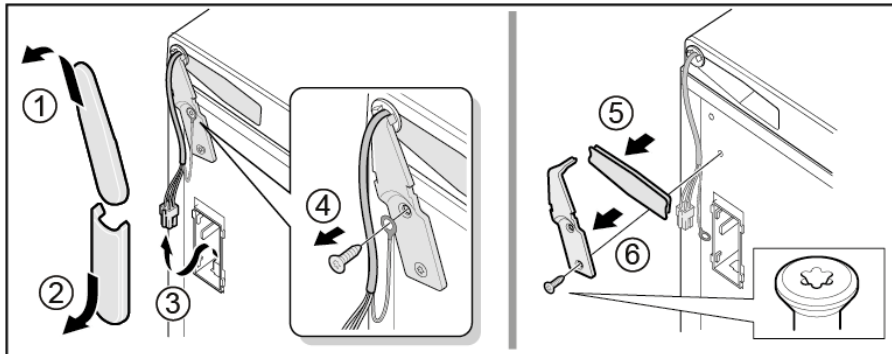

 La cerniera superiore è rimossa.

### 4.4.2 Montaggio della cerniera superiore della porta

- ▶ Per il montaggio, seguire la procedura sopra descritta in senso opposto.

## 4.5 Sostituzione della cerniera centrale della porta

### Attrezzi suggeriti:

🔧 Punta Torx TX20      6,3 mm (1/4")      [00340865]

	<b>⚠️ AVVERTENZA</b>
<b>Apparecchi pesanti, ingombranti!</b>	
Rischio di infortuni muscolari e alla schiena	
<ul style="list-style-type: none"> <li>▶ L'operazione di smontaggio della porta dell'apparecchio deve essere eseguita soltanto da tecnici addestrati.</li> <li>▶ Spostare l'apparecchio in due persone.</li> <li>▶ Usare solo utensili e attrezzature idonei.</li> </ul>	

	<b>⚠️ ATTENZIONE</b>
<b>Bordi taglienti!</b>	
Ferite da taglio	
<ul style="list-style-type: none"> <li>▶ Indossare guanti di protezione.</li> </ul>	

	<b>⚠️ AVVERTENZA</b>
<b>Gli apparecchi inclinati possono scivolare!</b>	
Fratture / lesioni da schiacciamento	
<ul style="list-style-type: none"> <li>▶ Fissare gli apparecchi in modo che non scivolino.</li> </ul>	

	<b>⚠️ ATTENZIONE</b>
<b>Rischio di caduta di componenti a causa di viti allentate!</b>	
Lesioni provocate dalla caduta di componenti.	
<ul style="list-style-type: none"> <li>▶ Fissare i componenti in modo che non cadano.</li> </ul>	

	<b>ATTENZIONE!</b>
<b>Rischio di caduta di componenti a causa di viti allentate!</b>	
Danni a altre parti dell'apparecchio o all'abitazione del cliente, ad es. parte inferiore.	
<ul style="list-style-type: none"> <li>▶ Fissare i componenti in modo che non cadano.</li> </ul>	

### Prerequisiti:

- ✔️ L'apparecchio è scollegato dalla rete elettrica.
- ✔️ Gli accessori interni dell'apparecchio sono stati rimossi.
- ✔️ La cerniera superiore della porta è rimossa.

✔️ La porta superiore è rimossa.

### 4.5.1 Smontaggio della cerniera centrale della porta

- ▶ 1. Togliere la porta del comparto frigorifero (1).
- ▶ 2. Svitare le due viti (2).
- ▶ 3. Rimuovere la cerniera centrale (3).

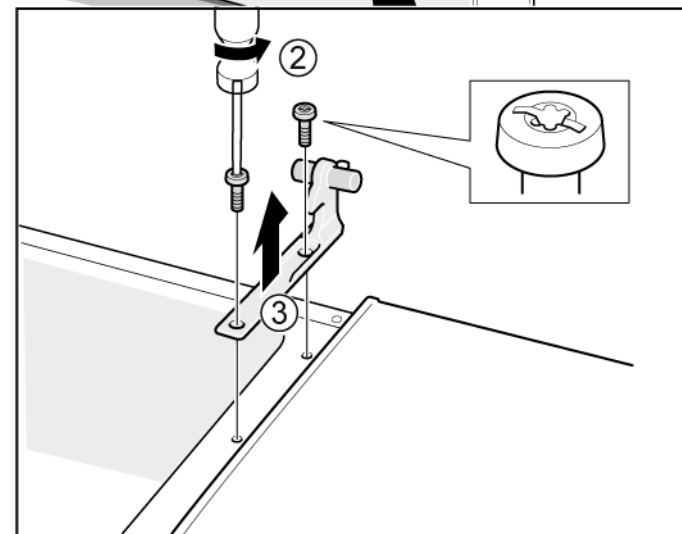
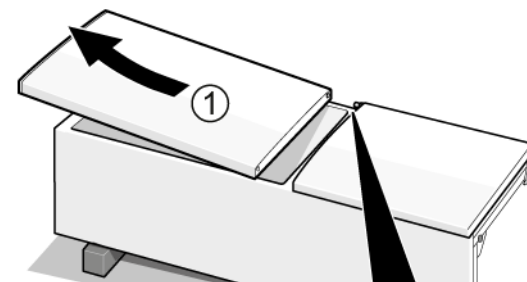

➡️ La cerniera centrale è rimossa.

### 4.5.2 Montaggio della cerniera centrale della porta

- ▶ Per il montaggio, seguire la procedura sopra descritta in senso opposto.

## 4.6 Sostituzione della cerniera inferiore della porta

### Attrezzi suggeriti:

🔧 Punta Torx TX20      6,3 mm (1/4")      [00340865]

	<b>⚠️ AVVERTENZA</b>
	<p><b>Apparecchi pesanti, ingombranti!</b>          Rischio di infortuni muscolari e alla schiena</p> <ul style="list-style-type: none"> <li>▶ L'operazione di smontaggio della porta dell'apparecchio deve essere eseguita soltanto da tecnici addestrati.</li> <li>▶ Spostare l'apparecchio in due persone.</li> <li>▶ Usare solo utensili e attrezzature idonei.</li> </ul>

	<b>⚠️ ATTENZIONE</b>
	<p><b>Bordi taglienti!</b>          Ferite da taglio</p> <ul style="list-style-type: none"> <li>▶ Indossare guanti di protezione.</li> </ul>

	<b>⚠️ AVVERTENZA</b>
	<p><b>Gli apparecchi inclinati possono scivolare!</b>          Fratture / lesioni da schiacciamento</p> <ul style="list-style-type: none"> <li>▶ Fissare gli apparecchi in modo che non scivolino.</li> </ul>

	<b>⚠️ ATTENZIONE</b>
	<p><b>Rischio di caduta di componenti a causa di viti allentate!</b>          Lesioni provocate dalla caduta di componenti.</p> <ul style="list-style-type: none"> <li>▶ Fissare i componenti in modo che non cadano.</li> </ul>

	<b>ATTENZIONE!</b>
	<p><b>Rischio di caduta di componenti a causa di viti allentate!</b>          Danni a altre parti dell'apparecchio o all'abitazione del cliente, ad es. parte inferiore.</p> <ul style="list-style-type: none"> <li>▶ Fissare i componenti in modo che non cadano.</li> </ul>

### Prerequisiti:

- ✔ L'apparecchio è scollegato dalla rete elettrica.
- ✔ Gli accessori interni dell'apparecchio sono stati rimossi.
- ✔ La cerniera superiore è rimossa.

✔ La cerniera centrale è rimossa.

### 4.6.1 Smontaggio della cerniera inferiore della porta

- ▶ 1. Togliere la porta del comparto freezer (1).
- ▶ 2. Svitare la vite (2).
- ▶ 3. Ruotare la cerniera inferiore verso l'esterno (3).
- ▶ 4. Togliere la cerniera inferiore (4).

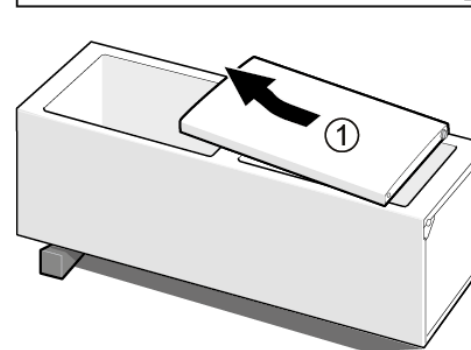
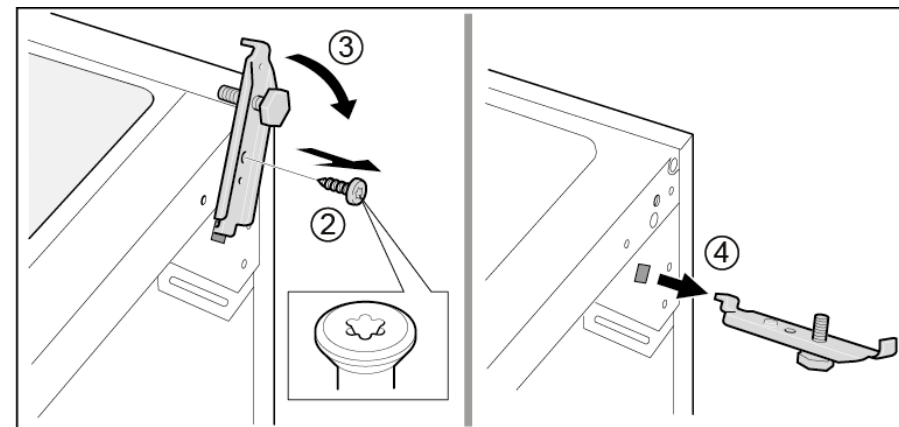

➡ La cerniera inferiore della porta è rimossa.

### 4.6.2 Montaggio della cerniera inferiore della porta

- ▶ Per il montaggio, seguire la procedura sopra descritta in senso opposto.

## 4.7 Sostituzione del ripiano

### Prerequisiti:

- ✔ La porta è aperta.

### 4.7.1 Smontaggio del ripiano

- ▶ Estrarre il ripiano.

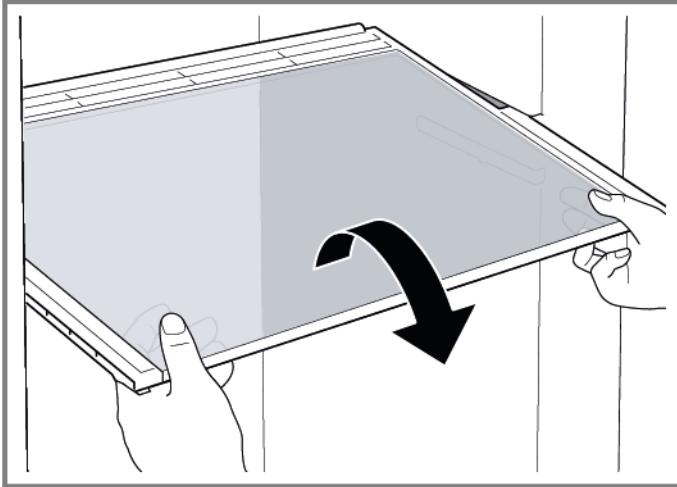

➡ Il ripiano è rimosso.

### 4.7.2 Montaggio del ripiano

- ▶ Per il montaggio, seguire la procedura sopra descritta in senso opposto.

## 4.8 Sostituzione del ripiano variabile

### Prerequisiti:

- ✔ La porta è aperta.

### 4.8.1 Smontaggio del ripiano variabile

1. Tirare la parte destra del ripiano variabile in avanti (1).
2. Rimuovere la parte destra del ripiano variabile (2).

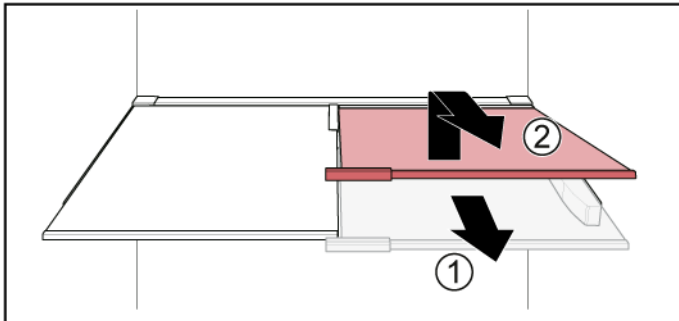

2. Rimuovere la parte sinistra del ripiano variabile nello stesso modo.

- ➡ Il ripiano variabile è rimosso.

### 4.8.2 Montaggio del ripiano variabile

- ▶ Per il montaggio, seguire la procedura sopra descritta in senso opposto.

## 4.9 Sostituzione del ripiano flessibile

### Prerequisiti:

- ✔ La porta è aperta.

### 4.9.1 Smontaggio del ripiano flessibile

- ▶ 1. Rimuovere il ripiano in vetro (1).
- ▶ 2. Sollevare il ripiano flessibile ed estrarlo (2).

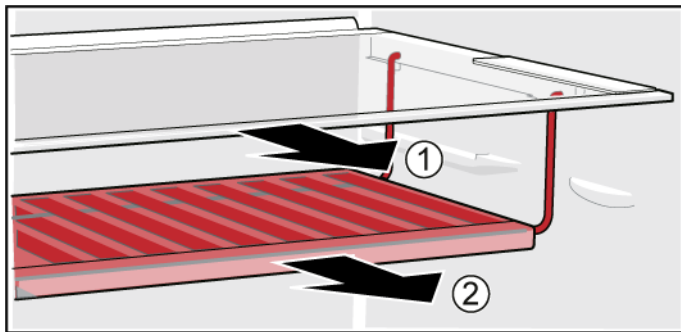

- ➡ Il ripiano flessibile è rimosso.

### 4.9.2 Montaggio del ripiano flessibile

- ▶ Per il montaggio, seguire la procedura sopra descritta in senso opposto.

## 4.10 Sostituzione del set colazione

### Prerequisiti:

- ✔ La porta è aperta.

### 4.10.1 Smontaggio del set colazione

- ▶ Sollevare il set colazione ed estrarlo.

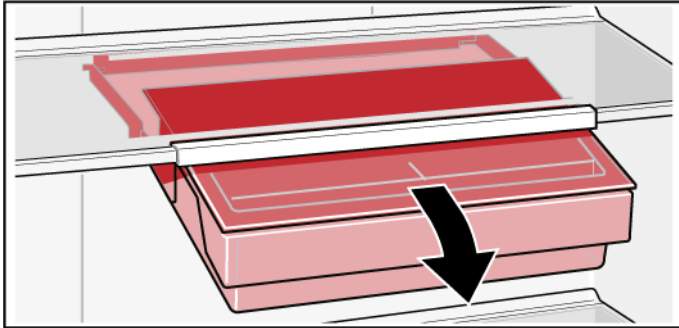

- ➡ Il set colazione è rimosso.

### 4.10.2 Montaggio del set colazione

- ▶ Per il montaggio, seguire la procedura sopra descritta in senso opposto.

## 4.11 Sostituzione del portabottiglie

### Prerequisiti:

- ✔ La porta è aperta.

### 4.11.1 Smontaggio del portabottiglie

- ▶ Estrarre il portabottiglie.

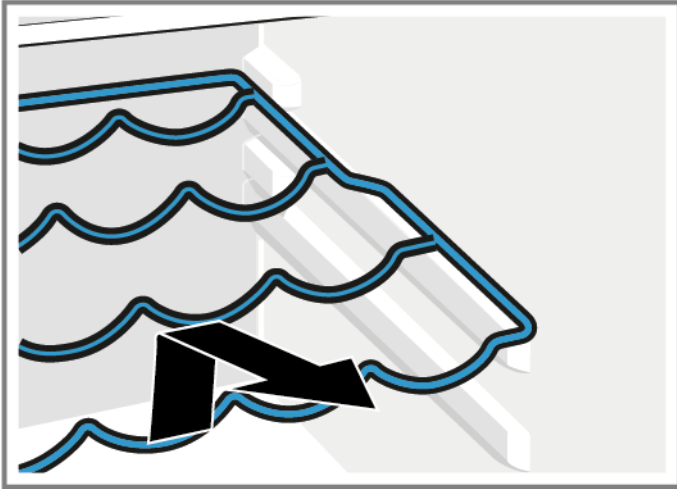

- ➡ Il portabottiglie è rimosso.

### 4.11.2 Montaggio del portabottiglie

- ▶ Per il montaggio, seguire la procedura sopra descritta in senso opposto.

## 4.12 Sostituzione del balconcino della porta

### Prerequisiti:

- ✔ La porta è aperta.

### 4.12.1 Smontaggio del balconcino della porta

- ▶ Tirare il balconcino della porta verso l'alto.

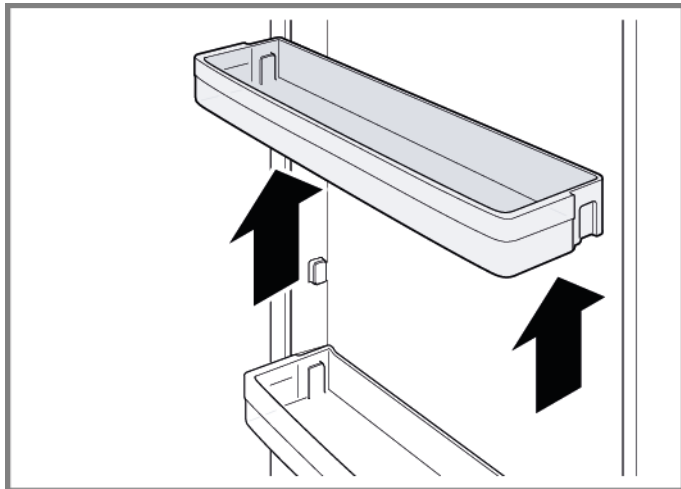

➡ Il balconcino della porta è rimosso.

### 4.12.2 Montaggio del balconcino della porta

- ▶ Per il montaggio, seguire la procedura sopra descritta in senso opposto.

## 4.13 Sostituzione del cassetto surgelati

### Prerequisiti:

- ✔ La porta è aperta.

### 4.13.1 Rimozione del cassetto surgelati

- ▶ 1. Estrarre completamente il cassetto surgelati (1).
- ▶ 2. Togliere il cassetto surgelati (2).

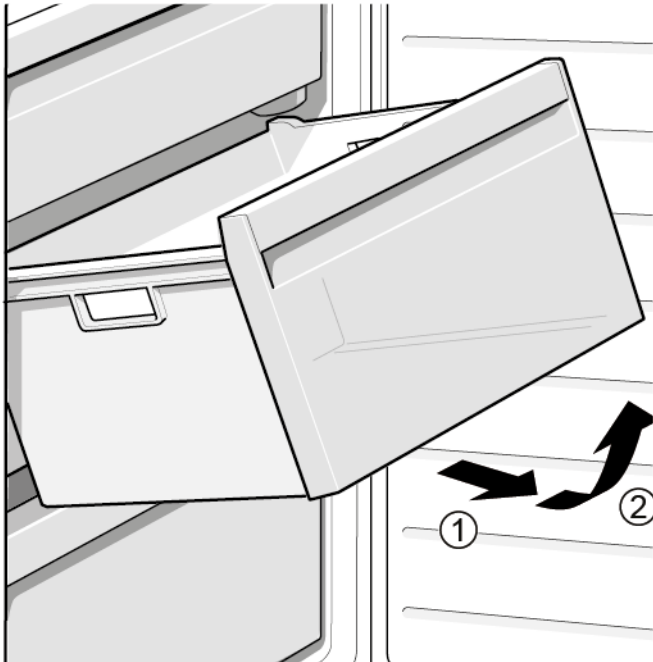

- ➡ Il cassetto surgelati è rimosso.

### 4.13.2 Inserimento del cassetto surgelati

- ▶ Per il montaggio, seguire la procedura sopra descritta in senso opposto.

## 4.14 Sostituzione del cassetto

### Prerequisiti:

- ✔ La porta è aperta.

### 4.14.1 Estrazione del cassetto

- ▶ 1. Estrarre il cassetto inferiore (1).
- ▶ 2. Estrarre il cassetto superiore (2).

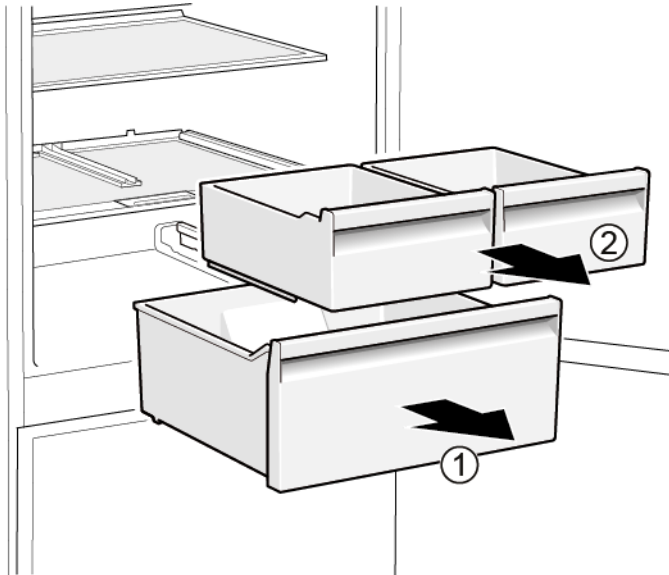

➡ I cassetti sono rimossi.

### 4.14.2 Inserimento del cassetto

- ▶ Per il montaggio, seguire la procedura sopra descritta in senso opposto.

## 4.15 Sostituzione del cassetto estraibile

### Prerequisiti:

- ✔ La porta è aperta.

### 4.15.1 Rimozione del cassetto estraibile

- ▶ 1. Estrarre completamente il cassetto (1).
- ▶ 2. Togliere il cassetto estraibile (2).

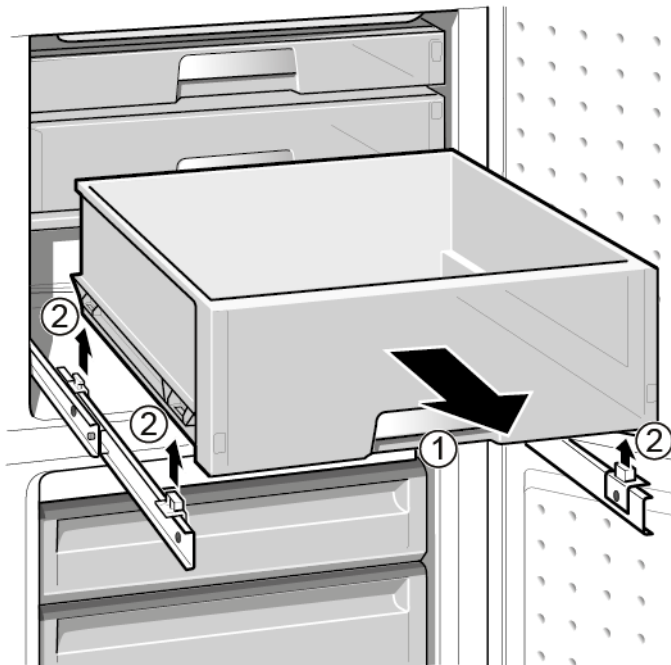

- ➡ Il cassetto estraibile è rimosso.

### 4.15.2 Inserimento del cassetto estraibile

- ▶ Per il montaggio, seguire la procedura sopra descritta in senso opposto.

## 4.16 Sostituzione del faretto a LED

### Attrezzi suggeriti:

Utensile speciale [00342180]

**i** L'apparecchio è dotato di una luce a LED esente da manutenzione. Queste luci possono essere riparate esclusivamente dall'assistenza clienti o da tecnici autorizzati!

**⚠ PERICOLO**  
**Rischio di scosse elettriche dovute a componenti sotto tensione!**  
Pericolo di morte dovuto a scosse elettriche in caso di riparazione non conforme

- ▶ Le parti elettriche devono essere riparate da elettricisti qualificati.
- ▶ Ultimata la riparazione, occorre eseguire un test di sicurezza conforme alla norma VDE 0701 o alle norme specifiche del Paese.

**⚠ PERICOLO**  
**Rischio di scossa elettrica dovuto a componenti sotto tensione!**  
Morte per folgorazione

- ▶ Scollegare l'apparecchio dall'alimentazione per almeno 60 secondi prima di iniziare la riparazione.

**⚠ ATTENZIONE**  
**Bordi taglienti!**  
Ferite da taglio

- ▶ Indossare guanti di protezione.

### Prerequisiti:

- ✓ L'apparecchio è scollegato dalla rete elettrica.
- ✓ La porta è aperta.

### 4.16.1 Smontaggio del faretto a LED

1. Utilizzare l'utensile speciale per estrarre il faretto a LED (1).



2. Rimuovere i collegamenti elettrici del faretto a LED.

➡ Il faretto a LED è rimosso.

### 4.16.2 Montaggio del faretto a LED

- ▶ Per il montaggio, seguire la procedura sopra descritta in senso opposto.

## 4.17 Sostituzione della luce a LED superiore

### Attrezzi suggeriti:

- Cacciavite a taglio Lama 2,4 mm x 0,4 mm x 60 mm, nel kit [00341820]



L'apparecchio è dotato di una luce a LED esente da manutenzione. Queste luci possono essere riparate esclusivamente dall'assistenza tecnica o da tecnici autorizzati!



### PERICOLO

**Rischio di scosse elettriche dovute a componenti sotto tensione!**  
Pericolo di morte dovuto a scosse elettriche in caso di riparazione non conforme

- Le parti elettriche devono essere riparate da elettricisti qualificati.
- Ultimata la riparazione, occorre eseguire un test di sicurezza conforme alla norma VDE 0701 o alle norme specifiche del Paese.



### PERICOLO

**Rischio di scossa elettrica dovuto a componenti sotto tensione!**

Morte per folgorazione

- Scollegare l'apparecchio dall'alimentazione per almeno 60 secondi prima di iniziare la riparazione.



### ATTENZIONE

**Bordi taglienti!**

Ferite da taglio

- Indossare guanti di protezione.

### Prerequisiti:

- L'apparecchio è scollegato dalla rete elettrica.
- La porta è aperta.
- Gli accessori interni superiori sono stati rimossi.

## 4.17.1 Smontaggio della luce a LED

1. Spostare la luce a LED sul lato sinistro.

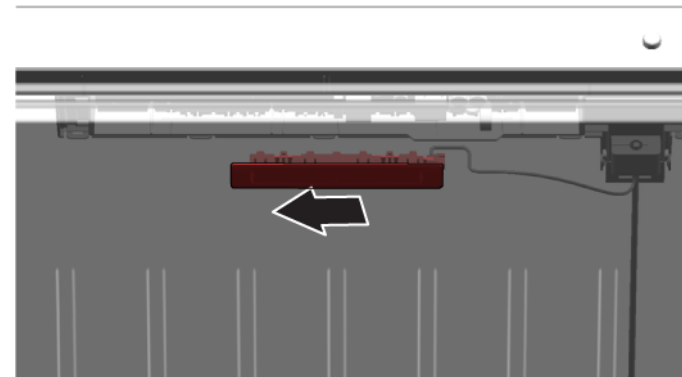

- Il collegamento elettrico della luce a LED è scollegato.

2. Sbloccare i fermi della luce a LED.

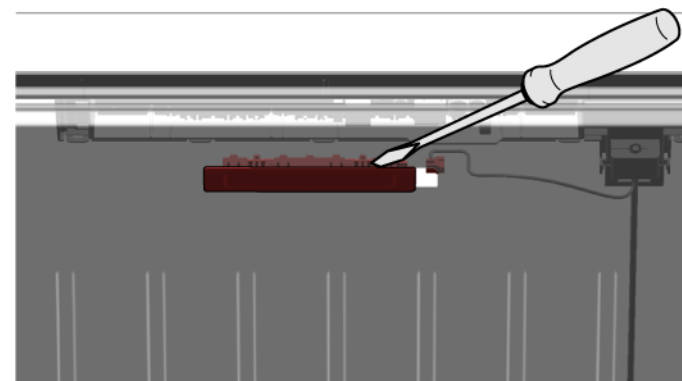

3. Togliere la luce a LED spostandola in avanti.

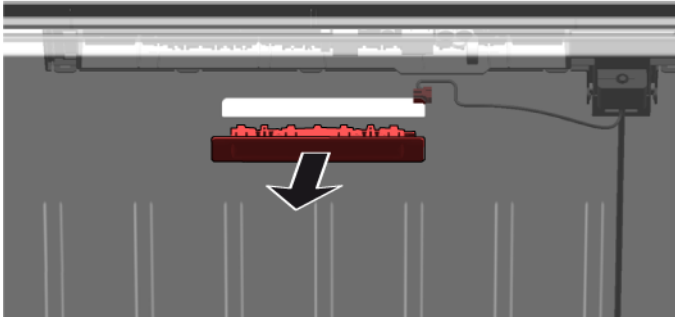

- ➡ La luce LED è rimossa.

### 4.17.2 Montaggio della luce a LED superiore

- ▶ Per il montaggio, seguire la procedura sopra descritta in senso opposto.

## 4.18 Sostituzione della luce a barra laterale a LED

### Attrezzi suggeriti:

Ventosa Ø50 mm [00342224]



L'apparecchio è dotato di una luce a LED esente da manutenzione. Queste luci possono essere riparate esclusivamente dall'assistenza clienti o da tecnici autorizzati!



### PERICOLO

**Rischio di scosse elettriche dovute a componenti sotto tensione!**  
Pericolo di morte dovuto a scosse elettriche in caso di riparazione non conforme

- ▶ Le parti elettriche devono essere riparate da elettricisti qualificati.
- ▶ Ultimata la riparazione, occorre eseguire un test di sicurezza conforme alla norma VDE 0701 o alle norme specifiche del Paese.



### PERICOLO

**Rischio di scossa elettrica dovuto a componenti sotto tensione!**  
Morte per folgorazione

- ▶ Scollegare l'apparecchio dall'alimentazione per almeno 60 secondi prima di iniziare la riparazione.



### ATTENZIONE

**Bordi taglienti!**

Ferite da taglio

- ▶ Indossare guanti di protezione.

### Prerequisiti:

- ✓ L'apparecchio è scollegato dalla rete elettrica.
- ✓ La porta è aperta.
- ✓ I ripiani del comparto frigorifero sono rimossi.

## 4.18.1 Smontaggio della luce a barra laterale a LED

1. Fissare la ventosa sul terzo superiore della luce a barra laterale a LED.



## Riparazione

2. Tirare la ventosa in avanti con la luce a barra laterale a LED con un unico movimento rotatorio.

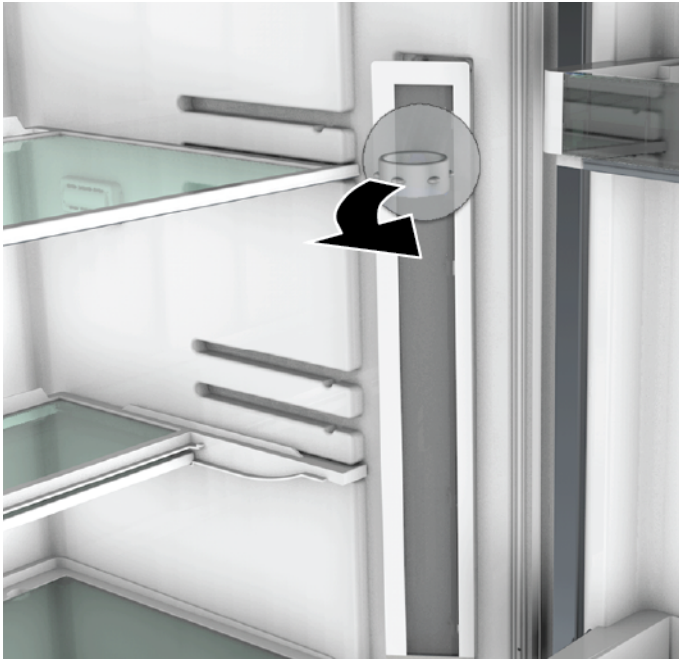

3. Staccare il collegamento della luce a barra laterale a LED.  
 La luce a barra laterale a LED è rimossa.

### 4.18.2 Montaggio della luce a barra laterale a LED

1. Collegare il collegamento elettrico della luce a barra laterale a LED.
  2. Fissare la luce a barra laterale a LED in posizione sulla parete del comparto (i fermi si agganciano).
-  La luce a barra laterale a LED è montata.

# Informācija par remontu - Dzesēšanas un saldēšanas ierīce

## Par šo dokumentu..... 354

1.1	Būtiska informācija .....	354
1.1.1	Mērķis .....	354
1.2	Simbolu skaidrojums.....	354
1.2.1	Bīstamības līmeņi .....	354
1.2.2	Bīstamības simboli.....	354
1.2.3	Brīdinājumu struktūra .....	355
1.2.4	Vispārīgie simboli.....	355

## Drošība..... 356

2.1	Vispārējie drošības norādījumi .....	356
2.1.1	Visām mājsaimniecības ierīcēm .....	356

## Piederumi un palīgļīdzekļi..... 357

## Remonts .....

4.1	Durvju blīvslēga nomaiņa .....	358
4.2	Durvju roktura nomaiņa.....	359
4.2.1	Durvju roktura noņemšana.....	359
4.2.2	Durvju roktura uzstādīšana .....	359
4.3	Durvju augšējās viras nomaiņa.....	360
4.3.1	Durvju augšējās viras noņemšana.....	360
4.3.2	Durvju augšējās viras uzstādīšana .....	361
4.4	Durvju augšējās viras nomaiņa (durvis ar displeju) .....	362
4.4.1	Durvju augšējās viras noņemšana.....	362
4.4.2	Durvju augšējās viras uzstādīšana .....	363
4.5	Durvju vidējās viras nomaiņa.....	364
4.5.1	Durvju vidējās viras noņemšana.....	364
4.5.2	Durvju vidējās viras uzstādīšana .....	364
4.6	Durvju apakšējās viras nomaiņa .....	365
4.6.1	Durvju apakšējās viras noņemšana.....	365
4.6.2	Durvju apakšējās viras uzstādīšana .....	365
4.7	Plaukta nomaiņa.....	366
4.7.1	Plaukta izņemšana.....	366
4.7.2	Plaukta uzstādīšana .....	366
4.8	Divdaļīgā plaukta nomaiņa .....	367

4.8.1	Divdaļīgā plaukta izņemšana.....	367
4.8.2	Divdaļīgā plaukta uzstādīšana .....	367
4.9	Pielāgojamā plaukta nomaiņa .....	368
4.9.1	Pielāgojamā plaukta izņemšana .....	368
4.9.2	Pielāgojamā plaukta uzstādīšana .....	368
4.10	Brokastu tvertnes nomaiņa .....	369
4.10.1	Brokastu tvertnes izņemšana .....	369
4.10.2	Brokastu tvertnes ielikšana .....	369
4.11	Pudeļu plaukta nomaiņa .....	370
4.11.1	Pudeļu plaukta izņemšana .....	370
4.11.2	Pudeļu plaukta uzstādīšana .....	370
4.12	Durvju plaukta nomaiņa.....	371
4.12.1	Durvju plaukta noņemšana.....	371
4.12.2	Durvju plaukta uzstādīšana .....	371
4.13	Saldētās pārtikas tvertnes nomaiņa.....	372
4.13.1	Saldētās pārtikas tvertnes izņemšana.....	372
4.13.2	Saldētās pārtikas tvertnes uzstādīšana .....	372
4.14	Tvertnes nomaiņa .....	373
4.14.1	Tvertnes izņemšana .....	373
4.14.2	Tvertnes uzstādīšana .....	373
4.15	Izvelkamās tvertnes nomaiņa.....	374
4.15.1	Izvelkamās tvertnes izņemšana.....	374
4.15.2	Izvelkamās tvertnes uzstādīšana .....	374
4.16	LED starmeša nomaiņa .....	375
4.16.1	LED starmeša noņemšana .....	375
4.16.2	LED starmeša uzstādīšana .....	375
4.17	Augšējā LED gaismekļa nomaiņa.....	376
4.17.1	LED gaismekļa noņemšana.....	376
4.17.2	Augšējā LED gaismekļa uzstādīšana .....	377
4.18	Sānu LED apgaismes joslas nomaiņa .....	378
4.18.1	Sānu LED apgaismes joslas noņemšana .....	378
4.18.2	Sānu LED apgaismes joslas uzstādīšana.....	379

# **i** Par šo dokumentu

## 1.1 Būtiska informācija

### 1.1.1 Mērķis

Šie labošanas ieteikumi ir paredzēti patērētājam, lai patstāvīgi labotu ierīces, saskaņā ar piemērojamo Ekodizaina regulu (sākot no 03.2021.).





Ir sniegta informācija, kā nomainīt noteiktas rezerves daļas, un brīdinājumi, kā arī ir aprakstīti riski.

Ja ir jautājumi, sazinieties ar mūsu klientu apkalpošanas dienestu. Mēs atbildam par zaudējumiem tikai tad, ja šie labošanas ieteikumi ir pienācīgi ievēroti.

## 1.2 Simbolu skaidrojums

### 1.2.1 Bīstamības līmeņi

Brīdinājuma līmeņus veido simbols un signālvārds. Signālvārds apzīmē bīstamības pakāpi.





Brīdinājuma līmenis	Nozīme
 <b>BĪSTAMI</b>	Brīdinājuma paziņojuma neievērošanas rezultātā iestāsies nāve vai radīsies smagas traumas.
 <b>BRĪDINĀJUMS</b>	Brīdinājuma paziņojuma neievērošanas rezultātā var iestāties nāve vai rasties smagas traumas.
 <b>ESJET PIESARDŽĪGI</b>	Brīdinājuma paziņojuma neievērošanas rezultātā var rasties nelielas traumas.
 <b>UZMANĪBU!</b>	Brīdinājuma paziņojuma neievērošanas rezultātā var rasties kaitējums īpašumam.

Tabula 1: Bīstamības līmeņi



### 1.2.2 Bīstamības simboli

Bīstamības simboli ir simboliski apzīmējumi, kas sniedz norādes par bīstamības veidu.

Šajā dokumentā ir izmantoti šādi bīstamības simboli:

Bīstamības simbols	Nozīme
	Vispārējs brīdinājuma paziņojums
	Elektriskā sprieguma radīts apdraudējums
	Sprādzienbīstamības risks
	Griezumu bīstamība
	Saspiešanas bīstamība

## **i** Par šo dokumentu

Bīstamības simbols	Nozīme
	Karstu virsmu radīta bīstamība
	Spēcīgu magnētisko lauku radīta bīstamība
	Nejonizējoša starojuma radīta bīstamība

Tabula 2: Bīstamības simboli

### 1.2.3 Brīdinājumu struktūra

Šajā dokumentā sniegtajiem brīdinājumiem ir standartizēts noformējums un standartizēta struktūra.



	<div style="background-color: red; color: white; padding: 2px; text-align: center;"><b>⚠ BĪSTAMI</b></div> <p><b>Bīstamības veids un avots!</b> Iespējamās sekas, kas rodas, neievērojot bīstamības paziņojumu / brīdinājumu.</p> <ul style="list-style-type: none"> <li>▶ Bīstamības novēršanas pasākumi un aizliegumi.</li> </ul>
--	---





Nākamajā piemērā ir parādīts brīdinājums, kas apzīmē elektrotrieciena risku, ko rada spriegumaktīvas detaļas. Ir norādīts bīstamības novēršanas pasākums.

	<div style="background-color: red; color: white; padding: 2px; text-align: center;"><b>⚠ BĪSTAMI</b></div> <p><b>Elektrotrieciena risks, ko rada spriegumaktīvas detaļas!</b> Nāvējošs elektrotrieciens</p> <ul style="list-style-type: none"> <li>▶ Atvienojiet iekārtas no strāvas padeves vismaz 60 sekundes pirms labošanas sākšanas.</li> </ul>
--	--

### 1.2.4 Vispārīgie simboli

Šajā dokumentā ir izmantoti šādi vispārīgie simboli:

Visp. simbols	Nozīme
	Īpašu ieteikumu apzīmējums (teksts un/ vai grafika)
	Vienkāršu ieteikumu apzīmējums (tikai teksts)

Visp. simbols	Nozīme
	Video pamācības saites apzīmējums
	Nepieciešamo rīku apzīmējums
	Nepieciešamo priekšnosacījumu apzīmējums
	Nosacījuma apzīmējums (ja ..., tad ...)
	Rezultāta apzīmējums
[Sākt]	Taustiņa vai pogas apzīmējums
[00123456]	Materiāla numura apzīmējums
Statuss	Attēlotā teksta / loga apzīmējums (iekārtas displejā)

Tabula 3: Vispārīgie simboli

## 2.1 Vispārējie drošības norādījumi

### 2.1.1 Visām mājsaimniecības ierīcēm

#### **Elektrotrieciena risks spriegumaktīvu daļu dēļ!**

- Ja remonts, kas skar elektriskās daļas, ir veikts kļūdaini, pastāv elektrotrieciena risks!
- Ierīcei ir jābūt atvienotai no tīkla vismaz 60 sekundes, pirms sāk darbu.
- Pēc remonta ierīces drošība ir jāpārbauda atbilstīgi noteikumiem VDE 0701 vai valsts noteikumiem.

#### **Savainojumu risks asu malu dēļ!**

- Valkājiet aizsargcimdus.

#### **Saspiešanas risks labošanas, uzturēšanas, traucējumu novēršanas un apkopes laikā, ko rada smagas un kustīgas detaļas**

- Valkājiet aizsargapavus.
- Nostipriniet smagas detaļas, lai tās nenokristu.
- Neievietojiet ķermeņa daļas kustīgās detaļās.

#### **Ierīces drošības / darbības traucējuma risks!**

- Izmantojiet tikai oriģinālās rezerves daļas.

#### **Pret elektrostatisko izlādi jutīgu daļu (ESDS) bojājuma risks!**

- Neaiztieciet moduļus, ieskaitot savienojumus un vadojumu.

## Piederumi un palīgļīdzekļi

Apzīmējums	Sīkāka informācija	Attēli
Aizsargdrāna [00342013]	60 cm x 50 cm	
Precīzas pieregulēšanas skrūvgriežu komplekts [00341820]	9 gab., 2,0 mm, 2,4 mm, 3,0 mm, PH0, PH00, PH1, TX6, TX8, TX9	
Papildu instruments [00342180]	Instrumentu plastmasas detaļu atvienošanai "magic tool"	
Piesūcekņi [00342224]	Ø 50 mm	
Torx uzgalis TX20 [00340865]	6,3 mm (1/4")	
Plakanais skrūvgriezis	Izmērs: 10 mm x 1,6 mm x 200 mm	

## 4.1 Durvju blīvslēga nomaiņa

### Prasība:

- Durvīm ir jābūt atvērtām.

## 4.2 Durvju roktura nomaiņa

### Speciāli rīki:

- Torx uzgalis TX20 6,3 mm (1/4") [00340865]
- Plakanais skrūvgriezis Izmērs: 10 mm x 1,6 mm x 200 mm

### Prasība:

- ✓ Ierīces elektropadevei ir jābūt atvienotai.
- ✓ Durvīm ir jābūt atvērtām.

### 4.2.1 Durvju roktura noņemšana

- ▶ 1. Noņemiet abu skrūvju vāciņus (1).
- ▶ 2. Izskrūvējiet abas skrūves (2).
- ▶ 3. Noņemiet durvju rokturi (3).

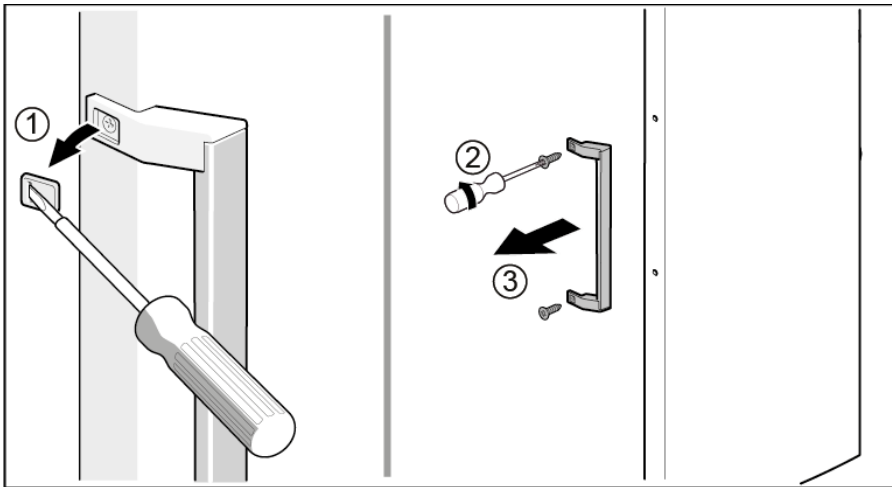

➡ Durvju rokturis ir noņemts.



Otru durvju rokturi noņem tāpat.

### 4.2.2 Durvju roktura uzstādīšana

- ▶ Uzstādiet apgrieztā kārtībā.

## 4.3 Durvju augšējās viras nomaiņa

Speciāli rīki:

Torx uzgalis TX20

6,3 mm (1/4")

[00340865]

	<p><b>BRĪDINĀJUMS</b></p> <p><b>Smaga lielizmēra ierīce!</b> Muguras un muskuļu savainojumi</p> <ul style="list-style-type: none"> <li>▶ Ierīces durvis drīkst noņemt tikai apmācīts speciālists.</li> <li>▶ Ierīce ir jāpārvieta divatā.</li> <li>▶ Ir jāizmanto tikai piemēroti darbarīki un aprīkojums.</li> </ul>
	<p><b>ESIET PIESARDZĪGI</b></p> <p><b>Asas malas!</b> Grieztas brūces</p> <ul style="list-style-type: none"> <li>▶ Lietojiet aizsargcimdus.</li> </ul>
	<p><b>BRĪDINĀJUMS</b></p> <p><b>Sasvērušos ierīču paslīdēšana!</b> Kaulu lūzumi / saspiešanas traumas</p> <ul style="list-style-type: none"> <li>▶ Nostipriniet ierīces, lai tās neslīdētu.</li> </ul>
	<p><b>ESIET PIESARDZĪGI</b></p> <p><b>Krītošu detaļu risks, ko izraisa vaļīgās skrūves!</b> Krītošu detaļu izraisītas traumas.</p> <ul style="list-style-type: none"> <li>▶ Nostipriniet detaļu, lai tā nenokristu.</li> </ul>
	<p><b>UZMANĪBU!</b></p> <p><b>Krītošu detaļu risks, ko izraisa vaļīgās skrūves!</b> Citu ierīces detaļu bojājumi vai bojājumi, kas rodas klienta mājās, piem., apakšpuse.</p> <ul style="list-style-type: none"> <li>▶ Nostipriniet detaļu, lai tā nenokristu.</li> </ul>

Prasība:

- ✓ Ierīces elektropadevei ir jābūt atvienotai.
- ✓ Ierīces iekšējām daļām ir jābūt izņemtām.

## 4.3.1 Durvju augšējās viras noņemšana

1. Nolieciet ierīci uz aizmugures.

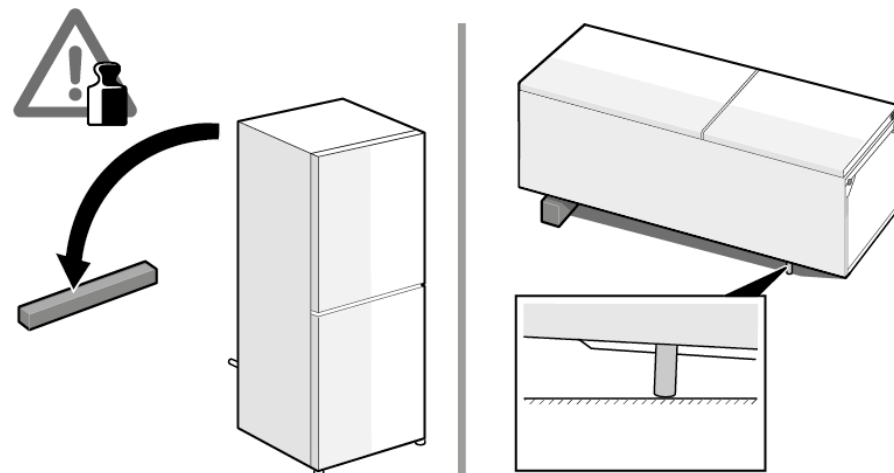

2. 1. Saspiediet augšējās viras pārsega abus sānus (1).
2. Pavelciet augšējās viras pārsegu (2).
3. Pagrieziet viras pārsegu (3).
4. Noņemiet augšējās viras pārsegu (4).
5. Izskrūvējiet abas skrūves (5).
6. Noņemiet augšējo viru (6).

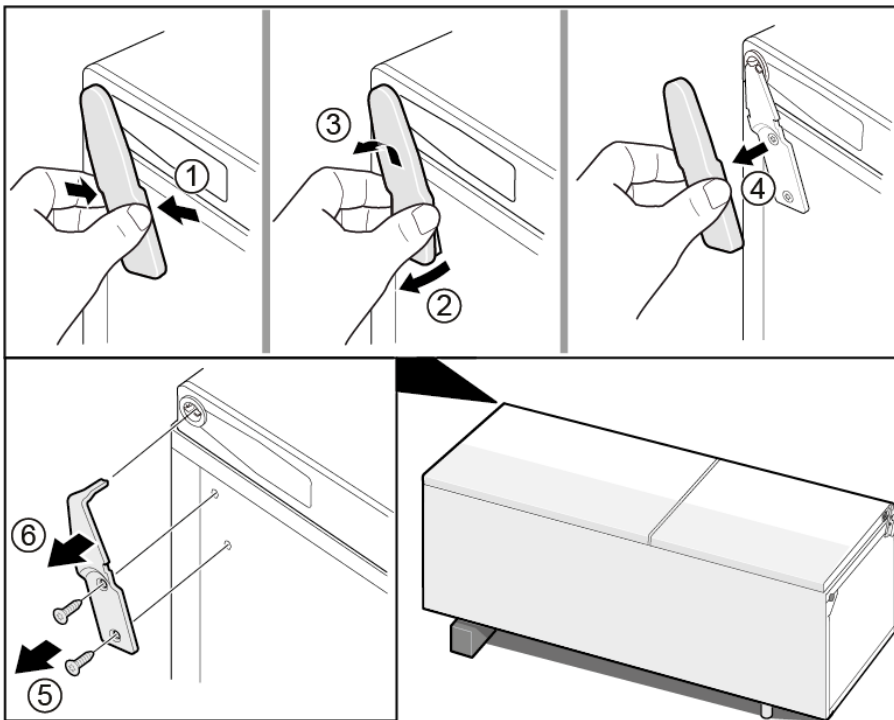

 Augšējā vira ir noņemta.

### 4.3.2 Durvju augšējās viras uzstādīšana

- ▶ Uzstādiet apgrieztā kārtībā.

## 4.4 Durvju augšējās viras nomaiņa (durvis ar displeju)

Speciāli rīki:

Torx uzgalis TX20 6,3 mm (1/4") [00340865]

	<b>BRĪDINĀJUMS</b>
	<p><b>Smaga lielizmēra ierīce!</b> Muguras un muskuļu savainojumi</p> <ul style="list-style-type: none"> <li>▶ Ierīces durvis drīkst noņemt tikai apmācīts speciālists.</li> <li>▶ Ierīce ir jāpārvieta divatā.</li> <li>▶ Ir jāizmanto tikai piemēroti darbarīki un aprīkojums.</li> </ul>

	<b>ESIET PIESARDZĪGI</b>
	<p><b>Asas malas!</b> Grieztas brūces</p> <ul style="list-style-type: none"> <li>▶ Lietojiet aizsargcimdus.</li> </ul>

	<b>BRĪDINĀJUMS</b>
	<p><b>Sasvērušos ierīču paslīdēšana!</b> Kaulu lūzumi / saspiešanas traumas</p> <ul style="list-style-type: none"> <li>▶ Nostipriniet ierīces, lai tās neslīdētu.</li> </ul>

	<b>ESIET PIESARDZĪGI</b>
	<p><b>Krītošu detaļu risks, ko izraisa vaļīgās skrūves!</b> Krītošu detaļu izraisītas traumas.</p> <ul style="list-style-type: none"> <li>▶ Nostipriniet detaļu, lai tā nenokristu.</li> </ul>

	<b>UZMANĪBU!</b>
	<p><b>Krītošu detaļu risks, ko izraisa vaļīgās skrūves!</b> Citu ierīces detaļu bojājumi vai bojājumi, kas rodas klienta mājās, piem., apakšpuse.</p> <ul style="list-style-type: none"> <li>▶ Nostipriniet detaļu, lai tā nenokristu.</li> </ul>

	<b>BĪSTAMI</b>
	<p><b>Elektrotrieciena risks spriegumaktīvu daļu dēļ!</b> Dzīvības apdraudējums nepareiza remonta izraisīta elektrotrieciena dēļ</p> <ul style="list-style-type: none"> <li>▶ Elektriskās daļas ir jāremontē kvalificētam elektriķim.</li> <li>▶ Pēc remonta ierīces drošība ir jāpārbauda atbilstīgi noteikumiem VDE 0701 vai valsts noteikumiem.</li> </ul>

	<b>BĪSTAMI</b>
	<p><b>Elektrotrieciena risks, ko rada spriegumaktīvas detaļas!</b> Nāvējošs elektrotrieciens</p> <ul style="list-style-type: none"> <li>▶ Atvienojiet iekārtas no strāvas padeves vismaz 60 sekundes pirms labošanas sākšanas.</li> </ul>

Prasība:

- ✓ Ierīces elektropadevei ir jābūt atvienotai.
- ✓ Ierīces iekšējām daļām ir jābūt izņemtām.

### 4.4.1 Durvju augšējās viras noņemšana

1. Nolieciet ierīci uz aizmugures.

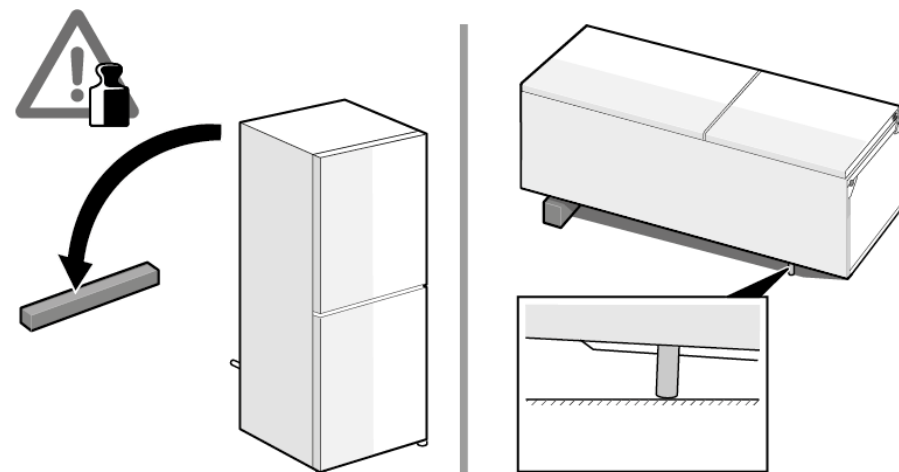

2. 1. Noņemiet augšējās viras pārsegu (1).
2. Noņemiet kabeļa kārbas vāku (2).
3. Atvienojiet elektriskos savienojumus (3).
4. Izskrūvējiet zemētājsavienojuma skrūvi (4).
5. Noņemiet kabeļa aizsargu (5).
6. Izskrūvējiet skrūvi (6).

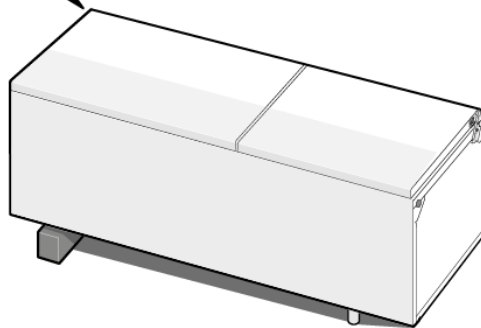
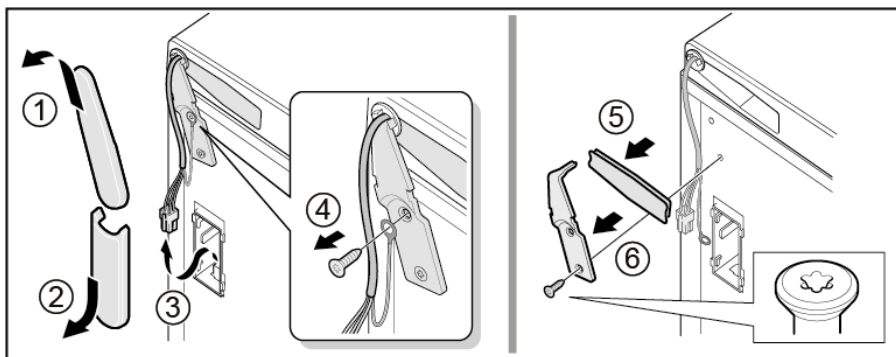

 Augšējā vira ir noņemta.

### 4.4.2 Durvju augšējās viras uzstādīšana

- ▶ Uzstādiet apgrieztā kārtībā.

## 4.5 Durvju vidējās viras nomaiņa

Speciāli rīki:

Torx uzgalis TX20

6,3 mm (1/4")

[00340865]

	<p><b>BRĪDINĀJUMS</b></p> <p><b>Smaga lielizmēra ierīce!</b> Muguras un muskuļu savainojumi</p> <ul style="list-style-type: none"> <li>▶ Ierīces durvis drīkst noņemt tikai apmācīts speciālists.</li> <li>▶ Ierīce ir jāpārvieta divatā.</li> <li>▶ Ir jāizmanto tikai piemēroti darbarīki un aprīkojums.</li> </ul>
	<p><b>ESIET PIESARDZĪGI</b></p> <p><b>Asas malas!</b> Grieztas brūces</p> <ul style="list-style-type: none"> <li>▶ Lietojiet aizsargcimdus.</li> </ul>
	<p><b>BRĪDINĀJUMS</b></p> <p><b>Sasvērušos ierīču paslīdēšana!</b> Kaulu lūzumi / saspiešanas traumas</p> <ul style="list-style-type: none"> <li>▶ Nostipriniet ierīces, lai tās neslīdētu.</li> </ul>
	<p><b>ESIET PIESARDZĪGI</b></p> <p><b>Krītošu detaļu risks, ko izraisa vaļīgās skrūves!</b> Krītošu detaļu izraisītas traumas.</p> <ul style="list-style-type: none"> <li>▶ Nostipriniet detaļu, lai tā nenokristu.</li> </ul>
	<p><b>UZMANĪBU!</b></p> <p><b>Krītošu detaļu risks, ko izraisa vaļīgās skrūves!</b> Citu ierīces detaļu bojājumi vai bojājumi, kas rodas klienta mājās, piem., apakšpuse.</p> <ul style="list-style-type: none"> <li>▶ Nostipriniet detaļu, lai tā nenokristu.</li> </ul>

Prasība:

- ✓ Ierīces elektropadevei ir jābūt atvienotai.
- ✓ Ierīces iekšējām daļām ir jābūt izņemtām.
- ✓ Durvju augšējai virai ir jābūt noņemtai.
- ✓ Augšējām durvīm ir jābūt noņemtām.

### 4.5.1 Durvju vidējās viras noņemšana

- ▶ 1. Noņemiet ledusskapja nodalījuma durvis (1).
- ▶ 2. Izskrūvējiet abas skrūves (2).
- ▶ 3. Noņemiet vidējo viru (3).

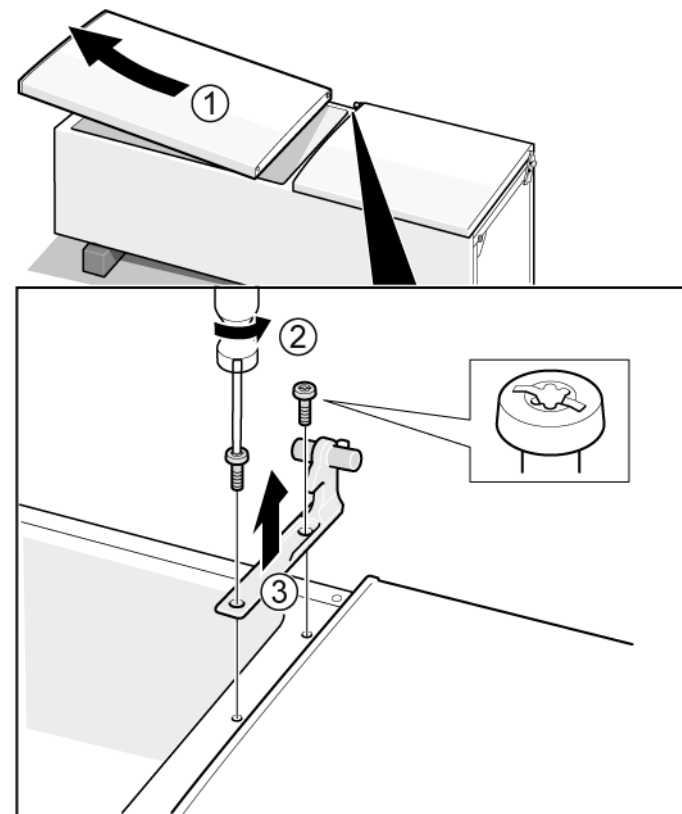

➡ Vidējā vira ir noņemta.

### 4.5.2 Durvju vidējās viras uzstādīšana

- ▶ Uzstādiet apgrieztā kārtībā.

## 4.6 Durvju apakšējās viras nomaiņa

Speciāli rīki:

Torx uzgalis TX20 6,3 mm (1/4") [00340865]

	<p><b>BRĪDINĀJUMS</b></p> <p><b>Smaga lielizmēra ierīce!</b> Muguras un muskuļu savainojumi</p> <ul style="list-style-type: none"> <li>▶ Ierīces durvis drīkst noņemt tikai apmācīts speciālists.</li> <li>▶ Ierīce ir jāpārvieta divatā.</li> <li>▶ Ir jāizmanto tikai piemēroti darbarīki un aprīkojums.</li> </ul>
	<p><b>ESIET PIESARDZĪGI</b></p> <p><b>Asas malas!</b> Grieztas brūces</p> <ul style="list-style-type: none"> <li>▶ Lietojiet aizsargcimdus.</li> </ul>
	<p><b>BRĪDINĀJUMS</b></p> <p><b>Sasvērušos ierīču paslīdēšana!</b> Kaulu lūzumi / saspiešanas traumas</p> <ul style="list-style-type: none"> <li>▶ Nostipriniet ierīces, lai tās neslīdētu.</li> </ul>
	<p><b>ESIET PIESARDZĪGI</b></p> <p><b>Krītošu detaļu risks, ko izraisa vaļīgas skrūves!</b> Krītošu detaļu izraisītas traumas.</p> <ul style="list-style-type: none"> <li>▶ Nostipriniet detaļu, lai tā nenokristu.</li> </ul>
	<p><b>UZMANĪBU!</b></p> <p><b>Krītošu detaļu risks, ko izraisa vaļīgas skrūves!</b> Citu ierīces detaļu bojājumi vai bojājumi, kas rodas klienta mājās, piem., apakšpuse.</p> <ul style="list-style-type: none"> <li>▶ Nostipriniet detaļu, lai tā nenokristu.</li> </ul>

Prasība:

- ✓ Ierīces elektropadevei ir jābūt atvienotai.
- ✓ Ierīces iekšējām daļām ir jābūt izņemtām.
- ✓ Augšējā vira ir noņemta.
- ✓ Vidējā vira ir noņemta.

### 4.6.1 Durvju apakšējās viras noņemšana

- ▶ 1. Noņemiet saldētavas nodalījuma durvis (1).
- ▶ 2. Izskrūvējiet skrūvi (2).
- ▶ 3. Pagrieziet apakšējo viru uz āru (3).
- ▶ 4. Noņemiet apakšējo viru (4).

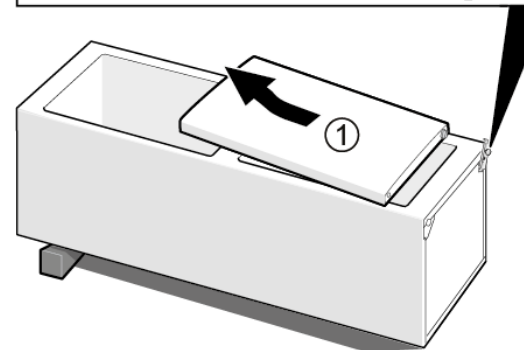
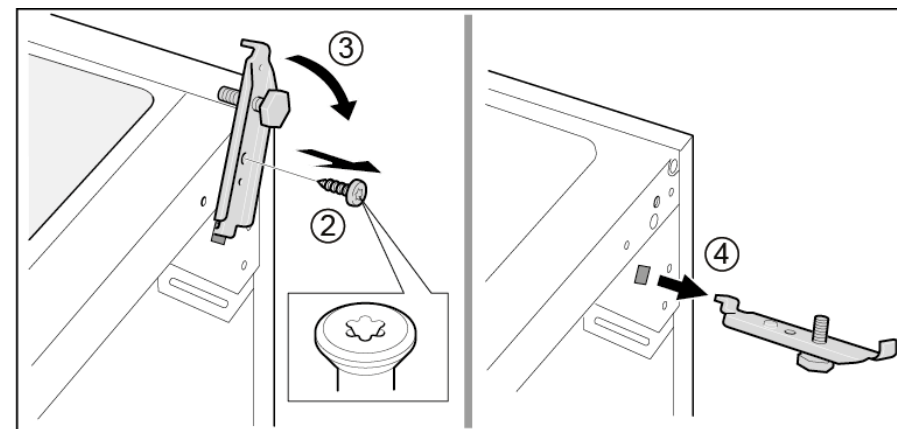

- ➡ Durvju apakšējā vira ir noņemta.

### 4.6.2 Durvju apakšējās viras uzstādīšana

- ▶ Uzstādiet apgrieztā kārtībā.

## 4.7 Plaukta nomaiņa

### Prasība:

- ✔ Durvīm ir jābūt atvērtām.

### 4.7.1 Plaukta izņemšana

- ▶ Izvelciet plauktu.

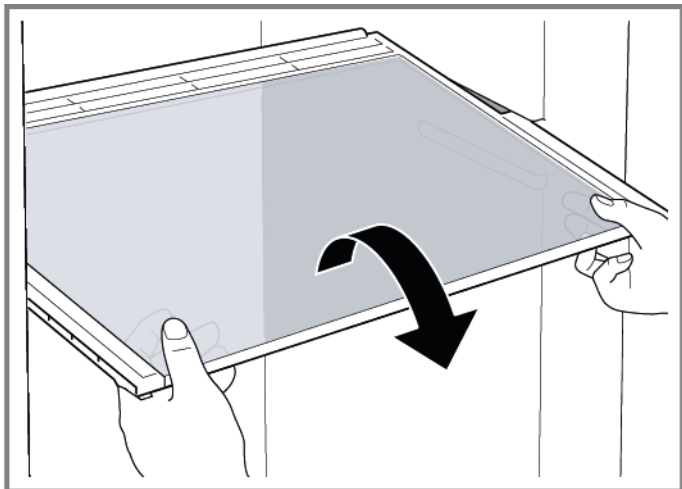

- ➡ Plaukts ir izņemts.

### 4.7.2 Plaukta uzstādīšana

- ▶ Uzstādiet apgrieztā kārtībā.

## 4.8 Divdaļīgā plaukta nomaīņa

### Prasība:

- ✓ Durvīm ir jābūt atvērtām.

### 4.8.1 Divdaļīgā plaukta izņemšana

1. Pavelciet divdaļīgā plaukta labo daļu uz priekšu (1).
2. Izņemiet divdaļīgā plaukta labo daļu (2).

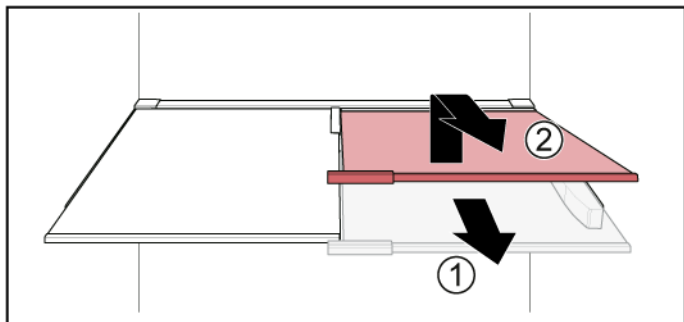

2. Tāpat izņemiet divdaļīgā plaukta kreiso daļu.

➡ Divdaļīgais plaukts ir izņemts.

### 4.8.2 Divdaļīgā plaukta uzstādīšana

- ▶ Uzstādiet apgrieztā kārtībā.

## 4.9 Pielāgojamā plaukta nomaiņa

### Prasība:

- ✓ Durvīm ir jābūt atvērtām.

### 4.9.1 Pielāgojamā plaukta izņemšana

- ▶ 1. Izņemiet stikla plauktu (1).
- ▶ 2. Pielāgojamo plauktu paceliet un izvelciet (2).

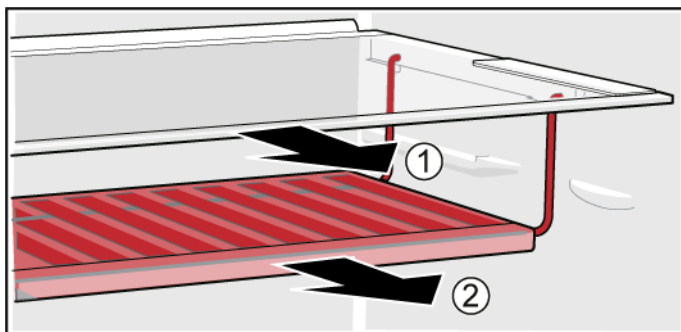

- ➡ Pielāgojamais plaukts ir izņemts.

### 4.9.2 Pielāgojamā plaukta uzstādīšana

- ▶ Uzstādiet apgrieztā kārtībā.

## 4.10 Brokastu tvertnes nomaiņa

### Prasība:

- ✔ Durvīm ir jābūt atvērtām.

### 4.10.1 Brokastu tvertnes izņemšana

- ▶ Brokastu tvertni paceliet un izvelciet.

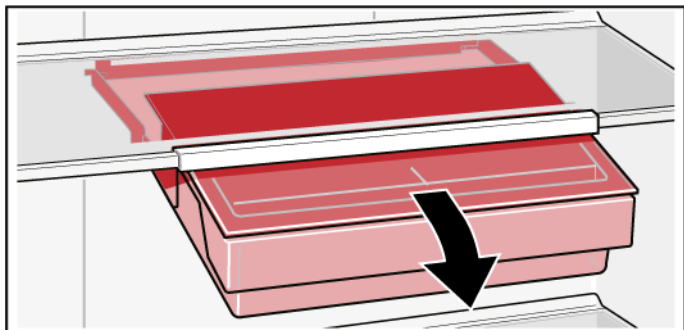

- ➡ Brokastu tvertne ir izņemta.

### 4.10.2 Brokastu tvertnes ielikšana

- ▶ Uzstādiet apgrieztā kārtībā.

## 4.11 Pudeļu plaukta nomaiņa

### Prasība:

- ✓ Durvīm ir jābūt atvērtām.

### 4.11.1 Pudeļu plaukta izņemšana

- ▶ Izvelciet pudeļu plauktu.

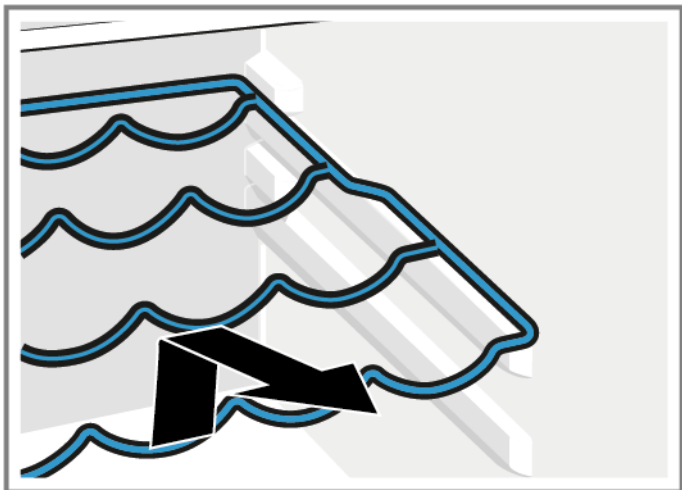

- ➡ Pudeļu plaukts ir izņemts.

### 4.11.2 Pudeļu plaukta uzstādīšana

- ▶ Uzstādiet apgrieztā kārtībā.

## 4.12 Durvju plaukta nomaiņa

### Prasība:

- ✔ Durvīm ir jābūt atvērtām.

### 4.12.1 Durvju plaukta noņemšana

- ▶ Paceliet durvju plauktu uz augšu.

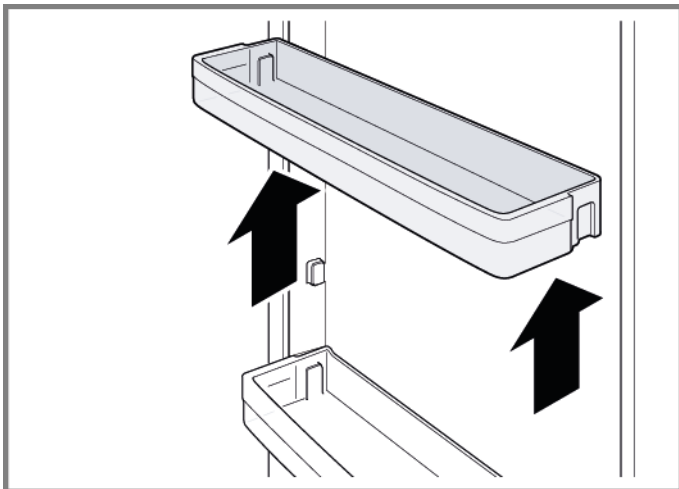

- ➡ Durvju plaukts ir noņemts.

### 4.12.2 Durvju plaukta uzstādīšana

- ▶ Uzstādiet apgrieztā kārtībā.

## 4.13 Saldētās pārtikas tvertnes nomaiņa

### Prasība:

- ✔ Durvīm ir jābūt atvērtām.

### 4.13.1 Saldētās pārtikas tvertnes izņemšana

- ▶ 1. Pilnībā izvelciet saldētās pārtikas tvertni (1).
- ▶ 2. Izņemiet pārtikas tvertni (2).

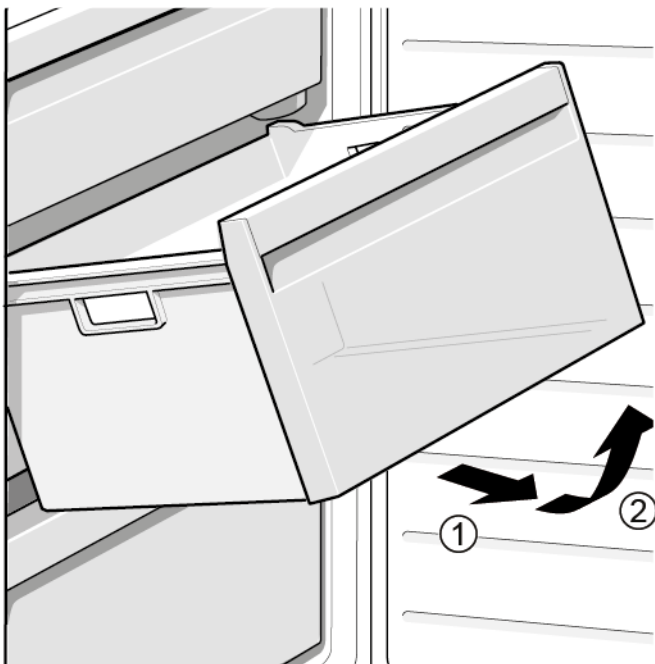

- ➡ Saldētās pārtikas tvertne ir izņemta.

### 4.13.2 Saldētās pārtikas tvertnes uzstādīšana

- ▶ Uzstādiet apgrieztā kārtībā.

## 4.14 Tvertnes nomaiņa

### Prasība:

- ✓ Durvīm ir jābūt atvērtām.

### 4.14.1 Tvertnes izņemšana

- ▶ 1. Izņemiet ledusskapja apakšējo tvertni (1).
- ▶ 2. Izņemiet ledusskapja augšējo tvertni (2).

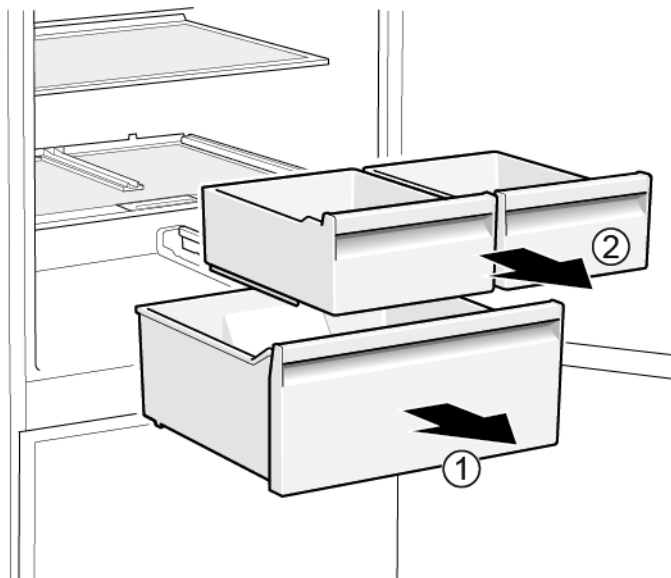

- ➡ Tvertnes ir izņemtas.

### 4.14.2 Tvertnes uzstādīšana

- ▶ Uzstādiet apgrieztā kārtībā.

## 4.15 Izvelkamās tvertnes nomaiņa

### Prasība:

- ✓ Durvīm ir jābūt atvērtām.

### 4.15.1 Izvelkamās tvertnes izņemšana

- ▶ 1. Pilnībā izvelciet izvelkamo tvertni (1).
- ▶ 2. Izņemiet izvelkamo tvertni (2).

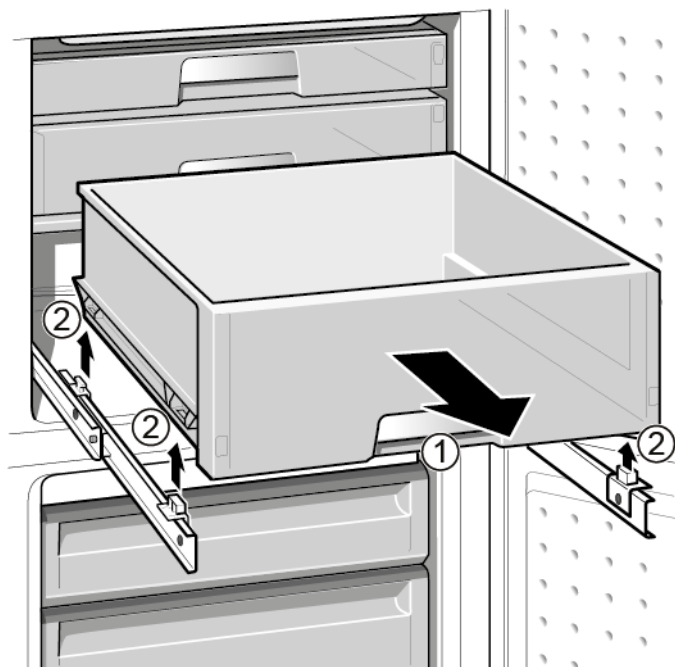

- ➡ Izvelkamā tvertne ir izņemta.

### 4.15.2 Izvelkamās tvertnes uzstādīšana

- ▶ Uzstādiet apgrieztā kārtībā.

## 4.16 LED starmeša nomaiņa

Speciāli rīki:

🔧 Īpašs darbarīks

[00342180]

**i** Ierīcē ir LED gaismeklis, kam nav jāveic apkope.  
Šo gaismekli drīkst remontēt tikai klientu apkalpošanas dienesta pārstāvis vai pilnvarots tehniķis!

**⚠ BĪSTAMI**  
**Elektrotrieciena risks spriegumaktīvu daļu dēļ!**  
Dzīvības apdraudējums nepareiza remonta izraisīta elektrotrieciena dēļ

- ▶ Elektriskās daļas ir jāremontē kvalificētam elektriķim.
- ▶ Pēc remonta ierīces drošība ir jāpārbauda atbilstīgi noteikumiem VDE 0701 vai valsts noteikumiem.

**⚠ BĪSTAMI**  
**Elektrotrieciena risks, ko rada spriegumaktīvas detaļas!**  
Nāvējošs elektrotrieciens

- ▶ Atvienojiet iekārtas no strāvas padeves vismaz 60 sekundes pirms labošanas sākšanas.

**⚠ ESIET PIESARDZĪGI**  
**Asas malas!**  
Griezta brūces

- ▶ Lietojiet aizsargcimdus.

Prasība:

- ✓ Ierīces elektropadevei ir jābūt atvienotai.
- ✓ Durvīm ir jābūt atvērtām.

## 4.16.1 LED starmeša noņemšana

1. Izvelciet LED starmeti ar īpašo darbarīku (1).

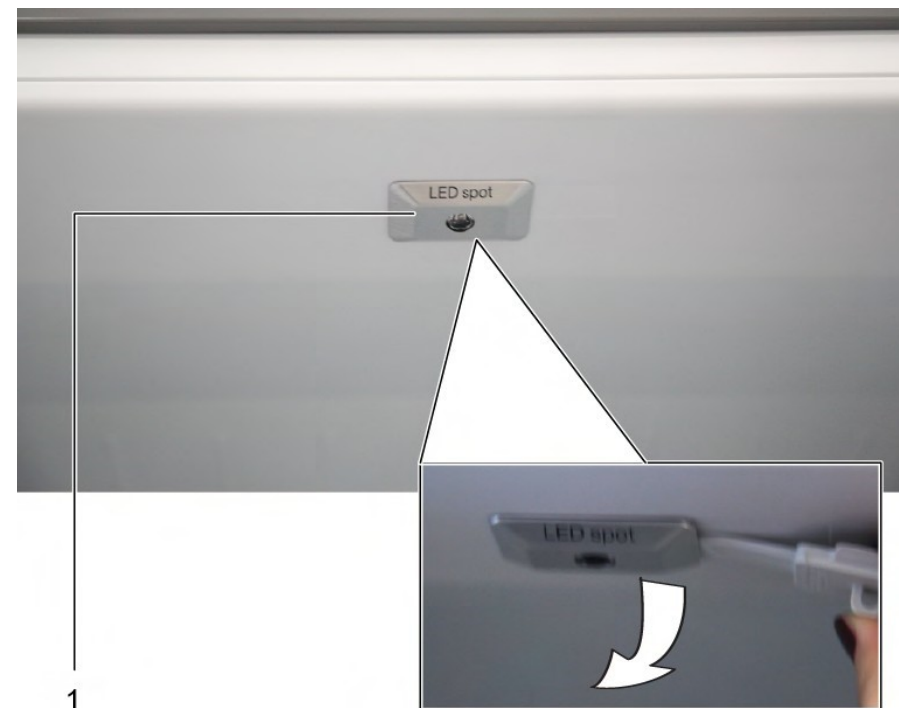

2. Atvienojiet LED starmeša elektriskos savienojumus.

➡ LED starmetis ir noņemts.

## 4.16.2 LED starmeša uzstādīšana

- ▶ Uzstādiet apgrieztā kārtībā.

## 4.17 Augšējā LED gaismekļa nomaiņa

### Speciāli rīki:

- Plakanais skrūvgriezis Izmērs: 2,4 mm x 0,4 mm x 60 mm, komplektā [00341820]

**i** Ierīcē ir LED gaismeklis, kam nav jāveic apkope.  
Šo gaismekli drīkst remontēt tikai klientu apkalpošanas dienesta pārstāvis vai pilnvarots tehniķis!



### **⚠ BĪSTAMI**

#### Elektrotrieciena risks spriegumaktīvu daļu dēļ!

Dzīvības apdraudējums nepareiza remonta izraisīta elektrotrieciena dēļ

- ▶ Elektriskās daļas ir jāremontē kvalificētam elektriķim.
- ▶ Pēc remonta ierīces drošība ir jāpārbauda atbilstīgi noteikumiem VDE 0701 vai valsts noteikumiem.



### **⚠ BĪSTAMI**

#### Elektrotrieciena risks, ko rada spriegumaktīvas detaļas!

Nāvējošs elektrotrieciens

- ▶ Atvienojiet iekārtas no strāvas padeves vismaz 60 sekundes pirms labošanas sākšanas.



### **⚠ ESIET PIESARDZĪGI**

Asas malas!

Grieztas brūces

- ▶ Lietojiet aizsargcimdus.

### Prasība:

- ✓ Ierīces elektropadevei ir jābūt atvienotai.
- ✓ Durvīm ir jābūt atvērtām.
- ✓ Augšējām iekšējām daļām ir jābūt izņemtām.

## 4.17.1 LED gaismekļa noņemšana

1. Pārvietojiet LED gaismekli pa kreisi.

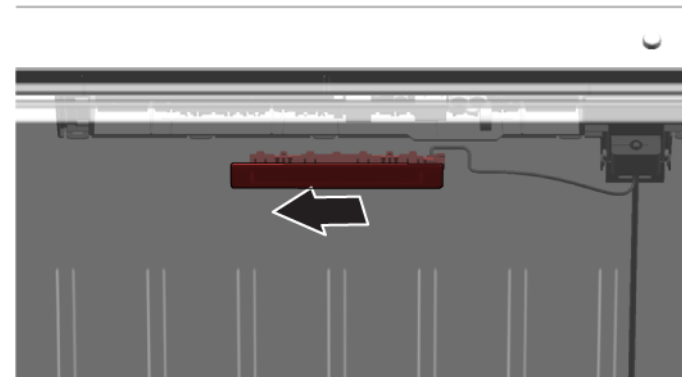

- ➡ LED gaismekļa elektriskais savienojums ir atvienots.

2. Atbrīvojiet LED gaismekļa āķus.

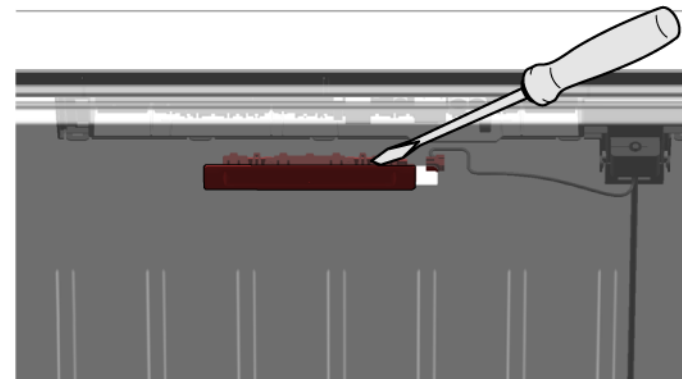

3. Lai noņemtu LED gaismekli, virziet to uz priekšu.

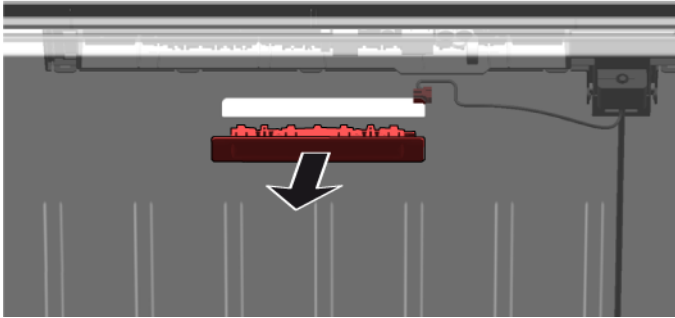

- ➔ LED gaismeklis ir noņemts.

### 4.17.2 Augšējā LED gaismekļa uzstādīšana

- ▶ Uzstādiet apgrieztā kārtībā.

## 4.18 Sānu LED apgaismes joslas nomaīņa

### Speciāli rīki:

Piesūceknis Ø50 mm [00342224]



Ierīcē ir LED gaismeklis, kam nav jāveic apkope.  
Šo gaismekli drīkst remontēt tikai klientu apkalpošanas dienesta pārstāvis vai pilnvarots tehniķis!



### **BĪSTAMI**

#### **Elektrotrieciena risks spriegumaktīvu daļu dēļ!**

Dzīvības apdraudējums nepareiza remonta izraisīta elektrotrieciena dēļ

- ▶ Elektriskās daļas ir jāremontē kvalificētam elektriķim.
- ▶ Pēc remonta ierīces drošība ir jāpārbauda atbilstīgi noteikumiem VDE 0701 vai valsts noteikumiem.



### **BĪSTAMI**

#### **Elektrotrieciena risks, ko rada spriegumaktīvas detaļas!**

Nāvējošs elektrotrieciens

- ▶ Atvienojiet iekārtas no strāvas padeves vismaz 60 sekundes pirms labošanas sākšanas.



### **ESIET PIESARDZĪGI**

#### **Asas malas!**

Grieztas brūces

- ▶ Lietojiet aizsargcimdus.

### Prasība:

- ✓ Ierīces elektropadevei ir jābūt atvienotai.
- ✓ Durvīm ir jābūt atvērtām.
- ✓ Ledusskapja nodalījuma plauktiem ir jābūt izņemtiem.

## 4.18.1 Sānu LED apgaismes joslas noņemšana

1. Uzspiediet piesūcekni uz sānu LED apgaismes joslas augšējās trešdaļas.



2. Piesūceknī kopā ar sānu LED apgaismes joslu pagriežot pavelciet uz priekšu.

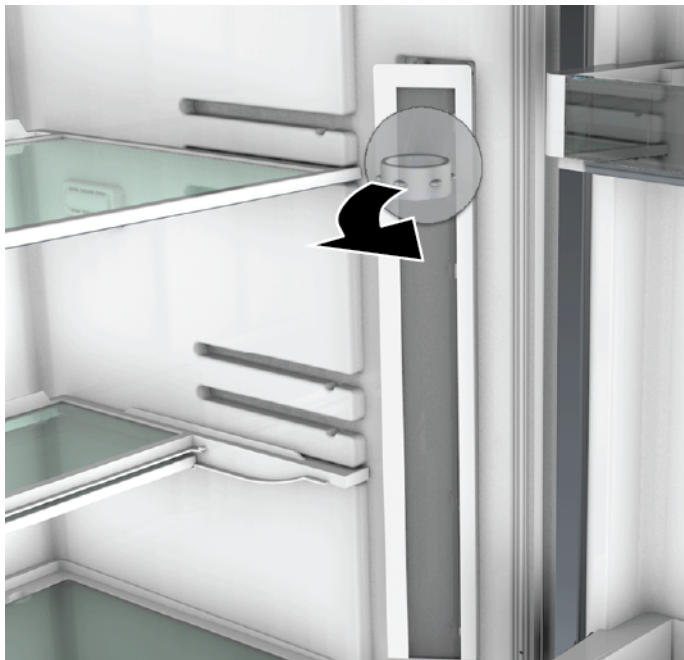

3. Atvienojiet sānu LED apgaismes joslas elektriskos savienojumus.  
➡ Sānu LED apgaismes josla ir noņemta.

### 4.18.2 Sānu LED apgaismes joslas uzstādīšana

1. Izveidojiet sānu LED apgaismes joslas elektriskos savienojumus.
  2. Nostipriniet sānu LED apgaismes joslu vietā nodalījuma sienā (āķiem ir jānoklikšķ).
- ➡ Sānu LED apgaismes josla ir uzstādīta.

# Informacija apie remontą - Šaldytuvas ir šaldiklis

 <b>Dėl šio dokumento</b> .....	<b>381</b>
1.1 Svarbi informacija .....	381
1.1.1 Paskirtis .....	381
1.2 Simbolių paaiškinimas .....	381
1.2.1 Pavojaus lygiai .....	381
1.2.2 Pavojaus simboliai .....	381
1.2.3 Įspėjimų struktūra .....	382
1.2.4 Bendrieji simboliai .....	382
 <b>Sauga</b> .....	<b>383</b>
2.1 Bendrosios saugos instrukcijos .....	383
2.1.1 Visi buitiniai prietaisai .....	383
 <b>Įrankiai ir pagalbinės priemonės</b> .....	<b>384</b>
 <b>Remontas</b> .....	<b>385</b>
4.1 Durelių tarpiklio keitimas .....	385
4.2 Durelių rankenos keitimas .....	386
4.2.1 Durelių rankenos nuėmimas .....	386
4.2.2 Durelių rankenos tvirtinimas .....	386
4.3 Durelių viršutinio vyro keitimas .....	387
4.3.1 Viršutinio durelių vyro nuėmimas .....	387
4.3.2 Viršutinio durelių vyro uždėjimas .....	388
4.4 Durelių viršutinio vyro keitimas (durelės su ekranu) .....	389
4.4.1 Viršutinio durelių vyro nuėmimas .....	389
4.4.2 Viršutinio durelių vyro uždėjimas .....	390
4.5 Vidurinio durelių vyro keitimas .....	391
4.5.1 Vidurinio durelių vyro nuėmimas .....	391
4.5.2 Vidurinių durelių vyro uždėjimas .....	391
4.6 Apatinio durelių vyro keitimas .....	392
4.6.1 Apatinio durelių vyro nuėmimas .....	392
4.6.2 Apatinio durelių vyro uždėjimas .....	392
4.7 Lentynos keitimas .....	393
4.7.1 Lentynos nuėmimas .....	393
4.7.2 Lentynos įdėjimas .....	393
4.8 Modifikuojamos lentynos keitimas .....	394

4.8.1 Modifikuojamos lentynos išėmimas .....	394
4.8.2 Modifikuojamos lentynos įdėjimas .....	394
4.9 Lanksčios lentynos keitimas .....	395
4.9.1 Lanksčios lentynos išėmimas .....	395
4.9.2 Lanksčios lentynos įdėjimas .....	395
4.10 Pusryčių dėžutės keitimas .....	396
4.10.1 Pusryčių dėžutės išėmimas .....	396
4.10.2 Pusryčių dėžutės įdėjimas .....	396
4.11 Butelių padėklo keitimas .....	397
4.11.1 Butelių padėklo išėmimas .....	397
4.11.2 Butelių padėklo įdėjimas .....	397
4.12 Durelių lentynos keitimas .....	398
4.12.1 Durelių lentynos išėmimas .....	398
4.12.2 Durelių lentynos įdėjimas .....	398
4.13 Šaldytų maisto produktų talpyklos keitimas .....	399
4.13.1 Šaldytų maisto produktų talpyklos išėmimas .....	399
4.13.2 Šaldytų maisto produktų talpyklos įdėjimas .....	399
4.14 Talpyklos keitimas .....	400
4.14.1 Talpyklos išėmimas .....	400
4.14.2 Talpyklos įdėjimas .....	400
4.15 Ištraukiamos talpyklos keitimas .....	401
4.15.1 Ištraukiamos talpyklos išėmimas .....	401
4.15.2 Ištraukiamos talpyklos įdėjimas .....	401
4.16 LED apšvietimo lemputės keitimas .....	402
4.16.1 LED apšvietimo lemputės išėmimas .....	402
4.16.2 LED apšvietimo lemputės montavimas .....	402
4.17 Viršutinės LED keitimas .....	403
4.17.1 LED lemputės išėmimas .....	403
4.17.2 Viršutinės LED lemputės montavimas .....	404
4.18 Šoninės pailgos LED lemputės keitimas .....	405
4.18.1 Šoninės pailgos LED lemputės išėmimas .....	405
4.18.2 Šoninės pailgos LED lemputės montavimas .....	406

# **i** Dėl šio dokumento

## 1.1 Svarbi informacija

### 1.1.1 Paskirtis

Šios remonto nuorodos padeda naudotojui pataisyti prietaisus patiems pagal galiojantį ekologinio projektavimo reglamentą (2021 m. kovo mėn. redakcija).





Jose pateikta informacija, kaip pakeisti tam tikras atsargines dalis, įskaitant ir įspėjimus bei riziką.

Jei kiltų klausimų, kreipkitės į mūsų klientų aptarnavimo tarnybą. Mes atsakysime už žalą tik tuo atveju, jei bus tinkamai laikomasi remonto nuorodų.

## 1.2 Simbolių paaiškinimas

### 1.2.1 Pavojaus lygiai

Įspėjimo lygiai susideda iš simbolio ir signalinio žodžio. Signalinis žodis nurodo pavojaus sunkumą.





Įspėjimo lygis	Reikšmė
 <b>PAVOJUS</b>	Nepaisant įspėjamojo pranešimo, ištinka mirtis arba sunkūs sužalojimai.
 <b>ĮSPĖJIMAS</b>	Nepaisant įspėjamojo pranešimo, gali ištikti mirtis arba sunkūs sužalojimai.
 <b>PERSPĖJIMAS</b>	Nepaisant įspėjamojo pranešimo, galimi nedideli sužalojimai.
 <b>DĖMESIO!</b>	Nepaisant įspėjamojo pranešimo, gali būti sugadintas turtas.

Lentelė 1: Pavojaus lygiai



### 1.2.2 Pavojaus simboliai

Pavojaus simboliai yra simboliniai atvaizdai, nurodantys pavojaus rūšį.

Šiame: dokumente naudojami tokie pavojaus simboliai

Pavojaus simbolis	Reikšmė
	Bendras įspėjamasis pranešimas
	Pavojinga elektros įtampa
	Sprogimo pavojus
	Įpjovimo pavojus
	Prispaudimo pavojus

## **i** Dėl šio dokumento

Pavojaus simbolis	Reikšmė
	Pavojus dėl karštų paviršių
	Pavojus dėl stipraus magnetinio lauko
	Pavojus dėl nejonizuojančiosios spinduliuotės

Lentelė 2: Pavojaus simboliai

### 1.2.3 Įspėjimų struktūra

Šiame dokumente pateikiami įspėjimai yra standartizuotos išvaizdos ir standartizuotos struktūros.



	<div style="background-color: red; color: white; padding: 2px; text-align: center;"><b>⚠ PAVOJUS</b></div> <p><b>Pavojaus tipas ir šaltinis!</b> Galimos pasekmės, jei nepaisoma pavojaus / įspėjimo.</p> <ul style="list-style-type: none"> <li>▶ Priemonės ir draudimai pavojui išvengti.</li> </ul>
--	--





Šiame pavyzdyje parodytas įspėjimas, įspėjantis apie elektros smūgį dėl dalių su įtampa. Paminėta priemonė, kaip išvengti pavojaus.

	<div style="background-color: red; color: white; padding: 2px; text-align: center;"><b>⚠ PAVOJUS</b></div> <p><b>Elektros smūgio pavojus dėl dalių, kuriose yra įtampa!</b> Mirtis dėl elektros smūgio</p> <ul style="list-style-type: none"> <li>▶ Prieš pradėdami remontą, ne mažiau kaip prieš 60 sekundžių atjunkite prietaisus nuo elektros tiekimo.</li> </ul>
---	--

### 1.2.4 Bendrieji simboliai

Šiame dokumente naudojami tokie bendrieji simboliai:

Bendr. simbolis	Reikšmė
	Žymi specialų patarimą (tekstas ir (arba) grafika)
	Žymi paprastą patarimą (tik tekstas)
	Žymi nuorodą į vaizdo pamoką

Bendr. simbolis	Reikšmė
	Žymi reikalingus įrankius
	Žymi reikalingas prielaidas
	Žymi sąlygą (jei ..., tai ...)
	Žymi rezultatą
<code>[Paleisti]</code>	Žymi klavišą arba ekrano mygtuką
<code>[00123456]</code>	Žymi dalies numerį
<code>Būsena</code>	Žymi rodomą tekstą / langą (prietaiso ekrane)

Lentelė 3: Bendrieji simboliai

## 2.1 Bendrosios saugos instrukcijos

### 2.1.1 Visi būtiniai prietaisai

#### **Elektros smūgio pavojus dėl dalių, kuriose yra įtampa!**

- Elektrinių konstrukcinių dalių remonto klaidos gali sukelti elektros smūgį!
- Prieš pradėdami dirbti, ne mažiau kaip prieš 60 sekundžių atjunkite prietaisą nuo maitinimo.
- Po remonto pasirūpinkite, kad būtų atliktas saugos bandymas pagal VDE 0701 arba šalyje galiojančius reglamentus.

#### **Pavojus susižeisti į aštrias briaunas!**

- Mūvėkite apsaugines pirštines.

#### **Prispaudimo rizika remonto, einamosios techninės priežiūros, sutrikimų šalinimo ir techninės priežiūros metu dėl sunkių ir judančių konstrukcinių dalių**

- Avėkite apsauginius batus.
- Apsaugokite sunkias konstrukcines dalis, kad jos nenukristų.
- Neartinkite kūno dalių prie judančių konstrukcinių dalių.

#### **Rizika prietaiso saugai / veikimui!**

- Naudokite tik originalias atsargines dalis.

#### **Elektrostatškai jautrių konstrukcinių dalių (ESD) pažeidimo rizika!**

- Nelieskite modulių, o taip pat ir jų jungčių bei laidininkų kelių.

## Įrankiai ir pagalbinės priemonės

Paskyrimas	Išsami informacija	Vaizdai
Apsauginis audinys [00342013]	60 cm x 50 cm	
Tikslųjų atsuktuvų rinkinys [00341820]	9 vnt., 2,0 mm, 2,4 mm, 3,0 mm, PH0, PH00, PH1, TX6, TX8, TX9	
Pagalbinis įrankis [00342180]	Įrankis plastikinėms dalims atpalaiduoti "magic tool"	
Siurbtukas [00342224]	Ø 50 mm	
„Torx“ antgalis TX20 [00340865]	6,3 mm (1/4 col.)	
Atsuktuvas su įpjomis	Mentė 10 mm x 1,6 mm x 200 mm	

## 4.1 Durelių tarpiklio keitimas

### Reikalavimas.

- Durelės turi būti atidarytos.

## 4.2 Durelių rankenos keitimas

### Specialūs įrankiai.

- „Torx“ antgalis TX20 6,3 mm (1/4 col.) [00340865]
- Atsuktuvus su įpjovomis Mentė 10 mm x 1,6 mm x 200 mm

### Reikalavimas.

- ✓ Prietaisas turi būti atjungtas nuo maitinimo šaltinio.
- ✓ Durelės turi būti atidarytos.

### 4.2.1 Durelių rankenos nuėmimas

- ▶ 1. Išimkite du varžtų gaubtelius (1).
- ▶ 2. Išsukite du varžtus (2).
- ▶ 3. Nuimkite durelių rankeną (3).

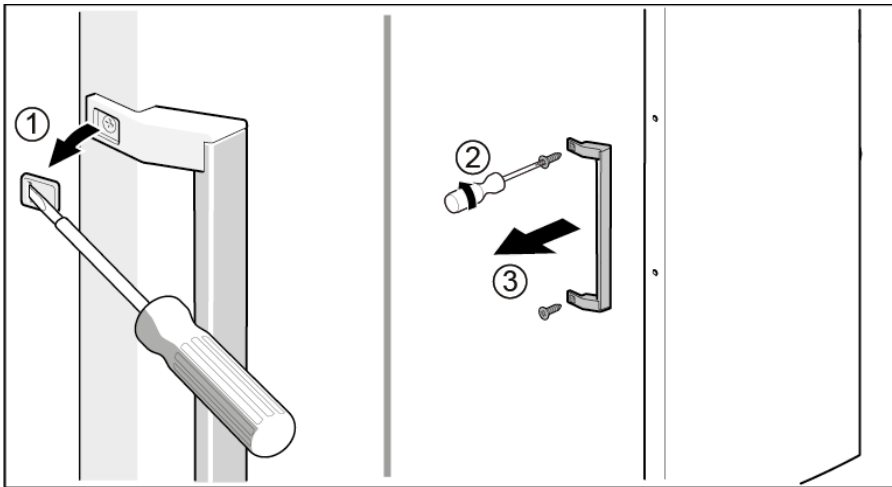

### ➔ Durelių rankena nuimta.



Antrą durelių rankenėlę galima nuimti tokiu pačiu būdu.

### 4.2.2 Durelių rankenos tvirtinimas

- ▶ Uždėkite atvirkščia eilės tvarka.

## 4.3 Durelių viršutinio vyro keitimas

### Specialūs įrankiai.

„Torx“ antgalis TX20

6,3 mm (1/4 col.)

[00340865]

	<b>ĮSPĖJIMAS</b> <b>Sunkūs ir dideli prietaisai!</b> Nugaros ir raumenų sužalojimai ▶ Prietaiso dureles nuimti gali tik apmokyti specialistai. ▶ Norint perkelti prietaisą į kitą vietą, reikalingi du žmonės. ▶ Naudokite tik tinkamus įrankius ir įrangą.
	<b>PERSPĖJIMAS</b> <b>Aštrios briaunos!</b> Galima įsipjauti ▶ Mūvėkite apsaugines pirštines.
	<b>ĮSPĖJIMAS</b> <b>Paverstų prietaisų slydimas!</b> Galimi kaulų lūžiai ir prispaudimai ▶ Apsaugokite prietaisus, kad jie nepaslystų.
	<b>PERSPĖJIMAS</b> <b>Pavojus, kad atpalaidavus varžtus dalys nukris!</b> Krentančios dalys gali sužeisti. ▶ Apsaugokite konstrukcinę dalį, kad ji nenukristų.
	<b>DĖMESIO!</b> <b>Pavojus, kad atpalaidavus varžtus dalys nukris!</b> Gali būti sugadintos kitos prietaiso dalys arba kliento namai, pvz., grindys. ▶ Apsaugokite konstrukcinę dalį, kad ji nenukristų.

### Reikalavimas.

- ✔ Prietaisas turi būti atjungtas nuo maitinimo šaltinio.
- ✔ Prietaiso vidiniai tvirtinimo elementai turi būti nuimti.

## 4.3.1 Viršutinio durelių vyro nuėmimas

1. Paguldykite prietaisą ant galinės pusės.

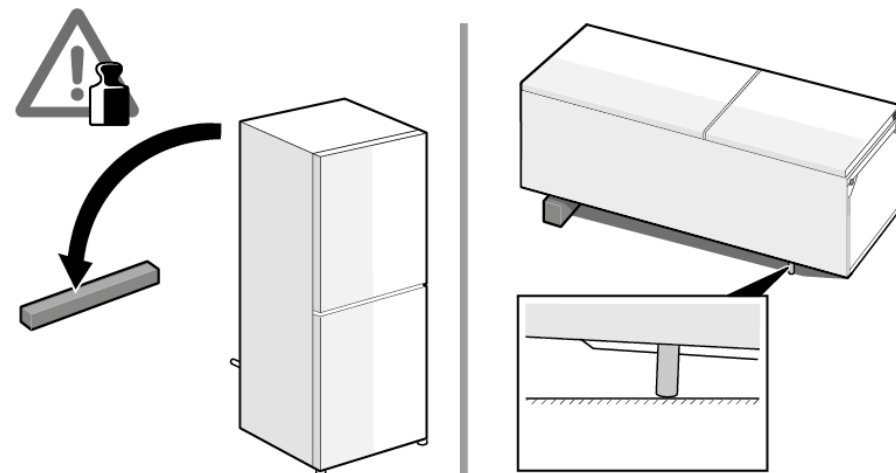

1. Spustelėkite viršutinio vairo dangtelį abiejose pusėse (1).
2. Atkelkite viršutinio vairo dangtelį (2).
3. Pasukite vairo dangtelį (3).
4. Nuimkite viršutinio vairo dangtelį (4).
5. Išsukite du varžtus (5).
6. Nuimkite viršutinį vairą (6).

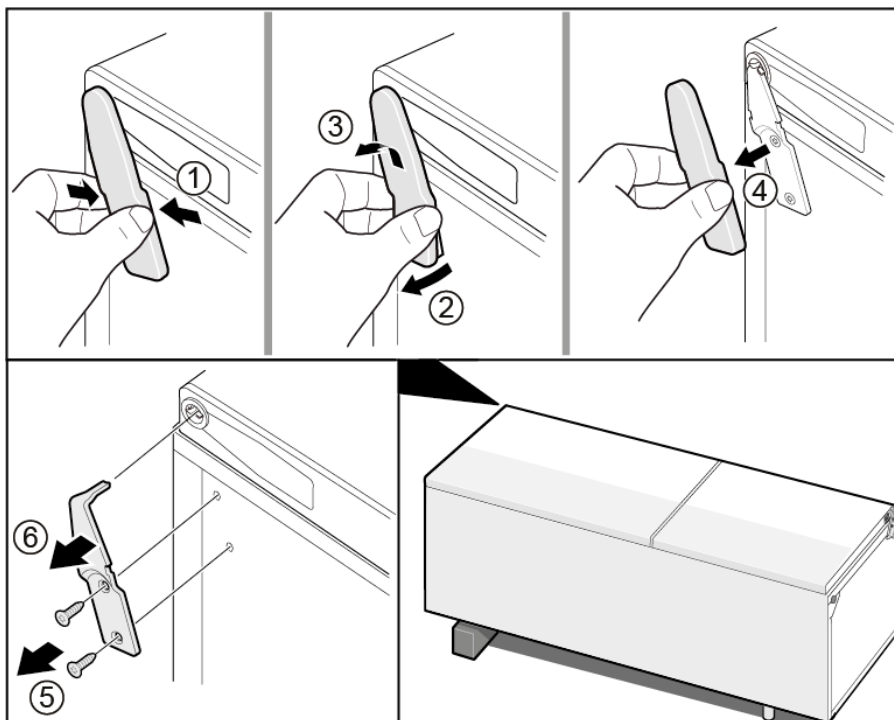

 Viršutinis vairas nuimtas.

### 4.3.2 Viršutinio durelių vairo uždėjimas

- ▶ Uždėkite atvirkščia eilės tvarka.



## 4.4 Durelių viršutinio vyro keitimas (durelės su ekranu)

Specialūs įrankiai.

„Torx“ antgalis TX20

6,3 mm (1/4 col.)

[00340865]

	<p style="text-align: center;"><b>⚠️ ĮSPĖJIMAS</b></p> <p><b>Sunkūs ir dideli prietaisai!</b> Nugaros ir raumenų sužalojimai</p> <ul style="list-style-type: none"> <li>▶ Prietaiso dureles nuimti gali tik apmokyti specialistai.</li> <li>▶ Norint perkelti prietaisą į kitą vietą, reikalingi du žmonės.</li> <li>▶ Naudokite tik tinkamus įrankius ir įrangą.</li> </ul>
	<p style="text-align: center;"><b>⚠️ PERSPĖJIMAS</b></p> <p><b>Aštrios briaunos!</b> Galima įsipjauti</p> <ul style="list-style-type: none"> <li>▶ Mūvėkite apsaugines pirštines.</li> </ul>
	<p style="text-align: center;"><b>⚠️ ĮSPĖJIMAS</b></p> <p><b>Paverstų prietaisų slydimas!</b> Galimi kaulų lūžiai ir prispaudimai</p> <ul style="list-style-type: none"> <li>▶ Apsaugokite prietaisus, kad jie nepaslystų.</li> </ul>
	<p style="text-align: center;"><b>⚠️ PERSPĖJIMAS</b></p> <p><b>Pavojus, kad atpalaidavus varžtus dalys nukris!</b> Krentančios dalys gali sužeisti.</p> <ul style="list-style-type: none"> <li>▶ Apsaugokite konstrukcinę dalį, kad ji nenukristų.</li> </ul>
	<p style="text-align: center;"><b>⚠️ DĖMESIO!</b></p> <p><b>Pavojus, kad atpalaidavus varžtus dalys nukris!</b> Gali būti sugadintos kitos prietaiso dalys arba kliento namai, pvz., grindys.</p> <ul style="list-style-type: none"> <li>▶ Apsaugokite konstrukcinę dalį, kad ji nenukristų.</li> </ul>

	<p style="text-align: center;"><b>⚠️ PAVOJUS</b></p> <p><b>Elektros smūgio pavojus dėl dalių, kuriose yra įtampa!</b> Pavojus gyvybei dėl elektros smūgio netinkamo remonto atveju</p> <ul style="list-style-type: none"> <li>▶ Elektrines dalis remontuoti turi kvalifikuoti elektrikai.</li> <li>▶ Po remonto pasirūpinkite, kad būtų atliktas saugos bandymas pagal VDE 0701 arba šalyje galiojančius reglamentus.</li> </ul>
---	--

	<p style="text-align: center;"><b>⚠️ PAVOJUS</b></p> <p><b>Elektros smūgio pavojus dėl dalių, kuriose yra įtampa!</b> Mirtis dėl elektros smūgio</p> <ul style="list-style-type: none"> <li>▶ Prieš pradėdami remontą, ne mažiau kaip prieš 60 sekundžių atjunkite prietaisus nuo elektros tiekimo.</li> </ul>
---	--

Reikalavimas.

- ✓ Prietaisas turi būti atjungtas nuo maitinimo šaltinio.
- ✓ Prietaiso vidiniai tvirtinimo elementai turi būti nuimti.

### 4.4.1 Viršutinio durelių vyro nuėmimas

1. Paguldykite prietaisą ant galinės pusės.

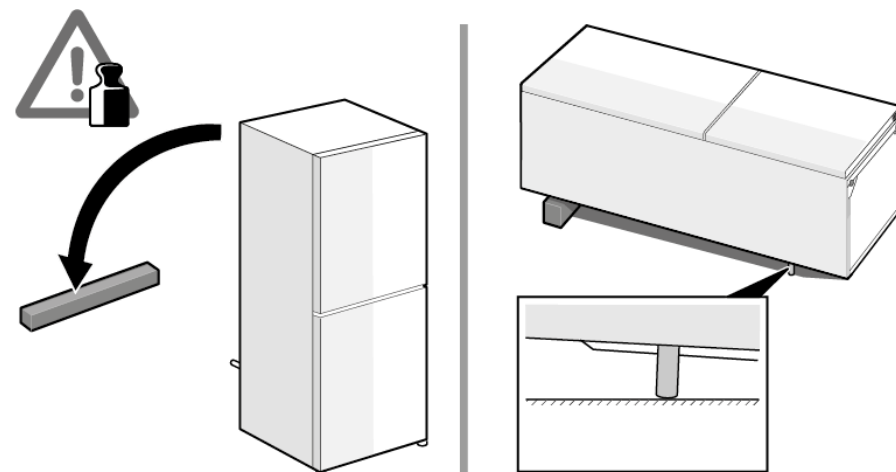

## Remontas

2. 1. Nuimkite viršutinio vyro dangtelį (1).
2. Nuimkite kabelių dėžutės dangtelį (2).
3. Atjunkite elektros jungtį (3).
4. Atsukite įžeminimo jungties varžtą (4).
5. Nuimkite kabelio apsaugą (5).
6. Išsukite varžtą (6).

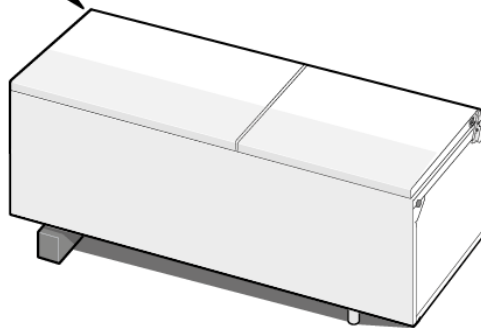
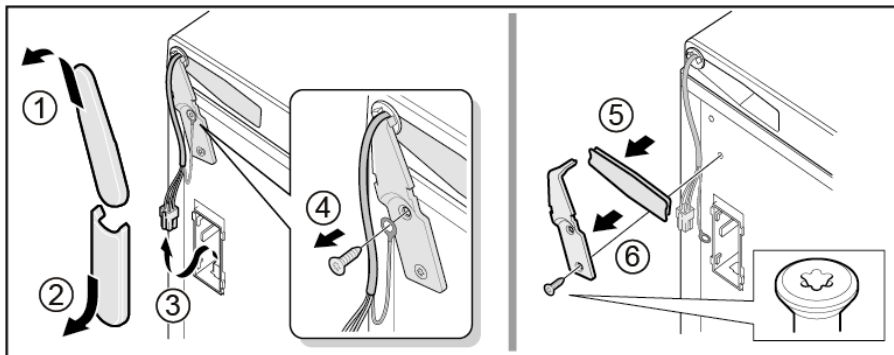

 Viršutinis vyras nuimtas.

### 4.4.2 Viršutinio durelių vyro uždėjimas

- ▶ Uždėkite atvirkščia eilės tvarka.

## 4.5 Vidurinio durelių vyrio keitimas

### Specialūs įrankiai.

„Torx“ antgalis TX20

6,3 mm (1/4 col.)

[00340865]

	<p style="text-align: center;"><b>⚠️ ĮSPĖJIMAS</b></p> <p><b>Sunkūs ir dideli prietaisai!</b> Nugaros ir raumenų sužalojimai</p> <ul style="list-style-type: none"> <li>▶ Prietaiso dureles nuimti gali tik apmokyti specialistai.</li> <li>▶ Norint perkelti prietaisą į kitą vietą, reikalingi du žmonės.</li> <li>▶ Naudokite tik tinkamus įrankius ir įrangą.</li> </ul>
	<p style="text-align: center;"><b>⚠️ PERSPĖJIMAS</b></p> <p><b>Aštrios briaunos!</b> Galima įsipjauti</p> <ul style="list-style-type: none"> <li>▶ Mūvėkite apsaugines pirštines.</li> </ul>
	<p style="text-align: center;"><b>⚠️ ĮSPĖJIMAS</b></p> <p><b>Paverstų prietaisų slydimas!</b> Galimi kaulų lūžiai ir prispaudimai</p> <ul style="list-style-type: none"> <li>▶ Apsaugokite prietaisus, kad jie nepaslystų.</li> </ul>
	<p style="text-align: center;"><b>⚠️ PERSPĖJIMAS</b></p> <p><b>Pavojus, kad atpalaidavus varžtus dalys nukris!</b> Krentančios dalys gali sužeisti.</p> <ul style="list-style-type: none"> <li>▶ Apsaugokite konstrukcinę dalį, kad ji nenukristų.</li> </ul>
	<p style="text-align: center;"><b>⚠️ DĖMESIO!</b></p> <p><b>Pavojus, kad atpalaidavus varžtus dalys nukris!</b> Gali būti sugadintos kitos prietaiso dalys arba kliento namai, pvz., grindys.</p> <ul style="list-style-type: none"> <li>▶ Apsaugokite konstrukcinę dalį, kad ji nenukristų.</li> </ul>

### Reikalavimas.

- ✔️ Prietaisas turi būti atjungtas nuo maitinimo šaltinio.
- ✔️ Prietaiso vidiniai tvirtinimo elementai nuimti.
- ✔️ Durelių viršutinis vyris nuimtas.
- ✔️ Viršutinės durelės nuimtos.

### 4.5.1 Vidurinio durelių vyrio nuėmimas

- ▶ 1. Nuimkite šaldytuvo skyriaus dureles (1).
- ▶ 2. Išsukite du varžtus (2).
- ▶ 3. Nuimkite vidurinį vyrį (3).

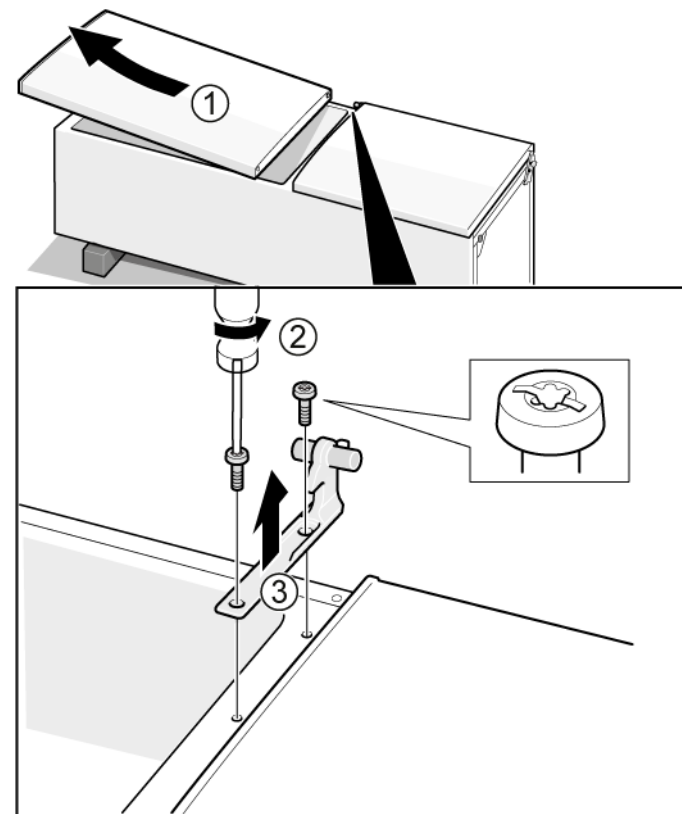

➡ Vidurinis vyris nuimtas.

### 4.5.2 Vidurinių durelių vyrio uždėjimas

- ▶ Uždėkite atvirkščia eilės tvarka.

## 4.6 Apatinio durelių vyrio keitimas

### Specialūs įrankiai.

„Torx“ antgalis TX20

6,3 mm (1/4 col.)

[00340865]

	<p><b>ĮSPĖJIMAS</b></p> <p><b>Sunkūs ir dideli prietaisai!</b> Nugaros ir raumenų sužalojimai</p> <ul style="list-style-type: none"> <li>▶ Prietaiso dureles nuimti gali tik apmokyti specialistai.</li> <li>▶ Norint perkelti prietaisą į kitą vietą, reikalingi du žmonės.</li> <li>▶ Naudokite tik tinkamus įrankius ir įrangą.</li> </ul>
	<p><b>PERSPĖJIMAS</b></p> <p><b>Aštrios briaunos!</b> Galima įsipjauti</p> <ul style="list-style-type: none"> <li>▶ Mūvėkite apsaugines pirštines.</li> </ul>
	<p><b>ĮSPĖJIMAS</b></p> <p><b>Paverstų prietaisų slydimas!</b> Galimi kaulų lūžiai ir prispaudimai</p> <ul style="list-style-type: none"> <li>▶ Apsaugokite prietaisus, kad jie nepaslystų.</li> </ul>
	<p><b>PERSPĖJIMAS</b></p> <p><b>Pavojus, kad atpalaidavus varžtus dalys nukris!</b> Krentančios dalys gali sužeisti.</p> <ul style="list-style-type: none"> <li>▶ Apsaugokite konstrukcinę dalį, kad ji nenukristų.</li> </ul>
	<p><b>DĖMESIO!</b></p> <p><b>Pavojus, kad atpalaidavus varžtus dalys nukris!</b> Gali būti sugadintos kitos prietaiso dalys arba kliento namai, pvz., grindys.</p> <ul style="list-style-type: none"> <li>▶ Apsaugokite konstrukcinę dalį, kad ji nenukristų.</li> </ul>

### Reikalavimas.

- ✓ Prietaisas turi būti atjungtas nuo maitinimo šaltinio.
- ✓ Prietaiso vidiniai tvirtinimo elementai turi būti nuimti.
- ✓ Viršutinis vyris nuimtas.
- ✓ Vidurinis vyris nuimtas.

### 4.6.1 Apatinio durelių vyrio nuėmimas

- ▶ 1. Nuimkite šaldiklio skyriaus dureles (1).
- ▶ 2. Išsukite varžtą (2).
- ▶ 3. Pasukite apatinį vyrį į išorę (3).
- ▶ 4. Nuimkite apatinį vyrį (4).

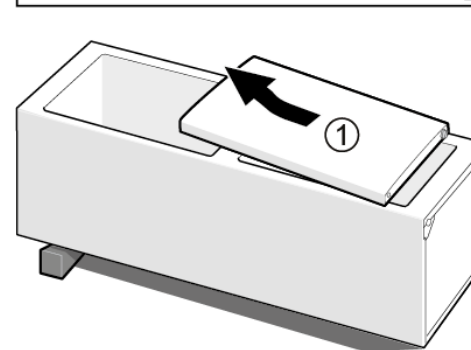
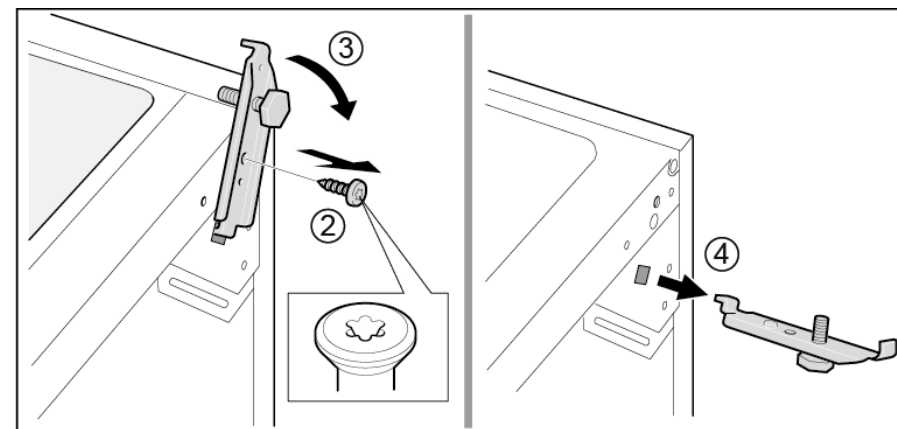

- ➡ Apatinis durelių vyris nuimtas.

### 4.6.2 Apatinio durelių vyrio uždėjimas

- ▶ Uždėkite atvirkščia eilės tvarka.

## 4.7 Lentynos keitimas

### Reikalavimas.

- ✔ Durelės turi būti atidarytos.

### 4.7.1 Lentynos nuėmimas

- ▶ Ištraukite lentyną.

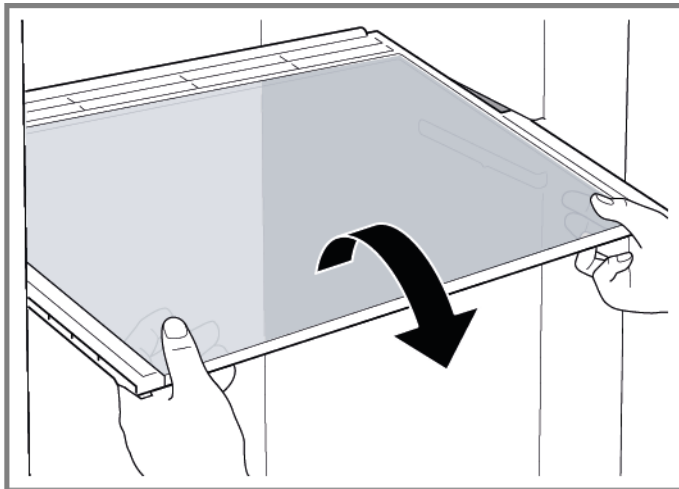

- ➡ Lentyna išimta.

### 4.7.2 Lentynos įdėjimas

- ▶ Uždėkite atvirkščia eilės tvarka.

## 4.8 Modifikuojamos lentynos keitimas

### Reikalavimas.

- ✔ Durelės turi būti atidarytos.

### 4.8.1 Modifikuojamos lentynos išėmimas

1. Patraukite dešiniąją modifikuojamos lentynos dalį pirmyn (1).
2. Išimkite dešiniąją modifikuojamos lentynos dalį (2).

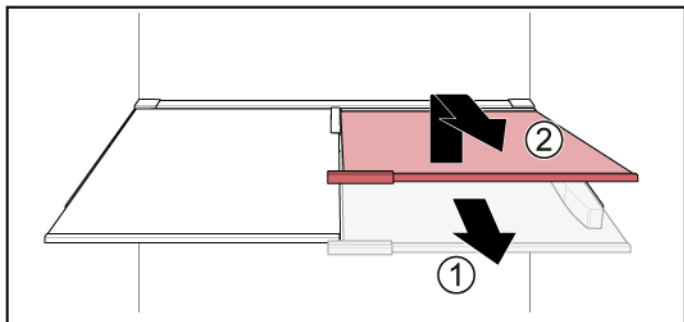

2. Tokiu pat būdu išimkite kairiąją modifikuojamos lentynos dalį.

- ➡ Modifikuojama lentyna išimta.

### 4.8.2 Modifikuojamos lentynos įdėjimas

- ▶ Uždėkite atvirkščia eilės tvarka.

## 4.9 Lanksčios lentynos keitimas

### Reikalavimas.

- ✔ Durelės turi būti atidarytos.

### 4.9.1 Lanksčios lentynos išėmimas

- ▶ 1. Išimkite stiklo lentyną (1).
- ▶ 2. Pakelkite lanksčią lentyną ir ją ištraukite (2).

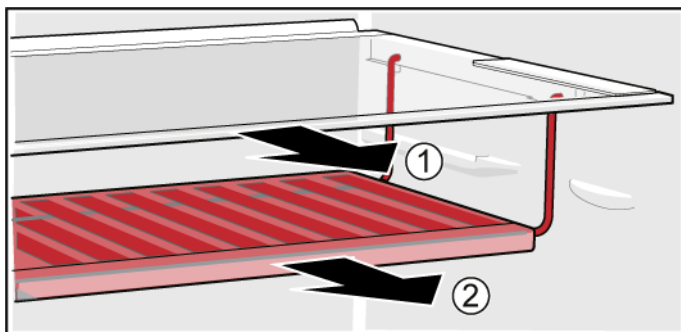

- ➡ Lanksti lentyna išimta.

### 4.9.2 Lanksčios lentynos įdėjimas

- ▶ Uždėkite atvirkščia eilės tvarka.

## 4.10 Pusryčių dėžutės keitimas

### Reikalavimas.

- ✔ Durelės turi būti atidarytos.

### 4.10.1 Pusryčių dėžutės išėmimas

- ▶ Pakelkite pusryčių dėžutę ir ją ištraukite.

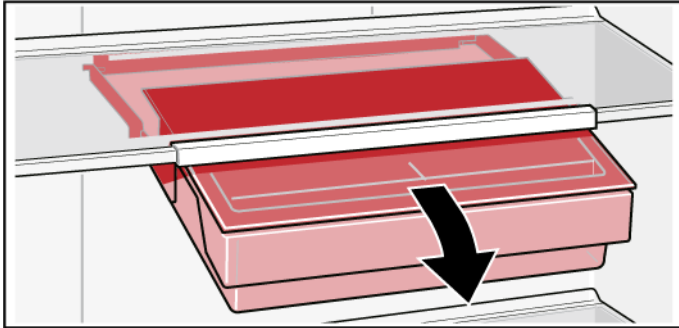

- ➡ Pusryčių dėžutė išimta.

### 4.10.2 Pusryčių dėžutės įdėjimas

- ▶ Uždėkite atvirkščia eilės tvarka.

## 4.11 Butelių padėklo keitimas

### Reikalavimas.

- ✔ Durelės turi būti atidarytos.

### 4.11.1 Butelių padėklo išėmimas

- ▶ Ištraukite butelių padėklą.

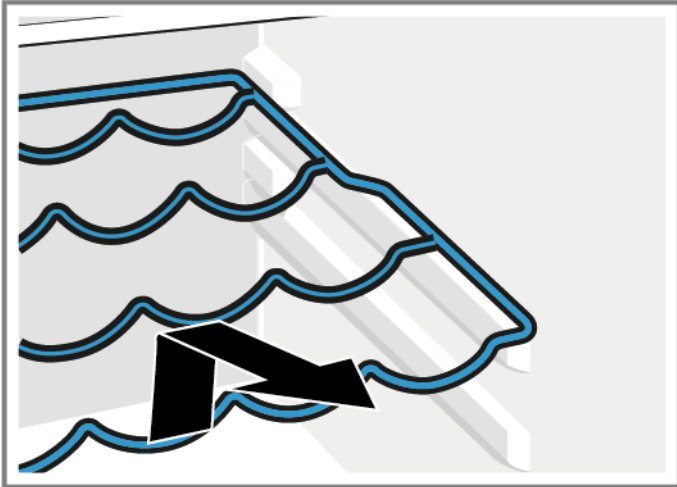

- ➡ Butelių padėklas išimtas.

### 4.11.2 Butelių padėklo įdėjimas

- ▶ Uždėkite atvirkščia eilės tvarka.

## 4.12 Durelių lentynos keitimas

### Reikalavimas.

- ✔ Durelės turi būti atidarytos.

### 4.12.1 Durelių lentynos išėmimas

- ▶ Pakelkite durelių lentyną į viršų.

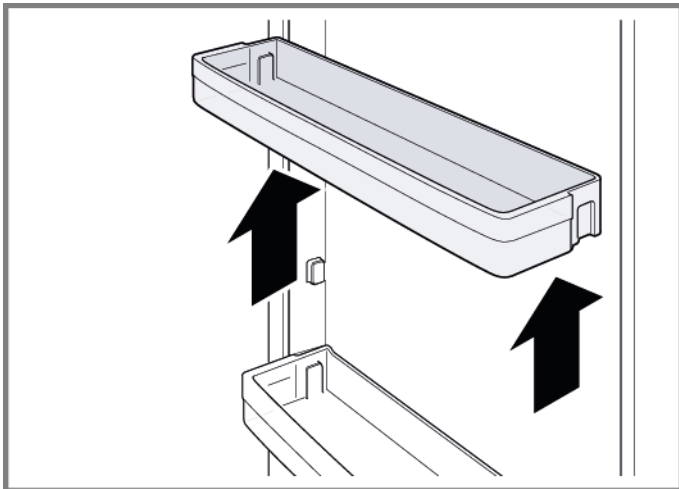

- ➡ Durelių lentyna išimta.

### 4.12.2 Durelių lentynos įdėjimas

- ▶ Uždėkite atvirkščia eilės tvarka.

## 4.13 Šaldytų maisto produktų talpyklos keitimas

### Reikalavimas.

- ✔ Durelės turi būti atidarytos.

### 4.13.1 Šaldytų maisto produktų talpyklos išėmimas

- ▶ 1. Ištraukite šaldytų maisto produktų talpyklą iki pat galo (1).
- ▶ 2. Išimkite maisto produktų talpyklą (2).

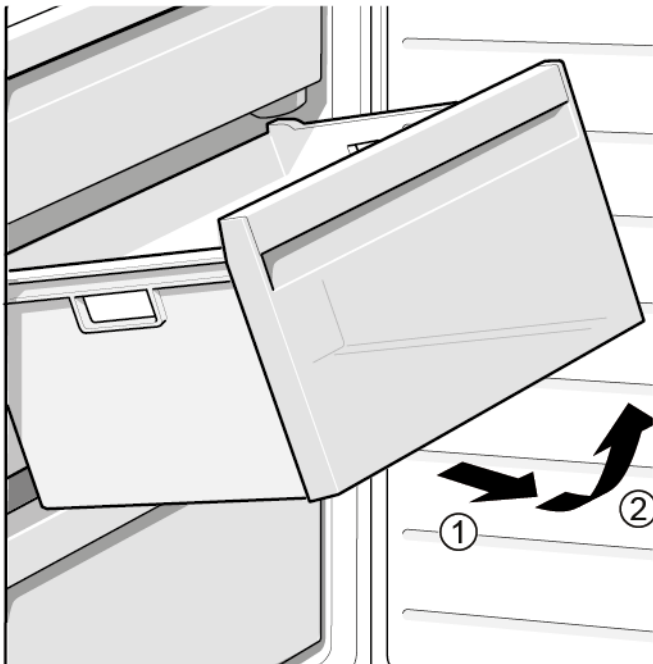

- ➡ Šaldytų maisto produktų talpykla išimta.

### 4.13.2 Šaldytų maisto produktų talpyklos įdėjimas

- ▶ Uždėkite atvirksčia eilės tvarka.

## 4.14 Talpyklos keitimas

### Reikalavimas.

- ✔ Durelės turi būti atidarytos.

### 4.14.1 Talpyklos išėmimas

- ▶ 1. Ištraukite apatinę šaldytuvo talpyklą (1).
- ▶ 2. Ištraukite viršutinę šaldytuvo talpyklą (2).

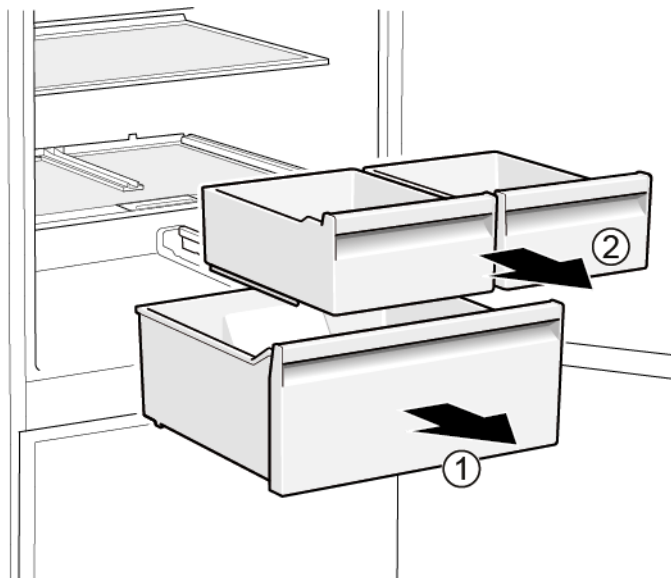

- ➡ Talpyklos išimtos.

### 4.14.2 Talpyklos įdėjimas

- ▶ Uždėkite atvirkščia eilės tvarka.

## 4.15 Ištraukiamos talpyklos keitimas

### Reikalavimas.

- ✔ Durelės turi būti atidarytos.

### 4.15.1 Ištraukiamos talpyklos išėmimas

- ▶ 1. Ištraukite ištraukiamą talpyklą iki pat galo (1).
- ▶ 2. Išimkite ištraukiamą talpyklą (2).

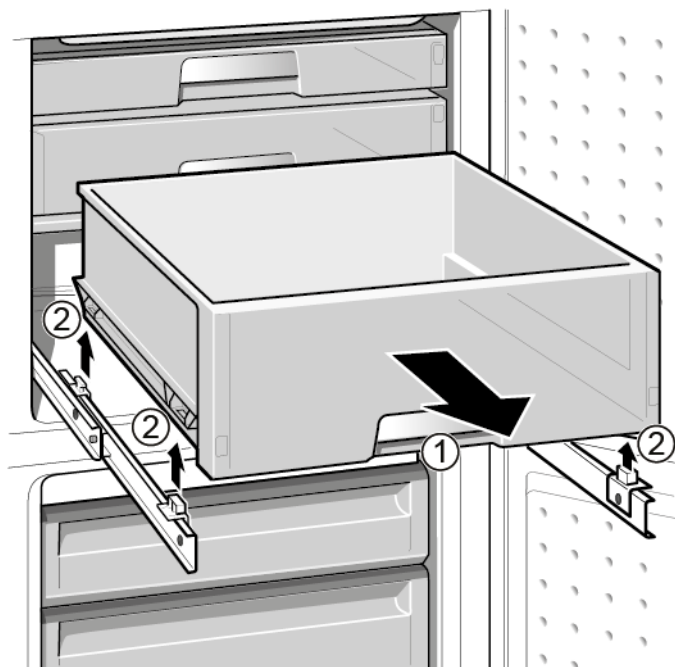

- ➡ Ištraukiama talpykla išimta.

### 4.15.2 Ištraukiamos talpyklos įdėjimas

- ▶ Uždėkite atvirkščia eilės tvarka.

## 4.16 LED apšvietimo lempučių keitimas

### Specialūs įrankiai.

Specialus įrankis

[00342180]

**i** Jūsų prietaise įrengta techninės priežiūros nereikalaujanti LED lempučių. Šią lempučių gali taisyti tik klientų aptarnavimo tarnybos specialistai arba įgalioti technikai!

**⚠ PAVOJUS**  
**Elektros smūgio pavojus dėl dalių, kuriose yra įtampa!**  
Pavojus gyvybei dėl elektros smūgio netinkamo remonto atveju

- ▶ Elektrinės dalis remontuoti turi kvalifikuoti elektrikai.
- ▶ Po remonto pasirūpinkite, kad būtų atliktas saugos bandymas pagal VDE 0701 arba šalyje galiojančius reglamentus.

**⚠ PAVOJUS**  
**Elektros smūgio pavojus dėl dalių, kuriose yra įtampa!**  
Mirtis dėl elektros smūgio

- ▶ Prieš pradėdami remontą, ne mažiau kaip prieš 60 sekundžių atjunkite prietaisus nuo elektros tiekimo.

**⚠ PERSPĖJIMAS**  
**Aštrios briaunos!**  
Galima įsipjauti

- ▶ Mūvėkite apsaugines pirštines.

### Reikalavimas.

- ✓ Prietaisas turi būti atjungtas nuo maitinimo šaltinio.
- ✓ Durelės turi būti atidarytos.

### 4.16.1 LED apšvietimo lempučių išėmimas

1. Pasinaudokite specialiu įrankiu ir išimkite LED apšvietimo lempučių (1).

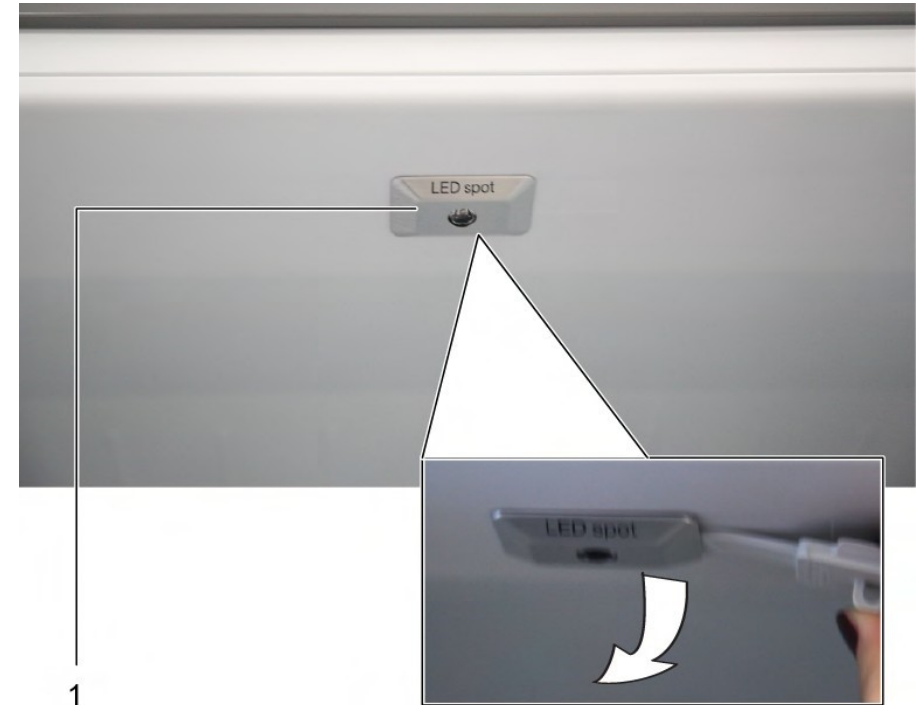

2. Atjunkite elektros LED apšvietimo lempučių jungtis.
- ➡ LED apšvietimo lempučių išimta.

### 4.16.2 LED apšvietimo lempučių montavimas

- ▶ Uždėkite atvirkščiai eilės tvarka.

## 4.17 Viršutinės LED keitimas

### Specialūs įrankiai.

- Atsuktuvas su įpjovomis
- Mentė 2,4 mm x 0,4 mm x 60 mm, rinkinyje [00341820]

**i** Jūsų prietaise įrengta techninės priežiūros nereikalaujanti LED lemputė. Šią lemputę gali taisyti tik klientų aptarnavimo tarnybos specialistai arba įgalioti technikai!

**⚠ PAVOJUS**  
**Elektros smūgio pavojus dėl dalių, kuriose yra įtampa!**  
Pavojus gyvybei dėl elektros smūgio netinkamo remonto atveju

- ▶ Elektrines dalis remontuoti turi kvalifikuoti elektrikai.
- ▶ Po remonto pasirūpinkite, kad būtų atliktas saugos bandymas pagal VDE 0701 arba šalyje galiojančius reglamentus.

**⚠ PAVOJUS**  
**Elektros smūgio pavojus dėl dalių, kuriose yra įtampa!**  
Mirtis dėl elektros smūgio

- ▶ Prieš pradėdami remontą, ne mažiau kaip prieš 60 sekundžių atjunkite prietaisus nuo elektros tiekimo.

**⚠ PERSPĖJIMAS**  
**Aštrios briaunos!**  
Galima įsijauti

- ▶ Mūvėkite apsaugines pirštines.

### Reikalavimas.

- ✔ Prietaisas turi būti atjungtas nuo maitinimo šaltinio.
- ✔ Durelės turi būti atidarytos.
- ✔ Viršutiniai vidiniai tvirtinimo elementai turi būti nuimti.

## 4.17.1 LED lemputės išėmimas

1. Perkelkite LED lemputę į kairę.



- ➡ LED elektros jungtis turi būti atjungta.

2. Atleiskite LED lemputės kabliukus.

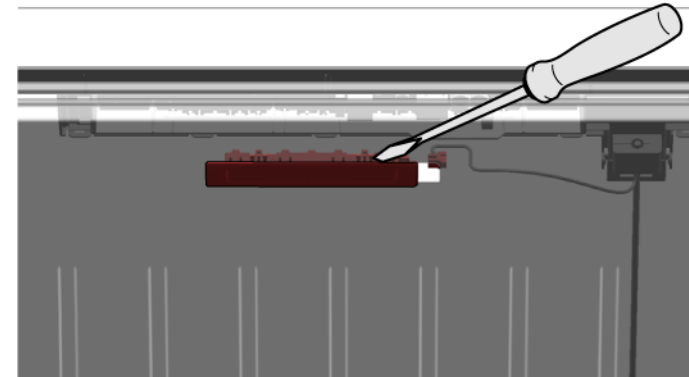

3. Išimkite LED lempuotę, perkeldami ją į priekį.

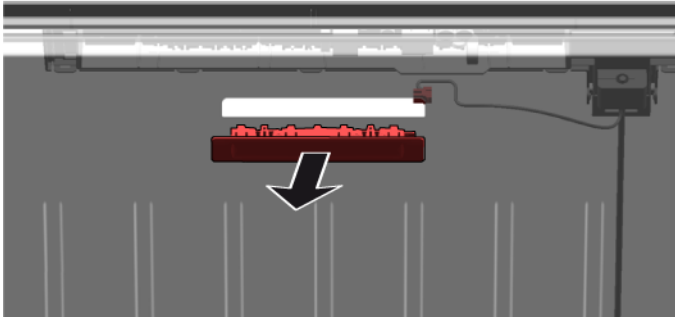

- ➔ LED lempuotė išimta.

### 4.17.2 Viršutinės LED lempuotės montavimas

- ▶ Uždėkite atvirkščia eilės tvarka.

## 4.18 Šoninės pailgos LED lemputės keitimas

Specialūs įrankiai.

Siurbtukas Ø50 mm [00342224]

 Jūsų prietaise įrengta techninės priežiūros nereikalaujanti LED lemputė. Šią lemputę gali taisyti tik klientų aptarnavimo tarnybos specialistai arba įgalioti technikai!

 **PAVOJUS**  
**Elektros smūgio pavojus dėl dalių, kuriose yra įtampa!**  
Pavojus gyvybei dėl elektros smūgio netinkamo remonto atveju

- ▶ Elektrinės dalis remontuoti turi kvalifikuoti elektrikai.
- ▶ Po remonto pasirūpinkite, kad būtų atliktas saugos bandymas pagal VDE 0701 arba šalyje galiojančius reglamentus.

 **PAVOJUS**  
**Elektros smūgio pavojus dėl dalių, kuriose yra įtampa!**  
Mirtis dėl elektros smūgio

- ▶ Prieš pradėdami remontą, ne mažiau kaip prieš 60 sekundžių atjunkite prietaisus nuo elektros tiekimo.

 **PERSPĖJIMAS**  
**Aštrios briaunos!**  
Galima įsipjauti

- ▶ Mūvėkite apsaugines pirštines.

Reikalavimas.

- ✓ Prietaisas turi būti atjungtas nuo maitinimo šaltinio.
- ✓ Durelės turi būti atidarytos.
- ✓ Šaldytuvo skyriaus lentynos išimtos.

### 4.18.1 Šoninės pailgos LED lemputės išėmimas

1. Prilipdykite siurbtuką prie viršutinės pailgos LED šoninės lemputės viršutinio trečdaliao.



2. Patraukite siurbtuką kartu su priekine pailga LED šonine lempute vienu sukamuju judesiu.

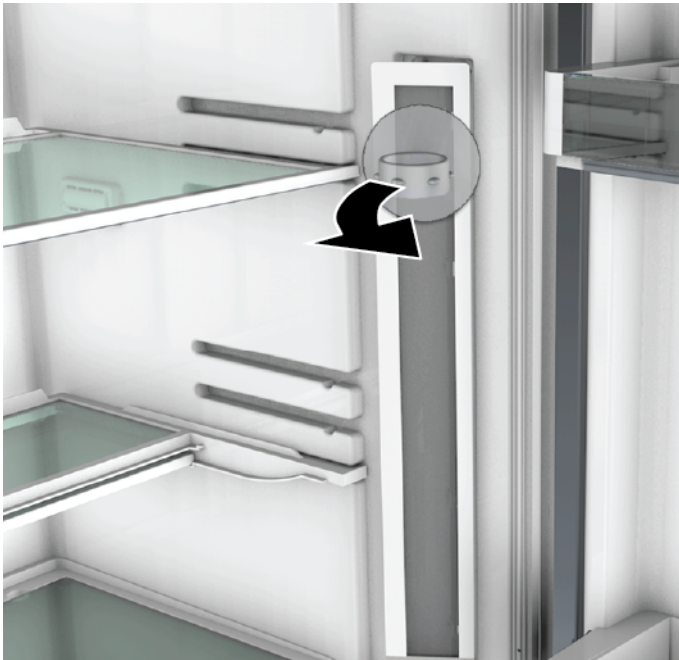

3. Atjunkite šoninės pailgos LED lemputės elektros jungtį.  
➡ Šoninės pailgos LED lemputės elektros jungtis.

### 4.18.2 Šoninės pailgos LED lemputės montavimas

1. Prijunkite šoninės pailgos LED lemputės elektros jungtį.
  2. Pritvirtinkite šoninę pailgą LED lemputę į jai skirtą vietą skyrelio sienelėje (užfiksuokite kabliukus).
- ➡ Šoninė pailga LED lemputė sumontuota.

# Reparasjonstips - Kjøl-/frysekombinasjon

 <b>Om dette dokumentet</b> .....	<b>408</b>
1.1 Viktig informasjon .....	408
1.1.1 Formål.....	408
1.2 Forklaring av symboler.....	408
1.2.1 Farenivåer .....	408
1.2.2 Faresymboler.....	408
1.2.3 Advarslenes struktur .....	409
1.2.4 Generelle symboler .....	409
 <b>Sikkerhet</b> .....	<b>410</b>
2.1 Generelle sikkerhetsinstruksjoner .....	410
2.1.1 Alle husholdningsapparater .....	410
 <b>Verktøy og hjelpemidler</b> .....	<b>411</b>
 <b>Reparasjon</b> .....	<b>412</b>
4.1 Utskiftning av dørpakning.....	412
4.2 Utskiftning av dørhåndtak.....	413
4.2.1 Demontering av dørhåndtak .....	413
4.2.2 Montering av dørhåndtak.....	413
4.3 Utskiftning av øvre dørhengsel .....	414
4.3.1 Demontering av øvre dørhengsel .....	414
4.3.2 Montering av øvre dørhengsel .....	415
4.4 Utskiftning av øvre dørhengsel (dør med display) .....	416
4.4.1 Demontering av øvre dørhengsel .....	416
4.4.2 Montering av øvre dørhengsel .....	417
4.5 Utskiftning av midtre dørhengsel .....	418
4.5.1 Demontering av midtre dørhengsel .....	418
4.5.2 Montering av midtre dørhengsel.....	418
4.6 Utskiftning av nedre dørhengsel .....	419
4.6.1 Demontering av nedre dørhengsel .....	419
4.6.2 Montering av nedre dørhengsel .....	419
4.7 Utskiftning av hylle.....	420
4.7.1 Demontering av hylle.....	420
4.7.2 Montering av hylle .....	420
4.8 Utskiftning av variabel hylle .....	421

4.8.1 Demontering av variabel hylle .....	421
4.8.2 Montering av variabel hylle.....	421
4.9 Utskiftning av fleksibel hylle .....	422
4.9.1 Demontering av fleksibel hylle .....	422
4.9.2 Montering av fleksibel hylle .....	422
4.10 Utskiftning av frokostsett.....	423
4.10.1 Demontering av frokostsett .....	423
4.10.2 Montering av frokostsett.....	423
4.11 Utskiftning av flaskehylle .....	424
4.11.1 Demontering av flaskehylle .....	424
4.11.2 Montering av flaskehylle.....	424
4.12 Utskiftning av dørrack.....	425
4.12.1 Demontering av dørrack.....	425
4.12.2 Montering av dørrack .....	425
4.13 Utskiftning av beholder for frysevarer .....	426
4.13.1 Demontering av beholder for frysevarer .....	426
4.13.2 Montering av beholder for frysevarer.....	426
4.14 Utskiftning av beholder .....	427
4.14.1 Demontering av beholder .....	427
4.14.2 Montering av beholder .....	427
4.15 Utskiftning av uttrekkbar beholder .....	428
4.15.1 Demontering av uttrekkbar beholder .....	428
4.15.2 Montering av uttrekkbar beholder .....	428
4.16 Utskiftning av LED-spotlight.....	429
4.16.1 Demontering av LED-spotlight.....	429
4.16.2 Montering av LED-spotlight .....	429
4.17 Utskiftning av øverste LED-lampe .....	430
4.17.1 Demontering av LED-lampe .....	430
4.17.2 Montering av øverste LED-lampe .....	431
4.18 Utskiftning av LED-lampe i sidelist .....	432
4.18.1 Demontering av LED-lampe i sidelist .....	432
4.18.2 Montering av LED-lampe i sidelist.....	433

# i Om dette dokumentet

## 1.1 Viktig informasjon

### 1.1.1 Formål

Disse tipsene om reparasjon skal hjelpe kunden til selv å kunne reparere apparater i samsvar med gjeldende regulering av øko-design (med gyldighet 03/2021).





De inneholder informasjon om hvordan definerte reservedeler skiftes, inklusive advarsler og risikoer.

Kontakt vår kundeservice dersom du har spørsmål. Vi påtar oss kun ansvar for skader dersom tipsene om reparasjon er korrekt fulgt.

## 1.2 Forklaring av symboler

### 1.2.1 Farenivåer

Advarslene som viser farenivå, består av et symbol og et signalord. Signalordet viser hvor alvorlig faren er.





Advarsel som viser farenivå	Betydning
 <b>FARE</b>	Dersom advarselen ignoreres, vil det føre til død eller alvorlige personskader.
 <b>ADVARSEL</b>	Dersom advarselen ignoreres, kan det føre til død eller alvorlige personskader.
 <b>FORSIKTIG</b>	Dersom advarselen ignoreres, kan det føre til mindre personskader.
 <b>OBS!</b>	Dersom advarselen ignoreres, kan det føre til materiell skade.

Tabell 1: Farenivåer



### 1.2.2 Faresymboler

Faresymboler er symbolske fremstillinger som gir en indikasjon av hvilken type fare det dreier seg om.

Følgende faresymboler brukes i dette dokumentet:

Faresymbol	Betydning
	Generell advarsel
	Fare for elektrisk støt
	Eksplisjonsfare
	Fare for å skjære seg
	Klemfare

## i Om dette dokumentet

Faresymbol	Betydning
	Fare på grunn av varme overflater
	Fare på grunn av sterkt magnetfelt
	Fare fra ikke-ioniserende stråling

Tabell 2: Faresymboler

### 1.2.3 Advarslenes struktur

Advarslene i dette dokumentet har standardisert utseende og standardisert struktur.



	<div style="background-color: red; color: white; padding: 2px; text-align: center;"><b>FARE</b></div> <p><b>Faretype og kilde til fare!</b> Mulige konsekvenser dersom fare/advarsel ignoreres.</p> <ul style="list-style-type: none"> <li>▶ Tiltak og forbud for å forebygge fare.</li> </ul>
--	--





Eksemplet nedenfor viser en advarsel mot elektrisk støt på grunn av strømførende deler. Tiltaket for å unngå faren er angitt.

	<div style="background-color: red; color: white; padding: 2px; text-align: center;"><b>FARE</b></div> <p><b>Fare for elektrisk støt på grunn av strømførende deler!</b> Død på grunn av drepende elektrisk støt</p> <ul style="list-style-type: none"> <li>▶ Koble apparatene fra strømforsyningen i minst 60 sekunder før reparasjonene startes.</li> </ul>
---	--

### 1.2.4 Generelle symboler

Følgende generelle symboler brukes i dette dokumentet:

Gen. symbol	Betydning
	Identifisering av et spesielt tips (tekst og/eller grafikk)
	Identifisering av et enkelt tips (kun tekst)
	Identifisering av en lenke til en opplæringsvideo

Gen. symbol	Betydning
	Identifisering av nødvendig verktøy
	Identifisering av nødvendige forutsetninger
	Identifisering av en betingelse (hvis ..., så ...)
	Identifisering av et resultat
[Start]	Identifisering av en tast eller knapp
[00123456]	Identifisering av et materialnummer
Status	Identifisering av vist tekst/vindu (i apparatets display)

Tabell 3: Generelle symboler

## 2.1 Generelle sikkerhetsinstruksjoner

### 2.1.1 Alle husholdningsapparater

#### **Fare for elektrisk støt på grunn av strømførende deler!**

- Feil ved reparasjoner hvor elektriske komponenter er involvert, kan føre til elektrisk støt!
- Koble apparatet fra strømmettet i minst 60 sekunder før arbeidet startes.
- Etter reparasjonen må du sørge for at det utføres en sikkerhetstest iht. VDE 0701 eller gjeldende forskrifter i det respektive land.

#### **Fare for personskade på grunn av skarpe kanter!**

- Bruk vernehansker.

#### **Fare for å knuse legemsdeler under reparasjoner, vedlikehold, feilsøking og service på grunn av tunge og bevegelige komponenter**

- Bruk vernesko.
- Sikre tunge komponenter for å hindre at de faller ned.
- Ikke stikk kroppsdelene inn i bevegelige komponenter.

#### **Fare for apparatets sikkerhet/funksjon!**

- Bruk kun originale reservedeler.

#### **Fare for skade på deler som er følsomme overfor elektrostatisk utlading (ESD)!**

- Ikke berør modulene, inklusive tilkoblinger og ledere.

## Verktøy og hjelpemidler

Betegnelse	Detaljer	Bilder
Beskyttelsesklut [00342013]	60 cm x 50 cm	
Sett med presisjonsskrutrekkerer [00341820]	9 stk., 2,0 mm, 2,4 mm, 3,0 mm, PH0, PH00, PH1, TX6, TX8, TX9	
Hjelpeverktøy [00342180]	Verktøy for å løsne plastdeler, "magic tool"	
Sugekopp [00342224]	Ø 50 mm	
Torx-bits TX20 [00340865]	6,3 mm (1/4")	
Flat skrutrekker	Blad 10 mm x 1,6 mm x 200 mm	

# Reparasjon



## 4.1 Utskiftning av dørpakning

### Forutsetning:



- Døren er åpen.

## 4.2 Utskiftning av dørhåndtak

### Spesielle hjelpemidler:

-  Torx-bits TX20                      6,3 mm (1/4")                      [00340865]
-  Flat skrutrekker                      Blad 10 mm x 1,6 mm x 200 mm

### Forutsetning:

-  Apparatet kobles fra strømforsyningen.
-  Døren er åpen.

### 4.2.1 Demontering av dørhåndtak

- ▶ 1. Fjern to skruhetter (1).
- ▶ 2. Skru ut to skruer (2).
- ▶ 3. Demonter dørhåndtaket (3).

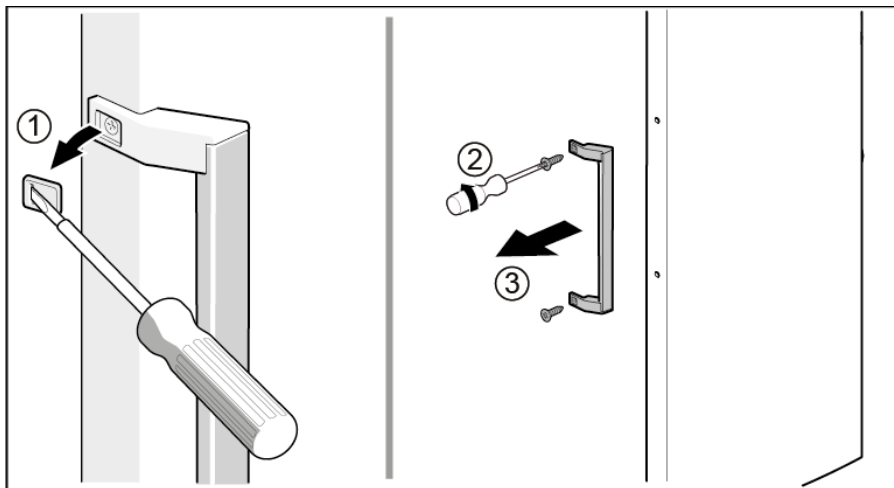

 Dørhåndtaket er demontert.



Dørhåndtaket for den andre døren kan demonteres på samme måte.

### 4.2.2 Montering av dørhåndtak

- ▶ Monteres i motsatt rekkefølge.





## 4.3 Utskiftning av øvre dørhengsel

### Spesielle hjelpemidler:

Torx-bits TX20

6,3 mm (1/4")

[00340865]

	<b>ADVARSEL</b> <b>Tunge, klumpete apparater!</b> Rygg- og muskelskader <ul style="list-style-type: none"><li>▶ Arbeidet med å demontere apparatets dør skal bare utføres av opplærte spesialister.</li><li>▶ Det kreves to personer for å flytte på apparatet.</li><li>▶ Bruk kun egnet verktøy og utstyr.</li></ul>
	<b>FORSIKTIG</b> <b>Skarpe kanter!</b> Kuttskader <ul style="list-style-type: none"><li>▶ Bruk vernehansker.</li></ul>
	<b>ADVARSEL</b> <b>Tiltede apparater kan skli ut!</b> Beinbrudd/klemskader <ul style="list-style-type: none"><li>▶ Sikre apparatene mot å skli ut.</li></ul>
	<b>FORSIKTIG</b> <b>Fare for at deler kan falle ned på grunn av løsnede skruer!</b> Personskade på grunn av fallende deler. <ul style="list-style-type: none"><li>▶ Sikre komponenten så den ikke kan falle ned.</li></ul>
	<b>OBS!</b> <b>Fare for at deler kan falle ned på grunn av løsnede skruer!</b> Skade på andre deler på apparatet eller i kundens hjem, f.eks. gulv. <ul style="list-style-type: none"><li>▶ Sikre komponenten så den ikke kan falle ned.</li></ul>

### Forutsetning:

- ✓ Apparatet kobles fra strømforsyningen.
- ✓ Apparatets innvendige beslag er demontert.

### 4.3.1 Demontering av øvre dørhengsel

1. Plasser apparatet på baksiden.

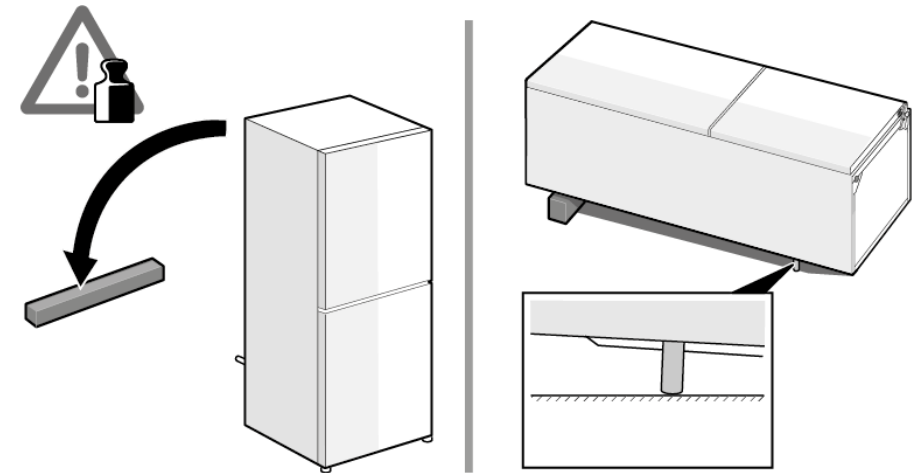

## Reparasjon

2. 1. Trykk inn det øvre hengseldekslet på begge sider (1).
2. Beveg det øvre hengseldekslet ut (2).
3. Drei hengseldekslet (3).
4. Ta av det øvre hengseldekslet (4).
5. Skru ut to skruer (5).
6. Demonter øvre hengsel (6)/

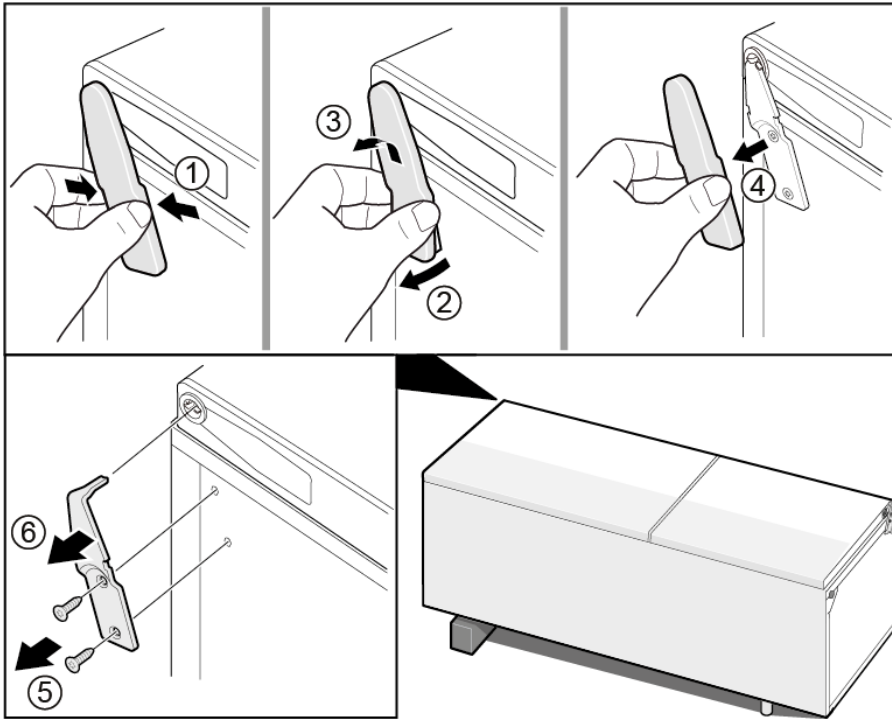

 Øvre hengsel er demontert.

### 4.3.2 Montering av øvre dørhengsel

- ▶ Monteres i motsatt rekkefølge.

## 4.4 Utskiftning av øvre dørhengsel (dør med display)

### Spesielle hjelpemidler:

Torx-bits TX20 6,3 mm (1/4") [00340865]

	<b>ADVARSEL</b> <b>Tunge, klumpete apparater!</b> Rygg- og muskelskader <ul style="list-style-type: none"><li>Arbeidet med å demontere apparatets dør skal bare utføres av opplærte spesialister.</li><li>Det kreves to personer for å flytte på apparatet.</li><li>Bruk kun egnet verktøy og utstyr.</li></ul>
--	---

	<b>FORSIKTIG</b> <b>Skarpe kanter!</b> Kuttskader <ul style="list-style-type: none"><li>Bruk vernehansker.</li></ul>
--	--

	<b>ADVARSEL</b> <b>Tiltede apparater kan skli ut!</b> Beinbrudd/klemskader <ul style="list-style-type: none"><li>Sikre apparatene mot å skli ut.</li></ul>
--	--

	<b>FORSIKTIG</b> <b>Fare for at deler kan falle ned på grunn av løsnede skruer!</b> Personskade på grunn av fallende deler. <ul style="list-style-type: none"><li>Sikre komponenten så den ikke kan falle ned.</li></ul>
---	--

	<b>OBS!</b> <b>Fare for at deler kan falle ned på grunn av løsnede skruer!</b> Skade på andre deler på apparatet eller i kundens hjem, f.eks. gulv. <ul style="list-style-type: none"><li>Sikre komponenten så den ikke kan falle ned.</li></ul>
--	--

	<b>FARE</b> <b>Fare for elektrisk støt på grunn av strømførende deler!</b> Livsfare på grunn av elektrisk støt ved feil reparasjon <ul style="list-style-type: none"><li>Elektriske deler skal repareres av kvalifiserte elektrikere.</li><li>Etter reparasjonen må du sørge for at det utføres en sikkerhets-test iht. VDE 0701 eller gjeldende forskrifter i det respektive land.</li></ul>
---	---

	<b>FARE</b> <b>Fare for elektrisk støt på grunn av strømførende deler!</b> Død på grunn av drepende elektrisk støt <ul style="list-style-type: none"><li>Koble apparatene fra strømforsyningen i minst 60 sekunder før reparasjonene startes.</li></ul>
---	---

### Forutsetning:

- ✓ Apparatet kobles fra strømforsyningen.
- ✓ Apparatets innvendige beslag er demontert.

### 4.4.1 Demontering av øvre dørhengsel

1. Plasser apparatet på baksiden.

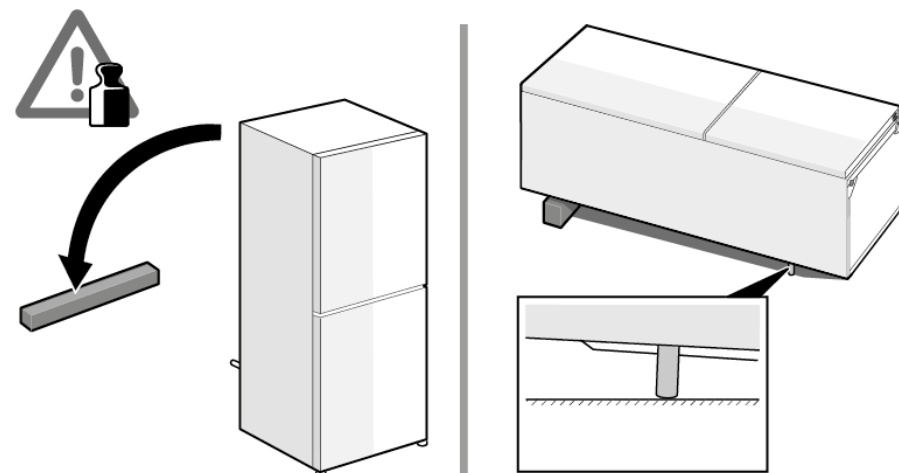

## Reparasjon

2. 1. Ta av det øvre hengseldekslet (1).
2. Ta av kabelboksdekslet (2).
3. Koble fra den elektriske tilkoblingen (3).
4. Skru ut skruen for jordkoblingen (4).
5. Fjern kabelbeskyttelsen (5).
6. Skru ut skruen (6)

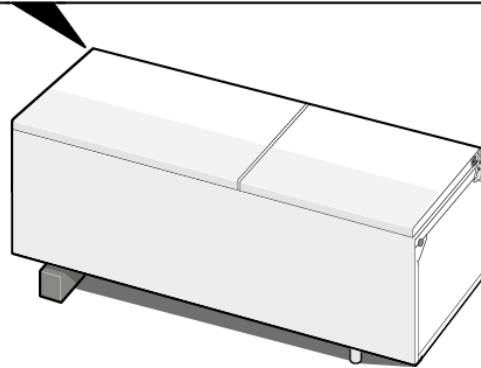
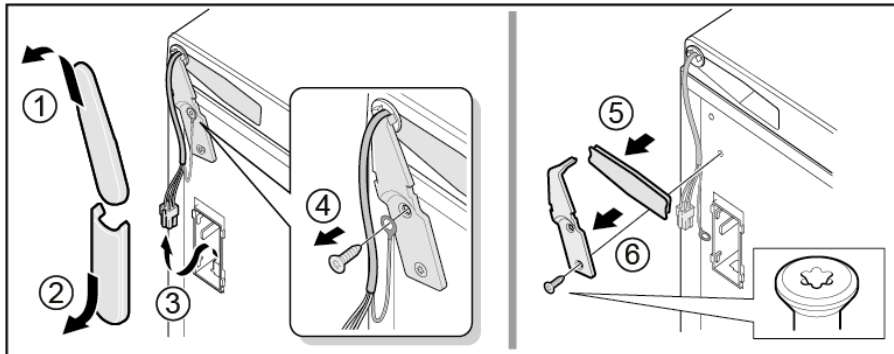

 Øvre hengsel er demontert.

### 4.4.2 Montering av øvre dørhengsel

- ▶ Monteres i motsatt rekkefølge.

## 4.5 Utskiftning av midtre dørhengsel

### Spesielle hjelpemidler:

Torx-bits TX20 6,3 mm (1/4") [00340865]

	<b>ADVARSEL</b> <b>Tunge, klumpete apparater!</b> Rygg- og muskelskader <ul style="list-style-type: none"><li>▶ Arbeidet med å demontere apparatets dør skal bare utføres av opplærte spesialister.</li><li>▶ Det kreves to personer for å flytte på apparatet.</li><li>▶ Bruk kun egnet verktøy og utstyr.</li></ul>
--	---

	<b>FORSIKTIG</b> <b>Skarpe kanter!</b> Kuttskader <ul style="list-style-type: none"><li>▶ Bruk vernehansker.</li></ul>
--	--

	<b>ADVARSEL</b> <b>Tiltede apparater kan skli ut!</b> Beinbrudd/klemskader <ul style="list-style-type: none"><li>▶ Sikre apparatene mot å skli ut.</li></ul>
--	--

	<b>FORSIKTIG</b> <b>Fare for at deler kan falle ned på grunn av løsnede skruer!</b> Personskade på grunn av fallende deler. <ul style="list-style-type: none"><li>▶ Sikre komponenten så den ikke kan falle ned.</li></ul>
---	--

	<b>OBS!</b> <b>Fare for at deler kan falle ned på grunn av løsnede skruer!</b> Skade på andre deler på apparatet eller i kundens hjem, f.eks. gulv. <ul style="list-style-type: none"><li>▶ Sikre komponenten så den ikke kan falle ned.</li></ul>
--	--

### Forutsetning:

- ✔ Apparatet kobles fra strømforsyningen.
- ✔ Apparatets innvendige beslag er demontert.
- ✔ Øvre dørhengsel er demontert.
- ✔ Øvre dør er demontert.

### 4.5.1 Demontering av midtre dørhengsel

- ▶ 1. Demonter døren til frysen (1).
- ▶ 2. Skru ut to skruer (2).
- ▶ 3. Demonter midtre hengsel (3).

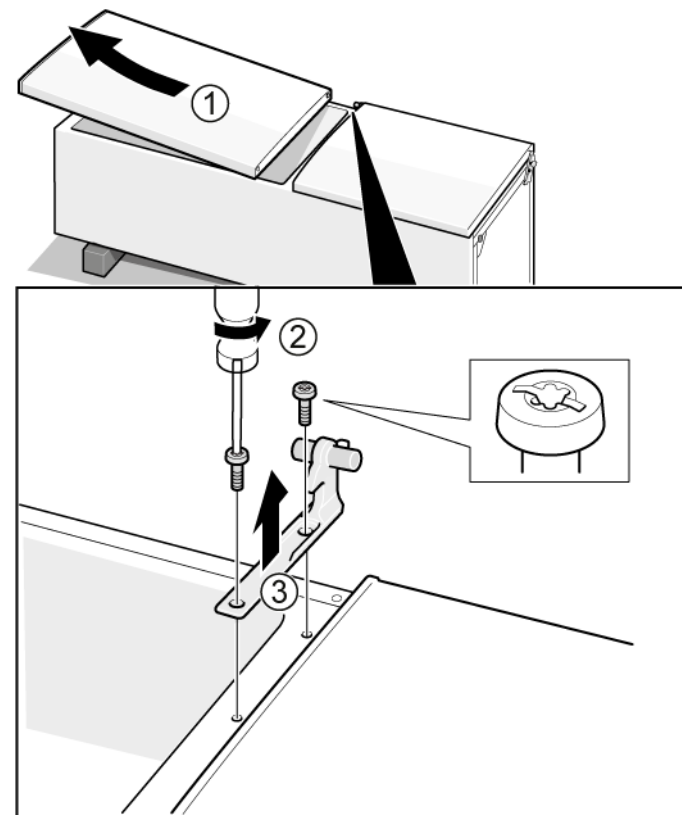

➡ Midtre hengsel er demontert.

### 4.5.2 Montering av midtre dørhengsel

- ▶ Monteres i motsatt rekkefølge.

## 4.6 Utskiftning av nedre dørhengsel

### Spesielle hjelpemidler:

Torx-bits TX20 6,3 mm (1/4") [00340865]

	<b>ADVARSEL</b> <b>Tunge, klumpete apparater!</b> Rygg- og muskelskader ▶ Arbeidet med å demontere apparatets dør skal bare utføres av opplærte spesialister. ▶ Det kreves to personer for å flytte på apparatet. ▶ Bruk kun egnet verktøy og utstyr.
--	--

	<b>FORSIKTIG</b> <b>Skarpe kanter!</b> Kuttskader ▶ Bruk vernehansker.
--	---

	<b>ADVARSEL</b> <b>Tiltede apparater kan skli ut!</b> Beinbrudd/klemskader ▶ Sikre apparatene mot å skli ut.
--	---

	<b>FORSIKTIG</b> <b>Fare for at deler kan falle ned på grunn av løsnede skruer!</b> Personskade på grunn av fallende deler. ▶ Sikre komponenten så den ikke kan falle ned.
---	---

	<b>OBS!</b> <b>Fare for at deler kan falle ned på grunn av løsnede skruer!</b> Skade på andre deler på apparatet eller i kundens hjem, f.eks. gulv. ▶ Sikre komponenten så den ikke kan falle ned.
--	---

### Forutsetning:

- ✔ Apparatet kobles fra strømforsyningen.
- ✔ Apparatets innvendige beslag er demontert.
- ✔ Øvre hengsel er demontert.
- ✔ Midtre hengsel er demontert.

### 4.6.1 Demontering av nedre dørhengsel

- ▶ 1. Demonter døren til frysen (1).
- ▶ 2. Skru ut skruen (2).
- ▶ 3. Drei den nedre hengselen ut (3).
- ▶ 4. Demonter nedre hengsel (4).

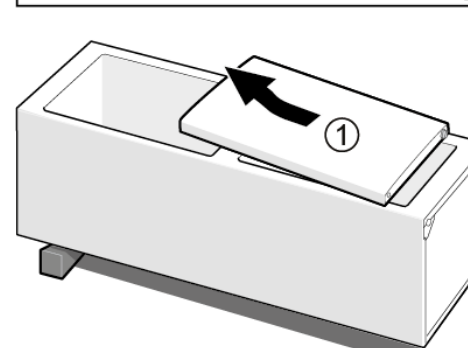
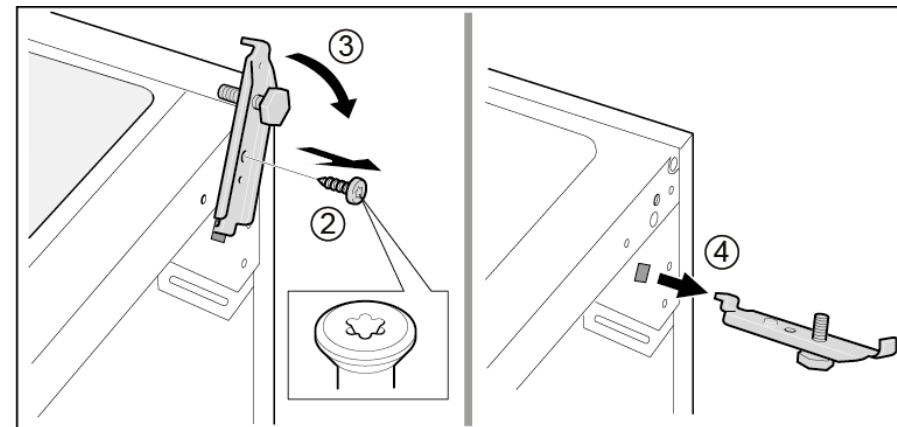

➡ Nedre dørhengsel er demontert.

### 4.6.2 Montering av nedre dørhengsel

- ▶ Monteres i motsatt rekkefølge.

## 4.7 Utskiftning av hylle

### Forutsetning:

- ✔ Døren er åpen.

### 4.7.1 Demontering av hylle

- ▶ Trekk ut hyllen.

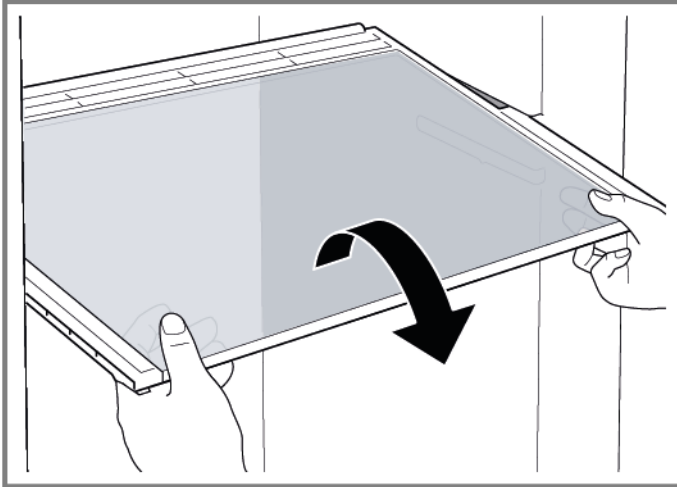

- ➡ Hyllen er demontert.

### 4.7.2 Montering av hylle

- ▶ Monteres i motsatt rekkefølge.

## 4.8 Utskiftning av variabel hylle

### Forutsetning:

- ✔ Døren er åpen.

### 4.8.1 Demontering av variabel hylle

1. Trekk høyre del av den variable hyllen forover (1).
2. Demonter høyre del av den variable hyllen (2).

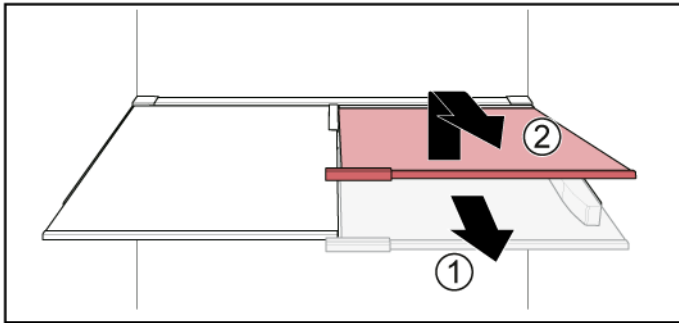

2. Demonter venstre del av den variable hylle på samme måte.

- ➡ Den variable hyllen er demontert.

### 4.8.2 Montering av variabel hylle

- ▶ Monteres i motsatt rekkefølge.

## 4.9 Utskiftning av fleksibel hylle

Forutsetning:

- ✔ Døren er åpen.

### 4.9.1 Demontering av fleksibel hylle

- ▶ 1. Ta ut glasshyllen (1).
- ▶ 2. Løft opp den fleksible hyllen og trekk den ut (2).

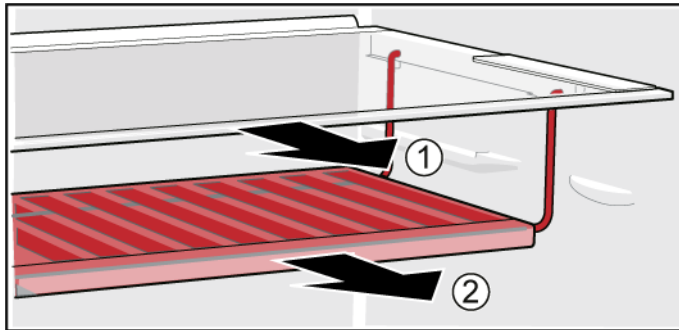

- ➡ Den fleksible hyllen er demontert.

### 4.9.2 Montering av fleksibel hylle

- ▶ Monteres i motsatt rekkefølge.

## 4.10 Utskiftning av frokostsett

Forutsetning:

- ✔ Døren er åpen.

### 4.10.1 Demontering av frokostsett

- ▶ Løft frokostsettet og trekk det ut.

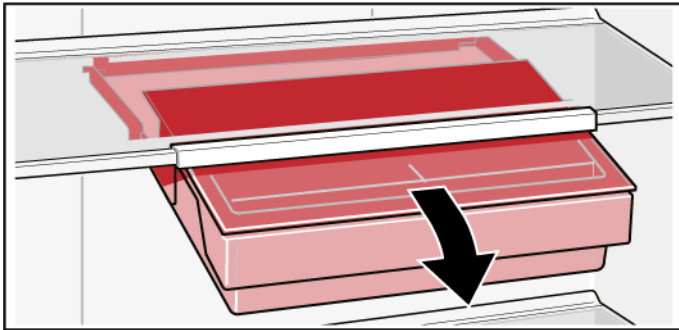

- ➡ Frokostsettet er demontert.

### 4.10.2 Montering av frokostsett

- ▶ Monteres i motsatt rekkefølge.

## 4.11 Utskiftning av flaskehylle

### Forutsetning:

- ✔ Døren er åpen.

### 4.11.1 Demontering av flaskehylle

- ▶ Trekk ut flaskehyllen.

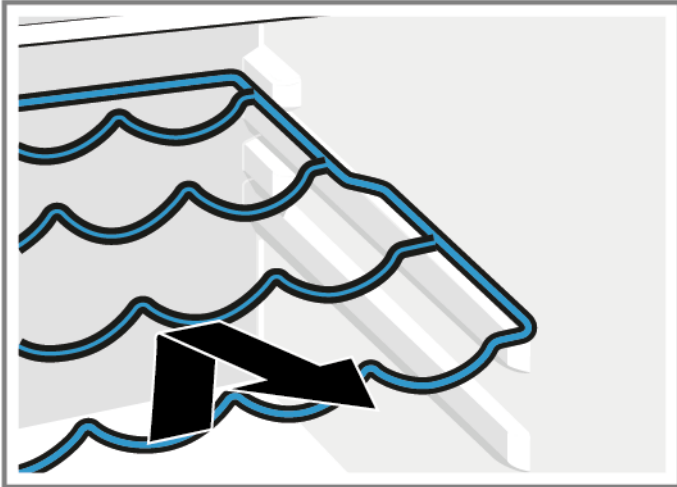

- ➡ Flaskehyllen er demontert.

### 4.11.2 Montering av flaskehylle

- ▶ Monteres i motsatt rekkefølge.

## 4.12 Utskiftning av dørrack

### Forutsetning:

- ✔ Døren er åpen.

### 4.12.1 Demontering av dørrack

- ▶ Løft dørracken opp.

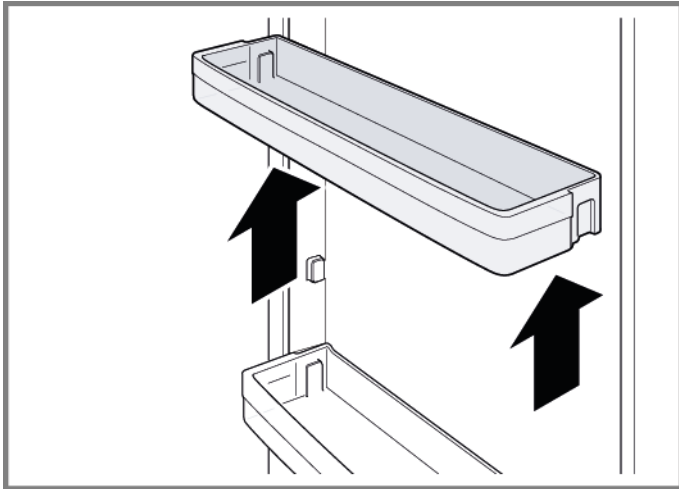

➡ Dørracken er demontert.

### 4.12.2 Montering av dørrack

- ▶ Monteres i motsatt rekkefølge.

## 4.13 Utskiftning av beholder for frysevarer

### Forutsetning:

- ✔ Døren er åpen.

### 4.13.1 Demontering av beholder for frysevarer

- ▶ 1. Trekk beholderen for frysevarer helt ut (1).
- ▶ 2. Ta ut matbeholderen (2).

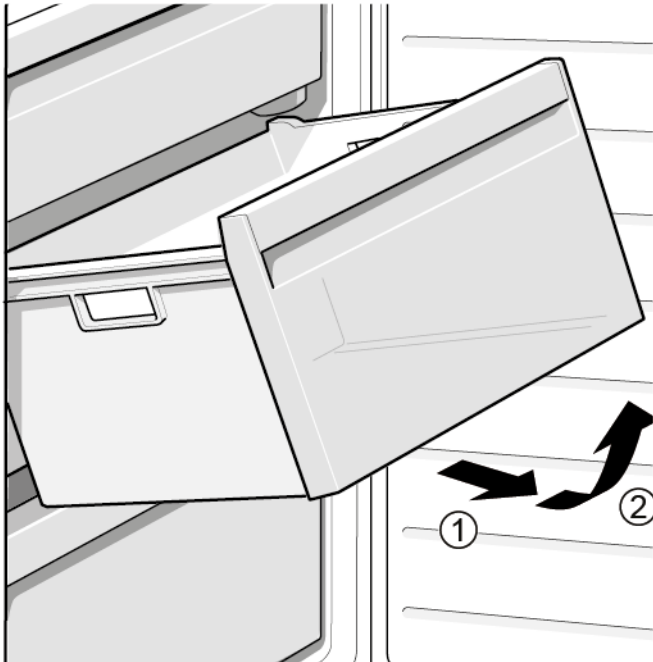

- ➡ Beholderen for frysevarer er demontert.

### 4.13.2 Montering av beholder for frysevarer

- ▶ Monteres i motsatt rekkefølge.

## 4.14 Utskiftning av beholder

### Forutsetning:

- ✔ Døren er åpen.

### 4.14.1 Demontering av beholder

- ▶ 1. Beveg den nedre beholderen i kjøleskapet ut (1).
- ▶ 2. Beveg den øvre beholderen i kjøleskapet ut (2).

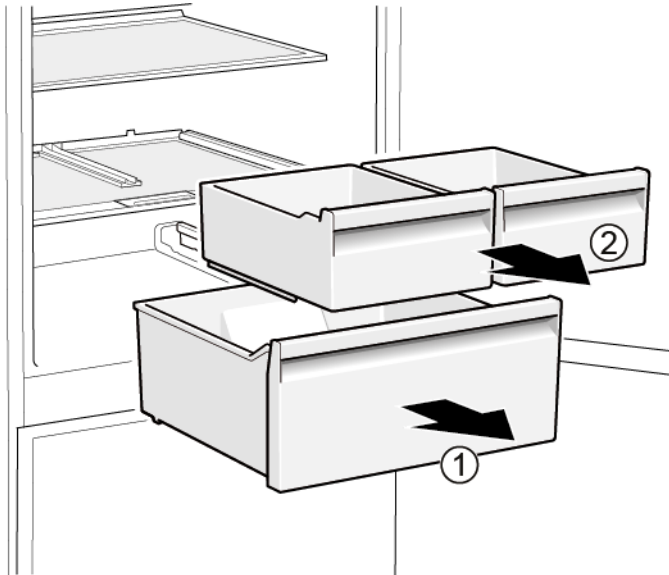

- ➡ Beholderne er demontert.

### 4.14.2 Montering av beholder

- ▶ Monteres i motsatt rekkefølge.

## 4.15 Utskiftning av uttrekkbar beholder

### Forutsetning:

- ✔ Døren er åpen.

### 4.15.1 Demontering av uttrekkbar beholder

- ▶ 1. Trekk den uttrekkbare beholderen helt ut (1).
- ▶ 2. Ta ut den uttrekkbare beholderen (2).

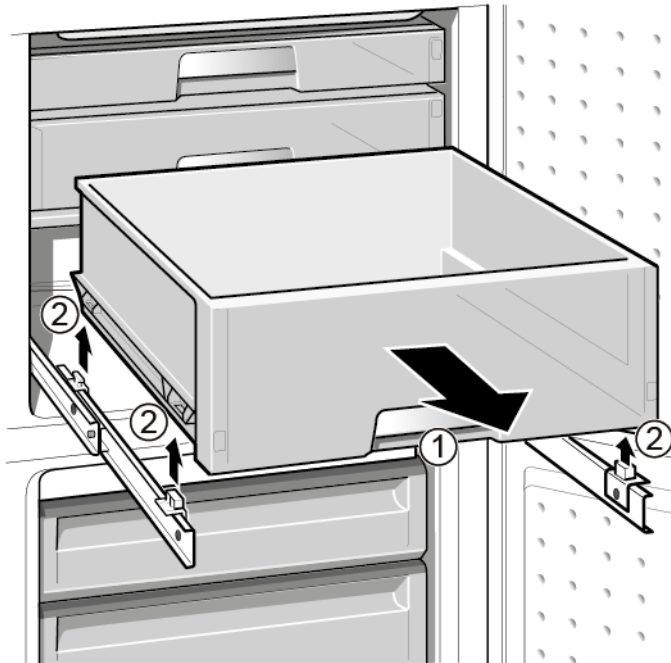

- ➡ Den uttrekkbare beholderen er demontert.

### 4.15.2 Montering av uttrekkbar beholder

- ▶ Monteres i motsatt rekkefølge.

## 4.16 Utskiftning av LED-spotlight

### Spesielle hjelpemidler:

Spesialverktøy

[00342180]



Apparatet har en vedlikeholdsfri LED-lampe.  
Disse lampene skal kun repareres av kundeservice eller autoriserte teknikere!



### FARE

#### Fare for elektrisk støt på grunn av strømførende deler!

Livsfare på grunn av elektrisk støt ved feil reparasjon

- ▶ Elektriske deler skal repareres av kvalifiserte elektrikere.
- ▶ Etter reparasjonen må du sørge for at det utføres en sikkerhetstest iht. VDE 0701 eller gjeldende forskrifter i det respektive land.



### FARE

#### Fare for elektrisk støt på grunn av strømførende deler!

Død på grunn av drepende elektrisk støt

- ▶ Koble apparatene fra strømforsyningen i minst 60 sekunder før reparasjonene startes.



### FORSIKTIG

#### Skarpe kanter!

Kuttskader

- ▶ Bruk vernehansker.

### Forutsetning:

- ✓ Apparatet kobles fra strømforsyningen.
- ✓ Døren er åpen.

## 4.16.1 Demontering av LED-spotlight

1. Bruk spesialverktøy for å trekke ut LED-spotlight (1).

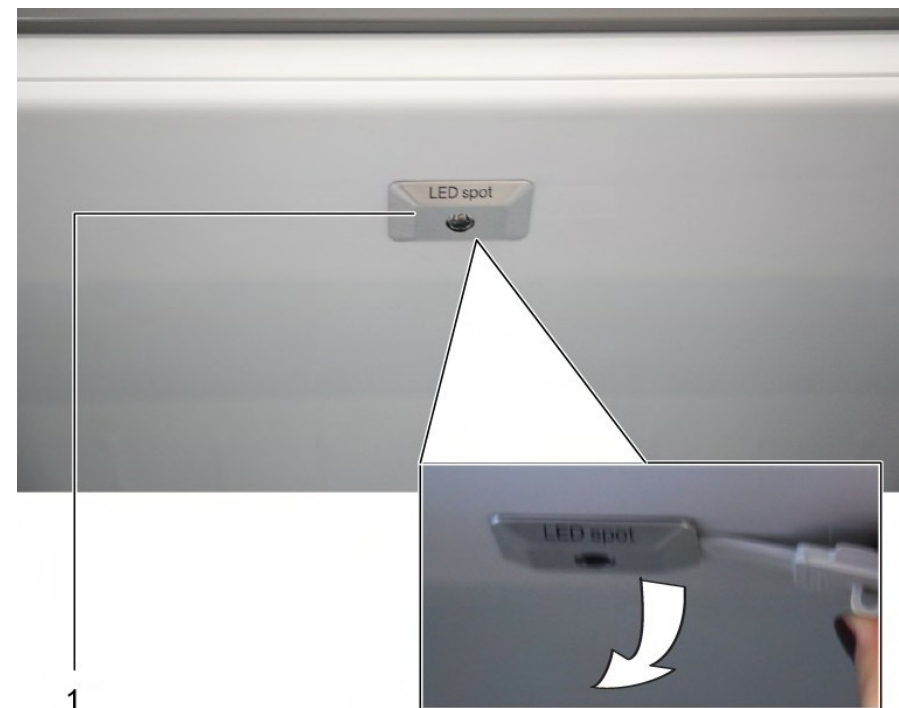

2. Koble fra de elektriske tilkoblingene for LED-spotlight.

➡ LED-spotlight er demontert.

## 4.16.2 Montering av LED-spotlight

- ▶ Monteres i motsatt rekkefølge.

## 4.17 Utskiftning av øverste LED-lampe

### Spesielle hjelpemidler:

- Flat skrutrekker Blad 2,4 mm x 0,4 mm x 60 mm, i sett [00341820]

**i** Apparatet har en vedlikeholdsfri LED-lampe.  
Disse lampene skal kun repareres av kundeservice eller autoriserte teknikere!

**FARE**  
**Fare for elektrisk støt på grunn av strømførende deler!**  
Livsfare på grunn av elektrisk støt ved feil reparasjon

- ▶ Elektriske deler skal repareres av kvalifiserte elektrikere.
- ▶ Etter reparasjonen må du sørge for at det utføres en sikkerhetstest iht. VDE 0701 eller gjeldende forskrifter i det respektive land.

**FARE**  
**Fare for elektrisk støt på grunn av strømførende deler!**  
Død på grunn av drepende elektrisk støt

- ▶ Koble apparatene fra strømforsyningen i minst 60 sekunder før reparasjonene startes.

**FORSIKTIG**  
**Skarpe kanter!**  
Kuttskader

- ▶ Bruk vernehansker.

### Forutsetning:

- ✓ Apparatet kobles fra strømforsyningen.
- ✓ Døren er åpen.
- ✓ De øvre innvendige beslagene er demontert.

### 4.17.1 Demontering av LED-lampe

1. Beveg LED-lampen over til venstre side.

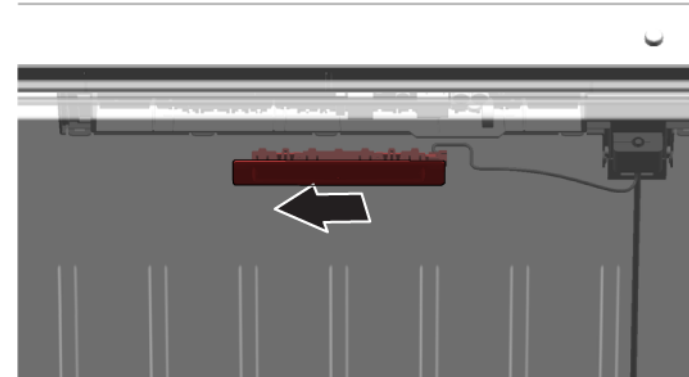

2. Løsne LED-lampens kroker.

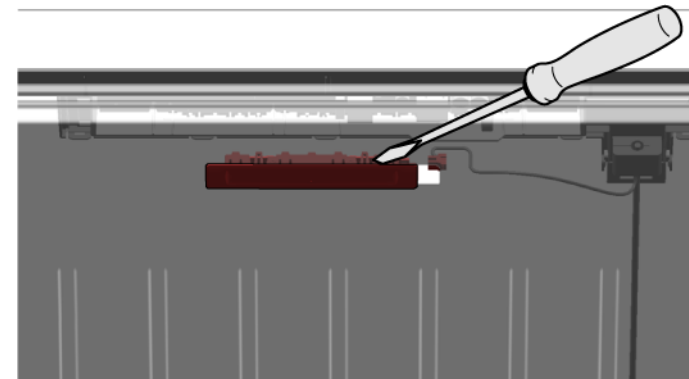

## Reparasjon

3. Demonter LED-lampen ved å bevege den forover.

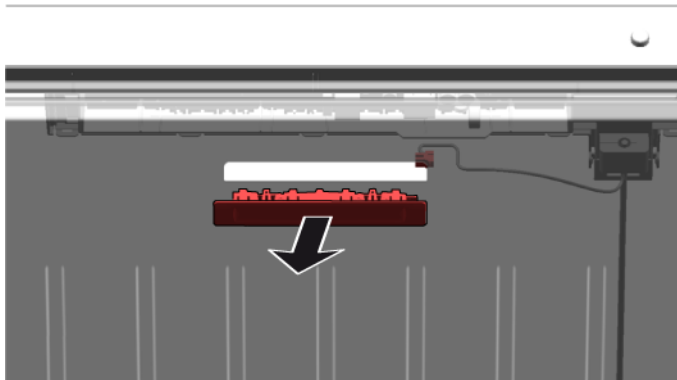

- ➡ LED-lampen er demontert.

### 4.17.2 Montering av øverste LED-lampe

- ▶ Monteres i motsatt rekkefølge.

## 4.18 Utskiftning av LED-lampe i sidelist

### Spesielle hjelpemidler:

Sugekopp Ø50 mm [00342224]

 Apparatet har en vedlikeholdsfri LED-lampe.  
Disse lampene skal kun repareres av kundeservice eller autoriserte teknikere!

 **FARE**  
**Fare for elektrisk støt på grunn av strømførende deler!**  
Livsfare på grunn av elektrisk støt ved feil reparasjon

- ▶ Elektriske deler skal repareres av kvalifiserte elektrikere.
- ▶ Etter reparasjonen må du sørge for at det utføres en sikkerhets-test iht. VDE 0701 eller gjeldende forskrifter i det respektive land.

 **FARE**  
**Fare for elektrisk støt på grunn av strømførende deler!**  
Død på grunn av drepende elektrisk støt

- ▶ Koble apparatene fra strømforsyningen i minst 60 sekunder før reparasjonene startes.

 **FORSIKTIG**  
**Skarpe kanter!**  
Kuttskader

- ▶ Bruk vernehansker.

### Forutsetning:

- ✓ Apparatet kobles fra strømforsyningen.
- ✓ Døren er åpen.
- ✓ Hyllene i fryseren er tatt ut.

### 4.18.1 Demontering av LED-lampe i sidelist

1. Fest sugekoppen på øvre tredel av LED-lampen i sidelisten.



## Reparasjon

2. Trekk sugekoppen forover med LED-lampen i sidelisten i en roterende bevegelse.

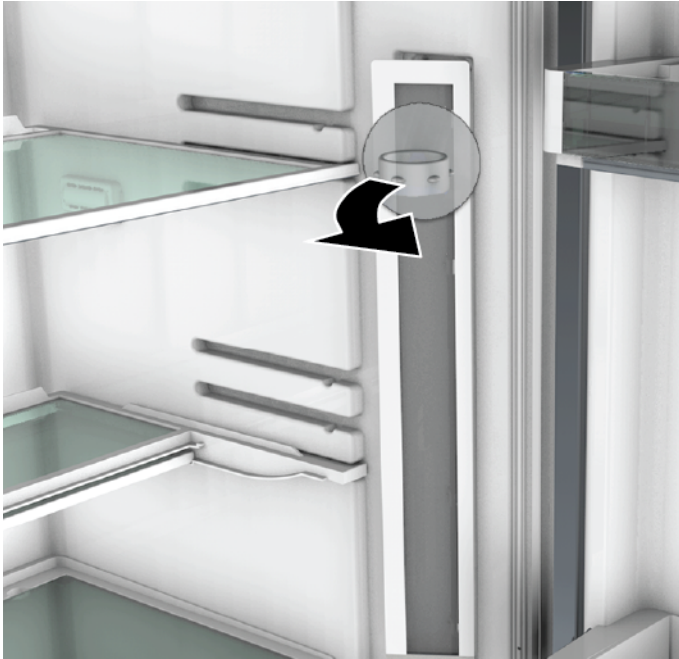





3. Koble fra den elektriske tilkoblingen for LED-lampen i sidelisten.  
➡ LED-lampen i sidelisten er demontert.

### 4.18.2 Montering av LED-lampe i sidelist

1. Koble til den elektriske tilkoblingen for LED-lampen i sidelisten.
  2. Fest LED-lampen i sidelisten på rett sted på veggen i apparatrommet (krokene klikker på plass).
- ➡ LED-lampen i sidelisten er montert.

# Wskazówki naprawy - Chłodziarko-zamrażarka

 <b>Informacje dotyczące dokumentu</b> .....	<b>435</b>		
1.1 Ważne informacje.....	435		
1.1.1 Cel dokumentu .....	435		
1.2 Objasnienie symboli ostrzegawczych.....	435		
1.2.1 Oznaczenie poziomów niebezpieczeństwa .....	435		
1.2.2 Symbole ostrzegawcze.....	435		
1.2.3 Budowa ostrzeżeń .....	436		
1.2.4 Ogólne symbole.....	436		
 <b>Bezpieczeństwo</b> .....	<b>437</b>		
2.1 Ogólne informacje dotyczące bezpieczeństwa.....	437		
2.1.1 Wszystkie sprzęty gospodarstwa domowego .....	437		
 <b>Narzędzia i pomoce techniczne</b> .....	<b>438</b>		
 <b>Naprawy</b> .....	<b>439</b>		
4.1 Wymiana uszczelki drzwiczek .....	439		
4.2 Wymiana uchwytu drzwiczek.....	440		
4.2.1 Demontaż uchwytu drzwiczek .....	440		
4.2.2 Montaż uchwytu drzwiczek .....	440		
4.3 Wymiana górnego zawiasu drzwiczek.....	441		
4.3.1 Demontaż górnego zawiasu drzwiczek.....	441		
4.3.2 Montaż górnego zawiasu drzwiczek .....	442		
4.4 Wymiana górnego zawiasu drzwiczek (drzwiczki z wyświetlaczem).....	443		
4.4.1 Demontaż górnego zawiasu drzwiczek .....	443		
4.4.2 Montaż górnego zawiasu drzwiczek .....	444		
4.5 Wymiana środkowego zawiasu drzwiczek.....	445		
4.5.1 Demontaż środkowego zawiasu drzwiczek .....	445		
4.5.2 Montaż środkowego zawiasu drzwiczek .....	445		
4.6 Wymiana dolnego zawiasu drzwiczek .....	446		
4.6.1 Demontaż dolnego zawiasu drzwiczek .....	446		
4.6.2 Montaż dolnego zawiasu drzwiczek.....	446		
4.7 Wymiana półki.....	447		
4.7.1 Demontaż półki.....	447		
4.7.2 Montaż półki .....	447		
4.8 Wymiana regulowanej półki.....	448		
4.8.1 Demontaż regulowanej półki .....	448		
4.8.2 Montaż regulowanej półki.....	448		
4.9 Wymiana elastycznej półki.....	449		
4.9.1 Demontaż elastycznej półki.....	449		
4.9.2 Montaż elastycznej półki .....	449		
4.10 Wymiana kompletu śniadaniowego .....	450		
4.10.1 Demontaż kompletu śniadaniowego .....	450		
4.10.2 Montaż kompletu śniadaniowego.....	450		
4.11 Wymiana podstawki na butelki .....	451		
4.11.1 Demontaż podstawki na butelki .....	451		
4.11.2 Montaż podstawki na butelki .....	451		
4.12 Wymiana półki drzwiczek.....	452		
4.12.1 Demontaż półki drzwiczek .....	452		
4.12.2 Montaż półki drzwiczek .....	452		
4.13 Wymiana pojemnika na mrożoną żywność .....	453		
4.13.1 Demontaż pojemnika na mrożoną żywność.....	453		
4.13.2 Montaż pojemnika na mrożoną żywność.....	453		
4.14 Wymiana pojemnika .....	454		
4.14.1 Demontaż pojemnika .....	454		
4.14.2 Montaż pojemnika .....	454		
4.15 Wymiana pojemnika wysuwanego.....	455		
4.15.1 Demontaż pojemnika wysuwanego.....	455		
4.15.2 Montaż pojemnika wysuwanego .....	455		
4.16 Wymiana oświetlenia punktowego LED .....	456		
4.16.1 Demontaż oświetlenia punktowego LED .....	456		
4.16.2 Montaż oświetlenia punktowego LED.....	456		
4.17 Wymiana górnego oświetlenia LED.....	457		
4.17.1 Demontaż oświetlenia LED .....	457		
4.17.2 Montaż górnego oświetlenia LED .....	458		
4.18 Wymiana bocznego paska oświetleniowego LED.....	459		
4.18.1 Demontaż bocznego paska oświetleniowego LED .....	459		
4.18.2 Montaż bocznego paska oświetleniowego LED .....	460		

# **i** Informacje dotyczące dokumentu

## 1.1 Ważne informacje

### 1.1.1 Cel dokumentu

Niniejsze wskazówki naprawcze mają na celu zapewnienie użytkownikowi pomocy w samodzielnej naprawie posiadanych urządzeń w sposób zgodny z obowiązującymi przepisami w sprawie ekoprojektu (stan na 03/2021).

Zawierają one informacje na temat wymiany określonych części zamiennych oraz ostrzeżenia i informacje o zagrożeniach.

W razie pytań należy się skontaktować z naszym działem serwisowym. Odpowiedzialność za szkody ponosimy tylko pod warunkiem prawidłowego stosowania się do wskazówek naprawczych.

## 1.2 Objasnienie symboli ostrzegawczych

### 1.2.1 Oznaczenie poziomów niebezpieczeństwa

Poziom ryzyka jest określany przy pomocy symbolu oraz wyrazu. Wyraz określa poziom ryzyka.





Symbol	Znaczenie
 <b>NIEBEZPIECZEŃSTWO</b>	Bezpośrednio zagrażające niebezpieczeństwo, które przy niezachowaniu odpowiednich środków ostrożności może doprowadzić do śmierci lub poważnych obrażeń.
 <b>OSTRZEŻENIE</b>	Prawdopodobieństwo wystąpienia niebezpieczeństwa, które przy niezachowaniu odpowiednich środków ostrożności może doprowadzić do śmierci lub poważnych obrażeń.
 <b>WAŻNE</b>	Prawdopodobieństwo wystąpienia niebezpieczeństwa, które przy niezachowaniu odpowiednich środków ostrożności może doprowadzić do powstania lekkich obrażeń.
<b>UWAGA!</b>	Ostrzeżenie dot. możliwości powstania szkody materialnej.

Tabela 1: Oznaczenie poziomów niebezpieczeństwa

### 1.2.2 Symbole ostrzegawcze

Symbole ostrzegawcze reprezentują graficznie źródło potencjalnego ryzyka.

W poniższym dokumencie użyto następujących symboli:

Symbole ostrzegawcze	Znaczenie
	Ogólne ostrzeżenie
	Niebezpieczeństwo od napięcia elektrycznego
	Ryzyko wybuchu

## **i** Informacje dotyczące dokumentu







Symbole ostrzegawcze	Znaczenie
	Ryzyko obrażeń (rozcięć)
	Ryzyko zmiżdżenia
	Ryzyko oparzenia
	Silne pole magnetyczne
	Promieniowanie nie-jonizujące

Tabela 2: Symbole ostrzegawcze

### 1.2.3 Budowa ostrzeżeń

Ostrzeżenia podane w dokumencie mają standardową budowę.

	<p><b>⚠ NIEBEZPIECZEŃSTWO</b></p> <p><b>Typ i źródło ryzyka!!</b>          Konsekwencje zignorowania.          ▶ Środki ochronne.</p>
---	---

Kolejne ostrzeżenie wskazuje, jako źródło możliwość porażenia prądem. Wskazano czynności, które mają za zadanie ograniczenie ryzyka.

	<p><b>⚠ NIEBEZPIECZEŃSTWO</b></p> <p><b>Ryzyko porażenia prądem, ze względu na elementy będące pod napięciem!</b>          Zagrożenie życia poprzez porażenie prądem          ▶ Odłączyć urządzenie od zasilania sieciowego na 60 sekund przed rozpoczęciem naprawy.</p>
--	--

### 1.2.4 Ogólne symbole

Poniższe symbole są używane w dokumentacji:







Symbol	Znaczenie
	Identyfikacja specjalnej wskazówki (tekst lub grafika)
	Identyfikacja prostej wskazówki (tylko tekst)
	Identyfikacja linku do pliku wideo
	Identyfikacja narzędzi
	Identyfikacja wstępnych warunków
	Identyfikacja warunku (jeżeli)
	Identyfikacja rezultatu
[Start]	Identyfikacja przycisku
[00123456]	Identyfikacja numeru materiału
Status	Identyfikacja wyświetlanego tekstu / komunikatu (na wyświetlaczu)

Tabela 3: Ogólne symbole

## **2.1 Ogólne informacje dotyczące bezpieczeństwa**

### **2.1.1 Wszystkie sprzęty gospodarstwa domowego**

#### **Ryzyko porażenia prądem elektrycznym wskutek kontaktu z elementami znajdującymi się pod napięciem!**

- Błędna naprawa części elektrycznych może spowodować porażenie prądem elektrycznym!
- Co najmniej 60 sekund przed przystąpieniem do pracy odłączyć urządzenie od sieci elektrycznej.
- Po naprawie należy przeprowadzić test bezpieczeństwa zgodny z przepisami normy VDE 0701 (Niemcy) lub odpowiednimi przepisami obowiązującymi w kraju użytkowania.

#### **Ryzyko zranienia o ostre krawędzie!**

- Używać rękawic ochronnych.

#### **Ryzyko zmiążdżenia podczas naprawy, obsługi lub diagnozy, ze względu na ciężkie i ruchome elementy**

- Stosować obuwie ochronne.
- Zabezpieczyć ciężkie elementy przed upadkiem.
- Nie dotykać ruchomych elementów podczas pracy urządzenia.

#### **Zagrożenie dla bezpieczeństwa użytkownika i działania urządzenia!**

- Używać tylko oryginalnych części zamiennych.

#### **Ryzyko uszkodzenia komponentów wrażliwych na wyładowania elektrostatyczne (ESD)!**

- Nie dotykać modułów, włącznie ze złączami i ścieżkami przewodzącymi.

## Narzędzia i pomoce techniczne

Przeznaczenie	Detale	Zdjęcia
Tkanina ochronna [00342013]	60 cm x 50 cm	
Zestaw śrubokrętów precyzyjnych [00341820]	9 elementów, 2.0 mm, 2.4 mm, 3.0 mm, PH0, PH00, PH1, TX6, TX8, TX9	
Narzędzie pomocnicze [00342180]	Do demontaż plastikowych części, "magic tool"	
Przyssawka [00342224]	Ø 50 mm	
Torx Bit TX20 [00340865]	6,3 mm (1/4")	
Śrubokręt z końcówką płaską	Końcówka 10 mm x 1,6 mm x 200 mm	



## 4.1 Wymiana uszczelki drzwiczek

### Warunek:



- Drzwiczki są otwarte.

## 4.2 Wymiana uchwyty drzwiczek

### Sugerowane narzędzia

-  Torx Bit TX20 6,3 mm (1/4") [00340865]
-  Śrubokręt z końcówką płaską Końcówka 10 mm x 1,6 mm x 200 mm

### Warunek:

-  Urządzenie jest odłączone od źródła zasilania energią elektryczną.
-  Drzwiczki są otwarte.

### 4.2.1 Demontaż uchwyty drzwiczek

- ▶ 1. Wykręcić dwie zaślepki gwintowane (1).
- ▶ 2. Wykręcić dwie śruby (2).
- ▶ 3. Zdjąć uchwyt drzwiczek (3).

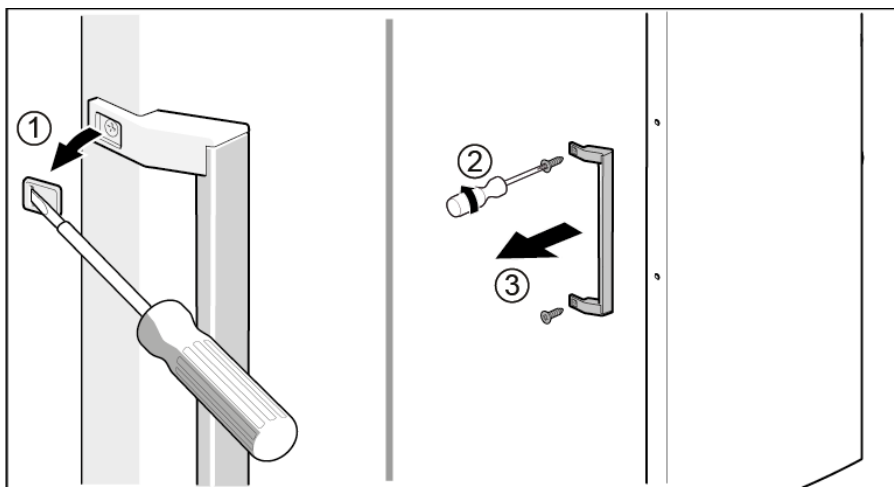

 Uchwyt drzwiczek został zdemontowany.



Uchwyt drugich drzwiczek można zdemontować w taki sam sposób.

### 4.2.2 Montaż uchwyty drzwiczek

- ▶ Montaż w odwrotnej kolejności.

## 4.3 Wymiana górnego zawiasu drzwiczek

### Sugerowane narzędzia

Torx Bit TX20

6,3 mm (1/4")

[00340865]

	<p><b>⚠ OSTRZEŻENIE</b></p> <p><b>Ciężkie, nieporęczne urządzenia!</b> Kontuzje mięśni i pleców</p> <ul style="list-style-type: none"> <li>▶ Czynność demontażu drzwiczek urządzenia powinna być wykonywana tylko przez wyszkolonych techników.</li> <li>▶ Przemieszczenie urządzenia wymaga udziału dwóch osób.</li> <li>▶ Używać tylko odpowiednich narzędzi i sprzętu.</li> </ul>
	<p><b>⚠ WAŻNE</b></p> <p><b>Ostre krawędzie!</b> Rany cięte</p> <ul style="list-style-type: none"> <li>▶ Zawsze używaj rękawic ochronnych.</li> </ul>
	<p><b>⚠ OSTRZEŻENIE</b></p> <p><b>Możliwość wyslizgnięcia się przechylnego urządzenia!</b> Złamania kości / zmiżdżenia</p> <ul style="list-style-type: none"> <li>▶ Zabezpieczyć urządzenia przed wyslizgnięciem.</li> </ul>
	<p><b>⚠ WAŻNE</b></p> <p><b>Niebezpieczeństwo spadnięcia części po wykręceniu śrub!</b> Zranienie przez spadające części.</p> <ul style="list-style-type: none"> <li>▶ Zabezpieczyć część przed spadnięciem.</li> </ul>
	<p><b>UWAGA!</b></p> <p><b>Niebezpieczeństwo spadnięcia części po wykręceniu śrub!</b> Uszkodzenie innych części urządzenia albo pomieszczenia mieszkalnego, np. podłogi.</p> <ul style="list-style-type: none"> <li>▶ Zabezpieczyć część przed spadnięciem.</li> </ul>

### Warunek:

- ✓ Urządzenie jest odłączone od źródła zasilania energią elektryczną.
- ✓ Zostały zdemontowane wewnętrzne elementy mocujące urządzenia.

## 4.3.1 Demontaż górnego zawiasu drzwiczek

1. Położyć urządzenie "na plecach".

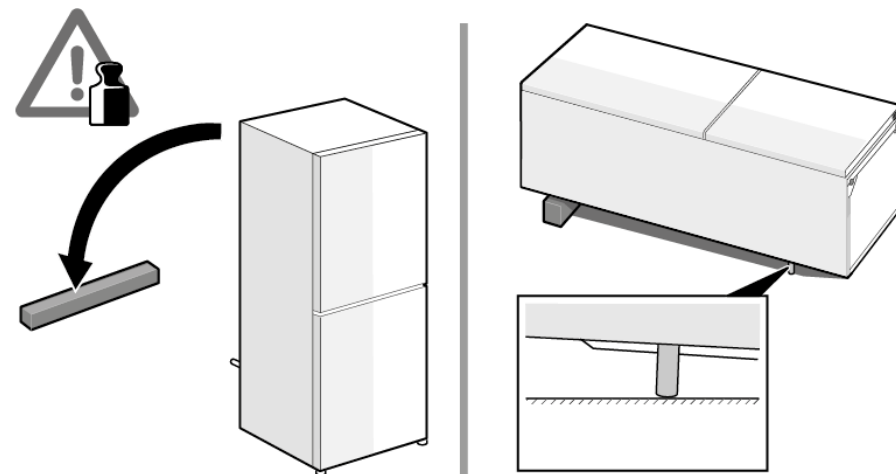

## Naprawy

1. Nacisnąć osłony zawiasów górnych po obu stronach (1).
2. Przesunąć osłonę zawiasu górnego (2).
3. Obrócić osłonę zawiasu (3).
4. Zdjąć osłonę zawiasu górnego (4).
5. Wykręcić dwie śruby (5).
6. Wyjąć zawias górny (6).

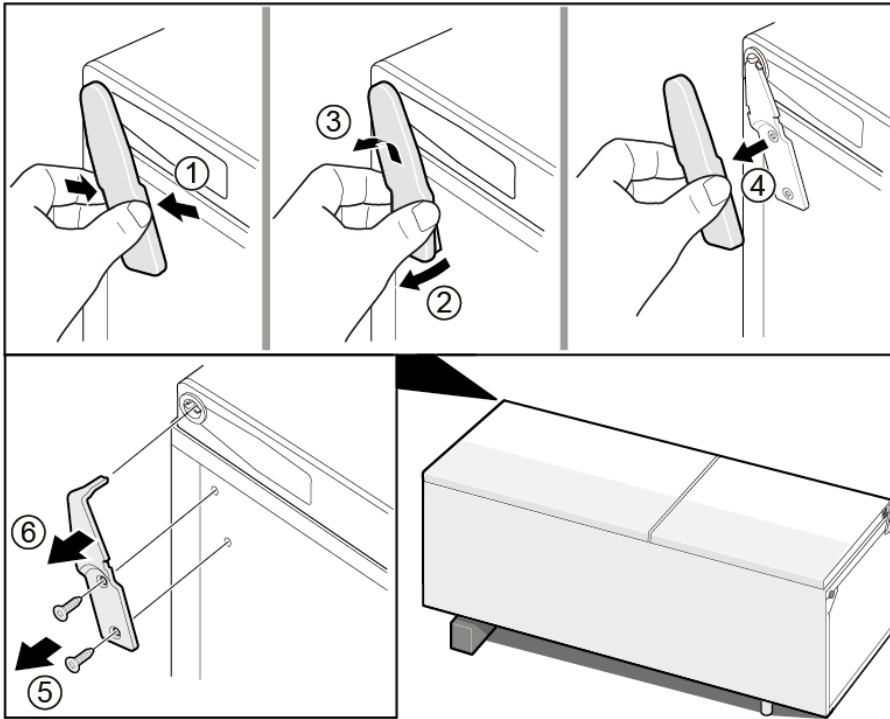

 Górny zawias jest zdemontowany.

### 4.3.2 Montaż górnego zawiasu drzwiczek

- ▶ Montaż w odwrotnej kolejności.

## 4.4 Wymiana górnego zawiasu drzwiczek (drzwiczki z wyświetlaczem)

### Sugerowane narzędzia

Torx Bit TX20 6,3 mm (1/4") [00340865]

	<b>⚠ OSTRZEŻENIE</b>
	<p><b>Ciężkie, nieporęczne urządzenia!</b> Kontuzje mięśni i pleców</p> <ul style="list-style-type: none"> <li>▶ Czynność demontażu drzwiczek urządzenia powinna być wykonywana tylko przez wyszkolonych techników.</li> <li>▶ Przemieszczenie urządzenia wymaga udziału dwóch osób.</li> <li>▶ Używać tylko odpowiednich narzędzi i sprzętu.</li> </ul>

	<b>⚠ WAŻNE</b>
	<p><b>Ostre krawędzie!</b> Rany cięte</p> <ul style="list-style-type: none"> <li>▶ Zawsze używaj rękawic ochronnych.</li> </ul>

	<b>⚠ OSTRZEŻENIE</b>
	<p><b>Możliwość wyslizgnięcia się przechylonego urządzenia!</b> Złamania kości / zmiążdżenia</p> <ul style="list-style-type: none"> <li>▶ Zabezpieczyć urządzenia przed wyslizgnięciem.</li> </ul>

	<b>⚠ WAŻNE</b>
	<p><b>Niebezpieczeństwo spadnięcia części po wykręceniu śrub!</b> Zranienie przez spadające części.</p> <ul style="list-style-type: none"> <li>▶ Zabezpieczyć część przed spadnięciem.</li> </ul>

	<b>UWAGA!</b>
	<p><b>Niebezpieczeństwo spadnięcia części po wykręceniu śrub!</b> Uszkodzenie innych części urządzenia albo pomieszczenia mieszkalnego, np. podłogi.</p> <ul style="list-style-type: none"> <li>▶ Zabezpieczyć część przed spadnięciem.</li> </ul>

	<b>⚠ NIEBEZPIECZEŃSTWO</b>
	<p><b>Ryzyko porażenia prądem elektrycznym wskutek kontaktu z elementami znajdującymi się pod napięciem!</b> Niebezpieczeństwo utraty życia wskutek porażenia prądem elektrycznym w przypadku nieprawidłowej naprawy</p> <ul style="list-style-type: none"> <li>▶ Części elektryczne powinny być naprawiane przez wykwalifikowanych elektryków.</li> <li>▶ Po naprawie należy przeprowadzić test bezpieczeństwa zgodny z przepisami normy VDE 0701 (Niemcy) lub odpowiednimi przepisami obowiązującymi w kraju użytkowania.</li> </ul>

	<b>⚠ NIEBEZPIECZEŃSTWO</b>
	<p><b>Ryzyko porażenia prądem, ze względu na elementy będące pod napięciem!</b> Zagrożenie życia poprzez porażenie prądem</p> <ul style="list-style-type: none"> <li>▶ Odłączyć urządzenie od zasilania sieciowego na 60 sekund przed rozpoczęciem naprawy.</li> </ul>

### Warunek:

- ✔ Urządzenie jest odłączone od źródła zasilania energią elektryczną.
- ✔ Zostały zdemontowane wewnętrzne elementy mocujące urządzenia.

### 4.4.1 Demontaż górnego zawiasu drzwiczek

1. Położyć urządzenie "na plecach".

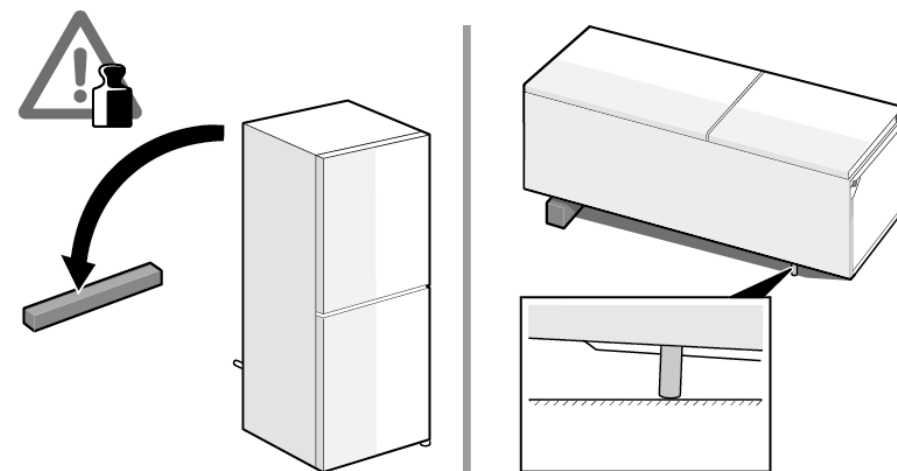

## Naprawy

2. 1. Zdjąć osłonę zawiasu górnego (1).
2. Zdjąć pokrywę puszki kablowej (2).
3. Odłączyć złącze elektryczne (3).
4. Odkręcić śrubę złącza uziemienia (4).
5. Wyjąć osłonę kabli (5).
6. Odkręcić śrubę (6)

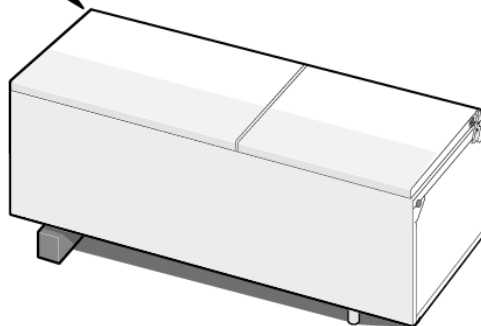
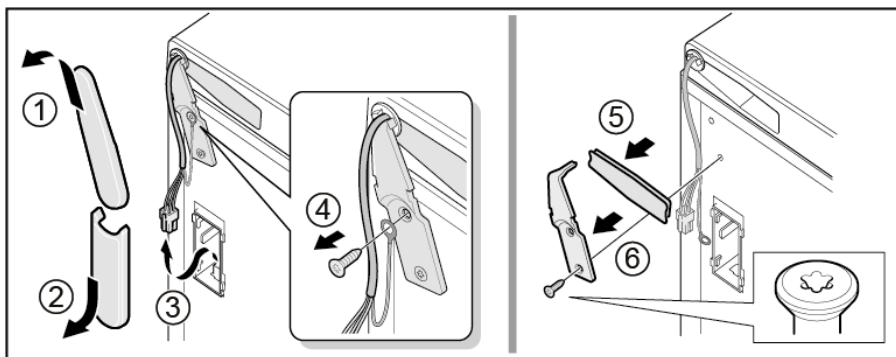

 Górny zawias jest zdemontowany.

### 4.4.2 Montaż górnego zawiasu drzwiczek

- ▶ Montaż w odwrotnej kolejności.

## 4.5 Wymiana środkowego zawiasu drzwiczek

### Sugerowane narzędzia

Torx Bit TX20                      6,3 mm (1/4")                      [00340865]

	<b>⚠ OSTRZEŻENIE</b>
	<p><b>Ciężkie, nieporęczne urządzenia!</b> Kontuzje mięśni i pleców</p> <ul style="list-style-type: none"> <li>▶ Czynność demontażu drzwiczek urządzenia powinna być wykonywana tylko przez wyszkolonych techników.</li> <li>▶ Przemieszczenie urządzenia wymaga udziału dwóch osób.</li> <li>▶ Używać tylko odpowiednich narzędzi i sprzętu.</li> </ul>

	<b>⚠ WAŻNE</b>
	<p><b>Ostre krawędzie!</b> Rany cięte</p> <ul style="list-style-type: none"> <li>▶ Zawsze używaj rękawic ochronnych.</li> </ul>

	<b>⚠ OSTRZEŻENIE</b>
	<p><b>Możliwość wyslizgnięcia się przechylonego urządzenia!</b> Złamania kości / zmiążdżenia</p> <ul style="list-style-type: none"> <li>▶ Zabezpieczyć urządzenia przed wyslizgnięciem.</li> </ul>

	<b>⚠ WAŻNE</b>
	<p><b>Niebezpieczeństwo spadnięcia części po wykręceniu śrub!</b> Zranienie przez spadające części.</p> <ul style="list-style-type: none"> <li>▶ Zabezpieczyć część przed spadnięciem.</li> </ul>

	<b>UWAGA!</b>
	<p><b>Niebezpieczeństwo spadnięcia części po wykręceniu śrub!</b> Uszkodzenie innych części urządzenia albo pomieszczenia mieszkalnego, np. podłogi.</p> <ul style="list-style-type: none"> <li>▶ Zabezpieczyć część przed spadnięciem.</li> </ul>

### Warunek:

- ✔ Urządzenie jest odłączone od źródła zasilania energią elektryczną.
- ✔ Zostały zdemontowane wewnętrzne elementy mocujące urządzenia.
- ✔ Górny zawias drzwiczek jest zdemontowany.

✔ Górne drzwiczki są zdemontowane.

### 4.5.1 Demontaż środkowego zawiasu drzwiczek

- ▶ 1. Zdemontować drzwiczki komory chłodziarki (1).
- ▶ 2. Wykręcić dwie śruby (2).
- ▶ 3. Wyjąć środkowy zawias (3).

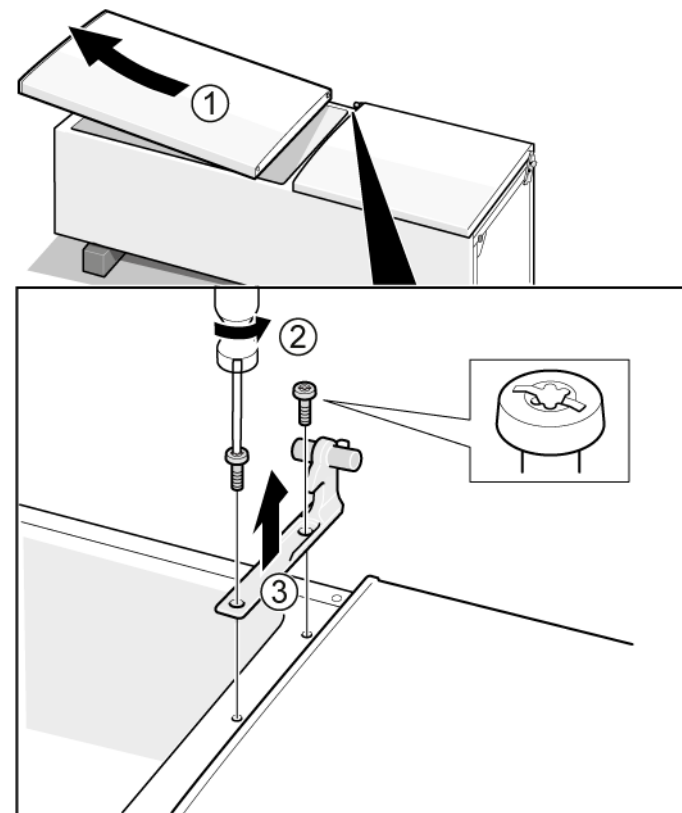

➡ Środkowy zawias jest zdemontowany.

### 4.5.2 Montaż środkowego zawiasu drzwiczek

- ▶ Montaż w odwrotnej kolejności.

## 4.6 Wymiana dolnego zawiasu drzwiczek

### Sugerowane narzędzia

Torx Bit TX20

6,3 mm (1/4")

[00340865]

	<p><b>OSTRZEŻENIE</b></p> <p><b>Ciężkie, nieporęczne urządzenia!</b> Kontuzje mięśni i pleców</p> <ul style="list-style-type: none"> <li>▶ Czynność demontażu drzwiczek urządzenia powinna być wykonywana tylko przez wyszkolonych techników.</li> <li>▶ Przemieszczenie urządzenia wymaga udziału dwóch osób.</li> <li>▶ Używać tylko odpowiednich narzędzi i sprzętu.</li> </ul>
	<p><b>WAŻNE</b></p> <p><b>Ostre krawędzie!</b> Rany cięte</p> <ul style="list-style-type: none"> <li>▶ Zawsze używaj rękawic ochronnych.</li> </ul>
	<p><b>OSTRZEŻENIE</b></p> <p><b>Możliwość wyslizgnięcia się przechylonego urządzenia!</b> Złamania kości / zmiążdżenia</p> <ul style="list-style-type: none"> <li>▶ Zabezpieczyć urządzenia przed wyslizgnięciem.</li> </ul>
	<p><b>WAŻNE</b></p> <p><b>Niebezpieczeństwo spadnięcia części po wykręceniu śrub!</b> Zranienie przez spadające części.</p> <ul style="list-style-type: none"> <li>▶ Zabezpieczyć część przed spadnięciem.</li> </ul>
	<p><b>UWAGA!</b></p> <p><b>Niebezpieczeństwo spadnięcia części po wykręceniu śrub!</b> Uszkodzenie innych części urządzenia albo pomieszczenia mieszkalnego, np. podłogi.</p> <ul style="list-style-type: none"> <li>▶ Zabezpieczyć część przed spadnięciem.</li> </ul>

### Warunek:

- ✔ Urządzenie jest odłączone od źródła zasilania energią elektryczną.
- ✔ Zostały zdemontowane wewnętrzne elementy mocujące urządzenia.
- ✔ Górny zawias jest zdemontowany.

- ✔ Środkowy zawias jest zdemontowany.

### 4.6.1 Demontaż dolnego zawiasu drzwiczek

- ▶ 1. Zdemontować drzwiczki komory zamrażarki (1).
- ▶ 2. Odkręcić śrubę (2).
- ▶ 3. Obrócić zawias dolny do zewnątrz (3).
- ▶ 4. Wyjąć zawias dolny (4).

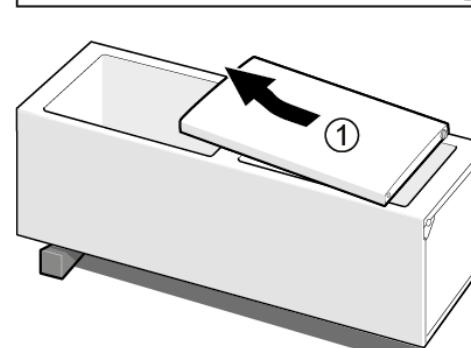
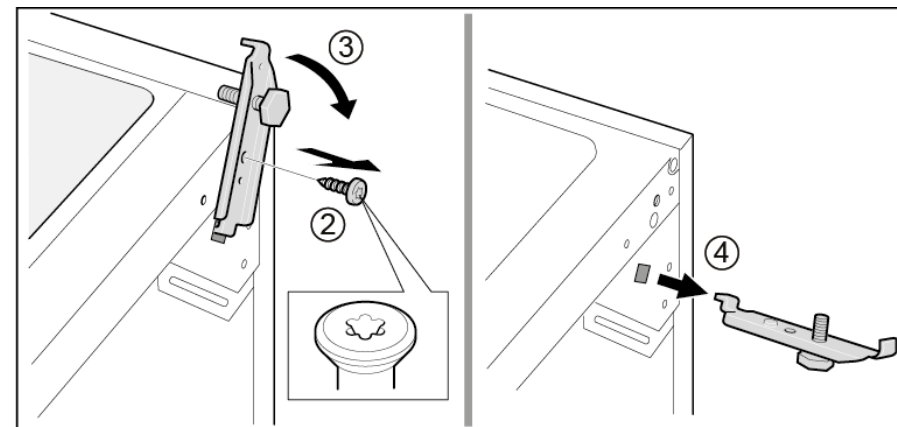

- ➡ Dolny zawias drzwiczek jest zdemontowany.

### 4.6.2 Montaż dolnego zawiasu drzwiczek

- ▶ Montaż w odwrotnej kolejności.

## 4.7 Wymiana półki

### Warunek:

- ✔ Drzwiczki są otwarte.

### 4.7.1 Demontaż półki

- ▶ Wyciągnąć półkę.

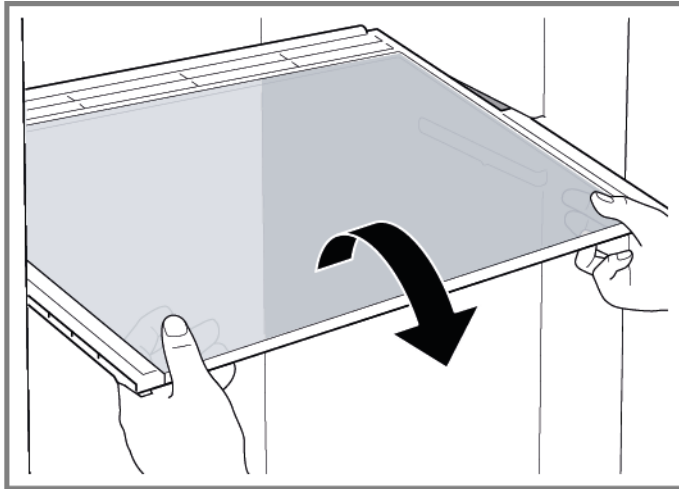

- ➡ Półka jest wyjęta.

### 4.7.2 Montaż półki

- ▶ Montaż w odwrotnej kolejności.

## 4.8 Wymiana regulowanej półki

### Warunek:

- ✔ Drzwiczki są otwarte.

### 4.8.1 Demontaż regulowanej półki

1. Wyciągnąć prawą część regulowanej półki do przodu (1).
2. Wyjąć prawą część regulowanej półki(2).

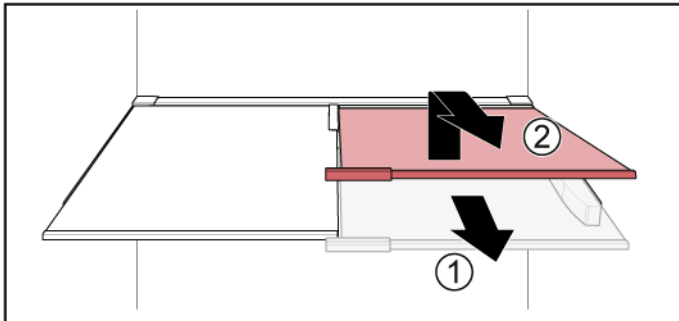

2. Wyjąć w ten sam sposób lewą część regulowanej półki.

- ➡ Regulowana półka jest wyjęta.

### 4.8.2 Montaż regulowanej półki

- ▶ Montaż w odwrotnej kolejności.

## 4.9 Wymiana elastycznej półki

### Warunek:

- ✔ Drzwiczki są otwarte.

### 4.9.1 Demontaż elastycznej półki

- ▶ 1. Wyjąć półkę szklaną (1).
- ▶ 2. Podnieść elastyczną półkę i wyciągnąć ją (2).

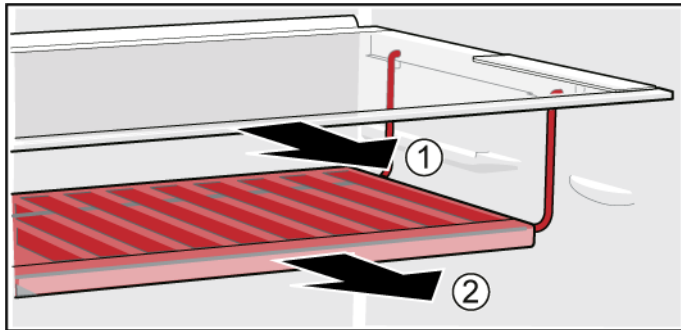

- ➡ Elastyczna półka jest wyjęta.

### 4.9.2 Montaż elastycznej półki

- ▶ Montaż w odwrotnej kolejności.

## 4.10 Wymiana kompletu śniadaniowego

### Warunek:

- ✔ Drzwiczki są otwarte.

### 4.10.1 Demontaż kompletu śniadaniowego

- ▶ Podnieść i wyciągnąć komplet śniadaniowy.

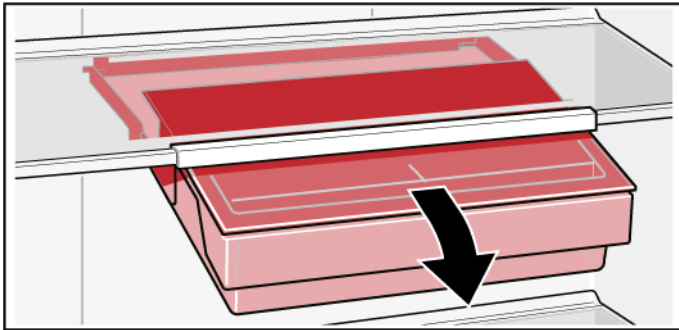

- ➡ Komplet śniadaniowy jest wymontowany.

### 4.10.2 Montaż kompletu śniadaniowego

- ▶ Montaż w odwrotnej kolejności.

## 4.11 Wymiana podstawki na butelki

### Warunek:

- ✔ Drzwiczki są otwarte.

### 4.11.1 Demontaż podstawki na butelki

- ▶ Wyciągnąć podstawkę na butelki.

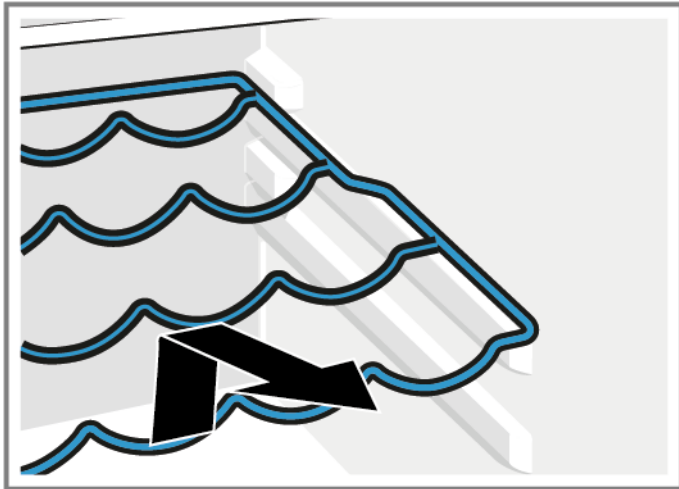

- ➡ Podstawka na butelki jest wyjęta.

### 4.11.2 Montaż podstawki na butelki

- ▶ Montaż w odwrotnej kolejności.

## 4.12 Wymiana półki drzwiczek

### Warunek:

- ✔ Drzwiczki są otwarte.

### 4.12.1 Demontaż półki drzwiczek

- ▶ Podnieść półkę drzwiczek do góry.

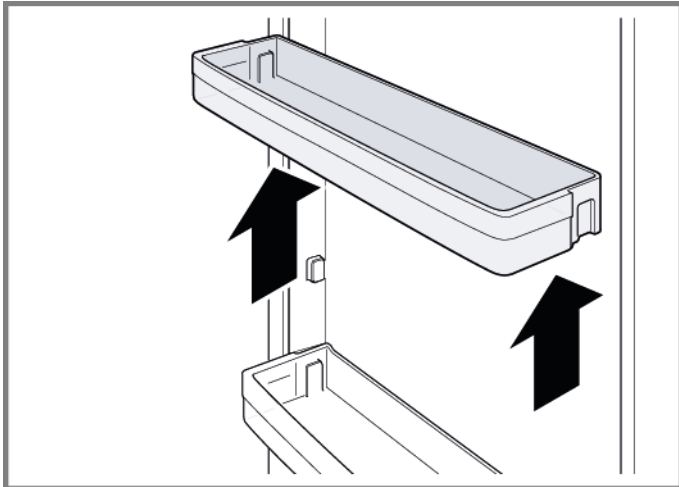

- ➡ Półka drzwiczek została zdemontowana.

### 4.12.2 Montaż półki drzwiczek

- ▶ Montaż w odwrotnej kolejności.

## 4.13 Wymiana pojemnika na mrożoną żywność

### Warunek:

- ✔ Drzwiczki są otwarte.

### 4.13.1 Demontaż pojemnika na mrożoną żywność

- ▶ 1. Wyciągnąć pojemnik na mrożoną żywność do końca (1).
- ▶ 2. Wyjąć pojemnik na żywność (2).

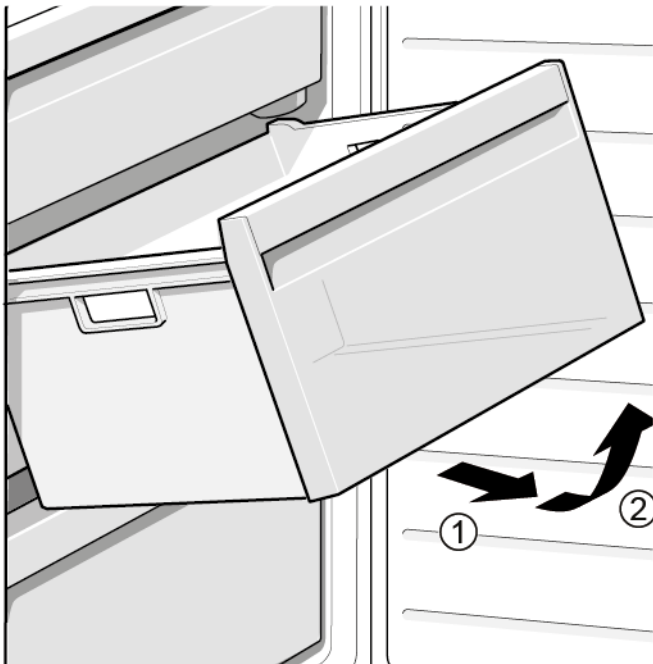

- ➡ Pojemnik na mrożoną żywność został wyjęty.

### 4.13.2 Montaż pojemnika na mrożoną żywność

- ▶ Montaż w odwrotnej kolejności.

## 4.14 Wymiana pojemnika

### Warunek:

- ✔ Drzwiczki są otwarte.

### 4.14.1 Demontaż pojemnika

- ▶ 1. Wyjąć dolny pojemnik chłodziarki (1).
- ▶ 2. Wyjąć górny pojemnik chłodziarki (2).

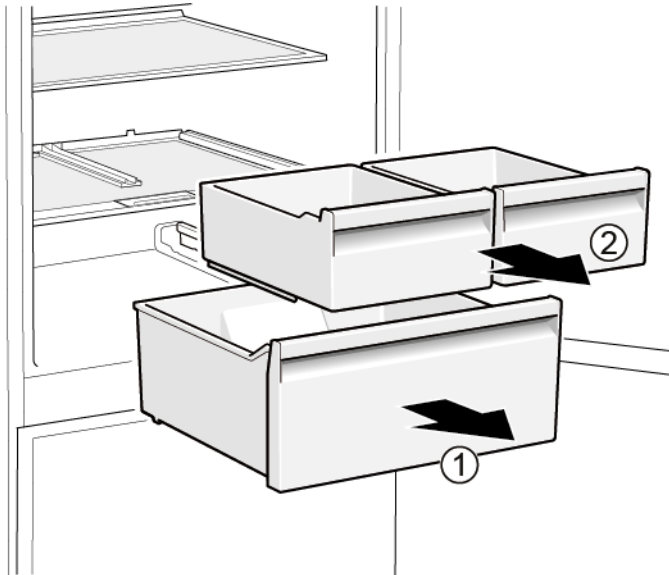

- ➡ Pojemniki zostały wyjęte.

### 4.14.2 Montaż pojemnika

- ▶ Montaż w odwrotnej kolejności.

## 4.15 Wymiana pojemnika wysuwanego

### Warunek:

- ✔ Drzwiczki są otwarte.

### 4.15.1 Demontaż pojemnika wysuwanego

- ▶ 1. Wyciągnąć pojemnik wysuwany do końca (1).
- ▶ 2. Wyjąć pojemnik wysuwany (2).

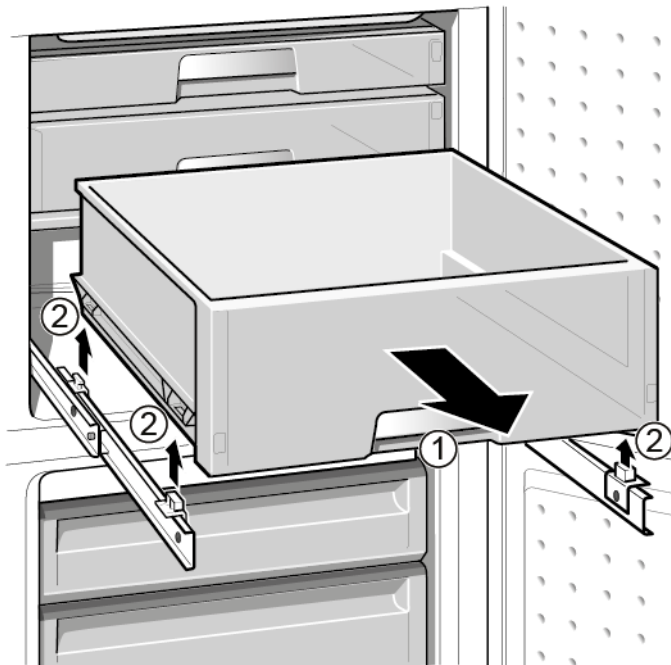

- ➡ Pojemnik wysuwany został wyjęty.

### 4.15.2 Montaż pojemnika wysuwanego

- ▶ Montaż w odwrotnej kolejności.

## 4.16 Wymiana oświetlenia punktowego LED

### Sugerowane narzędzia

 Narzędzie specjalne [00342180]

 Urządzenie posiada bezobsługowe oświetlenie LED. Tego rodzaju elementy oświetleniowe mogą być naprawiane wyłącznie przez serwis lub autoryzowanych techników!

 **NIEBEZPIECZEŃSTWO**  
**Ryzyko porażenia prądem elektrycznym wskutek kontaktu z elementami znajdującymi się pod napięciem!**  
 Niebezpieczeństwo utraty życia wskutek porażenia prądem elektrycznym w przypadku nieprawidłowej naprawy

- ▶ Części elektryczne powinny być naprawiane przez wykwalifikowanych elektryków.
- ▶ Po naprawie należy przeprowadzić test bezpieczeństwa zgodny z przepisami normy VDE 0701 (Niemcy) lub odpowiednimi przepisami obowiązującymi w kraju użytkowania.

 **NIEBEZPIECZEŃSTWO**  
**Ryzyko porażenia prądem, ze względu na elementy będące pod napięciem!**  
 Zagrożenie życia poprzez porażenie prądem

- ▶ Odłączyć urządzenie od zasilania sieciowego na 60 sekund przed rozpoczęciem naprawy.

 **WAŻNE**  
**Ostre krawędzie!**  
 Rany cięte

- ▶ Zawsze używaj rękawic ochronnych.

### Warunek:

- ✔ Urządzenie jest odłączone od źródła zasilania energią elektryczną.
- ✔ Drzwiczki są otwarte.

### 4.16.1 Demontaż oświetlenia punktowego LED

1. Przy użyciu specjalnego narzędzia wyjąć oświetlenie punktowe LED (1).

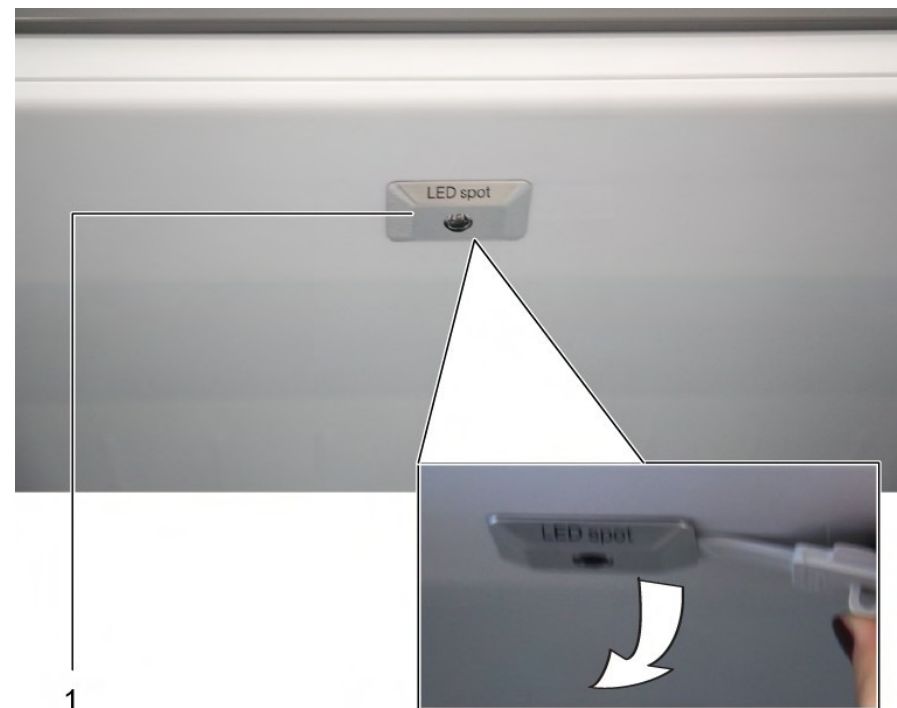

2. Odłączyć złącza elektryczne oświetlenia punktowego LED.
-  Oświetlenie punktowe LED zostało wymontowane.

### 4.16.2 Montaż oświetlenia punktowego LED

- ▶ Montaż w odwrotnej kolejności.

## 4.17 Wymiana górnego oświetlenia LED

### Sugerowane narzędzia

- Śrubokręt z końcówką płaską Końcówka 2,4 mm x 0,4 mm x 60 mm, w zestawie [00341820]

	Urządzenie posiada bezobsługowe oświetlenie LED. Tego rodzaju elementy oświetleniowe mogą być naprawiane wyłącznie przez serwis lub autoryzowanych techników!
---	---

	<p><b>⚠ NIEBEZPIECZEŃSTWO</b></p> <p><b>Ryzyko porażenia prądem elektrycznym wskutek kontaktu z elementami znajdującymi się pod napięciem!</b>          Niebezpieczeństwo utraty życia wskutek porażenia prądem elektrycznym w przypadku nieprawidłowej naprawy</p> <ul style="list-style-type: none"> <li>▶ Części elektryczne powinny być naprawiane przez wykwalifikowanych elektryków.</li> <li>▶ Po naprawie należy przeprowadzić test bezpieczeństwa zgodny z przepisami normy VDE 0701 (Niemcy) lub odpowiednimi przepisami obowiązującymi w kraju użytkownika.</li> </ul>
--	---

	<p><b>⚠ NIEBEZPIECZEŃSTWO</b></p> <p><b>Ryzyko porażenia prądem, ze względu na elementy będące pod napięciem!</b>          Zagrożenie życia poprzez porażenie prądem</p> <ul style="list-style-type: none"> <li>▶ Odłączyć urządzenie od zasilania sieciowego na 60 sekund przed rozpoczęciem naprawy.</li> </ul>
--	---

	<p><b>⚠ WAŻNE</b></p> <p><b>Ostre krawędzie!</b>          Rany cięte</p> <ul style="list-style-type: none"> <li>▶ Zawsze używaj rękawic ochronnych.</li> </ul>
--	--

### Warunek:

- ✔ Urządzenie jest odłączone od źródła zasilania energią elektryczną.
- ✔ Drzwiczki są otwarte.
- ✔ Zostały zdemontowane górne wewnętrzne elementy mocujące.

### 4.17.1 Demontaż oświetlenia LED

- Przesunąć oświetlenie LED w lewo.

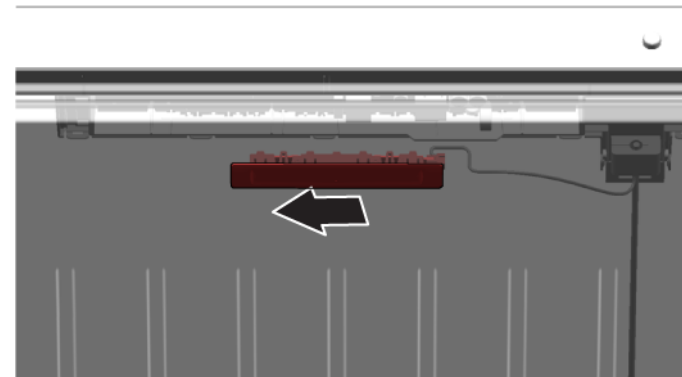

- ➡ Złącze elektryczne oświetlenia LED jest rozłączone.

- Zwolnić zaczepy oświetlenia LED.

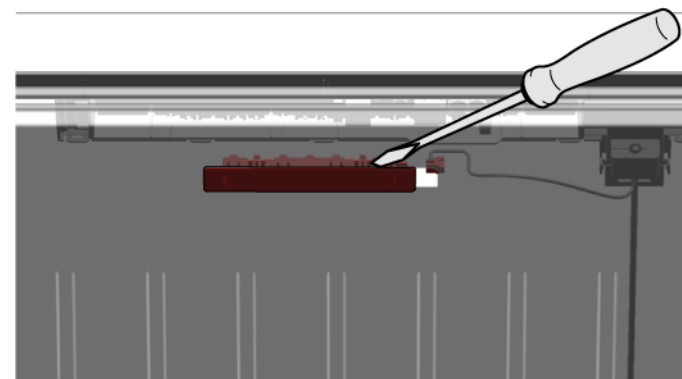

3. Wyjąć oświetlenie LED przez przesunięcie go do przodu.

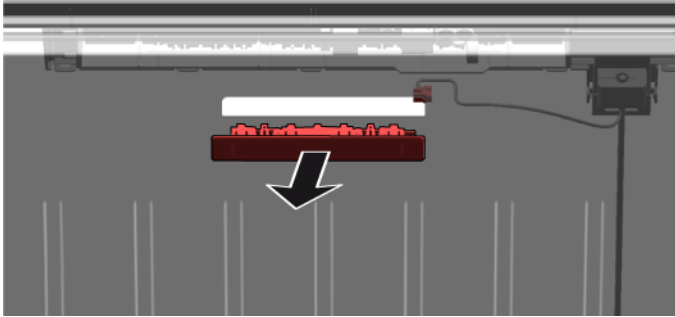

- ➡ Oświetlenie LED zostało wymontowane.

### 4.17.2 Montaż górnego oświetlenia LED

- ▶ Montaż w odwrotnej kolejności.

## 4.18 Wymiana bocznego paska oświetleniowego LED

### Sugerowane narzędzia

Przysawka Ø50 mm [00342224]

**i** Urządzenie posiada bezobsługowe oświetlenie LED. Tego rodzaju elementy oświetleniowe mogą być naprawiane wyłącznie przez serwis lub autoryzowanych techników!

**⚠ NIEBEZPIECZEŃSTWO**  
**Ryzyko porażenia prądem elektrycznym wskutek kontaktu z elementami znajdującymi się pod napięciem!**  
 Niebezpieczeństwo utraty życia wskutek porażenia prądem elektrycznym w przypadku nieprawidłowej naprawy

- ▶ Części elektryczne powinny być naprawiane przez wykwalifikowanych elektryków.
- ▶ Po naprawie należy przeprowadzić test bezpieczeństwa zgodny z przepisami normy VDE 0701 (Niemcy) lub odpowiednimi przepisami obowiązującymi w kraju użytkowania.

**⚠ NIEBEZPIECZEŃSTWO**  
**Ryzyko porażenia prądem, ze względu na elementy będące pod napięciem!**  
 Zagrożenie życia poprzez porażenie prądem

- ▶ Odłączyć urządzenie od zasilania sieciowego na 60 sekund przed rozpoczęciem naprawy.

**⚠ WAŻNE**  
**Ostre krawędzie!**  
 Rany cięte

- ▶ Zawsze używaj rękawic ochronnych.

### Warunek:

- ✔ Urządzenie jest odłączone od źródła zasilania energią elektryczną.
- ✔ Drzwiczki są otwarte.
- ✔ Z komory chłodziarki zostały wyjęte półki.

### 4.18.1 Demontaż bocznego paska oświetleniowego LED

1. Przyczołować przysawkę do bocznego paska oświetleniowego LED w obszarze górnej jednej trzeciej jego powierzchni.



2. Pociągnąć przysawkę z bocznym paskiem oświetleniowym LED do przodu jednym obrotowym ruchem.

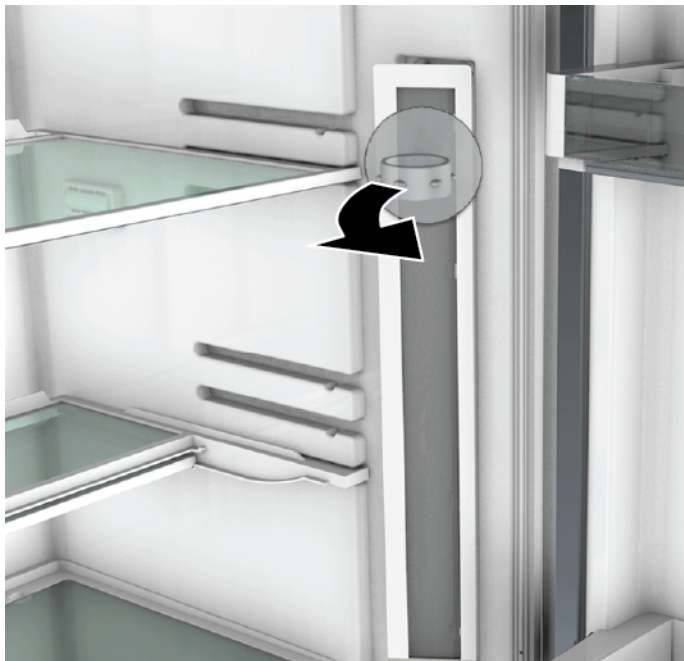

3. Rozłączyć złącze elektryczne bocznego paska oświetleniowego LED.  
➡ Boczny pasek oświetleniowy LED został wymontowany.

### 4.18.2 Montaż bocznego paska oświetleniowego LED

1. Połączyć złącze elektryczne bocznego paska oświetleniowego LED.
  2. Zamocować boczny pasek oświetleniowy LED w przewidzianym dla niego miejscu na ścianie komory (słychać kliknięcia zaczepów).
- ➡ Boczny pasek oświetleniowy LED został zamontowany.

# Dicas de resolução - Combinação de frigorífico e congelador

<b>i</b>	<b>Sobre este documento</b> .....	<b>462</b>		
1.1	Informação importante .....	462		
1.1.1	Finalidade.....	462		
1.2	Explicação dos símbolos.....	462		
1.2.1	Níveis de perigo.....	462		
1.2.2	Símbolos de perigo .....	462		
1.2.3	Estrutura dos avisos.....	463		
1.2.4	Símbolos gerais .....	463		
<b>⚠</b>	<b>Segurança</b> .....	<b>464</b>		
2.1	Instruções gerais de segurança.....	464		
2.1.1	Todos os eletrodomésticos .....	464		
<b>🔧</b>	<b>Ferramentas e auxiliares</b> .....	<b>465</b>		
<b>🔧</b>	<b>Reparação</b> .....	<b>466</b>		
4.1	Substituir a junta da porta .....	466		
4.2	Substituir o puxador da porta .....	467		
4.2.1	Remover o puxador da porta .....	467		
4.2.2	Instalar o puxador da porta .....	467		
4.3	Substituir a dobradiça superior da porta .....	468		
4.3.1	Remover a dobradiça superior da porta.....	468		
4.3.2	Instalar a dobradiça superior da porta .....	469		
4.4	Substituir a dobradiça superior da porta (porta com visor).....	470		
4.4.1	Remover a dobradiça superior da porta.....	470		
4.4.2	Instalar a dobradiça superior da porta .....	471		
4.5	Substituir a dobradiça central da porta .....	472		
4.5.1	Remover a dobradiça central da porta.....	472		
4.5.2	Instalar a dobradiça central da porta .....	472		
4.6	Substituir a dobradiça inferior da porta.....	473		
4.6.1	Remover a dobradiça inferior da porta.....	473		
4.6.2	Instalar a dobradiça inferior da porta .....	473		
4.7	Substituir a prateleira.....	474		
4.7.1	Remover a prateleira.....	474		
4.7.2	Instalar a prateleira .....	474		
4.8	Substituir a prateleira variável .....	475		
4.8.1	Remover a prateleira variável.....	475		
4.8.2	Instalar a prateleira variável .....	475		
4.9	Substituir a prateleira flexível .....	476		
4.9.1	Remover a prateleira flexível.....	476		
4.9.2	Instalar a prateleira flexível .....	476		
4.10	Substituir o conjunto de pequeno-almoço .....	477		
4.10.1	Remover o conjunto de pequeno-almoço .....	477		
4.10.2	Instalar o conjunto de pequeno-almoço.....	477		
4.11	Substituir o suporte para garrafas .....	478		
4.11.1	Remover o suporte para garrafas .....	478		
4.11.2	Instalar o suporte para garrafas.....	478		
4.12	Substituir a prateleira da porta .....	479		
4.12.1	Remover a prateleira da porta .....	479		
4.12.2	Instalar a prateleira da porta.....	479		
4.13	Substituir o recipiente para alimentos congelados.....	480		
4.13.1	Remover o recipiente para alimentos congelados.....	480		
4.13.2	Instalar o recipiente para alimentos congelados .....	480		
4.14	Substituir o recipiente .....	481		
4.14.1	Remover o recipiente.....	481		
4.14.2	Instalar o recipiente .....	481		
4.15	Substituir o recipiente extensível.....	482		
4.15.1	Remover o recipiente extensível.....	482		
4.15.2	Instalar o recipiente extensível .....	482		
4.16	Substituir a iluminação LED específica.....	483		
4.16.1	Remover a iluminação LED específica.....	483		
4.16.2	Instalar a iluminação LED específica .....	483		
4.17	Substituir a iluminação LED superior.....	484		
4.17.1	Remover a iluminação LED.....	484		
4.17.2	Instalar a iluminação LED superior .....	485		
4.18	Substituir a iluminação LED de barra lateral .....	486		
4.18.1	Remover a iluminação LED de barra lateral .....	486		
4.18.2	Instalar a iluminação LED de barra lateral.....	487		

# **i** Sobre este documento

## 1.1 Informação importante

### 1.1.1 Finalidade

Estas dicas de reparação auxiliam o consumidor na reparação de aparelhos por ele próprio de acordo com o regulamento de "Eco-design" aplicável (a partir de 03/2021).

Estas contêm informações sobre como substituir peças sobressalentes definidas, incluindo avisos e riscos.

Em caso de dúvidas, entre em contacto com o nosso serviço de apoio ao cliente. Apenas nos responsabilizaremos por danos se as dicas de reparação tiverem sido devidamente seguidas.

## 1.2 Explicação dos símbolos

### 1.2.1 Níveis de perigo

Os níveis de aviso são compostos por um símbolo e uma palavra sinal. A palavra-sinal indica a gravidade do perigo.







Nível de aviso	Significado
	A não observância da mensagem de aviso resulta em morte ou ferimentos graves.
	A não observância da mensagem de aviso pode resultar em morte ou ferimentos graves.
	A não observância da mensagem de aviso pode resultar em ferimentos ligeiros.
	A não observância da mensagem de aviso pode resultar em danos materiais.

Tabela 1: Níveis de perigo

### 1.2.2 Símbolos de perigo

Os símbolos de perigo são representações simbólicas que dão uma indicação do tipo de perigo.

Neste documento são utilizados os seguintes símbolos de perigo:

Símbolo de perigo	Significado
	Mensagem geral de aviso
	Perigo de tensão elétrica
	Risco de explosão
	Perigo de cortes

## **i** Sobre este documento





Símbolo de perigo	Significado
	Perigo de esmagamento
	Perigo de superfícies quentes
	Perigo de campo eletromagnético intenso
	Perigo de radiação não-ionizante

Tabela 2: Símbolos de perigo

### 1.2.3 Estrutura dos avisos

Os avisos neste documento possuem um aspeto normalizado e uma estrutura normalizada.

	<div style="background-color: red; color: white; padding: 2px; text-align: center;"><b>⚠ PERIGO</b></div> <p><b>Tipo e origem do perigo!</b> Possíveis consequência de ignorar o perigo / aviso.</p> <ul style="list-style-type: none"> <li>▶ Medidas e proibições para prevenir o perigo.</li> </ul>
--	---

O seguinte exemplo mostra um aviso que adverte contra choques elétricos devido a partes sob tensão. A medida para evitar o perigo é mencionada.

	<div style="background-color: red; color: white; padding: 2px; text-align: center;"><b>⚠ PERIGO</b></div> <p><b>Risco de choque elétrico devido a peças sob tensão!</b> Morte por eletrocussão</p> <ul style="list-style-type: none"> <li>▶ Desligue os aparelhos da fonte de alimentação elétrica pelo menos 60 segundos antes de iniciar as reparações.</li> </ul>
--	--

### 1.2.4 Símbolos gerais

Neste documento são utilizados os seguintes símbolos gerais:







Símbolo ger.	Significado
	Identificação de uma dica especial (texto e/ou ilustração)
	Identificação de uma dica simples (apenas texto)
	Identificação de uma ligação para um tutorial em vídeo
	Identificação das ferramentas necessárias
	Identificação das condições prévias necessárias
	Identificação de uma condição (se ..., então ...)
	Identificação de um resultado
Iniciar	Identificação de uma tecla ou botão
[00123456]	Identificação de um número de material
Estado	Identificação de um texto exibido / janela (no visor do aparelho)

Tabela 3: Símbolos gerais

## 2.1 Instruções gerais de segurança

### 2.1.1 Todos os eletrodomésticos

#### **Risco de choque elétrico devido a partes sob tensão!**

- Erros por reparações envolvendo componentes elétricos podem provocar choques elétricos!
- Desligue o aparelho da rede elétrica pelo menos 60 segundos antes de iniciar o trabalho.
- Após a reparação, solicite a realização de um teste de segurança de acordo com VDE 0701 ou os regulamentos específicos do país.

#### **Risco de ferimentos causados por arestas vivas!**

- Use luvas de proteção.

#### **Risco de esmagamento durante trabalhos de reparação, manutenção, resolução de problemas e serviço devido a componentes pesados e móveis**

- Use calçado de proteção.
- Proteja os componentes pesados contra quedas.
- Não introduzir partes do corpo em componentes móveis.

#### **Risco para a segurança/funcionamento do aparelho!**

- Utilize apenas peças sobressalentes originais.

#### **Risco de danos em componentes electrostáticamente sensíveis (ESDs)!**

- Não toque nos módulos, incluindo ligações e percursos condutores.

## Ferramentas e auxiliares

Designação	Detalhes	Imagens
Pano protetor [00342013]	60 cm x 50 cm	
Conjunto de chaves de fendas de precisão [00341820]	9 peças, 2,0 mm, 2,4 mm, 3,0 mm, PH0, PH00, PH1, TX6, TX8, TX9	
Ferramenta auxiliar [00342180]	Ferramenta para soltar as partes em plástico, "magic tool"	
Ventosa [00342224]	Ø 50 mm	
Ponta Torx TX20 [00340865]	6,3 mm (1/4")	
Chave de fendas	Lâmina 10 mm x 1,6 mm x 200 mm	

## **Reparação**



### **4.1 Substituir a junta da porta**

#### **Pré-requisito:**



- A porta está aberta.

## 4.2 Substituir o puxador da porta

### Ferramentas sugeridas:

-  Ponta Torx TX20                      6,3 mm (1/4")                      [00340865]
-  Chave de fendas                      Lâmina 10 mm x 1,6 mm x 200 mm

### Pré-requisito:

-  O aparelho está desligado da alimentação elétrica.
-  A porta está aberta.

### 4.2.1 Remover o puxador da porta

- ▶ 1. Remova duas tampas roscadas (1).
- ▶ 2. Desaperte dois parafusos (2).
- ▶ 3. Remova o puxador da porta (3).

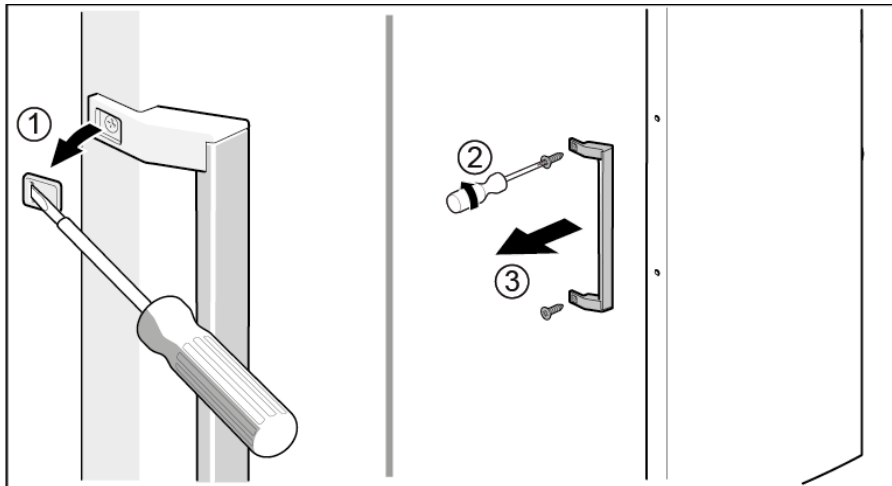

 O puxador da porta está removido.



O puxador da porta para a segunda porta pode ser removido da mesma forma.

### 4.2.2 Instalar o puxador da porta

- ▶ Instale pela ordem inversa.

## 4.3 Substituir a dobradiça superior da porta

### Ferramentas sugeridas:

🔧 Ponta Torx TX20      6,3 mm (1/4")      [00340865]

	<p><b>⚠️ AVISO</b></p> <p><b>Aparelhos pesados e volumosos!</b> Lesões nas costas e musculares</p> <ul style="list-style-type: none"><li>▶ A operação de remoção da porta do aparelho deve ser apenas executada por especialistas formados.</li><li>▶ São necessárias duas pessoas para mover o aparelho.</li><li>▶ Use apenas ferramentas e equipamento adequados.</li></ul>
--	---

	<p><b>⚠️ CUIDADO</b></p> <p><b>Arestas vivas!</b> Ferimentos por corte</p> <ul style="list-style-type: none"><li>▶ Use luvas de proteção.</li></ul>
--	---

	<p><b>⚠️ AVISO</b></p> <p><b>Deslizamento de aparelhos inclinados!</b> Fraturas ósseas / lesões por esmagamento</p> <ul style="list-style-type: none"><li>▶ Proteja os aparelhos contra o deslizamento.</li></ul>
--	---

	<p><b>⚠️ CUIDADO</b></p> <p><b>Risco de queda de peças devido a parafusos desapertados!</b> Lesões devido à queda de peças.</p> <ul style="list-style-type: none"><li>▶ Proteja o componente contra as quedas.</li></ul>
---	--

	<p><b>⚠️ ATENÇÃO!</b></p> <p><b>Risco de queda de peças devido a parafusos desapertados!</b> Danos em outros componentes do aparelho ou na casa do cliente, p. ex., no pavimento.</p> <ul style="list-style-type: none"><li>▶ Proteja o componente contra as quedas.</li></ul>
--	--

### Pré-requisito:

- ✔ O aparelho está desligado da alimentação elétrica.
- ✔ As fixações interiores do aparelho estão removidas.

## 4.3.1 Remover a dobradiça superior da porta

1. Coloque o aparelho sobre o lado traseiro.

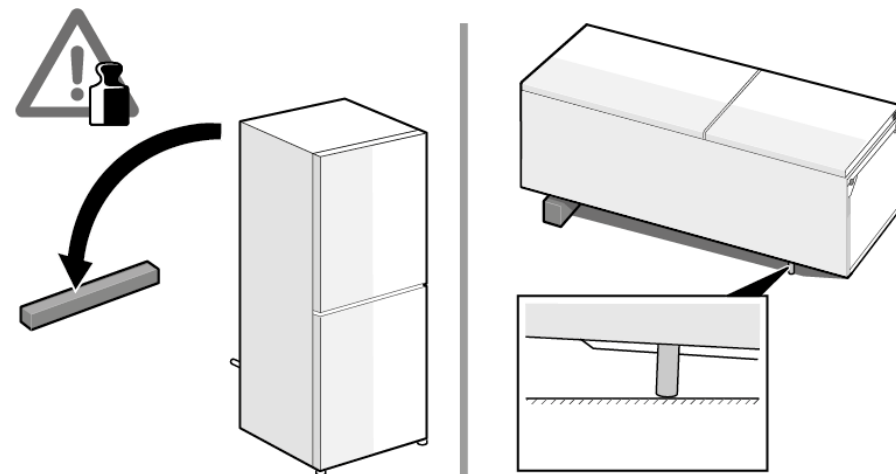

## Reparação

2. 1. Pressione a tampa da dobradiça superior de ambos os lados (1).
2. Extraia a tampa da dobradiça superior (2).
3. Rode a tampa da dobradiça (3).
4. Remova a tampa da dobradiça superior (4).
5. Desaperte dois parafusos (5).
6. Remova a dobradiça superior (6).

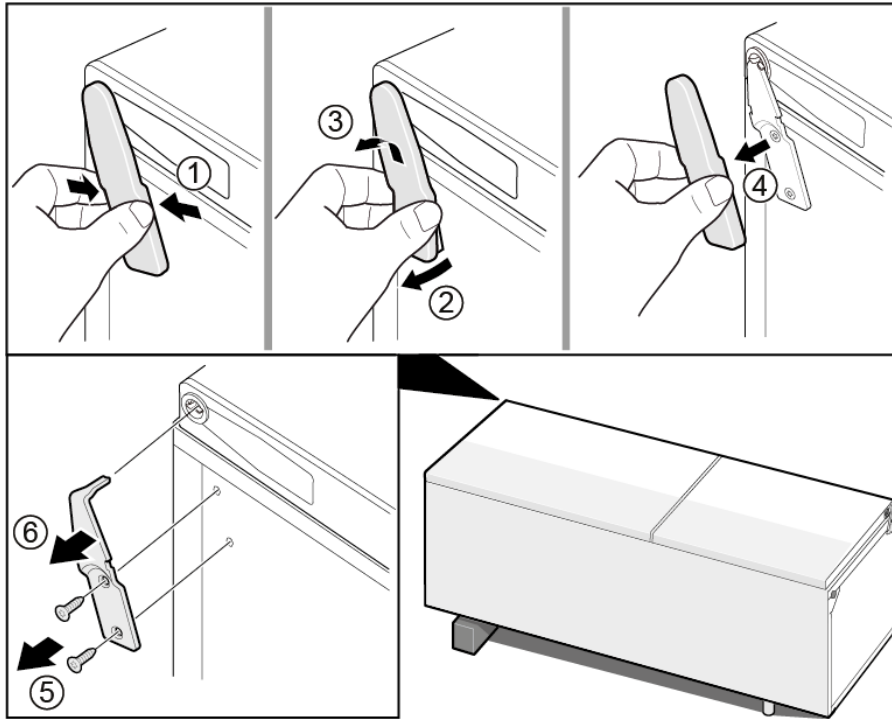

 A dobradiça superior está removida.

### 4.3.2 Instalar a dobradiça superior da porta

- ▶ Instale pela ordem inversa.

## 4.4 Substituir a dobradiça superior da porta (porta com visor)

Ferramentas sugeridas:

🔧 Ponta Torx TX20      6,3 mm (1/4")      [00340865]

	<b>⚠️ AVISO</b>
	<p><b>Aparelhos pesados e volumosos!</b> Lesões nas costas e musculares</p> <ul style="list-style-type: none"> <li>▶ A operação de remoção da porta do aparelho deve ser apenas executada por especialistas formados.</li> <li>▶ São necessárias duas pessoas para mover o aparelho.</li> <li>▶ Use apenas ferramentas e equipamento adequados.</li> </ul>

	<b>⚠️ CUIDADO</b>
	<p><b>Arestas vivas!</b> Ferimentos por corte</p> <ul style="list-style-type: none"> <li>▶ Use luvas de proteção.</li> </ul>

	<b>⚠️ AVISO</b>
	<p><b>Deslizamento de aparelhos inclinados!</b> Fraturas ósseas / lesões por esmagamento</p> <ul style="list-style-type: none"> <li>▶ Proteja os aparelhos contra o deslizamento.</li> </ul>

	<b>⚠️ CUIDADO</b>
	<p><b>Risco de queda de peças devido a parafusos desapertados!</b> Lesões devido à queda de peças.</p> <ul style="list-style-type: none"> <li>▶ Proteja o componente contra as quedas.</li> </ul>

	<b>ATENÇÃO!</b>
	<p><b>Risco de queda de peças devido a parafusos desapertados!</b> Danos em outros componentes do aparelho ou na casa do cliente, p. ex., no pavimento.</p> <ul style="list-style-type: none"> <li>▶ Proteja o componente contra as quedas.</li> </ul>

	<b>⚠️ PERIGO</b>
	<p><b>Risco de choque elétrico devido a peças sob tensão!</b> Perigo de vida por choque elétrico em caso de reparação inadequada</p> <ul style="list-style-type: none"> <li>▶ As peças elétricas devem ser reparadas por um electricista qualificado.</li> <li>▶ Após a reparação, efetue um teste de segurança de acordo com a norma VDE 0701 ou com os regulamentos específicos do país.</li> </ul>

	<b>⚠️ PERIGO</b>
	<p><b>Risco de choque elétrico devido a peças sob tensão!</b> Morte por eletrocussão</p> <ul style="list-style-type: none"> <li>▶ Desligue os aparelhos da fonte de alimentação elétrica pelo menos 60 segundos antes de iniciar as reparações.</li> </ul>

**Pré-requisito:**

- ✓ O aparelho está desligado da alimentação elétrica.
- ✓ As fixações interiores do aparelho estão removidas.

### 4.4.1 Remover a dobradiça superior da porta

1. Coloque o aparelho sobre o lado traseiro.

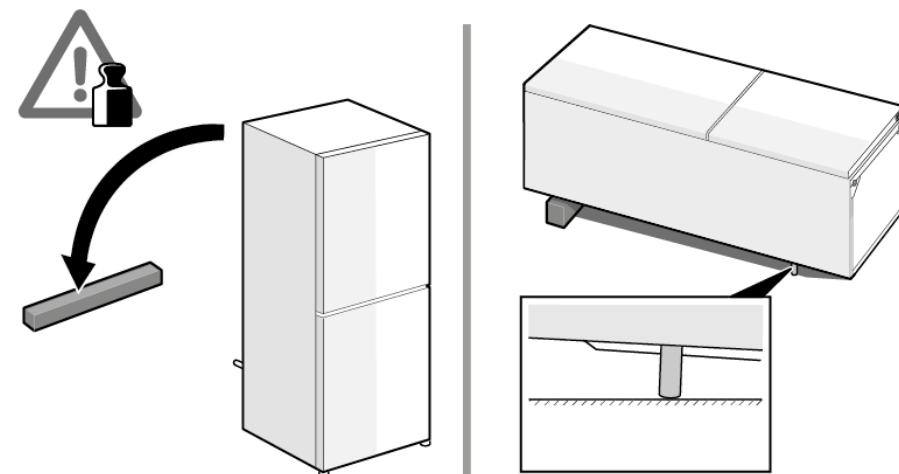

## Reparação

2. 1. Remova a tampa da dobradiça superior (1).
2. Remova a tampa da caixa de cabos (2).
3. Desconecte a ligação elétrica (3).
4. Desaperte o parafuso de ligação à terra (4).
5. Remova a proteção dos cabos (5).
6. Desaperte o parafuso (6)

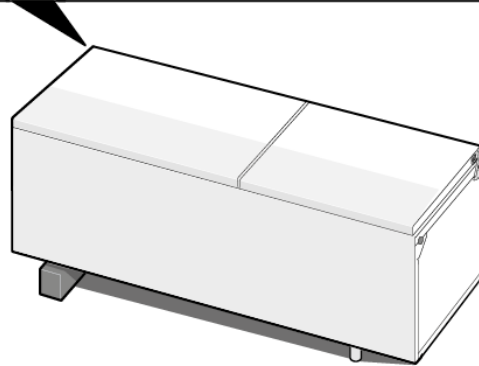
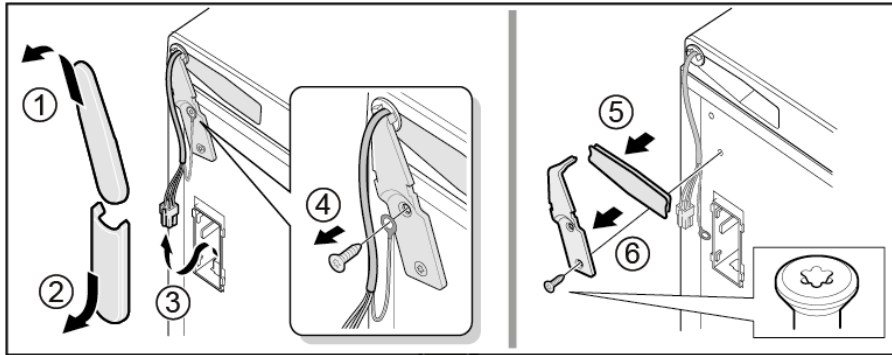

 A dobradiça superior está removida.

### 4.4.2 Instalar a dobradiça superior da porta

- ▶ Instale pela ordem inversa.

## 4.5 Substituir a dobradiça central da porta

### Ferramentas sugeridas:

🔧 Ponta Torx TX20      6,3 mm (1/4")      [00340865]

	<b>⚠️ AVISO</b>
	<b>Aparelhos pesados e volumosos!</b> Lesões nas costas e musculares <ul style="list-style-type: none"><li>▶ A operação de remoção da porta do aparelho deve ser apenas executada por especialistas formados.</li><li>▶ São necessárias duas pessoas para mover o aparelho.</li><li>▶ Use apenas ferramentas e equipamento adequados.</li></ul>

	<b>⚠️ CUIDADO</b>
	<b>Arestas vivas!</b> Ferimentos por corte <ul style="list-style-type: none"><li>▶ Use luvas de proteção.</li></ul>

	<b>⚠️ AVISO</b>
	<b>Deslizamento de aparelhos inclinados!</b> Fraturas ósseas / lesões por esmagamento <ul style="list-style-type: none"><li>▶ Proteja os aparelhos contra o deslizamento.</li></ul>

	<b>⚠️ CUIDADO</b>
	<b>Risco de queda de peças devido a parafusos desapertados!</b> Lesões devido à queda de peças. <ul style="list-style-type: none"><li>▶ Proteja o componente contra as quedas.</li></ul>

	<b>ATENÇÃO!</b>
	<b>Risco de queda de peças devido a parafusos desapertados!</b> Danos em outros componentes do aparelho ou na casa do cliente, p. ex., no pavimento. <ul style="list-style-type: none"><li>▶ Proteja o componente contra as quedas.</li></ul>

### Pré-requisito:

- ✔ O aparelho está desligado da alimentação elétrica.
- ✔ As fixações interiores do aparelho estão removidas.
- ✔ A dobradiça superior da porta está removida.

✔ A porta superior está removida.

### 4.5.1 Remover a dobradiça central da porta

- ▶ 1. Remova a porta do compartimento de refrigeração (1).
- ▶ 2. Desaperte dois parafusos (2).
- ▶ 3. Remova a dobradiça central (3).

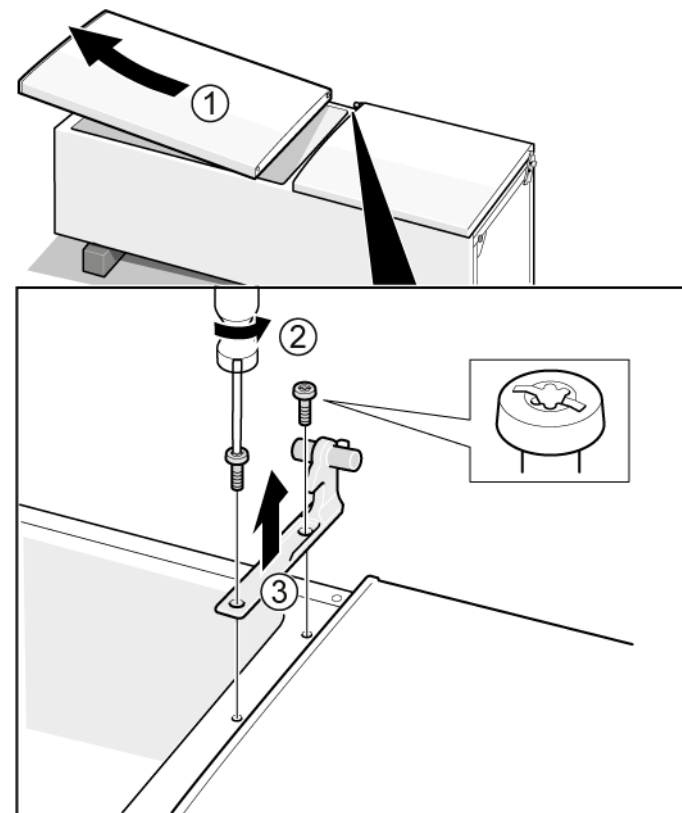

➡ A dobradiça central está removida.

### 4.5.2 Instalar a dobradiça central da porta

- ▶ Instale pela ordem inversa.

## 4.6 Substituir a dobradiça inferior da porta

### Ferramentas sugeridas:

🔧 Ponta Torx TX20      6,3 mm (1/4")      [00340865]

	<b>⚠️ AVISO</b>
	<b>Aparelhos pesados e volumosos!</b> Lesões nas costas e musculares <ul style="list-style-type: none"><li>▶ A operação de remoção da porta do aparelho deve ser apenas executada por especialistas formados.</li><li>▶ São necessárias duas pessoas para mover o aparelho.</li><li>▶ Use apenas ferramentas e equipamento adequados.</li></ul>

	<b>⚠️ CUIDADO</b>
	<b>Arestas vivas!</b> Ferimentos por corte <ul style="list-style-type: none"><li>▶ Use luvas de proteção.</li></ul>

	<b>⚠️ AVISO</b>
	<b>Deslizamento de aparelhos inclinados!</b> Fraturas ósseas / lesões por esmagamento <ul style="list-style-type: none"><li>▶ Proteja os aparelhos contra o deslizamento.</li></ul>

	<b>⚠️ CUIDADO</b>
	<b>Risco de queda de peças devido a parafusos desapertados!</b> Lesões devido à queda de peças. <ul style="list-style-type: none"><li>▶ Proteja o componente contra as quedas.</li></ul>

	<b>ATENÇÃO!</b>
	<b>Risco de queda de peças devido a parafusos desapertados!</b> Danos em outros componentes do aparelho ou na casa do cliente, p. ex., no pavimento. <ul style="list-style-type: none"><li>▶ Proteja o componente contra as quedas.</li></ul>

### Pré-requisito:

- ✔ O aparelho está desligado da alimentação elétrica.
- ✔ As fixações interiores do aparelho estão removidas.
- ✔ A dobradiça superior está removida.

✔ A dobradiça central está removida.

### 4.6.1 Remover a dobradiça inferior da porta

- ▶ 1. Remova a porta da zona do congelador (1).
- ▶ 2. Desaperte o parafuso (2).
- ▶ 3. Rode dobradiça inferior para fora (3).
- ▶ 4. Remova a dobradiça inferior (4).

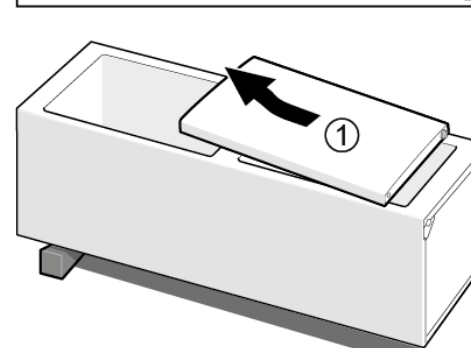
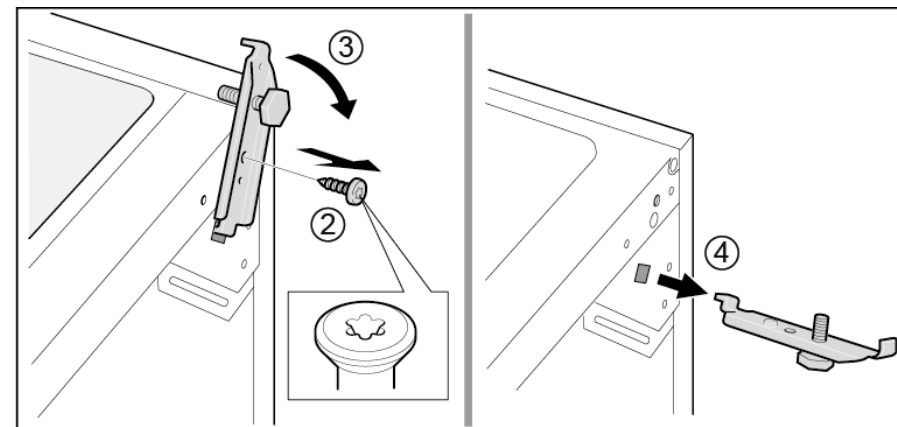

➡ A dobradiça inferior da porta está removida.

### 4.6.2 Instalar a dobradiça inferior da porta

- ▶ Instale pela ordem inversa.

## 4.7 Substituir a prateleira

### Pré-requisito:

- ✔ A porta está aberta.

### 4.7.1 Remover a prateleira

- ▶ Puxe a prateleira para fora.

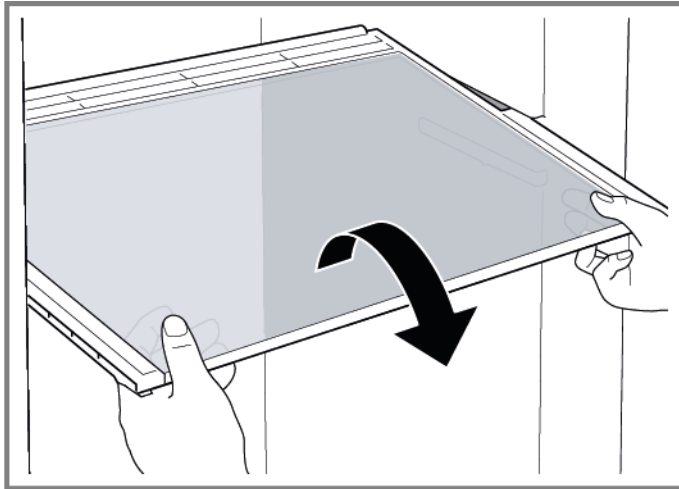

- ➡ A prateleira está removida.

### 4.7.2 Instalar a prateleira

- ▶ Instale pela ordem inversa.

## 4.8 Substituir a prateleira variável

### Pré-requisito:

- ✔ A porta está aberta.

### 4.8.1 Remover a prateleira variável

1. Puxe a secção direita da prateleira variável para a frente (1).
2. Remova a secção direita da prateleira variável (2).

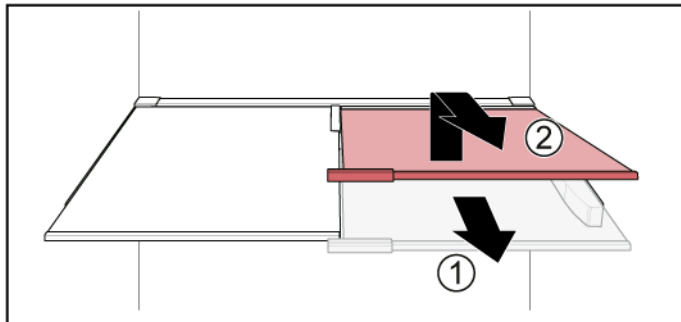

2. Remova a secção esquerda da prateleira variável da mesma forma.

➡ A prateleira variável está removida.

### 4.8.2 Instalar a prateleira variável

- ▶ Instale pela ordem inversa.

## 4.9 Substituir a prateleira flexível

Pré-requisito:

- ✔ A porta está aberta.

### 4.9.1 Remover a prateleira flexível

- ▶ 1. Remova a prateleira de vidro (1).
- ▶ 2. Levante a prateleira flexível e puxe-a para fora (2).

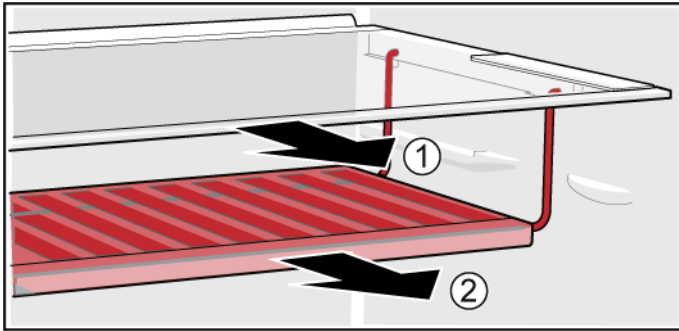

- ➡ A prateleira flexível está removida.

### 4.9.2 Instalar a prateleira flexível

- ▶ Instale pela ordem inversa.

### **4.10 Substituir o conjunto de pequeno-almoço**

**Pré-requisito:**

- ✔ A porta está aberta.

#### **4.10.1 Remover o conjunto de pequeno-almoço**

- ▶ Levante o conjunto de pequeno-almoço e puxe-o para fora.

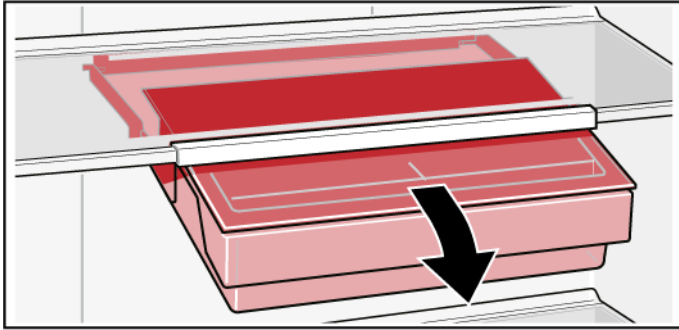

- ➡ O conjunto de pequeno-almoço está removido.

#### **4.10.2 Instalar o conjunto de pequeno-almoço**

- ▶ Instale pela ordem inversa.

### 4.11 Substituir o suporte para garrafas

Pré-requisito:

- ✔ A porta está aberta.

#### 4.11.1 Remover o suporte para garrafas

- ▶ Puxe para fora o suporte para garrafas.

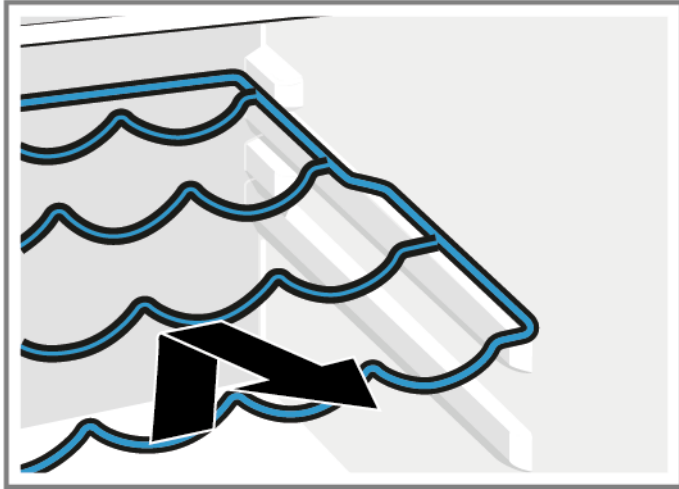

- ➡ O suporte para garrafas está removido.

#### 4.11.2 Instalar o suporte para garrafas

- ▶ Instale pela ordem inversa.

## 4.12 Substituir a prateleira da porta

Pré-requisito:

- ✔ A porta está aberta.

### 4.12.1 Remover a prateleira da porta

- ▶ Levante a prateleira da porta.

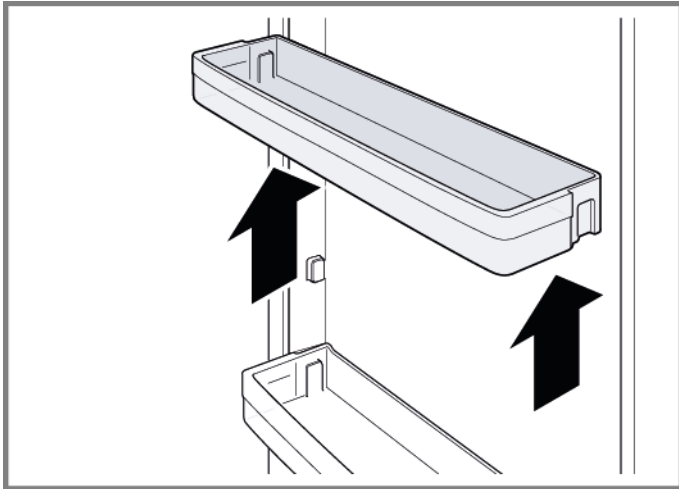

➡ A prateleira da porta está removida.

### 4.12.2 Instalar a prateleira da porta

- ▶ Instale pela ordem inversa.

## 4.13 Substituir o recipiente para alimentos congelados

### Pré-requisito:

- ✔ A porta está aberta.

### 4.13.1 Remover o recipiente para alimentos congelados

- ▶ 1. Puxe o recipiente para alimentos congelados inteiramente para fora (1).
- ▶ 2. Remova o recipiente para alimentos (2).

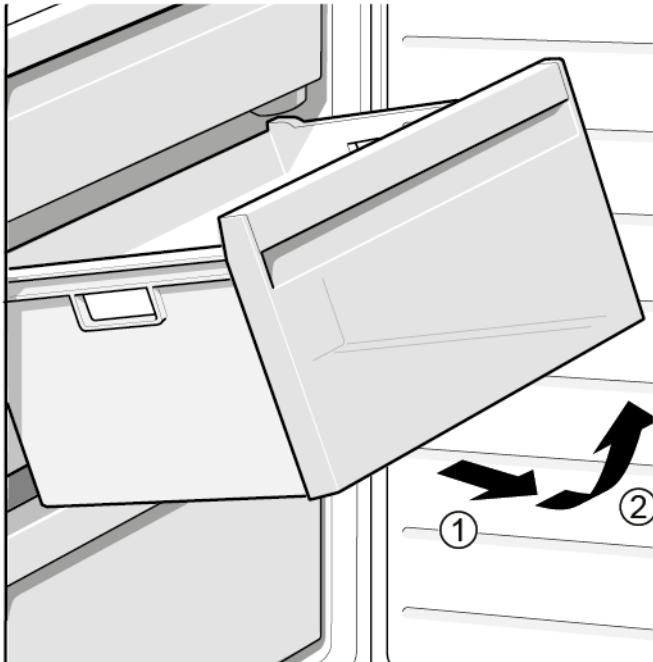

- ➡ O recipiente para alimentos congelados está removido.

### 4.13.2 Instalar o recipiente para alimentos congelados

- ▶ Instale pela ordem inversa.

## 4.14 Substituir o recipiente

### Pré-requisito:

- ✔ A porta está aberta.

### 4.14.1 Remover o recipiente

- ▶ 1. Retire o recipiente inferior do frigorífico (1).
- ▶ 2. Retire o recipiente superior do frigorífico (2).

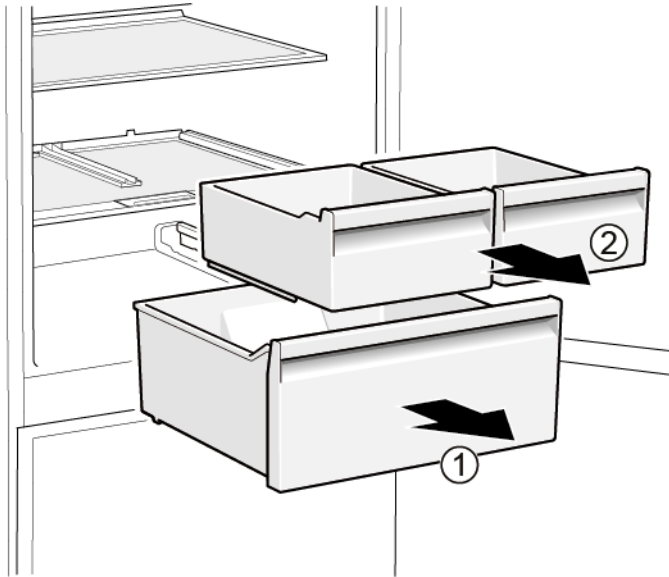

- ➡ Os recipientes estão removidos.

### 4.14.2 Instalar o recipiente

- ▶ Instale pela ordem inversa.

## 4.15 Substituir o recipiente extensível

### Pré-requisito:

- ✔ A porta está aberta.

### 4.15.1 Remover o recipiente extensível

- ▶ 1. Puxe o recipiente extensível inteiramente para fora (1).
- ▶ 2. Remova o recipiente extensível (2).

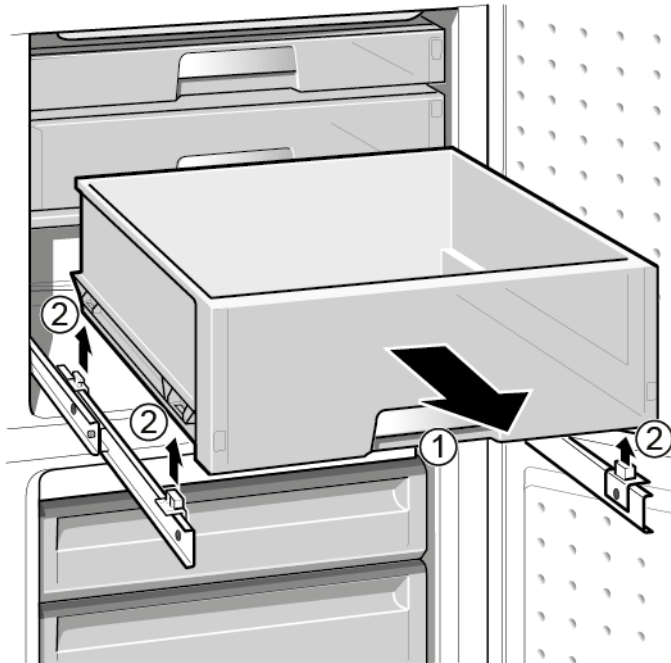

- ➡ O recipiente extensível está removido.

### 4.15.2 Instalar o recipiente extensível

- ▶ Instale pela ordem inversa.

## 4.16 Substituir a iluminação LED específica

### Ferramentas sugeridas:

Ferramenta especial

[00342180]



O seu aparelho dispõe de uma iluminação LED isenta de manutenção. Estas iluminações só podem ser reparadas pelo serviço de apoio ao consumidor ou por técnicos autorizados!



### PERIGO

#### Risco de choque elétrico devido a peças sob tensão!

Perigo de vida por choque elétrico em caso de reparação inadequada

- ▶ As peças elétricas devem ser reparadas por um electricista qualificado.
- ▶ Após a reparação, efetue um teste de segurança de acordo com a norma VDE 0701 ou com os regulamentos específicos do país.



### PERIGO

#### Risco de choque elétrico devido a peças sob tensão!

Morte por eletrocussão

- ▶ Desligue os aparelhos da fonte de alimentação elétrica pelo menos 60 segundos antes de iniciar as reparações.



### CUIDADO

#### Arestas vivas!

Ferimentos por corte

- ▶ Use luvas de proteção.

### Pré-requisito:

- ✓ O aparelho está desligado da alimentação elétrica.
- ✓ A porta está aberta.

## 4.16.1 Remover a iluminação LED específica

1. Use uma ferramenta especial para puxar para fora a iluminação LED específica (1).



2. Desconecte as ligações elétricas da iluminação LED específica.
- ➡ A iluminação LED específica está removida.

## 4.16.2 Instalar a iluminação LED específica

- ▶ Instale pela ordem inversa.

## 4.17 Substituir a iluminação LED superior

### Ferramentas sugeridas:

-  Chave de fendas Lâmina 2,4 mm x 0,4 mm x 60 mm, no kit [00341820]

 O seu aparelho dispõe de uma iluminação LED isenta de manutenção. Estas iluminações só podem ser reparadas pelo serviço de apoio ao consumidor ou por técnicos autorizados!



### PERIGO

#### Risco de choque elétrico devido a peças sob tensão!

Perigo de vida por choque elétrico em caso de reparação inadequada

- ▶ As peças elétricas devem ser reparadas por um electricista qualificado.
- ▶ Após a reparação, efetue um teste de segurança de acordo com a norma VDE 0701 ou com os regulamentos específicos do país.



### PERIGO

#### Risco de choque elétrico devido a peças sob tensão!

Morte por eletrocussão

- ▶ Desligue os aparelhos da fonte de alimentação elétrica pelo menos 60 segundos antes de iniciar as reparações.





### CUIDADO

#### Arestas vivas!

Ferimentos por corte

- ▶ Use luvas de proteção.

### Pré-requisito:

-  O aparelho está desligado da alimentação elétrica.
-  A porta está aberta.
-  As fixações interiores superiores estão removidas.

### 4.17.1 Remover a iluminação LED

1. Desloque a iluminação LED para o lado esquerdo.



-  A ligação elétrica da iluminação LED está desligada.

2. Solte os ganchos da iluminação LED.

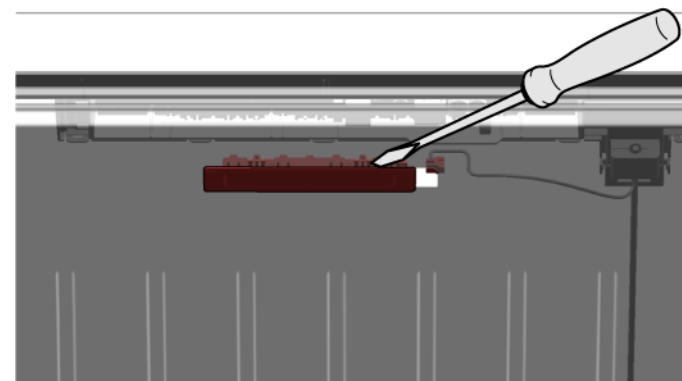

## Reparação

3. Remova a iluminação LED, avançando-a.

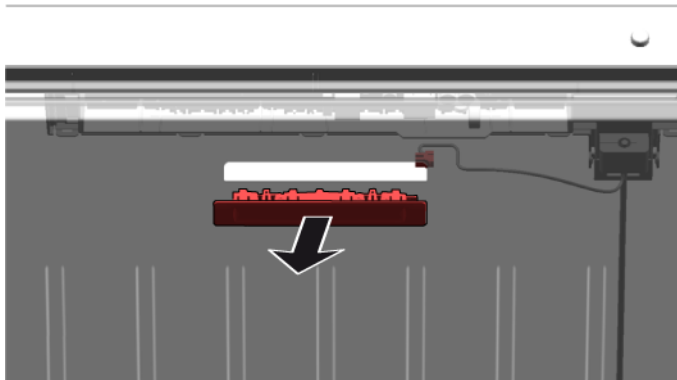

- ➡ A iluminação LED está removida.

### 4.17.2 Instalar a iluminação LED superior

- ▶ Instale pela ordem inversa.

## 4.18 Substituir a iluminação LED de barra lateral

### Ferramentas sugeridas:

 Ventosa Ø50 mm [00342224]



O seu aparelho dispõe de uma iluminação LED isenta de manutenção. Estas iluminações só podem ser reparadas pelo serviço de apoio ao consumidor ou por técnicos autorizados!



### PERIGO

#### Risco de choque elétrico devido a peças sob tensão!

Perigo de vida por choque elétrico em caso de reparação inadequada

- ▶ As peças elétricas devem ser reparadas por um electricista qualificado.
- ▶ Após a reparação, efetue um teste de segurança de acordo com a norma VDE 0701 ou com os regulamentos específicos do país.



### PERIGO

#### Risco de choque elétrico devido a peças sob tensão!

Morte por eletrocussão

- ▶ Desligue os aparelhos da fonte de alimentação elétrica pelo menos 60 segundos antes de iniciar as reparações.





### CUIDADO

#### Arestas vivas!

Ferimentos por corte

- ▶ Use luvas de proteção.

### Pré-requisito:

-  O aparelho está desligado da alimentação elétrica.
-  A porta está aberta.
-  As prateleiras do compartimento de refrigeração estão removidas.

## 4.18.1 Remover a iluminação LED de barra lateral

1. Coloque a ventosa no terço superior da iluminação LED de barra lateral.



## Reparação

2. Puxe a ventosa para a frente com a iluminação LED de barra lateral num movimento rotativo.

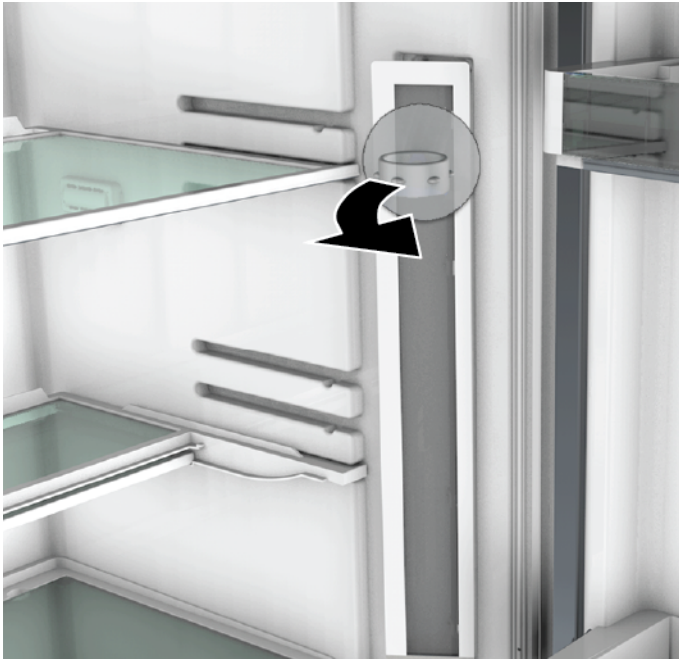





3. Desconecte a ligação elétrica da iluminação LED de barra lateral.  
➡ A iluminação LED de barra lateral está removida.

### 4.18.2 Instalar a iluminação LED de barra lateral

1. Conecte a ligação elétrica da iluminação LED de barra lateral.
2. Fixe a iluminação LED de barra lateral na sua localização na parede do compartimento (os ganchos encaixam).

- ➡ A iluminação LED de barra lateral está instalada.

# Indicii pentru reparații - Combină frigorifică

 <b>Referitor la acest document</b> .....	<b>489</b>
1.1 Informații importante .....	489
1.1.1 Aplicabilitatea .....	489
1.2 Explicația simbolurilor .....	489
1.2.1 Nivelurile de pericol .....	489
1.2.2 Simbolurile de pericol .....	489
1.2.3 Structura avertismentelor .....	490
1.2.4 Simbolurile generale .....	490
 <b>Siguranța</b> .....	<b>491</b>
2.1 Instrucțiuni generale de siguranță .....	491
2.1.1 Toate aparatele electrocasnice .....	491
 <b>Instrumente și materiale utile</b> .....	<b>492</b>
 <b>Repararea</b> .....	<b>493</b>
4.1 Înlocuirea garniturii ușii .....	493
4.2 Înlocuirea mânerului ușii .....	494
4.2.1 Demontarea mânerului ușii .....	494
4.2.2 Montarea mânerului ușii .....	494
4.3 Înlocuirea balamalei de sus a ușii .....	495
4.3.1 Demontarea balamalei de sus a ușii .....	495
4.3.2 Montarea balamalei de sus a ușii .....	496
4.4 Înlocuirea balamalei de sus a ușii (ușă cu afișaj) .....	497
4.4.1 Demontarea balamalei de sus a ușii .....	497
4.4.2 Montarea balamalei de sus a ușii .....	498
4.5 Înlocuirea balamalei din mijloc a ușii .....	499
4.5.1 Demontarea balamalei din mijloc a ușii .....	499
4.5.2 Montarea balamalei din mijloc a ușii .....	499
4.6 Înlocuirea balamalei de jos a ușii .....	500
4.6.1 Demontarea balamalei de jos a ușii .....	500
4.6.2 Montarea balamalei de jos a ușii .....	500
4.7 Repoziționarea raftului .....	501
4.7.1 Demontarea raftului .....	501
4.7.2 Montarea raftului .....	501
4.8 Repoziționarea raftului variabil .....	502

4.8.1 Demontarea raftului variabil .....	502
4.8.2 Montarea raftului variabil .....	502
4.9 Repoziționarea raftului flexibil .....	503
4.9.1 Demontarea raftului flexibil .....	503
4.9.2 Montarea raftului flexibil .....	503
4.10 Repoziționarea setului pentru mic dejun .....	504
4.10.1 Demontarea setului pentru mic dejun .....	504
4.10.2 Montarea setului pentru mic dejun .....	504
4.11 Repoziționarea suportului pentru sticle .....	505
4.11.1 Demontarea suportului pentru sticle .....	505
4.11.2 Montarea suportului pentru sticle .....	505
4.12 Repoziționarea raftului pentru ușă .....	506
4.12.1 Demontarea raftului pentru ușă .....	506
4.12.2 Montarea raftului pentru ușă .....	506
4.13 Repoziționarea containerului pentru alimente înghețate .....	507
4.13.1 Demontarea containerului pentru alimente înghețate .....	507
4.13.2 Montarea containerului pentru alimente înghețate .....	507
4.14 Repoziționarea containerului .....	508
4.14.1 Demontarea containerului .....	508
4.14.2 Montarea containerului .....	508
4.15 Repoziționarea containerului extensibil .....	509
4.15.1 Demontarea containerului extensibil .....	509
4.15.2 Montarea containerului extensibil .....	509
4.16 Înlocuirea spotului luminos LED .....	510
4.16.1 Demontarea spotului luminos LED .....	510
4.16.2 Montarea spotului luminos LED .....	510
4.17 Înlocuirea lămpii LED de sus .....	511
4.17.1 Demontarea lămpii LED .....	511
4.17.2 Montarea lămpii LED de sus .....	512
4.18 Înlocuirea lămpii LED de pe bara laterală .....	513
4.18.1 Demontarea lămpii LED de pe bara laterală .....	513
4.18.2 Montarea lămpii LED de pe bara laterală .....	514

# **i** Referitor la acest document

## 1.1 Informații importante

### 1.1.1 Aplicabilitatea

Aceste instrucțiuni de reparare îl ajută pe client să își repare singur aparatele, în conformitate cu normele de proiectare ecologică aplicabile (începând cu 03/2021).



Acestea conțin informații privind modul de înlocuire a pieselor de schimb specifice, inclusiv avertismente și pericole.

Dacă aveți întrebări, vă rugăm să luați legătura cu serviciul relații clienți. Ne asumăm răspunderea pentru daune numai dacă instrucțiunile de reparare au fost respectate pe deplin.

## 1.2 Explicația simbolurilor

### 1.2.1 Nivelurile de pericol

Nivelurile de alertă sunt reprezentate printr-un simbol și un cuvânt de avertizare. Cuvântul de avertizare indică gravitatea pericolului.





Nivelul de alertă	Semnificație
 <b>PERICOL</b>	Nerespectarea mesajului de avertizare va provoca accidente grave sau decesul.
 <b>AVERTISMENT</b>	Nerespectarea mesajului de avertizare ar putea provoca accidente grave sau decesul.
 <b>ATENȚIONARE</b>	Nerespectarea mesajului de avertizare ar putea provoca accidente ușoare.
<b>ATENȚIE!</b>	Nerespectarea mesajului de avertizare ar putea provoca daune asupra proprietății.

Tabel 1: Nivelurile de pericol



### 1.2.2 Simbolurile de pericol

Simbolurile de pericol sunt reprezentări simbolice care indică tipul de pericol.

În acest document sunt utilizate simbolurile de pericol de mai jos:

Simbol de pericol	Semnificație
	Mesaj de avertizare general
	Pericol din cauza tensiunii electrice
	Pericol de explozie
	Pericol de tăiere
	Pericol de zdrobire

## **i** Referitor la acest document

Simbol de pericol	Semnificație
	Pericol din cauza suprafețelor fierbinți
	Pericol din cauza câmpului magnetic puternic
	Pericol din cauza radiației neionizante

Tabel 2: Simbolurile de pericol

### 1.2.3 Structura avertismentelor

Avertismentele din acest document au un aspect și o structură standard.



	<div style="background-color: red; color: white; padding: 2px; text-align: center;"><b>⚠ PERICOL</b></div> <p><b>Tipul și sursa pericolului!</b> Consecințele posibile ale ignorării pericolului/avertismentului.</p> <ul style="list-style-type: none"> <li>▶ Măsuri și interdicții pentru prevenirea pericolului.</li> </ul>
--	--









Exemplul următor prezintă un avertisment privind electrocutarea din cauza pieselor sub tensiune. Se menționează măsura necesară pentru a evita pericolul.

	<div style="background-color: red; color: white; padding: 2px; text-align: center;"><b>⚠ PERICOL</b></div> <p><b>Pericol de electrocutare din cauza pieselor sub tensiune!</b> Deces prin electrocutare</p> <ul style="list-style-type: none"> <li>▶ Deconectați aparatele de la sursa de alimentare cu tensiune cu cel puțin 60 de secunde înainte de a începe reparațiile.</li> </ul>
---	---

### 1.2.4 Simbolurile generale

În acest document sunt utilizate simbolurile generale de mai jos:

Simbol general	Semnificație
	Identificarea unei recomandări speciale (text și/sau grafică)
	Identificarea unei recomandări simple (numai text)

Simbol general	Semnificație
	Identificarea unui link spre un videoclip instructiv
	Identificarea sculelor necesare
	Identificarea condițiilor preliminare necesare
	Identificarea unei stări (dacă..., apoi...)
	Identificarea unui rezultat
	Identificarea unei taste sau a unui buton
	Identificarea unui număr de serie
	Identificarea unui text/unei ferestre afișate (pe ecranul aparatului)

Tabel 3: Simbolurile generale

## 2.1 Instrucțiuni generale de siguranță

### 2.1.1 Toate aparatele electrocasnice

#### **Pericol de electrocutare din cauza pieselor sub tensiune!**

- Erorile care au loc în timpul reparațiilor efectuate la componentele electrice pot să ducă la electrocutări!
- Deconectați aparatul de la sursa de alimentare cu tensiune cu cel puțin 60 de secunde înainte de a începe lucrările.
- După reparație, este obligatorie efectuarea unei verificări de siguranță conform cu VDE 0701 sau cu reglementările naționale respective.

#### **Pericol de rănire din cauza muchiilor ascuțite!**

- Purtați mănuși de protecție.

#### **Pericol de zdrobire în timpul lucrărilor de reparație, întreținere, depanare și service, din cauza componentelor grele și mobile**

- Purtați încălțăminte de protecție.
- Fixați componentele grele împotriva căderii.
- Nu vă sprijiniți cu părți ale corpului de componentele mobile.

#### **Pericol pentru siguranța/funcționarea aparatului!**

- Utilizați numai piese de schimb originale.

#### **Pericol de deteriorare a componentelor sensibile la electricitatea statică (ESD)!**

- Nu atingeți modulele, inclusiv conexiunile și căile conductorilor.

## Instrumente și materiale utile

Desemnare	Detalii	Imagini
Material textil de protecție [00342013]	60 cm x 50 cm	
Set de șurubelnițe de precizie [00341820]	9 piese, 2,0 mm, 2,4 mm, 3,0 mm, PH0, PH00, PH1, TX6, TX8, TX9	
Instrumentul auxiliar [00342180]	Instrument pentru slăbirea pieselor din plastic, "magic tool"	
Ventuză [00342224]	Ø 50 mm	
Cap torx TX20 [00340865]	6,3 mm (1/4")	
Șurubelniță plată	Lamă de 10 mm x 1,6 mm x 200 mm	

## **Repararea**



### **4.1 Înlocuirea garniturii ușii**

#### **Cerință:**



- Ușa este deschisă.

## 4.2 Înlocuirea mânerului ușii

### Scule speciale:

-  Cap torx TX20                      6,3 mm (1/4")                      [00340865]
-  Șurubelniță plată                      Lamă de 10 mm x 1,6 mm x 200 mm

### Cerință:

-  Aparatul este deconectat de la sursa de energie electrică.
-  Ușa este deschisă.

### 4.2.1 Demontarea mânerului ușii

- ▶ 1. Demontați două capace de șuruburi (1).
- ▶ 2. Deșurubați două șuruburi (2).
- ▶ 3. Demontați mânerul ușii (3).

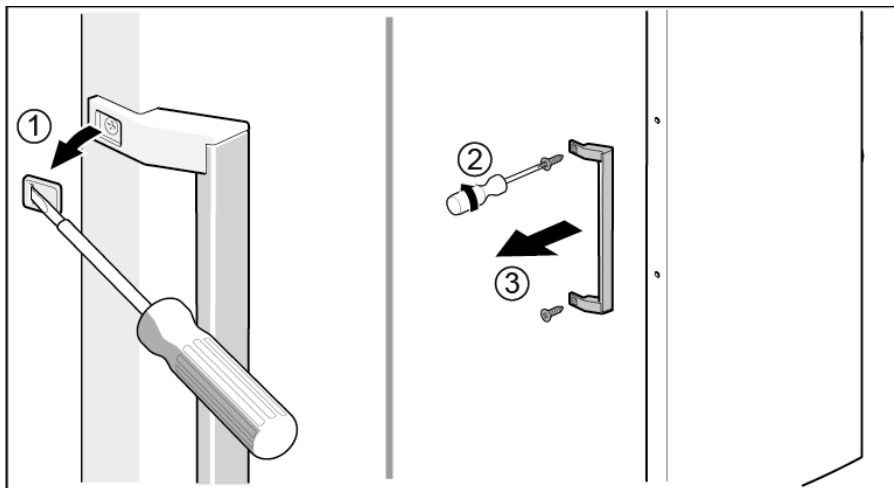

 Mânerul ușii este demontat.



Mânerul ușii pentru cea de-a doua ușă poate fi demontat în același mod.

### 4.2.2 Montarea mânerului ușii

- ▶ Montați urmând procedura de demontare în ordine inversă.

## 4.3 Înlocuirea balamalei de sus a ușii

### Scule speciale:

🌀 Cap torx TX20

6,3 mm (1/4")

[00340865]

	<b>⚠️ AVERTISMENT</b>
	<b>Aparate grele, masive!</b> Accidentarea spatelui și leziuni musculare <ul style="list-style-type: none"><li>▶ Operația de demontare a ușii aparatului trebuie efectuată numai de specialiști instruiți.</li><li>▶ Pentru deplasarea aparatului sunt necesare două persoane.</li><li>▶ Utilizați numai instrumente și echipamente adecvate.</li></ul>

	<b>⚠️ ATENȚIONARE</b>
	<b>Marginea ascuțită!</b> Rănire prin tăiere <ul style="list-style-type: none"><li>▶ Purtați mănuși de protecție.</li></ul>

	<b>⚠️ AVERTISMENT</b>
	<b>Alunecarea aparatelor înclinate!</b> Fracturi/zdrobiri <ul style="list-style-type: none"><li>▶ Fixați aparatele împotriva alunecării.</li></ul>

	<b>⚠️ ATENȚIONARE</b>
	<b>Pericol din cauza pieselor care cad pentru că șuruburile sunt slăbite!</b> Accidente din cauza pieselor care cad. <ul style="list-style-type: none"><li>▶ Fixați componenta împotriva căderii.</li></ul>

	<b>ATENȚIE!</b>
	<b>Pericol din cauza pieselor care cad pentru că șuruburile sunt slăbite!</b> Deteriorarea altor piese ale aparatului sau a casei clientului, de exemplu, partea de jos. <ul style="list-style-type: none"><li>▶ Fixați componenta împotriva căderii.</li></ul>

### Cerință:

- ✔️ Aparatul este deconectat de la sursa de energie electrică.
- ✔️ Fitingurile interioare ale aparatului sunt demontate.

## 4.3.1 Demontarea balamalei de sus a ușii

1. Așezați aparatul pe spate.

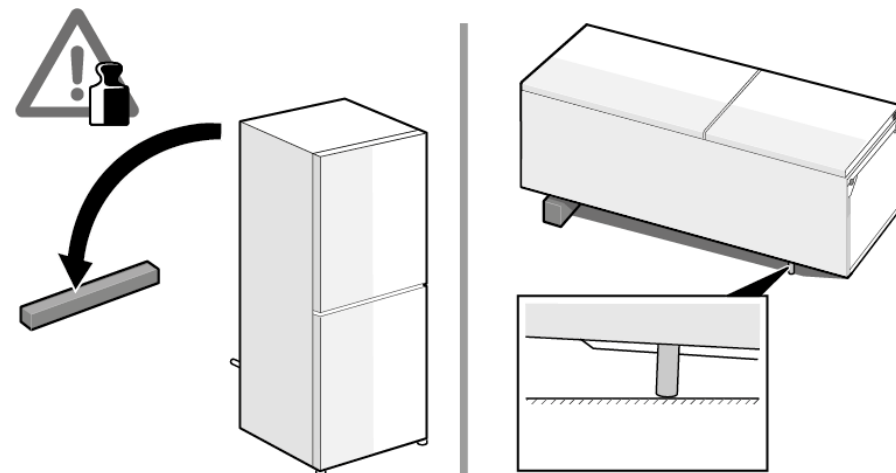

## Repararea

2. 1. Apăsați capacul balamalei de sus pe ambele părți laterale (1).
2. Îndepărtați capacul balamalei de sus (2).
3. Rotiți capacul balamalei (3).
4. Demontați capacul balamalei de sus (4).
5. Deșurubați două șuruburi (5).
6. Demontați balamaua de sus (6)/

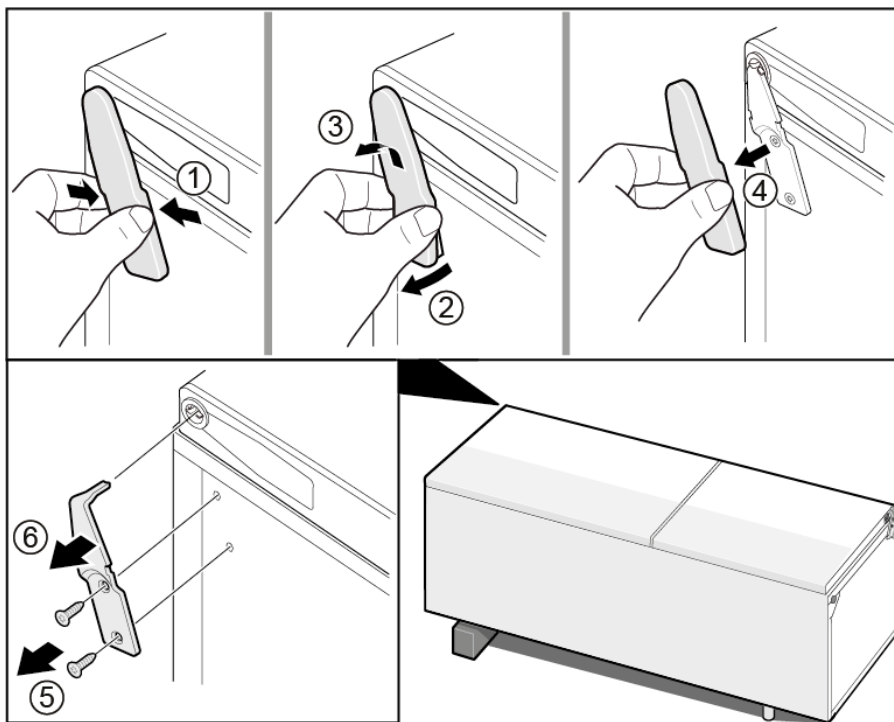

 Balamaua de sus este demontată.

### 4.3.2 Montarea balamalei de sus a ușii

- ▶ Montați urmând procedura de demontare în ordine inversă.

## 4.4 Înlocuirea balamalei de sus a ușii (ușă cu afișaj)

### Scule speciale:

🌀 Cap torx TX20                      6,3 mm (1/4")                      [00340865]

	<b>⚠️ AVERTISMENT</b>
	<p><b>Aparate grele, masive!</b> Accidentarea spatelui și leziuni musculare</p> <ul style="list-style-type: none"> <li>▶ Operația de demontare a ușii aparatului trebuie efectuată numai de specialiști instruiți.</li> <li>▶ Pentru deplasarea aparatului sunt necesare două persoane.</li> <li>▶ Utilizați numai instrumente și echipamente adecvate.</li> </ul>

	<b>⚠️ ATENȚIONARE</b>
	<p><b>Marginea ascuțită!</b> Rănire prin tăiere</p> <ul style="list-style-type: none"> <li>▶ Purtați mănuși de protecție.</li> </ul>

	<b>⚠️ AVERTISMENT</b>
	<p><b>Alunecarea aparatelor înclinate!</b> Fracturi/zdrobiri</p> <ul style="list-style-type: none"> <li>▶ Fixați aparatele împotriva alunecării.</li> </ul>

	<b>⚠️ ATENȚIONARE</b>
	<p><b>Pericol din cauza pieselor care cad pentru că șuruburile sunt slăbite!</b> Accidente din cauza pieselor care cad.</p> <ul style="list-style-type: none"> <li>▶ Fixați componenta împotriva căderii.</li> </ul>

	<b>ATENȚIE!</b>
	<p><b>Pericol din cauza pieselor care cad pentru că șuruburile sunt slăbite!</b> Deteriorarea altor piese ale aparatului sau a casei clientului, de exemplu, partea de jos.</p> <ul style="list-style-type: none"> <li>▶ Fixați componenta împotriva căderii.</li> </ul>

	<b>⚠️ PERICOL</b>
	<p><b>Pericol de electrocutare din cauza pieselor sub tensiune!</b> Pericol de moarte prin electrocutare în cazul unei reparații necorespunzătoare</p> <ul style="list-style-type: none"> <li>▶ Componentele electrice trebuie reparate de către electricieni calificați.</li> <li>▶ După reparație, este obligatorie efectuarea unei verificări de siguranță conform cu VDE 0701 sau cu reglementările naționale respective.</li> </ul>

	<b>⚠️ PERICOL</b>
	<p><b>Pericol de electrocutare din cauza pieselor sub tensiune!</b> Deces prin electrocutare</p> <ul style="list-style-type: none"> <li>▶ Deconectați aparatele de la sursa de alimentare cu tensiune cu cel puțin 60 de secunde înainte de a începe reparațiile.</li> </ul>

### Cerință:

- ✔️ Aparatul este deconectat de la sursa de energie electrică.
- ✔️ Fitingurile interioare ale aparatului sunt demontate.

### 4.4.1 Demontarea balamalei de sus a ușii

1. Așezați aparatul pe spate.

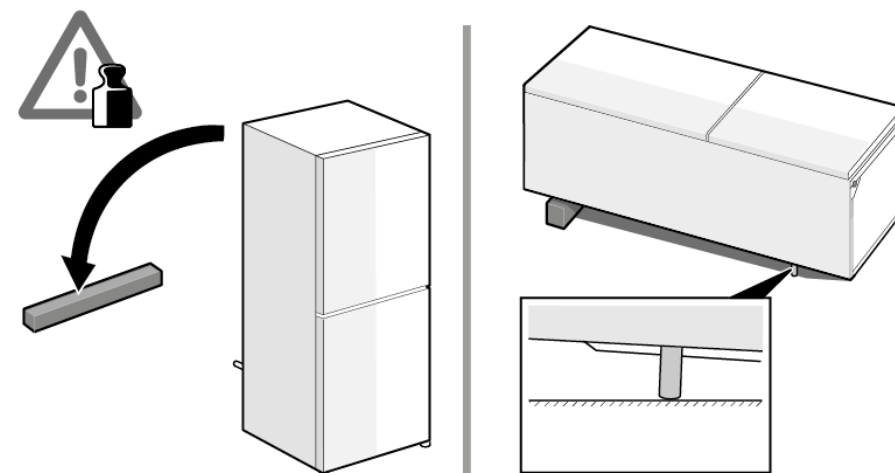

## Repararea

2. 1. Demontați capacul balamalei de sus (1).
2. Demontați capacul cutiei de cabluri (2).
3. Deconectați conexiunea electrică (3).
4. Deșurubați șurubul conexiunii de împământare (4).
5. Demontați protecția cablurilor (5).
6. Deșurubați șurubul (6)

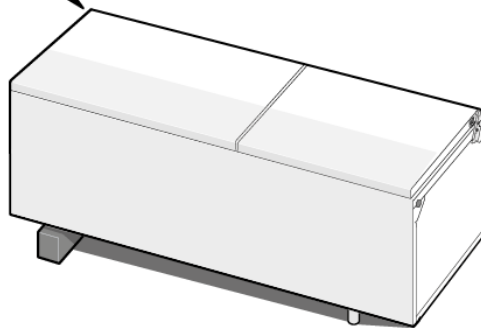
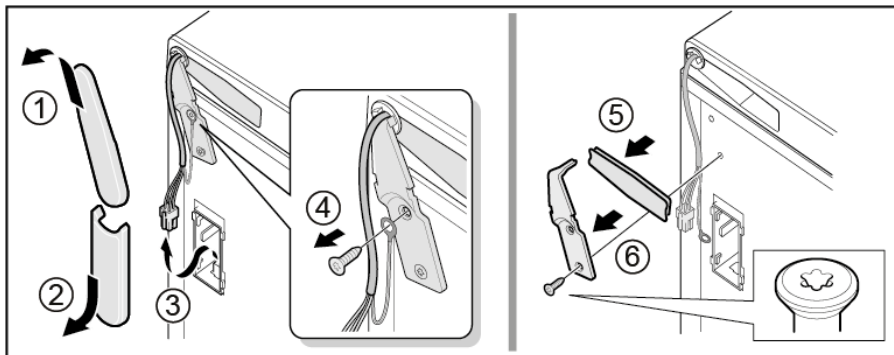

 Balamaua de sus este demontată.

### 4.4.2 Montarea balamalei de sus a ușii

- ▶ Montați urmând procedura de demontare în ordine inversă.

## 4.5 Înlocuirea balamalei din mijloc a ușii

### Scule speciale:

🔩 Cap torx TX20

6,3 mm (1/4")

[00340865]

	<b>⚠️ AVERTISMENT</b>
	<p><b>Aparate grele, masive!</b> Accidentarea spatelui și leziuni musculare</p> <ul style="list-style-type: none"> <li>▶ Operația de demontare a ușii aparatului trebuie efectuată numai de specialiști instruiți.</li> <li>▶ Pentru deplasarea aparatului sunt necesare două persoane.</li> <li>▶ Utilizați numai instrumente și echipamente adecvate.</li> </ul>

	<b>⚠️ ATENȚIONARE</b>
	<p><b>Marginea ascuțită!</b> Rănire prin tăiere</p> <ul style="list-style-type: none"> <li>▶ Purtați mănuși de protecție.</li> </ul>

	<b>⚠️ AVERTISMENT</b>
	<p><b>Alunecarea aparatelor înclinate!</b> Fracturi/zdrobiri</p> <ul style="list-style-type: none"> <li>▶ Fixați aparatele împotriva alunecării.</li> </ul>

	<b>⚠️ ATENȚIONARE</b>
	<p><b>Pericol din cauza pieselor care cad pentru că șuruburile sunt slăbite!</b> Accidente din cauza pieselor care cad.</p> <ul style="list-style-type: none"> <li>▶ Fixați componenta împotriva căderii.</li> </ul>

	<b>ATENȚIE!</b>
	<p><b>Pericol din cauza pieselor care cad pentru că șuruburile sunt slăbite!</b> Deteriorarea altor piese ale aparatului sau a casei clientului, de exemplu, partea de jos.</p> <ul style="list-style-type: none"> <li>▶ Fixați componenta împotriva căderii.</li> </ul>

### Cerință:

- ✅ Aparatul este deconectat de la sursa de energie electrică.
- ✅ Fitingurile interioare ale aparatului sunt demontate.

✅ Balamaua de sus a ușii este demontată.

✅ Ușa de sus este demontată.

### 4.5.1 Demontarea balamalei din mijloc a ușii

- ▶ 1. Scoateți ușa compartimentului frigiderului (1).
- ▶ 2. Deșurubați două șuruburi (2).
- ▶ 3. Scoateți balamaua din mijloc (3).

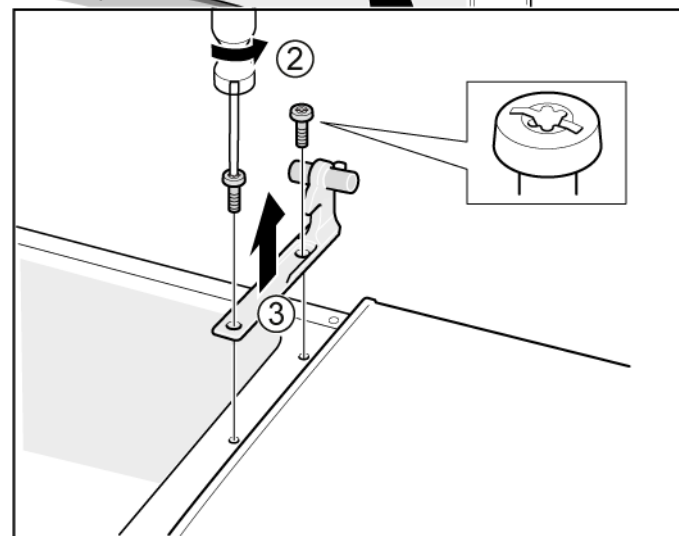
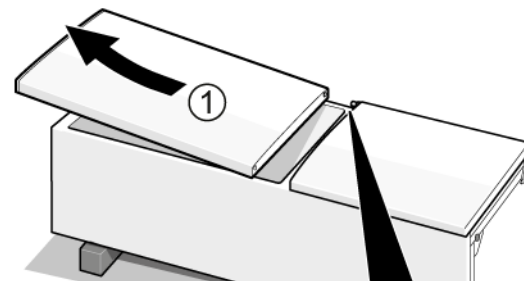

➡ Balamaua din mijloc este demontată.

### 4.5.2 Montarea balamalei din mijloc a ușii

- ▶ Montați urmând procedura de demontare în ordine inversă.





## 4.6 Înlocuirea balamalei de jos a ușii

### Scule speciale:

🔩 Cap torx TX20

6,3 mm (1/4")

[00340865]

	<p><b>⚠️ AVERTISMENT</b></p> <p><b>Aparate grele, masive!</b>          Accidentarea spatelui și leziuni musculare</p> <ul style="list-style-type: none"> <li>▶ Operația de demontare a ușii aparatului trebuie efectuată numai de specialiști instruiți.</li> <li>▶ Pentru deplasarea aparatului sunt necesare două persoane.</li> <li>▶ Utilizați numai instrumente și echipamente adecvate.</li> </ul>
	<p><b>⚠️ ATENȚIONARE</b></p> <p><b>Marginea ascuțită!</b>          Rănire prin tăiere</p> <ul style="list-style-type: none"> <li>▶ Purtați mănuși de protecție.</li> </ul>
	<p><b>⚠️ AVERTISMENT</b></p> <p><b>Alunecarea aparatelor înclinate!</b>          Fracturi/zdrobiri</p> <ul style="list-style-type: none"> <li>▶ Fixați aparatele împotriva alunecării.</li> </ul>
	<p><b>⚠️ ATENȚIONARE</b></p> <p><b>Pericol din cauza pieselor care cad pentru că șuruburile sunt slăbite!</b>          Accidente din cauza pieselor care cad.</p> <ul style="list-style-type: none"> <li>▶ Fixați componenta împotriva căderii.</li> </ul>
	<p><b>⚠️ ATENȚIE!</b></p> <p><b>Pericol din cauza pieselor care cad pentru că șuruburile sunt slăbite!</b>          Deteriorarea altor piese ale aparatului sau a casei clientului, de exemplu, partea de jos.</p> <ul style="list-style-type: none"> <li>▶ Fixați componenta împotriva căderii.</li> </ul>

### Cerință:

- ✔️ Aparatul este deconectat de la sursa de energie electrică.
- ✔️ Fitingurile interioare ale aparatului sunt demontate.

- ✔️ Balamaua de sus este demontată.
- ✔️ Balamaua din mijloc este demontată.

### 4.6.1 Demontarea balamalei de jos a ușii

- ▶ 1. Scoateți ușa compartimentului congelatorului (1).
- ▶ 2. Deșurubați șurubul (2).
- ▶ 3. Rotiți și scoateți balamaua de sus (3).
- ▶ 4. Demontați balamaua de jos (4).

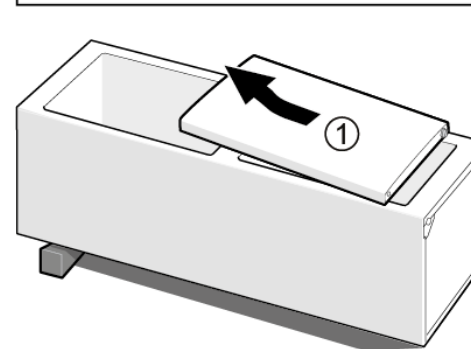
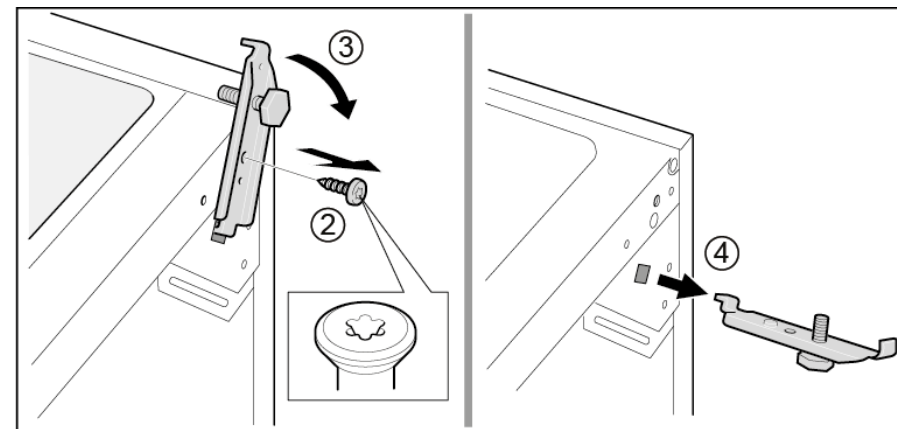

- ➡️ Balamaua de jos a ușii este demontată.

### 4.6.2 Montarea balamalei de jos a ușii

- ▶ Montați urmând procedura de demontare în ordine inversă.

## 4.7 Repoziționarea raftului

### Cerință:

- ✔ Ușa este deschisă.

### 4.7.1 Demontarea raftului

- ▶ Scoateți raftul.

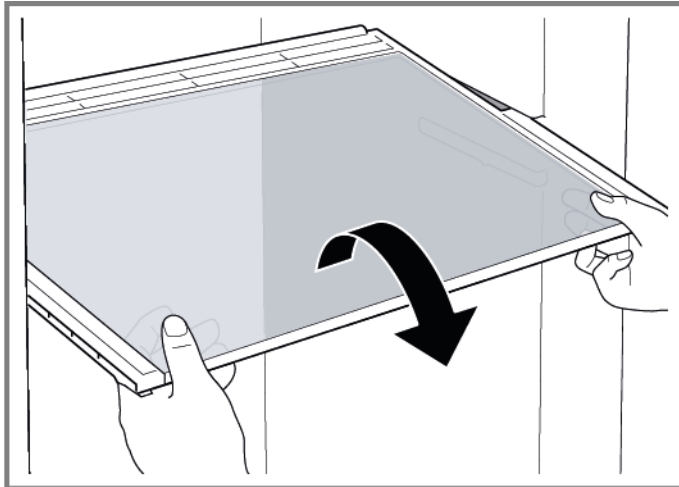

- ➡ Raftul este demontat.

### 4.7.2 Montarea raftului

- ▶ Montați urmând procedura de demontare în ordine inversă.

## 4.8 Repoziționarea raftului variabil

### Cerință:

- ✓ Ușa este deschisă.

### 4.8.1 Demontarea raftului variabil

1. Trageți în față partea din dreapta a raftului variabil (1).
2. Scoateți partea din dreapta a raftului variabil (2).

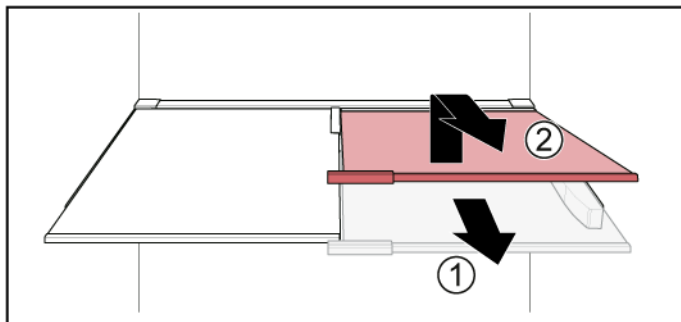

2. Scoateți partea din stânga a raftului variabil în același mod.

➡ Raftul variabil este demontat.

### 4.8.2 Montarea raftului variabil

- ▶ Montați urmând procedura de demontare în ordine inversă.

## 4.9 Repoziționarea raftului flexibil

### Cerință:

- ✔ Ușa este deschisă.

### 4.9.1 Demontarea raftului flexibil

- ▶ 1. Scoateți raftul din sticlă (1).
- ▶ 2. Ridicați raftul flexibil și scoateți-l (2).

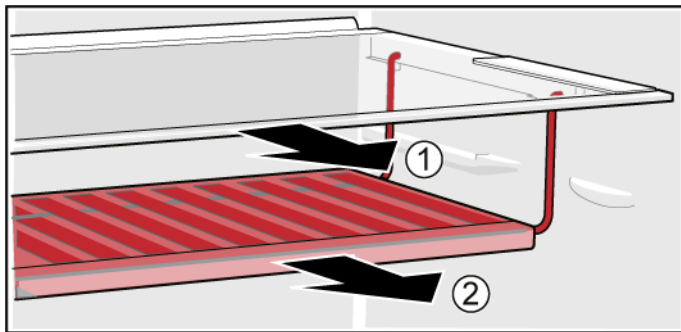

- ➡ Raftul flexibil este demontat.

### 4.9.2 Montarea raftului flexibil

- ▶ Montați urmând procedura de demontare în ordine inversă.

## 4.10 Repoziționarea setului pentru mic dejun

### Cerință:

- ✔ Ușa este deschisă.

### 4.10.1 Demontarea setului pentru mic dejun

- ▶ Ridicați setul pentru mic dejun și scoateți-l.

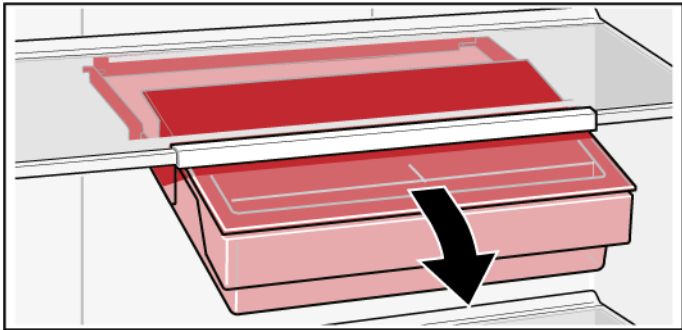

- ➡ Setul pentru mic dejun este demontat.

### 4.10.2 Montarea setului pentru mic dejun

- ▶ Montați urmând procedura de demontare în ordine inversă.

## 4.11 Repoziționarea suportului pentru sticle

### Cerință:

- ✓ Ușa este deschisă.

### 4.11.1 Demontarea suportului pentru sticle

- ▶ Trageți suportul pentru sticle pentru a-l scoate.

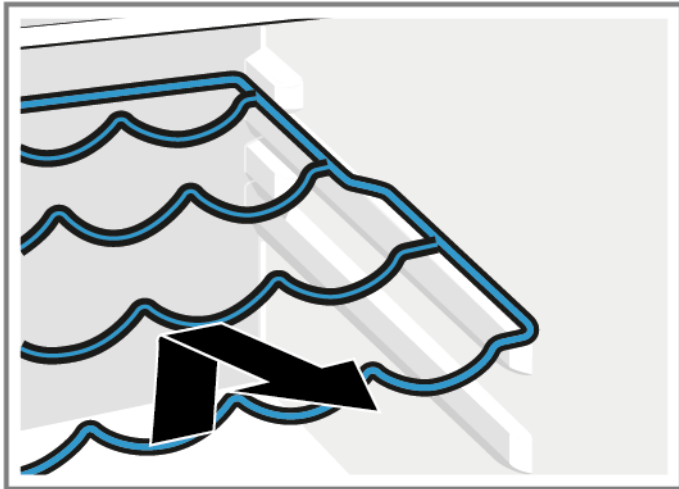

- ➡ Suportul pentru sticle este demontat.

### 4.11.2 Montarea suportului pentru sticle

- ▶ Montați urmând procedura de demontare în ordine inversă.

## 4.12 Repoziționarea raftului pentru ușă

### Cerință:

- ✔ Ușa este deschisă.

### 4.12.1 Demontarea raftului pentru ușă

- ▶ Ridicați raftul pentru ușă.

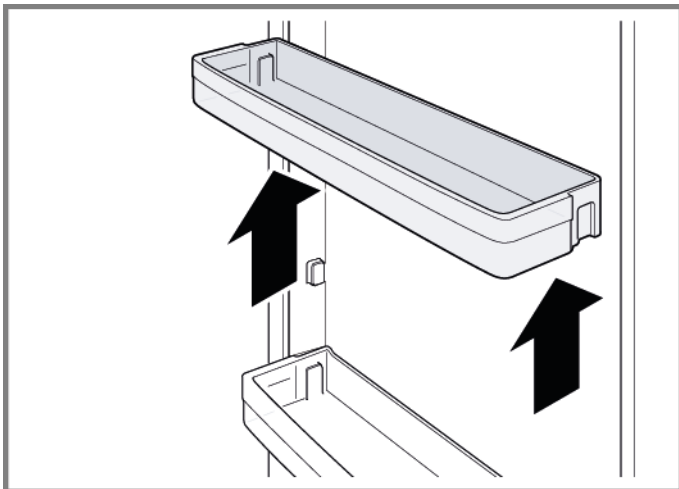

- ➡ Raftul pentru ușă este demontat.

### 4.12.2 Montarea raftului pentru ușă

- ▶ Montați urmând procedura de demontare în ordine inversă.

### 4.13 Repoziționarea containerului pentru alimente înghețate

#### Cerință:

- ✔ Ușa este deschisă.

#### 4.13.1 Demontarea containerului pentru alimente înghețate

- ▶ 1. Extrageți complet containerul pentru alimente înghețate (1).
- ▶ 2. Demontați containerul pentru alimente (2).

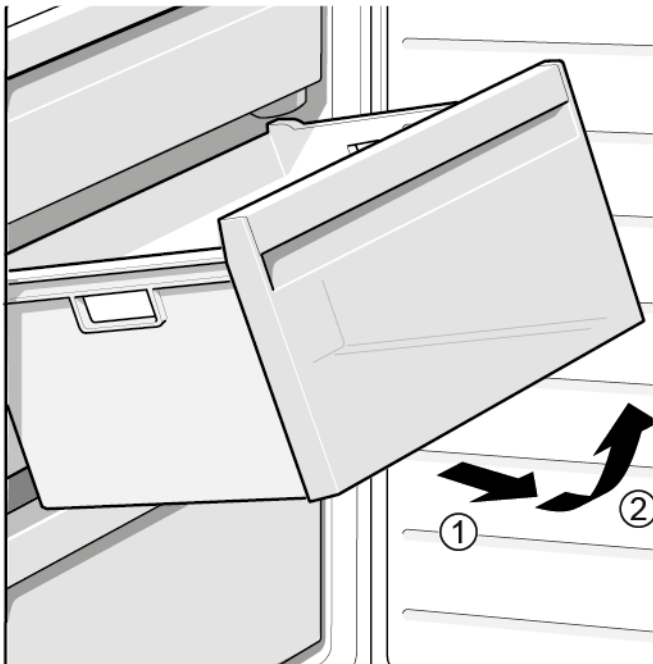

- ➡ Containerul pentru alimente înghețate este demontat.

#### 4.13.2 Montarea containerului pentru alimente înghețate

- ▶ Montați urmând procedura de demontare în ordine inversă.

## 4.14 Repoziționarea containerului

### Cerință:

- ✓ Ușa este deschisă.

### 4.14.1 Demontarea containerului

- ▶ 1. Demontați containerul de jos al frigiderului (1).
- ▶ 2. Demontați containerul de sus al frigiderului (2).

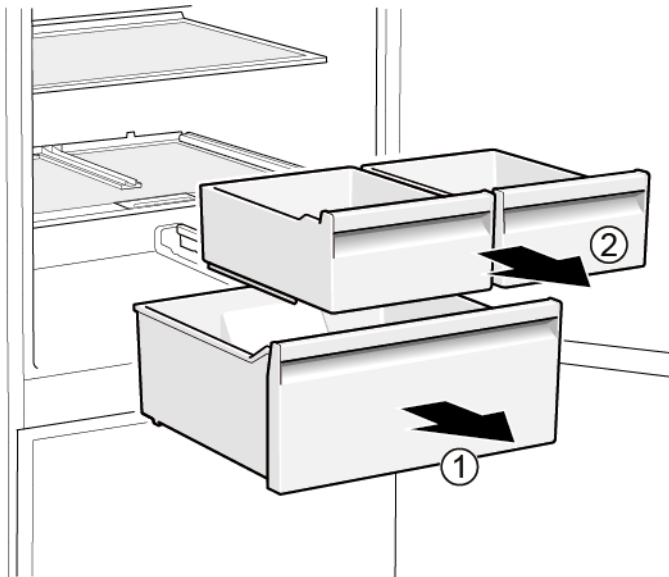

- ➡ Containerele sunt demontate.

### 4.14.2 Montarea containerului

- ▶ Montați urmând procedura de demontare în ordine inversă.

## 4.15 Repoziționarea containerului extensibil

### Cerință:

- ✓ Ușa este deschisă.

### 4.15.1 Demontarea containerului extensibil

- ▶ 1. Extrageți complet containerul extensibil (1).
- ▶ 2. Demontați containerul extensibil (2).

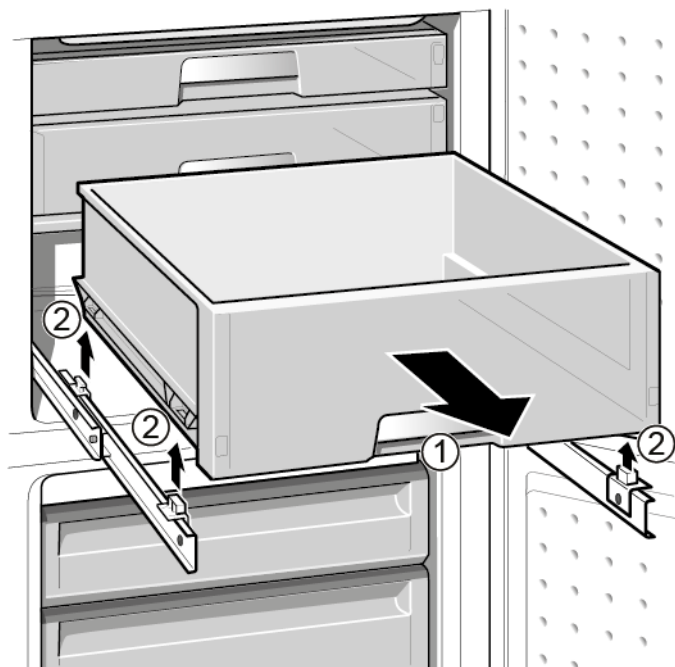

- ➡ Containerul extensibil este demontat.

### 4.15.2 Montarea containerului extensibil

- ▶ Montați urmând procedura de demontare în ordine inversă.

## 4.16 Înlocuirea spotului luminos LED

### Scule speciale:

🔧 Instrument special [00342180]



Aparatul dumneavoastră este echipat cu o lampă LED care nu necesită întreținere.  
Aceste lămpi pot fi înlocuite numai de către departamentul de service pentru clienți sau de către tehnicieni autorizați!



### ⚠️ PERICOL

**Pericol de electrocutare din cauza pieselor sub tensiune!**  
Pericol de moarte prin electrocutare în cazul unei reparații necorespunzătoare

- ▶ Componentele electrice trebuie reparate de către electricieni calificați.
- ▶ După reparație, este obligatorie efectuarea unei verificări de siguranță conform cu VDE 0701 sau cu reglementările naționale respective.



### ⚠️ PERICOL

**Pericol de electrocutare din cauza pieselor sub tensiune!**  
Deces prin electrocutare

- ▶ Deconectați aparatele de la sursa de alimentare cu tensiune cu cel puțin 60 de secunde înainte de a începe reparațiile.



### ⚠️ ATENȚIONARE

**Marginea ascuțite!**  
Rănire prin tăiere

- ▶ Purtați mănuși de protecție.

### Cerință:

- ✔️ Aparatul este deconectat de la sursa de energie electrică.
- ✔️ Ușa este deschisă.

### 4.16.1 Demontarea spotului luminos LED

1. Utilizați instrumentul special pentru a trage spotul luminos LED afară (1).

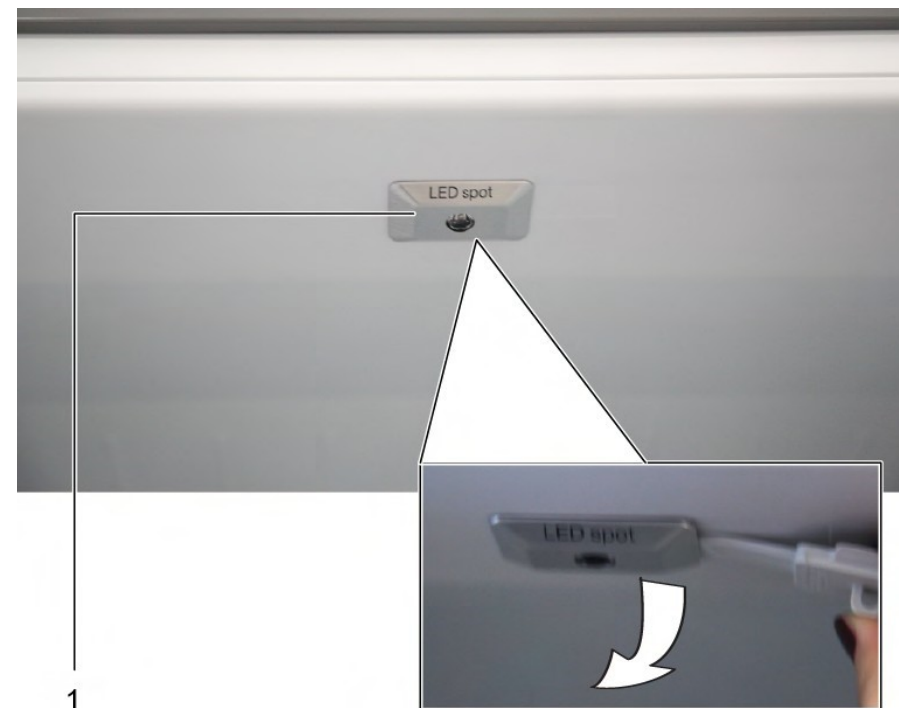

2. Deconectați conexiunile electrice ale spotului luminos LED.
- ➡ Sportul luminos LED este demontat.

### 4.16.2 Montarea spotului luminos LED

- ▶ Montați urmând procedura de demontare în ordine inversă.

## 4.17 Înlocuirea lămpii LED de sus

### Scule speciale:

 Șurubelniță plată

Lamă de 2,4 mm x 0,4 mm x 60 mm,  
în kitul [00341820]



Aparatul dumneavoastră este echipat cu o lampă LED care nu necesită întreținere.

Aceste lămpi pot fi înlocuite numai de către departamentul de service pentru clienți sau de către tehnicieni autorizați!



### PERICOL

#### Pericol de electrocutare din cauza pieselor sub tensiune!

Pericol de moarte prin electrocutare în cazul unei reparații necorespunzătoare

- ▶ Componentele electrice trebuie reparate de către electricieni calificați.
- ▶ După reparație, este obligatorie efectuarea unei verificări de siguranță conform cu VDE 0701 sau cu reglementările naționale respective.



### PERICOL

#### Pericol de electrocutare din cauza pieselor sub tensiune!

Deces prin electrocutare

- ▶ Deconectați aparatele de la sursa de alimentare cu tensiune cu cel puțin 60 de secunde înainte de a începe reparațiile.



### ATENȚIONARE

#### Marginea ascuțite!

Rănire prin tăiere

- ▶ Purtați mănuși de protecție.

### Cerință:

- ✓ Aparatul este deconectat de la sursa de energie electrică.
- ✓ Ușa este deschisă.
- ✓ Fitingurile interioare din partea de sus sunt demontate.

## 4.17.1 Demontarea lămpii LED

1. Deplasați lampa LED spre stânga.

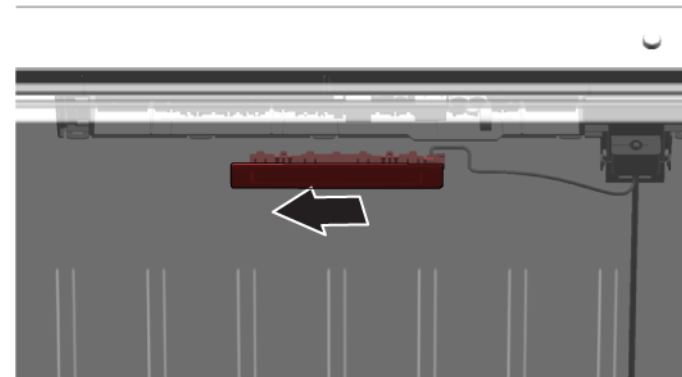

-  Conexiunea electrică a lămpii LED este deconectată.

2. Decuplați cârligele lămpii LED.

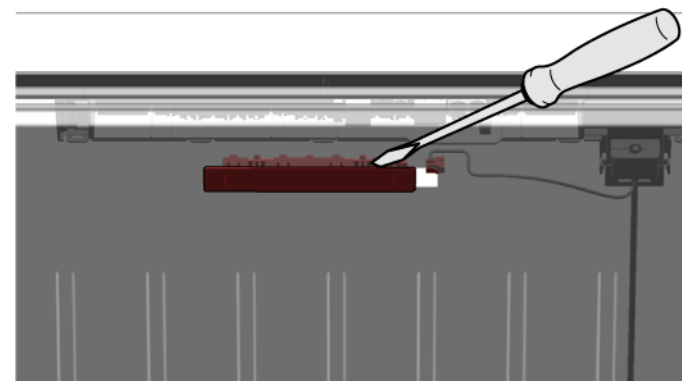

## Repararea

3. Demontați lampa LED deplasând-o în față.

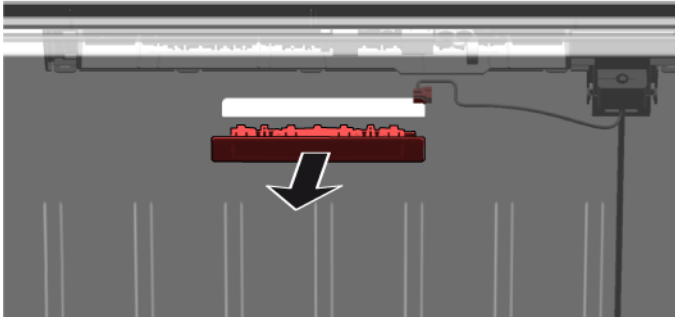

- ➡ Lampa LED este demontată.

### 4.17.2 Montarea lămpii LED de sus

- ▶ Montați urmând procedura de demontare în ordine inversă.

## 4.18 Înlocuirea lămpii LED de pe bara laterală

### Scule speciale:

 Ventuză Ø50 mm [00342224]

	<p>Aparatul dumneavoastră este echipat cu o lampă LED care nu necesită întreținere.</p> <p>Aceste lămpi pot fi înlocuite numai de către departamentul de service pentru clienți sau de către tehnicieni autorizați!</p>
---	---

	<p><b>⚠ PERICOL</b></p> <p><b>Pericol de electrocutare din cauza pieselor sub tensiune!</b> Pericol de moarte prin electrocutare în cazul unei reparații necorespunzătoare</p> <ul style="list-style-type: none"><li>▶ Componentele electrice trebuie reparate de către electricieni calificați.</li><li>▶ După reparație, este obligatorie efectuarea unei verificări de siguranță conform cu VDE 0701 sau cu reglementările naționale respective.</li></ul>
--	---

	<p><b>⚠ PERICOL</b></p> <p><b>Pericol de electrocutare din cauza pieselor sub tensiune!</b> Deces prin electrocutare</p> <ul style="list-style-type: none"><li>▶ Deconectați aparatele de la sursa de alimentare cu tensiune cu cel puțin 60 de secunde înainte de a începe reparațiile.</li></ul>
--	--

	<p><b>⚠ ATENȚIONARE</b></p> <p><b>Marginea ascuțite!</b> Rănire prin tăiere</p> <ul style="list-style-type: none"><li>▶ Purtați mănuși de protecție.</li></ul>
--	--

### Cerință:

- ✔ Aparatul este deconectat de la sursa de energie electrică.
- ✔ Ușa este deschisă.
- ✔ Rafturile din compartimentul frigiderului sunt demontate.

### 4.18.1 Demontarea lămpii LED de pe bara laterală

1. Aplicați ventuză în treimea superioară a lămpii LED de pe bara laterală.



## Repararea

- Trageți în față ventuza cu lampa LED de pe bara laterală, cu o mișcare de rotație.

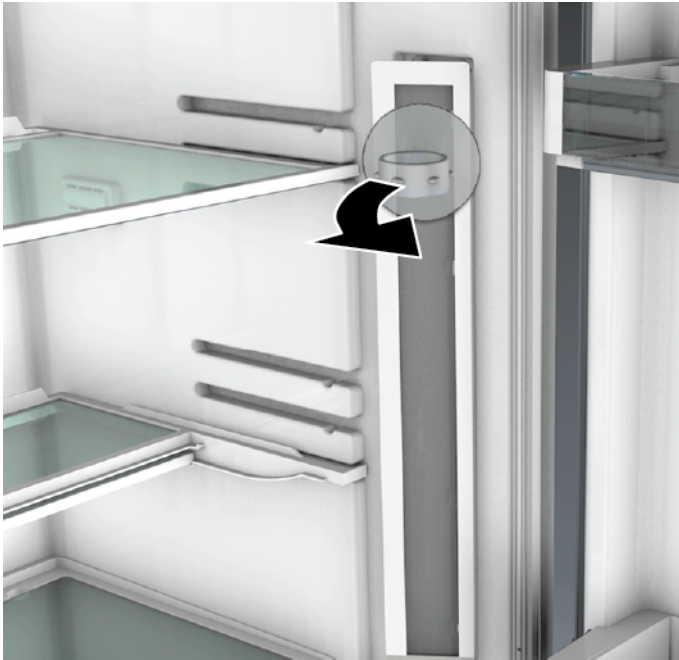





- Deconectați conexiunea electrică a lămpii LED de pe bara laterală.  
➡ Lampa LED de pe bara laterală este demontată.

### 4.18.2 Montarea lămpii LED de pe bara laterală

- Conectați conexiunea electrică a lămpii LED de pe bara laterală.
  - Fixați lampa LED de pe bara laterală în locația sa de pe peretele compartimentului (cârligele se fixează cu un clic).
- ➡ Lampa LED de pe bara laterală este montată.

# Poznámky k opravám - Chladnička s mrazničkou

 <b>O tomto dokumente</b> .....	<b>516</b>		
1.1 Dôležité informácie .....	516		
1.1.1 Účel .....	516		
1.2 Vysvetlenie symbolov .....	516		
1.2.1 Úrovne nebezpečenstva .....	516		
1.2.2 Symboly označujúce riziká .....	516		
1.2.3 Štruktúra varovaní .....	517		
1.2.4 Všeobecné symboly .....	517		
 <b>Bezpečnosť</b> .....	<b>518</b>		
2.1 Všeobecné bezpečnostné pokyny .....	518		
2.1.1 Všetky domáce spotrebiče .....	518		
 <b>Nástroje a pomôcky</b> .....	<b>519</b>		
 <b>Oprava</b> .....	<b>520</b>		
4.1 Výmena tesnenia dvierok .....	520		
4.2 Výmena dverovej úchytky .....	521		
4.2.1 Odoberanie dverovej úchytky .....	521		
4.2.2 Montáž dverovej úchytky .....	521		
4.3 Výmena horného závesu dverí .....	522		
4.3.1 Odoberanie horného závesu dvierok .....	522		
4.3.2 Montáž horného závesu dvierok .....	523		
4.4 Výmena horného závesu dvierok (dvierka s displejom) .....	524		
4.4.1 Odoberanie horného závesu dvierok .....	524		
4.4.2 Montáž horného závesu dvierok .....	525		
4.5 Výmena prostredného závesu dverí .....	526		
4.5.1 Odoberanie prostredného závesu dverí .....	526		
4.5.2 Montáž prostredného závesu dverí .....	526		
4.6 Výmena spodného závesu dvierok .....	527		
4.6.1 Odoberanie spodného závesu dverí .....	527		
4.6.2 Montáž spodného závesu dvierok .....	527		
4.7 Výmena odkladacej plochy .....	528		
4.7.1 Odobratie odkladacej plochy .....	528		
4.7.2 Montáž odkladacej plochy .....	528		
4.8 Výmena odkladacej plochy variable .....	529		
4.8.1 Odobratie odkladacej plochy variable .....	529		
4.8.2 Montáž odkladacej plochy variable .....	529		
4.9 Výmena odkladacej plochy flexible .....	530		
4.9.1 Odobratie odkladacej plochy flexible .....	530		
4.9.2 Montáž odkladacej plochy flexible .....	530		
4.10 Výmena raňajkovej sady .....	531		
4.10.1 Odobratie raňajkovej sady .....	531		
4.10.2 Montáž raňajkovej sady .....	531		
4.11 Výmena odkladacieho priestoru na fľaše .....	532		
4.11.1 Odobratie odkladacieho priestoru na fľaše .....	532		
4.11.2 Montáž odkladacieho priestoru na fľaše .....	532		
4.12 Výmena poličky v dvierkach .....	533		
4.12.1 Odobratie poličky v dvierkach .....	533		
4.12.2 Montáž poličky do dvierok .....	533		
4.13 Výmena nádoby na zmrazené potraviny .....	534		
4.13.1 Odobratie nádoby na zmrazené potraviny .....	534		
4.13.2 Montáž nádoby na zmrazené potraviny .....	534		
4.14 Výmena nádoby .....	535		
4.14.1 Odobratie nádoby .....	535		
4.14.2 Montáž nádoby .....	535		
4.15 Výmena výsuvnej nádoby .....	536		
4.15.1 Odobratie výsuvnej nádoby .....	536		
4.15.2 Montáž výsuvnej nádoby .....	536		
4.16 Výmena bodového LED svetla .....	537		
4.16.1 Odoberanie bodového LED svetla .....	537		
4.16.2 Montáž bodového LED svetla .....	537		
4.17 Výmena horného LED svetla .....	538		
4.17.1 Odobratie LED osvetlenia .....	538		
4.17.2 Montáž horného LED svetla .....	539		
4.18 Výmena bočného pásového LED svetla .....	540		
4.18.1 Odobratie bočného pásového LED svetla .....	540		
4.18.2 Montáž bočného pásového LED svetla .....	541		

# **i** O tomto dokumente

## 1.1 Dôležité informácie

### 1.1.1 Účel

Tieto pokyny pre opravu pomáhajú spotrebiteľovi pri vlastnej oprave spotrebičov podľa nariadenia o ekodizajne (z marca 2021).

Obsahujú informácie o výmene určených náhradných dielov vrátane varovaní a rizík.

Ak máte otázky, kontaktujte náš zákaznícky servis. Za poškodenia ručíme len vtedy, ak pokyny boli dodržané správne.

## 1.2 Vysvetlenie symbolov

### 1.2.1 Úrovne nebezpečenstva

Úroveň varovania obsahuje symbol a signalizačné slovo. Signalizačné slovo naznačuje mieru nebezpečenstva.





Úroveň varovania	Význam
 <b>NEBEZPEČENSTVO</b>	Následkom nerešpektovania varovného hlásenia je úmrtie alebo vážne zranenia.
 <b>VAROVANIE</b>	Možným následkom nerešpektovania varovného hlásenia je úmrtie alebo vážne zranenia.
 <b>UPOZORNENIE</b>	Možným následkom nerešpektovania varovného hlásenia sú mierne zranenia.
<b>POZOR!</b>	Možným následkom nerešpektovania varovného hlásenia je poškodenie majetku.

Tabuľka 1: Úrovne nebezpečenstva



### 1.2.2 Symboly označujúce riziká

Symboly označujúce riziká sú symbolické znázornenia, ktoré naznačujú druh nebezpečenstva.

V tomto dokumente sa používajú nasledujúce symboly označujúce riziká:

Symbol označujúci riziko	Význam
	Všeobecné varovné hlásenie
	Nebezpečenstvo v súvislosti s elektrickým napätím
	Nebezpečenstvo výbuchu
	Nebezpečenstvo porezania
	Nebezpečenstvo pomliaždenia

## i O tomto dokumente

Symbol označujúci riziko	Význam
	Nebezpečenstvo v súvislosti s horúcimi povrchmi
	Nebezpečenstvo v súvislosti s magnetickým poľom
	Nebezpečenstvo v súvislosti s neionizujúcou radiáciou

Tabuľka 2: Symboly označujúce riziká

### 1.2.3 Štruktúra varovaní

Varovania v tomto dokumente majú štandardný vzhľad a štandardnú štruktúru.



	<p><b>⚠ NEBEZPEČENSTVO</b></p> <p><b>Druh a zdroj nebezpečenstva!</b> Možné následky pri ignorovaní nebezpečenstva/varovania.</p> <ul style="list-style-type: none"> <li>▶ Opatrenia a zákazy na zabránenie nebezpečenstvu.</li> </ul>
--	--





Nasledujúci príklad znázorňuje varovanie pred zásahom elektrickým prúdom pri dotyku s časťami pod napätím. Je uvedené opatrenie na predídenie nebezpečenstvu.

	<p><b>⚠ NEBEZPEČENSTVO</b></p> <p><b>Nebezpečenstvo úrazu elektrickým prúdom pri dotyku s časťami pod napätím!</b> Úmrtie v dôsledku zásahu elektrickým prúdom</p> <ul style="list-style-type: none"> <li>▶ Odpojte spotrebiče od elektrického zdroja aspoň 60 sekúnd pred začiatkom opráv.</li> </ul>
---	--

### 1.2.4 Všeobecné symboly

V tomto dokumente sa používajú nasledujúce všeobecné symboly:

Všeob. symbol	Význam
	Označenie špeciálneho pokynu (textové a/alebo grafické)
	Označenie jednoduchého pokynu (len textové)

Všeob. symbol	Význam
	Označenie prepojenia na videonávod
	Označenie požadovaných nástrojov
	Označenie požadovaných podmienok
	Označenie podmienky (ak ..., potom ...)
	Označenie výsledku
[Spustenie]	Označenie klávesu alebo tlačidla
[00123456]	Označenie čísla materiálu
Stav	Označenie zobrazeného textu/okna (na displeji spotrebiča)

Tabuľka 3: Všeobecné symboly

## **2.1 Všeobecné bezpečnostné pokyny**

### **2.1.1 Všetky domáce spotrebiče**

#### **Nebezpečenstvo úrazu elektrickým prúdom pri dotyku s časťami pod napätím!**

- Chyby pri opravách na elektrických komponentoch môžu spôsobiť zásah elektrickým prúdom!
- Odpojte spotrebič od elektrickej siete aspoň 60 sekúnd pred začiatkom práce.
- Po oprave zariadenia vykonajte bezpečnostný test v súlade s nariadením VDE 0701 alebo s miestnymi nariadeniami.

#### **Riziko poranenia na ostrých hranách!**

- Noste ochranné rukavice.

#### **Riziko pomliaždenia počas opravy, údržby, riešenia problémov a servisu na ťažkých a pohybujúcich sa komponentoch**

- Noste ochrannú obuv.
- Zaisťte ťažké komponenty proti pádu.
- Nesiahajte končatinami do pohybujúcich sa komponentov.

#### **Riziko ohrozenia bezpečnosti/funkčnosti spotrebiča!**

- Používajte len originálne náhradné diely.

#### **Riziko poškodenia elektrostaticky citlivých komponentov (ESD)!**

- Nedotýkajte sa modulov vrátane prípojok a vedení vodičov.

## Nástroje a pomôcky

Označenie	Detaily	Snímky
Ochranná látka [00342013]	60 cm x 50 cm	
Súprava presných skrutkovačov [00341820]	9 kusov, 2,0 mm, 2,4 mm, 3,0 mm, PH0, PH00, PH1, TX6, TX8, TX9	
Pomocný nástroj [00342180]	Nástroj na uvoľnenie plastových častí "magic tool"	
Prísavný držiak [00342224]	Ø 50 mm	
Bit Torx TX20 [00340865]	6,3 mm (1/4")	
Plochý skrutkovač	Čepeľ 10 mm x 1,6 mm x 200 mm	



## 4.1 Výmena tesnenia dvierok

### Požiadavka:



- Dvierka sú otvorené.

## 4.2 Výmena dverovej úchytky

### Špeciálne nástroje:

-  Bit Torx TX20                      6,3 mm (1/4")                      [00340865]
-  Plochý skrutkovač                      Čepel' 10 mm x 1,6 mm x 200 mm

### Požiadavka:

-  Spotrebič je odpojený od elektrického napájania.
-  Dvierka sú otvorené.

### 4.2.1 Odoberanie dverovej úchytky

- ▶ 1. Odoberte dve krytky skrutiek (1).
- ▶ 2. Odskrutkujte dve skrutky (2).
- ▶ 3. Odoberte dverovú úchytку (3).

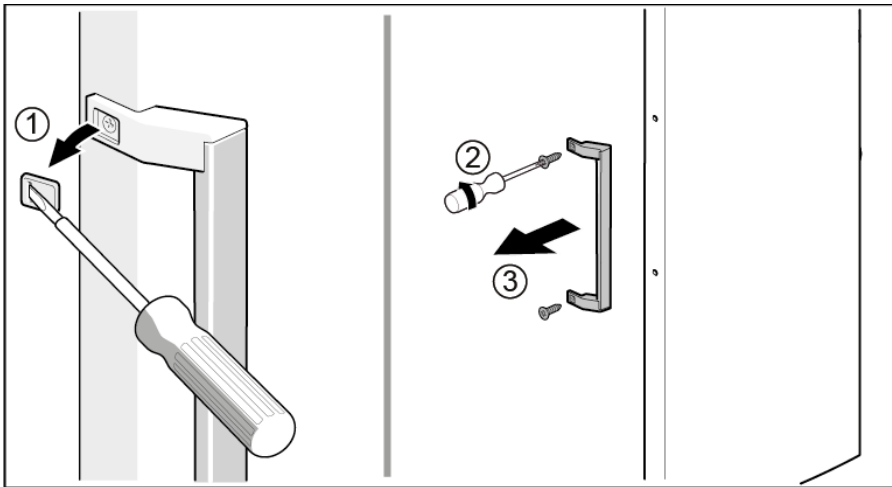

 Dverová úchytka je odobratá.



Dverová úchytka druhých dvierok sa dá odobrať rovnakým spôsobom.

### 4.2.2 Montáž dverovej úchytky

- ▶ Pri montáži postupujte v opačnom poradí krokov demontáže.

### 4.3 Výmena horného závesu dverí

Špeciálne nástroje:

 Bit Torx TX20      6,3 mm (1/4")      [00340865]

	<p style="text-align: center;"><b>VAROVANIE</b></p> <p><b>Ťažké, objemné spotrebiče!</b> Poranenie chrbta a svalov</p> <ul style="list-style-type: none"> <li>▶ Proces odoberania dverí spotrebiča by mal vykonávať školený odborník.</li> <li>▶ Na presunutie spotrebiča sa vyžadujú dve osoby.</li> <li>▶ Použite vhodné nástroje a vybavenie.</li> </ul>
--	---



	<p style="text-align: center;"><b>UPOZORNENIE</b></p> <p><b>Ostré hrany!</b> Rezné poranenia</p> <ul style="list-style-type: none"> <li>▶ Noste ochranné rukavice.</li> </ul>
--	---

	<p style="text-align: center;"><b>VAROVANIE</b></p> <p><b>Zošmyknutie naklonených spotrebičov!</b> Zlomeniny/pomliaždenia</p> <ul style="list-style-type: none"> <li>▶ Zaistite spotrebiče proti zošmyknutiu.</li> </ul>
--	--

	<p style="text-align: center;"><b>UPOZORNENIE</b></p> <p><b>Riziko pádu dielov po uvoľnení skrutiek!</b> Zranenie padajúcimi dielmi.</p> <ul style="list-style-type: none"> <li>▶ Zaistite komponent proti pádu.</li> </ul>
---	---

	<p style="text-align: center;"><b>POZOR!</b></p> <p><b>Riziko pádu dielov po uvoľnení skrutiek!</b> Poškodenie iných častí spotrebiča alebo domácnosti zákazníka, napr. podlahy.</p> <ul style="list-style-type: none"> <li>▶ Zaistite komponent proti pádu.</li> </ul>
--	---

Požiadavka:

-  Spotrebič je odpojený od elektrického napájania.
-  Tvarovky z interiéru spotrebiča sú odobraté.

#### 4.3.1 Odoberanie horného závesu dverí

1. Spotrebič dajte na zadnú stranu.

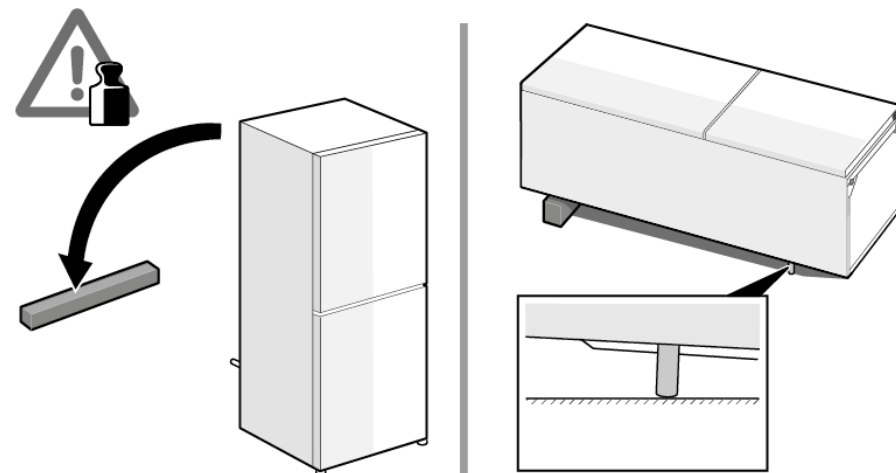

## Oprava

2. 1. Na oboch stranách stlačte kryt horného závesu (1).
2. Vytiahnite kryt horného závesu (2).
3. Otočte kryt závesu (3).
4. Odoberte kryt horného závesu (4).
5. Odskrutkujte dve skrutky (5).
6. Odoberte horný záves (6)

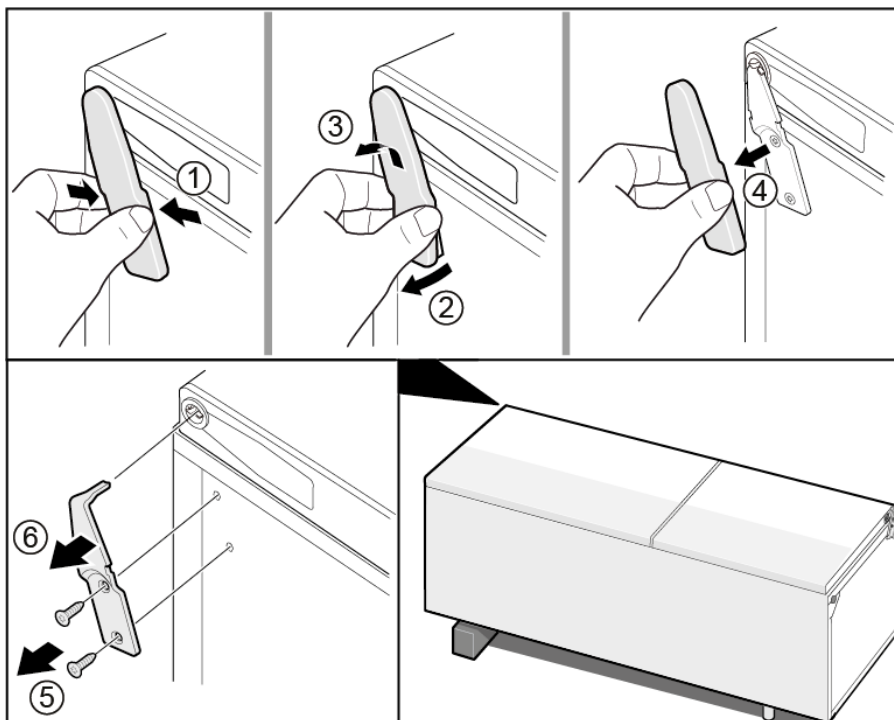

 Horný záves je odobratý.

### 4.3.2 Montáž horného závesu dvierok

- ▶ Pri montáži postupujte v opačnom poradí krokov demontáže.

## 4.4 Výmena horného závesu dvierok (dvierka s displejom)

Špeciálne nástroje:

 Bit Torx TX20      6,3 mm (1/4")      [00340865]

	<b>VAROVANIE</b>
	<p><b>Ťažké, objemné spotrebiče!</b> Poranenie chrbta a svalov</p> <ul style="list-style-type: none"> <li>▶ Proces odoberania dvierok spotrebiča by mal vykonávať školený odborník.</li> <li>▶ Na presunutie spotrebiča sa vyžadujú dve osoby.</li> <li>▶ Použite vhodné nástroje a vybavenie.</li> </ul>

	<b>UPOZORNENIE</b>
	<p><b>Ostré hrany!</b> Rezné poranenia</p> <ul style="list-style-type: none"> <li>▶ Noste ochranné rukavice.</li> </ul>

	<b>VAROVANIE</b>
	<p><b>Zošmyknutie naklonených spotrebičov!</b> Zlomeniny/pomliaždenia</p> <ul style="list-style-type: none"> <li>▶ Zaistite spotrebiče proti zošmyknutiu.</li> </ul>



	<b>UPOZORNENIE</b>
	<p><b>Riziko pádu dielov po uvoľnení skrutiek!</b> Zranenie padajúcimi dielmi.</p> <ul style="list-style-type: none"> <li>▶ Zaistite komponent proti pádu.</li> </ul>

	<b>POZOR!</b>
	<p><b>Riziko pádu dielov po uvoľnení skrutiek!</b> Poškodenie iných častí spotrebiča alebo domácnosti zákazníka, napr. podlahy.</p> <ul style="list-style-type: none"> <li>▶ Zaistite komponent proti pádu.</li> </ul>

	<b>NEBEZPEČENSTVO</b>
	<p><b>Nebezpečenstvo úrazu elektrickým prúdom pri dotyku s časťami pod napätím!</b> Ohrozenie života spôsobené elektrickým zásahom v prípade nesprávnej opravy</p> <ul style="list-style-type: none"> <li>▶ Elektrické diely má opravovať kvalifikovaný elektrikár.</li> <li>▶ Po oprave zariadenie vykonanie bezpečnostného testu v súlade s nariadením VDE 0701 alebo s miestnymi nariadeniami.</li> </ul>

	<b>NEBEZPEČENSTVO</b>
	<p><b>Nebezpečenstvo úrazu elektrickým prúdom pri dotyku s časťami pod napätím!</b> Úmrtie v dôsledku zásahu elektrickým prúdom</p> <ul style="list-style-type: none"> <li>▶ Odpojte spotrebiče od elektrického zdroja aspoň 60 sekúnd pred začiatkom opráv.</li> </ul>

**Požiadavka:**

-  Spotrebič je odpojený od elektrického napájania.
-  Tvarovky z interiéru spotrebiča sú odobraté.

### 4.4.1 Odoberanie horného závesu dvierok

- Spotrebič dajte na zadnú stranu.

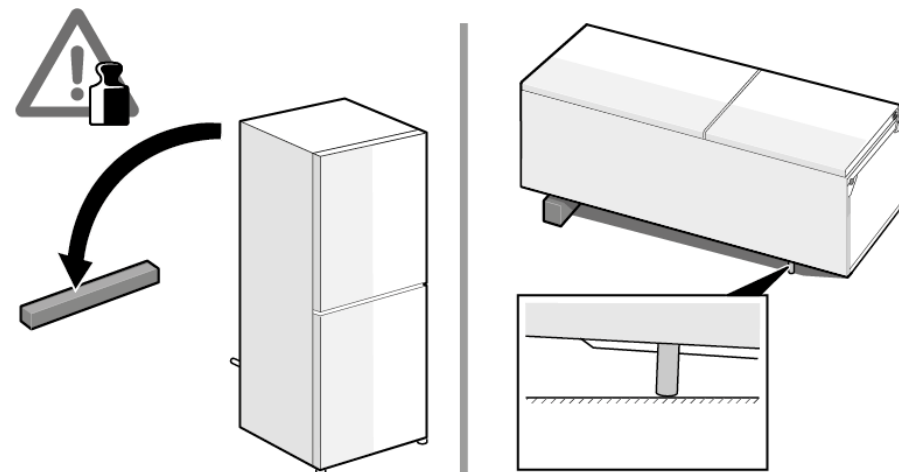

2. 1. Odoberte kryt horného závesu (1).
2. Odoberte kryt priestoru na káble (2).
3. Odpojte elektrické pripojenie (3).
4. Odskrutkujte skrutku uzemňovacieho pripojenia (4).
5. Odoberte ochranu kábla (5).
6. Odskrutkujte skrutku (6)

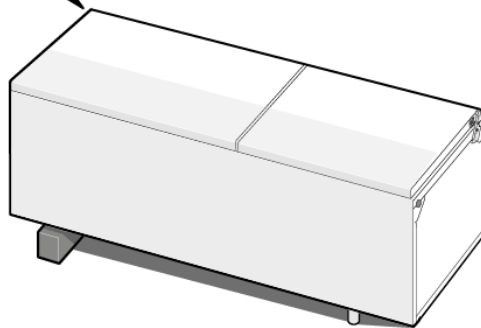
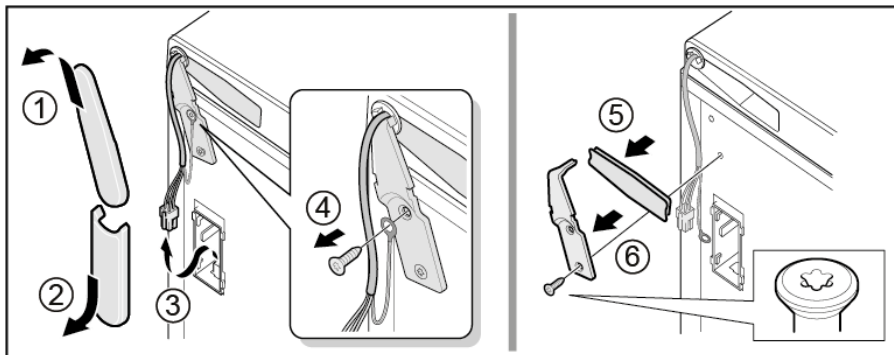

 Horný záves je odobratý.

### 4.4.2 Montáž horného závesu dverok

- ▶ Pri montáži postupujte v opačnom poradí krokov demontáže.

## 4.5 Výmena prostredného závesu dverí

Špeciálne nástroje:

 Bit Torx TX20      6,3 mm (1/4")      [00340865]

	<b>VAROVANIE</b>
	<p><b>Ťažké, objemné spotrebiče!</b> Poranenie chrbta a svalov</p> <ul style="list-style-type: none"> <li>▶ Proces odobrania dvierok spotrebiča by mal vykonávať školený odborník.</li> <li>▶ Na presunutie spotrebiča sa vyžadujú dve osoby.</li> <li>▶ Použite vhodné nástroje a vybavenie.</li> </ul>



	<b>UPOZORNENIE</b>
	<p><b>Ostré hrany!</b> Rezné poranenia</p> <ul style="list-style-type: none"> <li>▶ Noste ochranné rukavice.</li> </ul>

	<b>VAROVANIE</b>
	<p><b>Zošmyknutie naklonených spotrebičov!</b> Zlomeniny/pomliaždenia</p> <ul style="list-style-type: none"> <li>▶ Zaistite spotrebiče proti zošmyknutiu.</li> </ul>

	<b>UPOZORNENIE</b>
	<p><b>Riziko pádu dielov po uvoľnení skrutiek!</b> Zranenie padajúcimi dielmi.</p> <ul style="list-style-type: none"> <li>▶ Zaistite komponent proti pádu.</li> </ul>

	<b>POZOR!</b>
	<p><b>Riziko pádu dielov po uvoľnení skrutiek!</b> Poškodenie iných častí spotrebiča alebo domácnosti zákazníka, napr. podlahy.</p> <ul style="list-style-type: none"> <li>▶ Zaistite komponent proti pádu.</li> </ul>

**Požiadavka:**

-  Spotrebič je odpojený od elektrického napájania.
-  Tvarovky z interiéru spotrebiča sú odobraté.
-  Horný záves dvierok je odobratý.

 Horné dvierka sú odobraté.

### 4.5.1 Odoberanie prostredného závesu dverí

- ▶ 1. Odoberte dvierka z chladiaceho priestoru (1).
- ▶ 2. Odskrutkujte dve skrutky (2).
- ▶ 3. Odoberte prostredný záves (3).

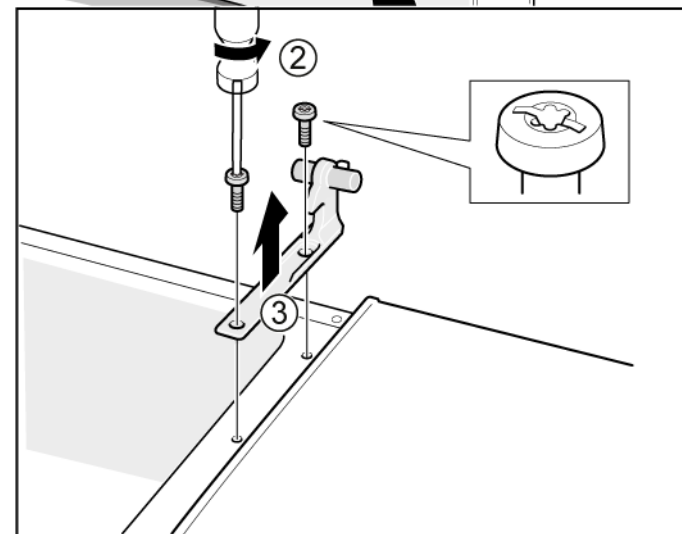
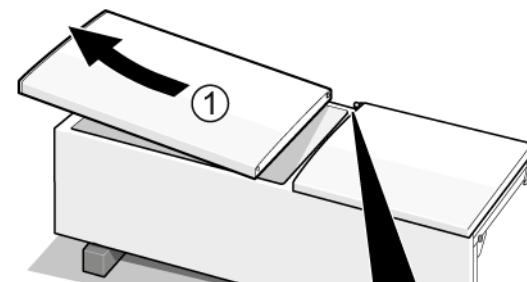

 Prostredný záves je odobratý.

### 4.5.2 Montáž prostredného závesu dverí

- ▶ Pri montáži postupujte v opačnom poradí krokov demontáže.

## 4.6 Výmena spodného závesu dvierok

### Špeciálne nástroje:

Bit Torx TX20 6,3 mm (1/4") [00340865]

	<b>VAROVANIE</b>
	<p><b>Ťažké, objemné spotrebiče!</b> Poranenie chrbta a svalov</p> <ul style="list-style-type: none"> <li>▶ Proces odobrania dvierok spotrebiča by mal vykonávať školený odborník.</li> <li>▶ Na presunutie spotrebiča sa vyžadujú dve osoby.</li> <li>▶ Použite vhodné nástroje a vybavenie.</li> </ul>

	<b>UPOZORNENIE</b>
	<p><b>Ostré hrany!</b> Rezné poranenia</p> <ul style="list-style-type: none"> <li>▶ Noste ochranné rukavice.</li> </ul>

	<b>VAROVANIE</b>
	<p><b>Zošmyknutie naklonených spotrebičov!</b> Zlomeniny/pomliaždenia</p> <ul style="list-style-type: none"> <li>▶ Zaistite spotrebiče proti zošmyknutiu.</li> </ul>

	<b>UPOZORNENIE</b>
	<p><b>Riziko pádu dielov po uvoľnení skrutiek!</b> Zranenie padajúcimi dielmi.</p> <ul style="list-style-type: none"> <li>▶ Zaistite komponent proti pádu.</li> </ul>

	<b>POZOR!</b>
	<p><b>Riziko pádu dielov po uvoľnení skrutiek!</b> Poškodenie iných častí spotrebiča alebo domácnosti zákazníka, napr. podlahy.</p> <ul style="list-style-type: none"> <li>▶ Zaistite komponent proti pádu.</li> </ul>

### Požiadavka:

- ✔ Spotrebič je odpojený od elektrického napájania.
- ✔ Tvarovky z interiéru spotrebiča sú odobraté.
- ✔ Horný záves je odobratý.

✔ Prostredný záves je odobratý.

### 4.6.1 Odoberanie spodného závesu dverí

- ▶ 1. Odoberte dverka z mraziaceho priestoru (1).
- ▶ 2. Odskrutkujte skrutku (2).
- ▶ 3. Otočením vyberte spodný záves (3).
- ▶ 4. Odoberte spodný záves (4).

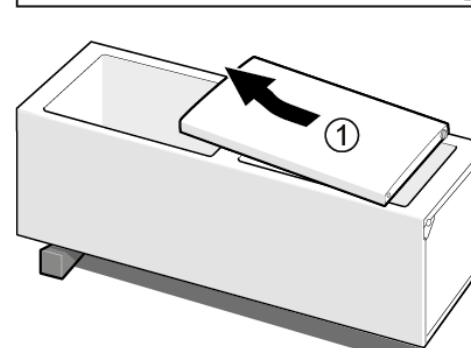
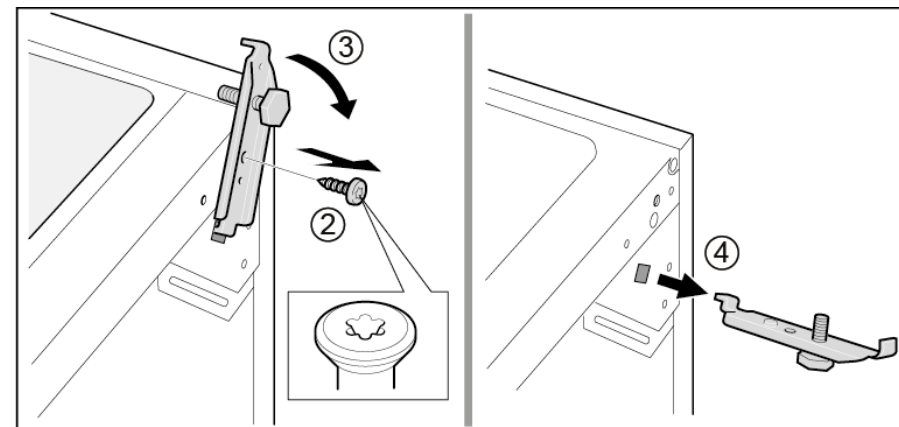

➡ Spodný záves dvierok je odobratý.

### 4.6.2 Montáž spodného závesu dvierok

- ▶ Pri montáži postupujte v opačnom poradí krokov demontáže.

## 4.7 Výmena odkladacej plochy

### Požiadavka:

- ✔ Dvierka sú otvorené.

### 4.7.1 Odobratie odkladacej plochy

- ▶ Vytiahnite odkladaciu plochu.

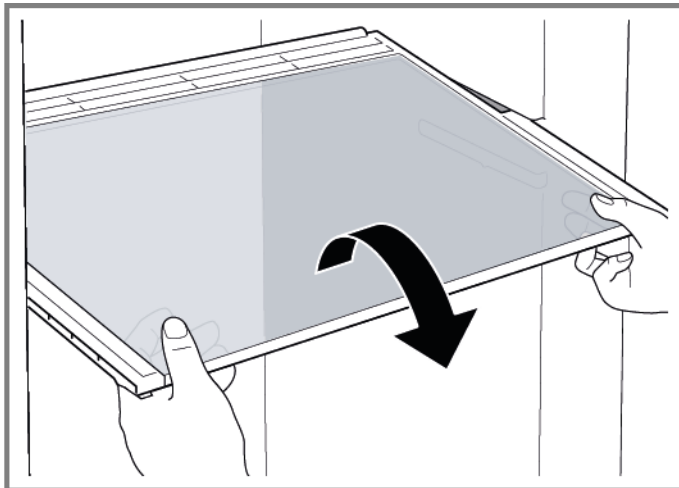

- ➡ Odkladacia plocha je odobratá.

### 4.7.2 Montáž odkladacej plochy

- ▶ Pri montáži postupujte v opačnom poradí krokov demontáže.

## 4.8 Výmena odkladacej plochy variable

### Požiadavka:

- ✓ Dvierka sú otvorené.

### 4.8.1 Odobratie odkladacej plochy variable

1. Potiahnite časť odkladacej plochy variable po pravej ruke (1).
2. Odoberte časť odkladacej plochy variable po pravej ruke (2).

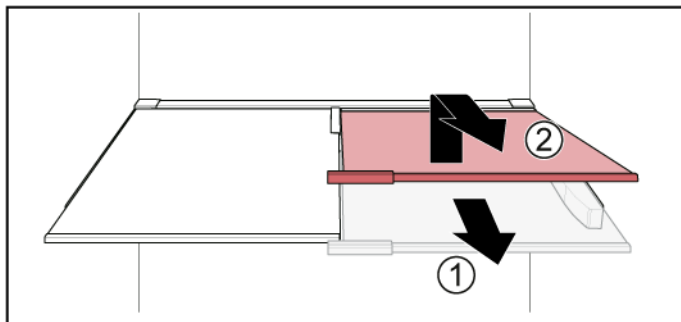

2. Odoberte časť odkladacej plochy variable po ľavej ruke rovnakým spôsobom.

- ➡ Odkladacia plocha variable je odobraná.

### 4.8.2 Montáž odkladacej plochy variable

- ▶ Pri montáži postupujte v opačnom poradí krokov demontáže.

## 4.9 Výmena odkladacej plochy flexible

### Požiadavka:

- ✔ Dvierka sú otvorené.

### 4.9.1 Odoberanie odkladacej plochy flexible

- ▶ 1. Odoberte sklenenú policu (1).
- ▶ 2. Zdvihnite odkladaciu plochu flexible a vytiahnite ju (2).

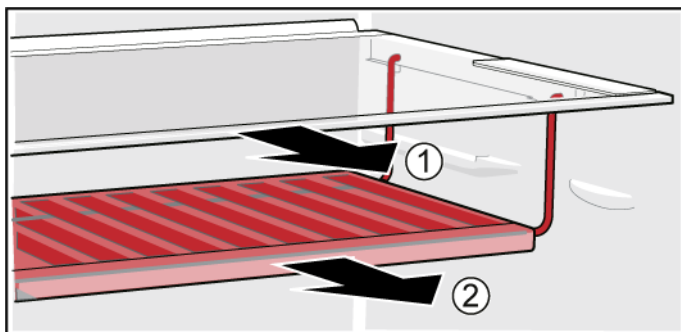

- ➡ Odkladacia plocha flexible je odobratá.

### 4.9.2 Montáž odkladacej plochy flexible

- ▶ Pri montáži postupujte v opačnom poradí krokov demontáže.

## 4.10 Výmena raňajkovej sady

### Požiadavka:

- ✔ Dvierka sú otvorené.

### 4.10.1 Odobratie raňajkovej sady

- ▶ Raňajkovú sadu nadvihnite a vysuňte ju.

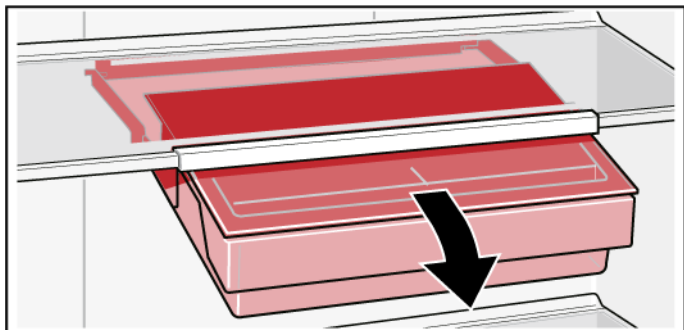

- ➡ Raňajková sada je odobratá.

### 4.10.2 Montáž raňajkovej sady

- ▶ Pri montáži postupujte v opačnom poradí krokov demontáže.

## 4.11 Výmena odkladacieho priestoru na fľaše

### Požiadavka:

- ✔ Dvierka sú otvorené.

### 4.11.1 Odobratie odkladacieho priestoru na fľaše

- ▶ Vytiahnite odkladací priestor na fľaše.

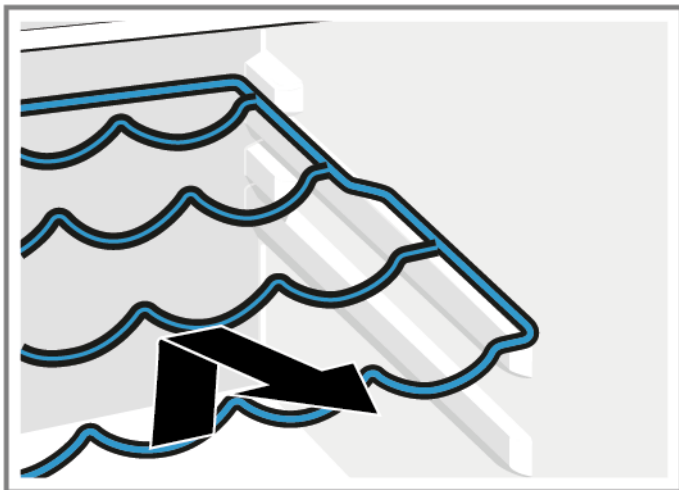

- ➡ Odkladací priestor na fľaše je odobratý.

### 4.11.2 Montáž odkladacieho priestoru na fľaše

- ▶ Pri montáži postupujte v opačnom poradí krokov demontáže.

## 4.12 Výmena poličky v dvierkach

### Požiadavka:

- ✔ Dvierka sú otvorené.

### 4.12.1 Odobratie poličky v dvierkach

- ▶ Poličku v dvierkach zodvihnite smerom nahor.

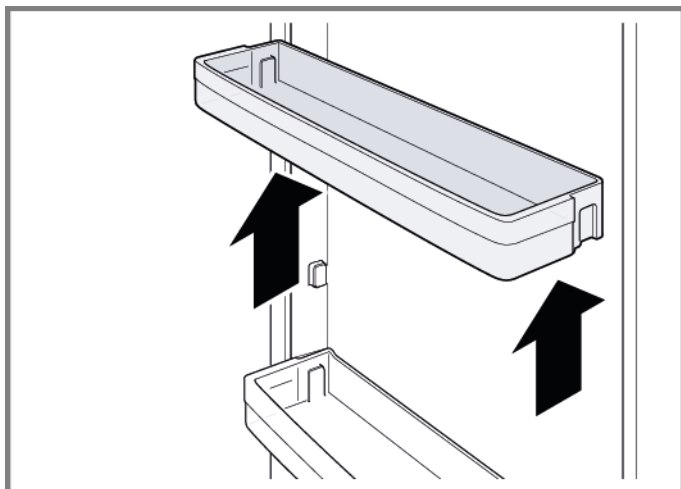

- ➡ Polička v dvierkach je odobratá.

### 4.12.2 Montáž poličky do dvierok

- ▶ Pri montáži postupujte v opačnom poradí krokov demontáže.

## 4.13 Výmena nádoby na zmrazené potraviny

### Požiadavka:

- ✔ Dvierka sú otvorené.

### 4.13.1 Odobratie nádoby na zmrazené potraviny

- ▶ 1. Úplne vytiahnite nádobu na zmrazené potraviny (1).
- ▶ 2. Odoberte nádobu na varené potraviny (2).

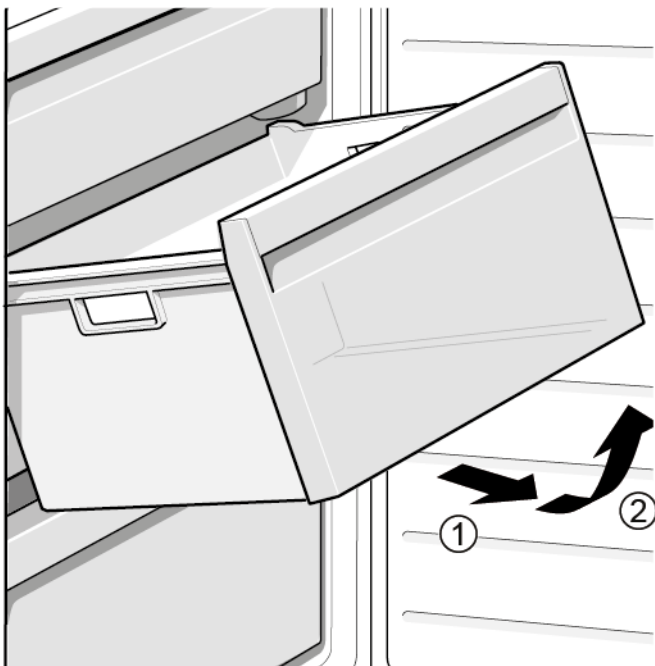

- ➡ Nádobu na zmrazené potraviny je odobratá.

### 4.13.2 Montáž nádoby na zmrazené potraviny

- ▶ Pri montáži postupujte v opačnom poradí krokov demontáže.

## 4.14 Výmena nádoby

### Požiadavka:

- ✔ Dvierka sú otvorené.

### 4.14.1 Odobratie nádoby

- ▶ 1. Vyberte spodnú nádobu chladničky (1).
- ▶ 2. Vyberte hornú nádobu chladničky (2).

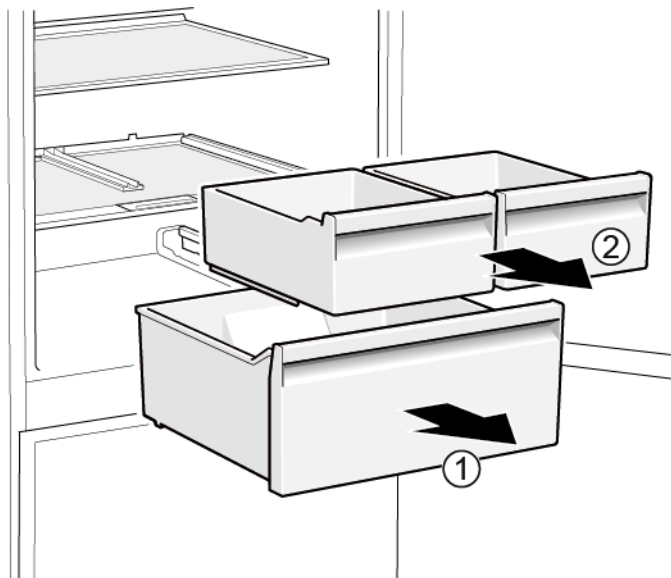

- ➡ Nádoby sú odstránené.

### 4.14.2 Montáž nádoby

- ▶ Pri montáži postupujte v opačnom poradí krokov demontáže.

## 4.15 Výmena výsuvnej nádoby

### Požiadavka:

- ✔ Dvierka sú otvorené.

### 4.15.1 Odobratie výsuvnej nádoby

- ▶ 1. Úplne vytiahnite vysúvateľnú nádobu (1).
- ▶ 2. Odoberte výsuvnú nádobu (2).

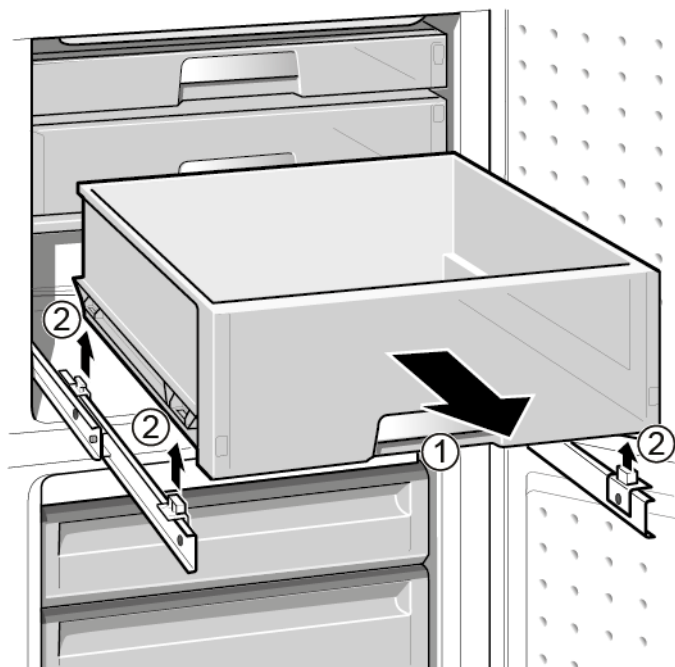

- ➡ Výsuvná nádoba je odobratá.

### 4.15.2 Montáž výsuvnej nádoby

- ▶ Pri montáži postupujte v opačnom poradí krokov demontáže.

## 4.16 Výmena bodového LED svetla

### Špeciálne nástroje:

Špeciálny nástroj [00342180]



Vo výbave vášho spotrebiča je bezúdržbové LED svetlo.  
Tieto svetlá môže opravovať len zákaznícky servis alebo oprávnený technik!



#### NEBEZPEČENSTVO

**Nebezpečenstvo úrazu elektrickým prúdom pri dotyku s časťami pod napätím!**  
Ohrozenie života spôsobené elektrickým zásahom v prípade nesprávnej opravy

- ▶ Elektrické diely má opravovať kvalifikovaný elektrikár.
- ▶ Po oprave zariadenie vykonať bezpečnostný test v súlade s nariadením VDE 0701 alebo s miestnymi nariadeniami.



#### NEBEZPEČENSTVO

**Nebezpečenstvo úrazu elektrickým prúdom pri dotyku s časťami pod napätím!**

Úmrtie v dôsledku zásahu elektrickým prúdom

- ▶ Odpojte spotrebiče od elektrického zdroja aspoň 60 sekúnd pred začiatkom opráv.



#### UPOZORNENIE

**Ostré hrany!**

Rezné poranenia

- ▶ Noste ochranné rukavice.

### Požiadavka:

- ✔ Spotrebič je odpojený od elektrického napájania.
- ✔ Dvierka sú otvorené.

### 4.16.1 Odoberanie bodového LED svetla

1. Na vytiahnutie bodového LED svetla použite špeciálny nástroj (1).

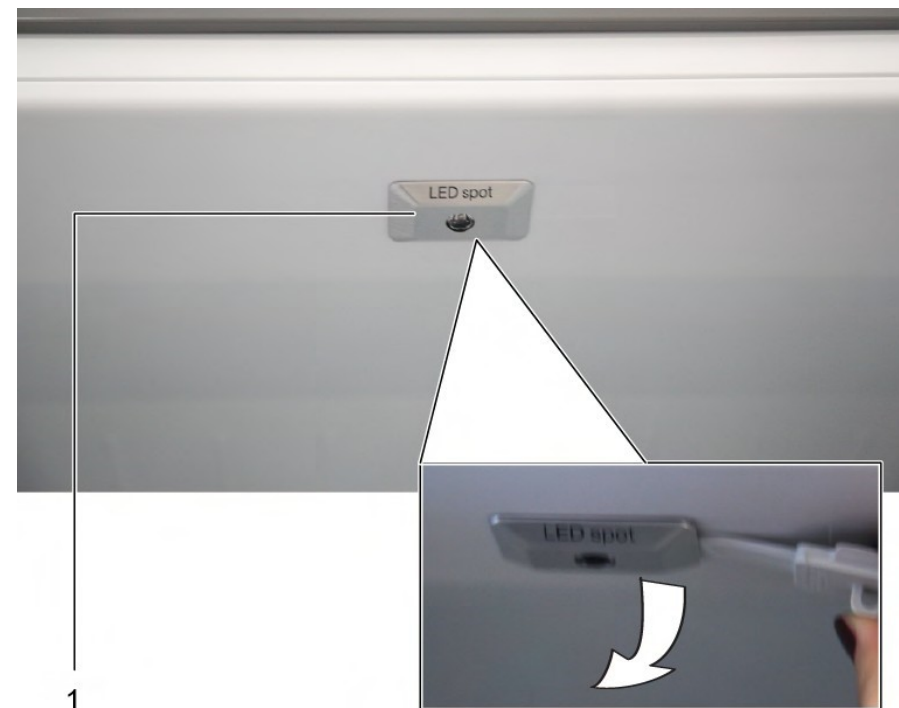

2. Odpojte elektrické pripojenia bodového LED svetla.



➡ Bodové LED svetlo je odobraté.

### 4.16.2 Montáž bodového LED svetla

- ▶ Pri montáži postupujte v opačnom poradí krokov demontáže.

## 4.17 Výmena horného LED svetla

### Špeciálne nástroje:

-  Plochý skrutkovač
-  Čepel 2,4 mm x 0,4 mm x 60 mm, v sade [00341820]



Vo výbave vášho spotrebiča je bezúdržbové LED svetlo. Tieto svetlá môže opravovať len zákaznícky servis alebo oprávnený technik!



#### **NEBEZPEČENSTVO**

**Nebezpečenstvo úrazu elektrickým prúdom pri dotyku s časťami pod napätím!**  
Ohrozenie života spôsobené elektrickým zásahom v prípade nesprávnej opravy

- ▶ Elektrické diely má opravovať kvalifikovaný elektrikár.
- ▶ Po oprave zariadenie vykonať bezpečnostného testu v súlade s nariadením VDE 0701 alebo s miestnymi nariadeniami.



#### **NEBEZPEČENSTVO**

**Nebezpečenstvo úrazu elektrickým prúdom pri dotyku s časťami pod napätím!**

Úmrtie v dôsledku zásahu elektrickým prúdom

- ▶ Odpojte spotrebiče od elektrického zdroja aspoň 60 sekúnd pred začiatkom opráv.





#### **UPOZORNENIE**

**Ostré hrany!**

Rezné poranenia

- ▶ Noste ochranné rukavice.

### Požiadavka:

-  Spotrebič je odpojený od elektrického napájania.
-  Dvierka sú otvorené.
-  Horné tvarovky z interiéru sú odobraté.

### 4.17.1 Odobratie LED osvetlenia

1. Posuňte LED svetlo na ľavú stranu.

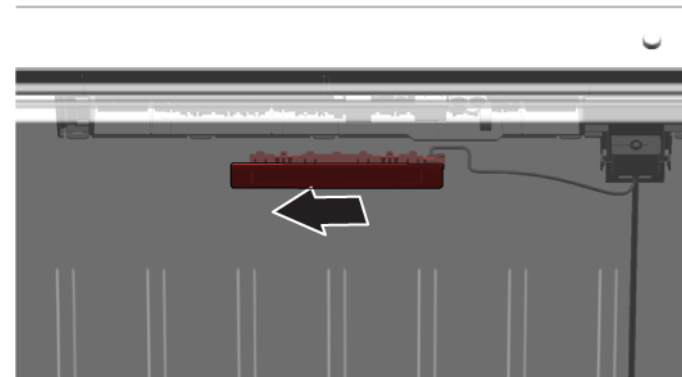

-  Elektrické pripojenie LED svetla je odpojené.

2. Uvoľnite háčiky LED svetla.

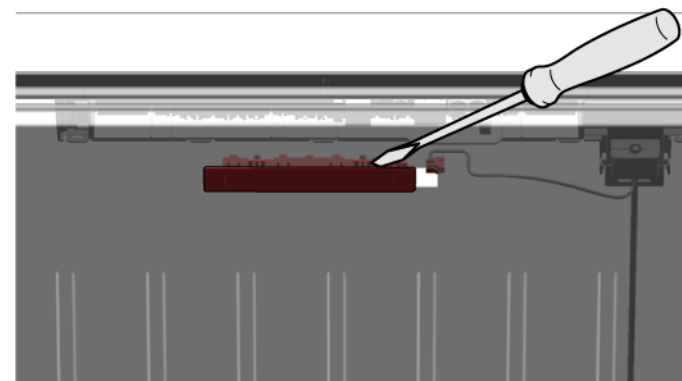

3. Presuňte LED svetlo posunutím dopredu.

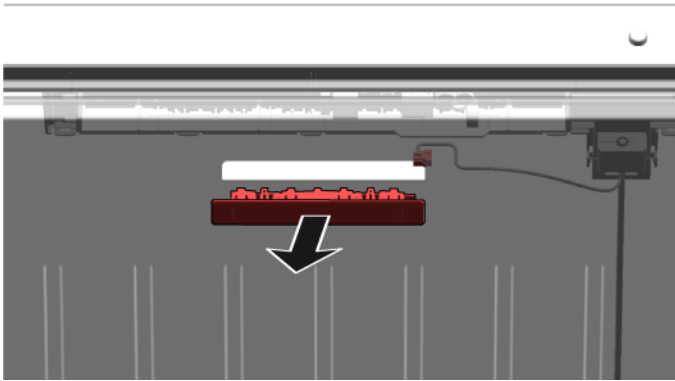

- ➡ LED svetlo je odobraté.

### 4.17.2 Montáž horného LED svetla

- ▶ Pri montáži postupujte v opačnom poradí krokov demontáže.

## 4.18 Výmena bočného pásového LED svetla

### Špeciálne nástroje:

 Prísavný držiak Ø50 mm [00342224]



Vo výbave vášho spotrebiča je bezúdržbové LED svetlo.  
Tieto svetlá môže opravovať len zákaznícky servis alebo oprávnený technik!



### **NEBEZPEČENSTVO**

**Nebezpečenstvo úrazu elektrickým prúdom pri dotyku s časťami pod napätím!**  
Ohrozenie života spôsobené elektrickým zásahom v prípade nesprávnej opravy

- ▶ Elektrické diely má opravovať kvalifikovaný elektrikár.
- ▶ Po oprave zariadenie vykonať bezpečnostný test v súlade s nariadením VDE 0701 alebo s miestnymi nariadeniami.



### **NEBEZPEČENSTVO**

**Nebezpečenstvo úrazu elektrickým prúdom pri dotyku s časťami pod napätím!**  
Úmrtie v dôsledku zásahu elektrickým prúdom

- ▶ Odpojte spotrebiče od elektrického zdroja aspoň 60 sekúnd pred začiatkom opráv.





### **UPOZORNENIE**

**Ostré hrany!**  
Rezné poranenia

- ▶ Noste ochranné rukavice.

### Požiadavka:

-  Spotrebič je odpojený od elektrického napájania.
-  Dvierka sú otvorené.
-  Poličky chladiaceho priestoru sú odobraté.

### 4.18.1 Odobratie bočného pásového LED svetla

1. Nalepte prísavný držiak na hornú tretinu bočného pásového LED svetla.



2. Potiahnite prísavný držiak dopredu s bočným pásovým LED svetlom jedným otočným pohybom.

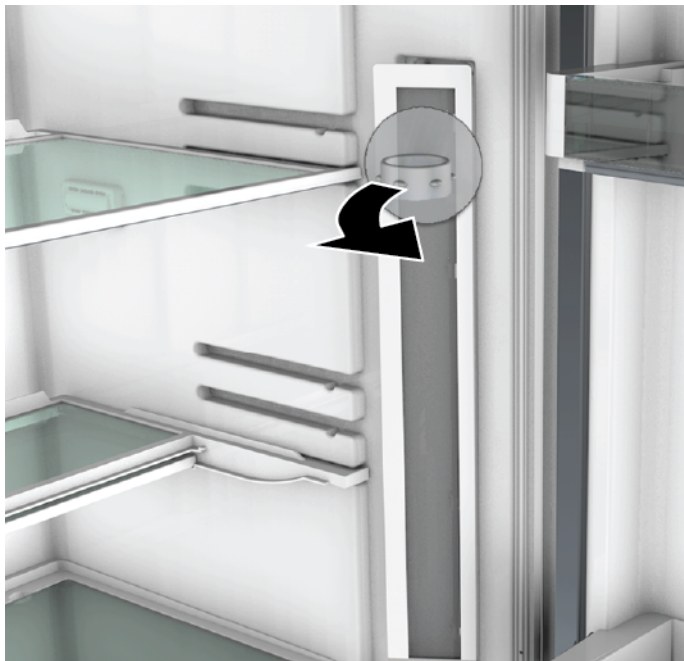





3. Odpojte elektrické pripojenie bočného pásového LED svetla.  
➡ Bočné pásové LED svetlo je odobraté.

### 4.18.2 Montáž bočného pásového LED svetla

1. Pripojte elektrické pripojenie bočného pásového LED svetla.
  2. Pripevnite bočné pásové LED svetlo na svoje miesto na stene priestoru (háčiky zacvaknú).
- ➡ Bočné pásové LED svetlo je namontované.

# Nasveti za popravilo - Hladilno-zamrzovalni aparat

 <b>V zvezi s tem dokumentom</b> .....	<b>543</b>		
1.1 Pomembne informacije .....	543		
1.1.1 Namen .....	543		
1.2 Razlaga simbolov .....	543		
1.2.1 Stopnje nevarnosti .....	543		
1.2.2 Simboli za nevarnost .....	543		
1.2.3 Struktura opozoril .....	544		
1.2.4 Splošni simboli .....	544		
 <b>Varnost</b> .....	<b>545</b>		
2.1 Splošna varnostna navodila .....	545		
2.1.1 Vsi gospodinjski aparati .....	545		
 <b>Orodja in pripomočki</b> .....	<b>546</b>		
 <b>Popravilo</b> .....	<b>547</b>		
4.1 Zamenjava tesnila vrat .....	547		
4.2 Zamenjava ročaja vrat .....	548		
4.2.1 Odstranjevanje ročaja vrat .....	548		
4.2.2 Namestitev ročaja vrat .....	548		
4.3 Zamenjava zgornjega tečaja vrat .....	549		
4.3.1 Odstranjevanje zgornjega tečaja vrat .....	549		
4.3.2 Namestitev zgornjega tečaja vrat .....	550		
4.4 Zamenjava zgornjega tečaja vrat (vrata s prikazovalnikom) .....	551		
4.4.1 Odstranjevanje zgornjega tečaja vrat .....	551		
4.4.2 Namestitev zgornjega tečaja vrat .....	552		
4.5 Zamenjava srednjega tečaja vrat .....	553		
4.5.1 Odstranjevanje srednjega tečaja vrat .....	553		
4.5.2 Namestitev srednjega tečaja vrat .....	553		
4.6 Zamenjava spodnjega tečaja vrat .....	554		
4.6.1 Odstranjevanje spodnjega tečaja vrat .....	554		
4.6.2 Namestitev spodnjega tečaja vrat .....	554		
4.7 Zamenjava police .....	555		
4.7.1 Odstranjevanje police .....	555		
4.7.2 Namestitev police .....	555		
4.8 Zamenjava nastavljive police .....	556		
4.8.1 Odstranjevanje nastavljive police .....	556		
4.8.2 Namestitev nastavljive police .....	556		
4.9 Zamenjava prilagodljive police .....	557		
4.9.1 Odstranjevanje prilagodljive pripolice .....	557		
4.9.2 Namestitev prilagodljive police .....	557		
4.10 Zamenjava kompleta za zajtrk .....	558		
4.10.1 Odstranjevanje kompleta za zajtrk .....	558		
4.10.2 Namestitev kompleta za zajtrk .....	558		
4.11 Zamenjava nosilca za steklenice .....	559		
4.11.1 Odstranjevanje nosilca za steklenice .....	559		
4.11.2 Namestitev nosilca za steklenice .....	559		
4.12 Zamenjava vratnega predala .....	560		
4.12.1 Odstranjevanje vratnega predala .....	560		
4.12.2 Namestitev vratnega predala .....	560		
4.13 Zamenjava predala za zamrznjena živila .....	561		
4.13.1 Odstranjevanje predala za zamrznjena živila .....	561		
4.13.2 Namestitev predala za zamrznjena živila .....	561		
4.14 Zamenjava predala .....	562		
4.14.1 Odstranjevanje predala .....	562		
4.14.2 Namestitev predala .....	562		
4.15 Zamenjava razširljivega predala .....	563		
4.15.1 Odstranjevanje razširljivega predala .....	563		
4.15.2 Namestitev razširljivega predala .....	563		
4.16 Zamenjava točkovne lučke LED .....	564		
4.16.1 Odstranjevanje točkovne lučke LED .....	564		
4.16.2 Namestitev točkovne lučke LED .....	564		
4.17 Zamenjava zgornje lučke LED .....	565		
4.17.1 Odstranjevanje lučke LED .....	565		
4.17.2 Namestitev zgornje lučke LED .....	566		
4.18 Zamenjava stranske svetlobne letve LED .....	567		
4.18.1 Odstranjevanje stranske svetlobne letve LED .....	567		
4.18.2 Namestitev stranske svetlobne letve LED .....	568		

# **i** V zvezi s tem dokumentom

## 1.1 Pomembne informacije

### 1.1.1 Namen

Ti namigi za popravila uporabnika podpirajo pri lastnoročnem popravilu aparatov skladno z veljavno direktivo glede okoljsko primerne zasnove (od marca 2021).



Vsebujejo informacije o tem, kako zamenjati določene rezervne dele, vključno z opozorili in tveganji.

Če imate kakšna vprašanja, se obrnite na našo servisno službo. Za škodo bomo odgovorni le, če ste namige za popravila upoštevali pravilno.

## 1.2 Razlaga simbolov

### 1.2.1 Stopnje nevarnosti

Stopnje opozoril so sestavljene iz simbola in signalne besede. Signalna beseda označuje stopnjo nevarnosti.





Stopnja opozorila	Pomen
 <b>NEVARNOST</b>	Neupoštevanje opozorilnega sporočila bo povzročilo smrt ali hude poškodbe.
 <b>OPOZORILO</b>	Neupoštevanje opozorilnega sporočila lahko povzroči smrt ali hude poškodbe.
 <b>PREVIDNO</b>	Neupoštevanje opozorilnega sporočila lahko povzroči manjše poškodbe.
 <b>POZOR!</b>	Neupoštevanje opozorilnega sporočila lahko povzroči škodo na lastnini.

Preglednica 1: Stopnje nevarnosti



### 1.2.2 Simboli za nevarnost

Simboli za nevarnost so simbolni prikazi, ki podajajo informacije o vrsti nevarnosti.

V tem dokumentu so uporabljeni naslednji simboli za nevarnost:

Simbol za nevarnost	Pomen
	Splošno opozorilno sporočilo
	Nevarnost zaradi električne napetosti
	Nevarnost eksplozije
	Nevarnost ureznin
	Nevarnost zmečkanin

## **i** V zvezi s tem dokumentom

Simbol za nevarnost	Pomen
	Nevarnost zaradi vročih površin
	Nevarnost zaradi močnega magnetnega polja
	Nevarnost zaradi neionizirajočega sevanja

Preglednica 2: Simboli za nevarnost

### 1.2.3 Struktura opozoril

Opozorila v tem dokumentu imajo standardiziran videz in standardizirano strukturo.



	<div style="background-color: red; color: white; padding: 2px; text-align: center;"><b>⚠ NEVARNOST</b></div> <p><b>Vrsta in vir nevarnosti!</b> Morebitne posledice ob neupoštevanju nevarnosti/opozorila.</p> <ul style="list-style-type: none"> <li>▶ Ukrepi in prepovedi za preprečevanje nevarnosti.</li> </ul>
--	---





V naslednjem primeru je prikazano opozorilo, ki opozarja pred električnim udarom zaradi delov pod napetostjo. Naveden je ukrep za preprečevanje nevarnosti.

	<div style="background-color: red; color: white; padding: 2px; text-align: center;"><b>⚠ NEVARNOST</b></div> <p><b>Nevarnost električnega udara zaradi delov pod napetostjo!</b> Smrt zaradi električnega udara</p> <ul style="list-style-type: none"> <li>▶ Izključite aparate iz električnega omrežja vsaj 60 sekund pred začetkom popravil.</li> </ul>
---	---

### 1.2.4 Splošni simboli

V tem dokumentu so uporabljeni naslednji splošni simboli:

Splošni simbol	Pomen
	Identifikacija posebnega nasveta (besedilo in/ali slika)
	Identifikacija preprostega nasveta (samo besedilo)
	Identifikacija povezave na video vadnico

Splošni simbol	Pomen
	Identifikacija potrebnih orodij
	Identifikacija potrebnih predpogojev
	Identifikacija pogoja (če ..., potem ...)
	Identifikacija rezultata
Začetek	Identifikacija tipke ali gumba
[00123456]	Identifikacija številke dela
Stanje	Identifikacija prikazanega besedila/okna (na zaslonu aparata)

Preglednica 3: Splošni simboli

## 2.1 Splošna varnostna navodila

### 2.1.1 Vsi gospodinjski aparati

#### **Nevarnost električnega udara zaradi delov pod napetostjo!**

- Napake zaradi popravil električnih komponent lahko povzročijo električni udar!
- Aparat izključite iz električnega omrežja vsaj 60 sekund pred začetkom del.
- Po popravilu je treba izvesti preizkus varnosti v skladu z VDE 0701 ali predpisi, ki veljajo za posamezno državo.

#### **Nevarnost poškodb zaradi ostrih robov!**

- Uporabljajte zaščitne rokavice.

#### **Nevarnost zmečkanin med popravili, vzdrževanjem, odpravljanjem težav ali servisom zaradi težkih in premikajočih se komponent**

- Uporabljajte zaščitne čevlje.
- Težke komponente zavarujte pred padanjem.
- Delov telesa ne vstavljajte v premikajoče se komponente.





#### **Tveganje za varnost/delovanje aparata!**

- Uporabljajte le originalne nadomestne dele.

#### **Tveganje poškodb elektrostatično občutljivih komponent (ESD)!**

- Ne dotikajte se modulov, vključno s povezavami in potmi vodnika.

## Orodja in pripomočki

Oznaka	Podrobnosti	Slike
Zaščitna krpa [00342013]	60 cm x 50 cm	
Komplet natančnih izvijačev [00341820]	9 kosov, 2,0 mm, 2,4 mm, 3,0 mm, PH0, PH00, PH1, TX6, TX8, TX9	
Pomožno orodje [00342180]	Orodje za rahljanje plastičnih delov "magic tool"	
Vakuumski prisesek [00342224]	Ø 50 mm	
Nastavek Torx TX20 [00340865]	6,3 mm (1/4")	
Ploščati izvijač	Steblo 10 mm x 1,6 mm x 200 mm	



## 4.1 Zamenjava tesnila vrat

### Zahteva:



- Vrata so odprta.

## 4.2 Zamenjava ročaja vrat

### Posebna orodja:

-  Nastavek Torx TX20                      6,3 mm (1/4")                      [00340865]
-  Ploščati izvijač                      Steblo 10 mm x 1,6 mm x 200 mm

### Zahteva:

-  Aparat je odklopljen iz omrežne napetosti.
-  Vrata so odprta.

### 4.2.1 Odstranjevanje ročaja vrat

- ▶ 1. Odstranite dva pokrovčka vijakov (1).
- ▶ 2. Odvijte vijaka (2).
- ▶ 3. Odstranite ročaj vrat (3).

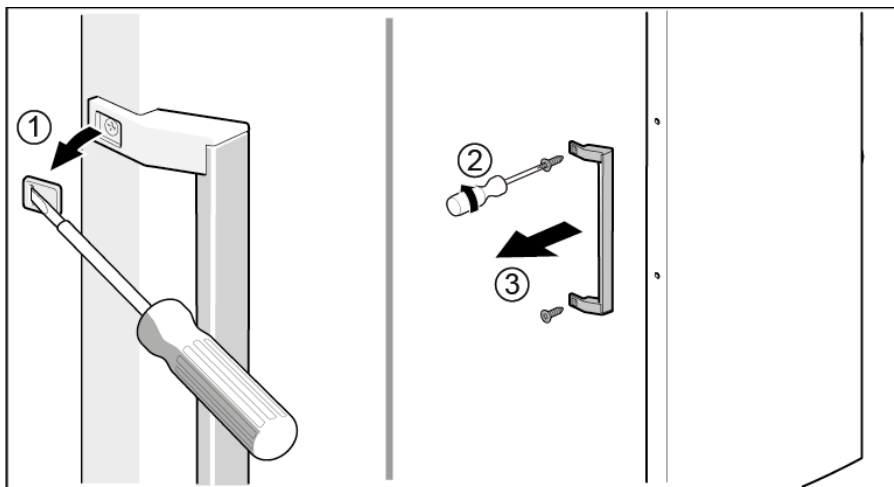

 Ročaj vrat je odstranjen.



Ročaj vrat za druga vrata lahko odstranite na enak način.

### 4.2.2 Namestitev ročaja vrat

- ▶ Namestite v obratnem vrstnem redu.

## 4.3 Zamenjava zgornjega tečaja vrat

Posebna orodja:

🔧 Nastavek Torx TX20      6,3 mm (1/4")      [00340865]

	<b>⚠️ OPOZORILO</b>
	<p><b>Težki, veliki aparati!</b> Poškodbe hrbta in mišic</p> <ul style="list-style-type: none"> <li>▶ Postopek odstranjevanja vrat aparata naj izvaja samo pooblašče-no strokovno osebje.</li> <li>▶ Za premikanje aparata sta potrebni dve osebi.</li> <li>▶ Uporabite samo ustrezno orodje in opremo.</li> </ul>

	<b>⚠️ PREVIDNO</b>
	<p><b>Ostri robovi!</b> Ureznine</p> <ul style="list-style-type: none"> <li>▶ Uporabljajte zaščitne rokavice.</li> </ul>

	<b>⚠️ OPOZORILO</b>
	<p><b>Zdrs nagnjenih aparatov!</b> Zlomi kosti/zmečkanine</p> <ul style="list-style-type: none"> <li>▶ Aparate zaščitite pred zdrsavanjem.</li> </ul>

	<b>⚠️ PREVIDNO</b>
	<p><b>Nevarnost padajočih delov zaradi zrahljanih vijakov!</b> Poškodbe zaradi padajočih delov.</p> <ul style="list-style-type: none"> <li>▶ Komponento zaščitite pred padcem.</li> </ul>

	<b>POZOR!</b>
	<p><b>Nevarnost padajočih delov zaradi zrahljanih vijakov!</b> Škoda na drugih delih aparata ali pri uporabniku doma, npr. na tleh.</p> <ul style="list-style-type: none"> <li>▶ Komponento zaščitite pred padcem.</li> </ul>

Zahteva:

- ✔ Aparat je odklopljen iz omrežne napetosti.
- ✔ Notranji elementi aparata so odstranjeni.

## 4.3.1 Odstranjevanje zgornjega tečaja vrat

1. Aparat postavite na zadnjo stran.

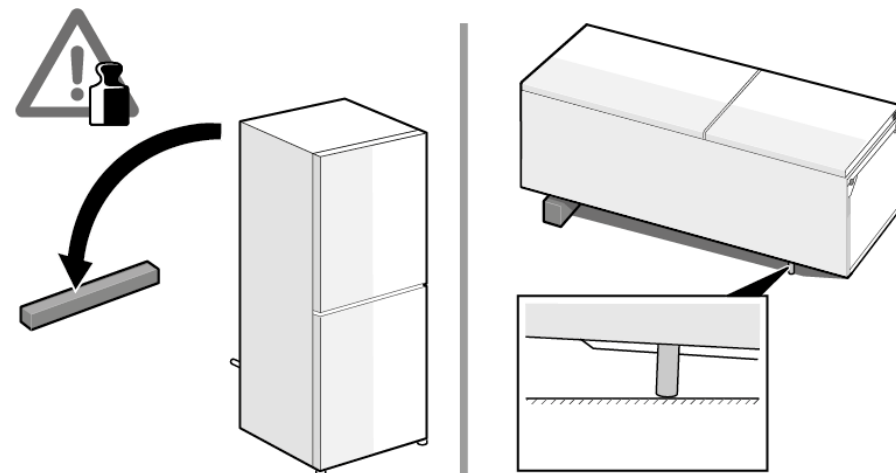

## Popravilo

1. Pokrovček zgornjega tečaja pritisnite na obeh straneh (1).
2. Pokrovček zgornjega tečaja povlecite stran (2).
3. Zavrtite pokrovček tečaja (3).
4. Odstranite pokrovček zgornjega tečaja (4).
5. Odvijte vijaka (5).
6. Odstranite zgornji tečaj (6).

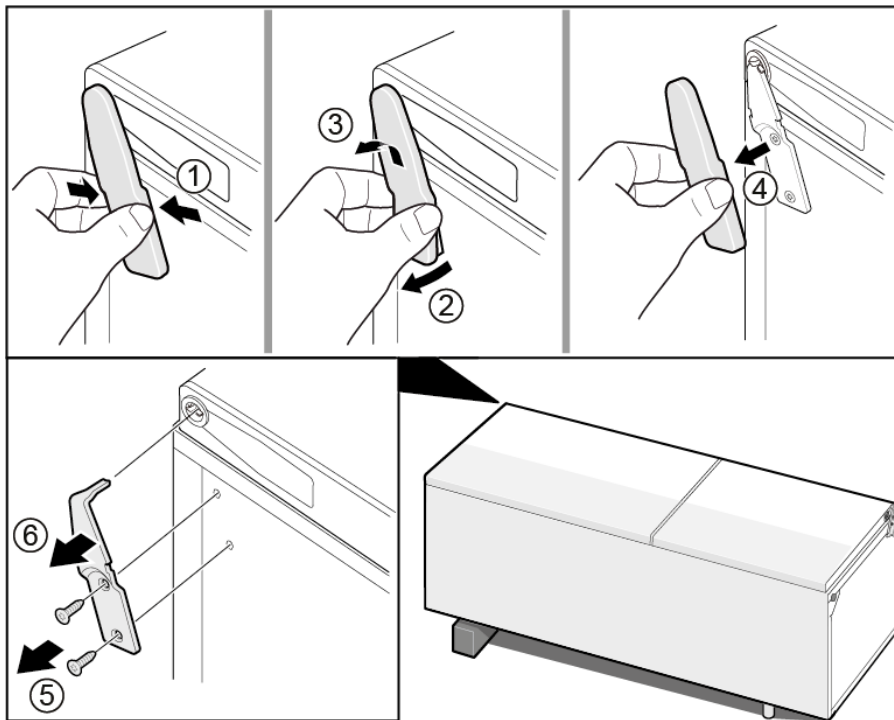

 Zgornji tečaj je odstranjen.

### 4.3.2 Namestitev zgornjega tečaja vrat

- ▶ Namestite v obratnem vrstnem redu.

## 4.4 Zamenjava zgornjega tečaja vrat (vrata s prikazovalnikom)

Posebna orodja:

🌀 Nastavek Torx TX20      6,3 mm (1/4")      [00340865]

	<b>⚠️ OPOZORILO</b>
	<p><b>Težki, veliki aparati!</b> Poškodbe hrbta in mišic</p> <ul style="list-style-type: none"> <li>▶ Postopek odstranjevanja vrat aparata naj izvaja samo pooblaščen strokovno osebje.</li> <li>▶ Za premikanje aparata sta potrebni dve osebi.</li> <li>▶ Uporabite samo ustrezno orodje in opremo.</li> </ul>

	<b>⚠️ PREVIDNO</b>
	<p><b>Ostri robovi!</b> Ureznine</p> <ul style="list-style-type: none"> <li>▶ Uporabljajte zaščitne rokavice.</li> </ul>

	<b>⚠️ OPOZORILO</b>
	<p><b>Zdrs nagnjenih aparatov!</b> Zlomi kosti/zmečkanine</p> <ul style="list-style-type: none"> <li>▶ Aparate zaščitite pred zdrsavanjem.</li> </ul>

	<b>⚠️ PREVIDNO</b>
	<p><b>Nevarnost padajočih delov zaradi zrahljanih vijakov!</b> Poškodbe zaradi padajočih delov.</p> <ul style="list-style-type: none"> <li>▶ Komponento zaščitite pred padcem.</li> </ul>

	<b>POZOR!</b>
	<p><b>Nevarnost padajočih delov zaradi zrahljanih vijakov!</b> Škoda na drugih delih aparata ali pri uporabniku doma, npr. na tleh.</p> <ul style="list-style-type: none"> <li>▶ Komponento zaščitite pred padcem.</li> </ul>

	<b>⚠️ NEVARNOST</b>
	<p><b>Nevarnost električnega udara zaradi delov pod napetostjo!</b> Življenjska nevarnost zaradi električnega udara v primeru nepravilnega popravila</p> <ul style="list-style-type: none"> <li>▶ Električne dele mora popraviti kvalificiran električar.</li> <li>▶ Po popravilu je treba izvesti preizkus varnosti v skladu z VDE 0701 ali predpisi, ki veljajo za posamezno državo.</li> </ul>

	<b>⚠️ NEVARNOST</b>
	<p><b>Nevarnost električnega udara zaradi delov pod napetostjo!</b> Smrt zaradi električnega udara</p> <ul style="list-style-type: none"> <li>▶ Izključite aparate iz električnega omrežja vsaj 60 sekund pred začetkom popravil.</li> </ul>

**Zahteva:**

- ✅ Aparat je odklopljen iz omrežne napetosti.
- ✅ Notranji elementi aparata so odstranjeni.

### 4.4.1 Odstranjevanje zgornjega tečaja vrat

1. Aparat postavite na zadnjo stran.

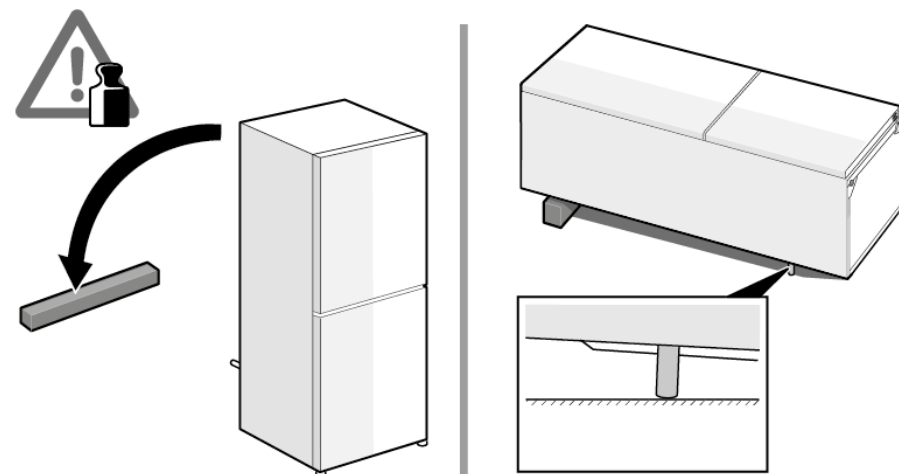

## Popravilo

2. 1. Odstranite pokrovček zgornjega tečaja (1).
2. Odstranite pokrovček odprtine za kable (2).
3. Odklopite električno povezavo (3)
4. Odvijte vijak za ozemljitev (4).
5. Odstranite kabelsko zaščito (5).
6. Odvijte vijak (6)

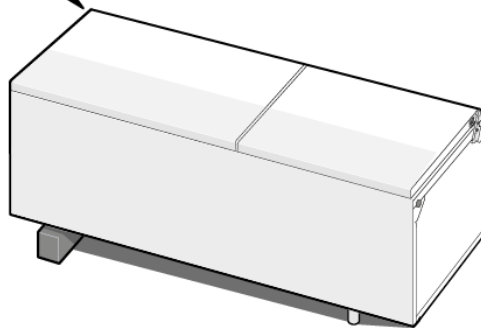
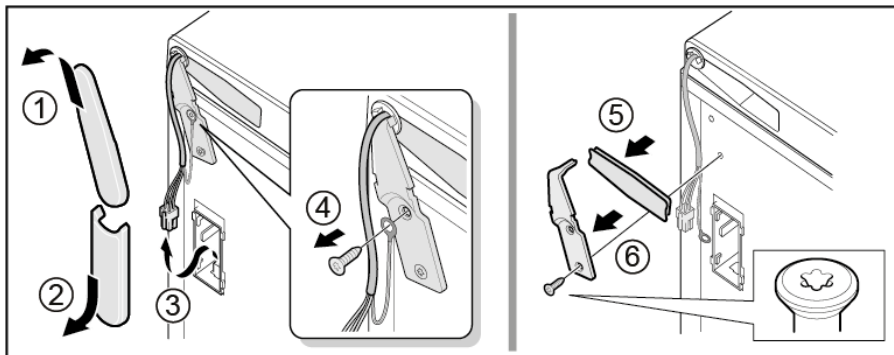

 Zgornji tečaj je odstranjen.

### 4.4.2 Namestitev zgornjega tečaja vrat

- ▶ Namestite v obratnem vrstnem redu.

## 4.5 Zamenjava srednjega tečaja vrat

### Posebna orodja:

🌀 Nastavek Torx TX20      6,3 mm (1/4")      [00340865]

	<b>⚠️ OPOZORILO</b>
	<p><b>Težki, veliki aparati!</b> Poškodbe hrbta in mišic</p> <ul style="list-style-type: none"> <li>▶ Postopek odstranjevanja vrat aparata naj izvaja samo pooblašče-no strokovno osebje.</li> <li>▶ Za premikanje aparata sta potrebni dve osebi.</li> <li>▶ Uporabite samo ustrezno orodje in opremo.</li> </ul>

	<b>⚠️ PREVIDNO</b>
	<p><b>Ostri robovi!</b> Ureznine</p> <ul style="list-style-type: none"> <li>▶ Uporabljajte zaščitne rokavice.</li> </ul>

	<b>⚠️ OPOZORILO</b>
	<p><b>Zdrs nagnjenih aparatov!</b> Zlomi kosti/zmečkanine</p> <ul style="list-style-type: none"> <li>▶ Aparate zaščitite pred zdrsavanjem.</li> </ul>

	<b>⚠️ PREVIDNO</b>
	<p><b>Nevarnost padajočih delov zaradi zrahljanih vijakov!</b> Poškodbe zaradi padajočih delov.</p> <ul style="list-style-type: none"> <li>▶ Komponento zaščitite pred padcem.</li> </ul>

	<b>POZOR!</b>
	<p><b>Nevarnost padajočih delov zaradi zrahljanih vijakov!</b> Škoda na drugih delih aparata ali pri uporabniku doma, npr. na tleh.</p> <ul style="list-style-type: none"> <li>▶ Komponento zaščitite pred padcem.</li> </ul>

### Zahteva:

- ✔ Aparat je odklopljen iz omrežne napetosti.
- ✔ Notranji elementi aparata so odstranjeni.
- ✔ Zgornji tečaj vrat je odstranjen.
- ✔ Zgornja vrata so odstranjena.

### 4.5.1 Odstranjevanje srednjega tečaja vrat

- ▶ 1. Odstranite vrata hladilnega dela (1).
- ▶ 2. Odvijte vijaka (2).
- ▶ 3. Odstranite srednji tečaj (3).

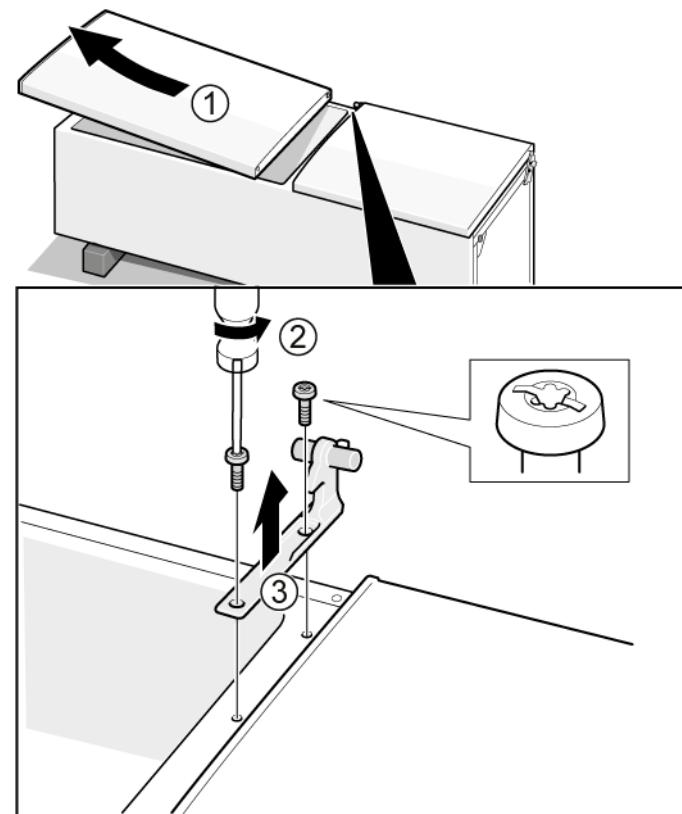

➡ Srednji tečaj je odstranjen.

### 4.5.2 Namestitev srednjega tečaja vrat

- ▶ Namestite v obratnem vrstnem redu.

## 4.6 Zamenjava spodnjega tečaja vrat

### Posebna orodja:

🔧 Nastavek Torx TX20      6,3 mm (1/4")      [00340865]

	<b>⚠️ OPOZORILO</b>
	<p><b>Težki, veliki aparati!</b> Poškodbe hrbta in mišic</p> <ul style="list-style-type: none"> <li>▶ Postopek odstranjevanja vrat aparata naj izvaja samo pooblašče-no strokovno osebje.</li> <li>▶ Za premikanje aparata sta potrebni dve osebi.</li> <li>▶ Uporabite samo ustrezno orodje in opremo.</li> </ul>

	<b>⚠️ PREVIDNO</b>
	<p><b>Ostri robovi!</b> Ureznine</p> <ul style="list-style-type: none"> <li>▶ Uporablajte zaščitne rokavice.</li> </ul>

	<b>⚠️ OPOZORILO</b>
	<p><b>Zdrs nagnjenih aparatov!</b> Zlomi kosti/zmečkanine</p> <ul style="list-style-type: none"> <li>▶ Aparate zaščitite pred zdrsavanjem.</li> </ul>

	<b>⚠️ PREVIDNO</b>
	<p><b>Nevarnost padajočih delov zaradi zrahljanih vijakov!</b> Poškodbe zaradi padajočih delov.</p> <ul style="list-style-type: none"> <li>▶ Komponento zaščitite pred padcem.</li> </ul>

	<b>POZOR!</b>
	<p><b>Nevarnost padajočih delov zaradi zrahljanih vijakov!</b> Škoda na drugih delih aparata ali pri uporabniku doma, npr. na tleh.</p> <ul style="list-style-type: none"> <li>▶ Komponento zaščitite pred padcem.</li> </ul>

### Zahteva:

- ✔️ Aparat je odklopljen iz omrežne napetosti.
- ✔️ Notranji elementi aparata so odstranjeni.
- ✔️ Zgornji tečaj je odstranjen.
- ✔️ Srednji tečaj je odstranjen.

### 4.6.1 Odstranjevanje spodnjega tečaja vrat

- ▶ 1. Odstranite vrata zamrzovalnega dela (1).
- ▶ 2. Odvijte vijak (2).
- ▶ 3. Spodnji tečaj zavrtite navzven (3).
- ▶ 4. Odstranite spodnji tečaj (4).

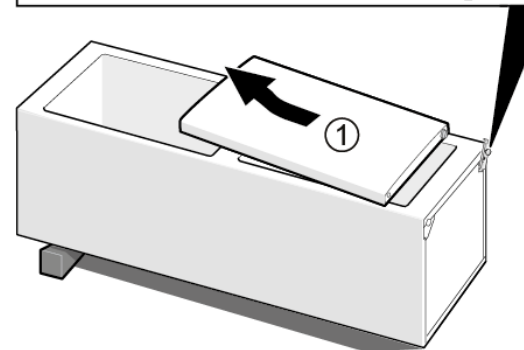
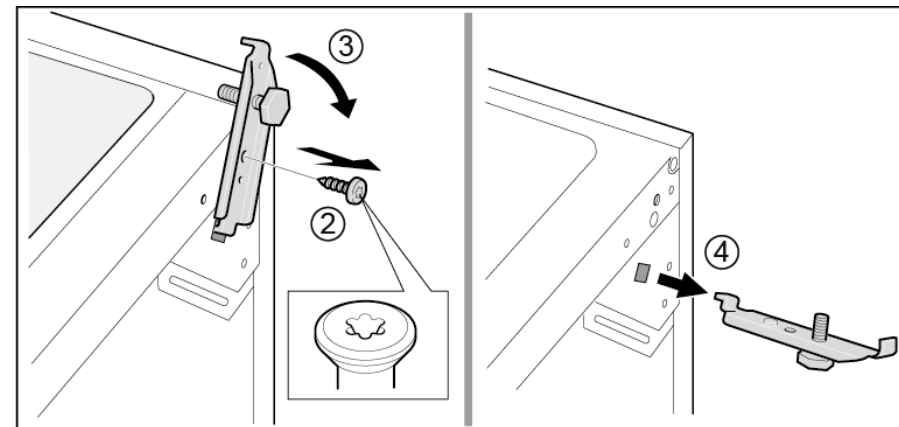

- ➡ Spodnji tečaj vrat je odstranjen.

### 4.6.2 Namestitev spodnjega tečaja vrat

- ▶ Namestite v obratnem vrstnem redu.

## 4.7 Zamenjava police

### Zahteva:

- ✔ Vrata so odprta.

### 4.7.1 Odstranjevanje police

- ▶ Izvlecite polico.

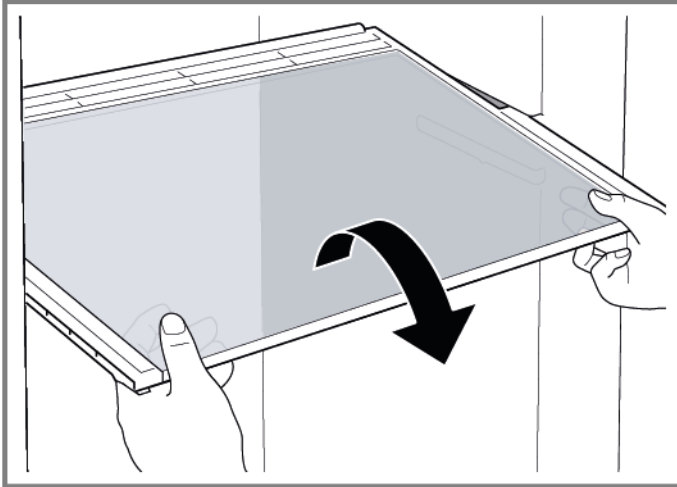

- ➡ Polica je odstranjena.

### 4.7.2 Namestitev police

- ▶ Namestite v obratnem vrstnem redu.

## 4.8 Zamenjava nastavljive police

### Zahteva:

- ✔ Vrata so odprta.

### 4.8.1 Odstranjanje nastavljive police

1. Povlecite desni del nastavljive police naprej (1).
2. Odstranite desni del nastavljive police (2).

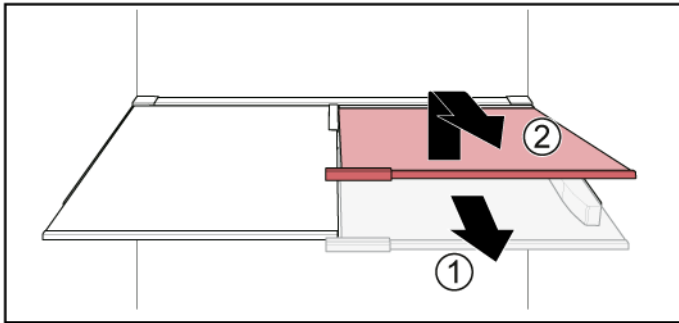

2. Na enak način odstranite levi del nastavljive police.

- ➡ Nastavljiva polica je odstranjena.

### 4.8.2 Namestitev nastavljive police

- ▶ Namestite v obratnem vrstnem redu.

## 4.9 Zamenjava prilagodljive police

### Zahteva:

- ✔ Vrata so odprta.

### 4.9.1 Odstranjanje prilagodljive police

- ▶ 1. Odstranite stekleno polico (1).
- ▶ 2. Dvignite prilagodljivo polico in jo izvlecite (2).

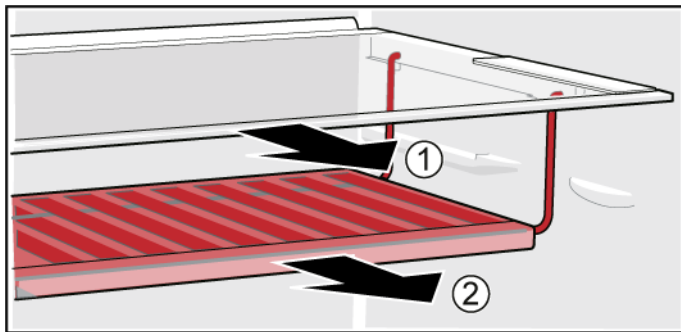

- ➡ Prilagodljiva polica je odstranjena.

### 4.9.2 Namestitev prilagodljive police

- ▶ Namestite v obratnem vrstnem redu.

## 4.10 Zamenjava kompleta za zajtrk

### Zahteva:

- ✔ Vrata so odprta.

### 4.10.1 Odstranjevanje kompleta za zajtrk

- ▶ Dvignite komplet za zajtrk in ga izvlecite.

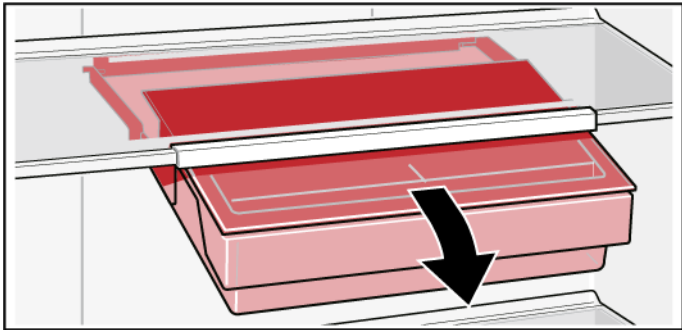

- ➡ Komplet za zajtrk je odstranjen.

### 4.10.2 Namestitev kompleta za zajtrk

- ▶ Namestite v obratnem vrstnem redu.

## 4.11 Zamenjava nosilca za steklenice

### Zahteva:

- ✔ Vrata so odprta.

### 4.11.1 Odstranjevanje nosilca za steklenice

- ▶ Izvlecite nosilec za steklenice.

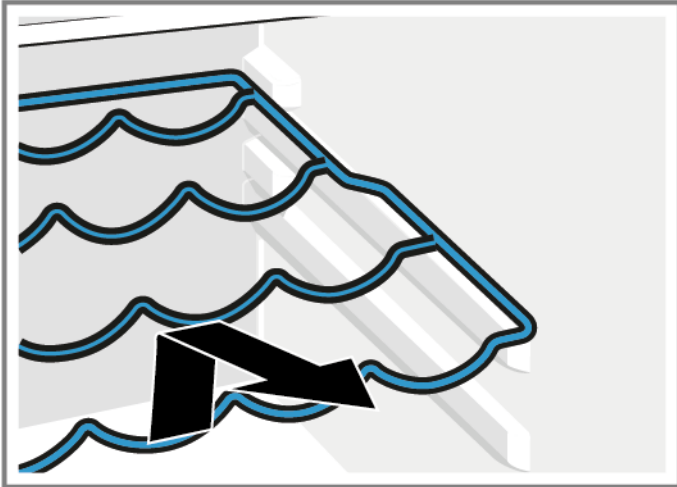

- ➔ Nosilec za steklenice je odstranjen.

### 4.11.2 Namestitev nosilca za steklenice

- ▶ Namestite v obratnem vrstnem redu.

## 4.12 Zamenjava vratnega predala

### Zahteva:

- ✔ Vrata so odprta.

### 4.12.1 Odstranjevanje vratnega predala

- ▶ Dvignite vrtni predal navzgor.

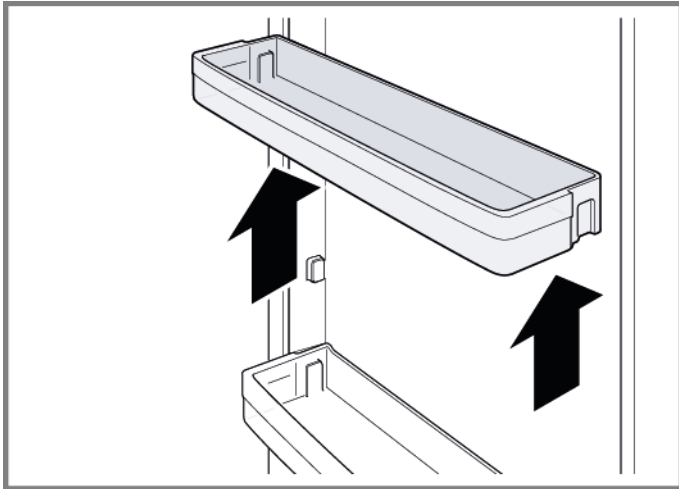

- ➡ Vratni predal je odstranjen.

### 4.12.2 Namestitev vratnega predala

- ▶ Namestite v obratnem vrstnem redu.

## 4.13 Zamenjava predala za zamrznjena živila

### Zahteva:

- ✔ Vrata so odprta.

### 4.13.1 Odstranjevanje predala za zamrznjena živila

- ▶ 1. Predal za zamrznjena živila izvlecite do konca (1).
- ▶ 2. Odstranite predal za živila (2).

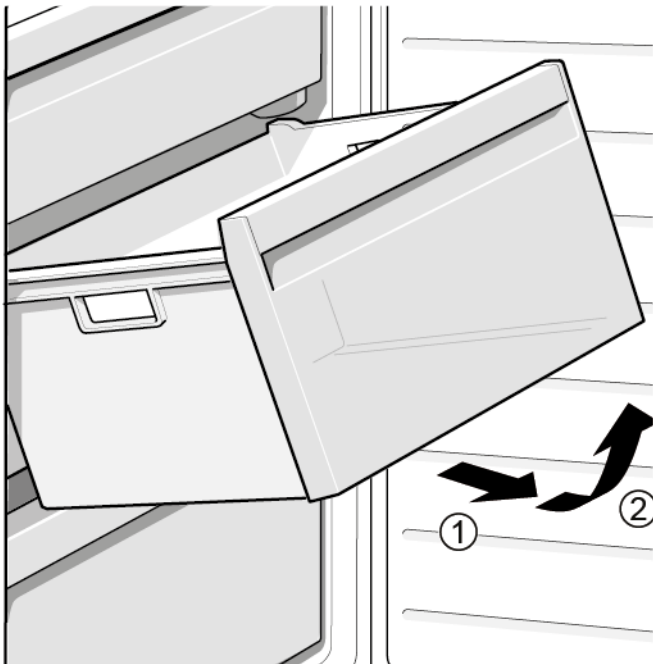

- ➡ Predal za zamrznjena živila je odstranjen.

### 4.13.2 Namestitev predala za zamrznjena živila

- ▶ Namestite v obratnem vrstnem redu.

## 4.14 Zamenjava predala

### Zahteva:

- ✔ Vrata so odprta.

### 4.14.1 Odstranjevanje predala

- ▶ 1. Izvlecite spodnji predal hladilnika (1).
- ▶ 2. Izvlecite zgornji predal hladilnika (2).

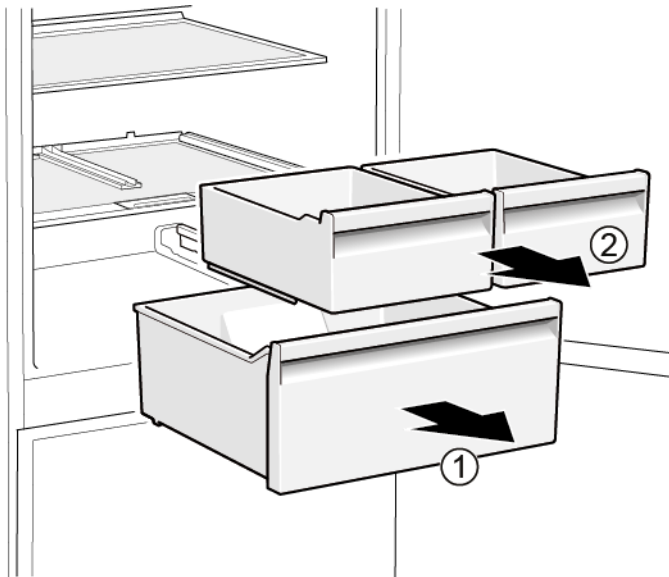

- ➡ Predala sta odstranjena.

### 4.14.2 Namestitev predala

- ▶ Namestite v obratnem vrstnem redu.

## 4.15 Zamenjava razširljivega predala

### Zahteva:

- ✔ Vrata so odprta.

### 4.15.1 Odstranjanje razširljivega predala

- ▶ 1. Razširljivi predal izvlecite do konca (1).
- ▶ 2. Odstranite razširljivi predal (2).

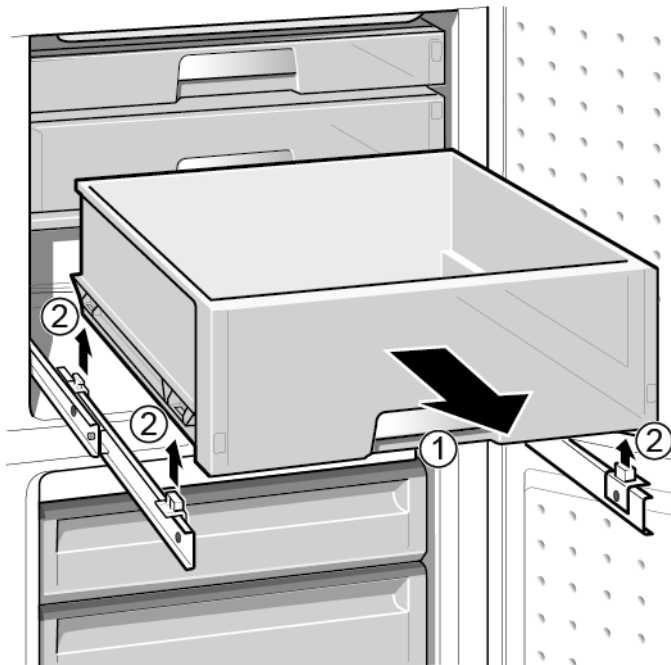

- ➡ Razširljivi predal je odstranjen.

### 4.15.2 Namestitev razširljivega predala

- ▶ Namestite v obratnem vrstnem redu.

## 4.16 Zamenjava točkovne lučke LED

### Posebna orodja:

🔧 Posebno orodje [00342180]

**i** Vaš aparat je opremljen z osvetlitvijo LED, ki ne potrebuje vzdrževanja. To vrsto osvetlitve lahko popravi samo servisna služba ali pooblaščen strokovno osebje!

**⚠️ NEVARNOST**  
**Nevarnost električnega udara zaradi delov pod napetostjo!**  
Življenjska nevarnost zaradi električnega udara v primeru nepravilnega popravila

- ▶ Električne dele mora popraviti kvalificiran električar.
- ▶ Po popravilu je treba izvesti preizkus varnosti v skladu z VDE 0701 ali predpisi, ki veljajo za posamezno državo.

**⚠️ NEVARNOST**  
**Nevarnost električnega udara zaradi delov pod napetostjo!**  
Smrt zaradi električnega udara

- ▶ Izključite aparate iz električnega omrežja vsaj 60 sekund pred začetkom popravil.

**⚠️ PREVIDNO**  
**Ostri robovi!**  
Ureznine

- ▶ Uporabljajte zaščitne rokavice.

### Zahteva:

- ✓ Aparat je odklopljen iz omrežne napetosti.
- ✓ Vrata so odprta.

### 4.16.1 Odstranjevanje točkovne lučke LED

1. Točkovno lučko LED izvalcite s posebnim orodjem (1).

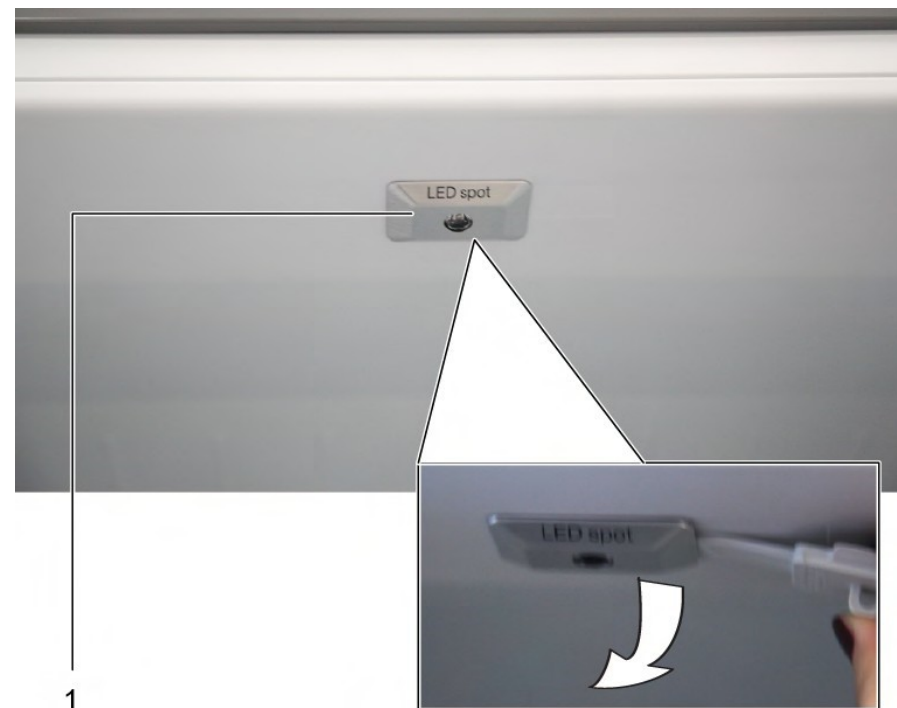

2. Odklopite električne priključke točkovne lučke LED.
- ➡ Točkovna lučka LED je odstranjena.

### 4.16.2 Namestitev točkovne lučke LED

- ▶ Namestite v obratnem vrstnem redu.

## 4.17 Zamenjava zgornje lučke LED

### Posebna orodja:

🔧 Ploščati izvijač

Steblo 2,4 mm x 0,4 mm x 60 mm, v kompletu [00341820]



Vaš aparat je opremljen z osvetlitvijo LED, ki ne potrebuje vzdrževanja. To vrsto osvetlitve lahko popravi samo servisna služba ali pooblaščen strokovno osebje!



### ⚠️ NEVARNOST

#### Nevarnost električnega udara zaradi delov pod napetostjo!

Življenjska nevarnost zaradi električnega udara v primeru nepravilnega popravila

- ▶ Električne dele mora popraviti kvalificiran električar.
- ▶ Po popravilu je treba izvesti preizkus varnosti v skladu z VDE 0701 ali predpisi, ki veljajo za posamezno državo.



### ⚠️ NEVARNOST

#### Nevarnost električnega udara zaradi delov pod napetostjo!

Smrt zaradi električnega udara

- ▶ Izključite aparate iz električnega omrežja vsaj 60 sekund pred začetkom popravil.



### ⚠️ PREVIDNO

#### Ostri robovi!

Ureznine

- ▶ Uporabljajte zaščitne rokavice.

### Zahteva:

- ✔️ Aparat je odklopljen iz omrežne napetosti.
- ✔️ Vrata so odprta.
- ✔️ Odstranjeni so zgornji notranji elementi aparata.

## 4.17.1 Odstranjevanje lučke LED

1. Lučko LED premaknite v levo.



- ➡️ Električni priključek lučke LED je odklopljen.

2. Sprostite zatiče lučke LED.

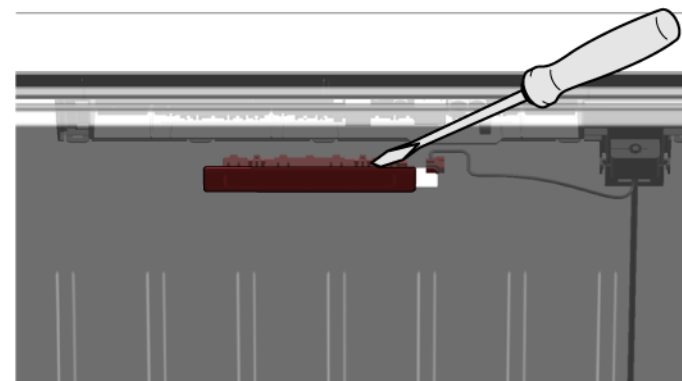

3. Lučko LED premaknite naprej in jo odstranite.

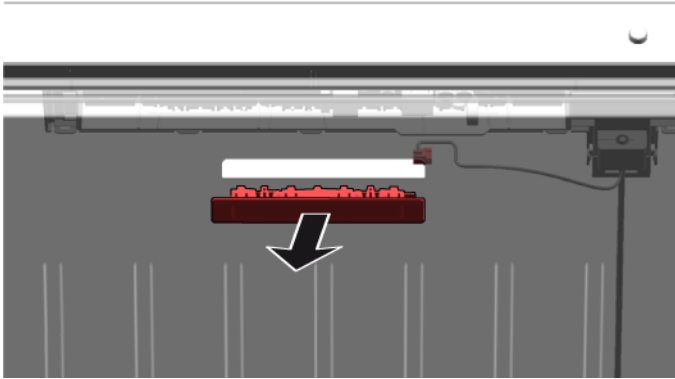

- ➔ Lučka LED je odstranjena.

### 4.17.2 Namestitev zgornje lučke LED

- ▶ Namestite v obratnem vrstnem redu.

## 4.18 Zamenjava stranske svetlobne letve LED

### Posebna orodja:

🌀 Vakuumski prisesek Ø50 mm [00342224]



Vaš aparat je opremljen z osvetlitvijo LED, ki ne potrebuje vzdrževanja. To vrsto osvetlitve lahko popravi samo servisna služba ali pooblaščen strokovno osebje!



### ⚠️ NEVARNOST

**Nevarnost električnega udara zaradi delov pod napetostjo!**  
Življenjska nevarnost zaradi električnega udara v primeru nepravilnega popravila

- ▶ Električne dele mora popraviti kvalificiran električar.
- ▶ Po popravilu je treba izvesti preizkus varnosti v skladu z VDE 0701 ali predpisi, ki veljajo za posamezno državo.



### ⚠️ NEVARNOST

**Nevarnost električnega udara zaradi delov pod napetostjo!**  
Smrt zaradi električnega udara

- ▶ Izključite aparate iz električnega omrežja vsaj 60 sekund pred začetkom popravil.



### ⚠️ PREVIDNO

**Ostri robovi!**  
Ureznine

- ▶ Uporabljajte zaščitne rokavice.

### Zahteva:

- ✓ Aparat je odklopljen iz omrežne napetosti.
- ✓ Vrata so odprta.
- ✓ Police hladilnega dela so odstranjene.

## 4.18.1 Odstranjevanje stranske svetlobne letve LED

1. Prisesek namestite na zgornjo tretjino stranske svetlobne letve LED.



## Popravilo

2. S krožnim gibom povlecite prisesek s stransko svetlobno letvijo LED k sebi.

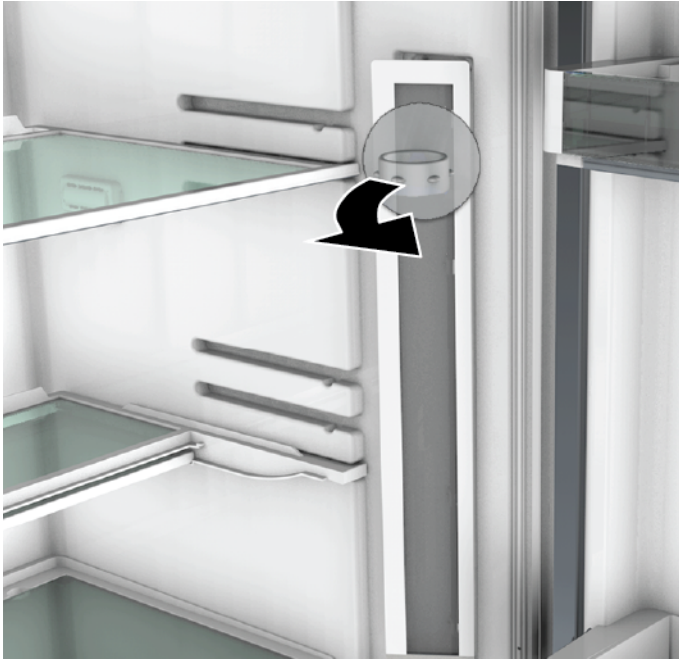





3. Odklopite električno povezavo stranske svetlobne letve LED.  
➡ Stranska svetlobna letev LED je odstranjena.

### 4.18.2 Namestitev stranske svetlobne letve LED

1. Priključite električno povezavo stranske svetlobne letve LED.
  2. Stransko svetlobno letev LED pritrdite na njeno mesto na steni hladilnika (zatiči se zaskočijo).
- ➡ Stranska svetlobna letev LED je nameščena.

# Consejos de reparación - Refrigerador-congelador

 <b>En relación con este documento</b> .....	<b>570</b>
1.1 Información importante .....	570
1.1.1 Finalidad .....	570
1.2 Explicación de símbolos generales .....	570
1.2.1 Niveles de peligrosidad .....	570
1.2.2 Símbolos de peligro .....	570
1.2.3 Estructura de las advertencias .....	571
1.2.4 Símbolos generales .....	571
 <b>Seguridad</b> .....	<b>572</b>
2.1 Instrucciones generales de seguridad .....	572
2.1.1 Todos los aparatos electrodomésticos.....	572
 <b>Herramientas y auxiliares</b> .....	<b>573</b>
 <b>Reparación</b> .....	<b>574</b>
4.1 Sustituir la junta de la puerta .....	574
4.2 Sustituir el tirador de la puerta.....	575
4.2.1 Retirar el tirador de la puerta .....	575
4.2.2 Montar el tirador de la puerta .....	575
4.3 Sustituir la bisagra superior de la puerta .....	576
4.3.1 Desmontar la bisagra superior de la puerta.....	576
4.3.2 Montar la bisagra superior de la puerta .....	577
4.4 Sustituir la bisagra superior de la puerta (puerta con display).....	578
4.4.1 Desmontar la bisagra superior de la puerta.....	578
4.4.2 Montar la bisagra superior de la puerta .....	579
4.5 Sustituir la bisagra central de la puerta .....	580
4.5.1 Desmontar la bisagra central de la puerta.....	580
4.5.2 Montar la bisagra central de la puerta.....	580
4.6 Sustituir la bisagra inferior de la puerta .....	581
4.6.1 Desmontar la bisagra inferior de la puerta .....	581
4.6.2 Montar la bisagra inferior de la puerta .....	581
4.7 Sustituir el estante .....	582
4.7.1 Extraer el estante.....	582
4.7.2 Montar el estante .....	582
4.8 Sustituir el estante ajustable.....	583
4.8.1 Retirar el estante ajustable.....	583
4.8.2 Montar el estante ajustable .....	583
4.9 Sustituir el estante flexible .....	584
4.9.1 Retirar el estante flexible.....	584
4.9.2 Montar el estante flexible .....	584
4.10 Sustituir el set de desayuno .....	585
4.10.1 Retirar el set de desayuno .....	585
4.10.2 Montar el set de desayuno .....	585
4.11 Sustituir la bandeja botellero.....	586
4.11.1 Extraer la bandeja botellero.....	586
4.11.2 Montar la bandeja botellero .....	586
4.12 Sustituir el estante de la puerta .....	587
4.12.1 Extraer el estante de la puerta.....	587
4.12.2 Montar el estante de la puerta .....	587
4.13 Sustituir el cajón de productos congelados .....	588
4.13.1 Extraer el cajón de productos congelados.....	588
4.13.2 Montar el cajón de productos congelados .....	588
4.14 Sustituir el cajón .....	589
4.14.1 Extraer el cajón .....	589
4.14.2 Montar el cajón.....	589
4.15 Sustituir el cajón extraíble.....	590
4.15.1 Retirar el cajón extraíble .....	590
4.15.2 Montar el cajón extraíble .....	590
4.16 Sustituir el foco LED.....	591
4.16.1 Desmontar el foco LED .....	591
4.16.2 Montar el foco LED.....	591
4.17 Sustituir la iluminación LED superior .....	592
4.17.1 Desmontar la iluminación LED .....	592
4.17.2 Montar la iluminación LED superior .....	593
4.18 Sustituir la barra de luz LED lateral .....	594
4.18.1 Retirar la barra de luz LED lateral.....	594
4.18.2 Montar la barra de luz LED lateral .....	595

# **i** En relación con este documento

## 1.1 Información importante

### 1.1.1 Finalidad

Estas indicaciones de reparación sirven como ayuda al consumidor para reparar aparatos por su cuenta conforme al reglamento aplicable sobre diseño ecológico (a partir de 03/2021).

Contienen información sobre cómo sustituir repuestos determinados e incluye las advertencias y los riesgos.

En caso de dudas, póngase en contacto con nuestro departamento de atención al cliente. Solo asumiremos la responsabilidad por daños si las indicaciones de reparación se han seguido correctamente.

## 1.2 Explicación de símbolos generales

### 1.2.1 Niveles de peligrosidad

Los niveles de peligro consisten en un símbolo y una palabra de advertencia. La palabra de advertencia identifica la gravedad del peligro.





Nivel de peligro	Significado
 <b>PELIGRO</b>	Si no se tiene en cuenta la advertencia, ocasionará la muerte o lesiones graves.
 <b>ADVERTENCIA</b>	Si no se tiene en cuenta la advertencia, puede ocasionar la muerte o lesiones graves.
 <b>PRECAUCIÓN</b>	Si no se tiene en cuenta la advertencia, puede ocasionar lesiones de carácter leve.
<b>ATENCIÓN</b>	Si no se tiene en cuenta la advertencia, puede ocasionar daños materiales.

Tabla 1: Niveles de peligrosidad

### 1.2.2 Símbolos de peligro

Los símbolos de peligro son una representación simbólica que indica el tipo de peligrosidad.

En este documento se utilizan los siguientes símbolos de peligro:

Símbolo de peligro	Significado
	Advertencia general
	Peligro de lesiones por corriente eléctrica
	Riesgo de explosión
	Peligro de lesiones a causa de cortes

## **i** En relación con este documento





Símbolo de peligro	Significado
	Peligro de lesiones por aplastamiento
	Peligro de lesiones por superficies calientes
	Peligro a causa de campos magnéticos de gran potencia
	Peligro derivado de radiación no ionizante

Tabla 2: Símbolos de peligro

### 1.2.3 Estructura de las advertencias

Las advertencias de este documento tienen una apariencia y una estructura uniformes.

	<div style="background-color: red; color: white; padding: 2px; text-align: center;"><b>⚠ PELIGRO</b></div> <p><b>¡Tipo y fuente del peligro!</b> Posibles consecuencias de ignorar el peligro / la advertencia.</p> <ul style="list-style-type: none"> <li>▶ Medidas y prohibiciones para prevenir el peligro.</li> </ul>
--	---

El ejemplo siguiente muestra una advertencia de descarga eléctrica a causa de piezas o partes cargadas con tensión. Se menciona la medida para evitar el peligro.

	<div style="background-color: red; color: white; padding: 2px; text-align: center;"><b>⚠ PELIGRO</b></div> <p><b>¡Riesgo de descarga eléctrica debido a partes con tensión!</b> Muerte por electrocución</p> <ul style="list-style-type: none"> <li>▶ Desconectar el aparato de la red al menos 60 segundos antes de comenzar con la reparación.</li> </ul>
--	---

### 1.2.4 Símbolos generales

En este documento se utilizan los siguientes símbolos generales:

Símbolo general	Significado
	Identificación de una indicación especial (texto y/o gráfico)







Símbolo general	Significado
	Identificación de un consejo simple (solo texto)
	Identificación de un enlace a un video tutorial
	Identificación de una herramienta requerida
	Identificación de una condición previa (prerrequisito)
	Identificación de una condición (si ..., entonces ...)
	Identificación de un resultado
Iniciar	Identificación de una tecla o botón
[00123456]	Identificación de un número de material
Estado	Identificación del texto / ventana mostrado (en el display del aparato)

Tabla 3: Símbolos generales

## 2.1 Instrucciones generales de seguridad

### 2.1.1 Todos los aparatos electrodomésticos

#### ¡Riesgo de descarga eléctrica debido a piezas con tensión!

- ¡Los errores en las reparaciones que incluyan componentes eléctricos pueden provocar una descarga eléctrica!
- Desconectar el aparato de la red durante al menos 60 segundos antes de comenzar con el trabajo.
- Después de la reparación, encargar una prueba de seguridad conforme a VDE 0701 o los reglamentos específicos del país.

#### ¡Riesgo de lesiones debido a bordes afilados!

- Usar guantes de protección.

#### Riesgo de aplastamiento durante la reparación, mantenimiento, resolución de problemas y servicio debido a componentes pesados y móviles

- Usar calzado de seguridad.
- Asegure los componentes pesados para que no se caigan.
- No pegue partes del cuerpo en componentes móviles.

#### ¡Riesgo para la seguridad/el funcionamiento del aparato!

- Utilizar únicamente los repuestos originales.

#### ¡Riesgo de daños de los componentes sensibles a cargas electrostáticas (ESD)!

- No tocar los módulos, incluidas las conexiones y las pistas conductoras.

## Herramientas y auxiliares

Designación	Detalles	Imágenes
Paño de protección [00342013]	60 cm x 50 cm	
Juego de destornilladores de precisión [00341820]	9 piezas, 2.0 mm, 2.4 mm, 3.0 mm, PH0, PH00, PH1, TX6, TX8, TX9	
Herramienta auxiliar [00342180]	Para desmontaje de piezas de plástico, "magic tool"	
Ventosa [00342224]	Ø 50 mm	
Punta Torx TX20 [00340865]	6,3 mm (1/4")	
Destornillador plano	Punta 10 mm x 1,6 mm x 200 mm	

## Reparación



### 4.1 Sustituir la junta de la puerta

#### Requisito:



- La puerta está abierta.

## 4.2 Sustituir el tirador de la puerta

### Herramientas sugeridas:

-  Punta Torx TX20                      6,3 mm (1/4")                      [00340865]
-  Destornillador plano                      Punta 10 mm x 1,6 mm x 200 mm

### Requisito:

-  El aparato está desconectado del suministro eléctrico.
-  La puerta está abierta.

### 4.2.1 Retirar el tirador de la puerta

- ▶ 1. Retirar las tapas de los dos tornillos (1).
- ▶ 2. Desatornillar los dos tornillos (2).
- ▶ 3. Retirar el tirador de la puerta (3).

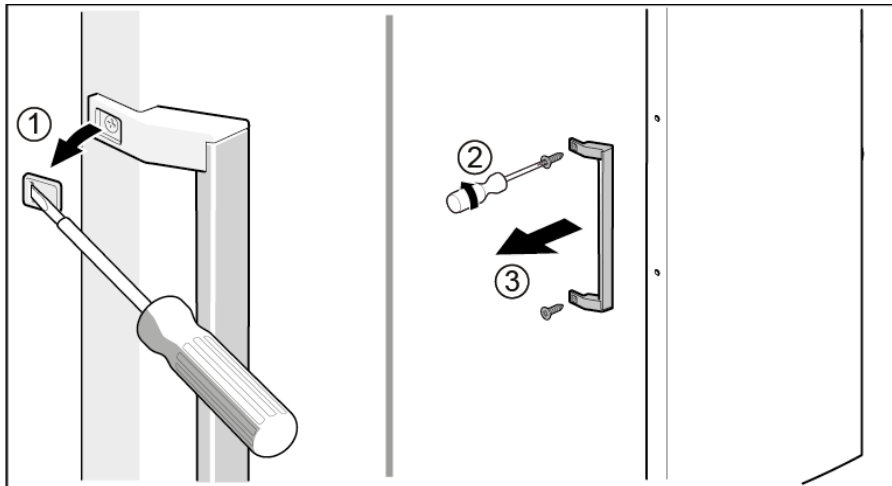

 Se ha retirado el tirador de la puerta.



El tirador de la segunda puerta puede retirarse del mismo modo.

### 4.2.2 Montar el tirador de la puerta

- ▶ Montar en orden inverso.

## 4.3 Sustituir la bisagra superior de la puerta

Herramientas sugeridas:

Punta Torx TX20 6,3 mm (1/4") [00340865]

	<b>ADVERTENCIA</b> <b>¡Aparatos pesados y voluminosos!</b> Espalda y lesiones musculares <ul style="list-style-type: none"><li>▶ La operación de extraer la puerta del aparato solo deben llevarla a cabo especialistas formados.</li><li>▶ Para mover el aparato se necesitan dos personas.</li><li>▶ Utilizar únicamente herramientas y equipos apropiados.</li></ul>
--	---

	<b>PRECAUCIÓN</b> <b>¡Bordes o cantos cortantes!</b> Peligro de cortes <ul style="list-style-type: none"><li>▶ Usar guantes de seguridad.</li></ul>
--	---

	<b>ADVERTENCIA</b> <b>¡Deslizamiento de aparatos inclinados!</b> Fracturas óseas / lesiones por aplastamiento <ul style="list-style-type: none"><li>▶ Asegurar los electrodomésticos contra deslizamientos.</li></ul>
--	---

	<b>PRECAUCIÓN</b> <b>¡Riesgo de que se caigan piezas debido a los tornillos aflojados!</b> Peligro de lesiones debido a piezas que caigan. <ul style="list-style-type: none"><li>▶ Asegure el componente para que no se caiga.</li></ul>
---	--

	<b>ATENCIÓN</b> <b>¡Riesgo de que se caigan piezas debido a los tornillos aflojados!</b> Daños en otras partes del aparato o en el domicilio del consumidor, p. ej., en la parte inferior. <ul style="list-style-type: none"><li>▶ Asegure el componente para que no se caiga.</li></ul>
--	--

Requisito:

- ✓ El aparato está desconectado del suministro eléctrico.
- ✓ Se han retirado los accesorios del interior del aparato.

### 4.3.1 Desmontar la bisagra superior de la puerta

1. Colocar el aparato sobre su lado posterior.

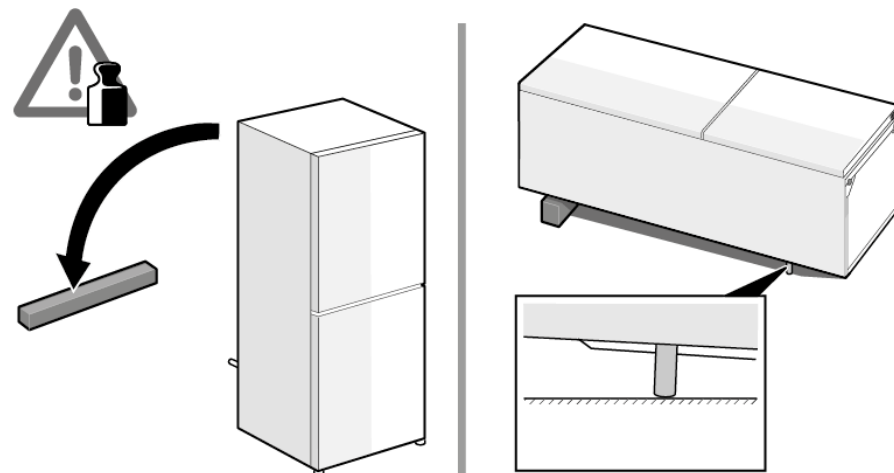

## Reparación

2. 1. Presionar la tapa de la bisagra superior en ambos lados (1).
2. Sacar la tapa de la bisagra superior (2).
3. Girar la tapa de la bisagra (3).
4. Retirar la tapa de la bisagra superior (4).
5. Desatornillar los dos tornillos (5).
6. Retirar la bisagra superior (6).

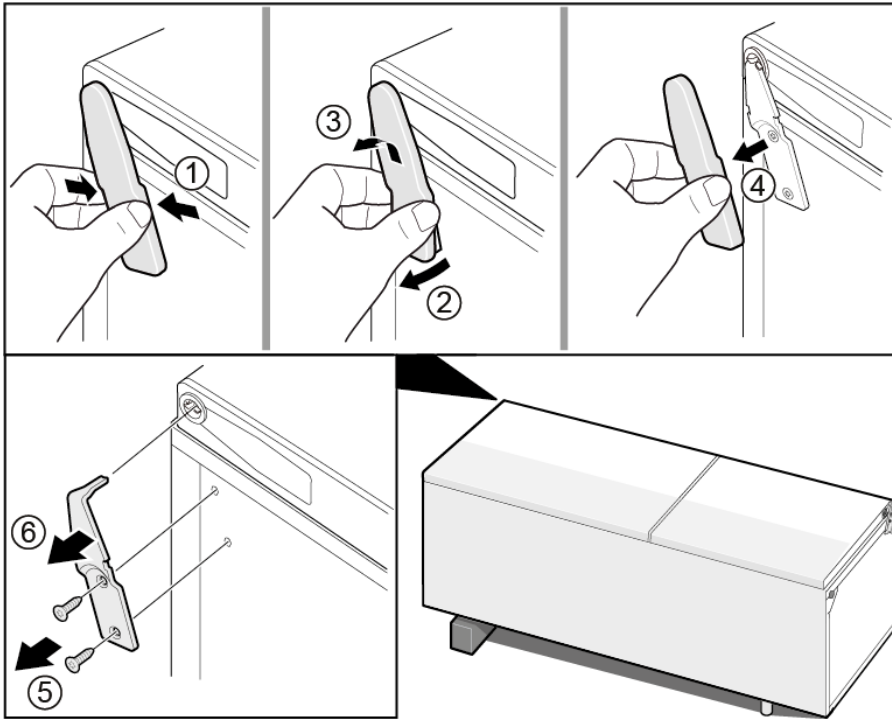

 Se ha retirado la bisagra superior.

### 4.3.2 Montar la bisagra superior de la puerta

- ▶ Montar en orden inverso.

## 4.4 Sustituir la bisagra superior de la puerta (puerta con display)

Herramientas sugeridas:

Punta Torx TX20 6,3 mm (1/4") [00340865]

	<b>⚠ ADVERTENCIA</b>
	<p><b>¡Aparatos pesados y voluminosos!</b> Espalda y lesiones musculares</p> <ul style="list-style-type: none"> <li>▶ La operación de extraer la puerta del aparato solo deben llevarla a cabo especialistas formados.</li> <li>▶ Para mover el aparato se necesitan dos personas.</li> <li>▶ Utilizar únicamente herramientas y equipos apropiados.</li> </ul>

	<b>⚠ PRECAUCIÓN</b>
	<p><b>¡Bordes o cantos cortantes!</b> Peligro de cortes</p> <ul style="list-style-type: none"> <li>▶ Usar guantes de seguridad.</li> </ul>

	<b>⚠ ADVERTENCIA</b>
	<p><b>¡Deslizamiento de aparatos inclinados!</b> Fracturas óseas / lesiones por aplastamiento</p> <ul style="list-style-type: none"> <li>▶ Asegurar los electrodomésticos contra deslizamientos.</li> </ul>

	<b>⚠ PRECAUCIÓN</b>
	<p><b>¡Riesgo de que se caigan piezas debido a los tornillos aflojados!</b> Peligro de lesiones debido a piezas que caigan.</p> <ul style="list-style-type: none"> <li>▶ Asegure el componente para que no se caiga.</li> </ul>

	<b>⚠ ATENCION</b>
	<p><b>¡Riesgo de que se caigan piezas debido a los tornillos aflojados!</b> Daños en otras partes del aparato o en el domicilio del consumidor, p. ej., en la parte inferior.</p> <ul style="list-style-type: none"> <li>▶ Asegure el componente para que no se caiga.</li> </ul>

	<b>⚠ PELIGRO</b>
	<p><b>¡Riesgo de descarga eléctrica debido a piezas con tensión!</b> Peligro mortal por descarga eléctrica en caso de reparación inadecuada</p> <ul style="list-style-type: none"> <li>▶ Las piezas eléctricas deberían ser reparadas por electricistas cualificados.</li> <li>▶ Después de la reparación, encargar una prueba de seguridad conforme a VDE 0701 o los reglamentos específicos del país.</li> </ul>

	<b>⚠ PELIGRO</b>
	<p><b>¡Riesgo de descarga eléctrica debido a partes con tensión!</b> Muerte por electrocución</p> <ul style="list-style-type: none"> <li>▶ Desconectar el aparato de la red al menos 60 segundos antes de comenzar con la reparación.</li> </ul>

Requisito:

- ✓ El aparato está desconectado del suministro eléctrico.
- ✓ Se han retirado los accesorios del interior del aparato.

### 4.4.1 Desmontar la bisagra superior de la puerta

1. Colocar el aparato sobre su lado posterior.

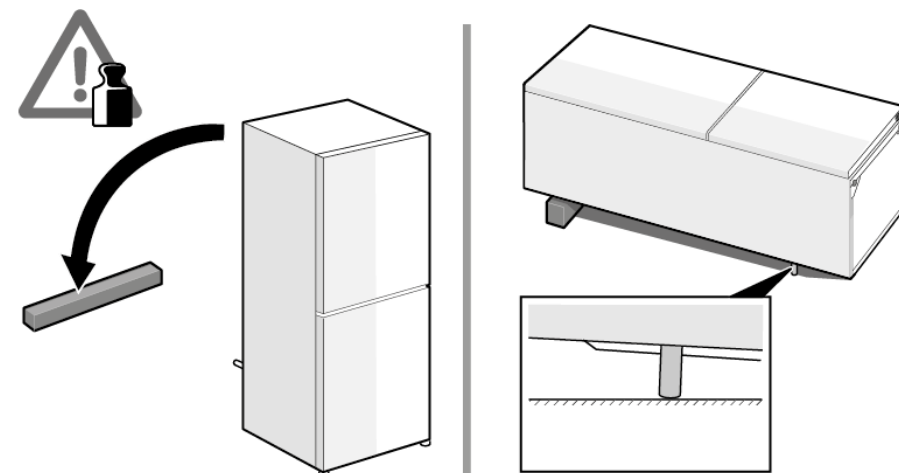

## Reparación

2. 1. Retirar la tapa de la bisagra superior (1).
2. Retirar la tapa de la caja de cables (2).
3. Desconectar la conexión eléctrica (3).
4. Desatornillar el tornillo de la conexión a tierra (4).
5. Retirar la protección de cables (5).
6. Desatornillar el tornillo (6)

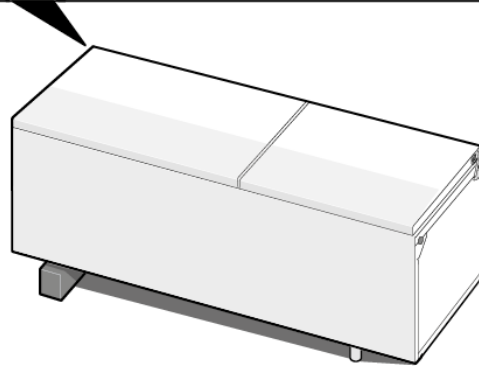
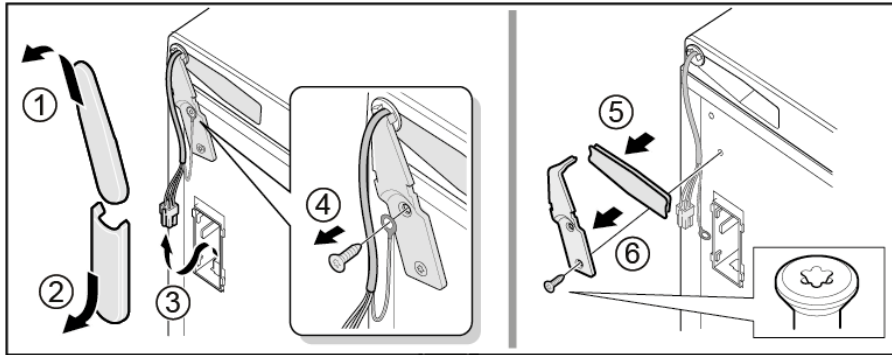

 Se ha retirado la bisagra superior.

### 4.4.2 Montar la bisagra superior de la puerta

- ▶ Montar en orden inverso.

## 4.5 Sustituir la bisagra central de la puerta

### Herramientas sugeridas:

🔧 Punta Torx TX20      6,3 mm (1/4")      [00340865]

	<b>⚠️ ADVERTENCIA</b>
	<b>¡Aparatos pesados y voluminosos!</b> Espalda y lesiones musculares <ul style="list-style-type: none"><li>▶ La operación de extraer la puerta del aparato solo deben llevarla a cabo especialistas formados.</li><li>▶ Para mover el aparato se necesitan dos personas.</li><li>▶ Utilizar únicamente herramientas y equipos apropiados.</li></ul>

	<b>⚠️ PRECAUCIÓN</b>
	<b>¡Bordes o cantos cortantes!</b> Peligro de cortes <ul style="list-style-type: none"><li>▶ Usar guantes de seguridad.</li></ul>

	<b>⚠️ ADVERTENCIA</b>
	<b>¡Deslizamiento de aparatos inclinados!</b> Fracturas óseas / lesiones por aplastamiento <ul style="list-style-type: none"><li>▶ Asegurar los electrodomésticos contra deslizamientos.</li></ul>

	<b>⚠️ PRECAUCIÓN</b>
	<b>¡Riesgo de que se caigan piezas debido a los tornillos aflojados!</b> Peligro de lesiones debido a piezas que caigan. <ul style="list-style-type: none"><li>▶ Asegure el componente para que no se caiga.</li></ul>

	<b>⚠️ ATENCION</b>
	<b>¡Riesgo de que se caigan piezas debido a los tornillos aflojados!</b> Daños en otras partes del aparato o en el domicilio del consumidor, p. ej., en la parte inferior. <ul style="list-style-type: none"><li>▶ Asegure el componente para que no se caiga.</li></ul>

### Requisito:

- ✔ El aparato está desconectado del suministro eléctrico.
- ✔ Se han retirado los accesorios del interior del aparato.
- ✔ Se ha retirado la bisagra superior de la puerta.

✔ Se ha retirado la puerta superior.

### 4.5.1 Desmontar la bisagra central de la puerta

- ▶ 1. Extraer la puerta del refrigerador (1).
- ▶ 2. Desatornillar los dos tornillos (2).
- ▶ 3. Retirar la bisagra central (3).

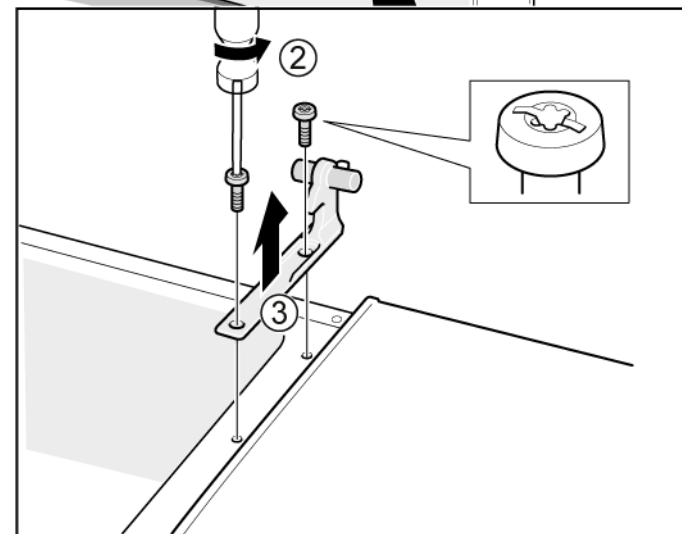
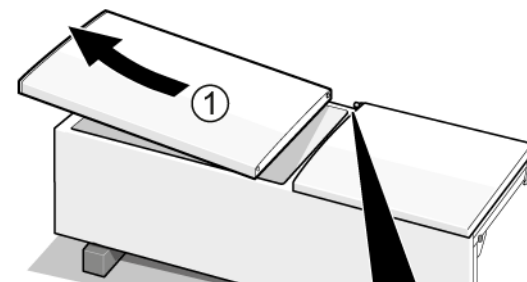

➡ Se ha retirado la bisagra central.

### 4.5.2 Montar la bisagra central de la puerta

- ▶ Montar en orden inverso.

## 4.6 Sustituir la bisagra inferior de la puerta

### Herramientas sugeridas:

🔧 Punta Torx TX20      6,3 mm (1/4")      [00340865]

	<b>⚠️ ADVERTENCIA</b>
	<p><b>¡Aparatos pesados y voluminosos!</b> Espalda y lesiones musculares</p> <ul style="list-style-type: none"> <li>▶ La operación de extraer la puerta del aparato solo deben llevarla a cabo especialistas formados.</li> <li>▶ Para mover el aparato se necesitan dos personas.</li> <li>▶ Utilizar únicamente herramientas y equipos apropiados.</li> </ul>

	<b>⚠️ PRECAUCIÓN</b>
	<p><b>¡Bordes o cantos cortantes!</b> Peligro de cortes</p> <ul style="list-style-type: none"> <li>▶ Usar guantes de seguridad.</li> </ul>

	<b>⚠️ ADVERTENCIA</b>
	<p><b>¡Deslizamiento de aparatos inclinados!</b> Fracturas óseas / lesiones por aplastamiento</p> <ul style="list-style-type: none"> <li>▶ Asegurar los electrodomésticos contra deslizamientos.</li> </ul>

	<b>⚠️ PRECAUCIÓN</b>
	<p><b>¡Riesgo de que se caigan piezas debido a los tornillos aflojados!</b> Peligro de lesiones debido a piezas que caigan.</p> <ul style="list-style-type: none"> <li>▶ Asegure el componente para que no se caiga.</li> </ul>

	<b>⚠️ ATENCION</b>
	<p><b>¡Riesgo de que se caigan piezas debido a los tornillos aflojados!</b> Daños en otras partes del aparato o en el domicilio del consumidor, p. ej., en la parte inferior.</p> <ul style="list-style-type: none"> <li>▶ Asegure el componente para que no se caiga.</li> </ul>

### Requisito:

- ✔ El aparato está desconectado del suministro eléctrico.
- ✔ Se han retirado los accesorios del interior del aparato.
- ✔ Se ha retirado la bisagra superior.

✔ Se ha retirado la bisagra central.

### 4.6.1 Desmontar la bisagra inferior de la puerta

- ▶ 1. Extraer la puerta del congelador (1).
- ▶ 2. Desatornillar el tornillo (2).
- ▶ 3. Girar la bisagra inferior hacia fuera (3).
- ▶ 4. Retirar la bisagra inferior (4).

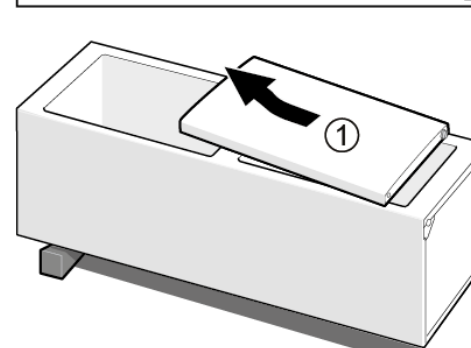
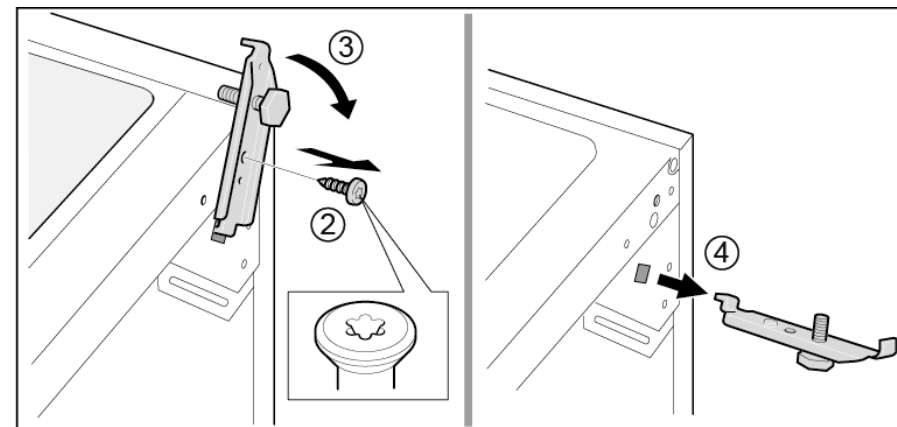

➡ Se ha retirado la bisagra inferior de la puerta.

### 4.6.2 Montar la bisagra inferior de la puerta

- ▶ Montar en orden inverso.

## 4.7 Sustituir el estante

### Requisito:

- ✔ La puerta está abierta.

### 4.7.1 Extraer el estante

- ▶ Sacar el estante.

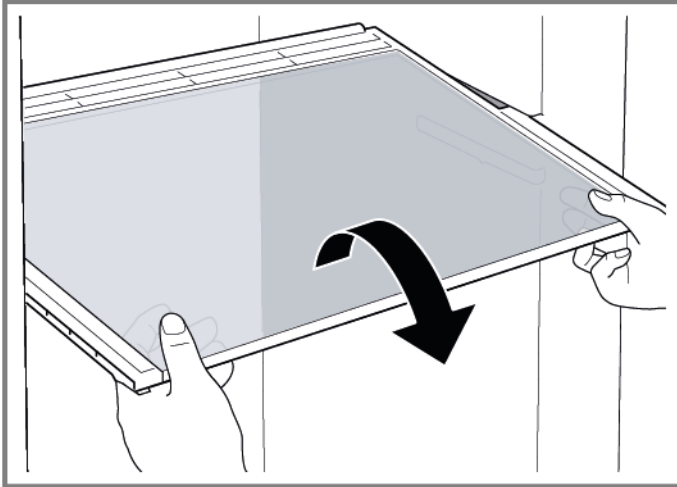

- ➡ Se ha retirado el estante.

### 4.7.2 Montar el estante

- ▶ Montar en orden inverso.

## 4.8 Sustituir el estante ajustable

### Requisito:

- ✔ La puerta está abierta.

### 4.8.1 Retirar el estante ajustable

1. Tirar hacia delante de la sección derecha del estante ajustable (1).
2. Retirar la sección derecha del estante ajustable (2).

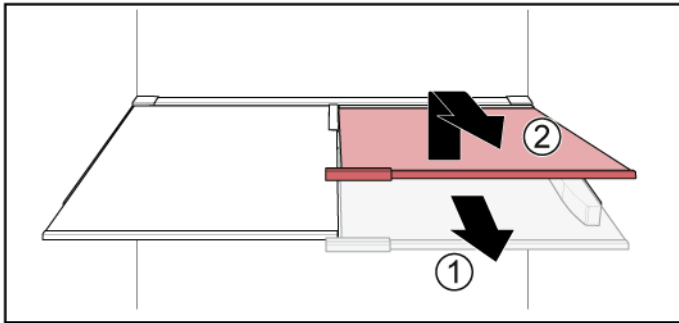

2. Retirar la sección izquierda del estante ajustable de la misma forma.

- ➡ Se ha retirado el estante ajustable.

### 4.8.2 Montar el estante ajustable

- ▶ Montar en orden inverso.

## 4.9 Sustituir el estante flexible

### Requisito:

- ✔ La puerta está abierta.

### 4.9.1 Retirar el estante flexible

- ▶ 1. Retirar la bandeja de cristal (1).
- ▶ 2. Levantar el estante flexible y sacarlo (2).

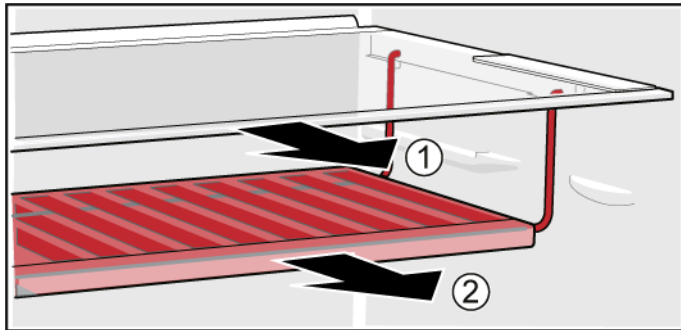

- ➡ Se ha retirado el estante flexible.

### 4.9.2 Montar el estante flexible

- ▶ Montar en orden inverso.

## 4.10 Sustituir el set de desayuno

### Requisito:

- ✔ La puerta está abierta.

### 4.10.1 Retirar el set de desayuno

- ▶ Levantar el set de desayuno y sacarlo.

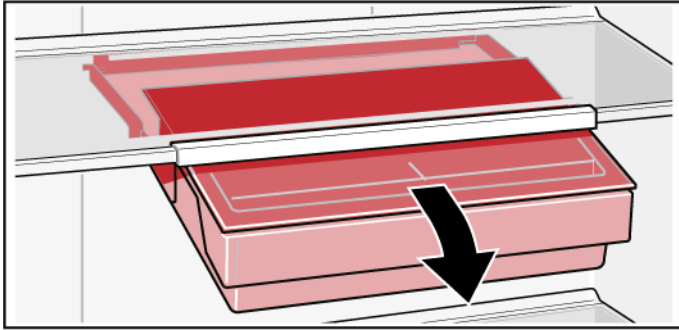

- ➡ Se ha retirado el set de desayuno.

### 4.10.2 Montar el set de desayuno

- ▶ Montar en orden inverso.

## 4.11 Sustituir la bandeja botellero

### Requisito:

- ✔ La puerta está abierta.

### 4.11.1 Extraer la bandeja botellero

- ▶ Sacar la bandeja botellero.

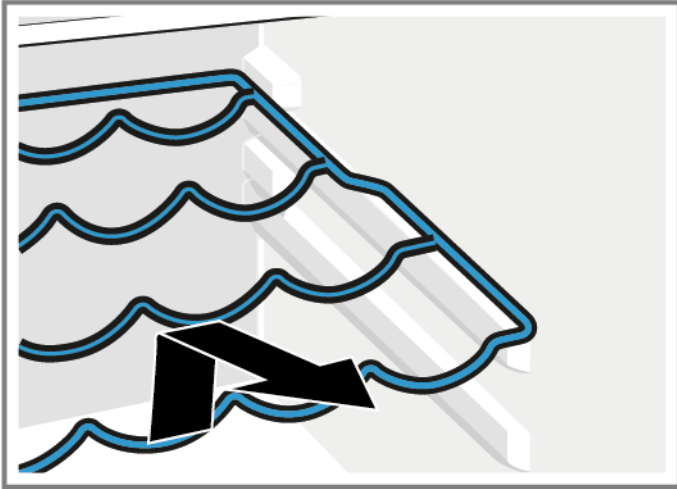

- ➡ Se ha retirado la bandeja botellero.

### 4.11.2 Montar la bandeja botellero

- ▶ Montar en orden inverso.

## 4.12 Sustituir el estante de la puerta

### Requisito:

- ✔ La puerta está abierta.

### 4.12.1 Extraer el estante de la puerta

- ▶ Sacar hacia arriba el estante de la puerta.

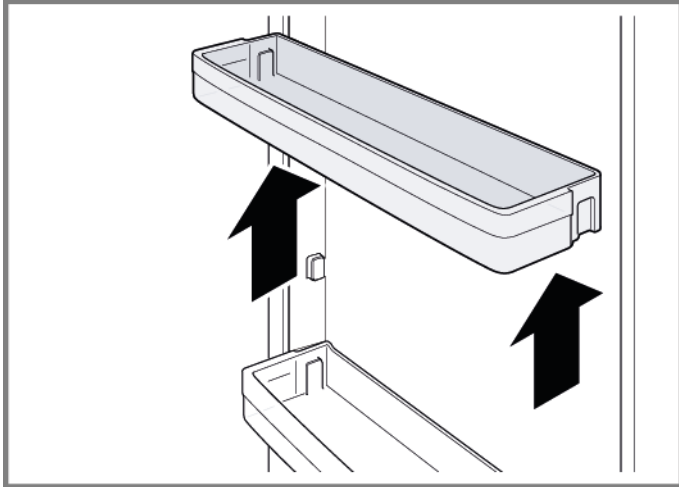

➡ Se ha retirado el estante de la puerta.

### 4.12.2 Montar el estante de la puerta

- ▶ Montar en orden inverso.

## 4.13 Sustituir el cajón de productos congelados

### Requisito:

- ✔ La puerta está abierta.

### 4.13.1 Extraer el cajón de productos congelados

- ▶ 1. Sacar por completo el cajón de productos congelados (1).
- ▶ 2. Extraer el cajón para alimentos (2).

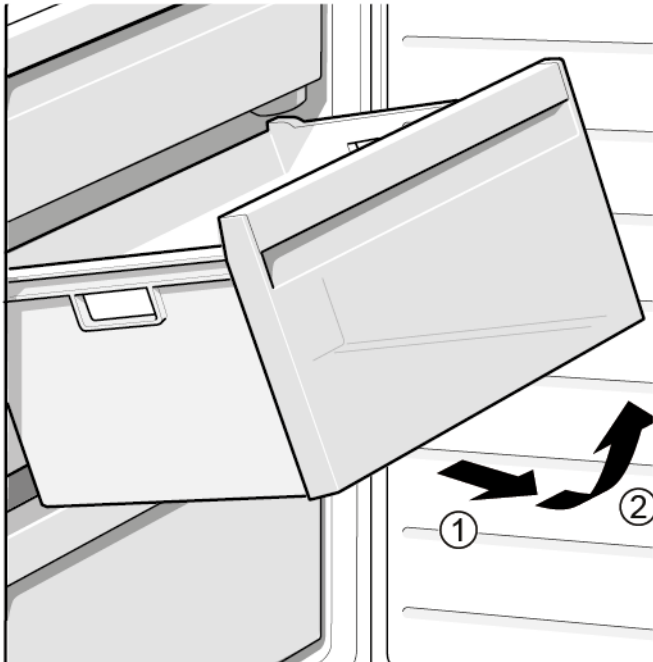

- ➡ Se ha retirado el cajón de productos congelados.

### 4.13.2 Montar el cajón de productos congelados

- ▶ Montar en orden inverso.

## 4.14 Sustituir el cajón

### Requisito:

- ✔ La puerta está abierta.

### 4.14.1 Extraer el cajón

- ▶ 1. Sacar el cajón inferior del frigorífico (1).
- ▶ 2. Sacar el cajón superior del frigorífico (2).

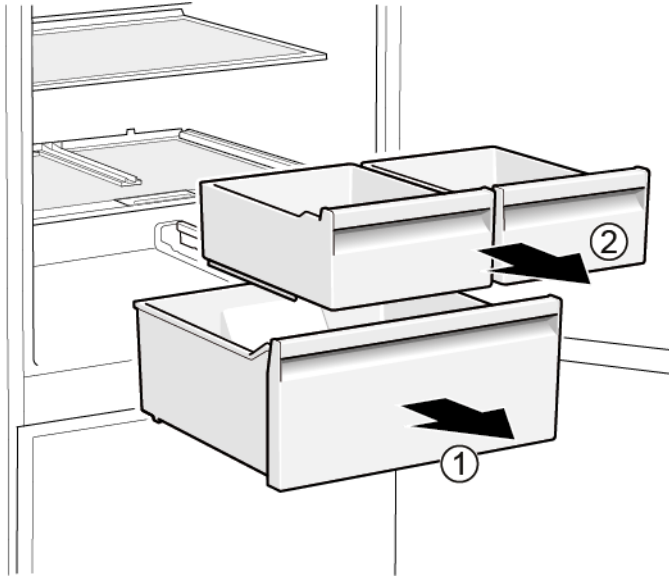

- ➡ Se han extraído los cajones.

### 4.14.2 Montar el cajón

- ▶ Montar en orden inverso.

## 4.15 Sustituir el cajón extraíble

### Requisito:

- ✔ La puerta está abierta.

### 4.15.1 Retirar el cajón extraíble

- ▶ 1. Sacar por completo el cajón extraíble (1).
- ▶ 2. Retirar el cajón extraíble (2).

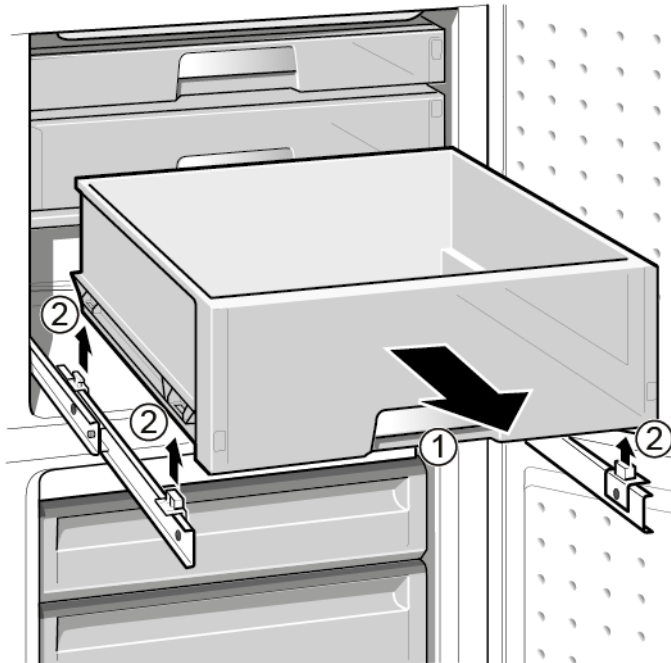

- ➡ Se ha retirado el cajón extraíble.

### 4.15.2 Montar el cajón extraíble

- ▶ Montar en orden inverso.

## 4.16 Sustituir el foco LED

### Herramientas sugeridas:

Herramienta especial [00342180]



Su aparato cuenta con una iluminación LED exenta de mantenimiento.  
¡Solo el servicio de atención al cliente o los técnicos autorizados pueden reparar esta iluminación!



### PELIGRO

**¡Riesgo de descarga eléctrica debido a piezas con tensión!**  
Peligro mortal por descarga eléctrica en caso de reparación inadecuada

- ▶ Las piezas eléctricas deberían ser reparadas por electricistas cualificados.
- ▶ Después de la reparación, encargar una prueba de seguridad conforme a VDE 0701 o los reglamentos específicos del país.



### PELIGRO

**¡Riesgo de descarga eléctrica debido a partes con tensión!**  
Muerte por electrocución

- ▶ Desconectar el aparato de la red al menos 60 segundos antes de comenzar con la reparación.



### PRECAUCIÓN

**¡Bordes o cantos cortantes!**  
Peligro de cortes

- ▶ Usar guantes de seguridad.

### Requisito:

- ✓ El aparato está desconectado del suministro eléctrico.
- ✓ La puerta está abierta.

## 4.16.1 Desmontar el foco LED

1. Utilizar una herramienta especial para sacar el foco LED (1).

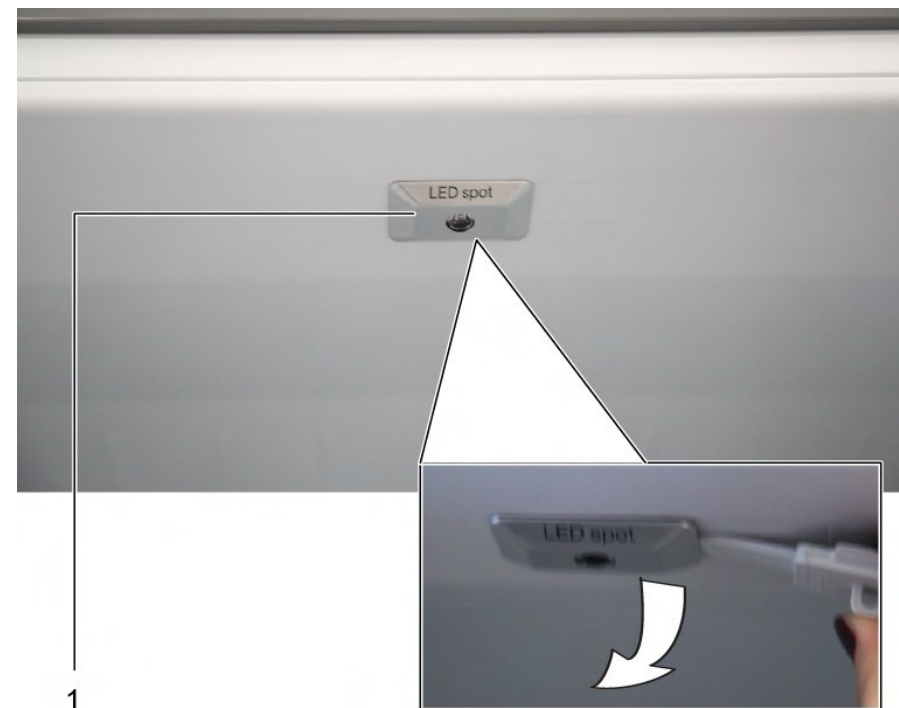

2. Desconectar las conexiones eléctricas del foco LED.

➡ Se ha retirado el foco LED.

## 4.16.2 Montar el foco LED

- ▶ Montar en orden inverso.

## 4.17 Sustituir la iluminación LED superior

### Herramientas sugeridas:

- Destornillador plano Punta 2,4 mm x 0,4 mm x 60 mm, en el kit [00341820]



Su aparato cuenta con una iluminación LED exenta de mantenimiento.  
¡Solo el servicio de atención al cliente o los técnicos autorizados pueden reparar esta iluminación!



### PELIGRO

#### ¡Riesgo de descarga eléctrica debido a piezas con tensión!

Peligro mortal por descarga eléctrica en caso de reparación inadecuada

- ▶ Las piezas eléctricas deberían ser reparadas por electricistas cualificados.
- ▶ Después de la reparación, encargar una prueba de seguridad conforme a VDE 0701 o los reglamentos específicos del país.



### PELIGRO

#### ¡Riesgo de descarga eléctrica debido a partes con tensión!

Muerte por electrocución

- ▶ Desconectar el aparato de la red al menos 60 segundos antes de comenzar con la reparación.



### PRECAUCIÓN

#### ¡Bordes o cantos cortantes!

Peligro de cortes

- ▶ Usar guantes de seguridad.

### Requisito:

- ✓ El aparato está desconectado del suministro eléctrico.
- ✓ La puerta está abierta.
- ✓ Se han retirado los accesorios superiores del interior.

### 4.17.1 Desmontar la iluminación LED

1. Mover la iluminación LED hacia el lado izquierdo.

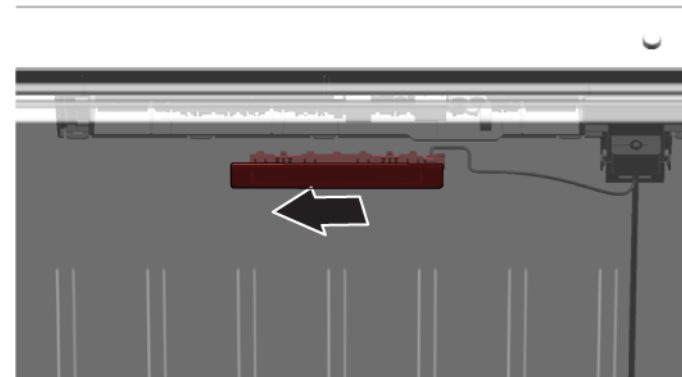

- ➡ Se ha desconectado la conexión eléctrica de la iluminación LED.

2. Soltar los ganchos de la iluminación LED.

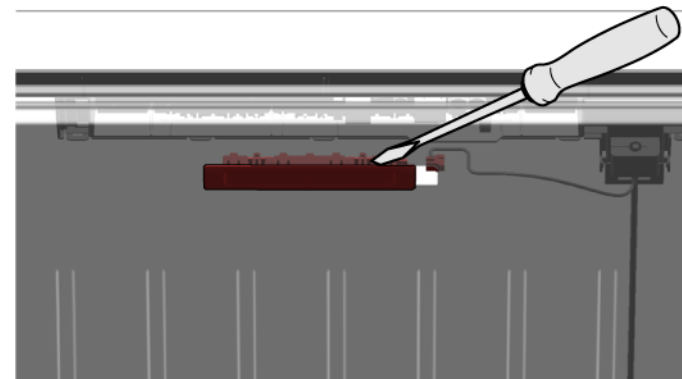

## Reparación

3. Retirar la iluminación LED moviéndola hacia delante.

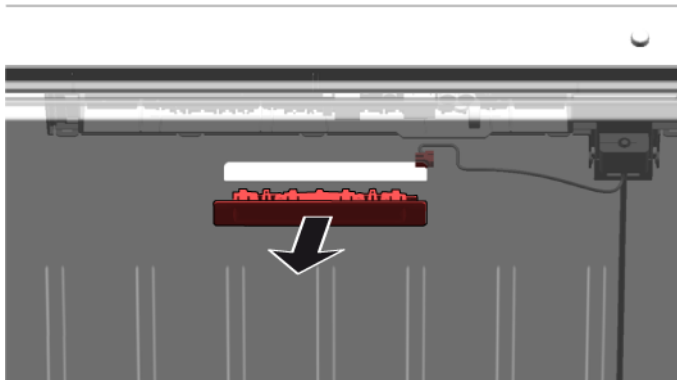

- ➡ Se ha retirado la iluminación LED.

### 4.17.2 Montar la iluminación LED superior

- ▶ Montar en orden inverso.

## 4.18 Sustituir la barra de luz LED lateral

### Herramientas sugeridas:

Ventosa Ø50 mm [00342224]



Su aparato cuenta con una iluminación LED exenta de mantenimiento.  
¡Solo el servicio de atención al cliente o los técnicos autorizados pueden reparar esta iluminación!



### PELIGRO

**¡Riesgo de descarga eléctrica debido a piezas con tensión!**  
Peligro mortal por descarga eléctrica en caso de reparación inadecuada

- ▶ Las piezas eléctricas deberían ser reparadas por electricistas cualificados.
- ▶ Después de la reparación, encargar una prueba de seguridad conforme a VDE 0701 o los reglamentos específicos del país.



### PELIGRO

**¡Riesgo de descarga eléctrica debido a partes con tensión!**  
Muerte por electrocución

- ▶ Desconectar el aparato de la red al menos 60 segundos antes de comenzar con la reparación.



### PRECAUCIÓN

**¡Bordes o cantos cortantes!**  
Peligro de cortes

- ▶ Usar guantes de seguridad.

### Requisito:

- ✓ El aparato está desconectado del suministro eléctrico.
- ✓ La puerta está abierta.
- ✓ Se han retirado los estantes del refrigerador.

## 4.18.1 Retirar la barra de luz LED lateral

1. Colocar la ventosa en el tercio superior de la barra de luz LED lateral.



## Reparación

2. Con un movimiento de rotación, tirar de la ventosa enganchada a la parte delantera de la barra de luz LED lateral.

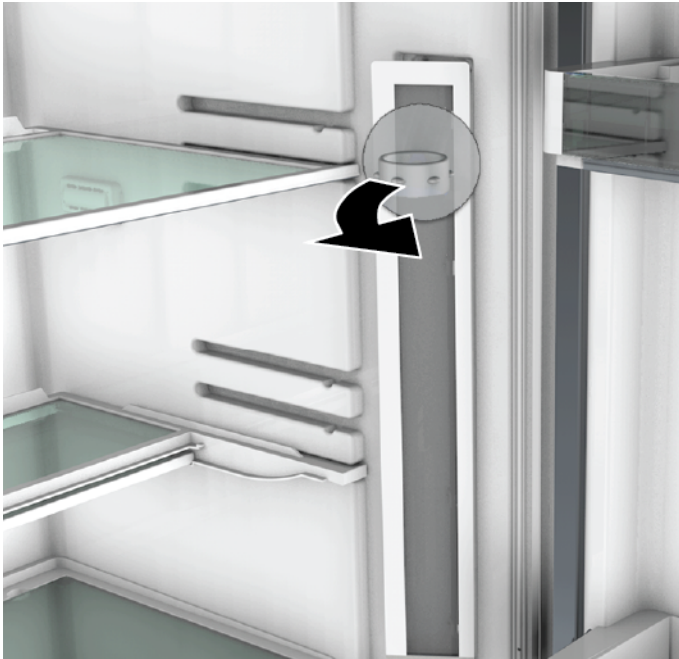





3. Desconectar la conexión eléctrica de la barra de luz LED lateral.  
 Se ha retirado la barra de luz LED lateral.

### 4.18.2 Montar la barra de luz LED lateral

1. Conectar la conexión eléctrica de la barra de luz LED lateral.
  2. Fijar la barra de luz LED lateral en su ubicación en la pared del cajón (los ganchos deben hacer clic).
-  Se ha montado la barra de luz LED lateral.

# Reparationsinformation - Kyl-/fryskombination

 <b>Om detta dokument</b> .....	<b>597</b>		
1.1 Viktig information.....	597		
1.1.1 Syfte .....	597		
1.2 Symbolförklaringar.....	597		
1.2.1 Faronivåer .....	597		
1.2.2 Risksymboler.....	597		
1.2.3 Varningarnas struktur.....	598		
1.2.4 Allmänna symboler.....	598		
 <b>Säkerhet</b> .....	<b>599</b>		
2.1 Allmänna säkerhetsanvisningar .....	599		
2.1.1 Alla hushållsmaskiner.....	599		
 <b>Verktyg och hjälpmedel</b> .....	<b>600</b>		
 <b>Reparation</b> .....	<b>601</b>		
4.1 Byta dörrpackning.....	601		
4.2 Byta dörrhandtag.....	602		
4.2.1 Ta bort dörrhandtag .....	602		
4.2.2 Montera dörrhandtag.....	602		
4.3 Byta dörrens övre gångjärn .....	603		
4.3.1 Ta bort dörrens övre gångjärn.....	603		
4.3.2 Montera dörrens övre gångjärn .....	604		
4.4 Byta dörrens övre gångjärn (dörr med display) .....	605		
4.4.1 Ta bort dörrens övre gångjärn.....	605		
4.4.2 Montera dörrens övre gångjärn .....	606		
4.5 Byta dörrens mellersta gångjärn .....	607		
4.5.1 Ta bort dörrens mellersta gångjärn.....	607		
4.5.2 Montera dörrens mellersta gångjärn .....	607		
4.6 Byta dörrens nedre gångjärn .....	608		
4.6.1 Ta bort dörrens nedre gångjärn.....	608		
4.6.2 Montera dörrens nedre gångjärn .....	608		
4.7 Byta hylla .....	609		
4.7.1 Ta bort hylla.....	609		
4.7.2 Montera hylla .....	609		
4.8 Byte av den flyttbara hyllan .....	610		
4.8.1 Borttagning av den flyttbara hyllan .....	610		
4.8.2 Montering av den flyttbara hyllan .....	610		
4.9 Byte av den böjliga hyllan .....	611		
4.9.1 Borttagning av den böjliga hyllan .....	611		
4.9.2 Montering av böjlig hylla.....	611		
4.10 Byte av frukostgruppen.....	612		
4.10.1 Borttagning av frukostgruppen.....	612		
4.10.2 Montering av frukostgruppen.....	612		
4.11 Byta flaskhylla.....	613		
4.11.1 Ta bort flaskhylla .....	613		
4.11.2 Montera flaskhylla.....	613		
4.12 Byta dörrhylla.....	614		
4.12.1 Ta bort dörrhylla .....	614		
4.12.2 Montera dörrhylla .....	614		
4.13 Byta fack för frysta matvaror .....	615		
4.13.1 Ta bort fack för frysta matvaror.....	615		
4.13.2 Montera fack för frysta matvaror .....	615		
4.14 Byta fack .....	616		
4.14.1 Ta bort fack .....	616		
4.14.2 Montera låda .....	616		
4.15 Byta utdragbar låda .....	617		
4.15.1 Ta bort utdragbar låda .....	617		
4.15.2 Montera utdragbar låda.....	617		
4.16 Byta LED-spotlight .....	618		
4.16.1 Ta bort LED-spotlight .....	618		
4.16.2 Montera LED-spotlight .....	618		
4.17 Byta översta LED-lampan.....	619		
4.17.1 Ta bort LED-lampan .....	619		
4.17.2 Montera översta LED-lampan.....	620		
4.18 Byta LED-sidoramplampa.....	621		
4.18.1 Ta bort LED-sidoramplampa .....	621		
4.18.2 Montera LED-sidoramplampa.....	622		

# i Om detta dokument

## 1.1 Viktig information

### 1.1.1 Syfte

Dessa reparationstips hjälper kunden att själv reparera maskiner enligt gällande ekodesignbestämmelser (som gäller 03/2021).





De innehåller information om hur vissa reservdelar ska bytas samt tillhörande varningar och risker.

Kontakta vår kundtjänst om du har frågor. Vi åtar oss bara ansvar för skador om reparationstipsen har följts korrekt.

## 1.2 Symbolförklaringar

### 1.2.1 Faronivåer

Varningsnivåerna består av en symbol och ett signalord. Signalordet visar hur allvarlig faran är.





Varningsnivå	Innebörd
 <b>FARA!</b>	Om inte varningsmeddelandet följs kommer det att leda till dödsfall eller allvarliga personskador.
 <b>VARNING!</b>	Om inte varningsmeddelandet följs kan det leda till dödsfall eller allvarliga personskador.
 <b>FÖRSIKTIGT!</b>	Om inte varningsmeddelandet följs kan det leda till lättare personskador.
 <b>OBS!</b>	Om inte varningsmeddelandet följs kan det leda till materialskador.

Grafik 1: Faronivåer



### 1.2.2 Risksymboler

Risksymboler är symboler som visar typen av fara.

Följande risksymboler används i detta dokument:

Risksymbol	Innebörd
	Allmänt varningsmeddelande
	Fara på grund av elektrisk spänning
	Explosionsrisk
	Fara för skärskador
	Fara för krosskador



## i Om detta dokument

Risksymbol	Innebörd
	Fara på grund av heta ytor
	Fara på grund av starka magnetfält
	Fara på grund av icke-joniserande strålning

Grafik 2: Risksymboler

### 1.2.3 Varningarnas struktur

Varningar i detta dokument har ett standardiserat utseende och en standardiserad struktur.



	<p> <b>FARA!</b></p> <p><b>Farans typ och ursprung!</b> Möjliga konsekvenser av att faran/varningen ignoreras.</p> <ul style="list-style-type: none"> <li>▶ Åtgärder och förbud för att förebygga faran.</li> </ul>
--	--





Följande exempel visar en varning som varnar för elstötar från strömförande delar. Det står vilken åtgärd som förebygger faran.

	<p> <b>FARA!</b></p> <p><b>Risk för elstötar på grund av strömförande delar!</b> Dödsfall på grund av elstötar</p> <ul style="list-style-type: none"> <li>▶ Koppla bort maskiner från elförsörjningen minst 60 sekunder innan reparationer påbörjas.</li> </ul>
---	---

### 1.2.4 Allmänna symboler

Följande allmänna symboler används i detta dokument:

Allm. symbol	Innebörd
	Identifiering av ett särskilt tips (text och/eller bild)
	Identifiering av ett enkelt tips (endast text)

Allm. symbol	Innebörd
	Identifiering av en länk till en videohandledning
	Identifiering av verktyg som behövs
	Identifiering av villkor som måste vara uppfyllda
	Identifiering av ett tillstånd (om ..., så ...)
	Identifiering av ett resultat
[Start]	Identifiering av en tangent eller knapp
[00123456]	Identifiering av ett materialnummer
Status	Identifiering av text/fönster som visas (i maskinens display)

Grafik 3: Allmänna symboler

## 2.1 Allmänna säkerhetsanvisningar

### 2.1.1 Alla hushållsmaskiner

#### **Risk för elstötar på grund av strömförande delar!**

- Fel vid reparationer som berör elkomponenter kan orsaka elstötar!
- Koppla bort maskinen från elnätet minst 60 sekunder innan arbetet påbörjas.
- Låt utföra ett säkerhetstest efter reparationen, i enlighet med VDE 0701 eller landsspecifika regler.

#### **Risk för personskador på grund av vassa kanter!**

- Använd skyddshandskar.

#### **Risk för krosskador vid reparation, underhåll, felsökning och service på grund av tunga och rörliga komponenter**

- Använd skyddsskor.
- Säkra tunga komponenter så att de inte faller ner.
- Stick inte in kroppsdelar i rörliga komponenter.

#### **Risk för maskinens säkerhet/funktion!**

- Använd endast originaldelar.

#### **Risk för skador på komponenter känsliga för statisk elektricitet (ESD)!**

- Rör inte modulerna samt anslutningar och strömförande ledningar.

## Verktyg och hjälpmedel

Beteckning	Detaljer	Bilder
Skyddstrasa [00342013]	60 cm x 50 cm	
Sats med precisionsskruvmejslar [00341820]	9 delar, 2,0 mm, 2,4 mm, 3,0 mm, PH0, PH00, PH1, TX6, TX8, TX9	
Hjälpverktyg [00342180]	Verktyg för att lossa plastdelar "magic tool"	
Sugkopp [00342224]	Ø 50 mm	
Torxbits TX20 [00340865]	6,3 mm (1/4")	
Spårskruvmejsel	Blad 10 mm x 1,6 mm x 200 mm	

# **Reparation**



## **4.1 Byta dörrpackning**

### **Förutsättning:**



- Dörren är öppen.

## 4.2 Byta dörrhandtag

### Nödvändiga verktyg:

-  Torxbits TX20 6,3 mm (1/4") [00340865]
-  Spårskruvmejsel Blad 10 mm x 1,6 mm x 200 mm

### Förutsättning:

-  Apparaten är bortkopplad från strömförsörjning.
-  Dörren är öppen.

### 4.2.1 Ta bort dörrhandtag

- ▶ 1. Ta bort de två skruvhättorna (1).
- ▶ 2. Skruva ur de två skruvarna (2).
- ▶ 3. Ta bort dörrhandtaget (3).

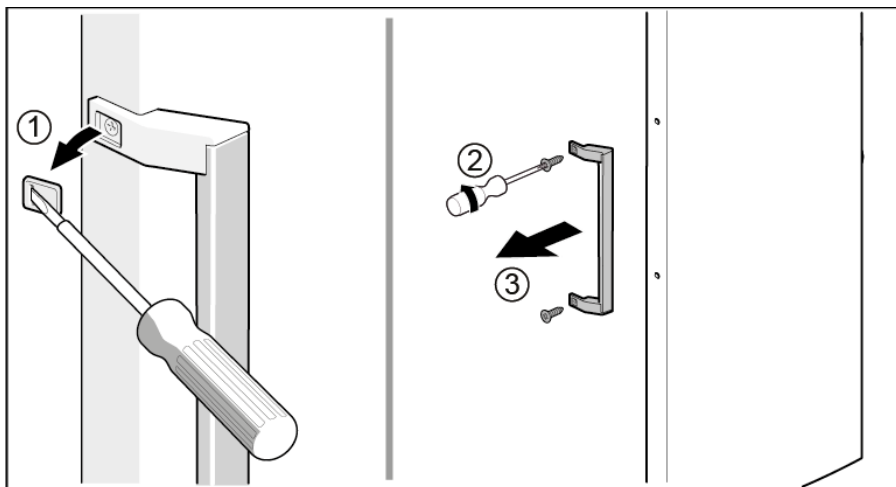

 Dörrhandtaget har tagits bort.



Dörrhandtaget för den andra dörren kan tas bort på samma sätt.

### 4.2.2 Montera dörrhandtag

- ▶ Montera i omvänd ordning.

## 4.3 Byta dörrens övre gångjärn

### Nödvändiga verktyg:

Torxbits TX20

6,3 mm (1/4")

[00340865]

	<b>⚠ VARNING!</b> <b>Tunga och skrymmande apparater!</b> Rygg- och muskelskador ▶ Låt endast utbildad personal ta bort dörren från apparaten. ▶ Det krävs två personer för att flytta apparaten. ▶ Använd endast passande verktyg och utrustning.
	<b>⚠ FÖRSIKTIGT!</b> <b>Vassa kanter!</b> Skärskador ▶ Använd skyddshandskar.
	<b>⚠ VARNING!</b> <b>Lutande maskiner kan glida!</b> Frakturer/krosskador ▶ Säkra maskiner så att de inte kan glida.
	<b>⚠ FÖRSIKTIGT!</b> <b>Risk för fallande delar på grund av lossade skruvar!</b> Personskador på grund av fallande delar. ▶ Säkra komponenter så att de inte faller ner.
	<b>OBS!</b> <b>Risk för fallande delar på grund av lossade skruvar!</b> Materiella skador på andra delar av maskinen eller i kundens hem, t.ex. vid botten. ▶ Säkra komponenter så att de inte faller ner.

### Förutsättning:

- ✓ Apparaten är bortkopplad från strömförsörjning.
- ✓ Tillbehör inuti apparaten har tagits bort.

## 4.3.1 Ta bort dörrens övre gångjärn

1. Lägg ner apparaten på baksidan.

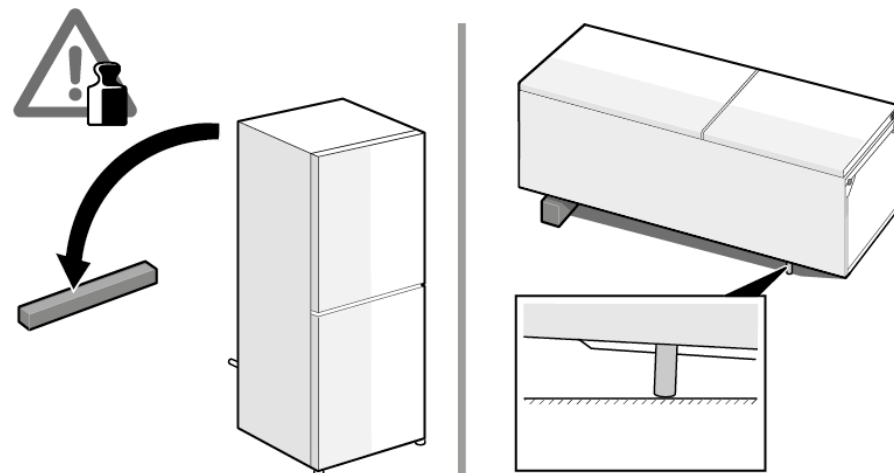

## Reparation

2. 1. Tryck på det övre gångjärnsskyddet på båda sidor (1).
2. Flytta ut det övre gångjärnsskyddet (2).
3. Vrid gångjärnsskyddet (3).
4. Ta bort det övre gångjärnsskyddet (4).
5. Skruva ur de två skruvarna (5).
6. Ta bort det övre gångjärnet (6)/

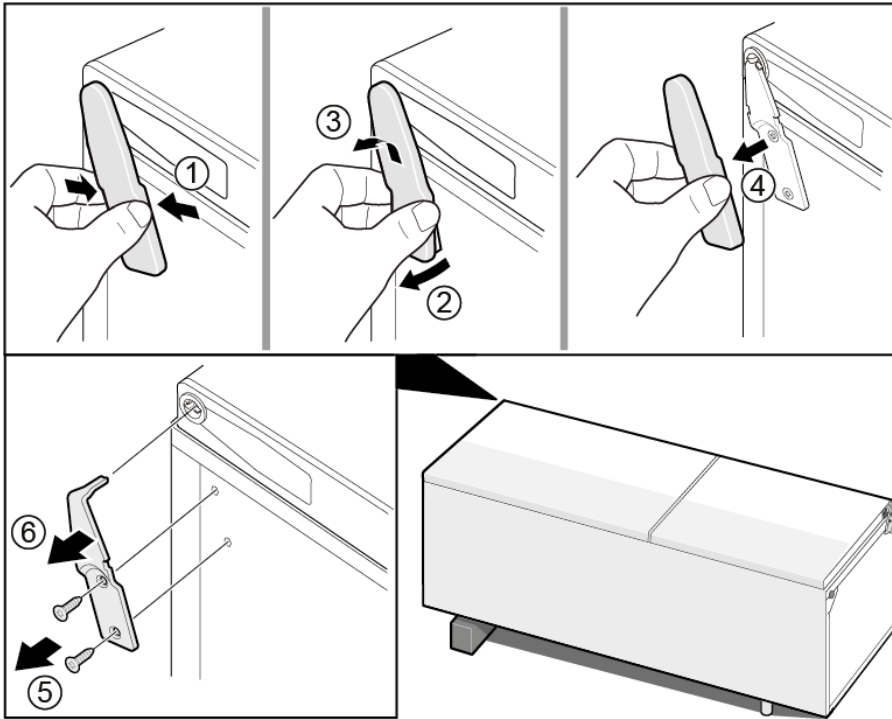

 Det övre gångjärnet har tagits bort.

### 4.3.2 Montera dörrens övre gångjärn

- ▶ Montera i omvänd ordning.

## 4.4 Byta dörrens övre gångjärn (dörr med display)

### Nödvändiga verktyg:

Torxbits TX20

6,3 mm (1/4")

[00340865]

	<b>⚠ VARNING!</b>
	<p><b>Tunga och skrymmande apparater!</b> Rygg- och muskelskador</p> <ul style="list-style-type: none"> <li>▶ Låt endast utbildad personal ta bort dörren från apparaten.</li> <li>▶ Det krävs två personer för att flytta apparaten.</li> <li>▶ Använd endast passande verktyg och utrustning.</li> </ul>

	<b>⚠ FÖRSIKTIGT!</b>
	<p><b>Vassa kanter!</b> Skärskador</p> <ul style="list-style-type: none"> <li>▶ Använd skyddshandskar.</li> </ul>

	<b>⚠ VARNING!</b>
	<p><b>Lutande maskiner kan glida!</b> Frakturer/krosskador</p> <ul style="list-style-type: none"> <li>▶ Säkra maskiner så att de inte kan glida.</li> </ul>

	<b>⚠ FÖRSIKTIGT!</b>
	<p><b>Risk för fallande delar på grund av lossade skruvar!</b> Personskador på grund av fallande delar.</p> <ul style="list-style-type: none"> <li>▶ Säkra komponenter så att de inte faller ner.</li> </ul>

	<b>OBS!</b>
	<p><b>Risk för fallande delar på grund av lossade skruvar!</b> Materiella skador på andra delar av maskinen eller i kundens hem, t.ex. vid botten.</p> <ul style="list-style-type: none"> <li>▶ Säkra komponenter så att de inte faller ner.</li> </ul>

	<b>⚠ FARA!</b>
	<p><b>Risk för elstötar på grund av strömförande delar!</b> Livsfara på grund av elstötar vid felaktiga reparationer</p> <ul style="list-style-type: none"> <li>▶ Elektriska delar ska repareras av behörig elektriker.</li> <li>▶ Låt utföra ett säkerhetstest efter reparationen, i enlighet med VDE 0701 eller landsspecifika regler.</li> </ul>

	<b>⚠ FARA!</b>
	<p><b>Risk för elstötar på grund av strömförande delar!</b> Dödsfall på grund av elstötar</p> <ul style="list-style-type: none"> <li>▶ Koppla bort maskiner från elförsörjningen minst 60 sekunder innan reparationer påbörjas.</li> </ul>

### Förutsättning:

- ✓ Apparaten är bortkopplad från strömförsörjning.
- ✓ Tillbehör inuti apparaten har tagits bort.

### 4.4.1 Ta bort dörrens övre gångjärn

1. Lagg ner apparaten på baksidan.

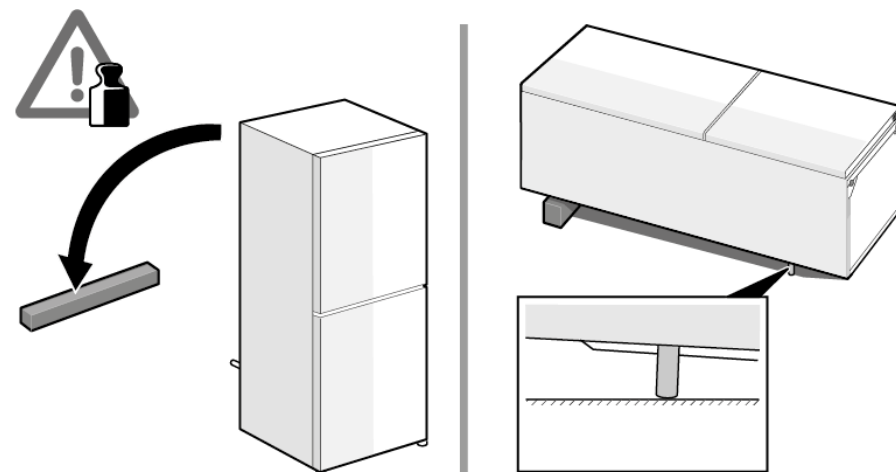

## Reparation

2. 1. Ta bort det övre gångjärnsskyddet (1).
2. Ta bort kabelboxhöljet (2).
3. Lossa elanslutningen (3).
4. Skruva ur jordanslutningsskruven (4).
5. Ta bort kabelskyddet (5).
6. Skruva ur skruven (6)

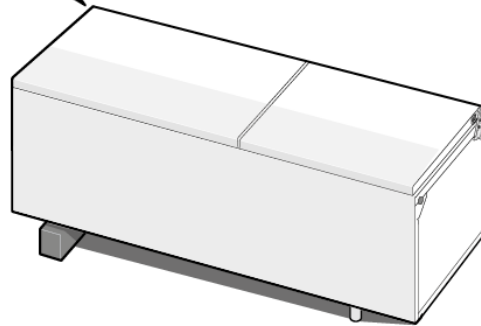
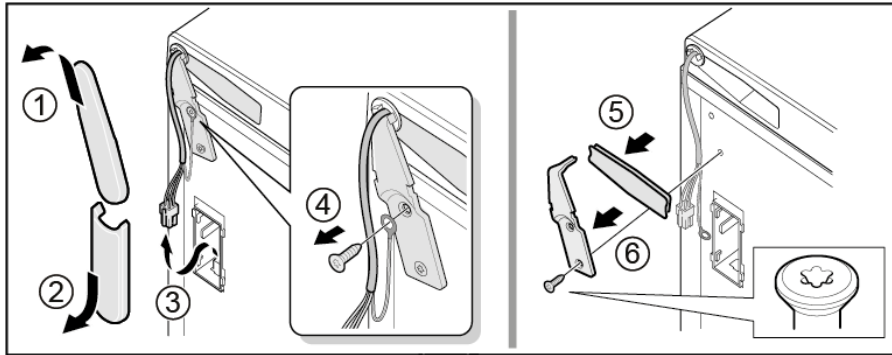

 Det övre gångjärnet har tagits bort.

### 4.4.2 Montera dörrens övre gångjärn

- ▶ Montera i omvänd ordning.

## 4.5 Byta dörrens mellersta gångjärn

### Nödvändiga verktyg:

Torxbits TX20

6,3 mm (1/4")

[00340865]

	<b>⚠ VARNING!</b>
	<p><b>Tunga och skrymmande apparater!</b> Rygg- och muskelskador</p> <ul style="list-style-type: none"> <li>▶ Låt endast utbildad personal ta bort dörren från apparaten.</li> <li>▶ Det krävs två personer för att flytta apparaten.</li> <li>▶ Använd endast passande verktyg och utrustning.</li> </ul>

	<b>⚠ FÖRSIKTIGT!</b>
	<p><b>Vassa kanter!</b> Skärskador</p> <ul style="list-style-type: none"> <li>▶ Använd skyddshandskar.</li> </ul>

	<b>⚠ VARNING!</b>
	<p><b>Lutande maskiner kan glida!</b> Frakturer/krosskador</p> <ul style="list-style-type: none"> <li>▶ Säkra maskiner så att de inte kan glida.</li> </ul>

	<b>⚠ FÖRSIKTIGT!</b>
	<p><b>Risk för fallande delar på grund av lossade skruvar!</b> Personskador på grund av fallande delar.</p> <ul style="list-style-type: none"> <li>▶ Säkra komponenter så att de inte faller ner.</li> </ul>

	<b>OBS!</b>
	<p><b>Risk för fallande delar på grund av lossade skruvar!</b> Materiella skador på andra delar av maskinen eller i kundens hem, t.ex. vid botten.</p> <ul style="list-style-type: none"> <li>▶ Säkra komponenter så att de inte faller ner.</li> </ul>

### Förutsättning:

- ✔ Apparaten är bortkopplad från strömförsörjning.
- ✔ Invändiga tillbehör i kylskåpet har tagits bort.
- ✔ Dörrens övre gångjärn har tagits bort.
- ✔ Den övre dörren har tagits bort.

### 4.5.1 Ta bort dörrens mellersta gångjärn

- ▶ 1. Ta bort kyldelens dörr (1).
- ▶ 2. Skruva ur de två skruvarna (2).
- ▶ 3. Ta bort det mellersta gångjärnet (3).

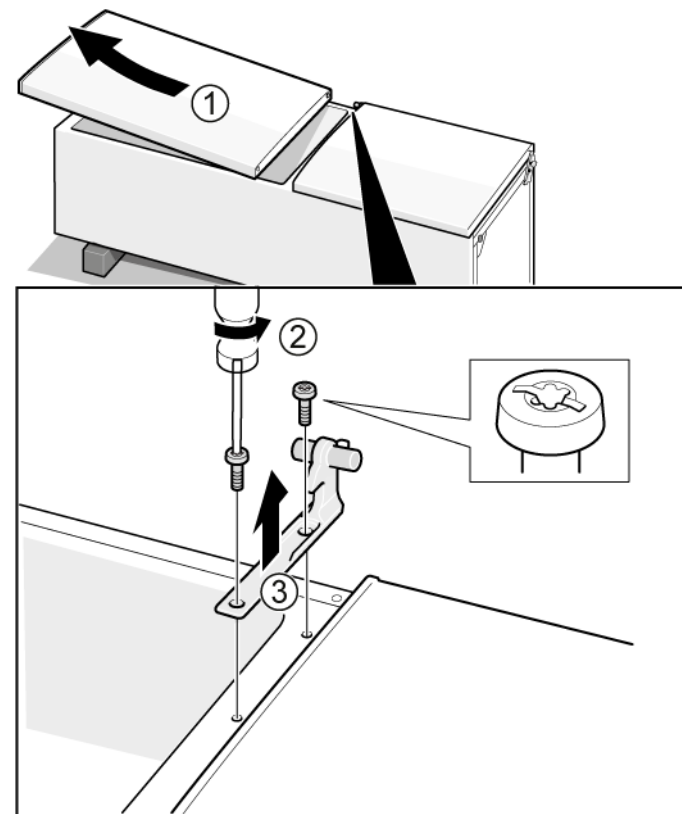

➡ Det mellersta gångjärnet har tagits bort.

### 4.5.2 Montera dörrens mellersta gångjärn

- ▶ Montera i omvänd ordning.

## 4.6 Byta dörrens nedre gångjärn

### Nödvändiga verktyg:

Torxbits TX20

6,3 mm (1/4")

[00340865]

	<b>⚠ VARNING!</b> <b>Tunga och skrymmande apparater!</b> Rygg- och muskelskador ▶ Låt endast utbildad personal ta bort dörren från apparaten. ▶ Det krävs två personer för att flytta apparaten. ▶ Använd endast passande verktyg och utrustning.
	<b>⚠ FÖRSIKTIGT!</b> <b>Vassa kanter!</b> Skärskador ▶ Använd skyddshandskar.
	<b>⚠ VARNING!</b> <b>Lutande maskiner kan glida!</b> Frakturer/krosskador ▶ Säkra maskiner så att de inte kan glida.
	<b>⚠ FÖRSIKTIGT!</b> <b>Risk för fallande delar på grund av lossade skruvar!</b> Personskador på grund av fallande delar. ▶ Säkra komponenter så att de inte faller ner.
	<b>OBS!</b> <b>Risk för fallande delar på grund av lossade skruvar!</b> Materiella skador på andra delar av maskinen eller i kundens hem, t.ex. vid botten. ▶ Säkra komponenter så att de inte faller ner.

### Förutsättning:

- ✓ Apparaten är bortkopplad från strömförsörjning.
- ✓ Tillbehör inuti apparaten har tagits bort.
- ✓ Det övre gångjärnet har tagits bort.
- ✓ Det mellersta gångjärnet har tagits bort.

### 4.6.1 Ta bort dörrens nedre gångjärn

- ▶ 1. Ta bort frysdelenens dörr (1).
- ▶ 2. Skruva ur skruven (2).
- ▶ 3. Vrid ut det nedre gångjärnet (3).
- ▶ 4. Ta bort det nedre gångjärnet (4).

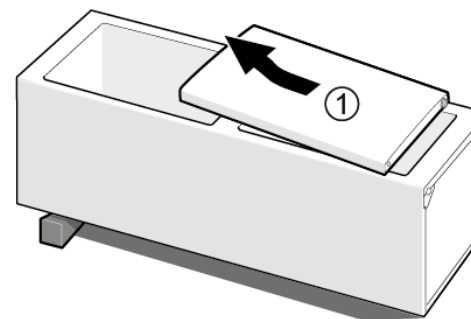
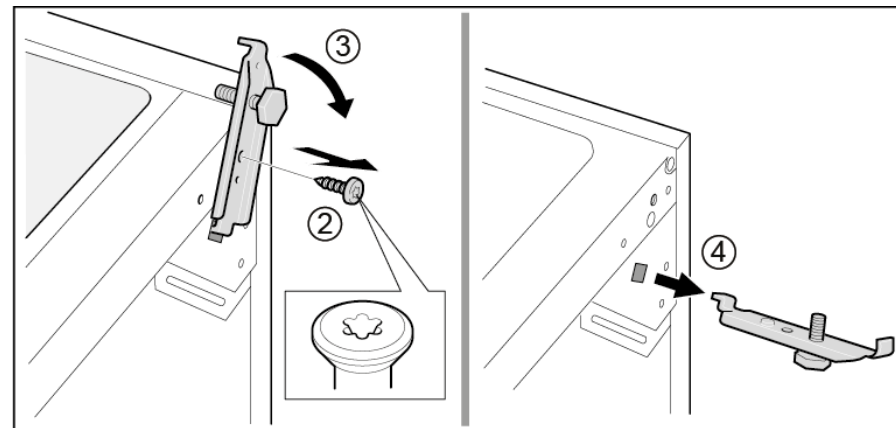

- ➡ Dörrens nedre gångjärn har tagits bort.

### 4.6.2 Montera dörrens nedre gångjärn

- ▶ Montera i omvänd ordning.

## 4.7 Byta hylla

### Förutsättning:

- ✔ Dörren är öppen.

### 4.7.1 Ta bort hylla

- ▶ Dra ut hyllan.

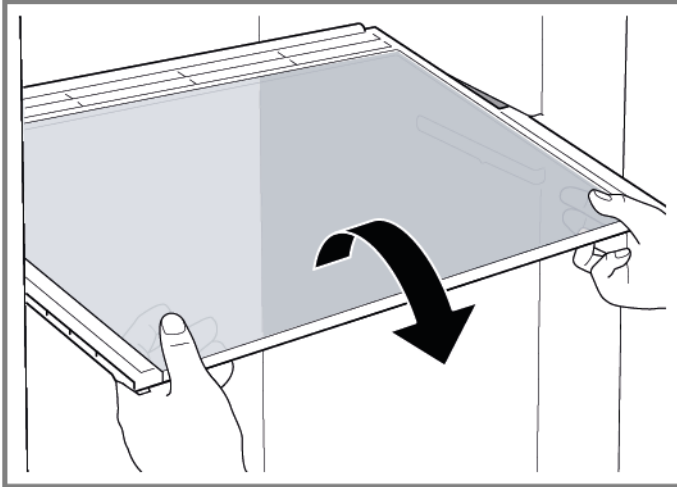

- ➡ Hyllan har tagits bort.

### 4.7.2 Montera hylla

- ▶ Montera i omvänd ordning.

## 4.8 Byte av den flyttbara hyllan

### Förutsättning:

- ✔ Dörren är öppen.

### 4.8.1 Borttagning av den flyttbara hyllan

1. Dra den flyttbara hyllans högra del framåt (1).
2. Ta bort den flyttbara hyllans högra del (2).

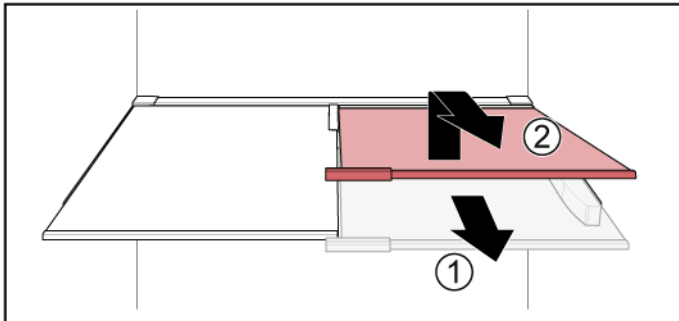

2. Ta bort den flyttbara hyllans vänstra del på samma sätt.

- ➡ Den flyttbara hyllan är nu borttagen.

### 4.8.2 Montering av den flyttbara hyllan

- ▶ Montera i omvänd ordning.

## 4.9 Byte av den böjligen hyllan

### Förutsättning:

- ✔ Dörren är öppen.

### 4.9.1 Borttagning av den böjligen hyllan

- ▶ 1. Ta bort glashyllan (1).
- ▶ 2. Lyft upp den böjligen hyllan och dra ut den (2).

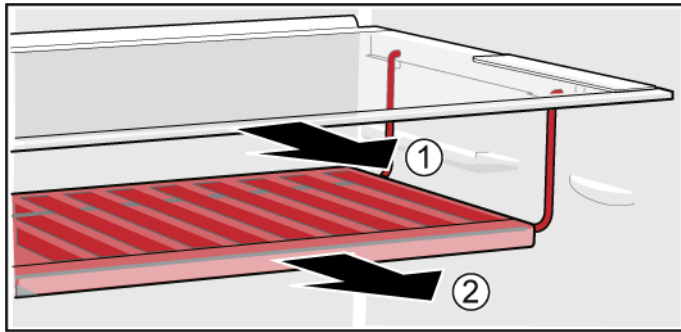

- ➡ Den böjligen hyllan är nu borttagen.

### 4.9.2 Montering av böjlig hylla

- ▶ Montera i omvänd ordning.

## 4.10 Byte av frukostgruppen

### Förutsättning:

- ✔ Dörren är öppen.

### 4.10.1 Borttagning av frukostgruppen

- ▶ Lyft upp frukostgruppen och dra ut den.

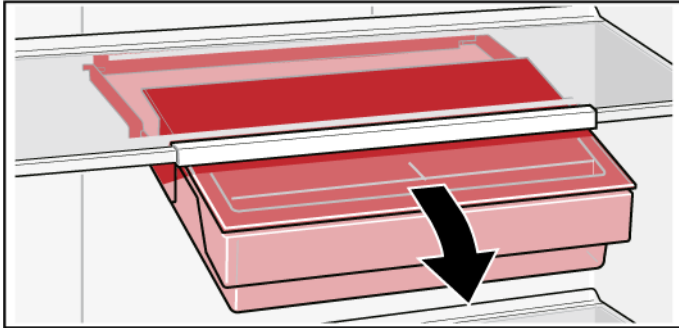

- ➡ Frukostgruppen är nu borttagen.

### 4.10.2 Montering av frukostgruppen

- ▶ Montera i omvänd ordning.

## 4.11 Byta flaskhylla

### Förutsättning:

- ✓ Dörren är öppen.

### 4.11.1 Ta bort flaskhylla

- ▶ Dra ut flaskhyllan.

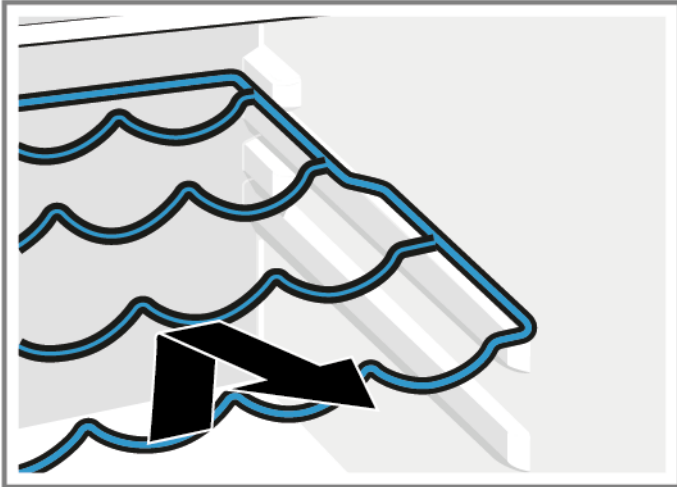

- ➡ Flaskhyllan har tagits bort.

### 4.11.2 Montera flaskhylla

- ▶ Montera i omvänd ordning.

## 4.12 Byta dörrhylla

### Förutsättning:

- ✔ Dörren är öppen.

### 4.12.1 Ta bort dörrhylla

- ▶ Lyft dörrhyllan uppåt.

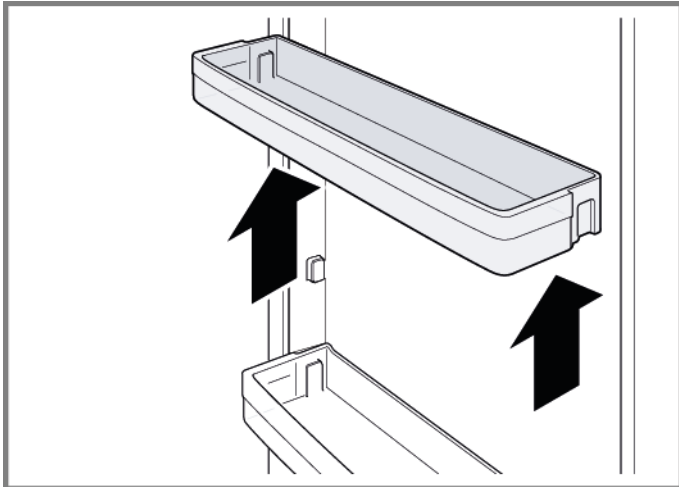

➡ Dörrhyllan har tagits bort.

### 4.12.2 Montera dörrhylla

- ▶ Montera i omvänd ordning.

## 4.13 Byta fack för frysta matvaror

### Förutsättning:

- ✔ Dörren är öppen.

### 4.13.1 Ta bort fack för frysta matvaror

- ▶ 1. Dra ut facket för frysta matvaror helt (1).
- ▶ 2. Ta bort facket för matvaror (2).

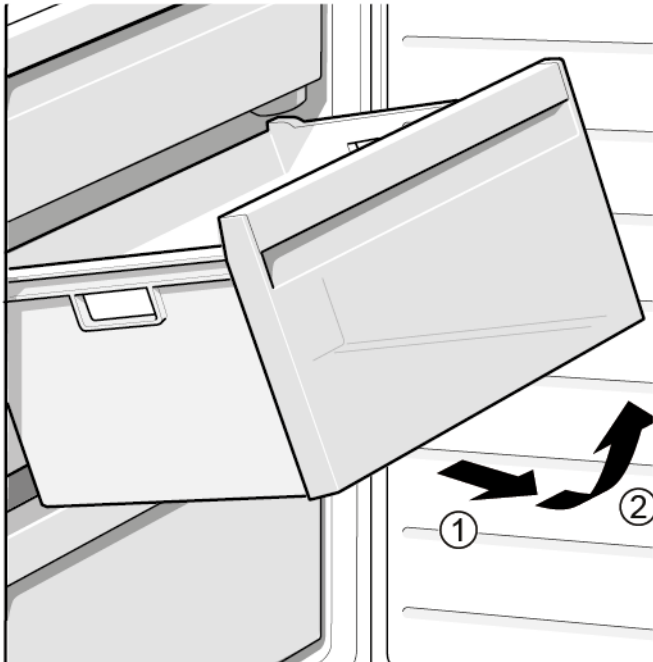

- ➡ Facket för frysta matvaror har tagits bort.

### 4.13.2 Montera fack för frysta matvaror

- ▶ Montera i omvänd ordning.

## 4.14 Byta fack

### Förutsättning:

- ✔ Dörren är öppen.

### 4.14.1 Ta bort fack

- ▶ 1. Ta ut det nedre kylfacket (1).
- ▶ 2. Ta ut det övre kylfacket (2).

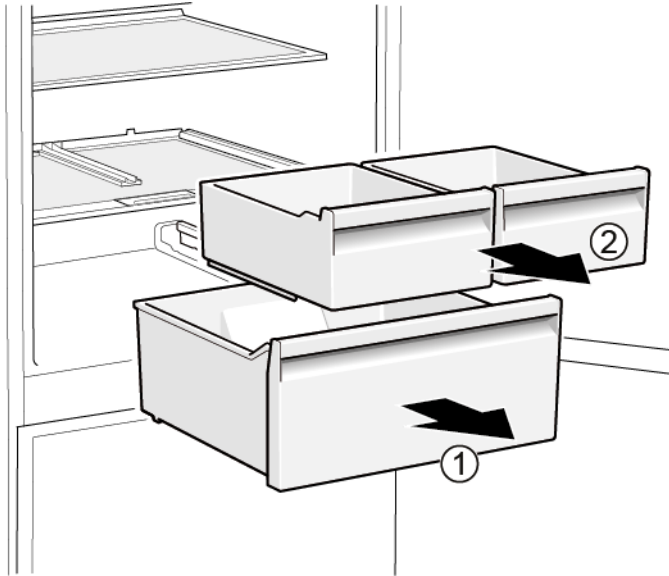

- ➡ Facken har tagits bort.

### 4.14.2 Montera låda

- ▶ Montera i omvänd ordning.

## 4.15 Byta utdragbar låda

### Förutsättning:

- ✓ Dörren är öppen.

### 4.15.1 Ta bort utdragbar låda

- ▶ 1. Dra ut den utdragbara lådan helt (1).
- ▶ 2. Ta bort den utdragbara lådan (2).

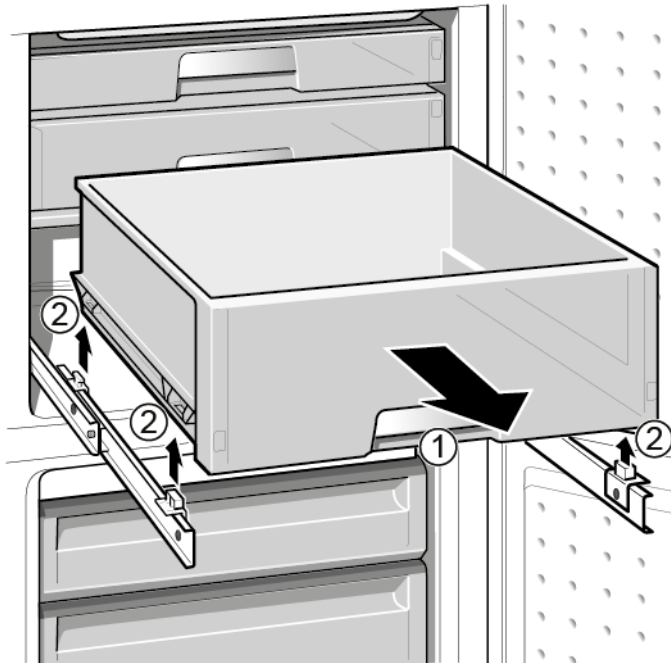

- ➡ Den utdragbara lådan har tagits bort.

### 4.15.2 Montera utdragbar låda

- ▶ Montera i omvänd ordning.

## 4.16 Byta LED-spotlight

### Nödvändiga verktyg:

Specialverktyg [00342180]



Din apparat har en underhållsfri LED-lampa.  
Dessa lampor får endast bytas av kundtjänst eller auktoriserade tekniker!



### **FARA!**

#### Risk för elstötar på grund av strömförande delar!

Livs fara på grund av elstötar vid felaktiga reparationer

- ▶ Elektriska delar ska repareras av behörig elektriker.
- ▶ Låt utföra ett säkerhetstest efter reparationen, i enlighet med VDE 0701 eller landsspecifika regler.



### **FARA!**

#### Risk för elstötar på grund av strömförande delar!

Dödsfall på grund av elstötar

- ▶ Koppla bort maskiner från elförsörjningen minst 60 sekunder innan reparationer påbörjas.



### **FÖRSIKTIGT!**

#### Vassa kanter!

Skärskador

- ▶ Använd skyddshandskar.

### Förutsättning:

- ✔ Apparaten är bortkopplad från strömförsörjning.
- ✔ Dörren är öppen.

### 4.16.1 Ta bort LED-spotlight

1. Använd specialverktyg för att dra ut LED-spotlighten (1).

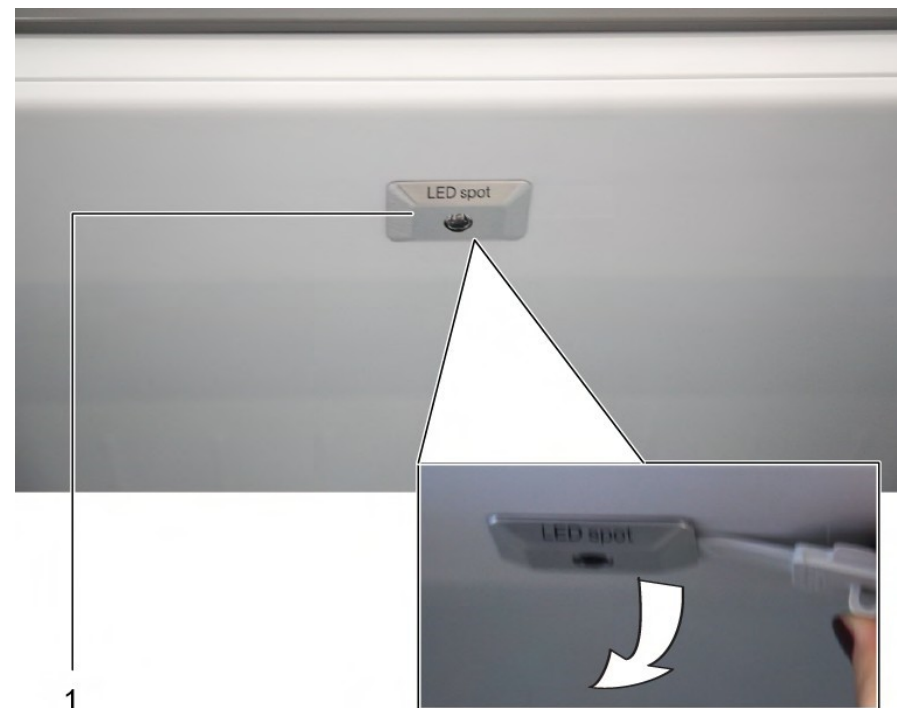

2. Lossa elanslutningarna till LED-spotlighten.

➡ LED-spotlighten har tagits bort.

### 4.16.2 Montera LED-spotlight

- ▶ Montera i omvänd ordning.

## 4.17 Byta översta LED-lampan

### Nödvändiga verktyg:

Spårskruvmejsel

Blad 2,4 mm x 0.4 mm x 60 mm, i kitet [00341820]

**i** Din apparat har en underhållsfri LED-lampa. Dessa lampor får endast bytas av kundtjänst eller auktoriserade tekniker!

**⚠ FARA!**  
**Risk för elstötar på grund av strömförande delar!**  
Livsfara på grund av elstötar vid felaktiga reparationer

- ▶ Elektriska delar ska repareras av behörig elektriker.
- ▶ Låt utföra ett säkerhetstest efter reparationen, i enlighet med VDE 0701 eller landsspecifika regler.

**⚠ FARA!**  
**Risk för elstötar på grund av strömförande delar!**  
Dödsfall på grund av elstötar

- ▶ Koppla bort maskiner från elförsörjningen minst 60 sekunder innan reparationer påbörjas.

**⚠ FÖRSIKTIGT!**  
**Vassa kanter!**  
Skärskador

- ▶ Använd skyddshandskar.

### Förutsättning:

- ✓ Apparaten är bortkopplad från strömförsörjning.
- ✓ Dörren är öppen.
- ✓ Tillbehör överst inuti apparaten har tagits bort.

### 4.17.1 Ta bort LED-lampan

1. Flytta LED-lampan åt vänster.



➡ LED-lampans elanslutning är bortkopplad.

2. Lossa LED-lampans hakar.

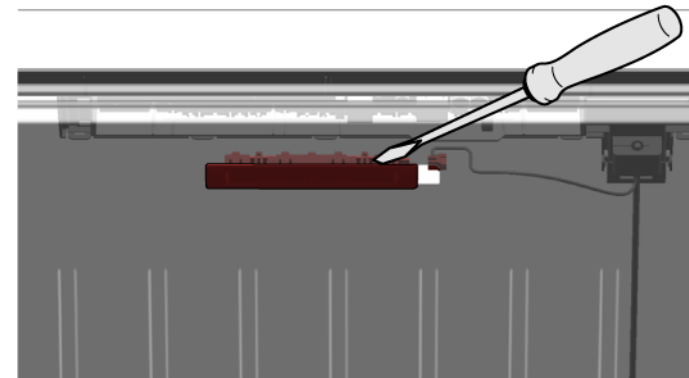

## Reparation

3. Ta bort LED-lampan genom att flytta den framåt.

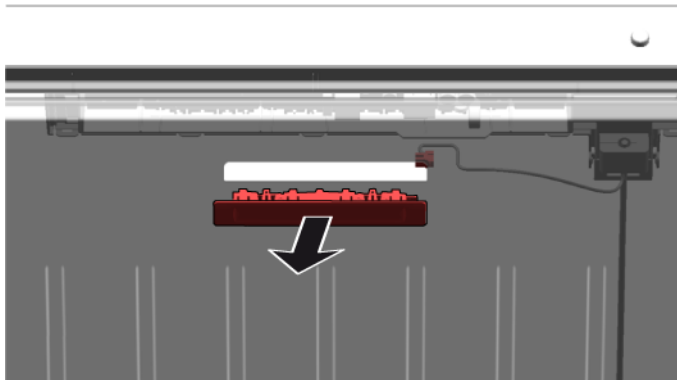

- ➡ LED-lampan har tagits bort.

### 4.17.2 Montera översta LED-lampan

- ▶ Montera i omvänd ordning.

## 4.18 Byta LED-sidoramplampa

### Nödvändiga verktyg:

Sugkopp Ø50 mm [00342224]

 Din apparat har en underhållsfri LED-lampa. Dessa lampor får endast bytas av kundtjänst eller auktoriserade tekniker!

 **FARA!**  
**Risk för elstötar på grund av strömförande delar!**  
Livsfara på grund av elstötar vid felaktiga reparationer

- ▶ Elektriska delar ska repareras av behörig elektriker.
- ▶ Låt utföra ett säkerhetstest efter reparationen, i enlighet med VDE 0701 eller landsspecifika regler.

 **FARA!**  
**Risk för elstötar på grund av strömförande delar!**  
Dödsfall på grund av elstötar

- ▶ Koppla bort maskiner från elförsörjningen minst 60 sekunder innan reparationer påbörjas.

 **FÖRSIKTIGT!**  
**Vassa kanter!**  
Skärskador

- ▶ Använd skyddshandskar.

### Förutsättning:

- ✓ Apparaten är bortkopplad från strömförsörjning.
- ✓ Dörren är öppen.
- ✓ Kyldelshyllorna har tagits bort.

### 4.18.1 Ta bort LED-sidoramplampa

1. Sätt sugkoppen på den övre tredjedelen av LED sidoramplampan.



## Reparation

2. Dra sugkoppen framåt med LED-sidoramplampan i en vridrörelse.

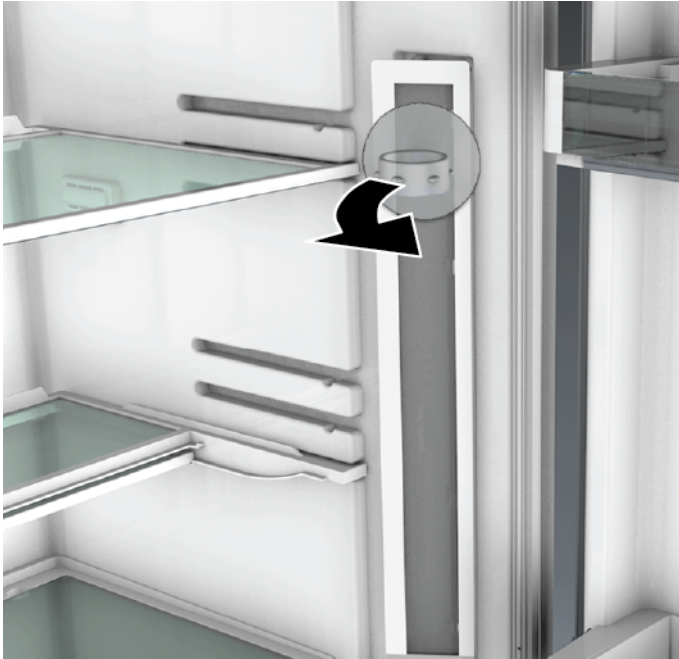

3. Lossa elanslutningen till LED-sidoramplampan.  
 LED-sidoramplampan har tagits bort.

### 4.18.2 Montera LED-sidoramplampa

1. Anslut elanslutningen till LED-sidoramplampan.
  2. Sätt fast LED-sidoramplampan på dess plats på kyldelsväggen (hakarna klickar i).
-  LED-sidoramplampan har monterats.

# Onarım İpuçları - Soğutucu cihaz ve derin dondurucu

<b>i</b>	<b>Bu doküman hakkında .....</b>	<b>624</b>
1.1	Önemli bilgi .....	624
1.1.1	Amacı.....	624
1.2	Sembollerinin açıklaması .....	624
1.2.1	Tehlike kademeleri .....	624
1.2.2	Tehlike sembolleri .....	624
1.2.3	İkaz bilgilerinin yapısı .....	625
1.2.4	Genel semboller.....	625
<b>⚠</b>	<b>Güvenlik.....</b>	<b>626</b>
2.1	Genel Güvenlik bilgileri .....	626
2.1.1	Tüm ev gereçleri .....	626
<b>🔧</b>	<b>Ekipman ve yardım.....</b>	<b>627</b>
<b>🔧</b>	<b>Onarım.....</b>	<b>628</b>
4.1	Kapı contasının değiştirilmesi .....	628
4.2	Kapı tutamağının değiştirilmesi.....	629
4.2.1	Kapı tutamağının çıkartılması .....	629
4.2.2	Kapı tutamağının takılması .....	629
4.3	Kapının üst menteşesinin değiştirilmesi.....	630
4.3.1	Kapının üst menteşesinin çıkartılması .....	630
4.3.2	Kapının üst menteşesinin takılması .....	631
4.4	Kapının üst menteşesinin değiştirilmesi (göstergeli kapı).....	632
4.4.1	Kapının üst menteşesinin çıkartılması .....	632
4.4.2	Kapının üst menteşesinin takılması .....	633
4.5	Kapının orta menteşesinin değiştirilmesi .....	634
4.5.1	Kapının orta menteşesinin çıkartılması .....	634
4.5.2	Kapının orta menteşesinin takılması.....	634
4.6	Kapının alt menteşesinin değiştirilmesi.....	635
4.6.1	Kapının alt menteşesinin çıkartılması .....	635
4.6.2	Kapının alt menteşesinin takılması .....	635
4.7	Raf yüzeyinin değiştirilmesi .....	636
4.7.1	Raf yüzeyinin çıkartılması .....	636
4.7.2	Raf yüzeyinin takılması.....	636
4.8	Değişken rafın çıkarılması ve takılması .....	637

4.8.1	Değişken rafın çıkartılması.....	637
4.8.2	Değişken raf yüzeyinin takılması .....	637
4.9	Esnek rafın değiştirilmesi.....	638
4.9.1	Esnek rafın çıkartılması.....	638
4.9.2	Esnek rafın takılması .....	638
4.10	Kahvaltı setinin değiştirilmesi .....	639
4.10.1	Kahvaltı setinin çıkartılması .....	639
4.10.2	Kahvaltı setinin takılması .....	639
4.11	Şişe rafının değiştirilmesi.....	640
4.11.1	Şişe rafının çıkartılması.....	640
4.11.2	Şişe rafının takılması .....	640
4.12	Kapı rafının değiştirilmesi .....	641
4.12.1	Kapı rafının çıkartılması .....	641
4.12.2	Kapı rafının takılması .....	641
4.13	Dondurulacak gıda kabının değiştirilmesi.....	642
4.13.1	Dondurulacak gıda kabının çıkartılması .....	642
4.13.2	Dondurulacak gıda kabının takılması .....	642
4.14	Kabın değiştirilmesi .....	643
4.14.1	Kabın çıkartılması.....	643
4.14.2	Kabın takılması .....	643
4.15	Uzatılabilir kabın değiştirilmesi .....	644
4.15.1	Uzatılabilir kabın çıkartılması.....	644
4.15.2	Uzatılabilir kabın takılması .....	644
4.16	LED spot ışığının değiştirilmesi .....	645
4.16.1	LED spot ışığının çıkartılması.....	645
4.16.2	LED spot ışığının takılması .....	645
4.17	LED Üst aydınlatmanın değiştirilmesi .....	646
4.17.1	LED Lambanın sökülmesi .....	646
4.17.2	Üst LED ışığının takılması.....	647
4.18	LED yan çubuk ışığının değiştirilmesi .....	648
4.18.1	LED yan çubuk ışığının çıkartılması.....	648
4.18.2	LED yan çubuk ışığının takılması.....	649

# **i** Bu doküman hakkında

## 1.1 Önemli bilgi

### 1.1.1 Amacı

Bu onarım ipuçları, tüketicinin cihazları, geçerli eko-tasarım yönetmeliğine göre (03/2021 itibarıyla) kendi başına onarması için destek sunar.

İpuçları, ilgili uyarı ve riskler de dahil olmak üzere tanımlanmış yedek parçaların nasıl değiştirilmesi gerektiğine dair bilgiler içerir.

Sorularınız varsa, lütfen müşteri hizmetlerimizle irtibata geçin. Yalnızca onarım ipuçlarına gerektiği gibi uyulduğu takdirde hasarlar için sorumluluk üstleniriz.

## 1.2 Sembollerinin açıklaması

### 1.2.1 Tehlike kademeleri

Tehlike kademeleri bir sembolden ve bir sinyal kelimesinden oluşur. Sinyal kelimesi tehlikenin şiddetini ve önemini tanımlar.





Tehlike kademesi	Anlamı
 <b>TEHLİKE</b>	İkaz bilgisinin dikkate alınmaması ölüme veya ağır yaralanmalara sebep olur.
 <b>UYARI</b>	İkaz bilgisinin dikkate alınmaması ölüme veya ağır yaralanmalara sebep olabilir.
 <b>DİKKAT</b>	İkaz bilgisinin dikkate alınmaması hafif yaralanmalara sebep olabilir.
<b>DİKKATI</b>	İkaz bilgisinin dikkate alınmaması maddi hasarların oluşmasına sebep olabilir.

Tablo 1: Tehlike kademeleri



### 1.2.2 Tehlike sembolleri

Tehlike sembolleri, tehlike türü hakkında bilgi veren anlamlı resimsel gösterimlerdir.

Bu dokümanda aşağıdaki tehlike sembolleri kullanılmıştır:

Tehlike sembolü	Anlamı
	Genel ikaz bilgisi
	Elektrik geriliminden kaynaklanan tehlike
	Patlamadan kaynaklanan tehlike
	Kesmeden dolayı yaralanma tehlikesi
	Sıkışıp ezilmeden dolayı yaralanma tehlikesi

## **i** Bu doküman hakkında

Tehlike sembolü	Anlamı
	Sıcak yüzeylerden kaynaklanan tehlike
	Güçlü elektromanyetik alan tehlikesi
	İyonizasyon olmayan ışınlardan kaynaklanan tehlike

Tablo 2: Tehlike sembolleri

### 1.2.3 İkaz bilgilerinin yapısı

Bu dokümandaki ikaz bilgilerinin standart olarak görünüşü ve yapısı aynıdır.



	<b>⚠ TEHLİKE</b> <b>Tehlikenin türü ve kaynağı!!</b> Tehlike / ikaz bilgisinin dikkate alınmamasının sonucu. ► Tehlikeye karşı korunmak için yapılacak işlem ve yasaklar.
--	--







Aşağıdaki örnekte, gerilim ileten parçalar nedeniyle oluşabilecek elektrik çarpması tehlikesi hakkında uyarıda bulunan bir ikaz bilgisi gösterilmiştir. Tehlikeyi önlemek için alınması gereken önlemler belirtilmiştir.

	<b>⚠ TEHLİKE</b> <b>Gerilim ileten parçalar nedeniyle elektrik çarpması tehlikesi!!</b> Elektrik çarpması sebebiyle ölüm ► Onarıma başlamadan önce cihazın elektrik şebeke bağlantısını en az 60 saniye süreyle sökün.
---	---

### 1.2.4 Genel semboller

Bu dokümanda aşağıdaki genel semboller kullanılmıştır:

Genel sembol	Anlamı
	Özel ipucu işareti (metin ve/veya grafik)
	Basit ipucu işareti (yalnızca metin)
	Video linki işareti

Genel sembol	Anlamı
	Gerekli araçlar işareti
	Ön koşulların işareti
	Koşul işareti (... olursa .... olur)
	Sonuç işareti
	Tuş veya düğme işareti
	Malzeme numarası işareti
	Gösterilen yazı / ekran işareti (cihaz ekranındaki)

Tablo 3: Genel semboller

## 2.1 Genel Güvenlik bilgileri

### 2.1.1 Tüm ev gereçleri

#### **Gerilim ileten parçalar nedeniyle elektrik çarpması tehlikesi!**

- Elektrikli bileşenlerde yapılan onarımlarda hatalar, elektrik çarpmasına neden olabilir!
- Cihaz çalışmalara başlamadan en az 60 saniye önce elektrik şebekesinden ayrılmalıdır.
- Onarım sonrasında VDE 0701 veya ülkeye özel düzenlemeler uyarınca bir güvenlik testi gerçekleştirilmelidir.

#### **Keskin kenarlar nedeniyle yaralanma tehlikesi!**

- Koruyucu eldiven kullanılmalıdır.

#### **Ağır ve hareketli parçaların onarım, bakım, hata arama ve servis işlemlerinde yaratabileceği ezilme riskleri**

- Koruyucu ayakkabı giyin.
- Yere düşmemesi için ağır parçaları emniyete alın.
- Hareketli parçaların arasına gövde parçaları koymayın.

#### **Cihaz güvenliğinde / fonksiyonda tehlike!**

- Yalnızca orijinal parçalar kullanılmalıdır.

#### **Elektrostatik hassasiyeti olan bileşenlerde hasar tehlikesi (ESD)!**

- Bağlantılar ve iletken yolları da dahil olmak üzere modüllere dokunmayın.

## Ekipman ve yardım

Tanımlama	Detaylar	Görüntüler
Koruyucu bez [00342013]	60 cm x 50 cm	
Hassas tornavida seti [00341820]	9 parça, 2,0 mm, 2,4 mm, 3,0 mm, PH0, PH00, PH1, TX6, TX8, TX9	
Sabitlenme parçası [00342180]	Plastik parçaların gevşetilmesi için alet, "magic tool"	
Vantuz [00342224]	Ø 50 mm	
Torx Bit TX20 [00340865]	6,3 mm (1/4")	
Düz tornavida	Bıçak 10 mm x 1,6 mm x 200 mm	

## 4.1 Kapı contasının deęiřtirilmesi

Ön koşul:

- Kapı açık.

## 4.2 Kapı tutamağının değiştirilmesi

### Önerilen araçlar:

- |                 |                               |            |
|-----------------|-------------------------------|------------|
| ⚙ Torx Bit TX20 | 6,3 mm (1/4")                 | [00340865] |
| ⚙ Düz tornavida | Bıçak 10 mm x 1,6 mm x 200 mm |            |

### Ön kontrol:

- ✓ Cihazın fişi çekilir.
- ✓ Kapı açık.

### 4.2.1 Kapı tutamağının çıkartılması

- ▶ 1. İki vidalı kapağı çıkartın (1).
- ▶ 2. Vidaları sökün (2).
- ▶ 3. Kapı tutamağını çıkartın (3).

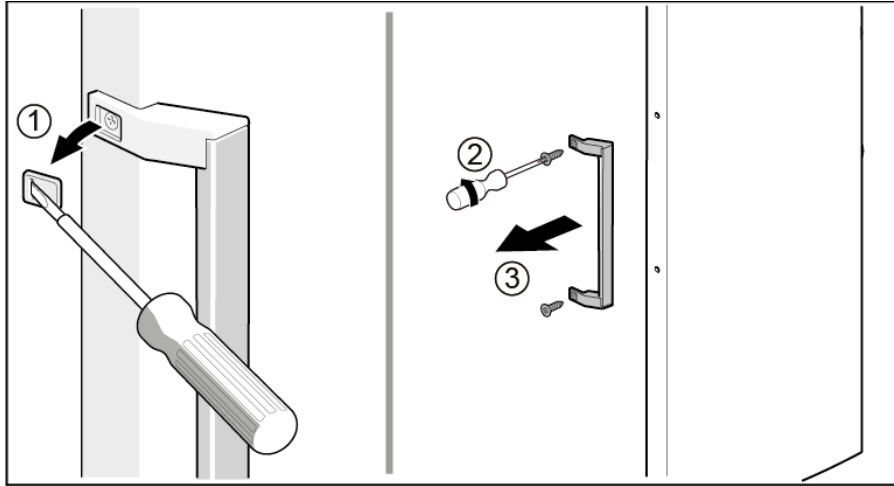

➡ Kapı tutamağı çıkartılmıştır.



İkinci kapının tutamağı da aynı şekilde çıkartılabilir.

### 4.2.2 Kapı tutamağının takılması

- ▶ Ters sıra ile monte edin.

## 4.3 Kapının üst menteşesinin değiştirilmesi

Önerilen araçlar:

Torx Bit TX20

6,3 mm (1/4")

[00340865]

	<p><b>UYARI</b></p> <p><b>Ağır, büyük cihazlar!</b> Sırt ve kas yaralanmaları</p> <ul style="list-style-type: none"><li>▶ Cihaz kapısını çıkarma işlemi sadece eğitimli uzmanlar tarafından gerçekleştirilmelidir.</li><li>▶ Cihazı hareket ettirmek için iki kişi gereklidir.</li><li>▶ Sadece uygun aletler ve ekipmanlar kullanın.</li></ul>
--	---

	<p><b>DİKKAT</b></p> <p><b>Keskin köşeler!</b> Kesik yaralanmaları</p> <ul style="list-style-type: none"><li>▶ Koruyucu eldiven kullanılmalıdır.</li></ul>
--	--

	<p><b>UYARI</b></p> <p><b>Eğilmiş cihazların kayması!</b> Kemik kırılmaları / çarpma sonucu yaralanmalar</p> <ul style="list-style-type: none"><li>▶ Cihazları kaymaya karşı emniyete alın.</li></ul>
--	---

	<p><b>DİKKAT</b></p> <p><b>Vidaların gevşetilmesi nedeniyle parçaların düşme tehlikesi!</b> Düşen parçalar nedeniyle yaralanma.</p> <ul style="list-style-type: none"><li>▶ Bileşenleri düşmeye karşı emniyete alın.</li></ul>
---	--

	<p><b>DİKKAT!</b></p> <p><b>Vidaların gevşetilmesi nedeniyle parçaların düşme tehlikesi!</b> Cihazın diğer parçalarında veya müşterinin evinde (örn. zemin) hasarlar.</p> <ul style="list-style-type: none"><li>▶ Bileşenleri düşmeye karşı emniyete alın.</li></ul>
--	--

Ön koşul:

- ✓ Cihazın fişi çekilir.
- ✓ Cihazın iç donanımları çıkartılmıştır.

### 4.3.1 Kapının üst menteşesinin çıkartılması

1. Cihazı arka tarafına yatırın.

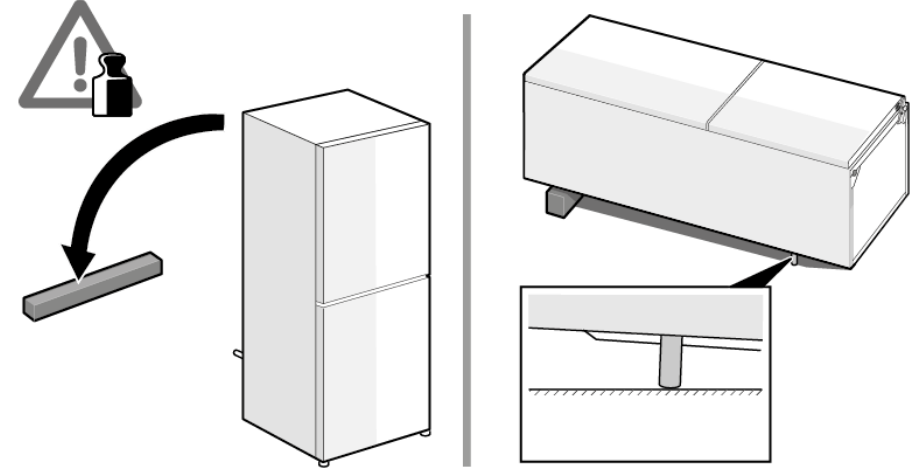

1. Üst menteşe kapağını iki tarafta da bastırın (1).
2. Üst menteşe kapağını çıkartın (2).
3. Menteşe kapağını döndürün (3).
4. Üst menteşe kapağını sökün (4).
5. Vidaları sökün (5).
6. Üst menteşeyi çıkartın (6)/

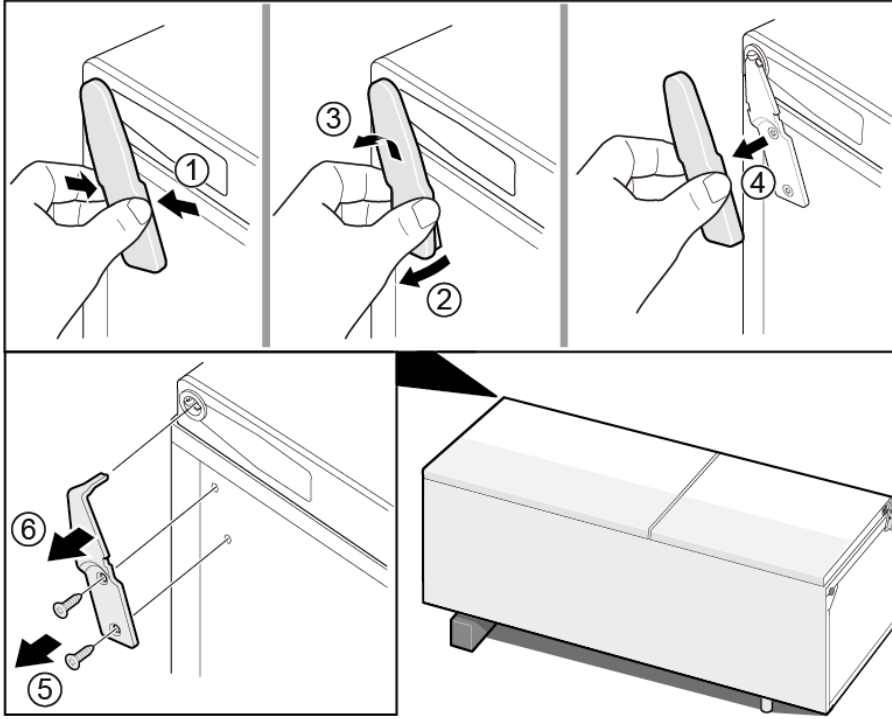

➔ Üst menteşe çıkarılır.

### 4.3.2 Kapının üst menteşesinin takılması

- ▶ Ters sıra ile monte edin.

#### 4.4 Kapının üst menteşesinin değiştirilmesi (göstergeli kapı)

Önerilen araçlar:

 Torx Bit TX20

6,3 mm (1/4")

[00340865]

	<b>UYARI</b> <b>Ağır, büyük cihazlar!</b> Sırt ve kas yaralanmaları <ul style="list-style-type: none"><li>▶ Cihaz kapısını çıkarma işlemi sadece eğitimli uzmanlar tarafından gerçekleştirilmelidir.</li><li>▶ Cihazı hareket ettirmek için iki kişi gereklidir.</li><li>▶ Sadece uygun aletler ve ekipmanlar kullanın.</li></ul>
--	---

	<b>DİKKAT</b> <b>Keskin köşeler!</b> Kesik yaralanmaları <ul style="list-style-type: none"><li>▶ Koruyucu eldiven kullanılmalıdır.</li></ul>
--	--

	<b>UYARI</b> <b>Eğilmiş cihazların kayması!</b> Kemik kırılmaları / çarpma sonucu yaralanmalar <ul style="list-style-type: none"><li>▶ Cihazları kaymaya karşı emniyete alın.</li></ul>
--	---



	<b>DİKKAT</b> <b>Vidaların gevşetilmesi nedeniyle parçaların düşme tehlikesi!</b> Düşen parçalar nedeniyle yaralanma. <ul style="list-style-type: none"><li>▶ Bileşenleri düşmeye karşı emniyete alın.</li></ul>
---	--

	<b>DİKKAT!</b> <b>Vidaların gevşetilmesi nedeniyle parçaların düşme tehlikesi!</b> Cihazın diğer parçalarında veya müşterinin evinde (örn. zemin) hasarlar. <ul style="list-style-type: none"><li>▶ Bileşenleri düşmeye karşı emniyete alın.</li></ul>
--	--

	<b>TEHLİKE</b> <b>Gerilim ileten parçalar nedeniyle elektrik çarpması tehlikesi!!</b> Onarımın düzgün yapılmaması nedeniyle elektrik çarpması sonucu hayati tehlike <ul style="list-style-type: none"><li>▶ Elektrikli parçaların onarımı kalifiye bir elektrik uzmanı tarafından gerçekleştirilmelidir.</li><li>▶ Onarım sonrasında VDE 0701 veya ülkeye özel düzenlemeler uyarınca bir güvenlik testi gerçekleştirilmelidir.</li></ul>
---	--

	<b>TEHLİKE</b> <b>Gerilim ileten parçalar nedeniyle elektrik çarpması tehlikesi!!</b> Elektrik çarpması sebebiyle ölüm <ul style="list-style-type: none"><li>▶ Onarıma başlamadan önce cihazın elektrik şebeke bağlantısını en az 60 saniye süreyle sökün.</li></ul>
---	--

Ön kopul:

-  Cihazın fişi çekilir.
-  Cihazın iç donanımları çıkartılmıştır.

##### 4.4.1 Kapının üst menteşesinin çıkartılması

1. Cihazı arka tarafına yatırın.

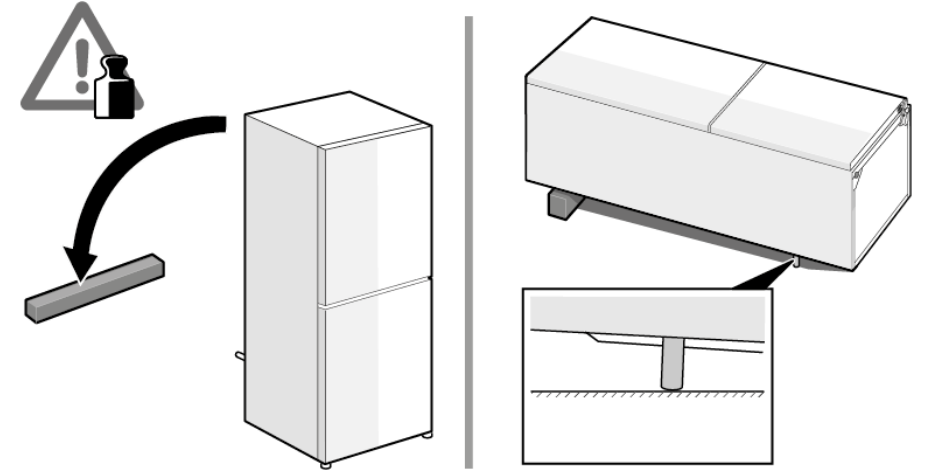

2. 1. Üst menteşe kapağını çıkartın (1).
2. Kablo kutusu kapağını çıkartın (2).
3. Elektrik bağlantısını ayırın (3)
4. Topraklama bağlantısı vidasını sökün (4).
5. Kablo korumasını çıkartın (5).
6. Vidayı sökün (6)

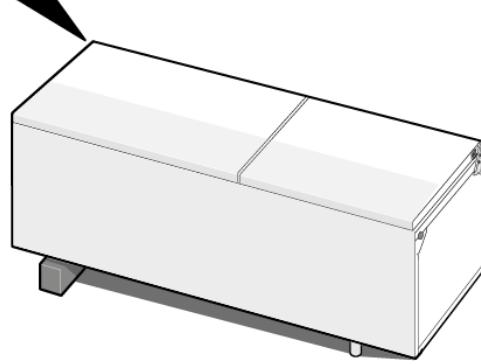
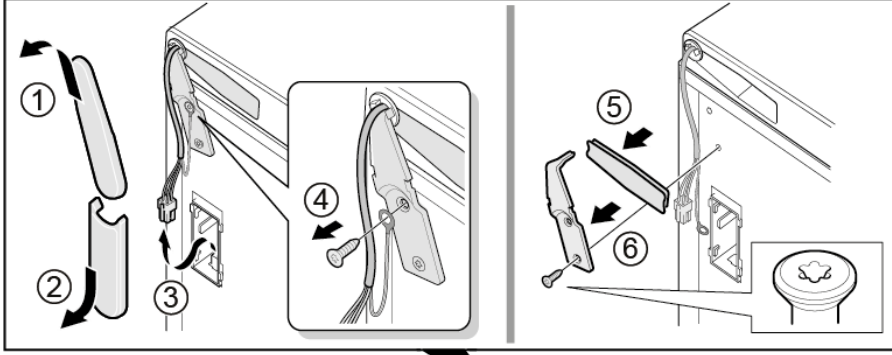

➔ Üst menteşe çıkarılır.

### 4.4.2 Kapının üst menteşesinin takılması

- ▶ Ters sıra ile monte edin.

## 4.5 Kapının orta menteşesinin değiştirilmesi

Önerilen araçlar:

Torx Bit TX20

6,3 mm (1/4")

[00340865]



### UYARI

#### Ağır, büyük cihazlar!

Sırt ve kas yaralanmaları

- ▶ Cihaz kapısını çıkarma işlemi sadece eğitimli uzmanlar tarafından gerçekleştirilmelidir.
- ▶ Cihazı hareket ettirmek için iki kişi gereklidir.
- ▶ Sadece uygun aletler ve ekipmanlar kullanın.



### DİKKAT

#### Keskin köşeler!

Kesik yaralanmaları

- ▶ Koruyucu eldiven kullanılmalıdır.



### UYARI

#### Eğilmiş cihazların kayması!

Kemik kırılmaları / çarpma sonucu yaralanmalar

- ▶ Cihazları kaymaya karşı emniyete alın.



### DİKKAT

#### Vidaların gevşetilmesi nedeniyle parçaların düşme tehlikesi!

Düşen parçalar nedeniyle yaralanma.

- ▶ Bileşenleri düşmeye karşı emniyete alın.



### DİKKAT!

#### Vidaların gevşetilmesi nedeniyle parçaların düşme tehlikesi!

Cihazın diğer parçalarında veya müşterinin evinde (örn. zemin) hasarlar.

- ▶ Bileşenleri düşmeye karşı emniyete alın.

Ön koşul:

- ✓ Cihazın fişi çekilir.
- ✓ Cihazın iç donanımları çıkartılmıştır.
- ✓ Kapının üst menteşesi çıkartılmıştır.
- ✓ Üst kapı çıkartılmıştır.

## 4.5.1 Kapının orta menteşesinin çıkartılması

- ▶ 1. Soğutucu bölüm kapısını sökün (1).
- ▶ 2. Vidaları sökün (2).
- ▶ 3. Orta menteşeyi çıkartın (3).

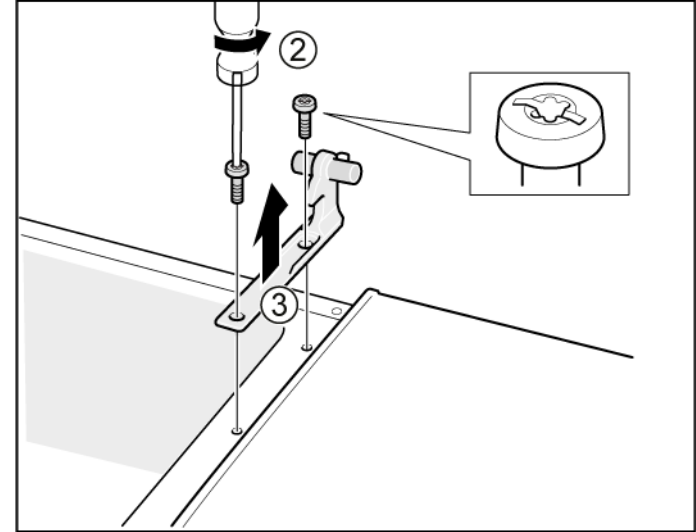
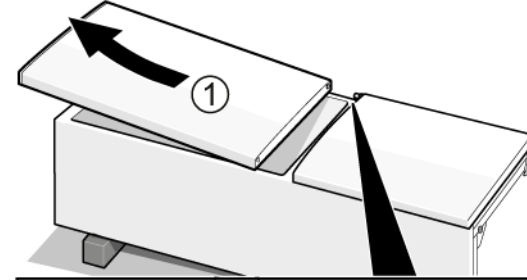

➡ Orta menteşe çıkartılmıştır.

## 4.5.2 Kapının orta menteşesinin takılması

- ▶ Ters sıra ile monte edin.

## 4.6 Kapının alt menteşesinin değiştirilmesi

Önerilen araçlar:

Torx Bit TX20

6,3 mm (1/4")

[00340865]

	<p><b>UYARI</b></p> <p><b>Ağır, büyük cihazlar!</b> Sırt ve kas yaralanmaları</p> <ul style="list-style-type: none"><li>▶ Cihaz kapısını çıkarma işlemi sadece eğitimli uzmanlar tarafından gerçekleştirilmelidir.</li><li>▶ Cihazı hareket ettirmek için iki kişi gereklidir.</li><li>▶ Sadece uygun aletler ve ekipmanlar kullanın.</li></ul>
--	---

	<p><b>DİKKAT</b></p> <p><b>Keskin köşeler!</b> Kesik yaralanmaları</p> <ul style="list-style-type: none"><li>▶ Koruyucu eldiven kullanılmalıdır.</li></ul>
--	--

	<p><b>UYARI</b></p> <p><b>Eğilmiş cihazların kayması!</b> Kemik kırılmaları / çarpma sonucu yaralanmalar</p> <ul style="list-style-type: none"><li>▶ Cihazları kaymaya karşı emniyete alın.</li></ul>
--	---

	<p><b>DİKKAT</b></p> <p><b>Vidaların gevşetilmesi nedeniyle parçaların düşme tehlikesi!</b> Düşen parçalar nedeniyle yaralanma.</p> <ul style="list-style-type: none"><li>▶ Bileşenleri düşmeye karşı emniyete alın.</li></ul>
---	--

	<p><b>DİKKAT!</b></p> <p><b>Vidaların gevşetilmesi nedeniyle parçaların düşme tehlikesi!</b> Cihazın diğer parçalarında veya müşterinin evinde (örn. zemin) hasarlar.</p> <ul style="list-style-type: none"><li>▶ Bileşenleri düşmeye karşı emniyete alın.</li></ul>
--	--

Ön koşul:

- ✓ Cihazın fişi çekilir.
- ✓ Cihazın iç donanımları çıkartılmıştır.
- ✓ Üst menteşe çıkarılır.
- ✓ Orta menteşe çıkartılmıştır.

### 4.6.1 Kapının alt menteşesinin çıkartılması

- ▶ 1. Derin dondurucu bölmesi kapısını sökün (1).
- ▶ 2. Vidayı sökün (2).
- ▶ 3. Alt menteşeyi (3) çevirin.
- ▶ 4. Alt menteşeyi (4) çıkarın.

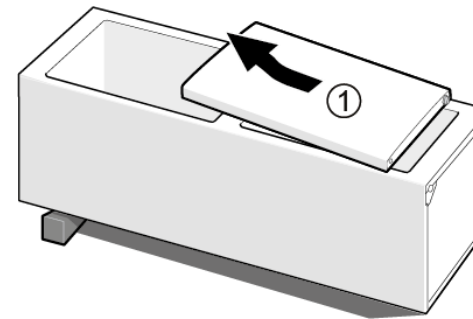
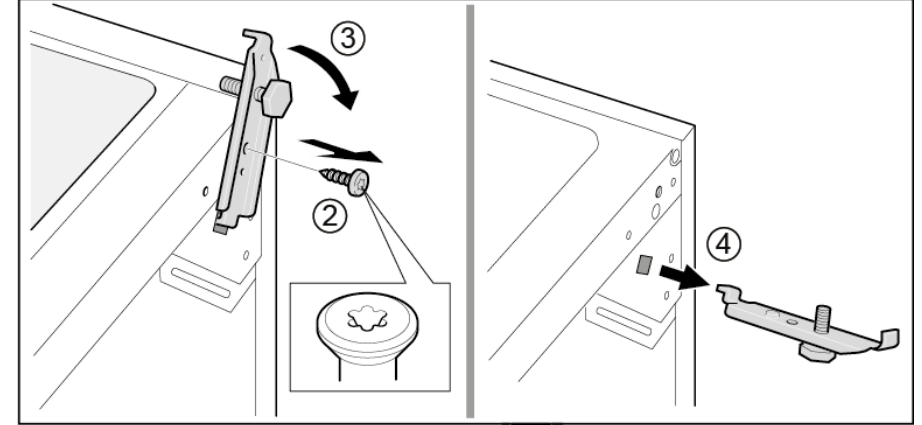

➡ Kapının alt menteşesi çıkartılmıştır.

### 4.6.2 Kapının alt menteşesinin takılması

- ▶ Ters sıra ile monte edin.

## 4.7 Raf yüzeyinin değiştirilmesi

Ön koşul:

- ✔ Kapı açık.

### 4.7.1 Raf yüzeyinin çıkartılması

- ▶ Raf yüzeyini dışarı çekin.

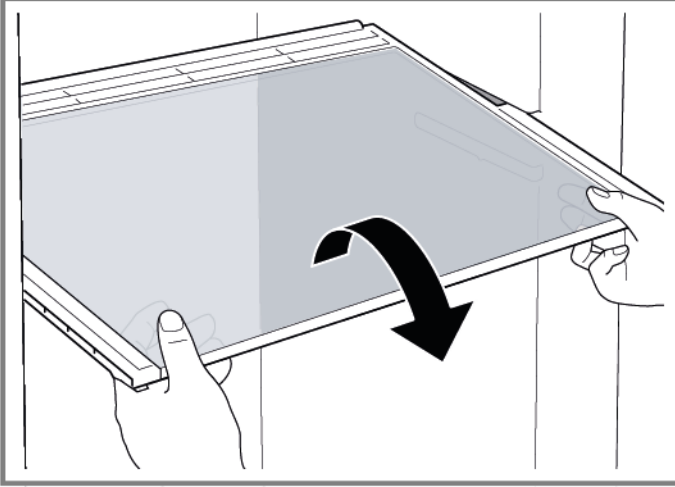

- ➡ Raf yüzeyi çıkartılmıştır.

### 4.7.2 Raf yüzeyinin takılması

- ▶ Ters sıra ile monte edin.

## 4.8 Değişken rafın çıkarılması ve takılması

Ön koşul:

- ✓ Kapı açık.

### 4.8.1 Değişken rafın çıkartılması

1. Değişken raf yüzeyinin sağ bölümünü öne doğru çekin (1).
2. Değişken rafın sağ bölümünü çıkartın (2).

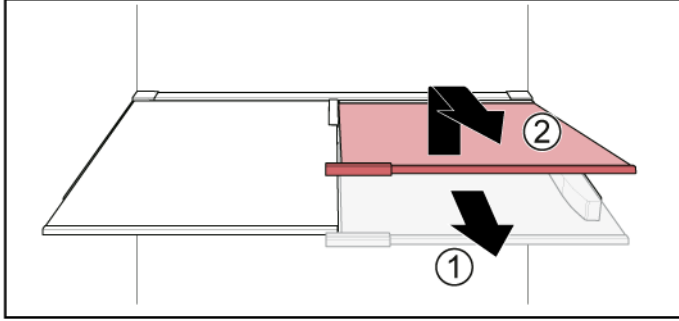

2. Değişken rafın sol bölümünü aynı şekilde çıkartın.

➡ Değişken raf çıkartılmıştır.

### 4.8.2 Değişken raf yüzeyinin takılması

- ▶ Ters sıra ile monte edin.

## 4.9 Esnek rafın deęiřtirilmesi

Ön koşul:

- ✓ Kapı açık.

### 4.9.1 Esnek rafın çıkartılması

- ▶ 1. Cam rafı çıkartın (1).
- ▶ 2. Esnek rafı kaldırın ve dışarı çekin (2).

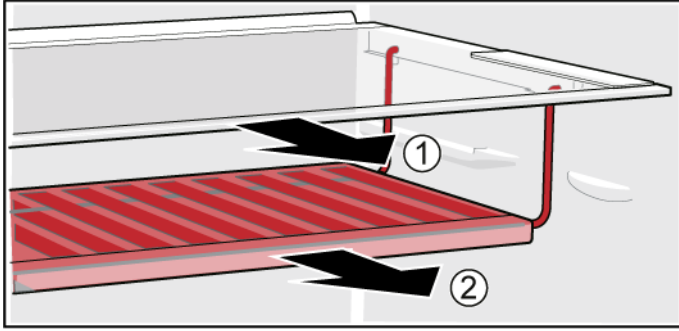

➡ Esnek raf çıkartılmıştır.

### 4.9.2 Esnek rafın takılması

- ▶ Ters sıra ile monte edin.

## 4.10 Kahvaltı setinin deęiřtirilmesi

Ön koşul:

- ✓ Kapı açık.

### 4.10.1 Kahvaltı setinin çıkartılması

- ▶ Kahvaltı setini kaldırın ve dışarı çekin.

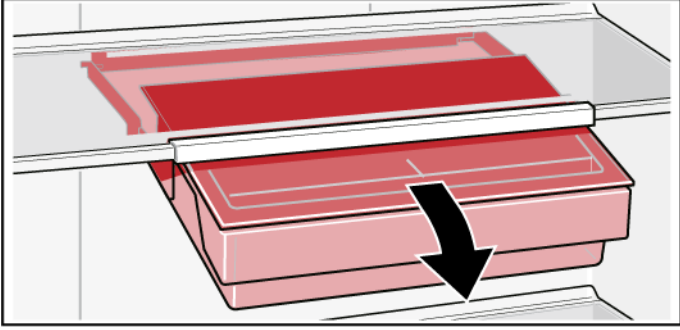

- ➡ Kahvaltı seti çıkartılmıştır.

### 4.10.2 Kahvaltı setinin takılması

- ▶ Ters sıra ile monte edin.

## 4.11 Şiše rafının değiştirilmesi

Ön koşul:

- ✔ Kapı açık.

### 4.11.1 Şiše rafının çıkartılması

- ▶ Şiše rafını dışarı çekin.

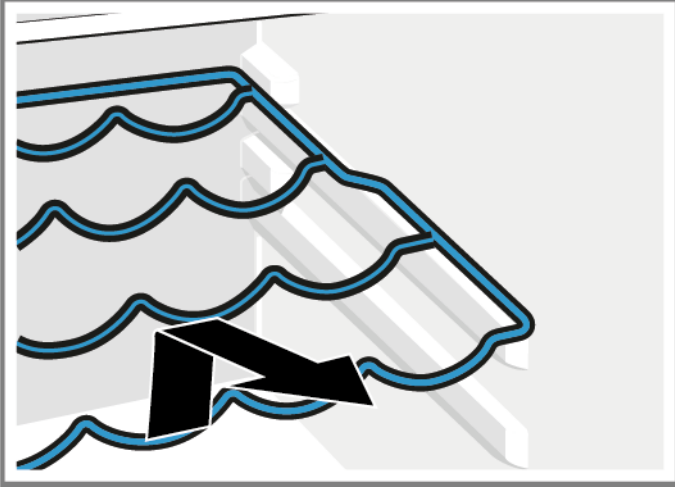

- ➡ Şiše rafı çıkartılmıştır.

### 4.11.2 Şiše rafının takılması

- ▶ Ters sıra ile monte edin.

## 4.12 Kapı rafının deęiřtirilmesi

Ön koşul:

- ✓ Kapı açık.

### 4.12.1 Kapı rafının çıkartılması

- ▶ Kapı rafını yukarıya doğru kaldırın.

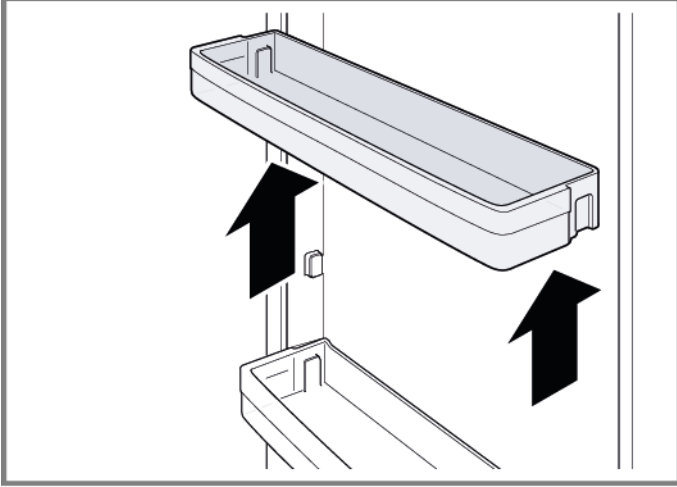

➡ Kapı rafı çıkartılmıştır.

### 4.12.2 Kapı rafının takılması

- ▶ Ters sıra ile monte edin.

## 4.13 Dondurulacak gıda kabının deęiřtirilmesi

Ön koşul:

- ✓ Kapı açık.

### 4.13.1 Dondurulacak gıda kabının çıkartılması

- ▶ 1. Dondurulacak gıda kabını tamamen dışarı çekin (1).
- ▶ 2. Gıda kabını çıkartın (2).

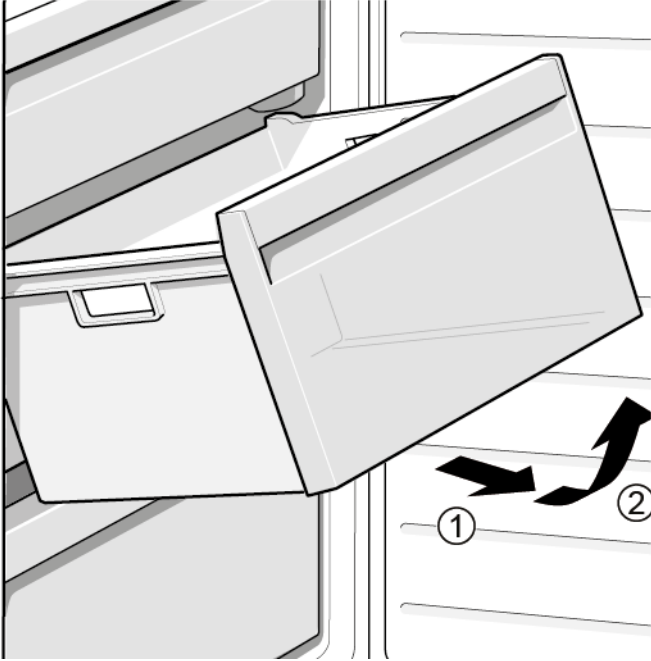

- ➡ Dondurulacak gıda kabı çıkartılmıştır.

### 4.13.2 Dondurulacak gıda kabının takılması

- ▶ Ters sıra ile monte edin.

## 4.14 Kabın deęiřtirilmesi

Ön koęul:

- ✓ Kapı açık.

### 4.14.1 Kabın çıkartılması

- ▶ 1. Alt buzdolabı kabını çıkartın (1).
- ▶ 2. Üst buzdolabı kabını çıkartın (2).

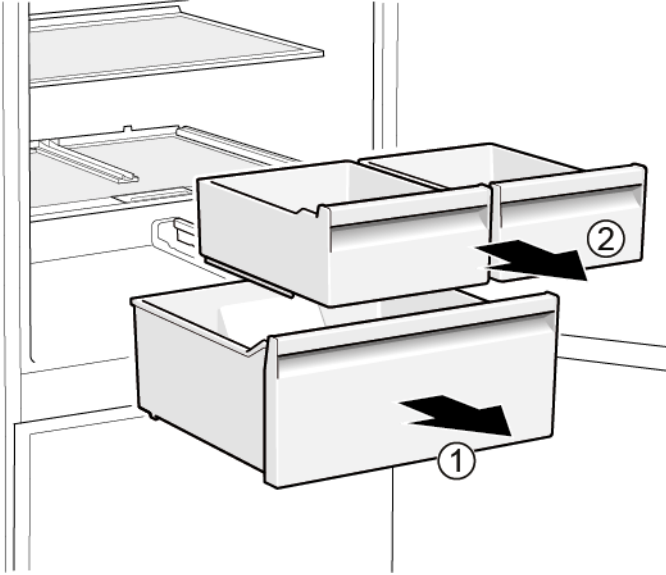

- ➡ Kaplar çıkartılmıştır.

### 4.14.2 Kabın takılması

- ▶ Ters sıra ile monte edin.

## 4.15 Uzatılabilir kabın değiştirilmesi

Ön koşul:

- ✓ Kapı açık.

### 4.15.1 Uzatılabilir kabın çıkartılması

- ▶ 1. Uzatılabilir kabı tamamen dışarı çekin (1).
- ▶ 2. Uzatılabilir kabı çıkartın (2).

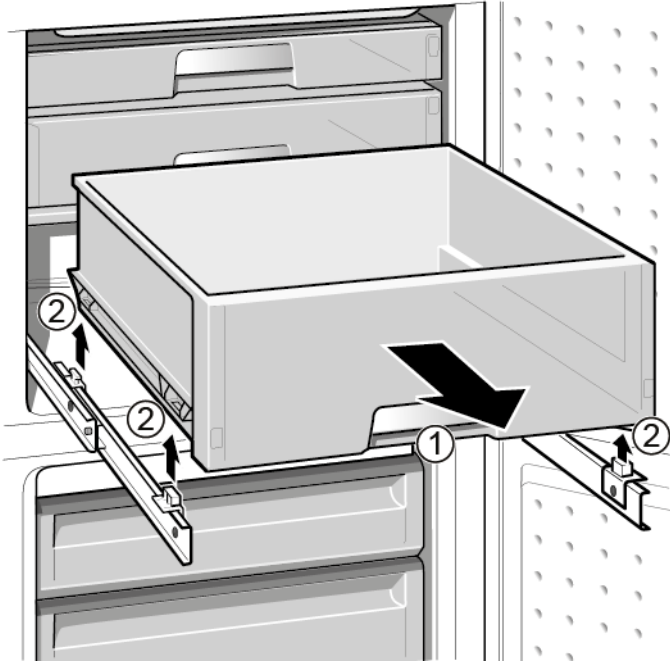

- ➡ Uzatılabilir kap çıkartılmıştır.

### 4.15.2 Uzatılabilir kabın takılması

- ▶ Ters sıra ile monte edin.

## 4.16 LED spot ışığının değiştirilmesi

Önerilen araçlar:

Special tool

[00342180]

**i** Cihazınızda bakım gerektirmeyen bir LED ışık bulunmaktadır.  
Bu ışıklar sadece müşteri hizmetleri veya yetkili teknisyenler tarafından değiştirilebilir!

**! TEHLİKE**  
**Gerilim ileten parçalar nedeniyle elektrik çarpması tehlikesi!!**  
Onarımın düzgün yapılmaması nedeniyle elektrik çarpması sonucu hayati tehlike

- ▶ Elektrikli parçaların onarımı kalifiye bir elektrik uzmanı tarafından gerçekleştirilmelidir.
- ▶ Onarım sonrasında VDE 0701 veya ülkeye özel düzenlemeler uyarınca bir güvenlik testi gerçekleştirilmelidir.

**! TEHLİKE**  
**Gerilim ileten parçalar nedeniyle elektrik çarpması tehlikesi!!**  
Elektrik çarpması sebebiyle ölüm

- ▶ Onarıma başlamadan önce cihazın elektrik şebeke bağlantısını en az 60 saniye süreyle sökün.

**! DİKKAT**  
**Keskin köşeler!**  
Kesik yaralanmaları

- ▶ Koruyucu eldiven kullanılmalıdır.

Ön koşul:

- ✓ Cihazın fişi çekilir.
- ✓ Kapı açık.

### 4.16.1 LED spot ışığının çıkartılması

1. LED spot ışığını dışarı çekmek için özel bir alet kullanın (1).

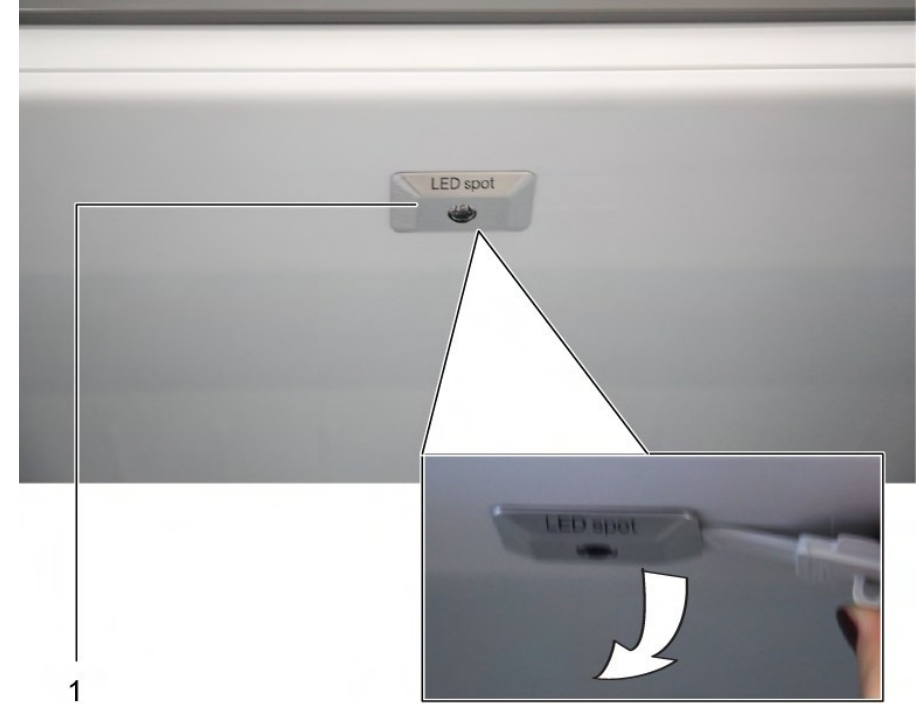

2. LED spot ışığının elektrik bağlantılarını ayırın.
- ➔ LED spot ışığı çıkartılmıştır.

### 4.16.2 LED spot ışığının takılması

- ▶ Ters sıra ile monte edin.

## 4.17 LED Üst aydınlatmanın değiştirilmesi

### Önerilen araçlar:

-  Düz tornavida Bıçak 2,4 mm x 0,4 mm x 60 mm,  
[00341820] numaralı kit içinde

 Cihazınızda bakım gerektirmeyen bir LED ışık bulunmaktadır.  
Bu ışıklar sadece müşteri hizmetleri veya yetkili teknisyenler tarafından değiştirilebilir!

 **TEHLİKE**  
**Gerilim ileten parçalar nedeniyle elektrik çarpması tehlikesi!!**  
Onarımın düzgün yapılmaması nedeniyle elektrik çarpması sonucu hayati tehlike

- ▶ Elektrikli parçaların onarımı kalifiye bir elektrik uzmanı tarafından gerçekleştirilmelidir.
- ▶ Onarım sonrasında VDE 0701 veya ülkeye özel düzenlemeler uyarınca bir güvenlik testi gerçekleştirilmelidir.

 **TEHLİKE**  
**Gerilim ileten parçalar nedeniyle elektrik çarpması tehlikesi!!**  
Elektrik çarpması sebebiyle ölüm

- ▶ Onarıma başlamadan önce cihazın elektrik şebeke bağlantısını en az 60 saniye süreyle sökün.

 **DİKKAT**  
**Keskin köşeler!**  
Kesik yaralanmaları

- ▶ Koruyucu eldiven kullanılmalıdır.

### Ön koşul:

- ✓ Cihazın fişi çekilir.
- ✓ Kapı açık.
- ✓ Üst iç donanımlar çıkartılmıştır.

### 4.17.1 LED Lambanın sökülmesi

1. LED Lambayı sol tarafa kaydırın.

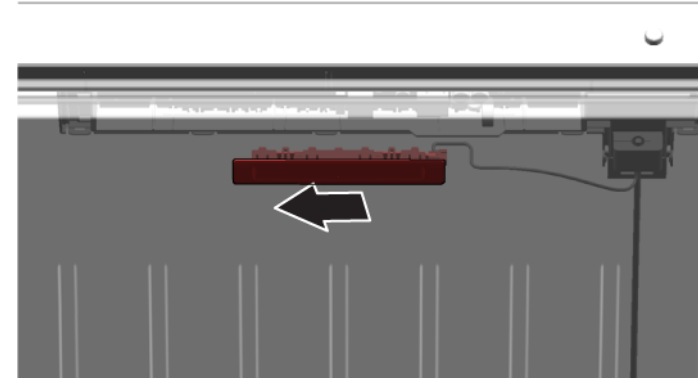

2. LED ışığının elektrik bağlantısı ayrıldı.

2. LED ışığını tırnaklarından kurtarın.

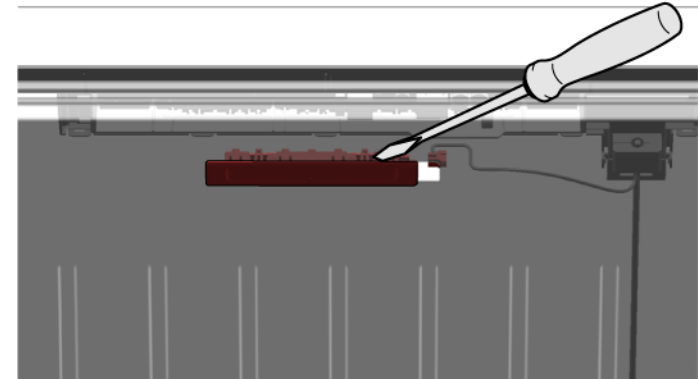

3. LED ışığını ileri hareket ettirerek sökün.

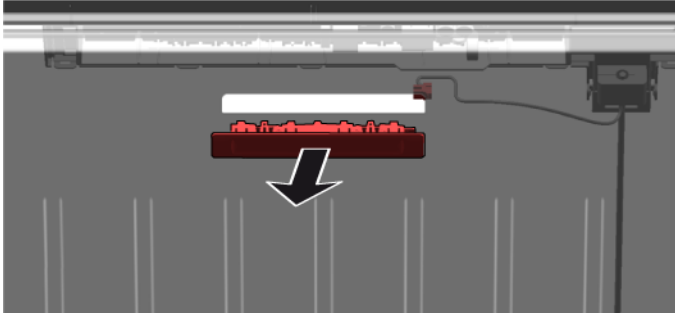

 LED ışığı söküldü.

### 4.17.2 Üst LED ışığının takılması

► Ters sıra ile monte edin.

## 4.18 LED yan çubuk ışığının değiştirilmesi

### Önerilen araçlar:

Vantuz Ø50 mm [00342224]

**i** Cihazınızda bakım gerektirmeyen bir LED ışık bulunmaktadır. Bu ışıklar sadece müşteri hizmetleri veya yetkili teknisyenler tarafından değiştirilebilir!

**⚠ TEHLİKE**  
**Gerilim ileten parçalar nedeniyle elektrik çarpması tehlikesi!!**  
Onarımın düzgün yapılmaması nedeniyle elektrik çarpması sonucu hayati tehlike

- ▶ Elektrikli parçaların onarımı kalifiye bir elektrik uzmanı tarafından gerçekleştirilmelidir.
- ▶ Onarım sonrasında VDE 0701 veya ülkeye özel düzenlemeler uyarınca bir güvenlik testi gerçekleştirilmelidir.

**⚠ TEHLİKE**  
**Gerilim ileten parçalar nedeniyle elektrik çarpması tehlikesi!!**  
Elektrik çarpması sebebiyle ölüm

- ▶ Onarıma başlamadan önce cihazın elektrik şebeke bağlantısını en az 60 saniye süreyle sökün.

**⚠ DİKKAT**  
**Keskin köşeler!**  
Kesik yaralanmaları

- ▶ Koruyucu eldiven kullanılmalıdır.

### Ön koşul:

- ✓ Cihazın fişi çekilir.
- ✓ Kapı açık.
- ✓ Soğutucu bölüm rafları çıkartılmıştır.

## 4.18.1 LED yan çubuk ışığının çıkartılması

1. Emme kabını LED yan çubuk ışığının üst üste birlik kısmına yapıştırın.



- Emme kabını LED yan çubuk ışığı ile birlikte döndürme hareketi uygulayarak öne doğru çekin.



- LED yan çubuk ışığının elektrik bağlantısını ayırın.  
➡ LED yan çubuk ışığı çıkartılmıştır.

### 4.18.2 LED yan çubuk ışığının takılması

- LED yan çubuk ışığının elektrik bağlantısını kurun.
  - LED yan çubuk ışığını, bölme panelinde yerine sabitleyin (kancalar yerine oturur).
- ➡ LED yan çubuk ışığının takılmıştır.