



BOSCH

Register your
new device on
MyBosch now and
get free benefits:
**[bosch-home.com/
welcome](https://bosch-home.com/welcome)**



Free standing cooker

HLS79R350A

[en] User manual

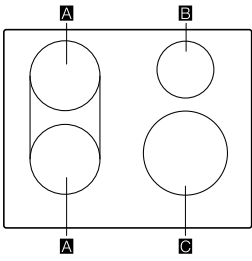

		g^1	b^1
A	Ø18	⊗ ⊗	1.800W 3.100W
	18 x 18	⊗	3.600W
B	Ø 14,5		1.400W 2.200W
C	Ø 21		2.200W 3.700W

¹  IEC 60335-2-6

Table of contents

1	Safety	3
2	Preventing material damage	7
3	Environmental protection and saving energy	8
4	Induction cooking	9
5	Installation and connection	10
6	Familiarising yourself with your appliance	12
7	Accessories	16
8	Before using for the first time	17
9	Operating the hotplate	17
10	CombiZone	19
11	Move function	20
12	Time-setting options	20
13	PowerBoost	21
14	Childproof lock	22
15	Locking the control panel for cleaning	22
16	Individual safety switch-off	22
17	Basic settings	22
18	Energy consumption display	23
19	Checking the cookware	24
20	PowerManager function	24
21	Basic operation	24
22	Rapid heating	25
23	Time-setting options	25
24	Programmes	27
25	Childproof lock	30
26	Sabbath mode	30
27	Basic settings	30
28	Cleaning and servicing	31
29	Pyrolysis	33
30	Cleaning aid	34
31	Rails	35
32	Appliance door	36
33	FAQs	39
34	Troubleshooting	40
35	Transportation and disposal	43
36	Customer Service	43

37	How it works	44
----	--------------------	----

1 Safety

Observe the following safety instructions.

1.1 Intended use

Read the information on intended use to ensure that you use the appliance correctly and safely.

The figures in these instructions are intended for information purposes.

Only a licensed professional may connect appliances without plugs. Damage caused by incorrect connection is not covered under the warranty.

Only use the appliance as follows:

- To prepare meals and drinks.
- Under supervision. Never leave the appliance unattended when cooking for short periods.
- In private households and in enclosed spaces in a domestic environment.
- Up to an altitude of max. 4000 m above sea level.

Do not use the appliance:

- On boats or in vehicles.
- as a room heater.
- with an external timer or a remote control.

You cannot operate the appliance with a timer or remote control.

If you wear an active implantable medical device (e.g. a pacemaker or defibrillator), check with your doctor that it complies with Council Directive 90/385/EEC of 20th June 1990, EN 45502-2-1 and EN 45502-2-2, and that it has been chosen, implanted and programmed in accordance with VDE-AR-E 2750-10. If these conditions are satisfied, and if, in addition, non-metal cooking utensils and cookware with non-metal handles are used, it is safe to use this induction hob as intended. If these conditions are satisfied, and if, in addition, non-metal cooking utensils and cookware with non-metal handles are used, it is safe to use this induction hob as intended. Always place accessories in the cooking compartment the right way round.

1.2 Restriction on user group

This appliance may be used by children aged 8 or over and by people who have reduced physical, sensory or mental abilities or inadequate experience and/or knowledge, provided that they are supervised or have been instructed on how to use the appliance safely and have understood the resulting dangers.

Do not let children play with the appliance. Children must not perform cleaning or user maintenance unless they are at least 15 years old and are being supervised.

Keep children under the age of 8 years away from the appliance and power cable.

1.3 Safe use

⚠ WARNING – Risk of fire!

The appliance will become hot.

- ▶ Do not keep combustible objects or aerosol cans in drawers directly underneath the hob.
- ▶ Never store or use combustible materials (e.g. spray cans or cleaning agents) under the appliance or in its immediate vicinity.

The cooking surface becomes very hot.

- ▶ Never place flammable objects on the cooking surface or in its immediate vicinity.
- ▶ Never place objects on the cooking surface.

Leaving fat or oil cooking on an unattended hob can be dangerous and may lead to fires.

- ▶ Never leave hot oil or fat unattended.
- ▶ Never attempt to extinguish a fire using water; instead, switch off the appliance and then cover with a lid or a fire blanket.

Hob covers can cause accidents, for example due to overheating, catching fire or materials shattering.

- ▶ Do not use hob covers.

Opening the appliance door creates a draught. Greaseproof paper may come into contact with the heating element and catch fire.

- ▶ Never place greaseproof paper loosely over accessories when preheating the appliance and while cooking.
- ▶ Always cut greaseproof paper to size and use a plate or baking tin to hold it down.

Combustible objects that are left in the cooking compartment may catch fire.

- ▶ Never store combustible objects in the cooking compartment.

- ▶ If smoke is emitted, the appliance must be switched off or the plug must be pulled out and the door must be held closed in order to stifle any flames.

Food may catch fire.

- ▶ The cooking process must be monitored. A short process must be monitored continuously.

After every use, switch off the hob using the main switch.

- ▶ Do not wait until the hob turns off automatically as there are no longer any pots and pans on it.

The hob switches off automatically and can no longer be operated. It may switch on unintentionally at a later point.

- ▶ Switch off the fuse in the fuse box.
- ▶ Call the customer service.

⚠ WARNING – Risk of burns!

The appliance and its parts that can be touched become hot during use, particularly the hob surround, if fitted.

- ▶ Caution should be exercised here in order to avoid touching heating elements.
- ▶ Young children under 8 years of age must be kept away from the appliance.

Metal objects on the hob quickly become very hot.

- ▶ Never place metal objects (such as knives, forks, spoons and lids) on the hob.

Hob protective grilles may cause accidents.

- ▶ Never use hob protective grilles.

Accessories and cookware get very hot.

- ▶ Always use oven gloves to remove accessories or cookware from the cooking compartment.

The appliance becomes hot during operation.

- ▶ Allow the appliance to cool down before cleaning.

When the cooking compartment is hot, any alcoholic vapours inside may catch fire.

- ▶ Only use small quantities of drinks with a high alcohol content in food.
- ▶ Open the appliance door carefully.

The appliance and its parts that can be touched become hot during use.

- ▶ Caution should be exercised here in order to avoid touching heating elements.
- ▶ Young children under 8 years of age must be kept away from the appliance.

⚠ WARNING – Risk of electric shock!

Incorrect repairs are dangerous.

- ▶ Repairs to the appliance should only be carried out by trained specialist staff.
- ▶ Only use genuine spare parts when repairing the appliance.
- ▶ If the power cord of this appliance is damaged, it must be replaced by the manufacturer, the manufacturer's Customer Service or a similarly qualified person in order to prevent any risk.

If the appliance or the power cord is damaged, this is dangerous.

- ▶ Never operate a damaged appliance.
- ▶ If the surface is cracked, you must switch off the appliance in order to prevent a possible electrical shock. To do this, switch off the appliance via the fuse in the fuse box rather than at the main switch.
- ▶ Call customer services. → *Page 43*

An ingress of moisture can cause an electric shock.

- ▶ Do not use steam- or high-pressure cleaners to clean the appliance.

The insulation on cables of electrical appliances may melt if it touches hot parts of the appliance.

- ▶ Never bring electrical appliance cables into contact with hot parts of the appliance.

If the insulation of the power cord is damaged, this is dangerous.

- ▶ Never let the power cord come into contact with hot appliance parts or heat sources.
- ▶ Never let the power cord come into contact with sharp points or edges.
- ▶ Never kink, crush or modify the power cord.

When you disconnect the appliance from the mains, the connections may cause residual voltages.

- ▶ Only allow a professional to connect the appliance.

⚠ WARNING – Risk of injury!

The hinges on the appliance door move when the door is opened and closed, which could trap your fingers.

- ▶ Keep your hands away from the hinges. Scratched glass in the appliance door may develop into a crack.

- ▶ Do not use any harsh or abrasive cleaners or sharp metal scrapers to clean the glass

on the oven door, as they may scratch the surface.

If you leave the appliance door open, people may bump into it, resulting in injury.

- ▶ Always keep the appliance door closed during and after operation.

When cooking in a bain marie, the hob and cooking container could shatter due to overheating.

- ▶ The cooking container in the bain marie must not directly touch the bottom of the water-filled pot.
- ▶ Only use heat-resistant cookware.

An appliance with a cracked or broken surface can cause cuts.

- ▶ Do not use the appliance if it has a cracked or broken surface.

⚠ WARNING – Risk of scalding!

The accessible parts of the appliance become hot during operation.

- ▶ Never touch these hot parts.
- ▶ Keep children at a safe distance.

Hot steam may escape when you open the appliance door. Steam may not be visible, depending on the temperature.

- ▶ Open the appliance door carefully.
- ▶ Keep children at a safe distance.

If there is water in the cooking compartment when it is hot, this may create hot steam.

- ▶ Never pour water into the cooking compartment when the cooking compartment is hot.

⚠ WARNING – Risk of suffocation!

Children may put packaging material over their heads or wrap themselves up in it and suffocate.

- ▶ Keep packaging material away from children.
- ▶ Do not let children play with packaging material.

Children may breathe in or swallow small parts, causing them to suffocate.

- ▶ Keep small parts away from children.
- ▶ Do not let children play with small parts.

⚠ WARNING – Risk of tipping!

If the appliance is placed on a base and is not secured, it may slide off the base.

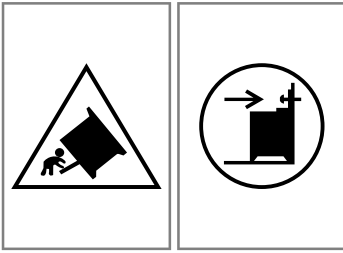

- ▶ Connect the appliance securely to the base.
- ▶ Warning: To prevent the appliance from tipping over, attach a compensation device.
- ▶ Observe the instructions for the installation.

1.4 Plinth drawer

⚠ WARNING – Risk of fire!

The surfaces of the plinth drawer may become very hot.

- ▶ Only store oven accessories in the drawer.
- ▶ Do not keep any flammable or combustible objects in the plinth drawer.

1.5 Halogen bulb

⚠ WARNING – Risk of burns!

The bulbs in the cooking compartment get very hot. There is still a risk of burning for some time after they have been switched off.

- ▶ Do not touch the glass cover.
- ▶ Avoid contact with your skin when cleaning.

⚠ WARNING – Risk of electric shock!

When changing the bulb, the bulb socket contacts are live.

- ▶ Before replacing the bulb, ensure that the appliance is switched off in order to prevent a potential electric shock.
- ▶ Also unplug the appliance from the mains or switch off the circuit breaker in the fuse box.

1.6 Cleaning function

⚠ WARNING – Risk of fire!

The outside of the appliance gets very hot when the cleaning function is in progress.

- ▶ Never hang combustible objects, e.g. tea towels, on the door handle.

- ▶ Leave the front of the appliance clear.
 - ▶ Keep children at a safe distance.
- If the door seal is damaged, a large amount of heat is generated around the door.
- ▶ Do not scrub or remove the seal.
 - ▶ Never operate the appliance if the seal is damaged or missing.

⚠ WARNING – Risk of serious harm to health!

The appliance gets very hot when the cleaning function is in progress. The non-stick coating on baking trays and tins is destroyed and noxious gases are released.

- ▶ Never clean non-stick baking trays or baking tins using the cleaning function.
- ▶ Never clean accessories at the same time.

⚠ WARNING – Risk of harm to health!

The cleaning function heats up the cooking compartment to a very high temperature so that food left over from roasting, grilling and baking will burn off. This process releases vapours, which can irritate mucous membranes.

- ▶ Keep the kitchen well ventilated while the cleaning function is running.
- ▶ Do not remain in the room for long periods.
- ▶ Keep children and pets away.

⚠ WARNING – Risk of burns!

The cooking compartment gets very hot when the cleaning function is in progress.

- ▶ Never open the appliance door.
- ▶ Allow the appliance to cool down.
- ▶ Keep children at a safe distance.

⚠ The outside of the appliance gets very hot when the cleaning function is in progress.

- ▶ Never touch the appliance door.
- ▶ Allow the appliance to cool down.
- ▶ Keep children at a safe distance.

2 Preventing material damage

2.1 Oven area

Follow the corresponding instructions when using the oven.

ATTENTION!

Objects on the cooking compartment floor at over 50 °C will cause heat to build up. The baking and roasting times will no longer be correct and the enamel will be damaged.

- ▶ Do not place any accessories, greaseproof paper or foil of any kind on the cooking compartment floor.
- ▶ Only place cookware on the cooking compartment floor if a temperature above 50 °C has been set.

If aluminium foil comes into contact with the door pane, it could cause permanent discolouration.

- ▶ Do not allow aluminium foil in the cooking compartment to come into contact with the door pane.

When the cooking compartment is hot, any water inside it will create steam. The change in temperature may cause damage.

- ▶ Never pour water into the cooking compartment when it is still hot.
- ▶ Never place cookware containing water on the cooking compartment floor.

The prolonged presence of moisture in the cooking compartment leads to corrosion.

- ▶ Allow the cooking compartment to dry after use.
- ▶ Do not keep moist food in the cooking compartment for a long time with the door closed.
- ▶ Do not store food in the cooking compartment.

Leaving the appliance to cool down with the door open will damage the front of neighbouring kitchen units over time.

- ▶ Always allow the cooking compartment to cool down with the door closed after cooking at high temperatures.
- ▶ Take care not to trap anything in the appliance door.
- ▶ Only leave the cooking compartment to dry with the door open if a lot of moisture was produced during operation.

Fruit juice dripping from the baking tray leaves stains that cannot be removed.

- ▶ When baking very juicy fruit flans, do not pack too much on the baking tray.
- ▶ If possible, use the deeper universal pan.

Using oven cleaner in a hot cooking compartment damages the enamel.

- ▶ Never use oven cleaner in the cooking compartment when it is still warm.
- ▶ Remove all food remnants from the cooking compartment and the appliance door before you next heat up the appliance.

If the seal is very dirty, the appliance door will no longer close properly during operation. This may damage the front of adjacent kitchen units.

- ▶ Keep the seal clean at all times.
- ▶ Never operate the appliance if the seal is damaged or missing.

Sitting or placing objects on the appliance door may damage it.

- ▶ Do not place or hang objects on the appliance door.
- ▶ Do not place cookware or accessories on the appliance door.

With certain models, accessories may scratch the door pane when closing the appliance door.

- ▶ Always push accessories fully into the cooking compartment.

If you carry or move the appliance by the handle on the cover or move, the handle may break off and cause damage to the hinges. The handle of the cover is not designed for the weight of the appliance.

- ▶ Do not carry or move the appliance by the handle on the cover.

When grilling, due to high temperatures, the baking tray or universal pan may become deformed and damage the enamel coating when they are removed.

- ▶ When grilling, do not insert the baking tray or universal pan higher than level 3.
- ▶ Above shelf position 3, only grill directly on the wire insert.

2.2 Hob

Follow the corresponding instructions when using the appliance.

Avoiding material damage

This is where you can find the most common causes of damage and tips on how to avoid them.

Damage	Cause	Measure
Stains	Unsupervised cooking process.	Monitor the cooking process.
Stains, blisters	Spilled food, especially food with a high sugar content.	Remove immediately with a glass scraper.
Stains, blisters or fractures in the glass	Defective cookware, cookware with melted enamel or cookware with copper or aluminium base.	Use suitable cookware that is in a good condition.
Stains, discolouration	Unsuitable cleaning methods.	Only use cleaning agents that are suitable for glass ceramic, and only clean the hob when it is cold.

Damage	Cause	Measure
Blisters or fractures in the glass	Knocks or falling cookware, cooking accessories or other hard or pointed objects.	When cooking, do not hit the glass or let objects fall onto the hob.
Scratches, discolouration	Rough cookware bases or moving the cookware on the hob.	Check the cookware. Lift the cookware when moving it.
Scratches	Salt, sugar or sand.	Do not use the hob as a work surface or storage space.
Damage to the appliance	Cooking with frozen cookware.	Never use frozen cookware.
Damage to the cookware or the appliance	Cooking without contents.	Never place or heat empty cookware on a hot cooking zone.
Glass damage	Melted material on the hot cooking zone or hot pot lid on the glass.	Do not place greaseproof paper or aluminium foil nor plastic containers or pot lids on the hob.
Overheating	Hot cookware on the control panel or on the frame.	Never place hot cookware on these areas.

2.3 Drawer area

Follow the corresponding instructions when using the drawer.

ATTENTION!

Do not place hot objects in the plinth drawer. The plinth drawer may be damaged.

- ▶ Do not place hot objects in the plinth drawer.

Do not place oven accessories that exceed the height of the drawer into the plinth drawer. Otherwise, this may damage the appliance.

- ▶ Do not place oven accessories that exceed the height of the drawer into the plinth drawer.

3 Environmental protection and saving energy

3.1 Disposing of packaging

The packaging materials are environmentally compatible and can be recycled.

- ▶ Sort the individual components by type and dispose of them separately.

3.2 Saving energy

If you follow these instructions, your appliance will use less energy.

Only preheat the appliance if the recipe or the recommended settings tell you to do so.

- Not preheating the appliance can reduce the energy used by up to 20%.

Use dark-coloured, black-coated or enamelled baking tins.

- These types of baking tin absorb the heat particularly well.

Open the appliance door as little as possible during operation.

- This maintains the temperature in the cooking compartment and eliminates the need for the appliance to reheat.

When baking multiple dishes, do so in succession or in parallel.

- The cooking compartment is heated after baking the first dish. This reduces the baking time for the second cake.

If the cooking time is relatively long, you can switch the appliance off 10 minutes before the cooking time ends.

- There will be enough residual heat to finish cooking the dish.

Remove any accessories that are not being used from the cooking compartment.

- Accessories that are not being used do not need to be heated.

Allow frozen food to defrost before cooking.

- This saves the energy that would otherwise be required to defrost it.

Note:

The appliance requires:

- A maximum of 1 W when the appliance is in operation with the display switched on
- A maximum of 0.5 W when the appliance is in operation with the display switched off

Saving energy

If you follow these instructions, your appliance will use less energy.

Select the cooking zone to match the size of your pan. Centre the cookware on the hob.

Use cookware whose base diameter is the same diameter as the hotplate.

Tip: Cookware manufacturers often give the upper diameter of the saucepan. It is often larger than the base diameter.

- Unsuitable cookware or incompletely covered cooking zones consume a lot of energy.

Cover saucepans with suitable lids.

- Cooking without a lid consumes considerably more energy.

Lift lids as infrequently as possible.

- When you lift the lid, a lot of energy escapes.

Use a glass lid.

- You can see into the pan through a glass lid without having to lift it.

Use pots and pans with flat bases.

- Uneven bases increase energy consumption.

Use cookware that is suitable for the quantity of food.

- Large items of cookware containing little food need more energy to heat up.

Cook with only a little water.

- The more water that is contained in the cookware, the more energy is required to heat it up.

Turn down to a lower power level early on.

- If you use an ongoing power level that is too high, you will waste energy.

Product Information according (EU) 66/2014 can be found on the attached appliance pass and online on the product page for your appliance.

4 Induction cooking

4.1 Advantages of induction cooking

Induction cooking is fundamentally different from traditional cooking methods, since the heat builds up directly in the cookware. This offers numerous advantages:

- Saves time when boiling and frying.
- Saves energy.
- Easier to care for and clean. Spilled food does not burn on as quickly.
- Controlling the heat supply and safety; the hob increases or decreases the heat supply as soon as the user changes the setting. The induction cooking zone stops the heat supply if you remove the cookware from the cooking zone without you having to switch it off first.

4.2 Cookware

Only ferromagnetic cookware is suitable for induction cooking.

For example:

- Enamelled steel cookware
- Cast iron cookware
- Special stainless steel cookware that is suitable for induction cooking

You can find additional information on which items of cookware are suitable for the induction cooking under → "Checking the cookware", Page 24

In order to achieve a good cooking result, ensure that the ferromagnetic area of the cookware base corresponds to the size of the cooking zone. If the cookware is not detected on a cooking zone, place it on a cooking zone with a smaller diameter.

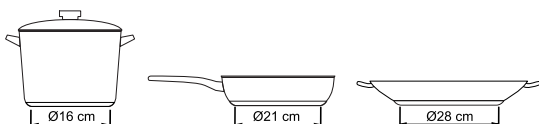

The base of many items of induction cookware is not fully ferromagnetic:

If you use large cookware with a smaller ferromagnetic base, only the area that is ferromagnetic heats up. As a result, the heat is not distributed evenly. The temperature of the non-ferromagnetic area may therefore be too low for cooking.

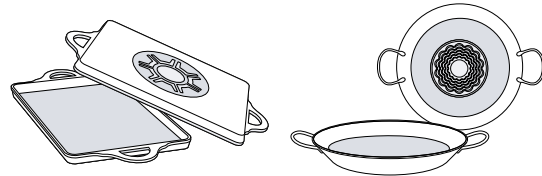

Cookware bases that contain aluminium reduce the ferromagnetic area. This may reduce the output and the cookware will not be detected sufficiently or at all, and will therefore not be heated sufficiently.

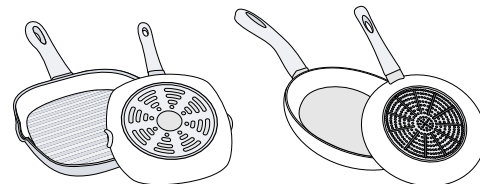

Unsuitable cookware

Never use flow plates or cookware made of the following:

- Thin-walled normal steel
- Glass
- Clay
- Copper
- Aluminium

Composition of the cookware base

The material(s) from which the base of the cookware is made can affect the cooking result. Cookware made of materials that distribute heat evenly in the pot, such as saucepans with a stainless steel sandwich base, save time and energy.

You should preferably use cookware with a flat base because uneven cookware bases impair the heat supply.

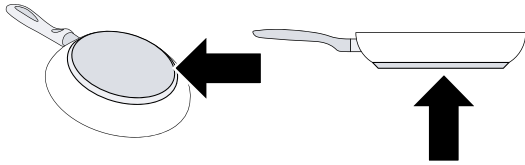

No cookware/cookware of an unsuitable size

If you do not place cookware on the selected cooking zone or the cookware is made of an unsuitable material or is not the right size for the cooking zone, the display for the cooking zone flashes. To make the display go out, place a suitable item of cookware on the cooking zone. If you do not place a suitable item of cookware on the cooking zone within 90 seconds, it automatically switches off.

Empty cookware or cookware with a thin base

Do not heat empty cookware and do not use cookware with a thin base. The hob is equipped with an internal safety system. However, empty cookware may heat up so quickly that the "Automatic switch-off" function does not respond in good time and an excessive temperature is reached. As a result, the base of the cookware may melt and damage the glass plate. In this case, do not touch the cookware and switch off the cooking zone. If the cooking zone no longer works after cooling down, contact the technical after-sales service.

Cookware detection

Each cooking zone has a minimum limit for the cookware detection and this depends on the ferromagnetic diameter and the material of the base of the cookware. Therefore, use the cooking zone that best corresponds to the diameter of the pan base.

5 Installation and connection

You can find out where and how best to install your appliance here. You will also learn how to connect your appliance to the power supply.

5.1 Electrical connection

The appliance must be connected to the mains by a licensed expert. You must comply with the requirements of your electricity supplier.

- Your appliance comes with the enclosed cable for permanently connecting it to the mains electricity supply. In the event of damage, never remove the cable from the appliance or replace it with another cable (with or without plug).
- If the power cord of this appliance is damaged, it must be replaced by the manufacturer, the manufacturer's Customer Service or a similarly qualified person in order to prevent any risk.
- Any damage arising from the appliance being connected incorrectly will invalidate the warranty.

Information on the electrical connection by the installer:

- If the plug is not accessible following installation, an all-pole isolating unit with a contact clearance of at least 3 mm must be available on the installation side. This is not necessary if the appliance is connected via a plug that is accessible to the user.
- Electrical safety: The cooker corresponds to safety class I and may only be used in conjunction with a safety earth terminal.
- To connect the appliance, use H 05 VV-F cables or other equivalent cables.

The mains voltage must correspond to the voltage specified on the rating plate.

Connect the wires in the power cord according to the colour coding:

Note: If the power cord is replaced Only connect it to the appliance as shown in the connection diagram

- Green and yellow: earth wire ⊕.
- Blue: (null) neutral wire

- Brown: phase (external conductor).

Important information about the electrical connection

Note the following information and ensure that:

⚠ WARNING – Risk of electric shock!

There is a risk of electric shock if you touch live components.

- ▶ Hold the mains plug with dry hands only.
- ▶ Never pull out the mains plug from the socket while the appliance is in operation.
- ▶ Pull out the power cable directly at the plug and never by pulling the power cable as this may become damaged.
- Fit the mains plug and socket together.
- The mains plug can be accessed at all times.
- The cross section of the cable is sufficient.
- The mains cable is not kinked, crushed, modified or severed.
- If required, the mains cable must only be replaced by a qualified electrician. A replacement mains cable is available from the after-sales service.
- Do not use any multiple plugs or multi-connectors and extension cords.
- The earthing system is correctly installed.
- If using a residual current device, only use one that bears the mark . The presence of this mark is the only way to be sure that it fulfils all the applicable regulations.
- The mains cable does not come into contact with heat sources.

5.2 Setting up the appliance

Place the appliance on a smooth surface.

Never set up the appliance behind a decorative door or the door of a kitchen unit. There is a risk of overheating.

Setting the base height of the appliance

Set the base height in accordance with the functions of your appliance.

Adjusting the height of the appliance with fixed drawers

If your appliance has fixed drawers, set the base height of your appliance as follows.

Note:

The appliance has height-adjustable feet. This allows the appliance to be raised approx. 15 mm from the ground.

- The feet are located at the front and rear on the underside of the appliance.
- Raise or lower the feet by turning the feet with an Allen key until the appliance is in a horizontal position.

Setting the base height of the appliance with a removable drawer

If your appliance does not have height-adjustable feet and the drawer is removable, set the base height of your appliance as follows.

1. Pull out the plinth drawer and lift it up and out. There are adjustable feet at the front and rear on the inside of the plinth.
2. Use an Allen key to raise or lower the adjustable feet until the cooker is level.

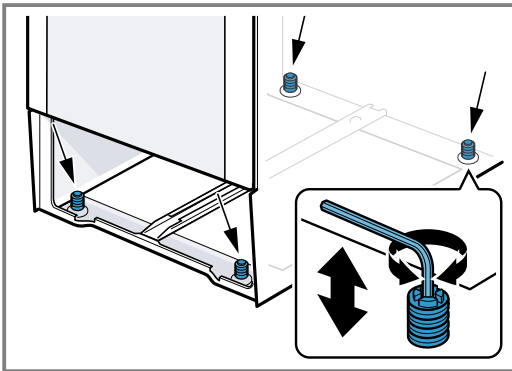

3. Push in the plinth drawer.

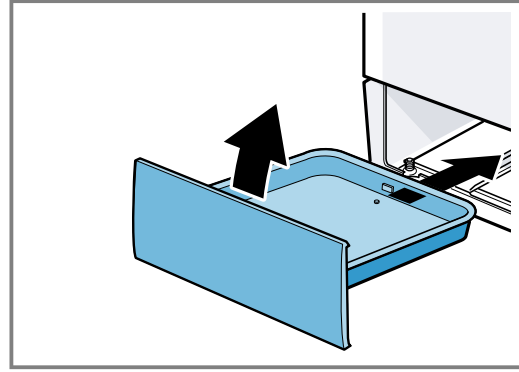

Adjacent units

Any adjacent units must not be made of flammable materials. The fronts of any adjacent units must be heat-resistant up to at least 90 °C.

Wall fixing

To prevent the appliance from tipping over, you must fix it to the wall using the enclosed brackets. To secure the appliance to the wall, follow the installation instructions.

5.3 Removing the appliance

Unplug the appliance from the mains.

⚠ WARNING – Risk of electric shock!

When you disconnect the appliance from the mains, the connections may cause residual voltages.

- ▶ Only allow a professional to connect the appliance.

6 Familiarising yourself with your appliance

6.1 Your appliance

You can find an overview of the parts of your appliance here.

Note: On certain models, specific details such as colour and shape may differ from those pictured.

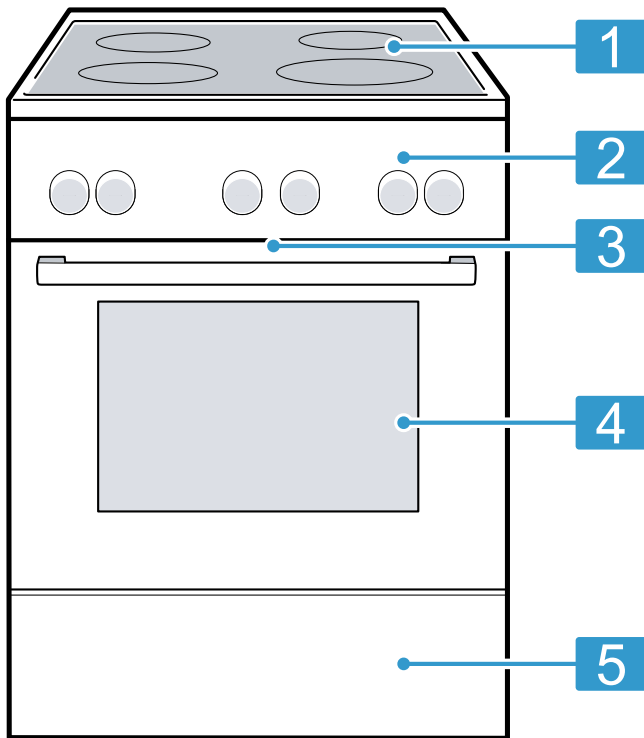

6.2 Control panels

You can use the control panel to configure all functions of your appliance and to obtain information about the operating status.

Controls

You can use the controls to configure all functions of your appliance and to obtain information about the operating status.

Control	Explanation
Buttons and display	The buttons are touch-sensitive surfaces. To select a function, simply press lightly on the relevant field. The display shows symbols for active functions and the time-setting options. → "Buttons and display", Page 13
Function selector	Use the function selector to set the types of heating and other functions. You can turn the function selector clockwise or anti-clockwise from the zero setting 0. Depending on the appliance, the function selector can be pushed in. Press on the function selector to click it into or out of the zero setting 0. → "Types of heating and functions", Page 13

	Explanation
1	Hob
2	Control panels
3	Cooling fan ¹
4	Appliance door
5	Plinth drawer ¹

¹ Depending on the appliance specifications







Control	Explanation
Temperature selector	Use the temperature selector to set the temperature for the type of heating and select settings for other functions. You can turn the temperature selector clockwise and anti-clockwise. It does not have a zero setting. Depending on the appliance, the temperature selector can be pushed in. Press on the temperature selector to click it in or out. → "Temperature and setting levels", Page 14

Control	Explanation
Hotplate control	You can use the four hotplate switches to control the output provided by each individual hotplate. The symbol above each of the switches shows you which hotplate is set using that switch.

Buttons and display

You can use the buttons to set various functions for your appliance. The display shows the settings.





If a function is active, the corresponding symbol lights up on the display. ☹ only lights up when you change the time.







Symbol	Function	Use
	Childproof lock	Activate or deactivate the childproof lock.
	Time-setting options	Select the time ☹, timer ⌚, cooking time ☹ and the end time ☹. To select the individual time-setting options, press ☹ several times. The red bar above or below the respective symbol indicates the function to which the setting in the display corresponds.
	Oven light	Switch the lighting in the cooking compartment on and off.
	Minus	Decrease the setting values.
	Plus	Increase the setting values.
	Rapid heating	Preheat the cooking compartment rapidly without accessories.

Types of heating and functions

To ensure that you always find the right type of heating to cook your food, we explain the differences and applications below.



When you select a type of heating, the appliance suggests a suitable temperature or setting. You can use these values or change them within the specified range.

Symbol	Type of heating and temperature range	What it's used for and how it works
	3D hot air 30 - 275 °C	Bake or roast on one or more levels. The fan distributes the heat from the ring-shaped heating element in the back wall evenly around the cooking compartment.
	Hot air gentle 125 - 275 °C	Cook selected dishes gently on one level without preheating. The fan distributes the heat from the ring-shaped heating element in the back wall evenly around the cooking compartment. The food is cooked in phases using residual heat. Always keep the appliance door closed when cooking. This type of heating is used to determine the energy consumption in air recirculation mode and the energy efficiency class.
	Pizza setting 30 - 275 °C	Cook pizza or food that requires a lot of heat from below. The bottom heating element and the ring-shaped heating element in the back wall heat the cooking compartment.
	Bottom heating 30 - 300 °C	Final baking or cooking food in a bain marie. The heat is emitted from below.

Symbol	Type of heating and temperature range	What it's used for and how it works
	Keep warm 60 - 100 °C	Keep cooked food warm.
	Defrosting 30 - 60 °C	Gently defrost frozen food.
	Slow cooking 70 - 120 °C	Slowly and gently cook seared, tender pieces of meat in uncovered cookware. The heat is emitted evenly from above and below at a low temperature.
	Full-surface grill Grill settings: 1 = low 2 = medium 3 = high	Grill flat items such as steak, sausages, or toast. Gratinated food. The entire area below the grill element becomes hot.
	Hot air grilling 30 - 300 °C	Roast poultry, whole fish or large pieces of meat. The grill element and the fan switch on and off alternately. The fan circulates the hot air around the food.
	Top/bottom heating 30 - 300 °C	Traditionally bake or roast on one level. This type of heating is especially suitable for cakes with moist toppings. The heat is emitted evenly from above and below. This type of heating is used to determine the energy consumption in the conventional mode.

Additional functions

Here, you can find an overview of other functions of your appliance.

Symbol	Function	Use
	Programmes	Use programmed setting values for various types of food. → "Programmes", Page 27
	Pyrolytic self-cleaning	Set the cleaning function, which cleans the cooking compartment virtually independently. → "Pyrolysis", Page 33

Temperature and setting levels

There are different settings for the types of heating and functions.

The settings appear in the display.

The temperature can be set in 1 degree increments up to 100 °C, and in 5 degree increments thereafter.

Note: For grill setting 3, the appliance lowers the setting to grill setting 1 after approx. 20 minutes.

Heat-up indicator

The appliance indicates when it is heating up.

The line at the bottom of the display turns red from left to right as the cooking compartment heats up.

When you preheat the appliance, the optimal time to place your food in the cooking compartment is as soon as the entire line has turned red.

Residual heat indicator

If you switch off the appliance, the line on the display shows the residual heat in the cooking compartment. The lower the temperature in the cooking compartment, the less the line is filled.

The control panel

On certain models, specific details such as the colour and shape may differ from those pictured.

Notes

- The heat-up indicator only shows the temperature increasing for types of heating for which a temperature is set. For grill settings, for example, the heat-up indicator shows a full line from the beginning.
- If the temperature in the cooking compartment is too high when the appliance is started, *h* appears in the display for some types of heating. Switch off the appliance and allow it to cool. Then restart the operation.
- Due to thermal inertia, the temperature that is displayed may differ slightly from the actual temperature inside the cooking compartment.

Cooking with induction

In comparison to conventional hobs, induction technology brings with it a series of changes and has a number of benefits such as time savings when cooking and frying, energy savings as well as greater ease of cleaning and care. It also offers improved heat control as the heat is generated directly in the cookware.

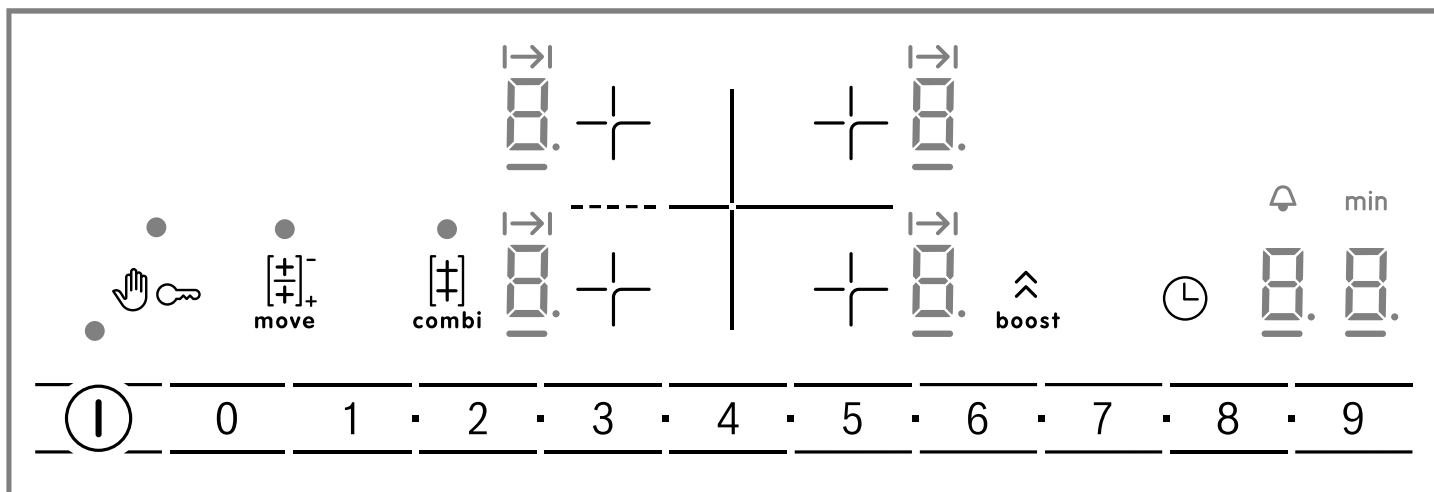

Selection sensors

Sensor	Function
①	Main switch
+/-	Select a cooking zone
0 1 2...8 9	Settings range
Hand icon	Control panel lock for cleaning purposes
Key icon	Childproof lock
combi icon	CombiZone function
move icon	Move function
boost icon	PowerBoost function
Timer icon	Timer function

Displays

Display	Function
□	Operating status
1-9	Power levels
00	Time-setting options
H/h	Residual heat
b	PowerBoost function
I->I	Setting the cooking time
⌚	Timer
min	Time display

Touch fields and displays

- Touch a symbol to activate the function it represents.
- Always keep the control panel clean and dry. Moisture impairs the function.
 - Do not place any cookware near the indicators or sensors. The electronics may overheat.

The cooking zones

You can find additional information on which items of cookware are suitable for the induction cooking under → "Induction cooking", Page 9.

The cooking zones

○/□	Single-circuit cooking zone	Use cookware that is a suitable size.
-----	-----------------------------	---------------------------------------

The cooking zones

□	Combi cooking zone	You can find additional information about this in the section entitled → "CombiZone", Page 19.
---	--------------------	--

Residual heat indicator

The hob has a residual heat indicator for each cooking zone. This indicates that a cooking zone is still hot. Do not touch the cooking zone immediately after switching it off or while the residual heat indicator is lit. Depending on the amount of residual heat, the following is shown:

- H display: High temperature
- h display: Low temperature

If you remove the cookware from the cooking zone during cooking, the residual heat indicator and the selected power level flash alternately.

If you switch off the cooking zone, the residual heat indicator lights up. If the hob has been switched off, the residual heat indicator remains lit for as long as the cooking zone remains warm.

6.3 Cooking compartment

The functions in the cooking compartment make your appliance easier to use.

Rails

The rails in the cooking compartment enable you to place accessories at different heights. The cooking compartment has five shelf positions. The shelf positions are numbered from bottom to top.

You can remove the rails, e.g. for cleaning.
→ "Rails", Page 35

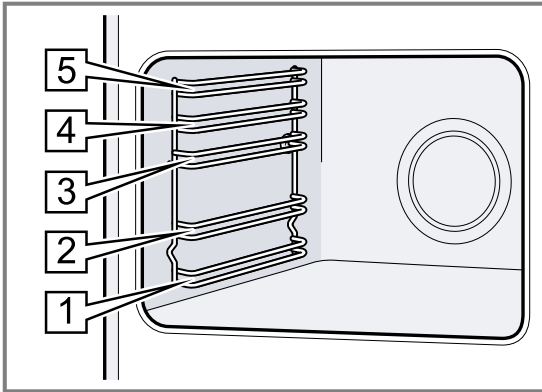

Lighting

The oven light lights up the cooking compartment. With most types of heating and functions, the lighting lights up during operation. If you use the function selector to end the operation, the lighting switches off. You can use the oven light button to switch on the light without heating up the oven.

Cooling fan

The cooling fan switches on and off depending on the appliance's temperature. The hot air escapes above the door.

ATTENTION!

Do not cover the ventilation slot above the appliance door. The appliance overheats.

- ▶ Ensure that the ventilation slots are unobstructed.

To ensure that the appliance cools down more quickly after operation, the cooling fan continues to run for a certain period afterwards.

Appliance door

If you open the appliance door during operation, the operation continues.

Condensation

Condensation can occur in the cooking compartment and on the appliance door when cooking. Condensation is normal and does not adversely affect appliance operation. Wipe away the condensation after cooking.

7 Accessories

Use original accessories. These have been made especially for your appliance.

Note: Heat may deform the accessory. This deformation has no effect on the function. When the accessory cools down, it will regain its original shape.

The accessories supplied may differ depending on the appliance model.

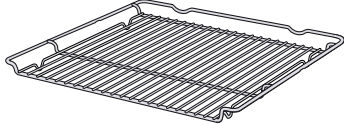
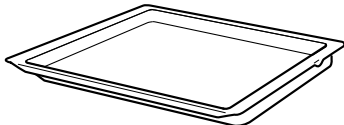
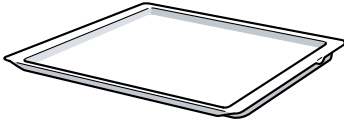
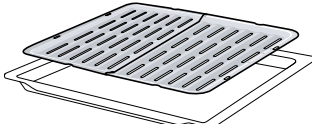
Accessories		Use
Wire rack		<ul style="list-style-type: none"> ■ Baking tins ■ Ovenproof dishes ■ Cookware ■ Meat, e.g. roasting joints or steak ■ Frozen meals
Universal pan		<ul style="list-style-type: none"> ■ Moist cakes ■ Biscuits ■ Bread ■ Large roasts ■ Frozen meals ■ Catching dripping liquids, e.g. fat when grilling food on the wire rack.
Baking tray		<ul style="list-style-type: none"> ■ Tray bakes ■ Sponge cake, simple
Grill tray		For grilling food

7.1 Using the accessory

Always slide the accessory into the cooking compartment correctly. This is the only way that you can remove the accessory halfway without it tipping.

1. Insert the accessory between the two guide rods for a shelf position.

Wire rack	Insert the wire rack with the open side facing the appliance door and the curved lip  facing downwards.
Baking tray E.g. universal pan or baking tray	Slide the tray in with the sloping edge facing the appliance door.

2. Grill tray To prevent splashes in the cooking compartment, insert a grill tray into the universal pan when grilling food.

3. Slide the accessory all the way in, making sure that the accessory does not touch the appliance door.

Note: Take any accessories that you will not be using out of the cooking compartment while the appliance is in operation.

7.2 Other accessories

You can purchase other accessories from our after-sales service, specialist retailers or online.

You will find a comprehensive range of products for your appliance in our brochures and online:

www.bosch-home.com

Accessories vary from one appliance to another. When purchasing accessories, always quote the exact product number (E no.) of your appliance.

You can find out which accessories are available for your appliance in our online shop or from our after-sales service.

8 Before using for the first time

Configure the settings for initial start-up. Clean the appliance and accessories.



8.1 Initial configuration

You have to implement settings for the initial configuration before you can use your appliance.

Setting the time

Once the appliance has been connected to the mains or after a power cut, the time flashes in the display. The time starts at "12:00". Set the current time.

Requirement: The function selector must be set to the off  position.

1. Use  or  to set the time.
2. Press .

✓ The time that is set appears in the display.

Tip: You can define whether the time is shown in the display in the basic settings → Page 22.

8.2 Cleaning the appliance before using it for the first time

Clean the cooking compartment and accessories before using the appliance to prepare food for the first time.

1. Remove the accessory and the leftover packaging, such as polystyrene pellets, from the cooking compartment.
2. Before heating, wipe the smooth surfaces in the cooking compartment with a soft, damp cloth.
3. Ventilate the room while the appliance is heating.
4. Set the type of heating and the temperature.
→ "Basic operation", Page 24

Type of heating	3D hot air 
-----------------	--

Temperature	Maximum
-------------	---------

Cooking time	1 hour
--------------	--------

5. Switch off the appliance after the specified cooking time.
6. Wait until the cooking compartment has cooled down.
7. Clean the smooth surfaces with soapy water and a dish cloth.
8. Clean the accessory with soapy water and a dish cloth or a soft brush.

9 Operating the hotplate



You can find out everything you need to know about operating your hotplate here.

9.1 Switching the hob on and off

Switch the hob on and off using the main switch .

If you switch the appliance back on again within four seconds after switching off, the hob starts up with the previously stored settings.

Switching on the hob

- ▶ Touch .
- An audible signal sounds and the  display beside it lights up.
- ✓ The hob is ready for use.

Switching off the hob

- ▶ Touch  until the displays go out.

The residual heat indicator lights up until the cooking zones have cooled down sufficiently.

- ✓ All cooking zones are switched off.

Note: The hob switches off if all cooking zones have been switched off for more than 20 seconds.

9.2 Setting the cooking zones

Select the required power level in the settings range.

Performance level

1	Lowest performance level
9	Highest performance level

Every power level has an intermediate setting. This is marked in the control panel with the ■ symbol.

Notes

- In order to protect the appliance's electronic parts from overheating or surge currents, the hob may temporarily reduce the power level.
- In order to prevent the appliance from producing excess noise, the hob may temporarily reduce the power level.

Selecting the cooking zone and power level

1. Touch + to select the cooking zone.

- ✓ The □ display lights up and the _ symbol lights up underneath it.

2. Select the required power level in the settings range.

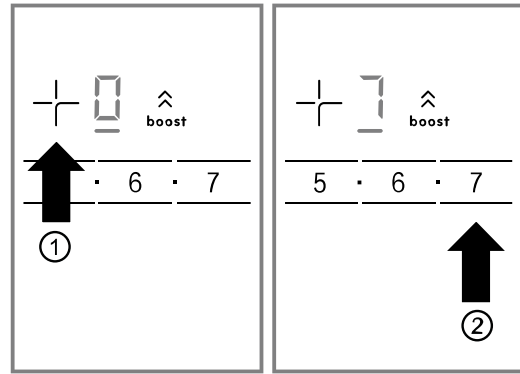

- ✓ The power level has been set.

Notes

- If you place cookware on the cooking zone before you switch the hob on, and you touch ①, the cookware is detected 20 seconds later. The cooking zone is selected automatically. If the cookware is detected, select the power level within 20 seconds, otherwise the cooking zone switches itself off. If you place several items of cookware down and switch on the hob, only one item of cookware is detected.
- If no cookware is placed on the cooking zone, the selected power level flashes. After a certain period of time, the cooking zone switches itself off.

Changing the power level and switching off the cooking zone

1. Select the cooking zone.
 2. Select the required power level in the settings area or set it to □.
- ✓ The cooking zone's power level changes or the cooking zone switches itself off and the residual heat indicator appears.

9.3 Cooking tips

- When heating up puree, cream soups or thick sauces, stir occasionally.
- To preheat, set the power level 8-9.
- When cooking with the lid on, reduce the power level as soon as you see steam escaping. The cooking result is not affected by the steam escaping.
- After cooking, close the cookware until you serve the dish.
- To cook with the pressure cooker, observe the manufacturer's instructions.
- Do not cook food for too long, otherwise nutrients will be lost. The kitchen timer enables you to set the optimal cooking time.
- Ensure that the oil does not smoke.
- To brown the food, fry it in small portions, one after the other.
- Some items of cookware may reach high temperatures while the food is cooking. You should therefore use oven gloves.
- You can find recommendations for energy-efficient cooking under → "Saving energy", Page 8

Cooking recommendations

The table shows which power level (□=■) is suitable for which food. The cooking time (⌚ min) may vary depending on the type, weight, thickness and quality of the food.

	□=■	⌚ min
Melting		
Chocolate, coatings	1 - 1.	-
Butter, honey, gelatine	1 - 2	-
Heating and keeping warm		
Stew, e.g. lentil stew	1. - 2	-
Milk ¹	1. - 2.	-
Boiled sausages ¹	3 - 4	-
Defrosting and heating		
Spinach, frozen	3 - 4	15 - 25
Goulash, frozen	3 - 4	35 - 55
Poaching, simmering		
¹ Without lid		
² Turn frequently		

	⏸	⌚ min
Potato dumplings ¹	4. - 5.	20 - 30
Fish ¹	4 - 5	10 - 15
White sauces, e.g. Béchamel sauce	1 - 2	3 - 6
Whisked sauces, e.g. Béarnaise sauce, Hollandaise sauce	3 - 4	8 - 12
Boiling, steaming, braising		
Rice, with double the volume of water	2. - 3.	15 - 30
Rice pudding	2 - 3	30 - 40
Unpeeled boiled potatoes	4. - 5.	25 - 35
Boiled potatoes	4. - 5.	15 - 30
Pasta ¹	6 - 7	6 - 10
Stew	3. - 4.	120 - 180
Soups	3. - 4.	15 - 60
Vegetables	2. - 3.	10 - 20
Vegetables, frozen	3. - 4.	7 - 20
Stew in a pressure cooker	4. - 5.	-
Stewing		
Rolled roasting joint	4 - 5	50 - 65
Pot-roasting	4 - 5	60 - 100
Goulash	3 - 4	50 - 60
Braising/frying with a small amount of fat¹		
Escalope, plain or breaded	6 - 7	6 - 10
Escalope, frozen	6 - 7	6 - 12
Chop, plain or breaded ²	6 - 7	8 - 12
Steak, 3 cm thick	7 - 8	8 - 12

¹ Without lid

² Turn frequently

	⏸	⌚ min
Poultry breast, 2 cm thick ²	5 - 6	10 - 20
Poultry breast, frozen	5 - 6	10 - 30
Patties, 3 cm thick ²	4. - 5.	20 - 30
Hamburgers, 2 cm thick ²	6 - 7	10 - 20
Fish and fish fillet, plain	5 - 6	8 - 20
Fish and fish fillet, breaded	6 - 7	8 - 20
Fish, breaded and frozen, e.g. fish fingers	6 - 7	8 - 15
Prawns and scampi	7 - 8	4 - 10
Sautéing fresh vegetables and mushrooms	7 - 8	10 - 20
Stir-fry, vegetables, meat cut in strips Asian-style	7 - 8	15 - 20
Frozen dishes, e.g. stir-fries	6 - 7	6 - 10
Pancakes, cooked one after the other	6. - 7.	-
Omelette, cooked one after the other	3. - 4.	3 - 10
Fried eggs	5 - 6	3 - 6
Deep-frying, 150–200 g per portion in 1–2 l oil, deep-fat fried in portions¹		
Frozen products, e.g. chips, chicken nuggets	8 - 9	-
Croquettes, frozen	7 - 8	-
Meat, e.g. chicken portions	6 - 7	-
Fish, breaded or battered	6 - 7	-
Vegetables, mushrooms, breaded, beer-battered or tempura	6 - 7	-
Small baked items, e.g. doughnuts, battered fruit	4 - 5	-

¹ Without lid

² Turn frequently

10 CombiZone

You can use this function to link the two left-hand cooking zones, which are the same size. When doing this, the same heat setting is set for both cooking zones. This is intended in particular for cooking with long cookware.

10.1 Information on using the cookware

For best results, use cookware that matches the size of the two cooking zones. Place the cookware in the centre of the cooking zones.

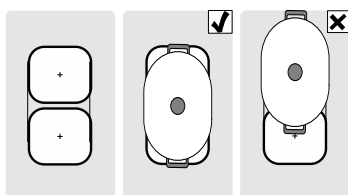

Note: If you are using only one item of cookware on one of the two cooking zones, you can move it to the second cooking zone. In this case, the power level and the selected settings are transferred.

10.2 Activating the CombiZone function

Requirement: The hob must be switched on.

1. Select one of the two cooking zones in the CombiZone and set the power level.
2. Touch . The ● display lights up.
 - ✓ The power level appears in the display for the lower cooking zone.
 - ✓ The function has now been activated.

10.3 Changing the power level

1. Select one of the two cooking zones assigned to the CombiZone function.
2. Change the power level in the settings area.

10.4 Deactivating the CombiZone function

1. Select one of the two cooking zones assigned to the CombiZone function.

2. Touch .
 - ✓ The function has now been deactivated.
 - ✓ The two cooking zones now operate independently of one another.

11 Move function

You can use this function to link the two left-hand cooking zones, which are the same size, and select a different power level for both.

Preset power levels:

- Front cooking zone = Power level 5
- Rear cooking zone = Power level 1.

You can change the power levels for each cooking zone independently of each other.

Notes

- Only use one of the cooking zones. If both cooking zones are used at the same time, the function is not activated.
- The power setting lights up less brightly in the display for the cooking zone on which there is no cookware. The power level is not activated until you move the cookware to this cooking zone or the cookware is detected.
- If the function is activated and a second piece of cookware is placed on the free cooking zone, the display lights up less brightly, but the cooking zone is not active. The cooking zone is activated when you remove the first item of cookware.

11.1 Information on using the cookware

In order to guarantee good thermal detection and heat distribution, position the cookware in the centre.

Only use one item of cookware that only covers one of the cooking zones:

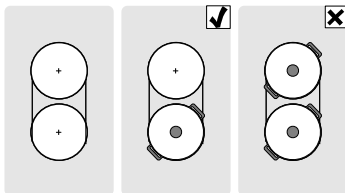

Move the cookware from one cooking zone to another:

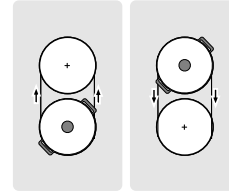

11.2 Activating the move function

Combine the two cooking zones that have different power levels.

1. Select one of the two cooking zones that belong to the move function.
2. Touch . The ● display lights up.
 - ✓ The power level lights up in the displays for the two cooking zones.
 - ✓ The move function has now been activated.

Notes

- The display for the cooking zone on which the cookware is located lights up brighter.
- The _ display lights up in the display for the cooking zone that is still selected.

11.3 Changing the power level

1. Select one of the two move cooking zones.
2. Change the power level in the settings area.
 - ✓ If you deactivate the function, the power levels return to the preset values.

11.4 Deactivating the move function

- ▶ Touch .
 - ✓ The move function has now been deactivated.

Note: You you set the power level for one of the cooking zones to 0, the function is deactivated within approx. 10 seconds.

12 Time-setting options



Your hob has various functions for setting the cooking time:

- Setting the cooking time
- Automatically programming the cooking time
- Timer

12.1 Setting the time

The cooking zone switches off automatically once the time that is set has elapsed. You can set a cooking time of up to 99 minutes.

Programming the cooking time

1. Select the cooking zone and the power level.
2. Touch .
 - ✓ The |→| display lights up in the cooking zone.
 - ✓  lights up in the timer display.

3. Within the next 10 seconds, set the required cooking time in the settings range.
 - To set a cooking time of less than 10 minutes, always touch 0 before you select the required value.

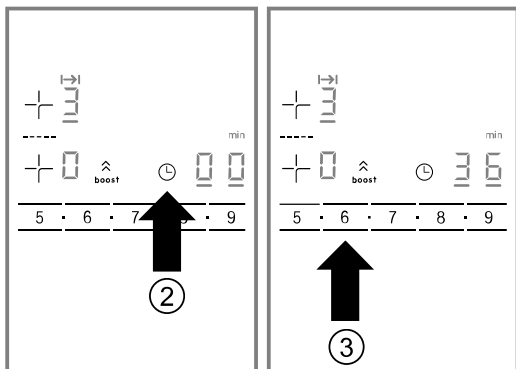

- ✓ The time starts to elapse.

Notes

- To view the remaining cooking time, select the corresponding cooking zone.
- If you have set a cooking time for several cooking zones, the time information for each of the selected cooking zones always appears in the timer display.
- If you select the CombiZone function for the combined cooking zone, the set time for both cooking zones is the same.

Changing or deleting the cooking time

1. Select the cooking zone and then touch ☹.
2. To delete the time, change the cooking time in the settings range or set to 00.

Once the cooking time has elapsed

The cooking zone switches itself off. An audible signal sounds and the 00 appears in the timer display for 10 seconds.

- ▶ Touch ☹.
- ✓ The displays go out and the audible signal stops.

12.2 Automatically programming the cooking time

You can automatically set the same cooking time for all cooking zones. The set time for each of the cooking zones counts down independently of the others.

You can find more information about this at → "Basic settings", Page 22.

12.3 Short-term timer

You can use the short-term timer to set a time of up to 99 minutes. This function operates independently of the cooking zones and other settings. This function does not automatically switch off a cooking zone.

Setting the short-term timer

1. Touch ☹ repeatedly until the ☹ display lights up.
 - ✓ 00 lights up in the timer display.
2. Set the desired time in the settings range.
 - ✓ After a few seconds, the time begins to elapse.

Changing or deleting the timer duration

1. Touch ☹ repeatedly until the ☹ display lights up.
2. In the settings range, change the time or set to 00 to delete the time.

Once the timer duration has elapsed

A signal sounds. 00 appears in the timer display and the ☹ display lights up. The displays go out after 10 seconds.

- ▶ Touch ☹.
- ✓ The displays go out and the audible signal stops.

13 PowerBoost

The PowerBoost function enables you to heat up large quantities of water faster than when using power level 9.

This function is available for all cooking zones if no other cooking zone is in use.

Otherwise **b** and 9 flash in the power level display.

Note: In the combi zone, you can only activate the PowerBoost function if you are using the two cooking zones as two independent cooking zones.

13.1 Activating the PowerBoost function

Requirement: In the combi zone, the PowerBoost function can only be activated if you are using the two cooking zones independently of each other.

1. Select the cooking zone.

2. Select power level 9 and then touch **b**. The **b** display lights up.
 - ✓ The function has been activated.

Note: If you switch on a cooking zone while the PowerBoost function is active, **b** and 9 flash in the power level display; power level 9 is then applied automatically. The PowerBoost function is deactivated.

13.2 Deactivating the PowerBoost function

1. Select the cooking zone.
2. Touch **b**. The **b** display goes out and the cooking zone switches back to the 9 power level.
 - ✓ The function has now been deactivated.



Note: In certain circumstances, the PowerBoost function is automatically switched off in order to protect the electronic elements inside the hob.

14 Childproof lock

The hob is equipped with a childproof lock. This prevents children from switching on the hob.

14.1 Activating the childproof lock

Requirement: The hob must be switched off.

- ▶ Touch and hold  for four seconds.
- ✓ The display beside  lights up for 10 seconds.
- ✓ The hob is now locked.

14.2 Deactivating the childproof lock

- ▶ Touch and hold  for four seconds.
- ✓ The lock is released.

14.3 Automatic childproof lock

The hob is equipped with an automatic childproof lock. This prevents children from switching on the hob.

Activating and deactivating

You can find more information about the automatic childproof lock under
→ "Basic settings", Page 22.

15 Locking the control panel for cleaning

You can use this function to lock the control panel for cleaning without having to change the settings you have selected for when the hob is switched on.

15.1 Activating the block of the control panel for cleaning

- ▶ touch . A signal sounds.
- ✓ The control panel remains locked for 35 seconds.

15.2 Deactivating the block of the control panel for cleaning purposes

To deactivate the function early.

- ▶ touch .
- ✓ The control panel is unlocked.

Notes

- An audible signal sounds 30 seconds after activation. This indicates that the function is about to finish.
- The lock has no effect on the main switch. You can switch off the hob at any time.

16 Individual safety switch-off

If you operate a cooking zone for an extended period and do not change any settings, the automatic safety shut-off is activated. Depending on which performance level has been selected, the cooking zone switches off automatically after 1 to 10 hours.

This stops the cooking zone from heating up. *FB* and the residual heat indicator *h* or *H* flash alternately in the cooking zone display.

To switch off the display, touch any symbol. You can set the cooking zone again.



17 Basic settings

You can configure the appliance to meet your needs.

17.1 Overview of the basic settings

Display	Function
<i>c</i> <i>!</i>	Childproof lock  Manual. ¹ <i>!</i> Automatic. <i>2</i> Function deactivated.

¹ Factory setting

Display	Function
<i>c</i> <i>2</i>	Audible signals  Confirmation and fault signals are deactivated. <i>!</i> Only the fault signal activated. <i>2</i> Only the confirmation signal is activated. <i>3</i> All signal tones are activated. ¹
<i>c</i> <i>3</i>	Display energy consumption  Deactivated. ¹ <i>!</i> Activated.

¹ Factory setting

Display	Function
c 5	Automatic switch-off of the cooking zones 00 Switched off. ¹ 01-99 Time until automatic switch-off.
c 6	Duration of the timer end signal tone 1 10 seconds. ¹ 2 30 seconds. 3 1 minute.
c 7	The power limitation function limits the total power of the hob . The available settings depend on the maximum power of the hob. 0 Deactivated. The hob's total power output is limited. ¹ 1 1000 W minimum power 1. 1500 W ... 3 3000 W is recommended for 13 A. 3. 3500 W is recommended for 16 A. 4 4000 W 4. 4500 W is recommended for 20 A. ... 9 or 9. The hob's total power output is limited.
c 9	Time for selecting the cooking zone 0 Unlimited: The cooking zone that was last set remains selected. ¹ 1 Limited: The cooking zone only remains selected for a few seconds.
c 12	Cookware test, result 0 Not suitable. 1 Not optimal. 2 Suitable.
c 23	Automatic management with power limitation 0 Deactivated: Shows the power limitation according to the power management function. ¹ 1 Activated: Does not show the power limitation of the power management function.
c 0	Restoring factory settings 0 Individual settings. ¹ 1 Factory settings.

¹ Factory setting

17.2 To go to the basic settings

Requirement: The hob must be switched off.

1. To switch on the hob, touch ①.

18 Energy consumption display

This function indicates the total amount of energy consumed between switching the hob on and switching it off again.

Once switched off, the energy consumption is displayed in kilowatt hours, e.g. 1.08 kWh, for 10 seconds.

2. Within the next 10 seconds, touch and hold ② for four seconds.

Product information	Display
Directory for the technical after-sales service (TK)	0 1
Production number	Fd
Production number 1	99.
Production number 2	0.5

- ✓ The first four displays provide the product information. To call up the individual displays, touch the control panel.
3. Touch ② to access the basic settings.

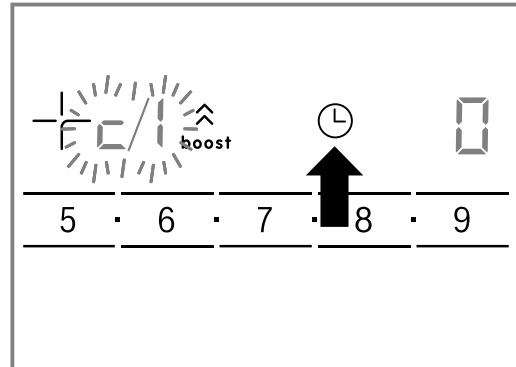

- ✓ c and 1, along with 0, light up alternately as a pre-setting.
4. Touch ② repeatedly until the required function is displayed.
 5. Select the required setting in the settings range.

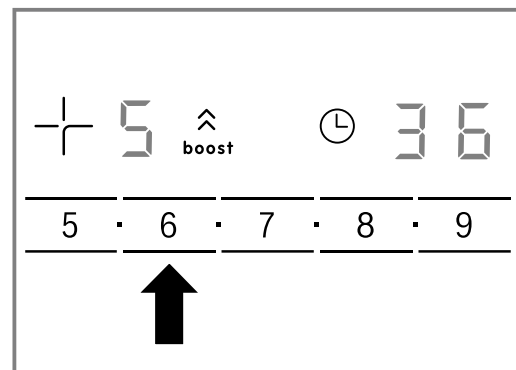

6. Touch and hold ② for four seconds.
- ✓ The settings are saved.

17.3 Exiting the basic settings

- ▶ Touch ① to switch off the hob.

The accuracy of the display depends on various factors such as the voltage quality of the power supply.

The display can be activated in the basic settings.

→ Page 22

19 Checking the cookware

You can use this function to check the speed and quality of the cooking process depending on the cookware. The result is a reference value and depends on the properties of the cookware and the cooking zone being used.

You can find more information about this function under

→ "Basic settings", Page 22 and on the type, size and positioning of the cookware under

→ "Induction cooking", Page 9.

19.1 Procedure for checking the cookware

1. Fill the cookware with approximately 200 ml water and place it at room temperature in the middle of the cooking zone that most closely matches the diameter of the base of the cookware.
2. Call up the basic settings and select **C 12**.
3. Touch the control panel. The — display flashes in the cooking zones.
 - ✓ The function has now been activated.
 - ✓ After 20 seconds, the result appears in the cooking zone displays.

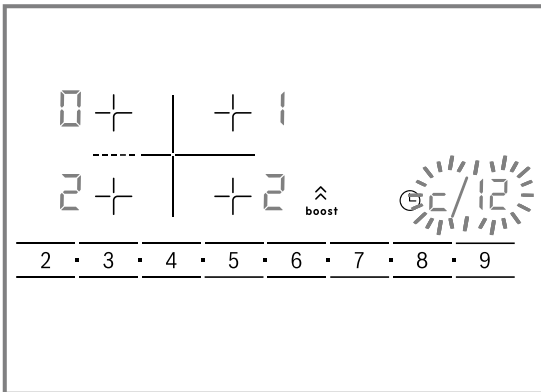

Note: If the diameter of the cooking zone that is used is much smaller than the diameter of the cookware, only the middle of the cookware can be expected to heat up. This may result in the cooking results not being as good as expected or being less than satisfactory.

19.2 Checking the result

In the following table, you can check the result for the quality and speed of the cooking process:

Result	
0	The cookware is not suitable for the cooking zone and therefore does not heat up. ¹
1	The cookware is taking longer to heat up than expected and cooking is not progressing as well as it ought to. ¹
2	The cookware is heating up correctly and cooking is progressing well.

¹ If a smaller cooking zone is available, test the cookware on this cooking zone.

To activate this function, touch the settings range.

20 PowerManager function

You can use the PowerManager function to configure the total power of the hob.

The hob settings are preconfigured at the factory. You can use this function to configure the settings in accordance with the requirements of an electrical installation.

In order to not exceed this set value, the hob automatically distributes the available power as needed between the cooking zones that are switched on.

While the PowerManager function is activated, the output of a cooking zone may temporarily fall below the nominal value. In order to not exceed this set value, the hob automatically distributes the available power as needed between the cooking zones that are switched on. The appliance regulates and selects the highest power level automatically.

If the automatic power limitation is activated, the appliance self-regulates but continues to display the selected power level unchanged.

For more information, go to .

21 Basic operation

21.1 Switching on the appliance

- ▶ Turn the function selector to any position other than the "Off" position 0.
- ✓ The appliance is switched on.

21.2 Switching off the appliance

- ▶ Turn the function selector to the "Off" position 0.
- ✓ The appliance is switched off.

21.3 Types of heating and temperature

1. Use the function selector to set the type of heating.
2. Use the temperature selector to set the temperature or grill setting.
 - ✓ The appliance starts heating after a few seconds.
 - ✓ Depending on the appliance type, rapid heating  automatically switches off at set temperatures of 200 °C and above and with certain types of heating.
 - "Rapid heating", Page 25
3. When the dish is ready, switch off the appliance.

Tips

- The most suitable type of heating for your food can be found in the description of the types of heating.

- You can also set a cooking time and an end time on the appliance.
 - "Time-setting options", Page 25

Changing the type of heating

You can change the type of heating at any time.

- ▶ Use the function selector to set the required type of heating.

Changing the temperature

You can change the temperature at any time.

- ▶ Turn the temperature selector to set the desired temperature.

22 Rapid heating

To save time, rapid heating can shorten the preheating time for set temperatures over 100 °C.



You can use rapid heating for the following types of heating:

- 3D hot air 
- Top/bottom heating 



22.1 Setting rapid heating

To ensure an even cooking result, do not place the food in the cooking compartment until rapid heating has come to an end.

Note: Do not set a cooking time until rapid heating has come to an end.

1. Set a suitable type of heating and a temperature of at least 100 °C.
 - Rapid heating automatically switches off at temperatures of 200 °C and above.
2. If rapid heating does not switch off automatically, press the  button.
 - ✓  appears in the display.
 - ✓ Rapid heating starts after a few seconds.
 - ✓ Once rapid heating has ended, a signal tone sounds and the  symbol goes out on the display.
3. Place the food in the cooking compartment.

Cancelling rapid heating





- ▶ Press the  button.
- ✓ The  symbol disappears from the display.

23 Time-setting options

Your appliance has different time-setting options which ensure that operation can be controlled.





23.1 Overview of the time-setting options



You can use the  button to select the different time-setting options.

Time-setting option	Use
Timer 	The timer can be set independently of the operation. It does not affect the appliance.
Cooking time 	If a cooking time has been set for the operation, the appliance stops heating automatically once this time has elapsed.
End 	A time at which the operation ends can be set for the cooking time. The appliance starts up automatically so that it finishes cooking at the required time.
Time 	Set the time.

23.2 Setting the timer

The timer runs independently of the appliance when it is in operation. The timer can be set up to 23 hours and 59 minutes regardless of whether the appliance is on or off. The timer has its own audible signal so that you can tell whether it is the timer or a cooking time which has elapsed.

1. Press  repeatedly until  is selected in the display.
2. Use the  or  button to set the timer duration.

Button	Recommended value
	5 minutes
	10 minutes

Up to 10 minutes, the timer duration can be set in 30-second increments. The time increments become bigger as the value increases.

- ✓ The timer starts and the timer duration begins to count down after a few seconds.
- ✓ An audible signal sounds and the timer duration is zero in the display when the timer duration has elapsed.
- 3. Once the timer duration has elapsed
 - Press any button to switch off the timer.

Changing the timer

The timer duration can be changed at any time.

Requirement: ⌘ is highlighted in the display.

- ▶ Use the — or + button to change the timer duration.
- ✓ The appliance applies the change after a few seconds.

Cancelling the timer

The timer duration can be cancelled at any time.

Requirement: ⌘ is highlighted in the display.

- ▶ Use the — button to reset the timer duration to zero.
- ✓ After a few seconds, the appliance applies the change and ⌘ goes out.

23.3 Setting the cooking time

The cooking time can be set to up to 23 hours and 59 minutes for the operation.

Requirement: The type of heating and temperature or setting have been set.

1. Press ⌚ repeatedly until ⌚ is selected in the display.
2. Use the — or + button to set the cooking time.

Additional programme	Recommended value
—	10 minutes
+	30 minutes

The cooking time can be set in one-minute increments up to one hour, and then in five-minute increments.

- ✓ After a few seconds, the appliance starts heating and the cooking time counts down.
- ✓ When the cooking time has elapsed, a signal sounds and the duration is at zero in the display.
- 3. When the cooking time has elapsed:
 - Press any button to end the signal prematurely.
 - To set another cooking time, press the + button.
 - When the dish is ready, switch off the appliance.

Changing the cooking time

The cooking time can be changed at any time.

Requirement: ⌚ is highlighted in the display.

- ▶ Change the cooking time using the — or + button.
- ✓ The appliance applies the change after a few seconds.

Cancelling the cooking time

The cooking time can be cancelled at any time.

Requirement: ⌚ is highlighted in the display.

- ▶ Reset the cooking time to zero using the — button.
- ✓ After a few seconds, the appliance applies the change and continues to heat without a cooking time.

23.4 Setting the end time

You can delay the time at which the cooking time is due to end by up to 23 hours and 59 minutes.

Notes

- The end time cannot be set for types of heating with grill function.

- In order to achieve a good cooking result, do not delay the end time once the appliance is already operating.
- Food will spoil if you leave it in the cooking compartment for too long.

Requirements

- The type of heating and temperature or setting have been set.
 - A cooking time must be set.
1. Press ⌚ repeatedly until ⌚ is selected in the display.
 2. Press the — or + button.
 - ✓ The display shows the calculated end time.
 3. Use the — or + button to delay the end time.
 - ✓ After a few seconds, the appliance applies the setting and the display shows the set end time.
 - ✓ Once the calculated start time has been reached, the appliance starts heating up and the cooking time starts counting down.
 - ✓ When the cooking time has elapsed, a signal sounds and the duration is at zero in the display.
 4. When the cooking time has elapsed:
 - Press any button to end the signal prematurely.
 - To set another cooking time, press the + button.
 - When the dish is ready, switch off the appliance.

Changing the end time

In order to achieve a good cooking result, you can only change the set end time before operation starts and the cooking time starts counting down.

Requirement: ⌚ is highlighted in the display.

- ▶ Use the — or + button to delay the end time.
- ✓ The appliance applies the change after a few seconds.

Cancelling the end time

You can delete the set end time at any time.

Requirement: ⌚ is highlighted in the display.

- ▶ Reset the end time to the current time plus the set cooking time using the — button.
- ✓ After a few seconds, the appliance applies the change and starts heating up. The cooking time counts down.

23.5 Setting the time

Once the appliance has been connected to the mains or after a power cut, the time flashes in the display. The time starts at "12:00". Set the current time.

Requirement: The function selector must be set to the off 0 position.

1. Use — or + to set the time.
2. Press ⌚.
 - ✓ The time that is set appears in the display.

Tip: You can define whether the time is shown in the display in the basic settings → Page 22.

24 Programmes

The programmes help you to use your appliance to prepare different dishes by selecting the optimum settings automatically.

24.1 Suitable cookware for programmes

You should therefore use heat-resistant cookware that is suitable for temperatures up to 300 °C. Glass or glass ceramic cookware is best. The joint should cover approx. two thirds of the cookware base.

Cookware made from the following material is not suitable:

- Bright, shiny aluminium
- Unglazed clay
- Plastic or plastic wire rack

24.2 Programme table

The programme numbers are assigned to specific foods.

No.	Meal	Cookware	Weight range Adjustment weight	Add liquid	Shelf posi- tion	Information
01	Pizza, thin base Frozen, prebaked	Universal pan with greaseproof paper	0.28–0.4 kg Total weight	No	3	For a second pizza, follow the instructions on the packaging
02	Pizza, deep-pan Frozen, prebaked	Universal pan with greaseproof paper	0.28–0.6 kg Total weight	No	3	For a second pizza, follow the instructions on the packaging
03	Lasagne Frozen	Original packaging	0.3–1.2 kg Total weight	No	3	-
04	Chips Frozen	Universal pan with greaseproof paper	0.2–0.75 kg Total weight	No	3	Spread out beside each other on the universal pan
05	Bread rolls Frozen, prebaked	Universal pan with greaseproof paper	0.1–0.8 kg Total weight	No	3	-
06	Potato gratin	Ovenproof dish without lid	0.5–3.0 kg Total weight	No	2	-
07	Pasta bake With precooked pasta	Ovenproof dish without lid	0.4–3.0 kg Total weight	No	2	-
08	Baked potatoes, whole Unpeeled, starchy potatoes	Universal pan	0.3–1.5 kg Total weight	No	3	-
09	Vegetable stew Vegetarian	Deep roasting dish with lid	0.5–2.5 kg Total weight	As per recipe	2	Cut vegetables that take longer to cook (e.g. carrots) into smaller pieces than vegetables that take less time to cook (e.g. tomatoes).
10	Meat stew	Deep roasting dish with lid	0.5–3.0 kg Total weight	As per recipe	2	Do not sear the meat beforehand.
11	Goulash Diced beef or pork, with vegetables	Deep roasting dish with lid	0.5–2.5 kg Total weight	As per recipe	2	Place the meat at the bottom and cover with vegetables. Do not sear the meat beforehand.
12	Fish, whole Ready to cook, seasoned	Roasting dish with lid	0.3–1.5 kg Weight of fish	Cover the bottom of the roasting dish.	2	-

No.	Meal	Cookware	Weight range Adjustment weight	Add liquid	Shelf posi- tion	Information
13	Chicken, unstuffed Ready to cook, seasoned	Roasting dish with glass lid	0.6–2.5 kg Chicken weight	No	2	Place in the cook- ware with the breast facing up.
14	Chicken pieces Ready to cook, seasoned	Roasting dish with lid	0.1–0.8 kg Weight of the heaviest piece	Cover the bottom of the roasting dish.	2	-
15	Turkey breast Whole, seasoned	Roasting dish with glass lid	0.5–2.5 kg Turkey breast weight	Cover the bottom of the roasting dish, and add up to 250 g ve- getables, if required.	2	-
16	Duck, unstuffed Ready to cook, seasoned	Roasting pan without lid	1.0–2.7 kg Duck weight	No	2	-
17	Goose, unstuffed Ready to cook, seasoned	Roasting pan without lid	2.5–3.5 kg Goose weight	No	2	-
18	Pot-roasted beef E.g. prime rib, shoulder, rump or mar- inated beef roast	Roasting dish with lid	0.5–2.5 kg Weight of meat	Almost cover the meat with liquid.	2	Do not sear the meat beforehand.
19	Sirloin, medium Ready to cook, seasoned	Roasting pan without lid	0.5–2.5 kg Weight of meat	No	2	Place in the cook- ware with the fatty side up. Do not sear the meat beforehand.
20	Beef roulades Stuffed with vegetables or meat	Roasting dish with lid	0.5–2.5 kg Total weight of all the stuffed roul- ades	Add stock or water, for ex- ample, to the dish until the roulades are almost covered.	2	Do not sear the meat beforehand.
21	Meat loaf, fresh Minced beef, pork or lamb	Roasting dish with lid	0.5–2.5 kg Roast weight	No	2	Do not sear the meat beforehand.
22	Leg of lamb, medium Boned, seasoned	Roasting dish with lid	0.5–2.5 kg Weight of meat	Cover the bottom of the roasting dish, and add up to 250 g ve- getables, if required.	2	Do not sear the meat beforehand.
23	Leg of lamb, well done Boned, seasoned	Roasting dish with lid	0.5–2.5 kg Weight of meat	Cover the bottom of the roasting dish, and add up to 250 g ve- getables, if required.	2	Do not sear the meat beforehand.
24	Joint of veal, marbled E.g. saddle or topside	Roasting dish with lid	0.5–3.0 kg Weight of meat	Cover the bottom of the roasting dish, and add up to 250 g ve- getables, if required.	2	Do not sear the meat beforehand.

No.	Meal	Cookware	Weight range Adjustment weight	Add liquid	Shelf posi- tion	Information
25	Joint of veal, lean E.g. tenderloin or eye	Roasting dish with lid	0.5–2.5 kg Weight of meat	Cover the bottom of the roasting dish, and add up to 250 g vegetables, if required.	2	Do not sear the meat beforehand.
26	Leg of roe venison Boned, seasoned with salt	Roasting dish with lid	0.5–2.0 kg Weight of meat	Cover the bottom of the roasting dish, and add up to 250 g vegetables, if required.	2	-
27	Rabbit, whole Ready to cook, seasoned	Roasting dish with glass lid	1.0–2.5 kg Weight of meat	Cover the bottom of the roasting dish, and add up to 250 g vegetables, if required.	2	-
28	Pork neck joint Boned, seasoned	Roasting dish with glass lid	0.5–3.0 kg Weight of meat	Cover the bottom of the roasting dish, and add up to 250 g vegetables, if required.	2	Do not sear the meat beforehand.
29	Joint of pork with rind E.g. shoulder, seasoned, and scored rind	Roasting dish with glass lid	0.5–3.0 kg Weight of meat	Cover the bottom of the roasting dish, and add up to 250 g vegetables, if required.	2	Place in the cookware fatty side up; salt the rind well.
30	Roasted lamb fillet Seasoned	Roasting dish with glass lid	0.5–2.5 kg Weight of meat	Cover the bottom of the roasting dish, and add up to 250 g vegetables, if required.	2	Do not sear the meat beforehand.

24.3 Preparing food for the programme



Use fresh and, ideally, chilled food. Use frozen food straight from the freezer.

1. Weigh the food.
The weight of the food is required in order to correctly set the programme.
2. Add the food to the cookware.
3. Place the cookware onto the wire rack.
Always place the ovenware into the cooking compartment without preheating it.

24.4 Setting a programme

The appliance selects the optimal type of heating, temperature and cooking time. All you need to do is set the weight.

Notes

- You can set the weight only in the intended range.
 - After the programme starts, you can no longer change the programme and the weight.
1. Use the function selector to set .
 2. Use — or + to set the required programme.
 3. Use the temperature selector to set the weight of your food. Always set the next higher weight.
 - To call up the programme's cooking time, press . You cannot change the cooking time.

- On some programmes, you can delay the end time using .
→ "Setting the end time", Page 26
- ✓ After a few seconds, the programme starts and the cooking time counts down.
- ✓ If the programme has ended, an audible signal sounds and the display shows the cooking time as zero.





4. When the programme ends:
 - Press any button to end the signal prematurely.
 - To set a cooking time for further cooking, press **+**. The appliance will resume heating using the programme settings.
 - When the dish is ready, switch off the appliance.

25 Childproof lock

Secure the appliance to prevent children from accidentally switching it on or changing the settings.

Note: The option to set the childproof lock can be activated in the Basic settings → Page 22.

25.1 Activating and deactivating the childproof lock

- Requirement:** The function selector must be set to the off  position.
- ▶ To activate the childproof lock, press and hold the  button until  appears in the display.
 - To deactivate the childproof lock, press and hold the  button until  goes out in the display.

26 Sabbath mode

You can use the Sabbath mode to set a time of over 70 hours. You can use top/bottom heating to keep food warm between 85 °C and 140 °C during this time without having to switch the appliance on or off.

26.1 Starting Sabbath mode

Notes

- If you open the appliance door during operation, the appliance does not interrupt the operation.
- Once it has started, you can no longer change or interrupt Sabbath mode.
- You cannot delay the end time for Sabbath mode.

Requirement: The Sabbath mode must be activated in the basic settings.



1. Use the function selector to set .
 - ✓ **SABb** appears in the display.
2. Use the temperature selector to set the maximum temperature.
3. Use **+** or **–** to set the cooking time.
 - ✓ After a few seconds, the appliance starts heating and the duration counts down.
 - ✓ Once the time has elapsed, the display shows the time as zero.
4. Switch off the appliance.

27 Basic settings

You can configure the basic settings for your appliance to meet your needs.

27.1 Overview of the basic settings

Here you can find an overview of the basic settings and factory settings. The basic settings depend on the features of your appliance.

Display	Basic setting	Selection
 0 1	Signal duration upon completion of a cooking time or timer period	1 = 10 seconds 2 = 30 seconds ¹ 3 = 2 minutes
 0 2	Waiting time until a setting is adopted	1 = 3 seconds ¹ 2 = 6 seconds 3 = 10 seconds
 0 3	Acoustic signal when a button is pressed	0 = off 1 = on ¹

¹ Factory setting (may vary according to model)

² Depending on the appliance specifications

Display	Basic setting	Selection
c 04	Brightness of the display illumination	1 = dark 2 = medium ¹ 3 = bright
c 05	Clock display	0 = hide the time 1 = display the time ¹
c 06	Childproof lock can be adjusted → "Childproof lock", Page 30	0 = no 1 = yes ¹ 2 = yes, with door lock
c 07	Interior lighting during operation	0 = no 1 = yes ¹
c 08	Cooling fan run-on time	1 = short 2 = medium ¹ 3 = long 4 = extra long
c 09	Telescopic shelves retrofitted ²	0 = no ¹ (for rails and 1-level pull-out) 1 = yes (for 2- and 3-level pull-out)
c 10	Sabbath mode available → "Sabbath mode", Page 30	0 = no ¹ 1 = yes
c 12	Automatic rapid heating from 200 °C ²	0 = No 1 = Yes ¹
c 13	Reset all values to factory settings	0 = no ¹ 1 = yes

¹ Factory setting (may vary according to model)

² Depending on the appliance specifications

27.2 Changing the basic settings

Requirement: The appliance is switched off.

1. Press and hold the ☺ button for approx. four seconds.
 - ✓ The first basic setting appears in the display, e.g. c012.
2. Use the temperature selector to change the setting.
3. Use the – or + button to switch to the next basic setting.

4. To save the changes, press and hold ☺ for approx. four seconds.

Note: Your changes to the basic settings will be retained even after a power failure.

27.3 Discarding changes to the basic settings

- ▶ Turn the function selector.
- ✓ All changes are discarded and not saved.

28 Cleaning and servicing

To keep your appliance working efficiently for a long time, it is important to clean and maintain it carefully.

28.1 Cleaning agent

To avoid damaging the different surfaces of the appliance, do not use unsuitable cleaning agents.

WARNING – Risk of electric shock!

An ingress of moisture can cause an electric shock.

- ▶ Do not use steam- or high-pressure cleaners to clean the appliance.

ATTENTION!

Unsuitable cleaning agents damage the surfaces of the appliance.

- ▶ Do not use aggressive or abrasive cleaning agents.

Suitable cleaning agents

Only use cleaning agents that are suitable for the different surfaces on your appliance.

- ▶ Do not use cleaning products with a high alcohol content.
- ▶ Do not use hard scouring pads or cleaning sponges.
- ▶ Do not use any special cleaners if the appliance is still warm.

Using oven cleaner in a hot cooking compartment damages the enamel.

- ▶ Do not use oven cleaner in the cooking compartment when it is still warm.
- ▶ Remove all food remnants from the cooking compartment and the appliance door before you next heat up the appliance.

New sponge cloths contain residues from production.

- ▶ Wash new sponge cloths thoroughly before use.

Follow the instructions on cleaning the appliance.
→ "Cleaning the appliance", Page 33

Appliance

Surface	Suitable cleaning agents	Information
Stainless steel	<ul style="list-style-type: none"> ▪ Hot soapy water ▪ Special stainless steel cleaning products suitable for hot surfaces 	To prevent corrosion, remove any limescale, grease, starch or albumin (e.g. egg white) stains on stainless steel fronts immediately. Apply a thin layer of the stainless steel cleaning product with a soft cloth.
Enamel, plastic, painted, and screen-printed surfaces E.g. control panel	<ul style="list-style-type: none"> ▪ Hot soapy water 	Do not use glass cleaner or a glass scraper.
Knobs	<ul style="list-style-type: none"> ▪ Hot soapy water 	Clean with a dish cloth and dry with a soft cloth. Do not remove or scrub.
Ceramic hob	<ul style="list-style-type: none"> ▪ Glass ceramic cleaner 	Follow the cleaning instructions on the product packaging. Remove heavy soiling using a glass scraper.
Plinth drawer	<ul style="list-style-type: none"> ▪ Hot soapy water 	Clean with a dishcloth.

Appliance door

Area	Suitable cleaning agents	Information
Door panels	<ul style="list-style-type: none"> ▪ Hot soapy water 	Do not use a glass scraper or stainless steel wool. Tip: Remove the door panels in order to clean them thoroughly. → "Appliance door", Page 36
Door panel	<ul style="list-style-type: none"> ▪ Made of stainless steel: Stainless steel cleaner ▪ Made of plastic: Hot soapy water 	Do not use glass cleaner or a glass scraper. Tip: Remove the upper door panel for thorough cleaning. → "Appliance door", Page 36
Door handle	<ul style="list-style-type: none"> ▪ Hot soapy water 	In order to avoid stubborn dirt, remove descaling agents from the door handle immediately.
Door seal	<ul style="list-style-type: none"> ▪ Hot soapy water 	Do not remove or scrub.

Cooking compartment

Area	Suitable cleaning agents	Information
Enamelled surfaces	<ul style="list-style-type: none"> ▪ Hot soapy water ▪ Vinegar water ▪ Oven cleaner 	Soak any heavily soiled areas and use a brush or steel wool. Leave the appliance door open to dry the cooking compartment after cleaning it. Tip: It is best to use the cleaning function. → "Pyrolysis", Page 33 Notes <ul style="list-style-type: none"> ▪ Enamel burns at very high temperatures, causing minor discoloration. The functionality of your appliance is not affected by this. ▪ The edges of thin baking trays cannot be completely enamelled and may be rough. This does not impair corrosion protection. ▪ Food residues will leave a white coating on the enamel surfaces. The coating does not pose a health risk. The functionality of your appliance is not affected by this. Remove residues with lemon juice.
Glass cover on the oven light	<ul style="list-style-type: none"> ▪ Hot soapy water 	Use oven cleaner to remove very heavy soiling.
Rails	<ul style="list-style-type: none"> ▪ Hot soapy water 	Soak any heavily soiled areas and use a brush or steel wool. Tip: Remove the shelf supports for cleaning. → "Rails", Page 35
Accessories	<ul style="list-style-type: none"> ▪ Hot soapy water ▪ Oven cleaner 	Soak any heavily soiled areas and use a brush or steel wool. Enamelled accessories are dishwasher-safe.

28.2 Cleaning the appliance

In order to avoid damaging the appliance, clean your appliance only as specified, and using suitable cleaning products.

⚠ WARNING – Risk of burns!

The appliance and its parts that can be touched become hot during use.

- ▶ Caution should be exercised here in order to avoid touching heating elements.
- ▶ Young children under 8 years of age must be kept away from the appliance.

⚠ WARNING – Risk of fire!

Loose food remnants, fat and meat juices may catch fire.

- ▶ Before using the appliance, remove the worst of the food residues and remnants from the cooking compartment, heating elements and accessories.

Requirement: Read the information on cleaning agents.

→ "Cleaning agent", Page 31

1. Clean the appliance using hot soapy water and a dish cloth.
 - For some surfaces, you can use alternative cleaning agents.
 - "Suitable cleaning agents", Page 31
2. Dry with a soft cloth.

28.3 Cleaning controls

⚠ WARNING – Risk of electric shock!

An ingress of moisture can cause an electric shock.

- ▶ Do not detach the control knobs to clean them.
- ▶ Do not use wet sponge cloths.

1. Observe the information regarding the cleaning agents.
2. Clean using a damp sponge cloth and hot soapy water.

3. Dry with a soft cloth.

28.4 Potential stains

In order to avoid these stains, clean the hob with a damp dish cloth and dry it with a cloth.

Dam- age	Cause	Action
Stains	Limescale and water marks	Only clean the hob when it has cooled down sufficiently. You can use a cleaning agent suitable for glass-ceramic hobs.
Stains	Sugar, rice starch or plastic	Clean immediately. Use a glass scraper.

28.5 Cleaning the hob

Clean the hob after every use to stop cooking residues from getting burnt on.

Requirement: The hob must be cold.

1. Remove heavy soiling using a glass scraper.
2. Clean the hob with a cleaning product for glass ceramic. Follow the cleaning instructions on the packaging of the cleaning product.

Tip: You can achieve good cleaning results using a special sponge for glass ceramic.

28.6 Cleaning the hob surround

If the hob frame is dirty or stained after use, clean this.

Note: Do not use a glass scraper.

1. Clean the hob frame with hot soapy water and a soft cloth. Wash new sponge cloths thoroughly before use.
2. Dry with a soft cloth.

29 Pyrolysis

With the pyrolysis cleaning function, the cooking compartment is cleaned virtually automatically. Use the cleaning function to clean the cooking compartment every two to three months. The cleaning function can be used more often, if required. The cleaning function requires approx. 2.5–4.8 kilowatt hours.

29.1 Preparing the appliance for the cleaning function

Carefully prepare the appliance in order to achieve a good cleaning result.

⚠ WARNING – Risk of fire!

Combustible objects that are left in the cooking compartment may catch fire.

- ▶ Never store combustible objects in the cooking compartment.
- ▶ If smoke is emitted, the appliance must be switched off or the plug must be pulled out and the door must be held closed in order to stifle any flames.

The outside of the appliance gets very hot when the cleaning function is in progress.

- ▶ Never hang combustible objects, e.g. tea towels, on the door handle.
- ▶ Leave the front of the appliance clear.
- ▶ Keep children at a safe distance.

Loose food residue, fat and meat juices may ignite while the cleaning function is running.

- ▶ Before starting the cleaning function each time, remove coarse dirt from the cooking compartment.
- ▶ Never clean accessories as well.

If the door seal is damaged, a large amount of heat is generated around the door.

- ▶ Do not scrub or remove the seal.
- ▶ Never operate the appliance if the seal is damaged or missing.

1. Remove accessories and cookware from the cooking compartment.
2. Detach the shelf supports and remove them from the cooking compartment.

3. Remove coarse dirt from the cooking compartment.
→ "Rails", Page 35
4. Clean the inside of the appliance door and the cooking compartment edge surfaces around the door with soapy water and a soft cloth.
Do not remove or scrub the door seal.
Use oven cleaner to remove stubborn dirt from the inside door pane.
5. Remove any items from the cooking compartment.
The cooking compartment must be empty.

29.2 Setting the cleaning function

Ventilate the kitchen while the cleaning function is running.

WARNING – Risk of burns!

 The outside of the appliance gets very hot when the cleaning function is in progress.

- ▶ Never touch the appliance door.
- ▶ Allow the appliance to cool down.
- ▶ Keep children at a safe distance.

The cooking compartment gets very hot when the cleaning function is in progress.

- ▶ Never open the appliance door.
- ▶ Allow the appliance to cool down.
- ▶ Keep children at a safe distance.

WARNING – Risk of harm to health!

The cleaning function heats up the cooking compartment to a very high temperature so that food left over from roasting, grilling and baking will burn off. This process releases vapours, which can irritate mucous membranes.

- ▶ Keep the kitchen well ventilated while the cleaning function is running.
- ▶ Do not remain in the room for long periods.
- ▶ Keep children and pets away.

Note: The oven light does not light up while the cleaning function is running.



Requirement: Prepare the appliance for the cleaning function. → Page 33

1. Use the function selector to set the pyrolysis .
2. Use the temperature selector to set the cleaning function.

Cleaning level	Degree of cleaning	Duration in hours
1	Light	Approx. 1:15
2	Medium	Approx. 1:30
3	High	Approx. 2:00

For stubborn or older dirt, select a higher cleaning level.

The duration cannot be changed.

- ✓ After a few seconds, the cleaning function starts and the duration counts down.
 - ✓ For your safety, the appliance door locks once a certain temperature is reached in the cooking compartment.  appears in the display.
 - ✓ When the cleaning function ends, a signal sounds and the duration is at zero in the display.
3. Switch off the appliance.
When the appliance has cooled down, the appliance door is unlocked and  goes out.
 4. The appliance is ready for operation. → Page 34

29.3 Preparing the appliance after the cleaning function

1. Allow the appliance to cool down.
2. Wipe off any ash that has been left behind in the cooking compartment and around the appliance door with a damp cloth.
3. Remove white deposits using citric acid.

Note: White deposits on the enamel surfaces may be caused by coarse dirt. These food residues are harmless. The deposits do not impair the function of the appliance.

4. Attach the shelf supports.
→ "Rails", Page 35

30 Cleaning aid

The cleaning aid is a fast alternative for occasionally cleaning the cooking compartment. The cleaning aid evaporates soapy water and therefore softens dirt. This means that dirt can be removed more easily.

30.1 Setting the cleaning aid

WARNING – Risk of scalding!





If there is water in the cooking compartment when it is hot, this may create hot steam.

- ▶ Never pour water into the cooking compartment when the cooking compartment is hot.

Requirement: The cooking compartment must be cooled down completely.

1. Remove the accessories from the cooking compartment.
2. Add one drop of detergent to 0.4 l water and pour it onto the centre of the cooking compartment floor.

Do not use distilled water.

3. Use the function selector to set the **Bottom heating**  type of heating.
4. Use the temperature selector to set 80 °C.
5. Press  repeatedly until  is selected in the display.
6. Use  or  to set the duration to four minutes.
- ✓ After a few seconds, the appliance starts heating and the duration counts down.
- ✓ When the cooking time has counted down, a signal sounds and the duration is at zero in the display.
7. Switch off the appliance and leave it to cool for approx. 20 minutes.

30.2 Cleaning the cooking compartment after using it

ATTENTION!

If the cooking compartment remains damp for too long, this results in corrosion.

- ▶ After using the cleaning aid, wipe the cooking compartment and allow it to dry completely.

Requirement: The cooking compartment has cooled down.

1. Open the appliance door and absorb the residual water with an absorbent sponge cloth.

2. Clean smooth surfaces in the cooking compartment with a dish cloth or a soft brush. Remove stubborn residues with a stainless steel spiral scourer.
3. Remove limescale deposits using a vinegar-soaked cloth. Wipe this away with clear water and use a soft cloth to also rub underneath the door seal dry.
4. Once the cooking compartment is sufficiently clean:
 - In order to cool the cooking compartment, leave the appliance door open in the detent position for approx. one hour.
 - To dry the cooking compartment more quickly, heat up the appliance with the door open with **3D hot air**  and 50 °C for approx. five minutes.

31 Rails

To clean the rails and cooking compartment thoroughly, you can remove the shelf supports.

31.1 Unhooking the rails

WARNING – Risk of burns!

The rails can be very hot.

- ▶ Never touch the rails when they are hot.
- ▶ Allow the appliance to cool down.
- ▶ Keep children at a safe distance.

1. Lift the front rail upwards and unhook it.

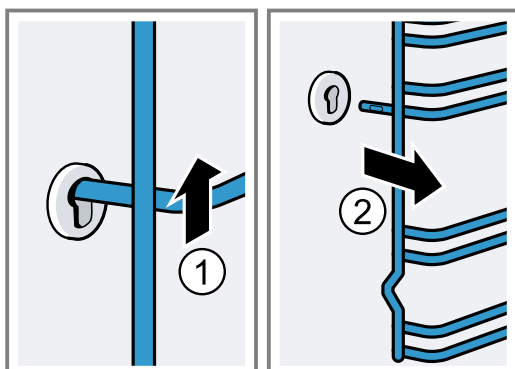

2. Then push the entire rail to the front and remove it.

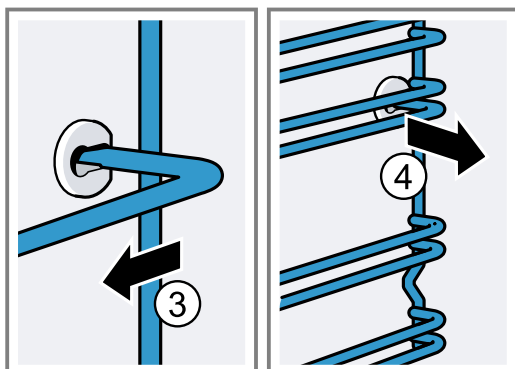

31.2 Attaching the rails

1. First insert the rail into the rear socket, press it to the back slightly

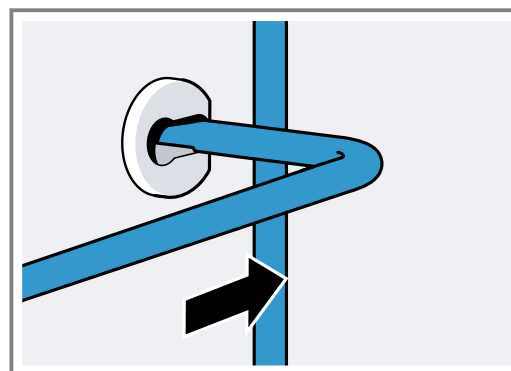

2. and insert it into the socket at the front.

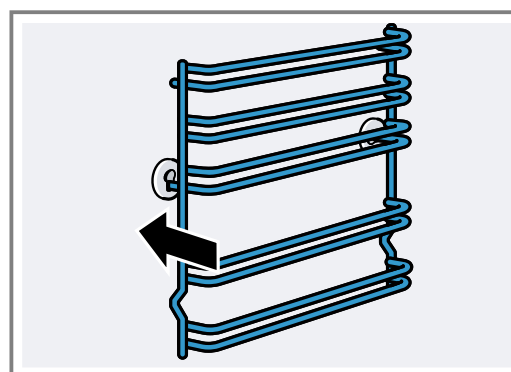

The rails fit both on the left and right sides. Shelf positions 1 and 2 are located at the bottom and shelf positions 3, 4 and 5 are located at the top.

32 Appliance door

It is normally sufficient if you clean the outside of the appliance door. If the appliance door is very dirty on the inside and outside, you can remove the appliance door and clean it.

32.1 Door hinges

⚠ WARNING – Risk of injury!

When the hinges are not secured, they can snap shut with great force.

- ▶ If you open the appliance door, ensure that the locking levers are fully open or fully closed.

1. The oven door hinges each have a locking lever. When the locking levers are closed, the oven door is secured in place.

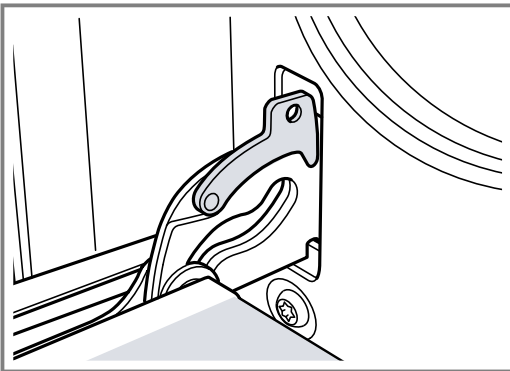

It cannot be detached.

2. When the locking levers are open in order to detach the oven door, the hinges are secured.

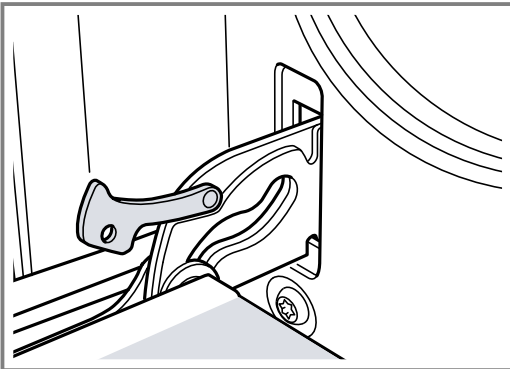

The hinges cannot snap shut.

32.2 Removing the appliance door

1. Open the oven door fully.

2. Open the locking levers on the left- and right-hand hinges.

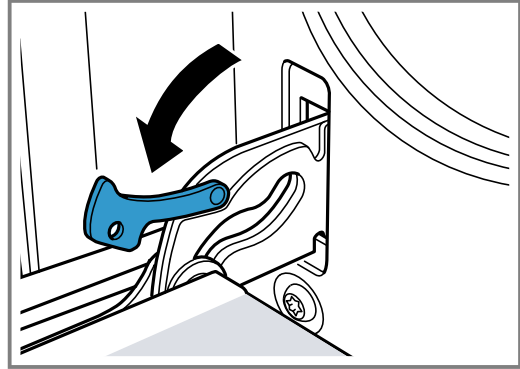

3. Close the oven door as far as the limit stop. Grip the left and right hand sides of the door with both hands. Close the door slightly more and remove it.

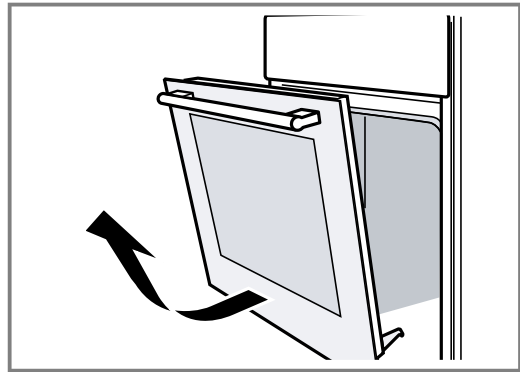

32.3 Removing the door panes

The glass panes of the oven door can be removed to make cleaning easier.

⚠ WARNING – Risk of injury!

Scratched glass in the appliance door may develop into a crack.

- ▶ Do not use any harsh or abrasive cleaners or sharp metal scrapers to clean the glass on the oven door, as they may scratch the surface.

The components in the appliance door may have sharp edges.

- ▶ Wear gloves.

1. Detach the oven door.
→ "Removing the appliance door", Page 36
2. Position it on a cloth with its handle pointing downwards.

3. Release the right- and left-hand screw from the cover in the upper area of the oven door. Pull out and remove the cover.

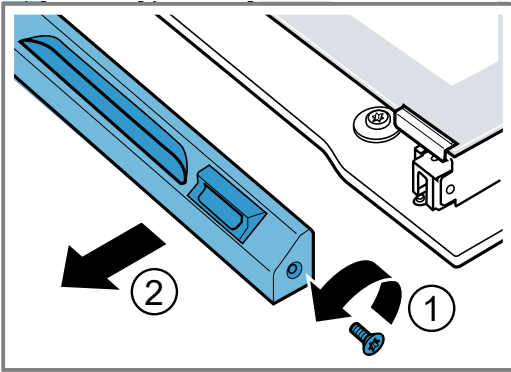

4. Remove the two small seals. Lift the top pane up and out.

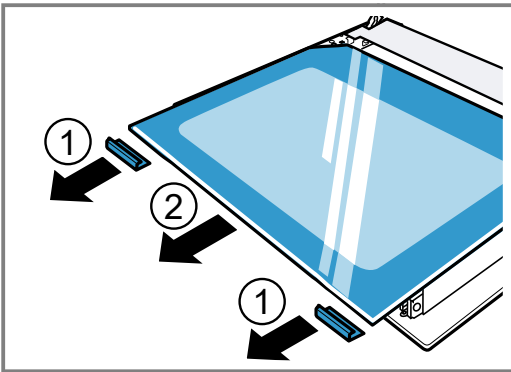

5. Unscrew the retaining clips on the right and left. Lift the pane and remove the claws from the pane.

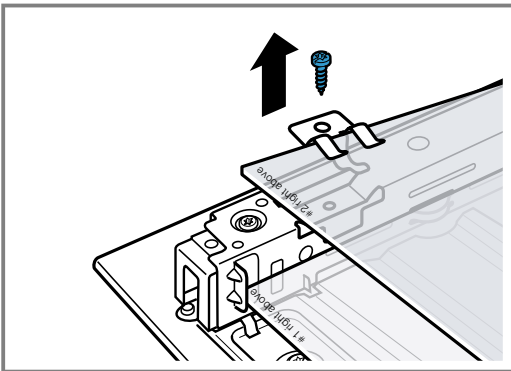

6. Remove the seal from below the pane. To do this, pull the seal and remove it upwards. Remove the pane.

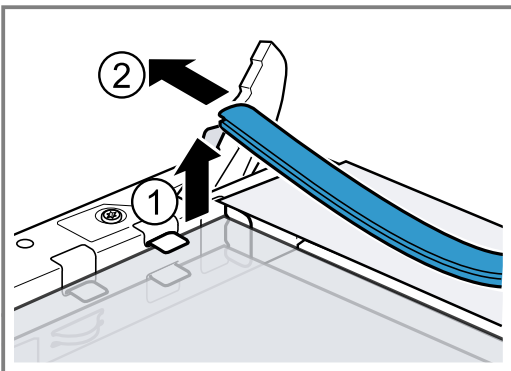

7. Pull the lower pane diagonally upwards and out.

8. Never remove the screws that are located on the right and left of the sheet metal part.

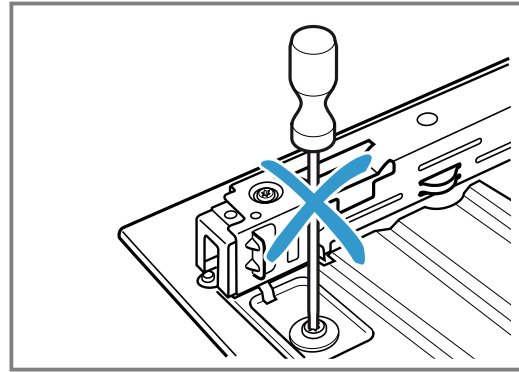

32.4 Fitting the door panes

When fitting the panes, ensure that, on both panes, the lettering "top right" is not upside down at the bottom left.

1. Insert the lower pane with the no. 1 downwards at an angle.

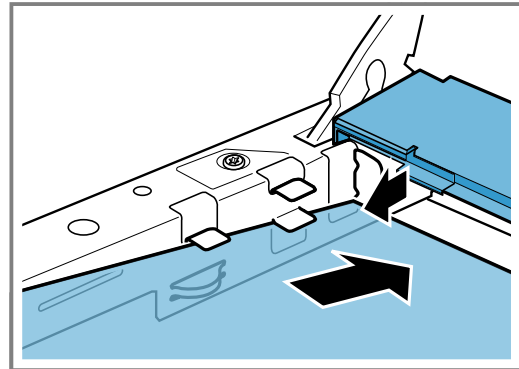

2. Insert the middle pane with no. 2 inwards.

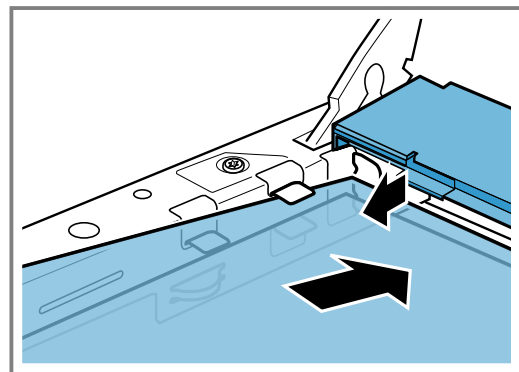

3. Fit the retaining clips onto the right- and left-hand side of the pane, aligning them so that the springs are over the screw holes. Screw the retaining clips in place.

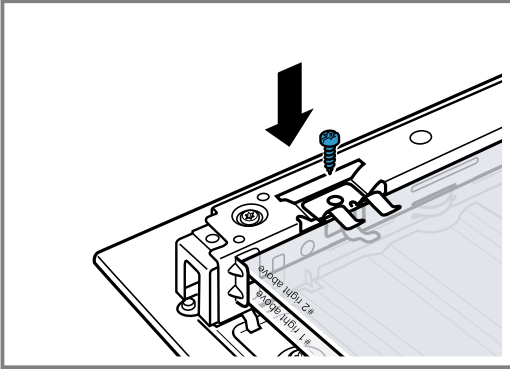

4. Insert the seal below the pane.

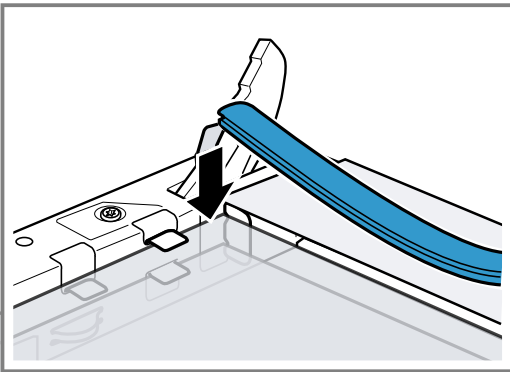

5. Hold the top pane in both brackets and insert it at an angle towards the back.

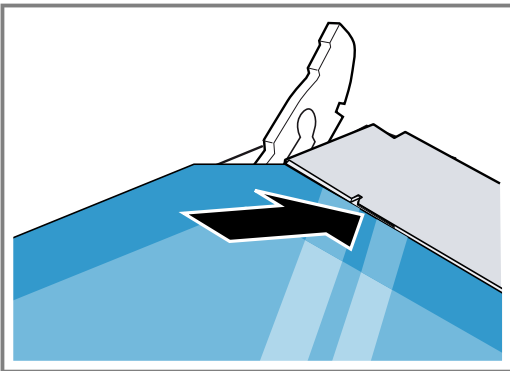

- Ensure that the seal does not slip backwards.
6. Fit the two small seals on the left and right of the pane again.

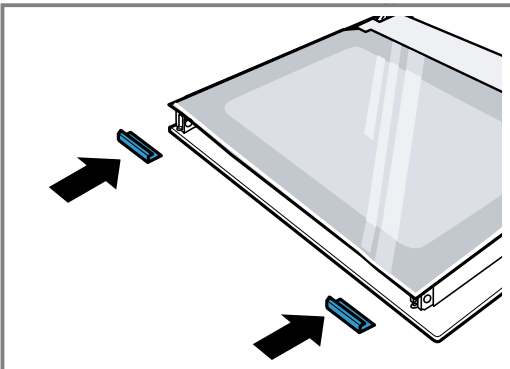

7. Put the cover back in place and screw it on.
8. Attach the oven door.
→ "Attaching the appliance door", Page 38

Note: Only use the oven once the glass panes have been correctly fitted.

32.5 Attaching the appliance door

Reattach the oven door in the reverse sequence to removal.

⚠ WARNING – Risk of injury!

The oven door might accidentally fall or a hinge may suddenly snap shut.

- ▶ In this case, do not hold onto the hinge. Call customer service.

1. When attaching the oven door, ensure that both hinges are inserted in the opening direction.

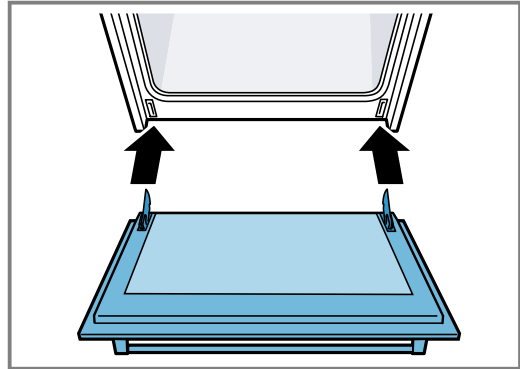

2. The notch on the hinge must engage on both sides.

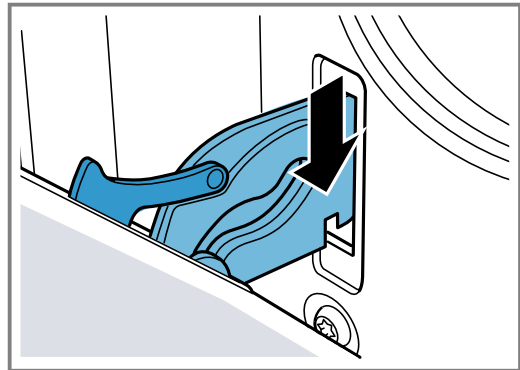

3. Close both locking levers again.

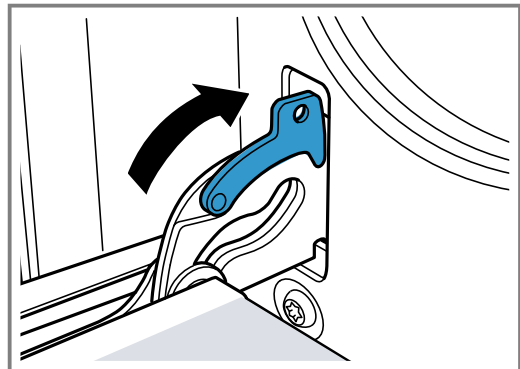

4. Close the appliance door.

32.6 Additional door safety

Additional safety devices have been fitted to prevent contact with the oven doors. Always attach these safety devices when children could come near the oven. You can purchase this special accessory from after-sales service. 11023590

WARNING – Risk of burns!

During long cooking times, the oven door may become very hot.

- ▶ Supervise small children when the oven is in operation.

33 FAQs

33.1 Using the appliance

Question	Answer
Why can I not switch on the hob and why is the childproof lock symbol lit?	<ul style="list-style-type: none"> ▪ The childproof lock is activated. You can find further information about this function under → "<i>Childproof lock</i>", Page 22.
Why are the illuminated displays flashing and why is a signal sounding?	<ul style="list-style-type: none"> ▪ Clean the surface of the control panel of any liquids or food residue. Remove any objects that may cover the control panel. You can find further information about deactivating the signal tone under → "<i>Basic settings</i>", Page 22.

33.2 Noises

Question	Answer
Why can I hear noises while I'm cooking?	<ul style="list-style-type: none"> ▪ Noises may be generated while using the hob depending on the base material of the cookware. These noises are normal for induction technology. They do not indicate that there is a fault.
Possible noises	<ul style="list-style-type: none"> ▪ A deep humming noise similar to a transformer: Occurs when cooking at a high power level. This noise disappears or becomes quieter when you reduce the power level. ▪ A quiet whistling noise: This can be heard when the cookware is empty. This noise disappears when you add water or food to the cookware. ▪ Crackling: This noise occurs when the cookware is made from different multilayer materials, or if you use cookware of different sizes and different materials. The loudness of the noise can vary depending on the quantity of food being cooked or the cooking method. ▪ Loud whistling noises: These may arise if you are operating two cooking zones at the same time and at the maximum power level. These whistling noises disappear or become quieter when you reduce the power level. ▪ Fan noises: The hob is equipped with a fan that switches on automatically at high temperatures. The fan may also continue to run after you have switched the hob off if the temperature measured is still too high. ▪ Steady tones, similar to the ticking of a clock: This noise only occurs if three or more cooking zones are switched on. The noise disappears or becomes quieter when you switch off one of the cooking zones. ▪ Steady tones, similar to the ticking of a clock: This noise only occurs if three or more cooking zones are switched on, or if you are using another cooking zone in addition to the combined cooking zone. The noise disappears or becomes quieter when you switch off one of the cooking zones.

33.3 Items of cookware

Question	Answer
Which cookware is suitable for the induction hob?	<ul style="list-style-type: none"> ▪ You can find more information on which items of cookware are compatible with induction cooking in → "<i>Induction cooking</i>", Page 9.

Question	Answer
Why is the cooking zone not heating up and why is the heat setting flashing?	<ul style="list-style-type: none"> ■ The cookware is on a different cooking zone to the one that has been switched on. Ensure that you have switched on the correct cooking zone for the cookware. ■ The cookware is too small for the cooking zone that is switched on or it is not suitable for induction cooking. Ensure that the cookware is suitable for induction cooking and that it is placed on the cooking zone which best corresponds to its size. You can find more information about this under → "Induction cooking", Page 9 → "CombiZone", Page 19.
Why is it taking so long for the cookware to heat up or why is it not heating up sufficiently despite being on a high power setting?	<ul style="list-style-type: none"> ■ The cookware is too small for the cooking zone that is switched on or it is not suitable for induction cooking. Ensure that the cookware is suitable for induction cooking and that it is placed on the cooking zone which best corresponds to its size. You can find more information about this under → "Induction cooking", Page 9 → "CombiZone", Page 19.

33.4 Cleaning

Question	Answer
How can I clean the hob?	<ul style="list-style-type: none"> ■ You can achieve the best results by using special glass-ceramic cleaning products. Do not use harsh or abrasive cleaning products, dishwasher detergent (concentrated) or scouring pads. You can find more information about this under → "Cleaning and servicing", Page 31.

34 Troubleshooting

You can rectify minor faults on your appliance yourself. Read the troubleshooting information before contacting after-sales service. This will avoid unnecessary costs.

WARNING – Risk of injury!

Improper repairs are dangerous.

- ▶ Repairs to the appliance should only be carried out by trained specialist staff.
- ▶ If the appliance is defective, call Customer Service.

WARNING – Risk of electric shock!

Incorrect repairs are dangerous.

- ▶ Repairs to the appliance should only be carried out by trained specialist staff.

- ▶ Only use genuine spare parts when repairing the appliance.
- ▶ If the power cord of this appliance is damaged, it must be replaced by the manufacturer, the manufacturer's Customer Service or a similarly qualified person in order to prevent any risk.













WARNING – Risk of fire!

The hob switches off automatically and can no longer be operated. It may switch on unintentionally at a later point.

- ▶ Switch off the fuse in the fuse box.
- ▶ Call the customer service.

34.1 Malfunctions

Fault	Cause and troubleshooting
The appliance is not working.	The mains plug of the power cord is not plugged in. ▶ Connect the appliance to the power supply.
	The circuit breaker is faulty. ▶ Check the circuit breaker in the fuse box.
	There has been a power cut. ▶ Check whether the lighting in your kitchen or other appliances are working.

Fault	Cause and troubleshooting
Appliance is not heating, the colon flashes in the display and a  appears.	Demo mode is activated. <ol style="list-style-type: none"> Briefly disconnect the appliance from the power supply by switching the circuit breaker in the fuse box off and then on again. Deactivate demo mode within 5 minutes by changing the last basic setting (depending on the appliance type <i>c 13</i> or <i>c 14</i>) to . → "Basic settings", Page 22
The appliance door cannot be opened and  lights up in the display.	The childproof lock locks the appliance door. <ul style="list-style-type: none"> Use  to deactivate childproof lock. → "Childproof lock", Page 30
The appliance door cannot be opened and  lights up in the display.	The cleaning function locks the appliance door. <ul style="list-style-type: none"> Allow the appliance to cool down until  goes out in the display. → "Pyrolysis", Page 33
The time flashes in the display.	There has been a power cut. <ul style="list-style-type: none"> Reset the time. → "Setting the time", Page 26
The time does not appear in the display when the appliance is switched off.	The basic setting has been changed. <ul style="list-style-type: none"> Change the basic setting for the time display. → "Basic settings", Page 22
 lights up in the display and no settings can be made on the appliance.	Childproof lock is activated. <ul style="list-style-type: none"> Use the  button to deactivate the childproof lock.
 flashes in the display and the appliance does not start.	The cooking compartment is too hot for the selected operation. <ol style="list-style-type: none"> Switch off the machine and allow it to cool. Restart the operation.
 appears in the display.	The maximum cooking time has been reached. To prevent an unwanted permanent operation, the appliance automatically stops heating after several hours if the settings are unchanged. <ul style="list-style-type: none"> Switch off the appliance. Implement new settings, if required. <p>Tip: To prevent the appliance from switching off when you do not want it to, e.g. for an extremely long preparation time, set a cooking time. → "Time-setting options", Page 25</p>
A message with  appears in the display, e.g. <i>E05-32</i> .	Electronics fault <ol style="list-style-type: none"> Press . <ul style="list-style-type: none"> If necessary, reset the time on the clock. If the fault was a one-off, the error message disappears. If the error message appears again, call the after-sales service. State the exact error message and the E no. for your appliance in full. → "Customer Service", Page 43

34.2 Information on the display panel

Fault	Cause and troubleshooting
No displays light up.	The power supply has been disconnected. <ul style="list-style-type: none"> Use other electrical appliances to check whether there has been a power failure. The appliance has not been connected as shown in the circuit diagram. <ul style="list-style-type: none"> Connect the appliance in accordance with the circuit diagram.
	Electronics fault <ul style="list-style-type: none"> If you are unable to rectify the fault, inform the technical after-sales service.
The displays flash.	The control panel is wet or an object is covering it. <ul style="list-style-type: none"> Dry the control panel or remove the object.

Fault	Cause and troubleshooting
The "-" display flashes in the cooking zone displays.	A fault has occurred in the electronics. ▶ To acknowledge the fault, briefly cover the control panel with your hand.
<i>F2, F4</i>	The electronics have overheated and one or all of the cooking zones have been switched off. ▶ Wait until the electronics have cooled down sufficiently. Then touch any button on the control panel.
<i>F2, F4, E 7015</i>	The electronics have overheated and one or all of the cooking zones have been switched off. ▶ Wait until the electronics have cooled down sufficiently. Then touch any button on the control panel.
<i>F5</i> + power level and audible signal	There is hot cookware in the vicinity of the control panel. This may cause the electronics to overheat. ▶ Remove the cookware. The fault display goes out shortly afterwards. You can continue to cook.
<i>F5</i> and signal tone	There is hot cookware in the vicinity of the control panel. The cooking zone has been switched off to protect the electronics. ▶ Remove the cookware. Wait a few seconds. Touch any button. When the fault display goes out, you can continue cooking.
<i>F1/F6</i>	The cooking zone has overheated and has been switched off to protect the work surface. ▶ Wait until the electronics have cooled down sufficiently before switching the cooking zone back on.
<i>F8</i>	The cooking zone has been operating continuously for an extended period. ▶ The automatic safety switch-off function has been activated. Touch any symbol to switch off the display so that you can set the cooking zone again.
<i>E 9000/E9010</i>	The operating voltage is incorrect and outside of the normal operating range. ▶ Contact your energy supplier.

34.3 Warnings

Notes

- If *E* appears in the displays, press and hold the sensor for the respective cooking zone and read the fault code.
- If the fault code is not listed in the table, disconnect the hob from the power supply and wait 30 seconds before reconnecting it. If this display appears again, contact the technical after-sales service and specify the exact fault code.
- If an error occurs, the appliance does not switch to standby mode.
- In order to protect the appliance's electronic parts from overheating or surge currents, the hob may temporarily reduce the power level.

34.4 Normal noises from your appliance

An induction hob may sometimes cause noises or vibrations, such as buzzing, crackling, hissing noises, fan noises or rhythmic noises.

34.5 Replacing the oven light bulb

If the light in the cooking compartment fails, change the oven light bulb.

Note: Heat-resistant, 25-watt, 230 V halogen bulbs are available from the after-sales service or specialist retailers. Only use these bulbs. Hold the new halogen bulbs only with a clean, dry towel. This increases the service life of the bulb.

WARNING – Risk of burns!

The appliance and its parts that can be touched become hot during use.

- ▶ Caution should be exercised here in order to avoid touching heating elements.
- ▶ Young children under 8 years of age must be kept away from the appliance.

WARNING – Risk of electric shock!

When changing the bulb, the bulb socket contacts are live.

- ▶ Before replacing the bulb, ensure that the appliance is switched off in order to prevent a potential electric shock.
- ▶ Also unplug the appliance from the mains or switch off the circuit breaker in the fuse box.

Requirements

- The appliance is disconnected from the power supply.
 - The cooking compartment has cooled down.
 - You have a new halogen bulb to replace the old one.
1. Place a tea towel in the cooking compartment to prevent damage.
 2. Remove the glass cover. To do this, press the metal tabs to the side with your thumb (image A).

3. Pull out the halogen bulb without turning it.

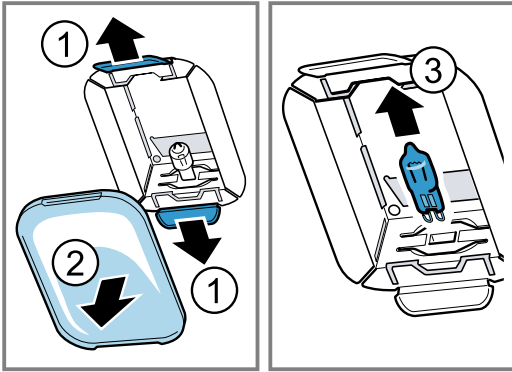

4. Insert the new halogen bulb and press it firmly into the socket.
Make sure the pins are positioned correctly.
5. Depending on the appliance model, the glass cover may have a sealing ring. Attach the sealing ring.
6. Screw in the glass cover. When doing this, insert it on one side and press firmly on the other side.
✓ The glass cover clicks into place.
7. Remove the tea towel from the cooking compartment.
8. Connect the appliance to the power supply.

35 Transportation and disposal

You can find out here how to prepare your appliance for transportation. You will also find out how to dispose of old appliances.

35.1 Disposing of old appliance

Valuable raw materials can be reused by recycling.

- ▶ Dispose of the appliance in an environmentally friendly manner.
Information about current disposal methods are available from your specialist dealer or local authority.



This appliance is labelled in accordance with European Directive 2012/19/EU concerning used electrical and electronic appliances (waste electrical and electronic equipment - WEEE).

The guideline determines the framework for the return and recycling of used appliances as applicable throughout the EU.

35.2 Transporting the appliance

Keep the original appliance packaging. Only transport the appliance in the original packaging. Observe the transport arrows on the packaging.

1. Secure all moving parts in and on the appliance using adhesive tape that can be removed without leaving any traces.
2. Slide all accessories, such as baking trays, into the corresponding slots with thin cardboard at the edges, in order to avoid damaging the appliance.
3. Place cardboard or similar between the front and rear side to prevent knocks against the inside of the door glass.
4. Secure the door and, if available, the top cover to the appliance sides using adhesive tape.

If the original packaging is no longer available

1. In order to guarantee sufficient protection against any transport damage, pack the appliance in protective packaging.
2. Always transport the appliance upright.
3. Do not hold the appliance by the door handle or the connections on the rear, as these could be damaged.
4. Do not place any heavy objects on the appliance.

36 Customer Service

If you have any queries on use, are unable to rectify faults on the appliance yourself or if your appliance needs to be repaired, contact Customer Service. Detailed information on the warranty period and terms of warranty in your country is available from our after-sales service, your retailer or on our website.

If you contact Customer Service, you will require the product number (E-Nr.) and the production number (FD) of your appliance.

The contact details for Customer Service can be found in the enclosed Customer Service directory or on our website.

This product contains light sources from energy efficiency class G.

36.1 Product number (E-Nr.) and production number (FD)

You can find the product number (E-Nr.) and the production number (FD) on the appliance's rating plate. You will see the rating plate with these numbers if you open the appliance door.

The product number (E no.) can also be found on the glass ceramic. You can also display the customer service index (KI) and the production number (FD) in the basic settings. → Page 22

Make a note of your appliance's details and the Customer Service telephone number to find them again quickly.

37 How it works

Here, you can find the ideal settings for various types of food as well as the best accessories and cookware. These recommendations are perfectly tailored to your appliance.

37.1 Proceed as follows:

Note:

If you are using the appliance for the first time, follow this important information:

- → "Safety", Page 3
- → "Saving energy", Page 8
- → "Preventing material damage", Page 7

1. Select a suitable type of food from the overview of food.

Notes

- Your appliance has programmed settings for a selection of food types. If you want to be guided by the appliance, use the automatic programmes.
 - If you do not find the exact food or application that you want to prepare or implement, look for a similar dish and take the general information into consideration.
2. Remove any accessories from the cooking compartment.
 3. Select suitable cookware and accessories. Use the cookware and the accessory listed in the recommended settings.
 4. Only preheat the appliance if the recipe or the recommended settings tell you to do so.
 5. Use the recommended settings when configuring the appliance settings.
 6. **⚠ WARNING – Risk of scalding!**
Hot steam may escape when you open the appliance door. Steam may not be visible, depending on the temperature.
 - ▶ Open the appliance door carefully.
 - ▶ Keep children at a safe distance.
 When the dish is ready, switch off the appliance.

37.2 Condensation

This section tells you how condensation is formed, how you can prevent damage, and how you can prevent condensation from forming.

When you are cooking food in the cooking compartment, a lot of steam may form in the cooking compartment. Since your appliance is extremely energy-efficient, only a small amount of heat escapes during operation. Due to the significant differences in temperature between the appliance interior and the external parts of the appliance, condensation may build up on the appliance door, the control panel or the front panels of adjacent kitchen cabinets. The formation of condensation is a normal physical phenomenon.

In order to prevent damage, wipe away the condensation.

When you preheat the appliance, you reduce the build-up of condensation.

37.3 Good to know

Observe this information when preparing food.

- The temperature and cooking time depend on the amount of food and the recipe. Settings ranges are specified for this reason. Select lower values first and, if required, select higher values the next time. Cooking times cannot be reduced by using higher temperatures. Doing this would mean that the food would only be cooked on the outside, and would not be fully cooked in the middle.
- The setting values apply to food placed in the cooking compartment while the cooking compartment is still cold. You can cut your energy use by up to 20%.

It is not usually necessary to preheat the appliance. If you would like to preheat the oven anyway, you can reduce the indicated baking times by a few minutes.

Preheating is required for some types of food. Do not place accessories into the cooking compartment until it has finished preheating.

- Remove any accessories that are not being used from the cooking compartment. This allows you to achieve optimal cooking results and save up to 20% in energy.
- Hot air gentle is an intelligent type of heating that allows you to gently cook meat, fish and baked items. The appliance optimally controls the supply of energy to the cooking compartment. The food is cooked in phases using residual heat. This means that the food remains more succulent and browns less. Depending on the preparation and food, you can save energy. If you preheat the appliance or open the appliance door before the food has finished cooking, you may not be able to achieve this result.
The hot air gentle type of heating is used to measure both the energy consumption in circulating-air mode and the energy efficiency class.
- Only use original accessories.
The original accessory has been tailored to the cooking compartment and the types of heating. Ensure that the accessory slides in the right way round.

Greaseproof paper

Only use greaseproof paper that is suitable for the selected temperature. Always cut the greaseproof paper to size.

⚠ WARNING – Risk of fire!

Opening the appliance door creates a draught. Greaseproof paper may come into contact with the heating element and catch fire.

- ▶ Never place greaseproof paper loosely over accessories when preheating the appliance and while cooking.
- ▶ Always cut greaseproof paper to size and use a plate or baking tin to hold it down.

37.4 Notes on baking

When baking, use the shelf positions indicated.



Baking on one level	Shelf position
Rising pasta/baked goods or tin on the wire rack	2
Flat pasta/baked items or in the baking tray	2–3
Baking on two or more levels	Shelf position
Universal pan	3
Baking tray	1
Baking tins on the wire rack:	Shelf position
First wire rack	3
Second wire rack	1
Baking on three levels	Shelf position
Baking trays	5
Universal pan	3
Baking trays	1

Notes

- When baking on several layers, use hot air. Different food that is placed in the oven at the same time will not necessarily be ready at the same time. In such cases, you can remove the cooked food and continue to cook the other baking tray. If necessary, you can change the position and direction of the baking trays.
- Position baking tins/dishes either next to one another or offset on different shelves so that they are not directly one above the other in the cooking compartment. You can cut energy use by cooking different items at the same time.
- For best results, we recommend using dark-coloured metal baking tins.

Recommended settings

Cakes in tins

Meal	Accessory/cookware	Shelf position	Type of heating	Temperature in °C	Cooking time, minutes
Sponge cake, simple	Vienna ring tin/loaf tin	2		160–180	50–60
Sponge cake, simple, 2 levels	Vienna ring tin/loaf tin	3+1		140–160	60–80
Sponge cake, delicate	Vienna ring tin/loaf tin	2		150–170	60–80
Sponge flan base	Flan base tin	3		160–180	30–40
Fruit tart or cheesecake with shortcrust pastry base	Springform cake tin, diameter 26 cm	2		160–180	70–90
Strudel	Tart dish or tin	1		200–240	25–50
Pie	Springform cake tin Ø 28 cm	2		160–180	25–35
Sponge cake	Bundt cake tin	2		150–170	60–80



37.5 Cakes and other baked goods

Recommended settings for cakes and baked items
The temperature and baking time depend on the quantity and consistency of the dough. This is why temperature ranges are given in the tables. Set a short cooking time first. If required, set a longer cooking time next time. A lower temperature results in more even browning.













Baking tips

We have compiled a few tips to help you achieve a good baking result.

Topic	Tip
You want your cake to rise evenly.	<ul style="list-style-type: none"> Only grease the base of the springform cake tin. After baking, use a knife to carefully loosen the cake from the baking tin.
You do not want small baked goods to stick to each other when baking.	Leave a minimum clearance of 2 cm around each item that is to be baked. This allows enough space for the baked goods to expand and brown on all sides.
Determine whether the cake is ready.	Push a cocktail stick into the highest point on the cake. If the cocktail stick comes out clean, the cake is ready.
You want to bake according to your own recipe.	Use similar items in the baking tables as a guide.
Use bakeware made of silicone, glass, plastic or ceramic.	<ul style="list-style-type: none"> The baking tin must be heat-resistant up to 250 °C. Cakes in these types of bakeware brown less.





Meal	Accessory/cookware	Shelf position	Type of heating	Temperature in °C	Cooking time, minutes
Sponge flan, 3 eggs	Springform cake tin, diameter 26 cm	2		160–170	30–40
Sponge flan, 6 eggs	Springform cake tin Ø 28 cm	2		160–170	35–45



Tray bakes

Meal	Accessory/cookware	Shelf position	Type of heating	Temperature in °C	Cooking time, minutes
Sponge cake with topping	Universal pan	3		160–180	20–45
Sponge cake, 2 levels	Universal pan + Baking tray	3+1		140–160	30–55
Shortcrust tart with dry topping	Universal pan	2		170–190	25–35
Shortcrust tart with dry topping, 2 levels	Universal pan + Baking tray	3+1		160–170	35–45
Shortcrust tart with moist topping	Universal pan	2		160–180	60–90
Yeast cake with dry topping	Universal pan	3		170–180	25–35
Yeast cake with dry topping, 2 levels	Universal pan + Baking tray	3+1		150–170	20–30
Yeast cake with moist topping	Universal pan	3		160–180	30–50
Yeast cake with moist topping, 2 levels	Universal pan + Baking tray	3+1		150–170	40–65
Plaited loaf, plaited ring	Universal pan	2		160–170	35–40
Swiss roll	Universal pan	2		170–190 ¹	15–20
Strudel, sweet	Universal pan	2		190–210	55–65
Strudel, frozen	Universal pan	3		180–200	35–45













¹ Preheat the appliance.

Small yeast cakes

Meal	Accessory/cookware	Shelf position	Type of heating	Temperature in °C	Cooking time, minutes
Muffins	Muffin tray on wire rack	2		170–190	20–40
Muffins, 2 levels	Muffin tray on wire rack	3+1		160–170	30–40
Small baked items	Universal pan	3		150–170	25–35
Viennese whirls, 2 levels	Universal pan + Baking tray	3+1		150–170	25–40
Puff pastry	Universal pan	3		180–200	20–30
Puff pastry, 2 levels	Universal pan + Baking tray	3+1		180–200	25–35
Puff pastry, 3 levels	2x Baking tray + Universal pan	5+3+1		170–190	30–45

Meal	Accessory/cookware	Shelf position	Type of heating	Temperature in °C	Cooking time, minutes
Choux pastry, e.g. profiteroles, eclairs	Universal pan	3		190-210	35-50
Choux pastry, 2 levels, e.g. profiteroles, eclairs	Universal pan + Baking tray	3+1		190-210	35-45

Biscuits

Meal	Accessory/cookware	Shelf position	Type of heating	Temperature in °C	Cooking time, minutes
Viennese whirls	Universal pan	3		140-150 ¹	30-40
Viennese whirls, 2 levels	Universal pan + Baking tray	3+1		140-150 ¹	30-45
Viennese whirls, 3 levels	2x Baking tray + Universal pan	5+3+1		130-140 ¹	40-55
Biscuits	Universal pan	3		140-160	20-30
Biscuits, 2 levels	Universal pan + Baking tray	3+1		130-150	25-35
Biscuits, 3 levels	2x Baking tray + Universal pan	5+3+1		130-150	30-40
Meringues	Universal pan	3		80-100	100-150
Meringues, 2 levels	Universal pan + Baking tray	3+1		90-100	100-150
Coconut macaroons	Universal pan	2		100-120	30-40
Coconut macaroons, 2 levels	Universal pan + Baking tray	3+1		100-120	35-45
Coconut macaroons, 3 levels	x 2 Baking tray + Universal pan	5+3+1		100-120	40-50
Viennese whirls	Universal pan	3		180-200	25-35

¹ Preheat the appliance for 5 minutes. For appliances with the rapid heating function, do not use this function for preheating.

Tips for next time you bake

If something goes wrong when baking, you can find some tips here.

Topic	Tip
Your cake collapses.	<ul style="list-style-type: none"> ▪ Note the ingredients and preparation instructions that are given in the recipe. ▪ Use less liquid. Or: ▪ Reduce the baking temperature by 10 °C and increase the baking time.

Topic	Tip
Your cake is too dry.	Increase the baking temperature by 10 °C and shorten the baking time.
Your cake is generally too light in colour.	<ul style="list-style-type: none"> ▪ Check the shelf position and accessory. ▪ Increase the baking temperature by 10 °C. Or: ▪ Increase the baking time.
Your cake is too light on top and too dark underneath.	Place the cake one level higher in the cooking compartment.

Topic	Tip
Your cake is too dark on top and too light underneath.	<ul style="list-style-type: none"> ▪ Place the cake one level lower in the cooking compartment. ▪ Reduce the baking temperature and increase the baking time.
Your cake is unevenly browned.	<ul style="list-style-type: none"> ▪ Reduce the baking temperature. ▪ Cut the greaseproof paper to a suitable size. ▪ Position the baking tin in the centre. ▪ Shape small baked goods to be the same size and thickness.

Topic	Tip
Your cake is cooked on the outside but is not fully baked through on the inside.	<ul style="list-style-type: none"> ▪ Reduce the baking temperature and increase the baking time. ▪ Add less liquid. <p>For cakes with a moist topping:</p> <ul style="list-style-type: none"> ▪ Pre-bake the base. ▪ Sprinkle the baked base with almonds or breadcrumbs. ▪ Place the topping on the base.
The cake will not come out of the tin when turned upside down.	<ul style="list-style-type: none"> ▪ Allow the cake to cool for 5–10 minutes after baking. ▪ Use a knife to carefully loosen the edge of the cake. ▪ Turn the cake tin upside down again and cover it several times with a cold, wet cloth. ▪ Next time you bake, grease the baking tin/dish and sprinkle it with breadcrumbs.

37.6 Bread and bread rolls

The values for bread dough apply to both dough placed on a tray and dough placed in a loaf tin.





ATTENTION!

When the cooking compartment is hot, any water inside it will create steam. The change in temperature may cause damage.

- ▶ Never pour water into the cooking compartment when it is still hot.
- ▶ Never place cookware containing water on the cooking compartment floor.

Recommended settings

Bread and bread rolls

Meal	Accessory/cookware	Shelf position	Type of heating	Temperature in °C	Cooking time, minutes
Bread, 750 g, in a loaf tin or free-form	Universal pan or Loaf tin	2		180–200	50–60
Bread, 1000 g, in a loaf tin or free-form	Universal pan or Loaf tin	2		200–220	35–50
Bread, 1500 g, in a loaf tin or free-form	Universal pan or Loaf tin	2		180–200	60–70
Flatbread	Universal pan	3		240–250	25–30

¹ The cooking process must take place on the appliance baking tray.

² Preheat the appliance.

Meal	Accessory/cookware	Shelf position	Type of heating	Temperature in °C	Cooking time, minutes
Flatbread, frozen ¹	Universal pan	2	☐	200–220 ²	10–25
Bread rolls, sweet, fresh	Universal pan	3	☐	170–180 ²	20–30
Bread rolls, sweet, fresh, 2 levels	Universal pan + Baking tray	3+1	☒	160–180 ²	15–25
Bread rolls, fresh	Universal pan	3	☐	200–220	20–30
Toast with topping, x 4	Wire rack	3	☐	200–220	15–20
Toast with topping, x 12	Wire rack	3	☐	220–240	15–25

¹ The cooking process must take place on the appliance baking tray.
² Preheat the appliance.

37.7 Pizza, quiche and savoury cakes

Here, you can find information about pizza, quiche and savoury cakes.

Recommended settings

Pizza, quiche and savoury cakes

Meal	Accessory/cookware	Shelf position	Type of heating	Temperature in °C	Cooking time, minutes
Pizza, fresh	Universal pan	3	☒	170–190	20–30
Pizza, fresh, 2 levels	Universal pan + Baking tray	3+1	☒	160–180	35–45
Pizza, fresh, thin-crust	Universal pan	2	☐	250–270 ¹	20–30
Pizza, chilled	Universal pan	1	☒	180–200 ¹	10–15
Pizza, frozen, thin-crust, x 1	Wire rack	2	☒	190–210	15–20
Pizza, frozen, thin base, x 2	Universal pan + Wire rack	3+1	☒	190–210	20–25
Pizza, frozen, deep-pan, x 1	Wire rack	3	☒	180–200	20–25
Pizza, frozen, deep-pan, x 2	Universal pan + Wire rack	3+1	☒	170–190	20–30
Mini pizzas, frozen	Universal pan	3	☒	190–210	10–20
Savoury bakes in a tin	Springform cake tin Ø 28 cm	2	☒	170–190	40–50
Quiche, flan	Tart dish or tin	2	☒	190–210	35–45
Pierogi	Ovenproof dish	2	☒	170–190	55–65
Empanadas	Universal pan	3	☒	180–190	35–45
Börek	Universal pan	3	☒	190–210	25–35

¹ Preheat the appliance.

37.8 Bakes and gratins

How well cooked the bake is will depend on the size of the ovenware and the thickness of the bake.

Use wide, shallow cookware for bakes and gratins. Food takes longer to cook in deep, narrow cookware and it browns more on top.

You can prepare food in baking tins or in the universal pan.

- Baking tins on the wire rack: Shelf position 2
- Universal pan: Shelf position 2

You can cut energy use by cooking different items at the same time. Position baking tins next to one another in the cooking compartment.

⚠ WARNING – Risk of injury!

If hot glass cookware is placed on a wet or cold surface, the glass may shatter.

- ▶ Place hot glass ovenware on a dry mat after cooking.

Recommended settings

Bakes and gratins

Meal	Accessory/cookware	Shelf position	Type of heating	Temperature in °C	Cooking time, minutes
Bake, savoury, fresh, cooked ingredients	Ovenproof dish	2	☐	200–220	30–60
Bake, sweet	Ovenproof dish	2	☐	180–200	50–60
Potato gratin, raw ingredients, 4 cm deep	Ovenproof dish	2	☑	150–170	60–80
Potato gratin, raw ingredients, 4 cm deep, on 2 levels	Ovenproof dish	3+1	☑	150–160	70–80

37.9 Poultry, meat and fish

The table lists values for poultry, meat and fish, with default values for the weight.

If you prepare dishes that are larger or heavier than what is specified in the recommended settings, always use the lower temperature. If cooking more than one item, use the weight of the heaviest item as a basis for determining the cooking time. The individual pieces must be approximately the same size.

Roasting and grilling on the wire rack

Roasting on the wire rack works particularly well for large poultry or for multiple pieces at the same time.

- Depending on the size and type of the food to be roasted, add up to 1/2 litre water to the universal pan.
You can make a sauce from the juices that are collected. This also means that less smoke is produced and the cooking compartment does not become as dirty.
- Keep the appliance door closed when using the grill.
Never grill with the appliance door open.
- Place the food to be grilled on the wire rack. In addition, slide the universal pan in at least one shelf position lower, with the slanted edge facing the appliance door. This means that any dripping fat is caught.

Roasting in cookware

If you cook food in cookware, you can remove it from the cooking compartment more easily and serve it directly in the cookware. If you cover the cookware when you cook your food, this will keep the cooking compartment cleaner.

General information about roasting in cookware

- Use heat-resistant, ovenproof cookware.
- Place the cookware onto the wire rack.
- Check in advance whether the cookware fits in the cooking compartment.
- Glass cookware is best.

- Shiny roasting dishes made from stainless steel or aluminium are not ideal. They reflect the heat like a mirror. The food cooks more slowly and does not brown as well. Increase the temperature accordingly and extend the cooking time.
- Follow the manufacturer's instructions for your roasting dishes.

Cookware without lid

- Use a deep roasting dish.
- Place the cookware onto the wire rack.
- If you do not have any suitable cookware, use the universal pan.

Cookware with lid

- Use a suitable lid that seals well.
- Place the cookware onto the wire rack.
- Meat, poultry and fish can also become crispy in a covered roasting dish. Use a roasting dish with a glass lid for this. Select a higher temperature.

⚠ WARNING – Risk of injury!

If hot glass cookware is placed on a wet or cold surface, the glass may shatter.

- ▶ Place hot glass ovenware on a dry mat after cooking.

⚠ WARNING – Risk of scalding!

Very hot steam may escape when the lid is opened after cooking. Steam may not be visible, depending on the temperature.

- ▶ Lift the lid in such a way that the hot steam can escape away from you.
- ▶ Keep children away from the appliance.

Notes on roasting and grilling

The setting values are based on the assumption that unstuffed, chilled, ready-to-roast poultry, meat or fish is placed into a cold cooking compartment.

- The larger the poultry, meat or fish, the lower the temperature and the longer the cooking time.
- Turn the poultry, meat or fish after approx. 1/2 to 2/3 of the time listed.

- Add a little liquid to the poultry in the cookware. Cover the base of the cookware with approx. 1–2 cm of liquid.
- When you turn poultry, ensure that the breast side or skin side is underneath to begin with.
- Use tongs to turn the pieces of food you are grilling. If you pierce the meat with a fork, the juices will run out and it will become dry.
- Only add salt to steaks once they have been grilled. Salt draws water from the meat.
- Set the cooking time (e.g. 20 + 35): For 500 g meat, calculate 20 minutes plus 35 minutes baking time with additional time. For 1.5 kg, the cooking time would therefore be 95 minutes.
- Cooking time range (e.g. 10–15): Your food will be ready within the specified range of time.

Tips for poultry, meat and fish

Observe the instructions when preparing poultry, meat and fish

Poultry

- For duck or goose, pierce the skin on the underside of the wings. This allows the fat to drain out.
- If using duck breast, score the skin. Do not turn duck breasts.
- Poultry will turn out particularly crispy and brown if you baste it towards the end of the roasting time with butter, salted water or orange juice.

Meat

- Coat lean meat with fat as required, or separate the pieces.
- When roasting, add a little liquid if the meat is lean. Cover the base of the glass cookware with approx. 1/2 cm of liquid.
- Score the rind crosswise. If you turn the joint when cooking it, ensure that the rind is underneath to begin with.
- When the joint is ready, turn off the oven and allow it to rest for a further 10 minutes in the cooking compartment, keeping the door closed. This helps distribute the meat juices more evenly. Wrap the joint in aluminium foil if necessary. The resting time is not included in the specified cooking time.
- It is more convenient to roast and braise meat in the cookware. You can take the joint out of the cooking compartment more easily in the cookware, and prepare the sauce in the cookware itself.
- The quantity of liquid depends on the type of meat, the material the cookware is made from and on whether or not a lid is used. If you are cooking meat in an enamelled or dark-coloured metal roasting dish, it will need a little more liquid than if cooked in glass cookware.
- The liquid in the cookware evaporates as the meat roasts. Carefully pour in more hot liquid if required.
- The distance between the meat and the lid must be at least 3 cm. The meat may expand.

- To braise the meat, sear it first as required. Add water, wine, vinegar or similar for the braising liquid. The base of the cookware must be covered with 1–2 cm of liquid.

Fish

- You do not need to turn whole fish.
- Place the whole fish into the cooking compartment in swimming position with the dorsal fin facing upwards.
- Placing half a potato or a small ovenproof container in the stomach cavity of the fish provides stability.
- You can tell when the fish is cooked because the dorsal fin can be removed easily.
- When stewing, add two to three tablespoons of liquid and a little lemon juice or vinegar into the cookware.











Tips for roasting and braising

Use these tips for good results when roasting and braising.















Topic	Tip
Lean meat must not dry out.	■ Coat lean meat with fat or oil as required or cover it with strips of bacon.
If you want to cook a joint with rind, proceed as follows:	<ul style="list-style-type: none"> ■ Score the rind in a criss-cross pattern. ■ Roast the joint with the rind facing down first.
Keep the cooking compartment as clean as possible.	<ul style="list-style-type: none"> ■ Cook the food in a covered roasting dish at a higher temperature. Or: ■ Use the grill tray. If required, the grill tray can be bought later as an optional accessory.
You want the meat (e.g. roast beef) to remain hot and succulent.	<ul style="list-style-type: none"> ■ When the roast is ready, switch off the oven and leave the meat to rest for 10 minutes in the cooking compartment with the door closed. This helps distribute the meat juices more evenly. The resting time is not included in the specified cooking time. ■ After preparing it, wrap the food in aluminium foil.

Recommended settings

Poultry

Food	Accessories/cook-ware	Shelf posi-tion	Type of heating	Temperature in °C/grill setting	Cooking time in mins
Chicken, 1.3 kg, unstuffed	Cookware without lid	2		200–220	60–70
Small chicken portions, 250 g each	Cookware without lid	3		220–230	30–35
Chicken goujons, nuggets, frozen	Universal pan	3		190–210	20–25
Duck, unstuffed, 2 kg	Cookware without lid	2		190–210	100–110
Duck breast, 300 g each, medium	Cookware without lid	3		240–260	30–40
Goose, unstuffed, 3 kg	Cookware without lid	2		170–190	120–140
Goose legs, 350 g each	Cookware without lid	3		220–240	40–50
Small turkey, 2.5 kg	Cookware without lid	2		180–200	80–100
Turkey breast, boned, 1 kg	Cookware with lid	2		240–260	80–100
Turkey thigh, on the bone, 1 kg	Cookware without lid	2		180–200	90–100

Meat

Food	Accessories/cook-ware	Shelf posi-tion	Type of heating	Temperature in °C/grill setting	Cooking time in mins
Joint of pork without rind, e.g. neck, 1.5 kg	Cookware without lid	1		180–200	140–160
Joint of pork with rind, e.g. shoulder, 2 kg	Cookware without lid	1		170–190	190–200
Pork tenderloin steak, 1.5 kg	Cookware with lid	2		190–210	130–140
Pork steaks, 2 cm thick	Wire rack	4		3	20–25 ¹
Fillet of beef, medium, 1 kg	Cookware without lid	3		210–220	45–55
Pot-roasted beef, 1.5 kg	Cookware with lid	2		200–220	100–120 ²
Sirloin, medium, 1.5 kg	Cookware without lid	2		200–220	60–70
Hamburger, 3–4 cm thick	Wire rack	4		3 ³	25–30 ¹
Joint of veal, 1.5 kg	Cookware without lid	2		180–200	120–140
Knuckle of veal, 1.5 kg	Cookware with lid	2		210–230	130–150
Leg of lamb, boned, medium, 1.5 kg	Cookware without lid	2		170–190	70–80 ⁴
Saddle of lamb on the bone, medium, 1.5 kg	Cookware without lid	2		180–190	45–55 ⁴
Grilled sausages	Wire rack	3		3	20–25 ¹
Meat loaf, 1 kg	Cookware without lid	2		170–180	70–80





¹ Slide the universal pan underneath the wire rack.

² At the start, add liquid to the cookware so that at least 2/3 of the joint is covered in liquid

³ Turn the dish 2/3 of the way through the cooking time.

⁴ Do not turn the food. Cover the base with water.

Fish

Food	Accessories/cook-ware	Shelf posi-tion	Type of heating	Temperature in °C/grill setting	Cooking time in mins
Fish, grilled, whole, 300 g, e.g. trout	Wire rack	2		2	20–25 ¹
Fish, grilled, whole, 1 kg, e.g. gilthead	Wire rack	2		180–200	45–50 ¹
Fish, grilled, whole, 1.5 kg, e.g. salmon	Wire rack	2		170–190	50–60 ¹
Fish fillet/fish cutlet, 2–3 cm thick, grilled	Wire rack	3		2	20–25 ¹

¹ Slide the universal pan underneath the wire rack.

Tips for next time you roast

If roasting is not successful the first time, you can find some tips here.

Topic	Tip
The roast is too dark and the crackling is partly burnt.	<ul style="list-style-type: none"> ▪ Select a lower temperature. ▪ Reduce the roasting time.
Your roast is too dry.	<ul style="list-style-type: none"> ▪ Select a lower temperature. ▪ Reduce the roasting time.
The crackling on your roast is too thin.	<ul style="list-style-type: none"> ▪ Increase the temperature. Or: ▪ Switch on the grill briefly at the end of the roasting time.

Topic	Tip
Your roasting juices are burnt.	<ul style="list-style-type: none"> ▪ Select a smaller item of cookware. ▪ When roasting, add more liquid.
Your roasting juices are too clear and watery.	<ul style="list-style-type: none"> ▪ Use a larger item of cookware so that more liquid evaporates. ▪ When roasting, add less liquid.
The meat is burned slightly during braising.	<ul style="list-style-type: none"> ▪ Check whether the roasting dish and lid fit together and close properly. ▪ Reduce the temperature. ▪ Add liquid when braising.

37.10 Vegetables and side dishes

This is where you can find information about preparing vegetable products that you can use as a side dish for your meals.

Recommended settings

Vegetables and side dishes

Use the settings listed in the table.

Food	Accessories/cookware	Shelf position	Type of heating	Temperature in °C/grill setting	Cooking time in mins
Grilled vegetables	Universal pan	5		3	10–20
Baked potatoes, halved	Universal pan	3		190–210	25–35
Potato products, frozen, e.g. chips, croquettes, potato pockets, rösti	Universal pan	3		200–220	25–35
Chips, 2 levels	Universal pan + Baking tray	3+1		190–210	30–40

37.11 Yoghurt

You can also use your appliance to make your own yoghurt.

Making yoghurt

1. Remove the accessories and shelves from the cooking compartment.
2. Heat 1 litre of milk (3.5% fat) to 90 °C on the hob and then leave it to cool down to 40 °C. Only heat UHT milk to 40 °C.
3. Stir 30 g yoghurt into the milk.
4. Pour the mixture into small containers, e.g. small jars with lids.
5. Cover the containers with film, e.g. cling film.
6. Place the containers on the cooking compartment floor.
7. Use the recommended settings when configuring the appliance settings.
8. After making the yoghurt, leave it to cool in the refrigerator.

Recommended settings

Yoghurt

Meal	Accessory/cookware	Shelf position	Type of heating/function	Temperature in °C	Cooking time, minutes
Yoghurt	Cup/jar	Cooking compartment floor		-	4–5 hours

37.12 Tips for keeping acrylamide levels to a minimum when cooking

Acrylamide is harmful to your health and is produced when you cook cereal and potato products at very high temperatures.



Meal	Tip
General information	<ul style="list-style-type: none"> ▪ Keep cooking times as short as possible. ▪ Cook food until it is golden brown, but not too dark. ▪ Use large, thick pieces of food. These contain less acrylamide.
Baking	<ul style="list-style-type: none"> ▪ Set max. top/bottom heating to 200 °C. ▪ Set the temperature in hot air mode to max. 180 °C.
Biscuits	<ul style="list-style-type: none"> ▪ Brush baked items and biscuits with egg or egg yolk. This reduces the production of acrylamide.
Oven chips	<ul style="list-style-type: none"> ▪ Spread the chips out evenly and in a single layer on the baking tray. ▪ Cook at least 400 g at once on a baking tray so that the chips do not dry out.

37.13 Slow cooking

Slow cooking is a technique for cooking food over a long period at low temperatures. For this reason, slow cooking is also called "low-temperature cooking". Slow cooking is ideal for all prime cuts, e.g. tender portions of beef, veal, pork, lamb or poultry, which are to be cooked "à point". The meat will remain succulent and tender.

Recommended settings

Slow cooking

Food	Accessories/cookware	Shelf position	Type of heating	Searing time in mins	Temperature in °C	Cooking time in mins
Duck breast, 300 g each	Cookware without lid	2		6–8	95 ¹	60–70
Chicken breast fillet, 200 g each, well done	Cookware without lid	2		4	120 ¹	80–110

¹ Preheat the appliance.

Note: Slow-cooking allows lots of scope for menu planning because slow-cooked meat is easy to keep warm. You do not have to turn the meat when cooking.

Slow cooking food

1. Only use fresh, clean and hygienic meat without bones.
 - Do not use defrosted meat.
 - Since fat develops a strong, distinct taste during slow cooking, carefully remove the sinews and fatty edges.
 - You can use seasoned or marinated meat.
2. Place the cookware onto the wire rack at level 2 in the cooking compartment. Use shallow cookware, e.g. a serving dish made out of porcelain or glass.
3. Only start operation when the cooking compartment has fully cooled down.
4. Preheat the cooking compartment and cookware for approx. 15 minutes.
5. Sear the meat on all sides on the hob at a very high heat.
6. Immediately place the meat into the pre-warmed cookware in the cooking compartment.
7. Keep the appliance door closed in order to maintain an even cooking climate.
8. After slow cooking, remove the meat from the cooking compartment. You can cut the meat immediately. No standing time is required. Due to the special cooking method, the meat looks pink, i.e. medium rare. The colour does not mean that the meat is raw or not sufficiently cooked.

Notes

- When using the slow cooking function, you cannot delay the start of the programme by setting an end time.
- The slow cooking temperature and cooking time are dependent on the size, thickness and quality of the meat. Settings ranges are specified for this reason.

Food	Accessories/cook-ware	Shelf position	Type of heating	Searing time in mins	Temperature in °C	Cooking time in mins
Turkey breast, boned, 6.5–8.5 cm thick, 1 kg, well done	Cookware without lid	2		6–8	120 ¹	140–180
Pork tenderloin steak, 5–6 cm thick, 1.5 kg, well done	Cookware without lid	2		6–8	85 ¹	150–210
Fillet of pork, whole	Cookware without lid	2		4–6	85 ¹	75–100
Beef topside, 6–7 cm thick, 1.5 kg	Cookware without lid	2		6–8	100 ¹	160–220
Fillet of beef, 4–6 cm thick, 1 kg	Cookware without lid	2		6–8	85 ¹	90–150
Sirloin, 5–6 cm thick, 1.5 kg	Cookware without lid	2		6–8	85 ¹	150–210
Beef medallions/rump steak, 4 cm thick	Cookware without lid	2		4	80 ¹	50–90
Flank of veal, 7–10 cm thick, 1.5 kg	Cookware without lid	2		6–8	85 ¹	250–310
Fillet of veal, whole	Cookware without lid	2		4–6	85 ¹	100–160
Veal medallions, 4 cm thick	Cookware without lid	2		4	80 ¹	50–70
Saddle of lamb, boneless, 200 g each	Cookware without lid	2		4	85 ¹	30–70
Leg of lamb, boned, 1 kg, tied	Cookware without lid	2		6–8	95 ¹	100–160

¹ Preheat the appliance.

Tips for slow cooking

Here you will find tips for achieving good results when slow cooking food.

Topic	Measure
If you want to slow cook a duck breast, proceed as follows:	<ul style="list-style-type: none"> ■ Place the cold duck breast into a cold pan. ■ Sear the skin side first. ■ Slow cook the duck breast. ■ After slow cooking, grill for 3 to 5 minutes until crispy.
If you want to serve your slow-cooked meat as hot as possible, proceed as follows:	<ul style="list-style-type: none"> ■ Preheat the serving plate. ■ Make sure that the accompanying sauces are very hot when you serve them.

37.14 Drying

You can achieve outstanding drying results for the food using hot air. With this type of preserving, flavours are concentrated as a result of the dehydration.

The temperature and drying time depend on the type, moistness, ripeness and thickness of the food. The longer you leave the food to be dried, the better it will

be preserved. The thinner you cut the slices, the quicker the drying process will be and the more flavour the dried food will retain. Settings ranges are specified for this reason.

Preparation for drying

1. Only use unblemished, fresh fruit, vegetables and herbs and wash them thoroughly. Line the wire rack with greaseproof paper or parchment paper. Drain the excess water from the fruit and then dry it.
2. If required, cut the fruit into thin pieces or slices of equal size. Place unpeeled fruit onto the dish with the sliced surfaces facing upwards. Ensure that neither fruit nor mushrooms overlap on the wire rack.
3. Grate vegetables and then blanch them. Drain the excess water from the blanched vegetables and spread them evenly on the wire rack.
4. Dry herbs on the stem. Spread the herbs out evenly and slightly heaped on the wire rack.
5. Turn very juicy fruit and vegetables several times. After drying, remove the dried fruit and vegetables from the paper immediately.

Recommended settings





Drying

The table contains settings for drying various foodstuffs. If you want to dry food that is not listed in the table, you should use similar foodstuffs in the table as a reference.

Note:

Use the following shelf positions for drying:

- 1 wire rack: Shelf position 3
- 2 wire racks: Shelf positions 3 + 1

Meal	Accessory/cookware	Shelf position	Type of heating	Temperature in °C	Cooking time, minutes
Pome fruit, e.g. apple rings, 3 mm thick, 200 g per wire rack	Wire rack	3 3+1		80	4–8 hours
Root vegetables, e.g. carrots, grated, blanched	Wire rack	3 3+1		80	4–7 hours
Mushrooms, sliced	Wire rack	3 3+1		80	5–8 hours
Herbs, stalks removed	Wire rack	3 3+1		60	2-5 hours

37.15 Preserving food

You can preserve fruit and vegetables by heating them and sealing them in air-tight jars.

- Only use heat-resistant, clean, undamaged preserving jars, rubber seals and clips.
- Only use fruit and vegetables which are in perfect condition.
- Only use jars that are the same size and contain the same food.

WARNING – Risk of injury!

If the preserving process is not carried out correctly, the preserving jars may crack.

- ▶ Make sure that you use the specified setting values.
- ▶ Use clean and undamaged preserving jars.
- ▶ Place no more than six ½ litre or 1 litre jars of food in the oven at a time. Do not use jars that are larger than this.

Preparing fruit or vegetables for preserving

1. Thoroughly wash the fruit and vegetables.
2. Prepare the fruit and vegetables, e.g. peel, remove pips/stone and chop.
3. Fill the glass up to approx. 2 cm below the mouth.
4. Fill the jars with hot liquid.
 - For one-litre jars, approx. 400 ml of liquid is necessary.
 - For fruit: Skimmed sugar solution
 - Approx. 250 g sugar for sweet fruit
 - Approx. 500 g sugar for sour fruit
 - For vegetables:
 - Boiled water
5. Wipe the rims of the jars. They must be clean.

6. Place a damp rubber seal and a lid on each jar.
7. Seal the jars with the clips.

Preserving fruit or vegetables

1. Slide the universal pan into the cooking compartment at shelf position 2.
 2. Once they have been prepared, place the jars into the universal pan in such a way that they do not touch one another.
 3. Pour 500 ml hot water (approx. 80 °C) into the universal pan.
 4. Use the recommended setting values when configuring the appliance settings.
 - ✓ After approx. 40 to 50 minutes, small bubbles begin to form at short intervals. The jar contents "bubble".
 5. Fruit
 - Once all of the jars are bubbling, switch off the appliance.
 - Remove the jars from the cooking compartment after the specified residual heating time.
 6. Vegetables
 - Once all of the jars are bubbling, reduce the temperature to 120 °C.
 - Switch off the appliance after the specified residual heating time and remove the jars from the cooking compartment.
 7. **ATTENTION!**
 - If there are large temperature differences, the jars may shatter.
 - ▶ Do not place jars on cold or wet surfaces.
 - ▶ Protect the jars from draughts.
- Place the jars on a clean cloth and cover them.
8. Once the jars have cooled, remove the clips.

Recommended settings

Preserving food

The specified times in the table are average values for preserving fruit and vegetables. They may be influenced by room temperature, the number of jars, quantity, heat and quality of the jar contents. The specifications are based on 1-litre round jars.

Meal	Accessory/ cookware	Shelf position	Type of heating	Temperature in °C	Cooking time, minutes
Vegetables, beetroot:	1-litre preserving jars	2	<input type="checkbox"/>	1. 170–180 2. 120–140 3. -	1. Until bubbling starts 2. Once it starts bubbling: 35 3. Residual heat: 30
Vegetables, e.g. cucumbers	1-litre preserving jars	2	<input type="checkbox"/>	1. 170–180 2. -	1. Until bubbling starts 2. Residual heat: 35
Vegetables, e.g. Brussels sprouts	1-litre preserving jars	2	<input type="checkbox"/>	1. 170–180 2. 120–140 3. -	1. Until bubbling starts 2. Once it starts bubbling: 45 3. Residual heat: 30
Vegetables, e.g. beans, kohlrabi, red cabbage	1-litre preserving jars	2	<input type="checkbox"/>	1. 170–180 2. 120–140 3. -	1. Until bubbling starts 2. Once it starts bubbling: 60 3. Residual heat: 30
Vegetables, e.g. peas	1-litre preserving jars	2	<input type="checkbox"/>	1. 170–180 2. 120–140 3. -	1. Until bubbling starts 2. Once it starts bubbling: 70 3. Residual heat: 30
Stone fruit, e.g. cherries, apricot, peach, grapes, gooseberries, damsons	1-litre preserving jars	2	<input type="checkbox"/>	1. 170–180 2. -	1. Until bubbling starts 2. Residual heat: 30
Pomes, e.g. apples, strawberries, gooseberries	1-litre preserving jars	2	<input type="checkbox"/>	1. 170–180 2. -	1. Until it starts bubbling: 30–40 2. Residual heat: 25
Pureed fruit, e.g. apples, pears and plums	1-litre preserving jars	2	<input type="checkbox"/>	1. 170–180 2. -	1. Until it starts bubbling: 30–40 2. Residual heat: 35

37.16 Proving dough

You can prove yeast dough more quickly in your appliance than at room temperature.

Proving dough

Always allow yeast dough to prove in two steps: Once in its entirety (dough fermentation) and a second time in the baking tin (final fermentation).

1. Place the dough into a heat-resistant bowl.
2. Place the bowl on the wire rack.





3. Use the recommended settings when configuring the appliance settings.
Only start operation when the cooking compartment has fully cooled down.
4. Do not open the appliance door while the dough is proving, otherwise moisture will escape.
5. Continue processing the dough and mould it into the final shape for baking.
6. Place the dough into the cooking compartment at the specified shelf position.

Tip: If you want to preheat the oven, do not carry out the final proving stage in the appliance.

Recommended settings

Proving dough

The temperature and time are dependent on the type and quantity of the ingredients. The values in the table are therefore guide values only.

Meal	Accessory/cookware	Shelf position	Type of heating	Temperature in °C	Cooking time, minutes
Yeast dough, light	1. Bowl	1. 2	1. 	1. 50 ¹	1. 25–30
	2. Universal pan	2. 2	2. 	2. 50 ¹	2. 10–20
Yeast dough, heavy and rich	1. Bowl	1. 2	1. 	1. 50 ¹	1. 60–75
	2. Universal pan	2. 2	2. 	2. 50 ¹	2. 45–60

¹ Preheat the appliance for 5 minutes.

37.17 Defrosting

For defrosting frozen fruit, vegetables and baked items. Poultry, meat and fish should ideally be defrosted in the refrigerator. Not suitable for cream cakes or cream gateaux.

When defrosting food, use the following shelf positions:

- 1 wire rack: Shelf position 2
- 2 wire racks: Shelf positions 3+1

Note: Food that is frozen in thin layers or small portions defrosts more quickly than food frozen in larger blocks.

- Take the food out of its packaging and place in a suitable dish on the wire rack.
- Redistribute the food or turn it once or twice as it defrosts. Turn large pieces of food several times. As the food defrosts, break up any clumps and remove items that have already defrosted from the appliance.
- To allow the temperature to equalise, leave the defrosted food to rest for another 10 to 30 minutes in the appliance after switching it off.

Recommended settings

Defrosting

Meal	Accessory/cookware	Shelf position	Type of heating	Temperature in °C	Cooking time, minutes
Baked items, cake and bread, fruit, vegetables, meat products	Wire rack	2 3+1		-	-

37.18 Keeping warm

You can keep cooked dishes warm using the "Keeping warm" type of heating. This prevents condensation from forming and you will not have to wipe down the cooking compartment.

Do not keep cooked dishes warm for longer than two hours. Be aware that some dishes may continue cooking whilst being kept warm. Cover the dishes if necessary.

37.19 Test dishes

These overviews have been produced for test institutes to facilitate appliance testing in accordance with EN 60350-1.

Baking

Please take note of the following information if you are baking test dishes.

General information

- The setting values apply to food placed in the cooking compartment while the cooking compartment is still cold.

- Observe the notes about preheating in the tables. These setting values assume that the rapid heating function is not being used.
- When baking, use the lower of the listed temperatures to begin with.

Shelf positions

Shelf positions for baking on one level:

- Universal pan/baking tray: Shelf position 3
- Baking tins on the wire rack: Shelf position 2

Note: Items that are placed in the oven on baking trays or in baking tins/dishes at the same time will not necessarily be ready at the same time.

Shelf positions for baking on two levels:

- Universal pan: Shelf position 3
Baking tray: Shelf position 1
- Baking tins on the wire rack:
First wire rack: Shelf position 3
Second wire rack: Shelf position 1

Shelf positions for baking on three levels:

- Baking tray: Shelf position 5
Universal pan: Shelf position 3
Baking tray: Shelf position 1

Baking with two springform cake tins:

If you can use your appliance to cook on multiple levels, position baking tins either next to one another or offset on different shelves so that they are not directly one above the other in the cooking compartment.

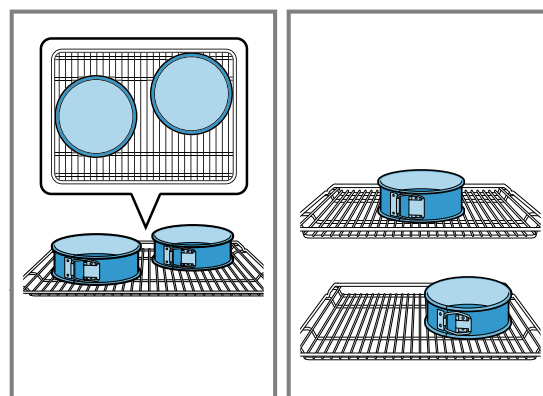

Recommended settings

Baking

Meal	Accessory/cookware	Shelf position	Type of heating	Temperature in °C	Cooking time, minutes
Viennese whirls	Universal pan	3	☐	140–150	30–40
Viennese whirls	Universal pan	3	☼	140–150	30–40
Viennese whirls, 2 levels	Universal pan + Baking tray	3+1	☼	140–150 ¹	30–45
Viennese whirls, 3 levels	2x Baking tray + Universal pan	5+3+1	☼	130–140 ¹	40–55
Small cakes	Universal pan	3	☐	150 ¹	25–35
Small cakes	Universal pan	3	☼	150 ¹	25–35
Small cakes, 2 levels	Universal pan + Baking tray	3+1	☼	150 ¹	25–35
Small cakes, 3 levels	2x Baking tray + Universal pan	5+3+1	☼	140 ¹	35–45
Hot water sponge cake	Springform cake tin, diameter 26 cm	2	☐	160–170 ²	30–40
Hot water sponge cake	Springform cake tin, diameter 26 cm	2	☼	170	30–40
Hot water sponge cake, 2 levels	Springform cake tin, diameter 26 cm	3+1	☼	150–160 ²	30–45

¹ Preheat the appliance for 5 minutes. For appliances with the rapid heating function, do not use this function for preheating.

² Preheat the appliance. For appliances with the rapid heating function, do not use this function for preheating.

Grilling

Food	Accessories/cookware	Shelf position	Type of heating	Temperature in °C/grill setting	Cooking time in mins
Toasting bread	Wire rack	5	☐	3	0.2–1.5



Thank you for buying a Bosch Home Appliance!

Register your new device on MyBosch now and profit directly from:

- **Expert tips & tricks for your appliance**
- **Warranty extension options**
- **Discounts for accessories & spare-parts**
- **Digital manual and all appliance data at hand**
- **Easy access to Bosch Home Appliances Service**

Free and easy registration – also on mobile phones:

www.bosch-home.com/welcome

BOSCH
HOME APPLIANCES
SERVICE

Looking for help? You'll find it here.

Expert advice for your Bosch home appliances, help with problems or a repair from Bosch experts.

Find out everything about the many ways Bosch can support you:

www.bosch-home.com/service

Contact data of all countries are listed in the attached service directory.

BSH Hausgeräte GmbH

Carl-Wery-Straße 34
81739 München, GERMANY
www.bosch-home.com

A Bosch Company



9001639663 (020208)

en