



REPAIR HINTS

[bg]	Съвети за ремонт	2
[hr]	Savjeti za popravak	17
[cs]	Poznámky k opravě	32
[da]	Tip til reparation	47
[nl]	Reparatie informatie	62
[en]	Repair hints	77
[et]	Remonditeave	92
[fi]	Korjausvinkit	107
[fr]	Conseils de réparation	122
[de]	Reparatur Hinweise	137
[el]	Υποδείξεις επισκευής	152
[hu]	Javítási útmutató	167
[it]	Consigli di riparazione	182
[lv]	Informācija par remontu	197
[lt]	Informacija apie remontą	212
[no]	Reparasjonstips	227
[pl]	Wskazówki naprawy	242
[pt]	Dicas de resolução	257
[ro]	Indicii pentru reparații	272
[sk]	Poznámky k opravám	287
[sl]	Nasveti za popravilo	302
[es]	Consejos de reparación	317
[sv]	Reparationsinformation	332
[tr]	Onarım İpuçları	347

Съвети за ремонт - Fridge-freezer

 Относно този документ	3
1.1 Важна информация.....	3
1.1.1 Цел.....	3
1.2 Обяснение на символите.....	3
1.2.1 Нива на опасност.....	3
1.2.2 Символи за опасност.....	3
1.2.3 Структура на предупрежденията.....	4
1.2.4 Общи символи.....	4
 Безопасност	5
2.1 Общи инструкции за безопасност.....	5
2.1.1 Всички домашни уреди.....	5
 Инструменти и помощни средства	6
 Ремонт	7
4.1 Смяна на уплътнителя на вратата.....	7
4.1.1 Сваляне на уплътнителя на вратата.....	7
4.1.2 Монтиране на уплътнителя на вратата.....	7
4.2 Смяна на дръжката на вратата.....	10
4.2.1 Изваждане на дръжката на вратата.....	10
4.2.2 Монтиране на дръжката на вратата.....	10
4.3 Смяна на рафта.....	11
4.3.1 Изваждане на рафта.....	11
4.3.2 Монтиране на рафта.....	11
4.4 Смяна на табличката за бутилки.....	12
4.4.1 Сваляне на табличката за бутилки.....	12
4.4.2 Монтиране на табличката за бутилки.....	12
4.5 Смяна на стелажа на вратата.....	13
4.5.1 Изваждане на стелажа на вратата.....	13
4.5.2 Монтиране на стелажа на вратата.....	13
4.6 Смяна на контейнерите.....	14
4.6.1 Изваждане на контейнерите.....	14
4.6.2 Монтиране на контейнерите.....	14
4.7 Смяна на LED лампата.....	15
4.7.1 Сваляне на LED лампата.....	15
4.7.2 Поставяне на LED лампата.....	16

i Относно този документ

1.1 Важна информация

1.1.1 Цел

Тези съвети за ремонт помагат на потребителя да ремонтира сам уреди в съответствие с регламента за екологосъобразно проектиране на уредите (от 03.2021 г.).

Те съдържат информация как да сменят определени резервни части, включително предупреждения и рискове.

Ако имате някакви въпроси, моля свържете се с нашия отдел за обслужване на клиенти. Ние носим отговорност за щети, само ако съветите за ремонт са спазени правилно.

1.2 Обяснение на символите

1.2.1 Нива на опасност

Предупредителните нива се състоят от символ и сигнална дума. Сигналната дума показва сериозността на опасността.





Ниво на предупреждение	Значение
 ОПАСНОСТ	Неспазването на предупредителното съобщение ще доведе до смърт или сериозни наранявания.
 ПРЕДУПРЕЖДЕНИЕ	Неспазването на предупредителното съобщение може да доведе до смърт или сериозни наранявания.
 ВНИМАТЕЛНО	Неспазването на предупредителното съобщение може да доведе до леки наранявания.
 ВНИМАНИЕ!	Неспазването на предупредителното съобщение може да доведе до имуществени щети.

Таблица 1: Нива на опасност

1.2.2 Символи за опасност

Символите за опасност са символични изображения, които дават индикация за вида опасност.

В този документ се използват следните символи за опасност:

Символ за опасност	Значение
	Общо предупредително съобщение
	Опасност от електрическо напрежение
	Риск от експлозия
	Опасност от порязвания

i Относно този документ





Символ за опасност	Значение
	Опасност от премазване
	Опасност от горещи повърхности
	Опасност от силно магнитно поле
	Опасност от нейонизиращо лъчение

Таблица 2: Символи за опасност

1.2.3 Структура на предупрежденията

Предупрежденията в този документ имат стандартизиран външен вид и стандартизирана структура.

	<p>ОПАСНОСТ</p> <p>Вид и източник на опасността! Възможни последици от игнориране на опасността/предупреждението.</p> <ul style="list-style-type: none"> ▶ Мерки и забрани за предотвратяване на опасността.
----------------------------------------------------------------------------------	--------------------------------------------------------------------------------------------------------------------------------------------------------------------------------------------------------------------------------------------------------

Следният пример показва предупреждение, което уведомява за токов удар, предизвикан от части под напрежение. Споменава се мярката за избягване на опасността.

	<p>ОПАСНОСТ</p> <p>Риск от токов удар поради части под напрежение! Смърт от токов удар</p> <ul style="list-style-type: none"> ▶ Изключете уредите от електрическото захранване поне 60 секунди преди започване на ремонта.
------------------------------------------------------------------------------------	----------------------------------------------------------------------------------------------------------------------------------------------------------------------------------------------------------------------------------------------------------------------

1.2.4 Общи символи

В този документ се използват следните общи символи:







Общ символ	Значение
	Идентифициране на специален съвет (текст и/или графика)
	Идентифициране на прост съвет (само текст)
	Идентифициране на връзка към видео урок
	Идентифициране на необходимите инструменти
	Идентифициране на необходимите предварителни условия
	Идентифициране на условие (ако ..., тогава ...)
	Идентифициране на резултат
Старт	Идентифициране на ключ или бутон
[00123456]	Идентифициране на каталожен номер
Статус	Идентифициране на показания текст/прозорец (на дисплея на уреда)

Таблица 3: Общи символи

2.1 Общи инструкции за безопасност

2.1.1 Всички домашни уреди

Риск от токов удар поради части под напрежение!

- Грешки при ремонти, включващи електрически компоненти, могат да доведат до токов удар!
- Разкачете уреда от електрическата мрежа за поне 60 секунди, преди да започнете работа.
- След ремонта трябва да се извърши проверка за безопасност съгласно VDE 0701 или в съответствие със специфичните за страната разпоредби.

Риск от нараняване от остри ръбове!

- Носете предпазни ръкавици.

Риск от премазване по време на ремонт, поддръжка, отстраняване на неизправности и сервиз поради тежки и движещи се компоненти

- Носете защитни обувки.
- Закрепете тежките компоненти, така че да не паднат.
- Не позволявайте контакт на части от тялото с движещи се компоненти.

Риск за безопасността/функцията на уреда!

- Използвайте само оригинални резервни части.

Риск от повреда на електростатично чувствителни компоненти (ESD)!

- Не докосвайте модулите, включително връзки и проводникови пътища.

Инструменти и помощни средства

посочване	Подробности	Изображения
Защитна кърпа [00342013]	60 см x 50 см	
Шестоъгълни гаечни ключове [00340819]	2 мм, 2,5 мм, 3 мм, 4 мм, 5 мм, 6 мм, 8 мм	

4.1 Смяна на уплътнителя на вратата

Изискване:

- ✔ Вратата е отворена.

4.1.1 Сваляне на уплътнителя на вратата

1. Освободете уплътнителя на вратата от жлеба отляво и отдясно.

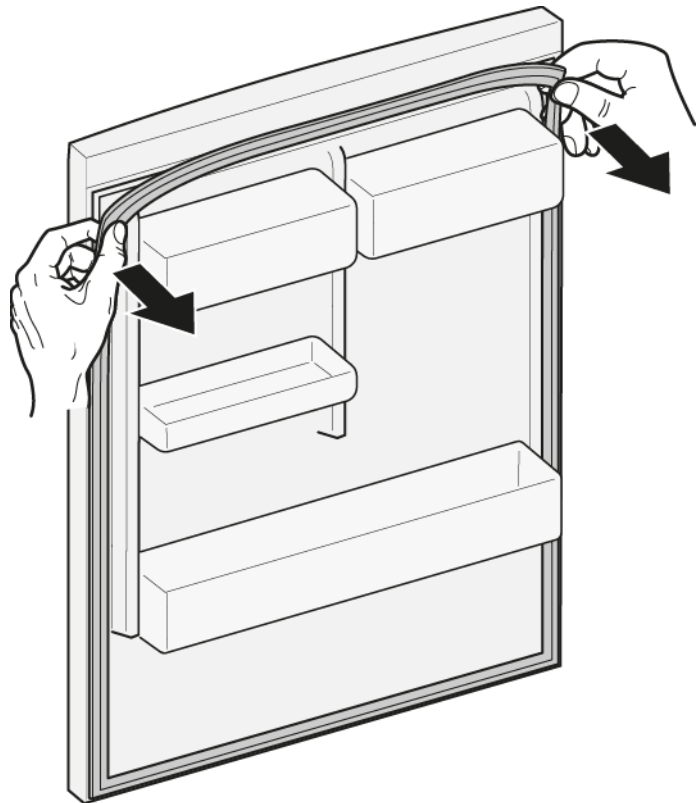

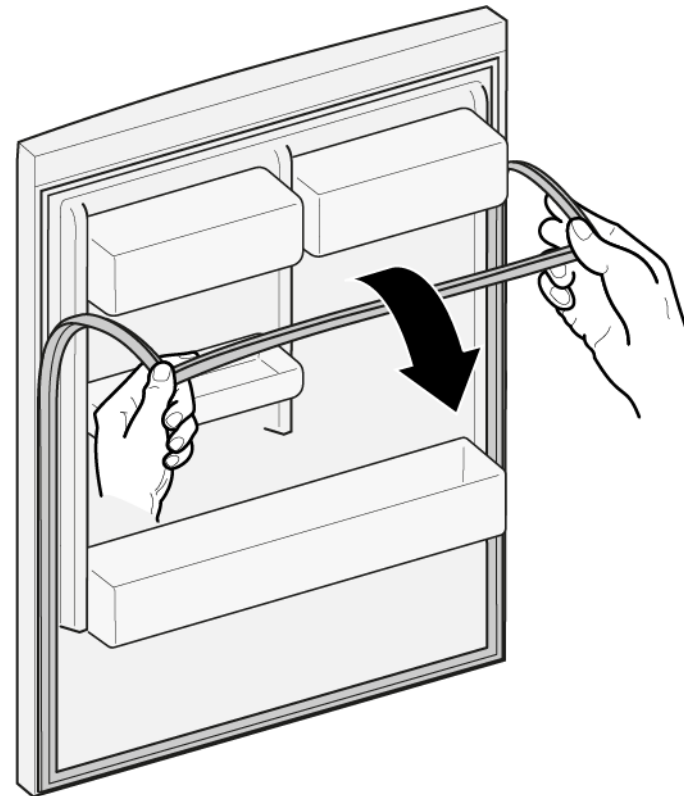

2. Извадете уплътнителя на вратата от жлеба.



- ➡ Уплътнителят на вратата е свален.

4.1.2 Монтиране на уплътнителя на вратата

	Дебелината на новия уплътнител на вратата може леко да се отличава от тази на стария уплътнител. Това няма да повлияе на начина на затваряне и нейната работа в дългосрочен план.
	Ако вашият уред има регулируеми панти или приставки за панти, можете да оптимизирате начина на затваряне по-късно.
	Малките странични отвори в уплътнителя на вратата са функционални (необходими за вентилация). Те не са производствени грешки.

1. Проверете жлеба на уплътнителя за повреди.

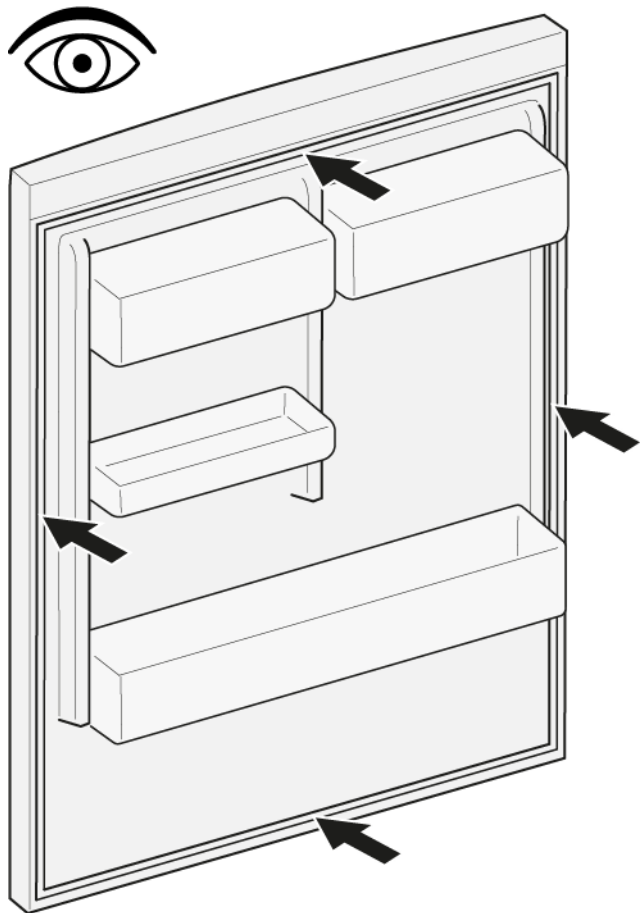

4. Натиснете ъглите на уплътнителя отгоре и отдолу към жлеба.

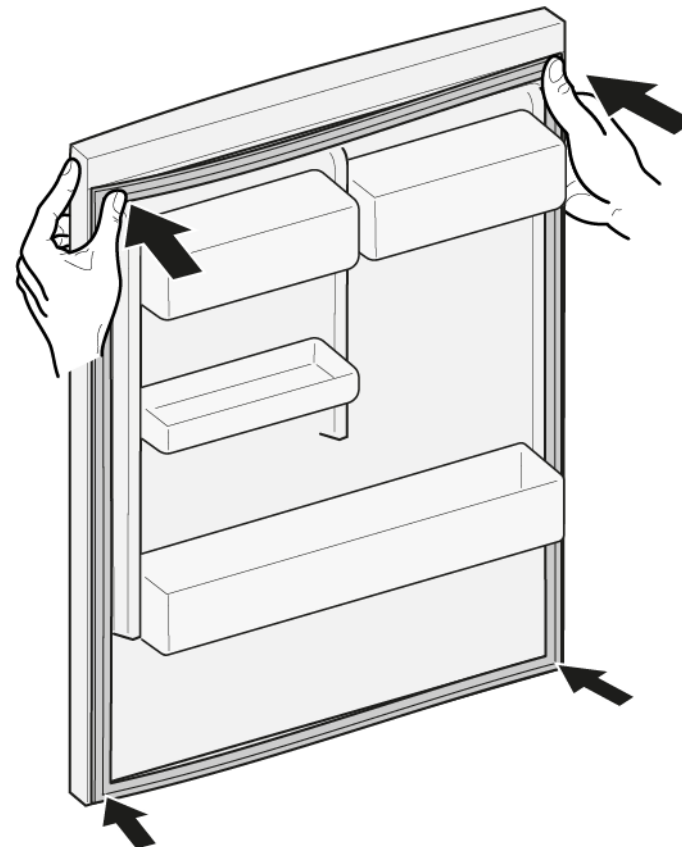



2.  Ако жлебът на уплътнителя е повреден:
- Свържете се с отдела за обслужване на клиенти.

3.  Леката деформация на уплътнителя на вратата е нормална и не засяга неговата функция. Препоръчително е да изправите уплътнителя на вратата, преди да го поставите в уреда.

Загрейте уплътнителя на вратата със сешоар или гореща вода и променете формата му.

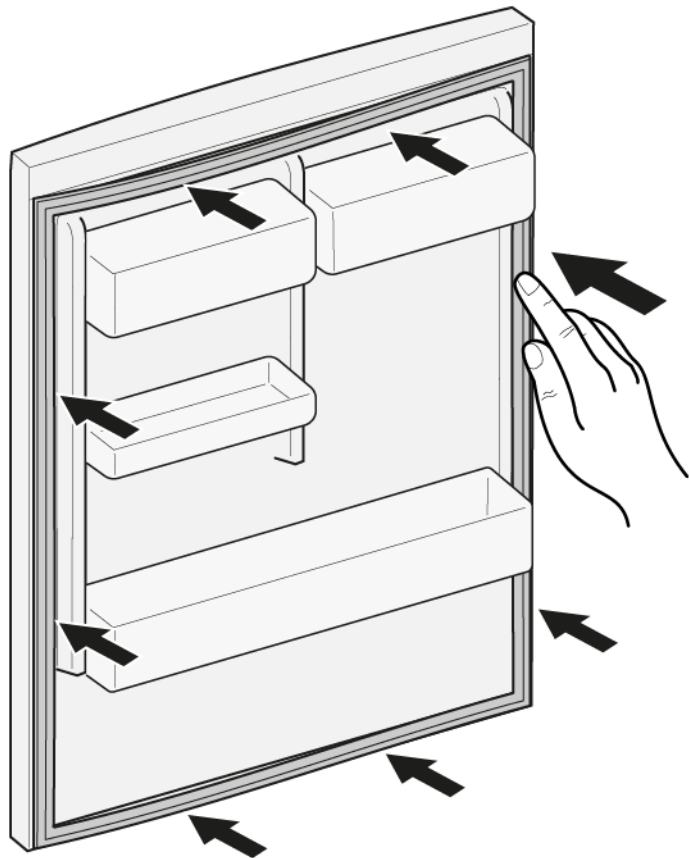
5. Постепенно вкарайте с натискане целия уплътнител в жлеба.





 Уплътнителят на вратата е монтиран.

4.2 Смяна на дръжката на вратата

Специални инструменти:

 Шестоъгълни гаечни ключове 2 мм, 2,5 мм, 3 мм, 4 мм, 5 мм, 6 мм, 8 мм [00340819]

Изискване:

-  Уредът е изключен от захранването.
-  Вратата е отворена.

4.2.1 Изваждане на дръжката на вратата

1. 1. Развийте двата винта (1).
2. Свалете дръжката на вратата (2).

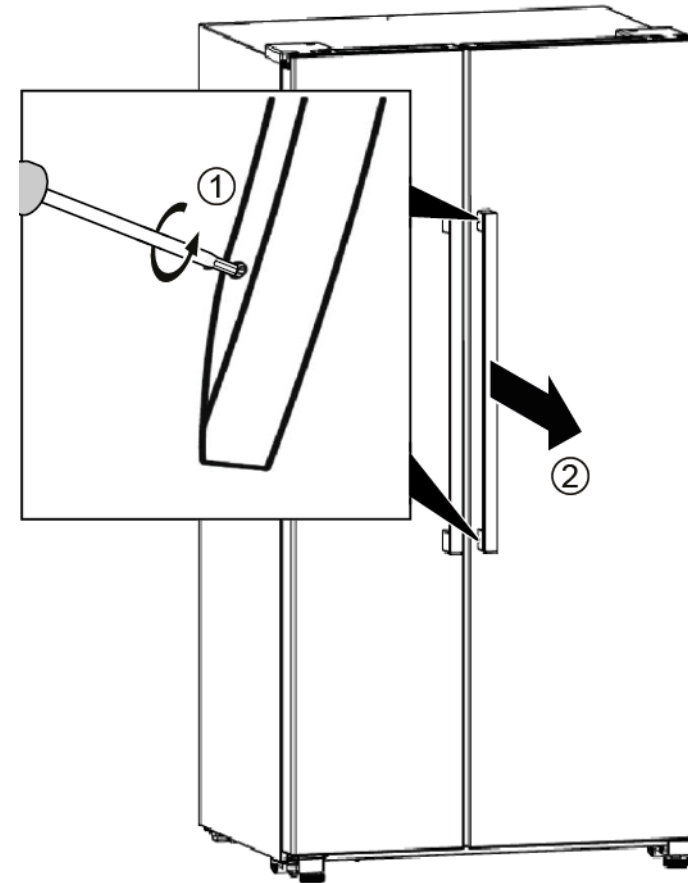

 Дръжката на вратата е свалена.

2. Свалете дръжката на втората врата по същия начин.

4.2.2 Монтиране на дръжката на вратата

- ▶ Монтирайте в обратен ред.

4.3 Смяна на рафта

Изискване:

- ✔ Вратата е отворена.

4.3.1 Изваждане на рафта

- ▶ Издърпайте рафта.

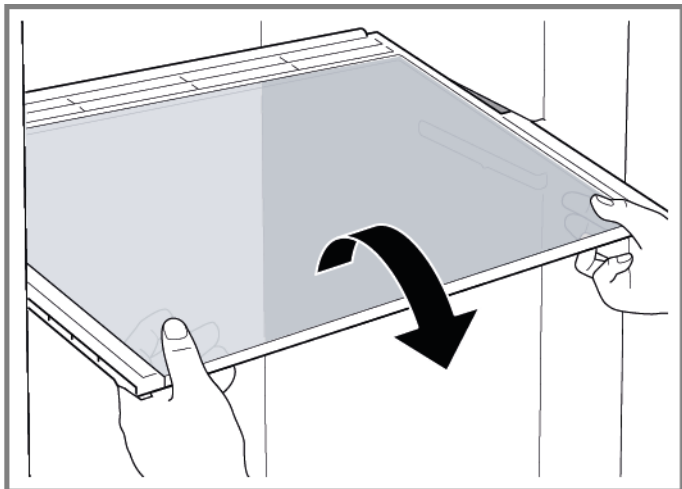

- ➡ Рафтът е свален.

4.3.2 Монтиране на рафта

- ▶ Монтирайте в обратен ред.

4.4 Смяна на табличката за бутилки

Изискване:

- ✔ Вратата е отворена.

4.4.1 Сваляне на табличката за бутилки

- ▶ Издърпайте табличката за бутилки.

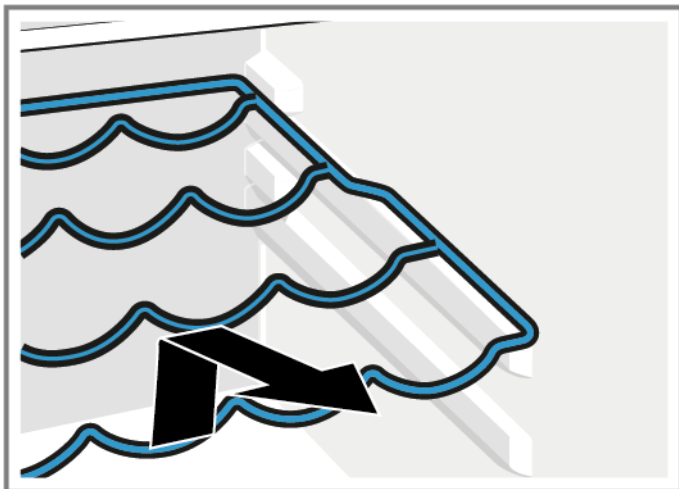

- ➡ Табличката за бутилки е свалена.

4.4.2 Монтиране на табличката за бутилки

- ▶ Монтирайте в обратен ред.

4.5 Смяна на стелажа на вратата

Изискване:

- ✔ Вратата е отворена.

4.5.1 Изваждане на стелажа на вратата

- ▶ Повдигнете стелажа на вратата нагоре.

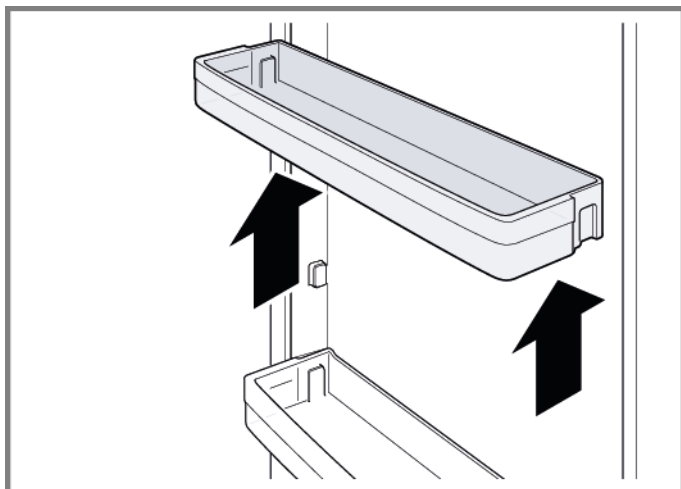

- ➡ Стелажът на вратата е свален.

4.5.2 Монтиране на стелажа на вратата

- ▶ Монтирайте в обратен ред.

4.6 Смяна на контейнерите

Изискване:

- ✔ Вратата е отворена.

4.6.1 Изваждане на контейнерите

- ▶ Издърпайте контейнера докрай, повдигнете го, за да го отделите от държача, и го извадете.

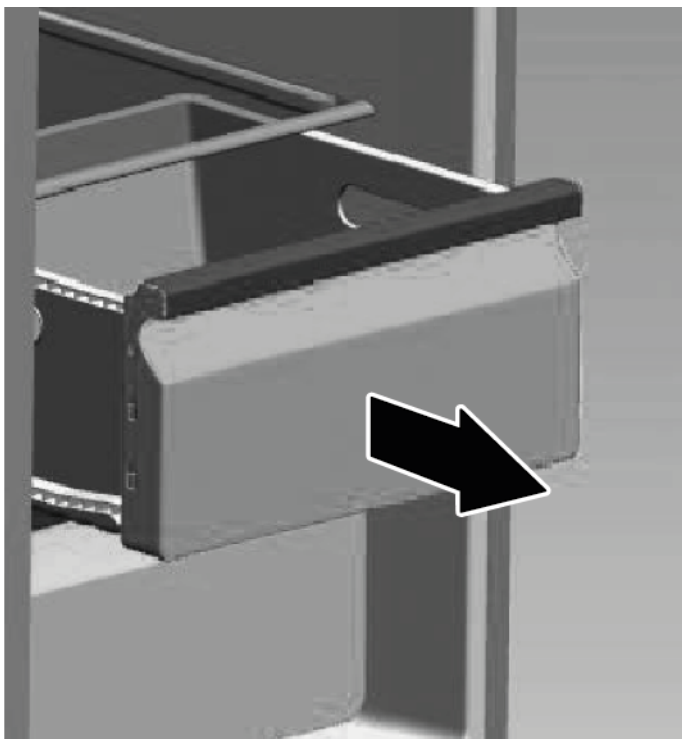

- ➡ Контейнерът е изваден.

4.6.2 Монтиране на контейнерите

- ▶ Монтирайте в обратен ред.

4.7 Смяна на LED лампата

	<p>Вашият уред е снабден с LED осветление, което не изисква поддръжка. Това осветление може да бъде ремонтирано само от специалисти от службата за обслужване на клиенти или от квалифицирани техници!</p>
-----------------------------------------------------------------------------------	----------------------------------------------------------------------------------------------------------------------------------------------------------------------------------------------------------------

	<p>⚠️ ОПАСНОСТ</p> <p>Риск от токов удар поради части под напрежение! Опасност за живота от токов удар в случай на неправилен ремонт</p> <ul style="list-style-type: none">▶ Електрическите части трябва да се ремонтират от квалифицирани електротехници.▶ След ремонта трябва да се извърши проверка за безопасност съгласно VDE 0701 или в съответствие със специфичните за страната разпоредби.
----------------------------------------------------------------------------------	----------------------------------------------------------------------------------------------------------------------------------------------------------------------------------------------------------------------------------------------------------------------------------------------------------------------------------------------------------------------------------------------------------------------------------------------

	<p>⚠️ ВНИМАТЕЛНО</p> <p>Остри ръбове! Наранявания от порязване</p> <ul style="list-style-type: none">▶ Носете предпазни ръкавици.
----------------------------------------------------------------------------------	-------------------------------------------------------------------------------------------------------------------------------------------------------------------

Изискване:

- ✔ Уредът е изключен от захранването.
- ✔ Вратата е отворена.
- ✔ Горният рафт е свален.

4.7.1 Сваляне на LED лампата

1. Хванете капака на LED лампата с две ръце и дръпнете надолу



- ➡ Капакът на LED лампата е свален.



2. Издърпайте и извадете LED лампата



3. Извадете клемата







 LED лампата е извадена.

4.7.2 Поставяне на LED лампата

- ▶ Монтирайте в обратен ред.

Savjeti za popravak - Kombinacija hladnjak/zamrzivač

 O ovom dokumentu	18
1.1 Važne informacije	18
1.1.1 Svrha	18
1.2 Objašnjenje oznaka	18
1.2.1 Stupnjevi opasnosti	18
1.2.2 Oznake opasnosti	18
1.2.3 Struktura upozorenja	19
1.2.4 Opće oznake	19
 Sigurnost	20
2.1 Opće sigurnosne upute	20
2.1.1 Svi kućanski uređaji	20
 Alat i pomagala	21
 Popravak	22
4.1 Zamjena brtve vrata.....	22
4.1.1 Uklanjanje brtve vrata.....	22
4.1.2 Postavljanje brtve vrata	22
4.2 Zamjena ručke za vrata.....	25
4.2.1 Uklanjanje ručke za vrata	25
4.2.2 Postavljanje ručke za vrata	25
4.3 Zamjena police.....	26
4.3.1 Uklanjanje police.....	26
4.3.2 Postavljanje police	26
4.4 Zamjena police za boce	27
4.4.1 Uklanjanje police za boce	27
4.4.2 Postavljanje police za boce.....	27
4.5 Zamjena posude za vrata.....	28
4.5.1 Uklanjanje posude za vrata.....	28
4.5.2 Postavljanje posude za vrata	28
4.6 Zamjena spremnika	29
4.6.1 Uklanjanje spremnika	29
4.6.2 Postavljanje spremnika.....	29
4.7 Zamjena LED svjetiljke	30
4.7.1 Uklanjanje LED svjetiljke	30
4.7.2 Postavljanje LED svjetiljke	31

i O ovom dokumentu

1.1 Važne informacije

1.1.1 Svrha

Ove upute za popravak služe kao podrška korisnicima prilikom samostalnog popravljivanja uređaja u skladu s primjenjivom Direktivom o ekološkom dizajnu (od ožujka 2021.).

One sadrže informacije o zamjeni određenih rezervnih dijelova, kao i napomene o upozorenjima i opasnostima.

Ako imate dodatna pitanja, obratite se našoj službi za korisnike. Mi snosimo odgovornost za oštećenja samo u slučaju pridržavanja uputa za popravak.

1.2 Objašnjenje oznaka

1.2.1 Stupnjevi opasnosti

Stupnjevi upozorenja sastoje se od oznake i signalne riječi. Signalna riječ ukazuje na ozbiljnost opasnosti.





Stupanj upozorenja	Značenje
 OPASNOST	Nepridržavanje poruke upozorenja rezultirat će smrtnim ili teškim ozljedama.
 UPOZORENJE	Nepridržavanje poruke upozorenja može rezultirati smrtnim ili teškim ozljedama.
 OPREZ	Nepridržavanje poruke upozorenja može rezultirati lakšim ozljedama.
 POZORI!	Nepridržavanje poruke upozorenja može rezultirati oštećenjem imovine.

Tablica 1: Stupnjevi opasnosti



1.2.2 Oznake opasnosti

Oznake opasnosti simbolička su reprezentacija s oznakom vrste opasnosti.

U ovom dokumentu koriste se sljedeće oznake opasnosti:

Oznaka opasnosti	Značenje
	Opća poruka upozorenja
	Opasnost od električnog napona
	Opasnost od eksplozije
	Opasnost od porezotina
	Opasnost od prignječenja

O ovom dokumentu

Oznaka opasnosti	Značenje
	Opasnost od vrućih površina
	Opasnost od jakog magnetskog polja
	Opasnost od neionizirajućeg zračenja

Tablica 2: Oznake opasnosti

1.2.3 Struktura upozorenja

Upozorenja u ovom dokumentu imaju normirani izgled i strukturu.



	<div style="background-color: red; color: white; padding: 2px; text-align: center;"> OPASNOST</div> <p>Vrsta i izvor opasnosti! Moguće posljedice zanemarivanja opasnosti/upozorenja.</p> <ul style="list-style-type: none"> ▶ Mjere i zabrane za sprječavanje opasnosti.
----------------------------------------------------------------------------------	---------------------------------------------------------------------------------------------------------------------------------------------------------------------------------------------------------------------------------------------------------------------------------------------------------------------------------------------------------------------------------------------





Sljedeći primjer pokazuje upozorenje na strujni udar od dijelova koji provode struju. Spominje se mjera za izbjegavanje opasnosti.

	<div style="background-color: red; color: white; padding: 2px; text-align: center;"> OPASNOST</div> <p>Opasnost od strujnog udara zbog dijelova koji provode struju! Smrt od strujnog udara</p> <ul style="list-style-type: none"> ▶ Isključite uređaj iz električnog napajanja najmanje 60 sekundi prije izvođenja popravaka.
-----------------------------------------------------------------------------------	--------------------------------------------------------------------------------------------------------------------------------------------------------------------------------------------------------------------------------------------------------------------------------------------------------------------------------------------------------------------------------------------------------------------------------------------------

1.2.4 Opće oznake

U ovom dokumentu koriste se sljedeće opće oznake:

Opća znaka	Značenje
	Oznaka posebnog savjeta (tekst i/ili grafika)
	Oznaka jednostavnog savjeta (samo tekst)
	Oznaka veze na videovodič

Opća znaka	Značenje
	Oznaka potrebnog alata
	Oznaka potrebnih preduvjeta
	Oznaka uvjeta (ako ..., tad ...)
	Oznaka rezultata
Početak	Oznaka tipke ili gumba
[00123456]	Oznaka broja materijala
Status	Oznaka prikazanog teksta / prozor (na zaslonu uređaja)

Tablica 3: Opće oznake

2.1 Opće sigurnosne upute

2.1.1 Svi kućanski uređaji

Opasnost od strujnog udara zbog dijelova koji provode struju!

- Pogreške izazvane popravcima električnih sastavnih dijelova mogu dovesti do strujnog udara!
- Isključite uređaj iz struje na najmanje 60 sekundi prije početka radova.
- Nakon popravka provedite sigurnosni test u skladu s VDE 0701 ili nacionalnim propisima.

Opasnost od ozljeda zbog oštih rubova!

- Nosite zaštitne rukavice.

Opasnost od prignječenja tijekom izvođenja radova na popravcima, održavanju, rješavanju problema i servisiranju teških i pokretnih sastavnih dijelova

- Nosite zaštitnu obuću.
- Osigurajte teške sastavne dijelove od pada.
- Nemojte umetati dijelove tijela u pokretne sastavne dijelove.



Opasnost za sigurnost/rad uređaja!

- Koristite samo originalne rezervne dijelove.

Opasnost od oštećenja elektrostatički osjetljivih sastavnih dijelova (ESD)!

- Nemojte dodirivati module, uključujući priključke i rute vodiča.

Alat i pomagala

Oznaka	Pojedinosti	Slike
Zaštitna navlaka [00342013]	60 cm x 50 cm	
Šesterokutni utični ključevi [00340819]	2 mm, 2,5 mm, 3 mm, 4 mm, 5 mm, 6 mm, 8 mm	

4.1 Zamjena brtve vrata

Zahtjev:

-  Vrata su otvorena.

4.1.1 Uklanjanje brtve vrata

1. Otpustite brtvu vrata iz utora u desnom i lijevom kutu.

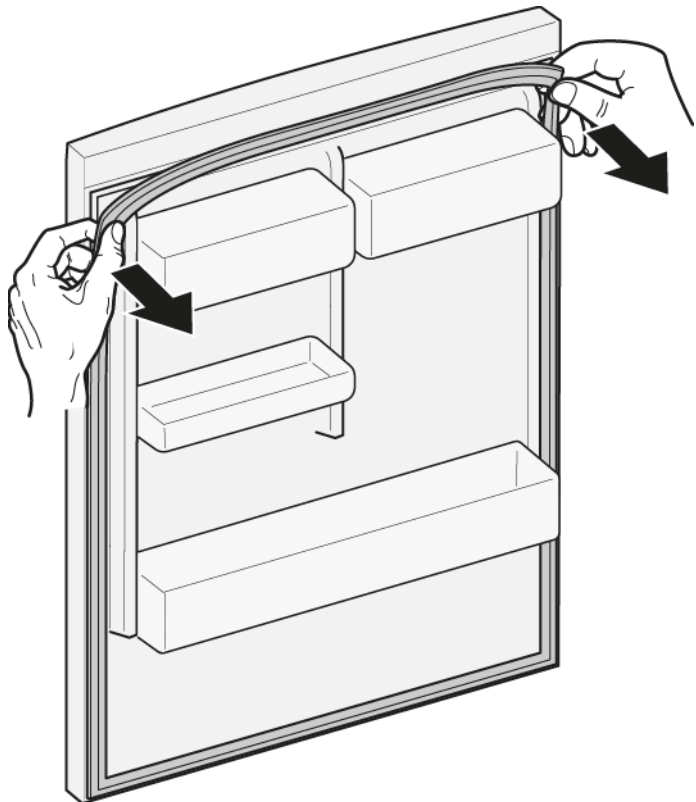

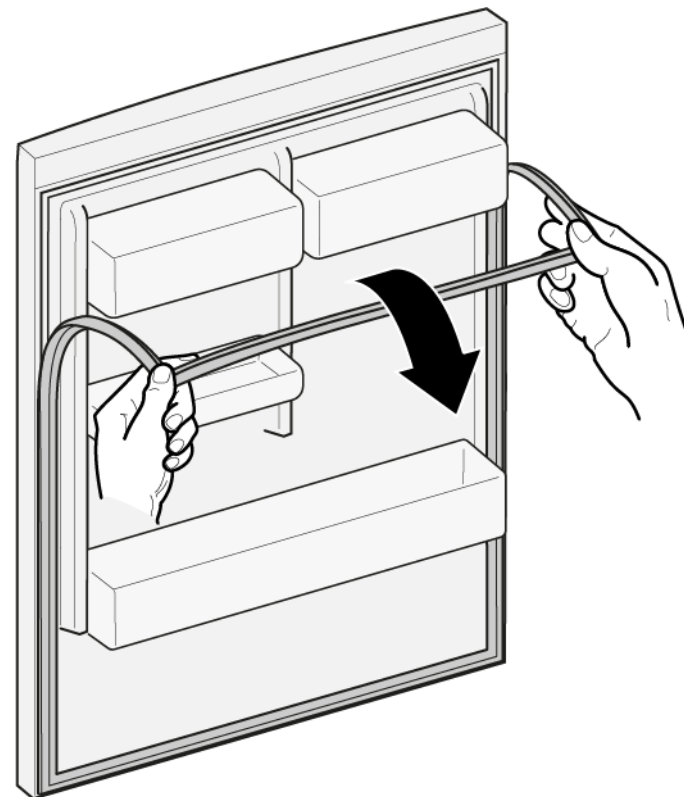

2. Izvucite brtvu vrata iz utora.



-  Brtva vrata je uklonjena.

4.1.2 Postavljanje brtve vrata

	Debljina nove brtve vrata može malo odstupati od debljine stare brtve vrata. To neće utjecati na zatvaranje i dugoročnu funkciju.
	Ako uređaj ima prilagodljive zglobove ili nastavke zglobova, možete dodatno optimizirati zatvaranje.
	Mali bočni otvori u brtvi vrata su funkcijski (potrebni za ventilaciju). Nije riječ o proizvodnim pogreškama.

1. Provjerite ima li oštećenja na utoru za brtvu.

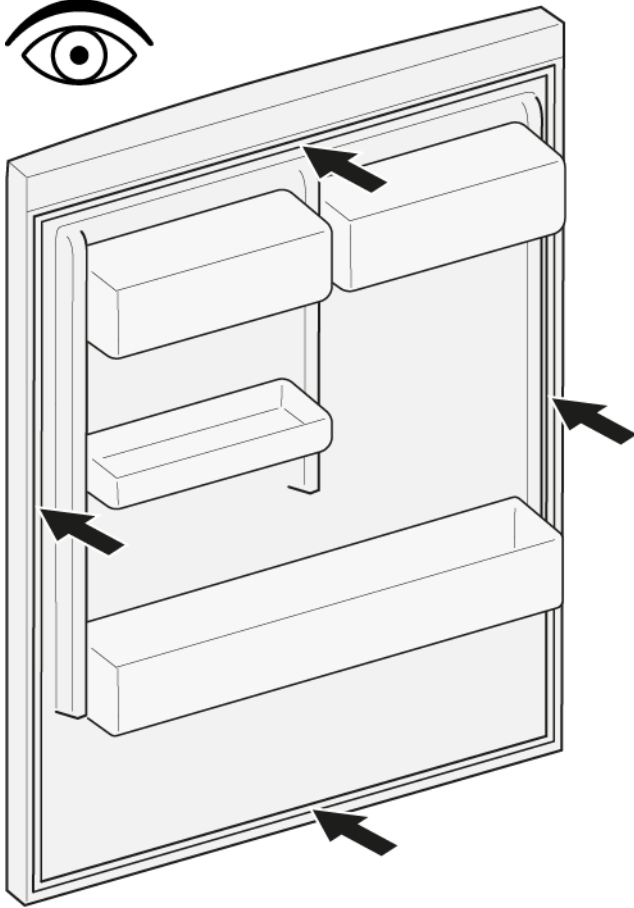

4. Gurnite kutove brtve na vrh i dno utora.

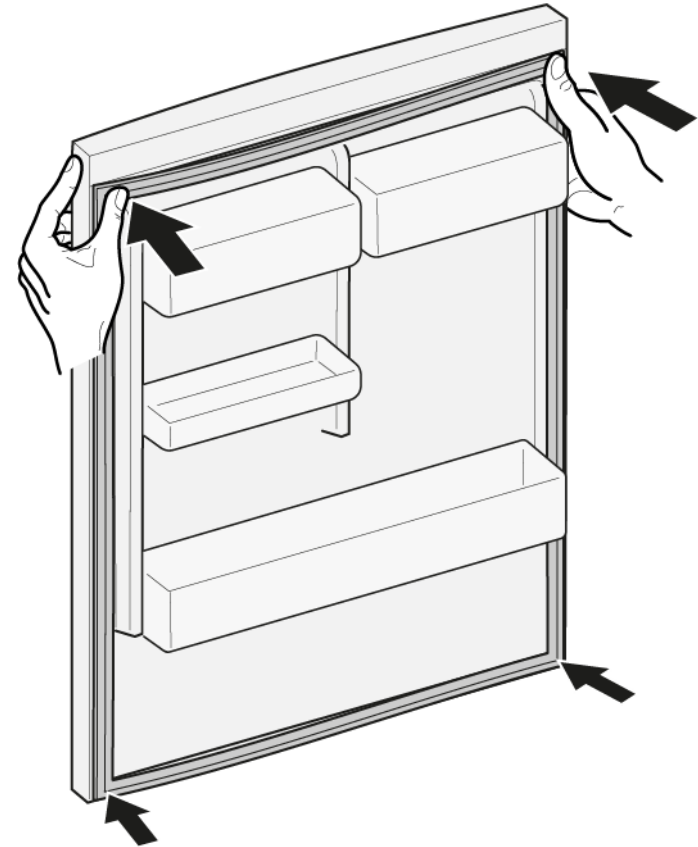

2.  Ako je utor za brtvu oštećen.
- Obratite se službi za korisnike.

3.  Blago odstupanje brtve vrata normalno je i ne utječe na funkciju. Preporučuje se izravnati brtvu vrata prije umetanja u uređaj.

Zagrijte brtvu vrata sušilom za kosu ili vrućom vodom i ručno je oblikujte.

5. Utisnite cijelu brtvu korak po korak u utor.

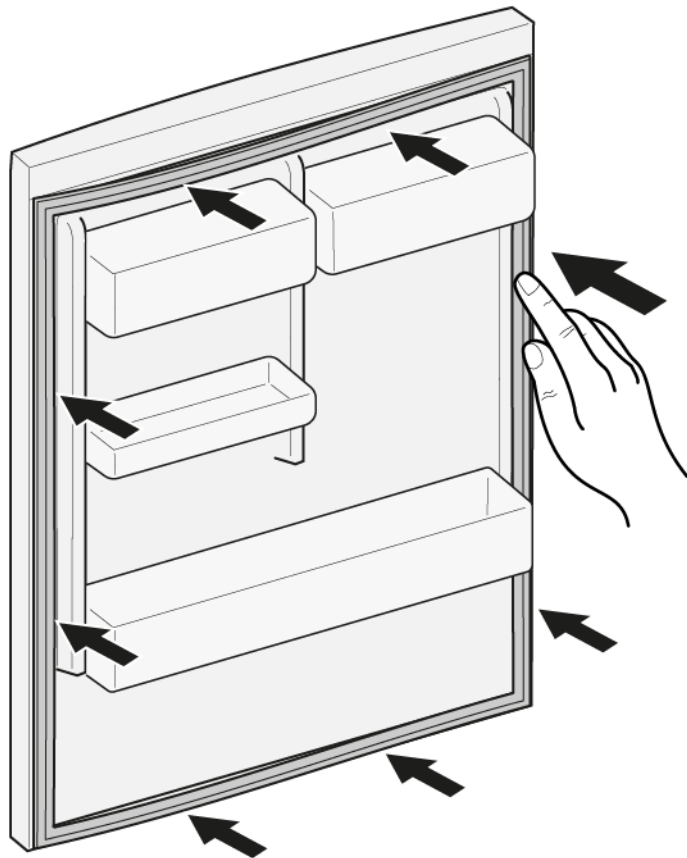

 Brtva vrata je postavljena.

4.2 Zamjena ručke za vrata

Specijalni alati:

🌀 Šesterokutni utični ključevi 2 mm, 2,5 mm, 3 mm, 4 mm, 5 mm, [00340819]
6 mm, 8 mm

Zahtjev:

- ✔ Uređaj je isključen iz napajanja.
- ✔ Vrata su otvorena.

4.2.1 Uklanjanje ručke za vrata

1. Odvijte dva vijka (1).
2. Uklonite ručku za vrata (2).

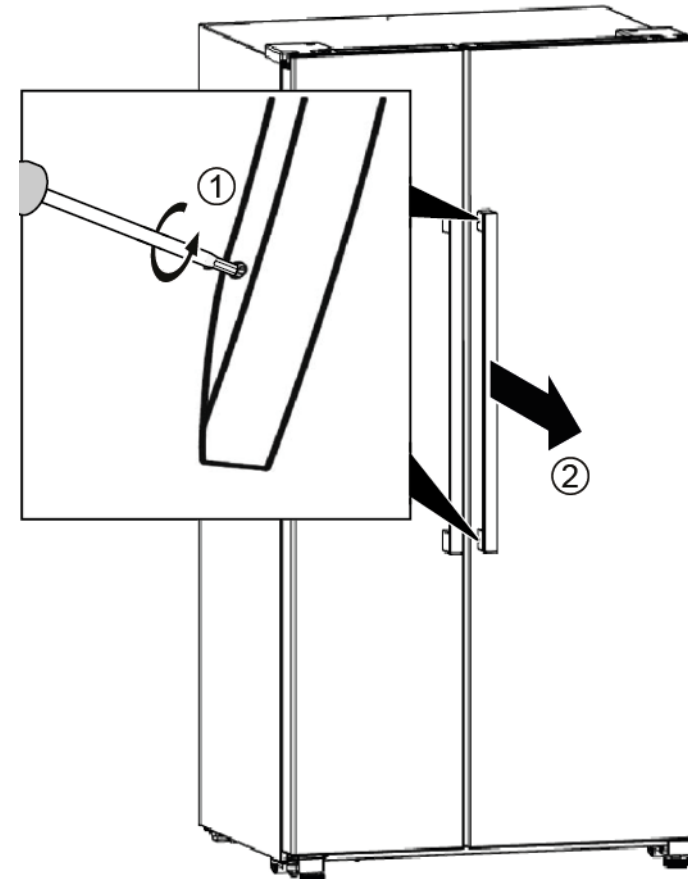

➡ Ručka za vrata je uklonjena.

2. Uklonite drugu ručku za vrata na isti način.

4.2.2 Postavljanje ručke za vrata

- ▶ Postavite obratnim redoslijedom.

4.3 Zamjena police

Zahtjev:

- ✔ Vrata su otvorena.

4.3.1 Uklanjanje police

- ▶ Izvucite policu.

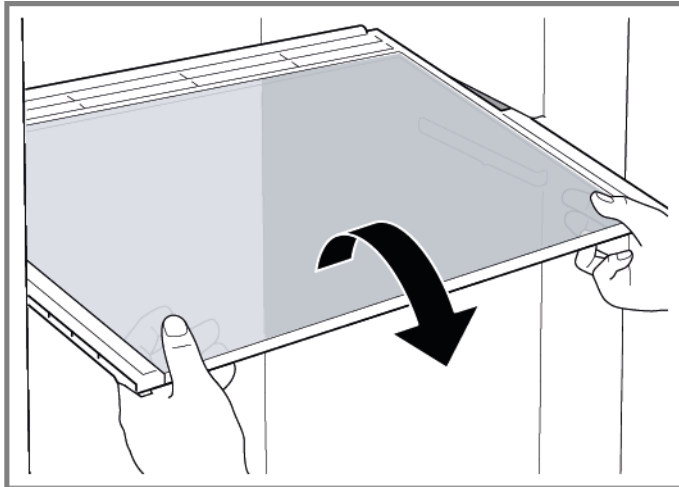

- ➡ Polica je uklonjena.

4.3.2 Postavljanje police

- ▶ Postavite obratnim redoslijedom.

4.4 Zamjena police za boce

Zahtjev:

- ✔ Vrata su otvorena.

4.4.1 Uklanjanje police za boce

- ▶ Izvucite policu za boce.

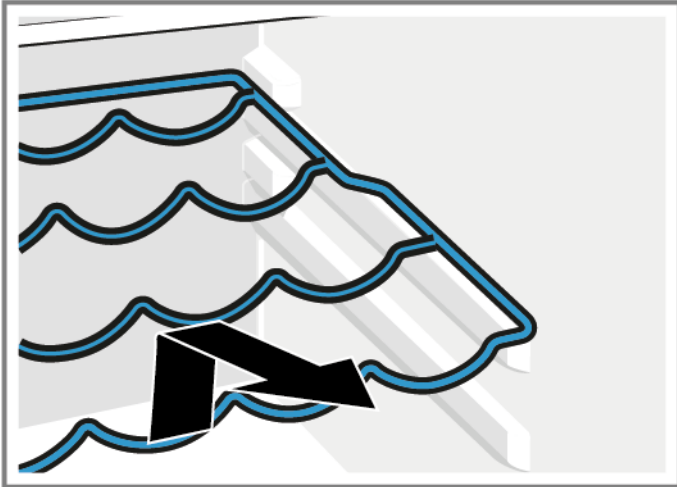

- ➔ Polica za boce je uklonjena.

4.4.2 Postavljanje police za boce

- ▶ Postavite obratnim redoslijedom.

4.5 Zamjena posude za vrata

Zahtjev:

- ✔ Vrata su otvorena.

4.5.1 Uklanjanje posude za vrata

- ▶ Podignite posudu za vrata prema gore.

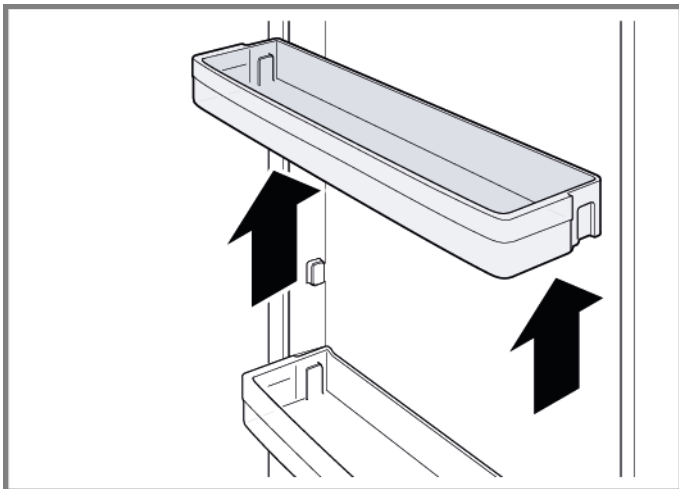

- ➡ Posuda za vrata je uklonjena.

4.5.2 Postavljanje posude za vrata

- ▶ Postavite obratnim redoslijedom.

4.6 Zamjena spremnika

Zahtjev:

- ✔ Vrata su otvorena.

4.6.1 Uklanjanje spremnika

- ▶ Potpuno izvucite spremnik, podignite ga da biste ga odvojili s držača i izvadite ga.

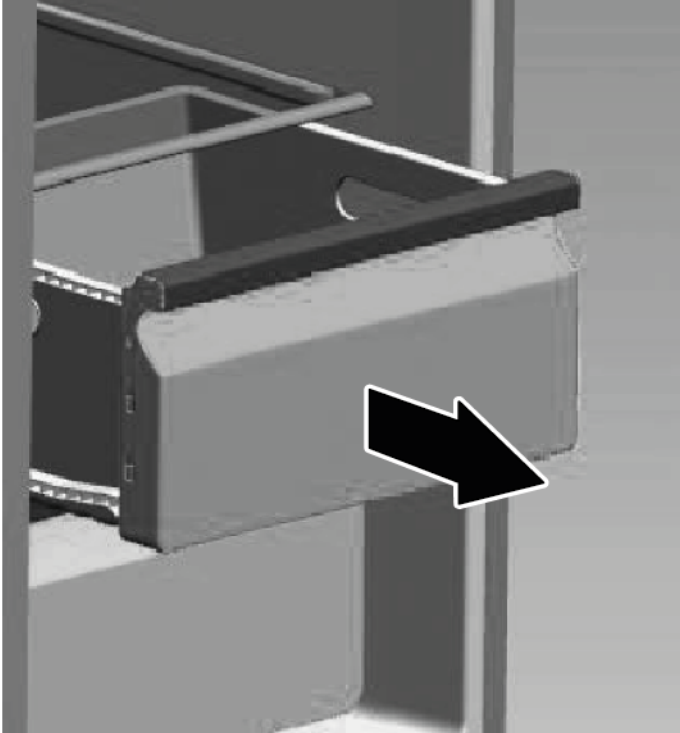

- ➡ Spremnik je uklonjen.

4.6.2 Postavljanje spremnika

- ▶ Postavite obratnim redoslijedom.

4.7 Zamjena LED svjetiljke

i Uređaj ima svjetlo LED koje ne zahtijeva održavanje. Ta svjetla smije popravljati samo osoblje iz službe za korisnike ili ovlašteni tehničari!

⚠️ OPASNOST
Opasnost od strujnog udara zbog dijelova koji provode struju!
U slučaju nepravilnog popravka može doći do opasnosti za život od strujnog udara

- ▶ Električne dijelove mora popraviti kvalificirani električar.
- ▶ Nakon popravka provedite sigurnosni test u skladu s VDE 0701 ili nacionalnim propisima.

⚠️ OPREZ
Oštri rubovi!
Porezotine

- ▶ Nosite zaštitne rukavice.

Zahtjev:

- ✔ Uređaj je isključen iz napajanja.
- ✔ Vrata su otvorena.
- ✔ Gornja polica je uklonjena.

4.7.1 Uklanjanje LED svjetiljke

1. Uхватite poklopac LED svjetiljke objema rukama i povucite ga prema dolje



- ➡ Poklopac LED svjetiljke je uklonjen.



2. Povucite i izvadite LED svjetiljku



3. Odvojite priključak







- ➡ LED svjetiljka je uklonjena.

4.7.2 Postavljanje LED svjetiljke

- ▶ Postavite obratnim redoslijedom.

Poznámky k opravě - Kombinace chladničky s mrazničkou

 O tomto dokumentu	33
1.1 Důležité informace	33
1.1.1 Účel	33
1.2 Vysvětlení symbolů	33
1.2.1 Úroveň nebezpečí	33
1.2.2 Symboly nebezpečí	33
1.2.3 Struktura výstrah	34
1.2.4 Obecné symboly	34
 Bezpečnost	35
2.1 Všeobecné bezpečnostní pokyny	35
2.1.1 Všechny domácí spotřebiče	35
 Nástroje a pomůcky	36
 Oprava	37
4.1 Výměna těsnění dvířek	37
4.1.1 Vyjmutí těsnění dvířek	37
4.1.2 Montáž těsnění dvířek	37
4.2 Výměna madla dvířek	40
4.2.1 Vyjmutí madla dvířek	40
4.2.2 Montáž madla dvířek	40
4.3 Výměna odkládací plochy	41
4.3.1 Vyjmutí odkládací plochy	41
4.3.2 Montáž odkládací plochy	41
4.4 Výměna držáku na láhve	42
4.4.1 Vyjmutí držáku na láhve	42
4.4.2 Montáž držáku na láhve	42
4.5 Výměna dveřní přihrádky	43
4.5.1 Vyjmutí dveřní přihrádky	43
4.5.2 Montáž dveřní přihrádky	43
4.6 Výměna zásobníků	44
4.6.1 Vyjmutí zásobníků	44
4.6.2 Montáž zásobníků	44
4.7 Výměna LED osvětlení	45
4.7.1 Vyjmutí LED osvětlení	45
4.7.2 Montáž LED osvětlení	46

i O tomto dokumentu

1.1 Důležité informace

1.1.1 Účel

Tyto pokyny k opravě pomáhají spotřebiteli při vlastnoruční opravě spotřebičů v souladu s platnými předpisy o ekodesignu (platnými k 03/2021).



Obsahují informace o výměně některých náhradních dílů včetně příslušných výstrah a nebezpečí.

V případě dotazů se obraťte na náš zákaznický servis. Za škody ručíme pouze v případě, že budou správně dodrženy pokyny k opravě.

1.2 Vysvětlení symbolů

1.2.1 Úroveň nebezpečí

Jednotlivé úrovně výstrah se skládají ze symbolu a signálního slova. Signální slova uvádějí závažnost nebezpečí.





Úroveň výstrahy	Význam
 NEBEZPEČÍ	Nedodržení výstražného upozornění způsobí smrt nebo vážná zranění.
 VÝSTRAHA	Nedodržení výstražného upozornění může způsobit smrt nebo vážná zranění.
 POZOR	Nedodržení výstražného upozornění může způsobit lehká zranění.
POZOR!	Nedodržení výstražného upozornění může způsobit škody na majetku.

Tabulka 1: Úroveň nebezpečí



1.2.2 Symboly nebezpečí

Symboly nebezpečí jsou symbolická znázornění určující druh nebezpečí.

V tomto dokumentu jsou použity následující symboly nebezpečí:

Symbol nebezpečí	Význam
	Obecné výstražné upozornění
	Nebezpečí vycházející z elektrického napětí
	Nebezpečí výbuchu
	Nebezpečí pořezání
	Nebezpečí rozdrcení

i O tomto dokumentu

Symbol nebezpečí	Význam
	Nebezpečí spojené s horkými povrchy
	Nebezpečí vycházející ze silného elektromagnetického pole
	Nebezpečí z neionizujícího záření

Tabulka 2: Symboly nebezpečí

1.2.3 Struktura výstrah

Výstrahy použité v tomto dokumentu mají standardizovaný vzhled a strukturu.



	<div style="background-color: red; color: white; padding: 2px; text-align: center;">⚠ NEBEZPEČÍ</div> <p>Typ a zdroj nebezpečí! Možné důsledky nedodržení výstražného upozornění.</p> <ul style="list-style-type: none"> ▶ Opatření a zákazy eliminující nebezpečí.
----------------------------------------------------------------------------------	------------------------------------------------------------------------------------------------------------------------------------------------------------------------------------------------------------------------------------------------------------------------------------------------------





Následující příklad ukazuje výstrahu, která varuje před zásahem elektrickým proudem při dotyku dílů pod proudem. Je uvedeno opatření pro zabránění rizika.

	<div style="background-color: red; color: white; padding: 2px; text-align: center;">⚠ NEBEZPEČÍ</div> <p>Nebezpečí úrazu elektrickým proudem při dotyku dílů pod proudem! Usmrcení elektrickým proudem</p> <ul style="list-style-type: none"> ▶ Odpojte spotřebič od přívodu elektrického proudu alespoň 60 sekund před zahájením opravy.
-----------------------------------------------------------------------------------	----------------------------------------------------------------------------------------------------------------------------------------------------------------------------------------------------------------------------------------------------------------------------------------------------------------------------------------------------------------------------

1.2.4 Obecné symboly

V tomto dokumentu jsou použity následující obecné symboly:

Obecný symbol	Význam
	Uvedení zvláštního tipu (text nebo grafické vyjádření)
	Uvedení jednoduchého tipu (pouze text)
	Uvedení odkazu k videonávodu

Obecný symbol	Význam
	Uvedení požadovaných nástrojů
	Uvedení požadovaných podmínek
	Uvedení podmínky (když, pak atd.)
	Uvedení výsledku
[Start]	Uvedení klávesy nebo tlačítka
[00123456]	Uvedení čísla materiálu
Status	Uvedení zobrazeného textu / okna (na ukazateli spotřebiče)

Tabulka 3: Obecné symboly

2.1 Všeobecné bezpečnostní pokyny

2.1.1 Všechny domácí spotřebiče

Nebezpečí úrazu elektrickým proudem při dotyku dílů pod proudem!

- Chyby při opravě elektrických součástí mohou vést k úrazu elektrickým proudem!
- Odpojte spotřebič ze sítě alespoň 60 sekund před zahájením prací.
- Po opravě nechte provést bezpečnostní zkoušku podle VDE 0701 nebo specifických předpisů dané země.

Nebezpečí poranění o ostré hrany!

- Používejte ochranné rukavice.

Nebezpečí rozdrčení během opravy, údržby, odstranění závad a servisu těžkými a pohyblivými součástmi

- Používejte bezpečnostní obuv.
- Zajistěte těžké součásti před pádem.
- Nesahejte na pohyblivé součásti.



Nebezpečí z hlediska bezpečnosti / funkce spotřebiče!

- Používejte pouze originální náhradní díly.

Nebezpečí poškození elektrostaticky citlivých součástí (elektrostatický výboj)!

- Nedotýkejte se modulů, včetně přípojek a vodičů.

Nástroje a pomůcky

Označení	Detaily	Snímky
Ochranná tkanina [00342013]	60 cm x 50 cm	
Imbusové klíče [00340819]	2 mm, 2,5 mm, 3 mm, 4 mm, 5 mm, 6 mm, 8 mm	

4.1 Výměna těsnění dvířek

Požadavek:

- ✔ Dvířka jsou otevřená.

4.1.1 Vyjmutí těsnění dvířek

1. Uvolněte těsnění dvířek z drážky v pravém a levém rohu.

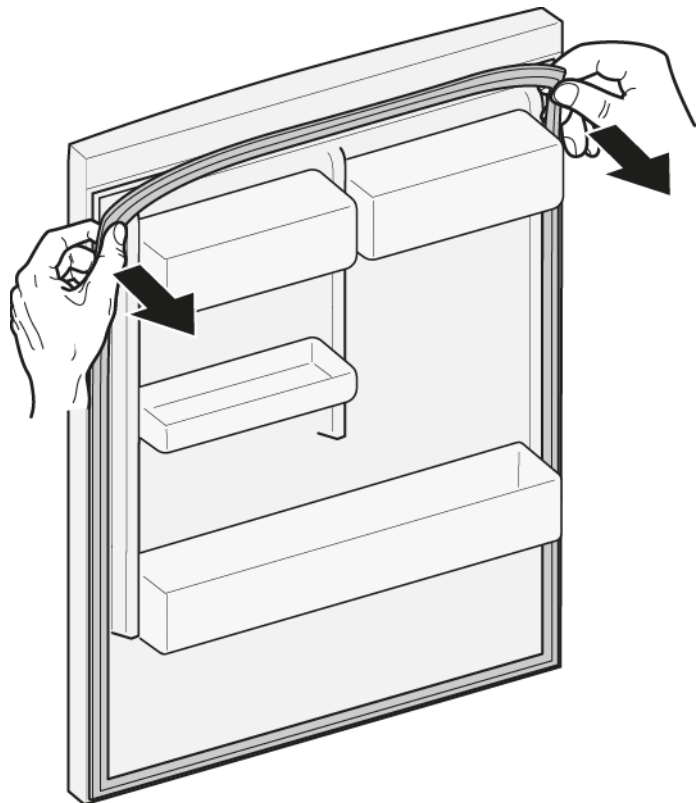

2. Vytáhněte těsnění z drážky.

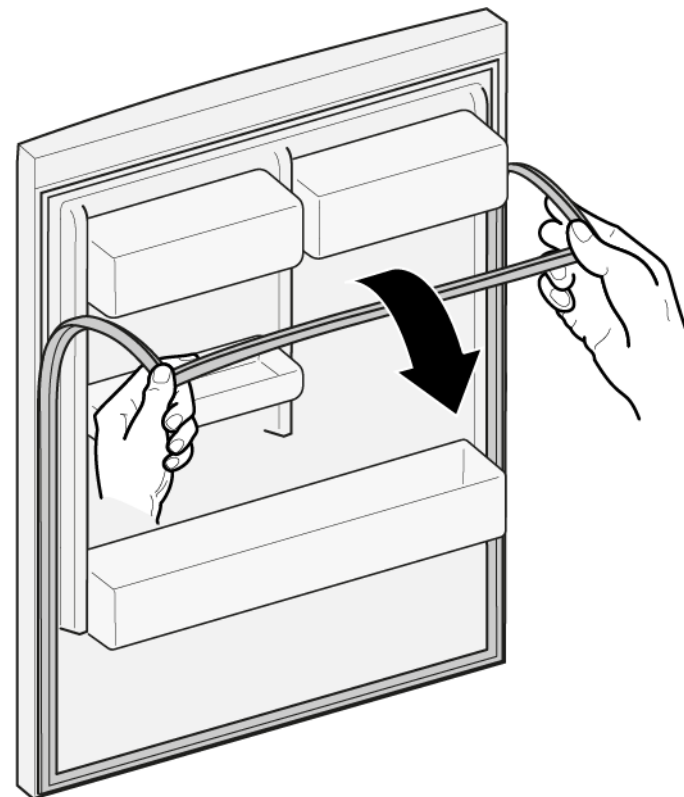

- ➡ Těsnění dvířek je vyjmuté.

4.1.2 Montáž těsnění dvířek



Nové těsnění dvířek může mít trochu jinou šířku než původní těsnění. Dovření dvířek ani dlouhodobá funkce tím nebudou ovlivněny.



Pokud má spotřebič nastavitelné závěsy nebo nástavce závěsů, můžete dovření dvířek následně upravit.



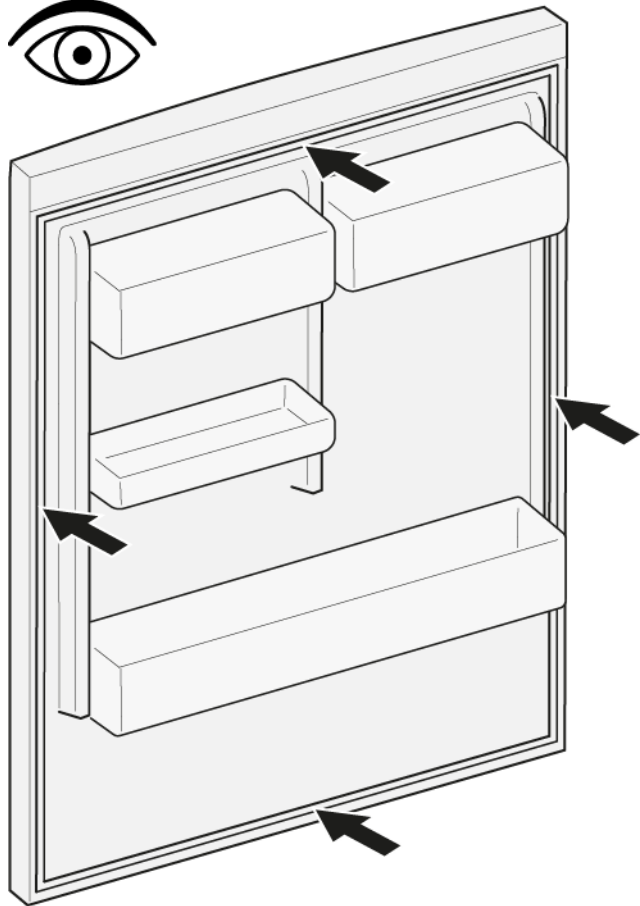

Malé boční otvory v těsnění dvířek jsou funkční (slouží pro přívod vzduchu). Nejsou vadou výrobku.

1. Zkontrolujte, zda není poškozena drážka těsnění.

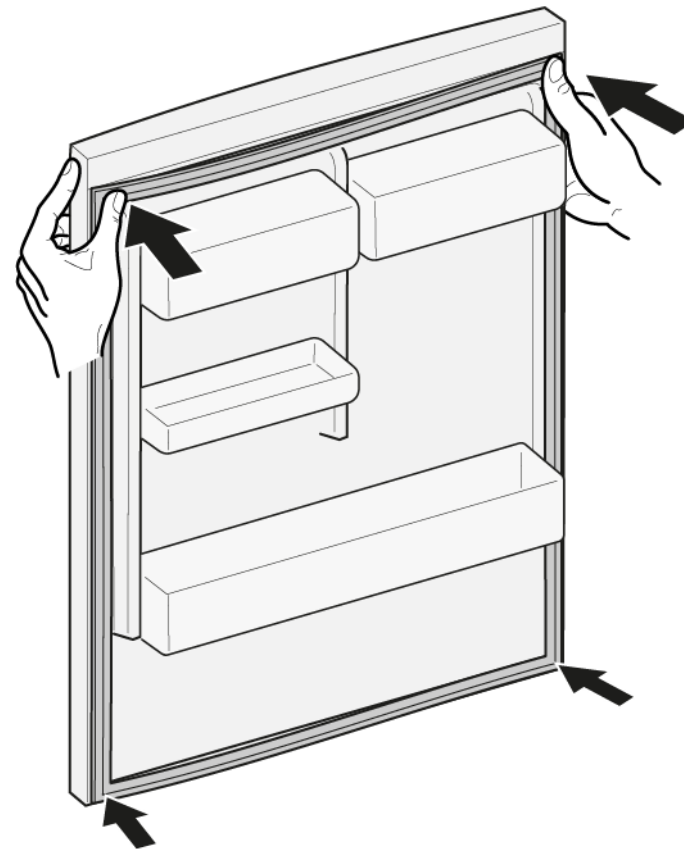

4. Zatlačte horní a dolní rohy těsnění do drážky.



2.  Pokud je drážka těsnění poškozená,
- kontaktujte zákaznický servis.

3.  Lehká deformace těsnění dvířek je normální a nemá vliv na jeho funkci. Před vložením do spotřebiče doporučujeme těsnění narovnat.

Těsnění zahřejte fénem nebo horkou vodou a manuálně upravte jeho tvar.

5. Postupně zatlačte do drážky celé těsnění.

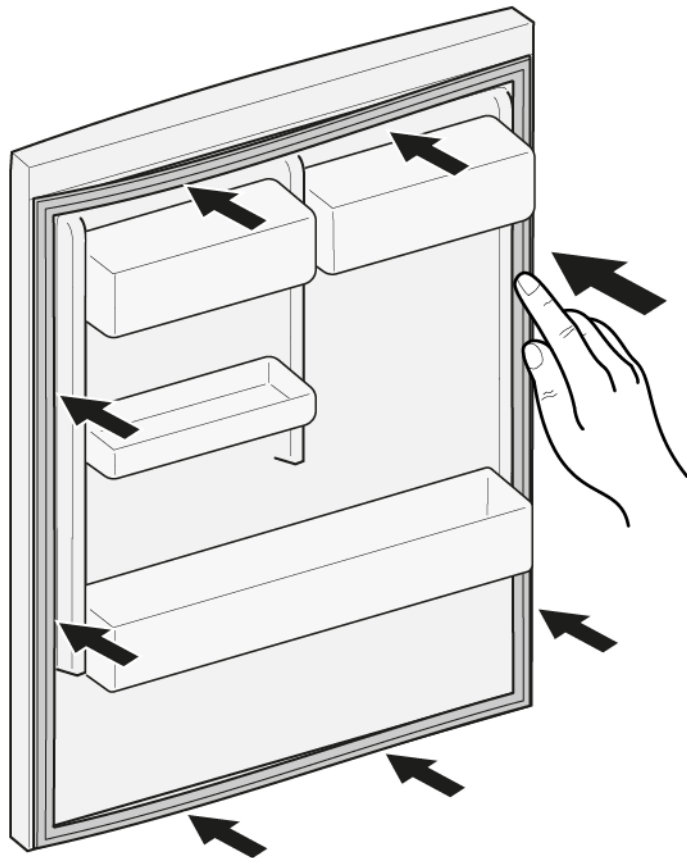



 Těsnění dvířek je namontované.

4.2 Výměna madla dvířek

Speciální nástroje:

 Imbusové klíče 2 mm, 2,5 mm, 3 mm, 4 mm, 5 mm, [00340819]
6 mm, 8 mm

Požadavek:

-  Spotřebič je odpojený od přívodu elektrické energie.
-  Dvířka jsou otevřená.

4.2.1 Vyjmutí madla dvířek

1. 1. Vyšroubujte dva šrouby (1).
2. 2. Vyjměte madlo dvířek (2).

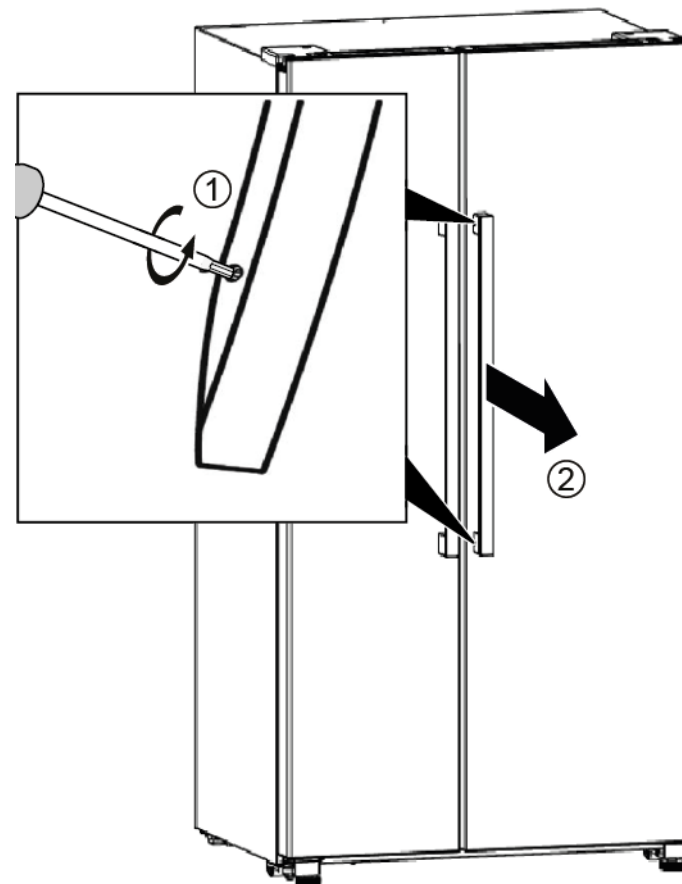

 Madlo dvířek je vyjmuté.

2. Madlo druhých dvířek vyjměte stejným způsobem.

4.2.2 Montáž madla dvířek

- ▶ Montáž proveďte v opačném sledu.

4.3 Výměna odkládací plochy

Požadavek:

- ✔ Dvířka jsou otevřená.

4.3.1 Vyjmutí odkládací plochy

- ▶ Vytáhněte odkládací plochu.

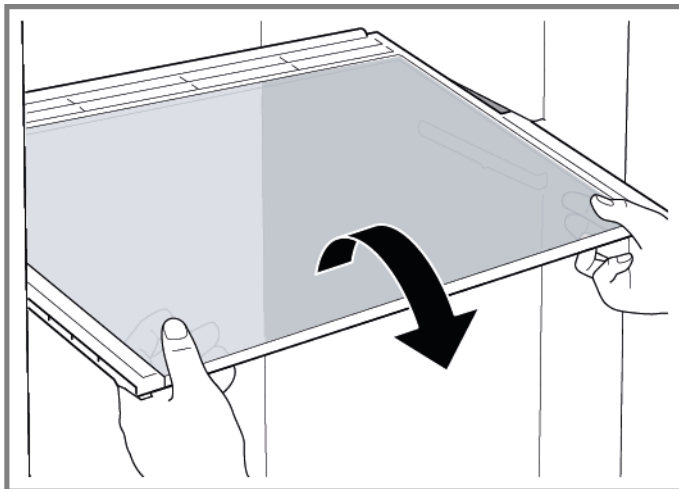

- ➡ Odkládací plocha je vyjmutá.

4.3.2 Montáž odkládací plochy

- ▶ Montáž proveďte v opačném sledu.

4.4 Výměna držáku na láhve

Požadavek:

- ✔ Dvířka jsou otevřená.

4.4.1 Vyjmutí držáku na láhve

- ▶ Vytáhněte držák na láhve.

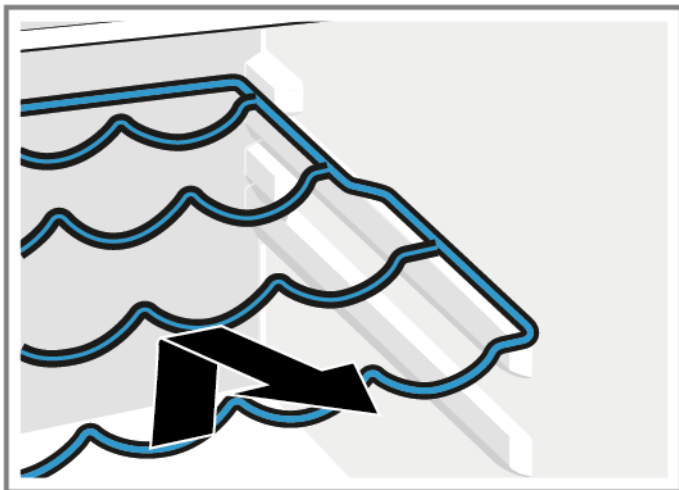

- ➡ Držák na láhve je vyjmutý.

4.4.2 Montáž držáku na láhve

- ▶ Montáž provedte v opačném sledu.

4.5 Výměna dveřní přihrádky

Požadavek:

- ✔ Dvířka jsou otevřená.

4.5.1 Vyjmutí dveřní přihrádky

- ▶ Zvedněte dveřní přihrádku nahoru.

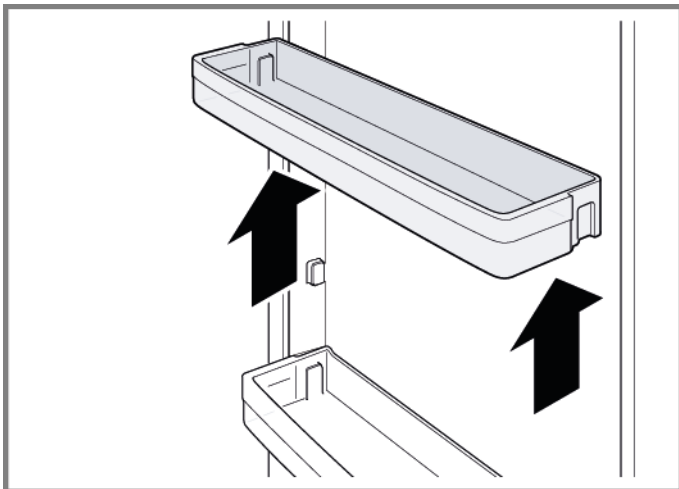

- ➡ Dveřní přihrádka je vyjmutá.

4.5.2 Montáž dveřní přihrádky

- ▶ Montáž proveďte v opačném sledu.

4.6 Výměna zásobníků

Požadavek:

- ✔ Dvířka jsou otevřená.

4.6.1 Vyjmutí zásobníků

- ▶ Úplně vytáhněte zásobník, zvednutím jej vyhákněte z držáku a vyjměte jej.

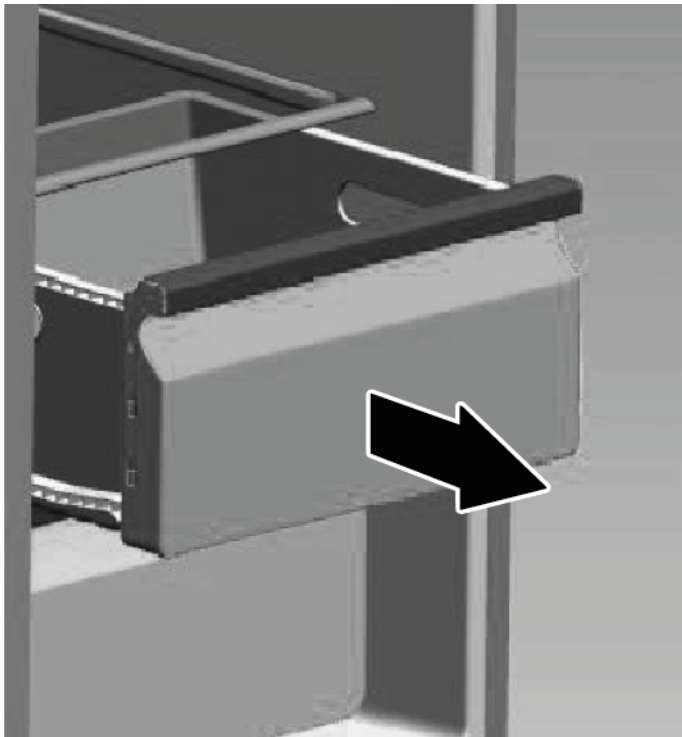

- ➡ Zásobník je vyjmutý.

4.6.2 Montáž zásobníků

- ▶ Montáž provedte v opačném sledu.

4.7 Výměna LED osvětlení

 Váš spotřebič je vybaven bezúdržbovým LED osvětlením. Tato osvětlení smí být opravena pouze zákaznickým servisem nebo oprávněným technikem!

 **NEBEZPEČÍ**
Nebezpečí úrazu elektrickým proudem při dotyku dílů pod proudem!
V případě neodborné opravy hrozí nebezpečí smrtelného úrazu elektrickým proudem

- ▶ Opravu elektrického zařízení smí provádět jen kvalifikovaný elektrikář.
- ▶ Po opravě nechte provést bezpečnostní zkoušku podle VDE 0701 nebo specifických předpisů dané země.

 **POZOR**
Ostré hrany!
Nebezpečí řezných poranění

- ▶ Používejte ochranné rukavice.

Požadavek:

- ✔ Spotřebič je odpojený od přívodu elektrické energie.
- ✔ Dvířka jsou otevřená.
- ✔ Horní odkládací plocha je vyjmutá.

4.7.1 Vyjmutí LED osvětlení

1. Vezměte LED kryt osvětlení do obou rukou a stáhněte jej dolů



-  LED kryt osvětlení je sejmutý.



2. Zatáhněte a odstraňte LED osvětlení



3. Vytáhněte svorku





-  LED osvětlení je vyjmuté.

4.7.2 Montáž LED osvětlení

- ▶ Montáž proveďte v opačném sledu.

Tip til reparation - Køle-/ frysekombination

 Om dette dokument	48
1.1 Vigtig information.....	48
1.1.1 Formål.....	48
1.2 Forklaring af symboler	48
1.2.1 Fareniveauer	48
1.2.2 Faresymboler.....	48
1.2.3 Advarslernes opbygning	49
1.2.4 Generelle symboler	49
 Sikkerhed	50
2.1 Generelle sikkerhedsanvisninger	50
2.1.1 Alle husholdningsapparater	50
 Værktøjer og hjælpemidler	51
 Reparation	52
4.1 Udskiftning af dørpakning.....	52
4.1.1 Fjernelse af dørpakning.....	52
4.1.2 Montering af dørpakning.....	52
4.2 Udskiftning af dørhåndtag	55
4.2.1 Fjernelse af dørhåndtag	55
4.2.2 Montering af dørhåndtag	55
4.3 Udskiftning af hylde	56
4.3.1 Fjernelse af hylde.....	56
4.3.2 Montering af hylde	56
4.4 Udskiftning af flaskehylde.....	57
4.4.1 Fjernelse af flaskehylde.....	57
4.4.2 Montering af flaskehylde.....	57
4.5 Udskiftning af dørhylde	58
4.5.1 Fjernelse af dørhylde.....	58
4.5.2 Montering af dørhylde	58
4.6 Udskiftning af beholdere	59
4.6.1 Fjernelse af beholdere.....	59
4.6.2 Montering af beholdere.....	59
4.7 Udskiftning af LED-lampe.....	60
4.7.1 Fjernelse af LED-lampe.....	60
4.7.2 Montering af LED-lampe.....	61

i Om dette dokument

1.1 Vigtig information

1.1.1 Formål

Disse reparationsanvisninger hjælper kunden til selv at kunne reparere apparater i henhold til den gældende lovgivning om miljøvenligt design (fra 03/2021).





De indeholder information om, hvordan der udskiftes bestemte reservedele, herunder advarsler og risici.

Kontakt kundeservice i tilfælde af spørgsmål. Vi påtager os kun ansvar for skader, hvis reparationsanvisningerne er fuldt korrekt.

1.2 Forklaring af symboler

1.2.1 Fareniveauer

Advarselsniveauerne består af et symbol og et signalford. Signalfordene indikerer farens alvor.





Advarselsniveau	Betydning
	Manglende overholdelse af advarselsmeddelelsen vil medføre død eller alvorlige kvæstelser.
	Manglende overholdelse af advarselsmeddelelsen kan medføre død eller alvorlige kvæstelser.
	Manglende overholdelse af advarselsmeddelelsen kan medføre mindre kvæstelser.
	Manglende overholdelse af advarselsmeddelelsen kan medføre materiel beskadigelse.

Tabel 1: Fareniveauer





1.2.2 Faresymboler

Faresymboler er symbolske visninger, der giver en indikation af faretypen.

Der anvendes følgende faresymboler i dette dokument:

Faresymbol	Betydning
	Generel advarselsmeddelelse
	Fare for elektrisk spænding
	Eksplussionsfare
	Fare for at skære sig

i Om dette dokument

Faresymbol	Betydning
	Fare for klemning
	Fare pga. varme overflader
	Fare pga. kraftigt magnetfelt
	Fare pga. ikke-ioniserende stråling

Tabel 2: Faresymboler

1.2.3 Advarslernes opbygning

Advarsler i dette dokument har et standardiseret udseende og en standardiseret opbygning.

	<div style="background-color: red; color: white; padding: 2px; text-align: center;">FARE</div> <p>Farens type og kilde! Mulige følger, hvis faren/advarslen ignoreres.</p> <ul style="list-style-type: none"> ▶ Foranstaltninger og forbud for at forhindre faren.
----------------------------------------------------------------------------------	-----------------------------------------------------------------------------------------------------------------------------------------------------------------------------------------------------------------------------------------------------------------------------------------------------

De følgende eksempler viser en advarsel, der advarer mod elektrisk stød pga. spændingsførende dele. Foranstaltningen til at undgå faren er nævnt.

	<div style="background-color: red; color: white; padding: 2px; text-align: center;">FARE</div> <p>Fare for elektrisk stød pga. spændingsførende dele! Død ved elektrisk stød</p> <ul style="list-style-type: none"> ▶ Afbryd apparater fra strømforsyningen i mindst 60 sekunder, før reparationer påbegyndes.
------------------------------------------------------------------------------------	-------------------------------------------------------------------------------------------------------------------------------------------------------------------------------------------------------------------------------------------------------------------------------------------------------------------------------------------------

1.2.4 Generelle symboler

Der anvendes følgende generelle symboler i dette dokument:

Generelt symbol	Betydning
	Angivelse af et særligt tip (tekst og/eller grafik)
	Angivelse af et simpelt tip (kun tekst)
	Angivelse af et link til en videotutorial
	Angivelse af nødvendige værktøjer
	Angivelse af krævede forudsætninger
	Angivelse af en betingelse (hvis..., så...)
	Angivelse af et resultat
	Angivelse af en tast eller knap
	Angivelse af et materialenummer
	Angivelse af en vist tekst/et vist vindue (i apparatets display)

Tabel 3: Generelle symboler

2.1 Generelle sikkerhedsanvisninger

2.1.1 Alle husholdningsapparater

Fare for elektrisk stød pga. spændingsførende dele!

- Fejl i forbindelse med reparationer, der involverer elektriske komponenter, kan medføre elektrisk stød!
- Afbryd apparatet fra strømmenet i mindst 60 sekunder, før arbejdet påbegyndes.
- Få efter reparationen udført en sikkerhedstest i henhold til VDE 0701 eller landespecifikke forskrifter.

Fare for tilskadekomst pga. skarpe kanter!

- Brug beskyttelseshandsker.

Fare for klemning i forbindelse med reparation, vedligeholdelse, fejlafhjælpning og service på grund af tunge og bevægelige komponenter

- Brug sikkerhedssko.
- Sørg for at sikre tunge komponenter mod at falde ned.
- Stik kropsdele ind i bevægelige komponenter.



Fare for apparatets sikkerhed/funktion!

- Brug kun originale reservedele.

Fare for beskadigelse af elektrostatisk følsomme komponenter (elektrostatiske afladninger)!

- Berør ikke modulerne, herunder forbindelser og ledningsbaner.

Værktøjer og hjælpemidler

Betegnelse	Detaljer	Billeder
Beskyttelsesklud [00342013]	60 cm x 50 cm	
Unbrakonøgler [00340819]	2 mm, 2,5 mm, 3 mm, 4 mm, 5 mm, 6 mm, 8 mm	

4.1 Udskiftning af dørpakning

Preindstilling:

- ✔ Døren er åben.

4.1.1 Fjernelse af dørpakning

1. Frigør dørpakningen fra rillen i højre og venstre hjørne.

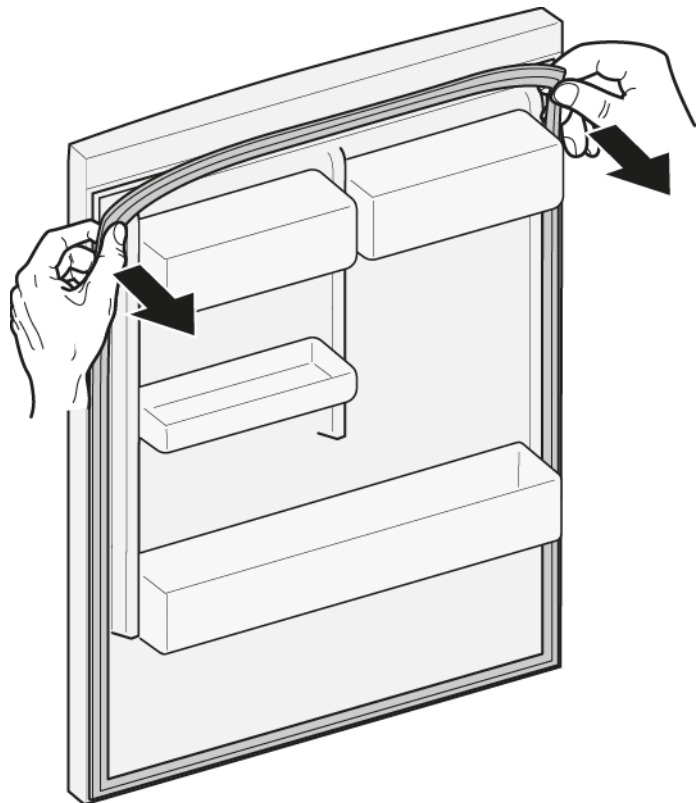

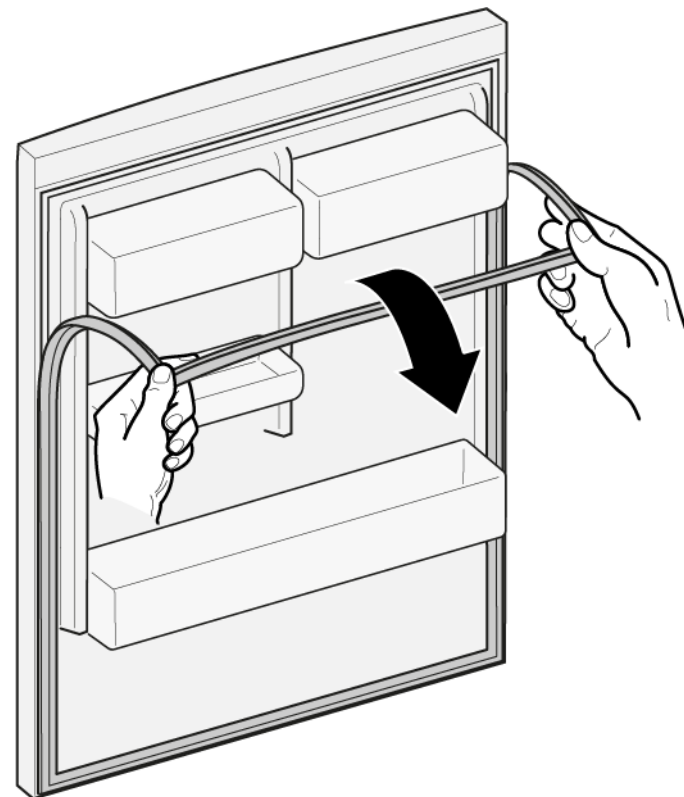

2. Træk dørpakningen ud af rillen.



- ➡ Dørpakningen er fjernet.

4.1.2 Montering af dørpakning

	Tykkelsen af den nye dørpakning kan afvige en smule fra tykkelsen af den gamle dørpakning. Dette vil ikke påvirke lukkemåden og den langsigtede funktion.
	Hvis apparatet har justerbare hængsler eller hængselbeslag, kan lukkemåden efterfølgende optimeres.
	Små sidehuller i dørpakningen er funktionelle (nødvendige til lufttilførelse). De er ikke produktionsfejl.

Reparation

1. Kontrollér rillen til pakningen med hensyn til beskadigelse.

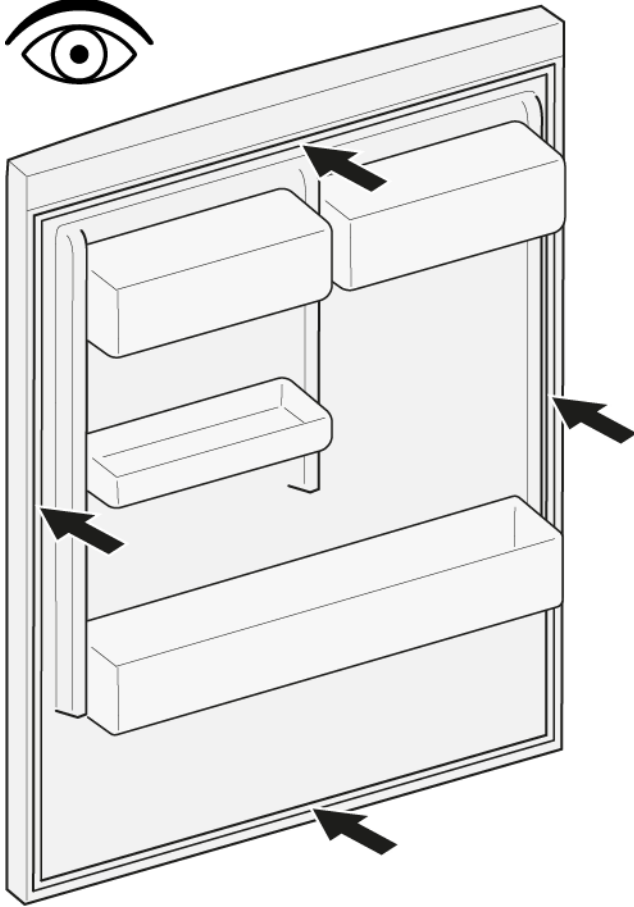

4. Tryk pakningens hjørner i rillen foroven og forneden.

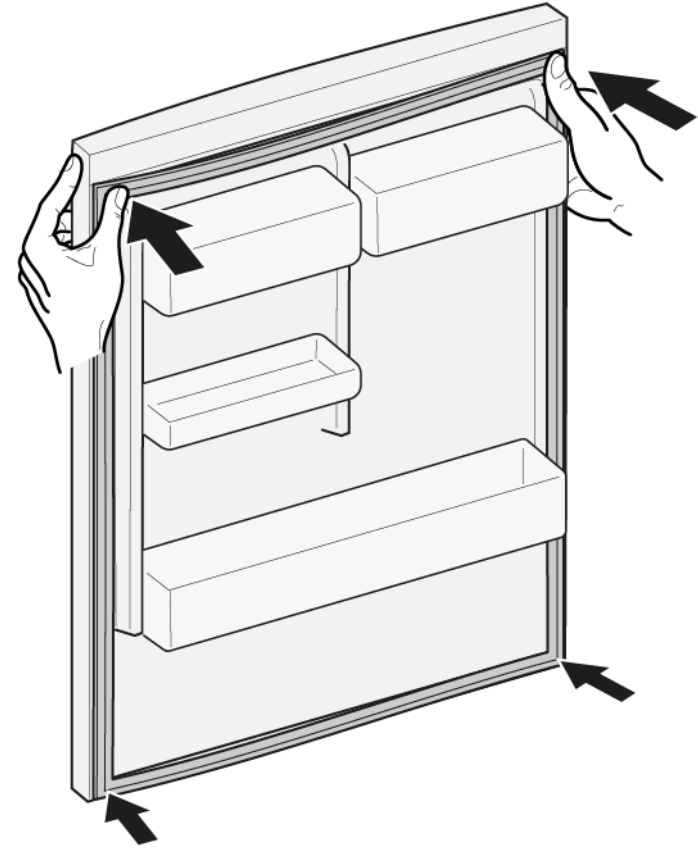

2.  Hvis rillen til pakningen er beskadiget:
 - Kontakt kundeservice.

3.  En smule deformation på dørpakningen er normalt og påvirker ikke dens funktion. Det anbefales til at glatte dørpakningen, før den sættes i apparatet.

Opvarm dørpakningen med en hårtørrer eller varmt vand, og genform den manuelt.

Reparation

5. Tryk hele pakningen trinvist i rillen.

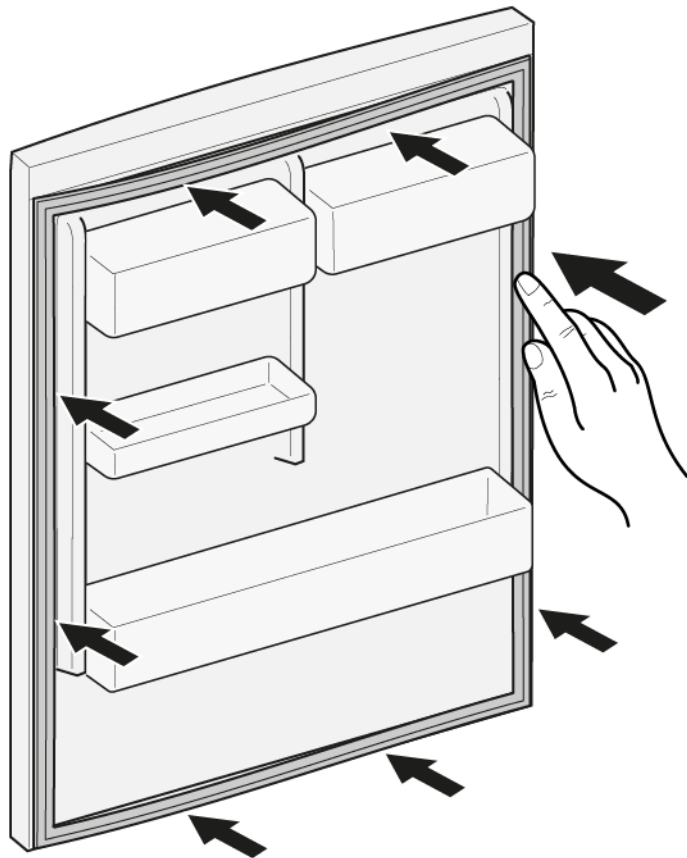



 Dørpakningen er monteret.

4.2 Udskiftning af dørhåndtag

Nødvendig værktøj:

 Unbrakonøgler 2 mm, 2,5 mm, 3 mm, 4 mm, 5 mm, 6 mm, 8 mm [00340819]

Preindstilling:

-  Apparatet er afbrudt fra strømforsyningen.
-  Døren er åben.

4.2.1 Fjernelse af dørhåndtag

1. 1. Skru de to skruer ud (1).
2. 2. Fjern dørhåndtaget (2).

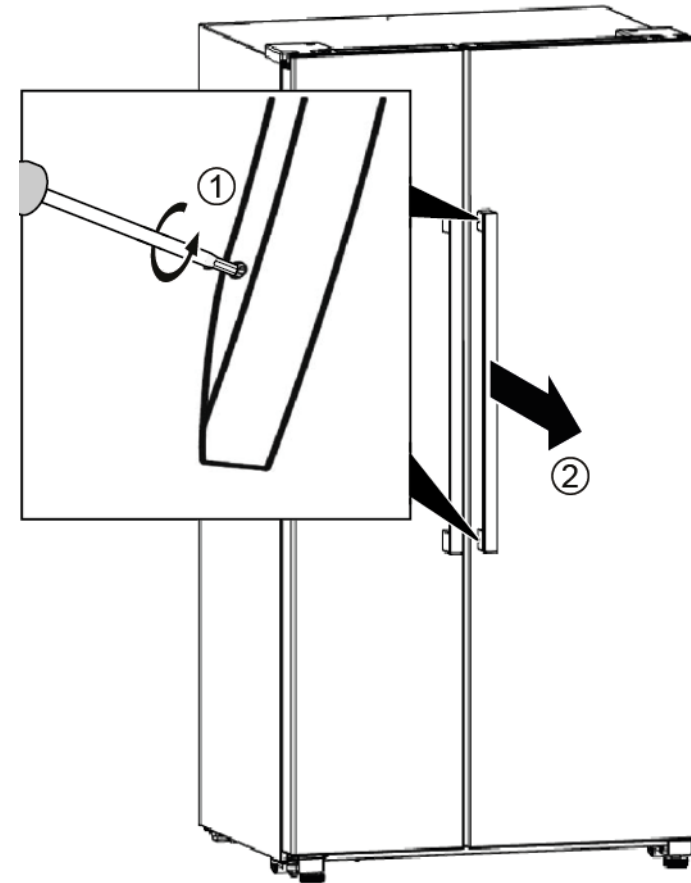

 Dørhåndtaget er fjernet.

2. Fjern det andet dørhåndtag på samme måde.

4.2.2 Montering af dørhåndtag

- ▶ Montér i omvendt rækkefølge.

4.3 Udskiftning af hylde

Preindstilling:

- ✔ Døren er åben.

4.3.1 Fjernelse af hylde

- ▶ Træk hylde ud.

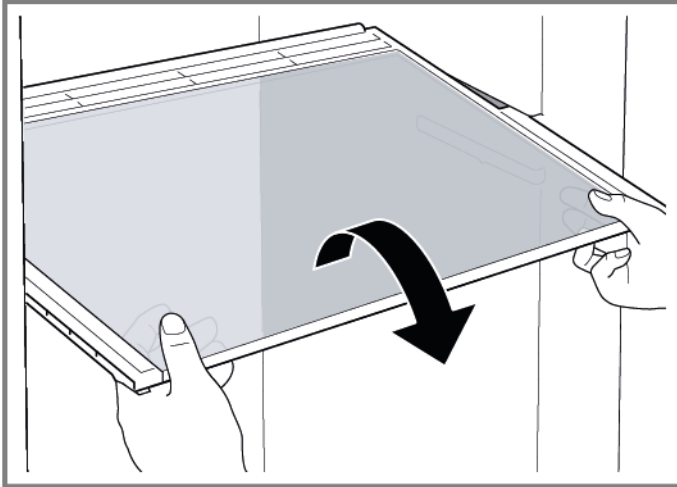

- ➡ Hylde er fjernet.

4.3.2 Montering af hylde

- ▶ Montér i omvendt rækkefølge.

4.4 Udskiftning af flaskehylde

Preindstilling:

- ✔ Døren er åben.

4.4.1 Fjernelse af flaskehylde

- ▶ Træk flaskehylde ud.

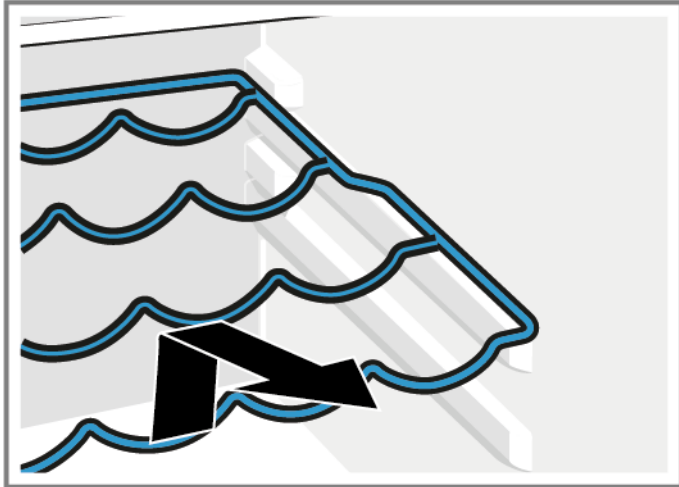

- ➡ Flaskehylde er fjernet.

4.4.2 Montering af flaskehylde

- ▶ Montér i omvendt rækkefølge.

4.5 Udskiftning af dørhylde

Preindstilling:

- ✔ Døren er åben.

4.5.1 Fjernelse af dørhylde

- ▶ Løft dørhylden opad.

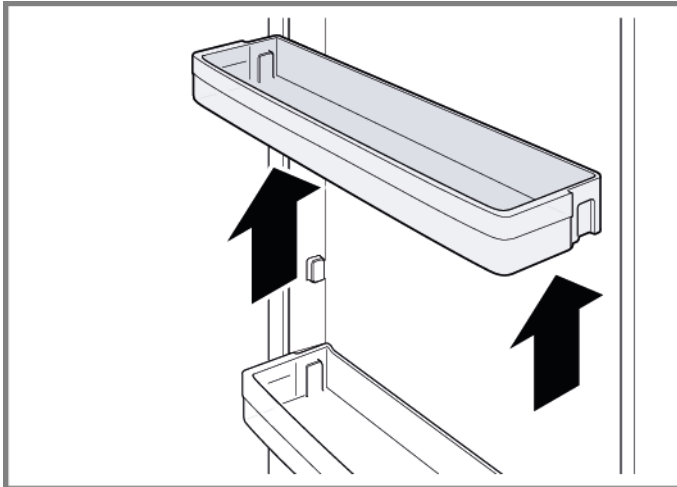

➡ Dørhylden er fjernet.

4.5.2 Montering af dørhylde

- ▶ Montér i omvendt rækkefølge.

4.6 Udskiftning af beholdere

Preindstilling:

- ✔ Døren er åben.

4.6.1 Fjernelse af beholdere

- ▶ Træk beholderen hele vejen ud, løft for at frigøre den fra holderen, og tag den ud.

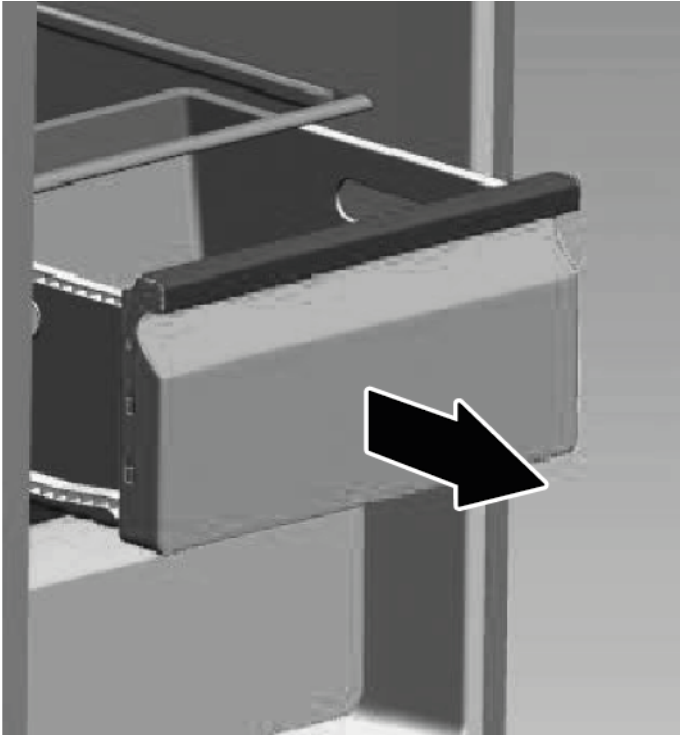

- ➡ Beholderen er fjernet.

4.6.2 Montering af beholdere

- ▶ Montér i omvendt rækkefølge.

4.7 Udskiftning af LED-lampe

	Dit apparat er udstyret med en vedligeholdelsesfri LED-lampe. Denne lampe må kun repareres af kundeservice eller autoriserede teknikere!
-----------------------------------------------------------------------------------	------------------------------------------------------------------------------------------------------------------------------------------

	⚠️ FARE Fare for elektrisk stød pga. spændingsførende dele! Livsfare pga. elektrisk stød i tilfælde af ukorrekt reparation <ul style="list-style-type: none">▶ Elektriske dele skal repareres af kvalificerede elektrikere.▶ Få efter reparationen udført en sikkerhedstest i henhold til VDE 0701 eller landespecifikke forskrifter.
----------------------------------------------------------------------------------	----------------------------------------------------------------------------------------------------------------------------------------------------------------------------------------------------------------------------------------------------------------------------------------------------------------------------------------------------------------------------------

	⚠️ PAS PÅ! Skarpe kanter! Snitlæsioner <ul style="list-style-type: none">▶ Brug beskyttelseshandsker.
----------------------------------------------------------------------------------	-----------------------------------------------------------------------------------------------------------------------------------------

Preindstilling:

- ✔️ Apparatet er afbrudt fra strømforsyningen.
- ✔️ Døren er åben.
- ✔️ Den øverste hylde er fjernet.

4.7.1 Fjernelse af LED-lampe

1. Tag fat i LED-lampens afdækning med to hænder, og træk den ned.



- ➡️ LED-lampens afdækning er fjernet.



2. Træk og tag LED-lampen ud.



3. Afbryd tilslutningen.







- ➡️ LED-lampen er fjernet.

4.7.2 Montering af LED-lampe

- ▶ Montér i omvendt rækkefølge.

Reparatie informatie - Koelvriescombinatie

 Over dit document	63
1.1 Belangrijke informatie	63
1.1.1 Doel	63
1.2 Verklaring van symbolen	63
1.2.1 Gevarenniveaus.....	63
1.2.2 Gevarensymbolen.....	63
1.2.3 Structuur van de waarschuwingen.....	64
1.2.4 Algemene symbolen.....	64
 Veiligheid	65
2.1 Algemene veiligheidsinstructies.....	65
2.1.1 Alle huishoudelijke apparaten	65
 Gereedschappen en hulpmiddelen	66
 Reparatie	67
4.1 Deurafdichting vervangen	67
4.1.1 Deurafdichting verwijderen	67
4.1.2 Deurafdichting monteren	67
4.2 Deurgreep vervangen	70
4.2.1 Deurgreep verwijderen	70
4.2.2 Deurgreep monteren	70
4.3 Plateau vervangen.....	71
4.3.1 Plateau verwijderen.....	71
4.3.2 Plateau monteren.....	71
4.4 Flessenrek vervangen.....	72
4.4.1 Flessenrek verwijderen.....	72
4.4.2 Flessenrek monteren.....	72
4.5 Deurrek vervangen	73
4.5.1 Deurrek verwijderen	73
4.5.2 Deurrek monteren	73
4.6 Lades vervangen.....	74
4.6.1 Lades verwijderen	74
4.6.2 Lades installeren.....	74
4.7 LED-lamp vervangen	75
4.7.1 LED-lamp verwijderen	75
4.7.2 LED-lamp monteren	76

i Over dit document

1.1 Belangrijke informatie

1.1.1 Doel

Met deze reparatieaanwijzingen wordt de klant geholpen zelf apparaten te repareren conform de toepasselijke verordening inzake ecologisch ontwerp (met ingang van 03/2021).





Ze bevatten informatie over hoe gedefinieerde reserveonderdelen kunnen worden vervangen met inbegrip van waarschuwingen en gevaren.

Neem bij vragen contact op met onze klantenservice. We stellen ons alleen aansprakelijk voor schade als de reparatieaanwijzingen correct zijn opgevolgd.

1.2 Verklaring van symbolen

1.2.1 Gevarenniveaus

De waarschuwningsniveaus worden aangegeven met een symbool en een signaalwoord. Het signaalwoord geeft de ernst van het gevaar aan.





Waarschuwningsniveau	Betekenis
	Als de waarschuwing niet in acht wordt genomen, leidt dat tot ernstig of dodelijk letsel.
	Als de waarschuwing niet in acht wordt genomen, kan dat tot ernstig of dodelijk letsel leiden.
	Als de waarschuwing niet in acht wordt genomen, kan dat tot licht letsel leiden.
	Als de waarschuwing niet in acht wordt genomen, kan dat tot materiële schade leiden.

Tabel 1: Gevarenniveaus

1.2.2 Gevarensymbolen

Gevarensymbolen zijn symbolische afbeeldingen die een indicatie geven van het soort gevaar.

De volgende gevarensymbolen worden in dit document gebruikt:

Gevarensymbool	Betekenis
	Algemene waarschuwing
	Gevaar voor elektrische spanning
	Ontploffingsgevaar
	Snijgevaar

i Over dit document

Gevarensymbool	Betekenis
	Beknellingsgevaar
	Gevaar voor hete oppervlakken
	Gevaar voor sterke magnetische velden
	Gevaar voor niet-ioniserende straling

Tabel 2: Gevarensymbolen

1.2.3 Structuur van de waarschuwingen

Waarschuwingen in dit document hebben een gestandaardiseerd uiterlijk en een gestandaardiseerde structuur.







	<p>⚠ GEVAAR</p> <p>Soort gevaar en bron van het gevaar! Mogelijke gevolgen van het negeren van het gevaar / de waarschuwing.</p> <ul style="list-style-type: none"> ▶ Maatregelen en verboden om het gevaar te voorkomen.
----------------------------------------------------------------------------------	------------------------------------------------------------------------------------------------------------------------------------------------------------------------------------------------------------------------------------------------------------

In het volgende voorbeeld is een waarschuwing te zien waarmee voor een elektrische schok aan stroomvoerende onderdelen wordt gewaarschuwd. De maatregel om het gevaar te vermijden wordt vermeld.

	<p>⚠ GEVAAR</p> <p>Gevaar voor een elektrische schok aan stroomvoerende onderdelen! Dood door elektrocutie</p> <ul style="list-style-type: none"> ▶ Haal apparaten minstens 60 seconden voor u met reparaties begint van de stroomvoorziening af.
------------------------------------------------------------------------------------	------------------------------------------------------------------------------------------------------------------------------------------------------------------------------------------------------------------------------------------------------------------------------------

1.2.4 Algemene symbolen

De volgende algemene symbolen worden in dit document gebruikt:

Alg. symbool	Betekenis
	Identificatie van een speciale tip (tekst en/of afbeelding)
	Identificatie van een eenvoudige tip (tekst)
	Identificatie van een link naar een video-instructie
	Identificatie van vereiste gereedschappen
	Identificatie van vereiste voorwaarden
	Identificatie van een voorwaarde (als ..., dan ...)
	Identificatie van een resultaat
[Start]	Identificatie van een toets of knop
[00123456]	Identificatie van een materiaalnummer
Status	Identificatie van weergegeven tekst / venster (in het display van het apparaat)

Tabel 3: Algemene symbolen

2.1 Algemene veiligheidsinstructies

2.1.1 Alle huishoudelijke apparaten

Gevaar voor een elektrische schok aan stroomvoerende onderdelen!

- Fouten bij reparaties aan elektrische componenten kunnen tot een elektrische schok leiden!
- Koppel het apparaat minstens 60 seconden los van het stroomnet voordat u met de werkzaamheden begint.
- Laat na de reparatie een veiligheidstest conform VDE 0701 of de landspecifieke regelgeving uitvoeren.

Gevaar voor letsel aan scherpe randen!

- Draag veiligheidshandschoenen.

Beknellingsgevaar tijdens reparatie, onderhoud, probleemoplossing en service vanwege zware en bewegende componenten

- Draag veiligheidsschoenen.
- Beveilig zware componenten tegen vallen.
- Steek geen lichaamsdelen in bewegende componenten.



Gevaar voor de veiligheid / werking van het apparaat!

- Gebruik uitsluitend originele reserveonderdelen.

Gevaar voor schade aan elektrostatisch gevoelige componenten (ESD's)!

- Raak de modules met inbegrip van de aansluitingen en geleiderbanen niet aan.

Gereedschappen en hulpmiddelen

Benaming	Details	Afbeeldingen
Beschermdoek [00342013]	60 cm x 50 cm	
Inbusleutels [00340819]	2 mm, 2,5 mm, 3 mm, 4 mm, 5 mm, 6 mm, 8 mm	

4.1 Deurafdichting vervangen

Voorwaarde:

- ✔ Deur is open.

4.1.1 Deurafdichting verwijderen

1. Haal deurafdichting los uit de sleuf in de rechter- en linkerhoek.

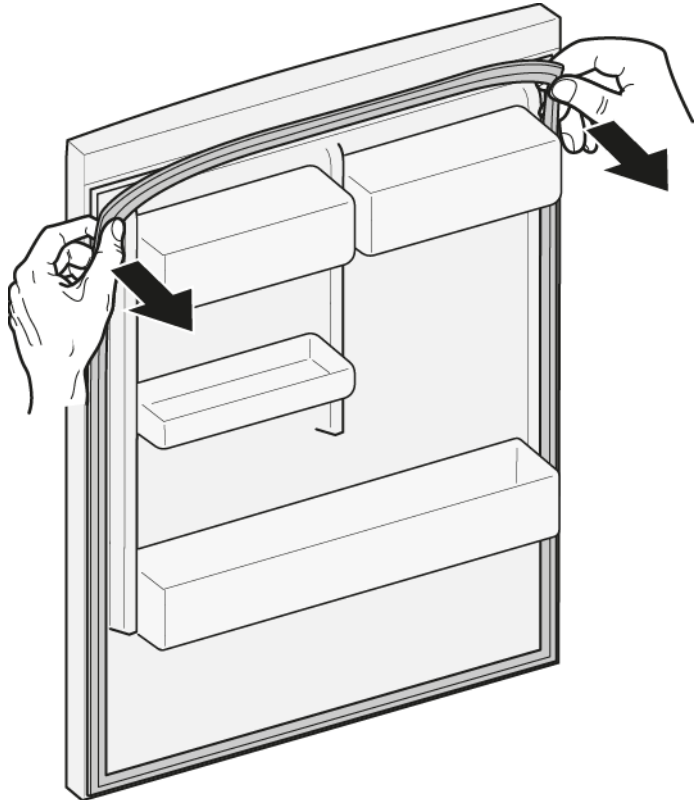

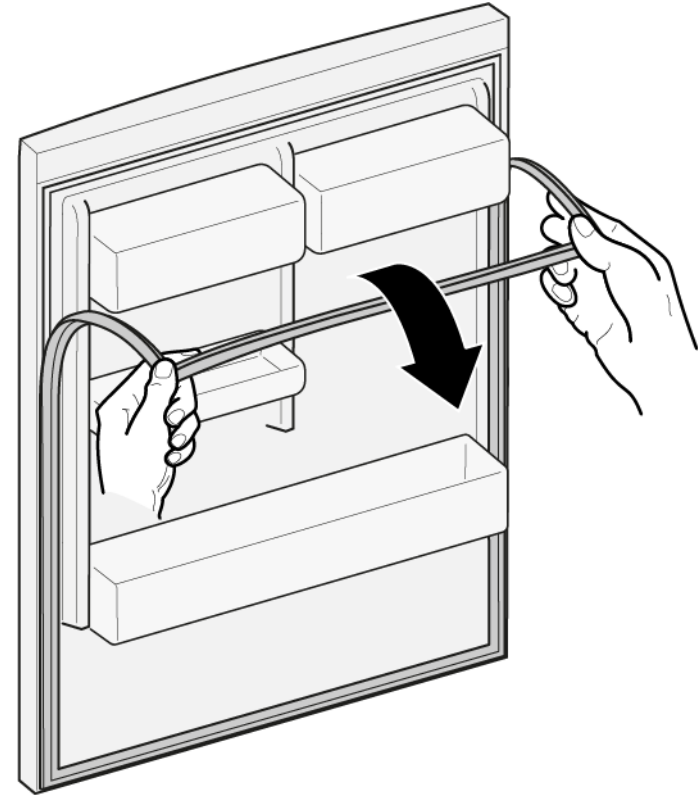

2. Trek deurafdichting uit gleuf.



- ➡ Deurafdichting wordt verwijderd.

4.1.2 Deurafdichting monteren

	De dikte van de nieuwe deurafdichting kan licht afwijken van de dikte van de oude deurafdichting. Dit doet geen afbreuk aan de sluiteigenschappen en de werking op de lange termijn.
	Als uw apparaat verstelbare scharnieren of scharnierbevestigingen heeft, kunt u de sluiteigenschappen later optimaliseren.
	De zijgaatjes in de deurafdichting zijn functioneel (vereist voor ventilatie). Dit zijn geen productiefouten.

Reparatie

1. Controleer de sleuf voor de afdichting op schade.

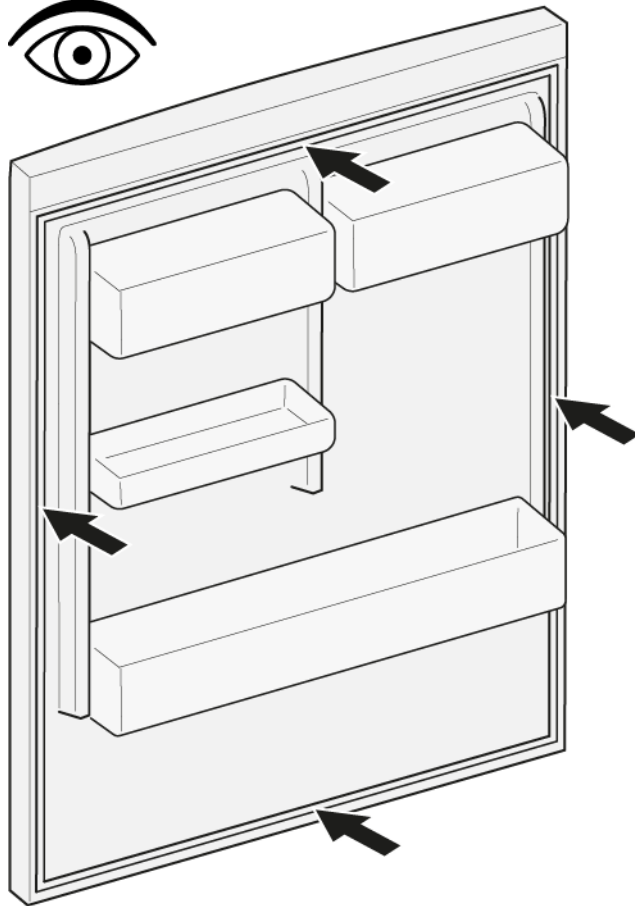

4. Duw de hoeken van de afdichting bovenaan en onderaan in de sleuf.

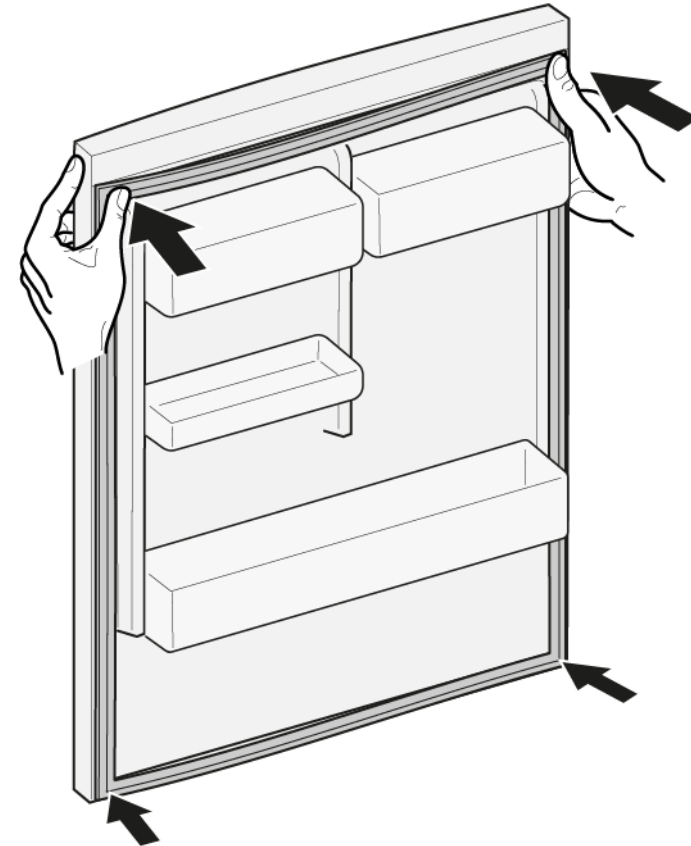

2.  Als de sleuf voor de afdichting is beschadigd:
 - Neem contact op met de klantenservice.

3.  Een lichte vervorming van de deurafdichting is normaal en doet geen afbreuk aan de werking. Geadviseerd wordt de deurafdichting recht te trekken voordat u deze in het apparaat steekt.

Verwarm de deurafdichting met een haardroger of met warm water en breng het handmatig terug in zijn vorm.

Reparatie

5. Druk de hele afdichting stap voor stap in de sleuf.

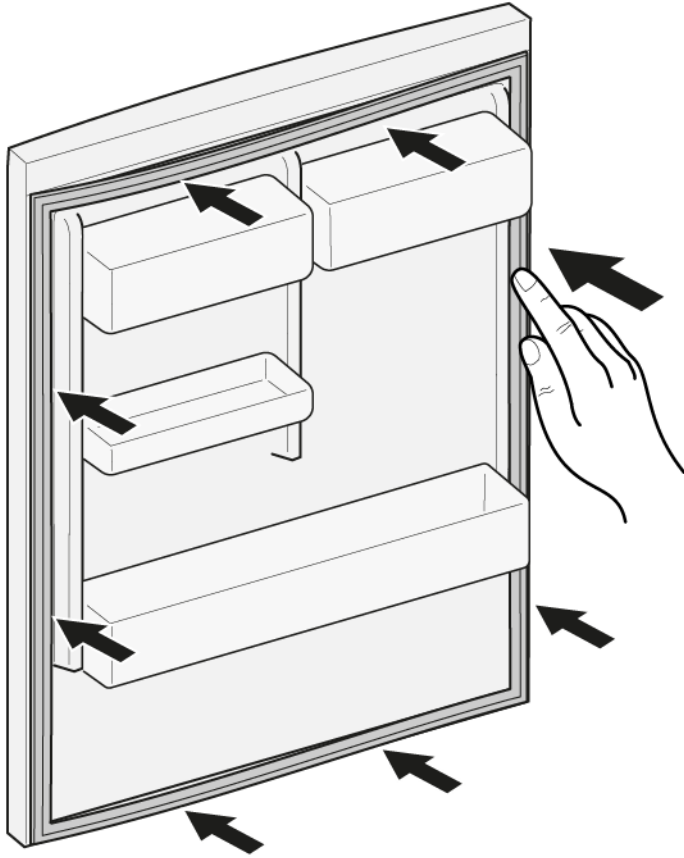



 De deurafdichting wordt gemonteerd.

4.2 Deurgreep vervangen

Speciale hulpmiddelen:

 Inbussleutels 2 mm, 2,5 mm, 3 mm, 4 mm, 5 mm, [00340819]
6 mm, 8 mm

Voorwaarde:

-  Apparaat is losgekoppeld is van de stroomvoorziening.
-  Deur is open.

4.2.1 Deurgreep verwijderen

1. 1. Draai de twee schroeven los (1).
2. 2. Verwijder de deurgreep (2).

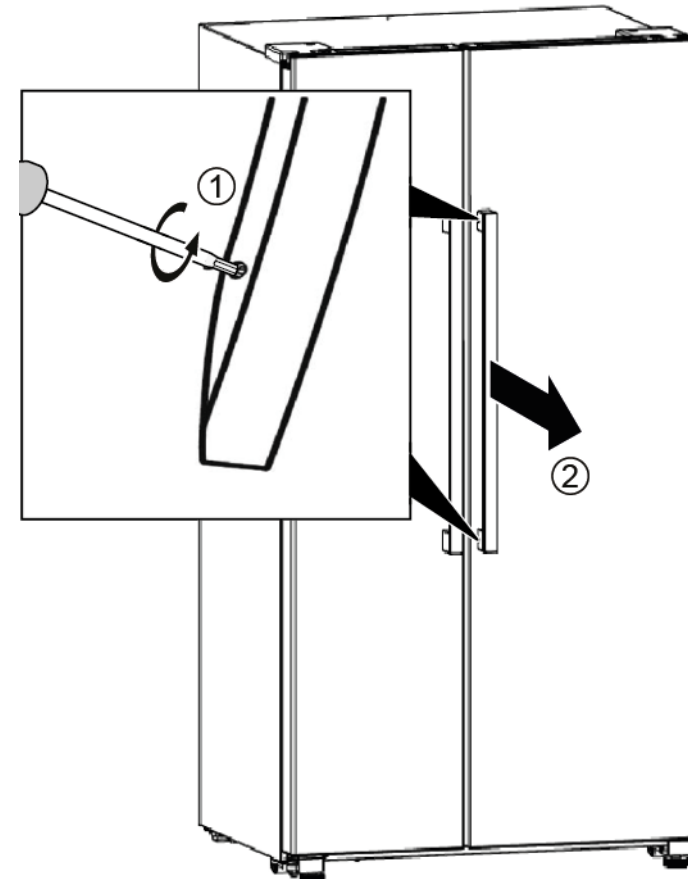

 Deurgreep wordt verwijderd.

2. 2. Verwijder de deurgreep van de tweede deur op dezelfde manier.

4.2.2 Deurgreep monteren

- ▶ Monteer in omgekeerde volgorde.

4.3 Plateau vervangen

Voorwaarde:

- ✔ Deur is open.

4.3.1 Plateau verwijderen

- ▶ Trek het plateau eruit.

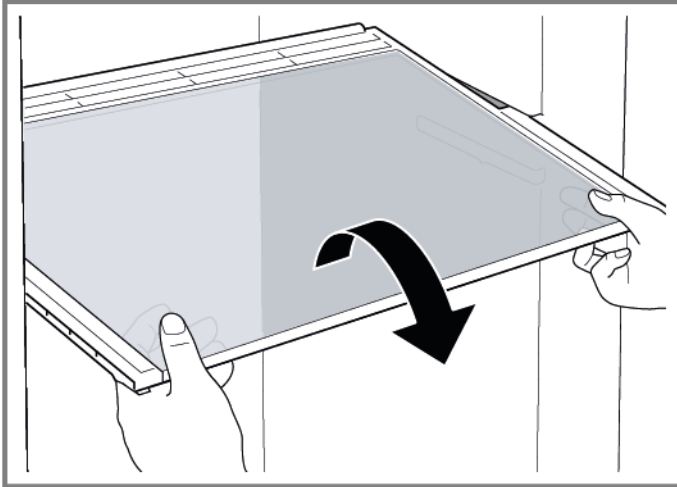

➡ Plateau wordt verwijderd.

4.3.2 Plateau monteren

- ▶ Monteer in omgekeerde volgorde.

4.4 Flessenrek vervangen

Voorwaarde:

- ✔ Deur is open.

4.4.1 Flessenrek verwijderen

- ▶ Trek het flessenrek eruit.

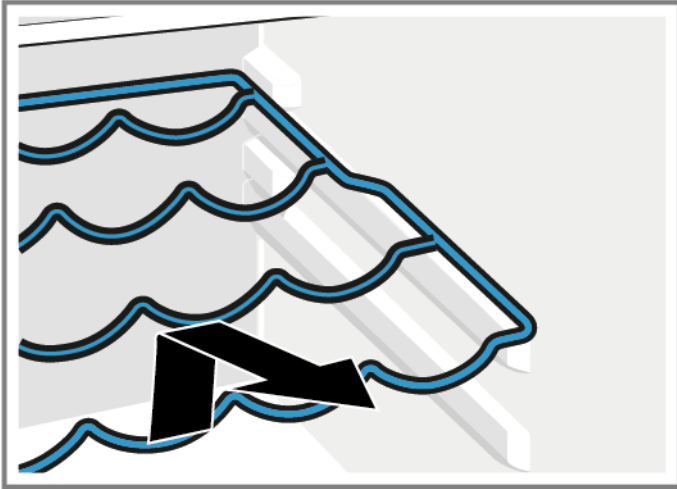

- ➡ Flessenrek wordt verwijderd.

4.4.2 Flessenrek monteren

- ▶ Monteer in omgekeerde volgorde.

4.5 Deurrek vervangen

Voorwaarde:

- ✔ Deur is open.

4.5.1 Deurrek verwijderen

- ▶ Licht het deurrek omhoog.

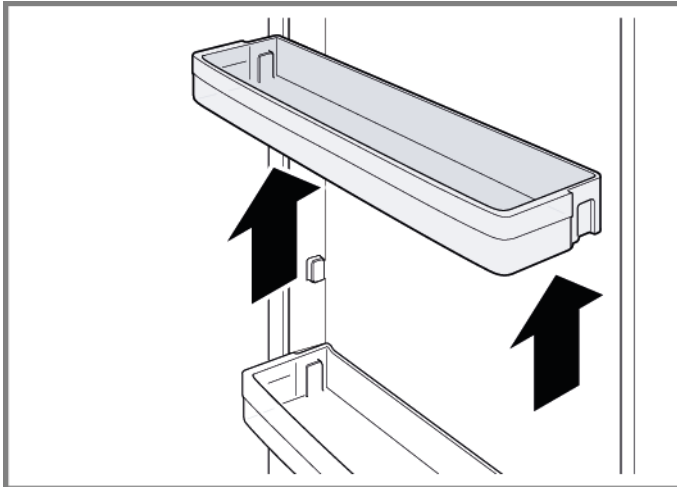

➡ Deurrek wordt verwijderd.

4.5.2 Deurrek monteren

- ▶ Monteer in omgekeerde volgorde.

4.6 Lades vervangen

Voorwaarde:

- ✔ Deur is open.

4.6.1 Lades verwijderen

- ▶ Trek de lade helemaal naar buiten, licht het omhoog om hem los te koppelen van de houder en haal hem eruit.

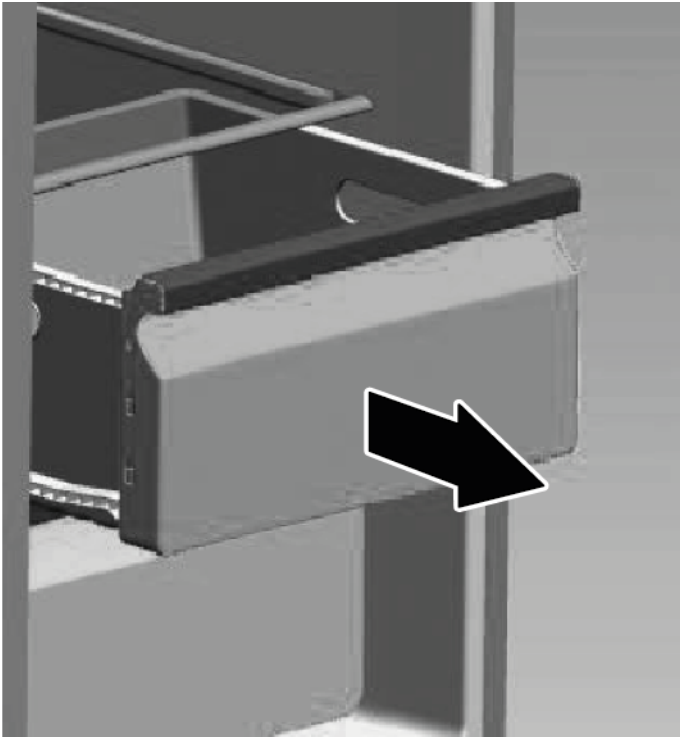

- ➡ Lade wordt verwijderd.

4.6.2 Lades installeren

- ▶ Monteer in omgekeerde volgorde.

4.7 LED-lamp vervangen

	Uw apparaat heeft een onderhoudsvrije LED-verlichting. Deze verlichting mag alleen maar door de klantenservice of geautoriseerde monteurs worden vervangen!
-----------------------------------------------------------------------------------	-------------------------------------------------------------------------------------------------------------------------------------------------------------

	⚠ GEVAAR Gevaar voor een elektrische schok aan stroomvoerende onderdelen! Levensgevaar door elektrische schokken in geval van een ondeskundige reparatie <ul style="list-style-type: none">▶ Elektrische onderdelen moeten door gekwalificeerde elektriciens worden gerepareerd.▶ Laat na de reparatie een veiligheidstest conform VDE 0701 of de landspecifieke regelgeving uitvoeren.
----------------------------------------------------------------------------------	------------------------------------------------------------------------------------------------------------------------------------------------------------------------------------------------------------------------------------------------------------------------------------------------------------------------------------------------------------------------------------------------------------------------------------

	⚠ VOORZICHTIG Scherpe randen! Snijletsel <ul style="list-style-type: none">▶ Draag veiligheidshandschoenen.
----------------------------------------------------------------------------------	-----------------------------------------------------------------------------------------------------------------------------------------------

Voorwaarde:

- ✔ Apparaat is losgekoppeld is van de stroomvoorziening.
- ✔ Deur is open.
- ✔ Het bovenste plateau wordt verwijderd.

4.7.1 LED-lamp verwijderen

1. Pak de LED-lampafdekking met twee handen beet en trek hem omlaag



- ➡ LED-lampafdekking wordt verwijderd.



2. Trek en haal de LED-lamp eruit



3. Haal de klem los.







- ➡ LED-lamp wordt verwijderd.

4.7.2 LED-lamp monteren

- ▶ Monteer in omgekeerde volgorde.

Repair hints - Fridge-freezer

 Concerning this document	78
1.1 Important information	78
1.1.1 Purpose.....	78
1.2 Explanation of symbols	78
1.2.1 Danger levels.....	78
1.2.2 Hazard symbols	78
1.2.3 Structure of the warnings.....	79
1.2.4 General symbols.....	79
 Safety	80
2.1 General Safety instructions	80
2.1.1 All domestic appliances	80
 Tools and aids	81
 Repair	82
4.1 Replacing door gasket	82
4.1.1 Removing door gasket.....	82
4.1.2 Installing door gasket	82
4.2 Replacing door handle	85
4.2.1 Removing door handle	85
4.2.2 Installing door handle	85
4.3 Replacing shelf.....	86
4.3.1 Removing shelf	86
4.3.2 Installing shelf.....	86
4.4 Replacing bottle tray	87
4.4.1 Removing bottle tray	87
4.4.2 Installing bottle tray	87
4.5 Replacing door rack.....	88
4.5.1 Removing door rack	88
4.5.2 Installing door rack.....	88
4.6 Replacing containers	89
4.6.1 Removing containers.....	89
4.6.2 Installing containers	89
4.7 Replacing LED lamp	90
4.7.1 Removing LED lamp	90
4.7.2 Installing LED lamp	91

i Concerning this document

1.1 Important information

1.1.1 Purpose

These repair hints support consumer to repair appliances by himself according to the applicable eco-design regulation (as of 03/2021).

They contain information how to exchange defined spare parts including warnings and risks.

In case of questions, please contact our customer service. We will only be liable for damages if the repair hints have been followed properly.

1.2 Explanation of symbols

1.2.1 Danger levels

The warning levels consist of a symbol and a signal word. The signal word indicates the severity of the danger.









Warning level	Meaning
 Danger	Non-observance of the warning message will result in death or serious injuries.
 Warning	Non-observance of the warning message could result in death or serious injuries.
 Caution	Non-observance of the warning message could result in minor injuries.
Notice	Non-observance of the warning message could result in damage to property.

Table 1: Danger levels

1.2.2 Hazard symbols

Hazard symbols are symbolic representations which give an indication of the kind of danger.

The following hazard symbols are used in this document:

Hazard symbol	Meaning
	General warning message
	Danger from electrical voltage
	Risk of explosion
	Danger of cuts
	Danger of crushing

i Concerning this document



Hazard symbol	Meaning
	Danger from hot surfaces
	Danger from strong magnetic field
	Danger from non-ionizing radiation

Table 2: Hazard symbols

1.2.3 Structure of the warnings

Warnings in this document have a standardised appearance and a standardised structure.



	<div style="background-color: red; color: white; padding: 2px; text-align: center;">⚠ Danger</div> <p>Type and source of danger! Possible consequences of ignoring the danger / warning.</p> <ul style="list-style-type: none"> ▶ Measures and prohibitions for preventing the danger.
----------------------------------------------------------------------------------	-------------------------------------------------------------------------------------------------------------------------------------------------------------------------------------------------------------------------------------------------------------------------------------------------------------------------

The following example shows a warning that warns against electric shock due to live parts. The measure for avoiding the danger is mentioned.

	<div style="background-color: red; color: white; padding: 2px; text-align: center;">⚠ Danger</div> <p>Risk of electric shock due to live parts! Death by electrocution</p> <ul style="list-style-type: none"> ▶ Disconnect appliances from electrical supply at least 60 seconds before starting repairs.
-----------------------------------------------------------------------------------	--------------------------------------------------------------------------------------------------------------------------------------------------------------------------------------------------------------------------------------------------------------------------------------------------------------------------------------------

1.2.4 General symbols

The following general symbols are used in this document:

Gen. symbol	Meaning
	Identification of a special tip (text and/or graphic)
	Identification of a simple tip (only text)
	Identification of a link to a video tutorial





Gen. symbol	Meaning
	Identification of required tools
	Identification of required preconditions
	Identification of a condition (if ..., then ...)
	Identification of a result
[Start]	Identification of a key or button
[00123456]	Identification of a material number
Status	Identification of displayed text / window (in the appliance's display)

Table 3: General symbols

2.1 General Safety instructions

2.1.1 All domestic appliances

Risk of electric shock due to live parts!

- Errors by repairs involving electrical components can lead to electrical shock!
- Disconnect the appliance from the mains for at least 60 seconds before starting work.
- After the repair have a safety test according VDE 0701 or country-specific regulations performed.

Risk of injury from sharp edges!

- Wear protective gloves.

Risk of crushing during repair, maintenance, troubleshooting and service due to heavy and moving components

- Wear protective shoes.
- Secure heavy components from falling down.
- Do not stick body parts into moving components.



Risk to the appliance's safety / function!

- Only use original spare parts.

Risk of damage to electrostatically sensitive components (ESDs)!

- Do not touch the modules, including connections and conductor paths.

Tools and aids

Designation	Details	Images
Protection cloth [00342013]	60 cm x 50 cm	
Hexagon socket wrenches [00340819]	2 mm, 2.5 mm, 3 mm, 4 mm, 5 mm, 6 mm, 8 mm	

4.1 Replacing door gasket

Prerequisite:

- ✔ Door is open.

4.1.1 Removing door gasket

1. Release door gasket from the groove on right and left corner.

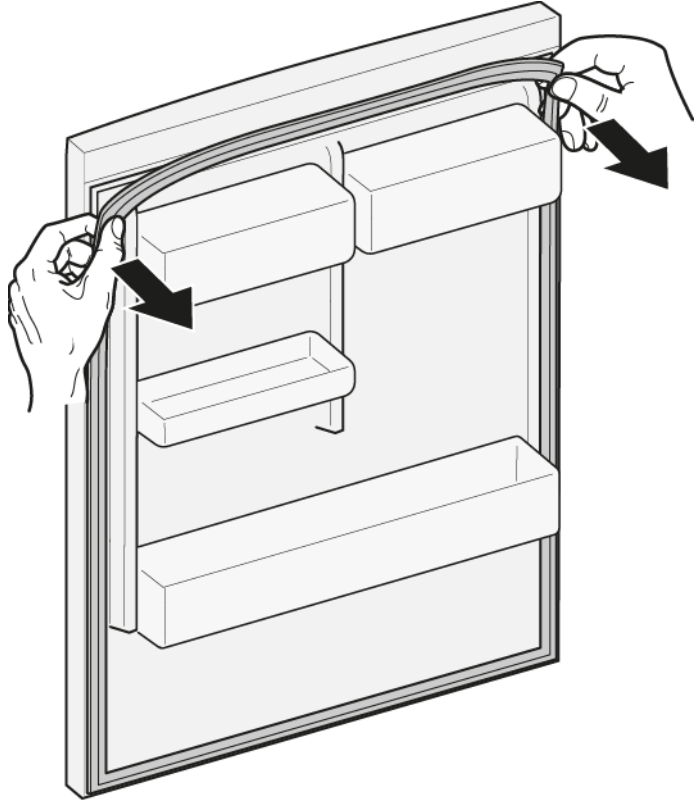

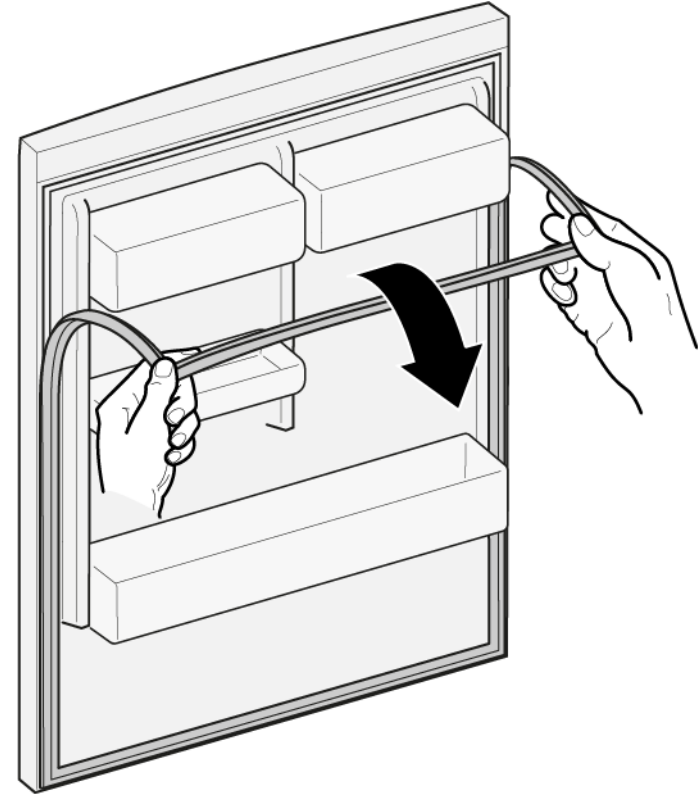

2. Pull out door gasket from groove.



- ➡ Door gasket is removed.

4.1.2 Installing door gasket

	Thickness of new door gasket may deviate slightly from thickness of old door gasket. This will not affect closing behavior and long-term function.
	If your appliance has adjustable hinges or hinge attachments, you can optimize the closing behavior subsequently.
	Small side holes in door gasket are functional (required for ventilation). These are not production faults.

Repair

1. Check groove for gasket for damage.

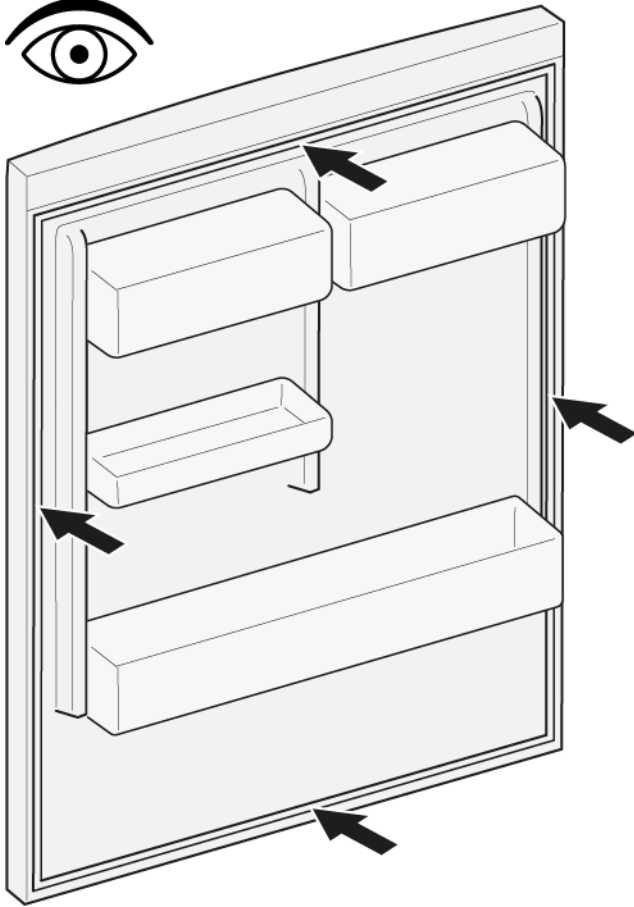

4. Push corners of gasket at the top and bottom to the groove.

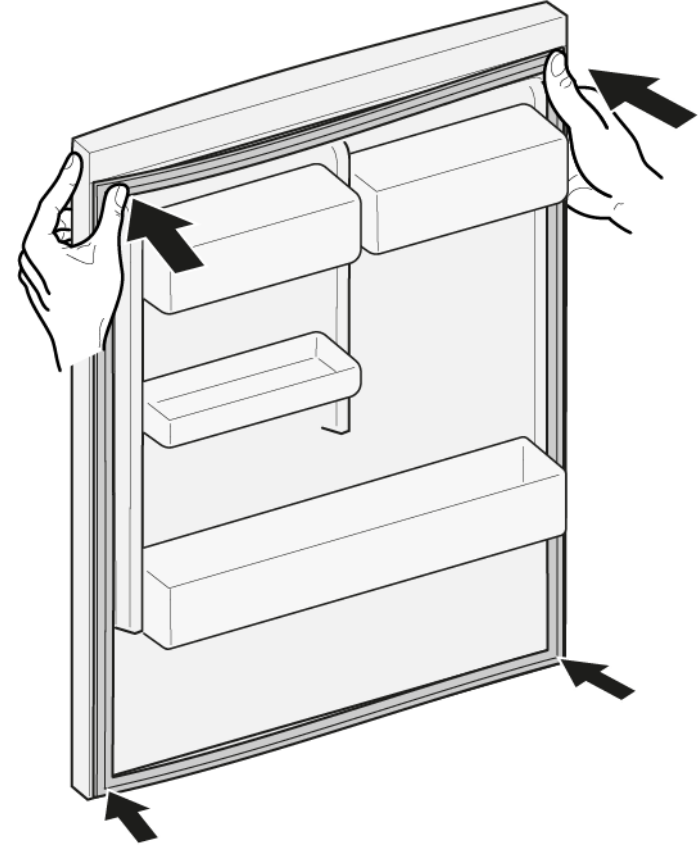

2.  If groove for gasket is it is damaged.
- Contact customer service.

3.  Slight deformation of door gasket is normal and does not affect its function. It is recommended to straighten door gasket before inserting it into appliance.

Heat door gasket with a hair dryer or hot water and manually reshape it.

5. Press whole gasket step by step into the groove.

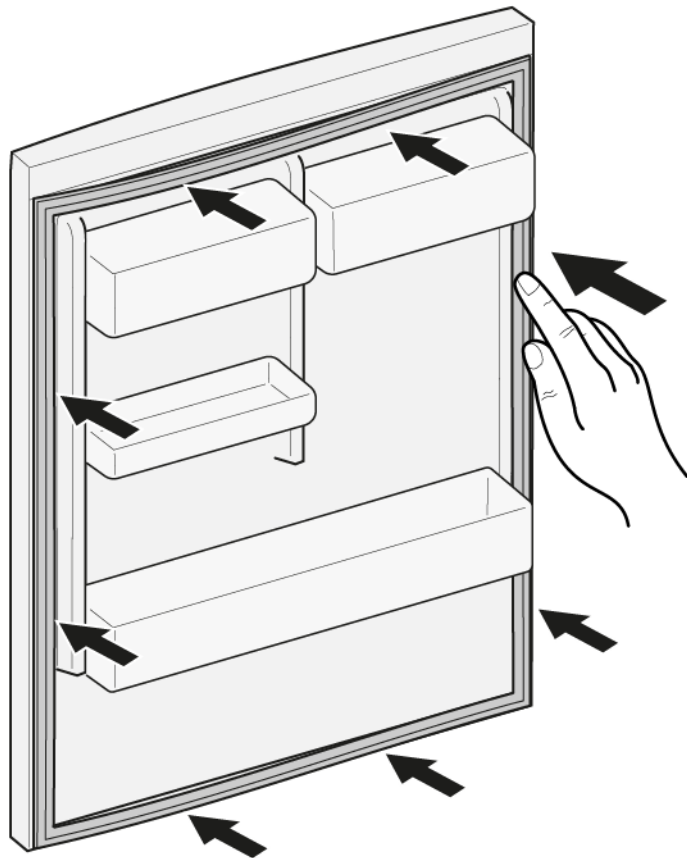



 Door gasket is installed.

4.2 Replacing door handle

Required tools:

-  Hexagon socket wrenches 2 mm, 2.5 mm, 3 mm, 4 mm, 5 mm, 6 mm, 8 mm [00340819]

Prerequisite:

-  Appliance is disconnected from power supply.
-  Door is open.

4.2.1 Removing door handle

1. Unscrew two screws (1).
2. Remove door handle (2).

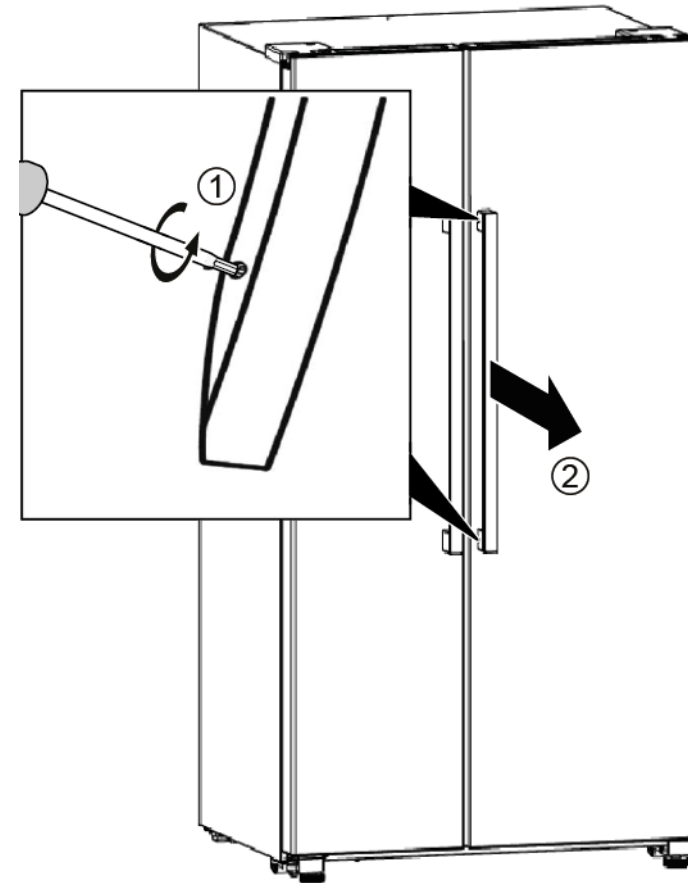

 Door handle is removed.

2. Remove the second door handle in the same manner.

4.2.2 Installing door handle

- ▶ Install in reverse order.

4.3 Replacing shelf

Prerequisite:

- ✔ Door is open.

4.3.1 Removing shelf

- ▶ Pull out shelf.

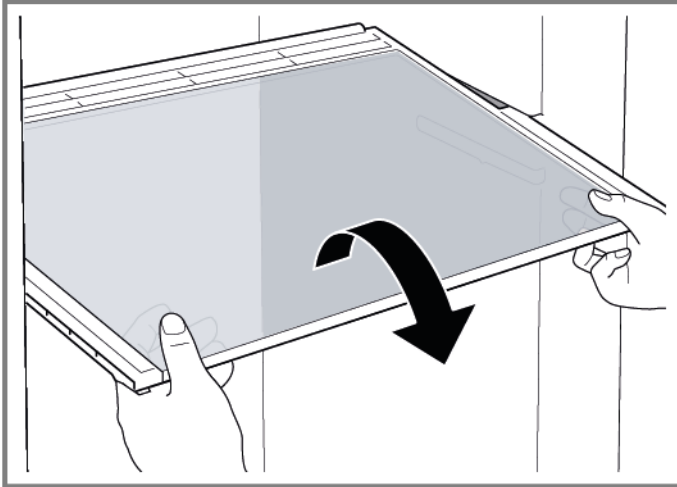

- ➡ Shelf is removed.

4.3.2 Installing shelf

- ▶ Install in reverse order.

4.4 Replacing bottle tray

Prerequisite:

- ✔ Door is open.

4.4.1 Removing bottle tray

- ▶ Pull out bottle tray.

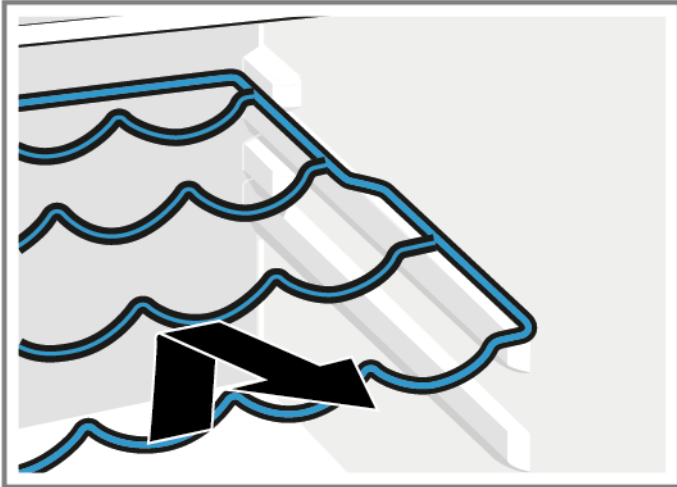

- ➡ Bottle tray is removed.

4.4.2 Installing bottle tray

- ▶ Install in reverse order.

4.5 Replacing door rack

Prerequisite:

- ✔ Door is open.

4.5.1 Removing door rack

- ▶ Lift door rack upwards.

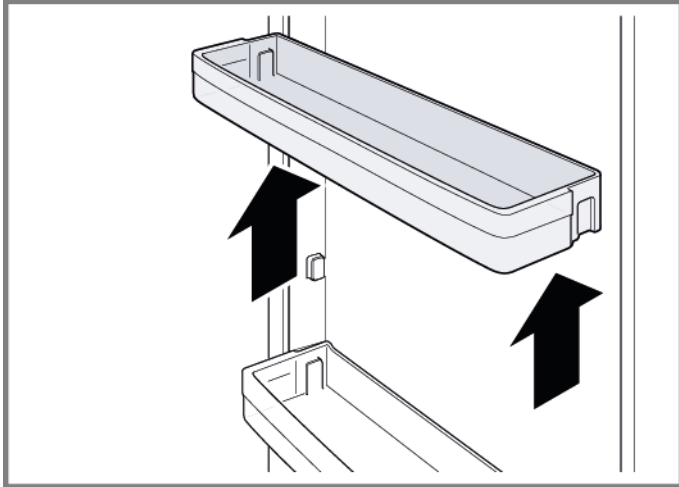

- ➡ Door rack is removed.

4.5.2 Installing door rack

- ▶ Install in reverse order.

4.6 Replacing containers

Prerequisite:

- ✔ Door is open.

4.6.1 Removing containers

- ▶ Pull out container all the way, lift to detach it from the holder and take out.

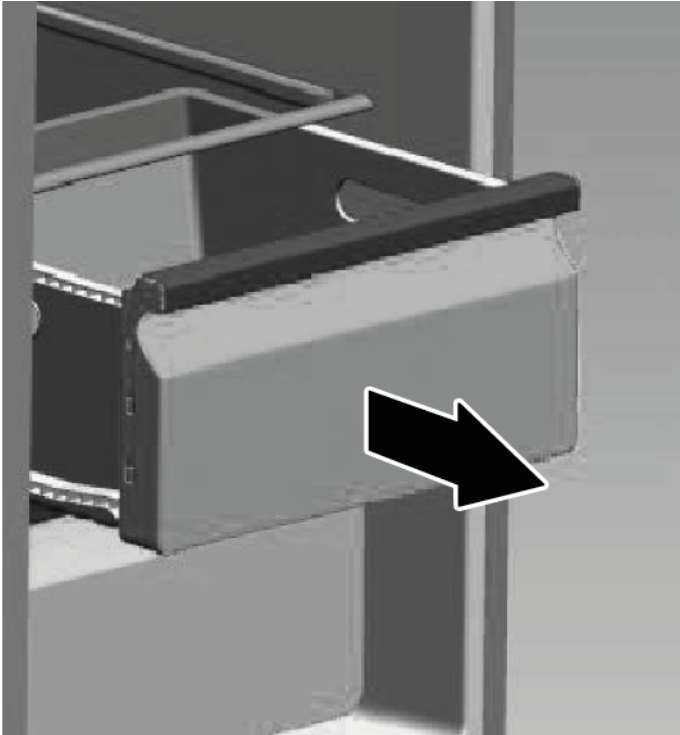



- ➡ Container is removed.

4.6.2 Installing containers

- ▶ Install in reverse order.

4.7 Replacing LED lamp

	Your appliance features a maintenance-free LED light. These lights may be repaired by customer service or authorised technicians only!
-----------------------------------------------------------------------------------	----------------------------------------------------------------------------------------------------------------------------------------

	⚠️ Danger
Risk of electric shock due to live parts! Danger to life through electric shock in case of improper repair	
<ul style="list-style-type: none">▶ Electric parts should be repaired by a qualified electrician.▶ After the repair have a safety test according to VDE 0701 or country-specific regulations performed.	

	⚠️ Caution
Sharp edges! Cut injuries	
<ul style="list-style-type: none">▶ Wear protective gloves.	

Prerequisite:

- ✔️ Appliance is disconnected from power supply.
- ✔️ Door is open.
- ✔️ Upper shelf is removed.

4.7.1 Removing LED lamp

1. Catch the LED lamp cover with two hands and pull down



- ➡️ LED lamp cover is removed.



2. Pull and take the LED lamp out



3. Unplug the terminal



- ➡️ LED lamp is removed.

4.7.2 Installing LED lamp

- ▶ Install in reverse order.

Remonditeave - Kombikülmik

 Selle dokumendiga seoses	93
1.1 Tähtis teave	93
1.1.1 Eesmärk.....	93
1.2 Sümbolite selgitus	93
1.2.1 Ohutasemed.....	93
1.2.2 Ohusümbolid	93
1.2.3 Hoiatuste struktuur.....	94
1.2.4 Üldised sümbolid.....	94
 Ohutus.....	95
2.1 Üldised ohutusjuhised.....	95
2.1.1 Kõik kodumasinad.....	95
 Tööriistad ja abinõud.....	96
 Remont.....	97
4.1 Uksetihendi vahetamine.....	97
4.1.1 Uksetihendi eemaldamine	97
4.1.2 Uksetihendi paigaldamine.....	97
4.2 Käepideme vahetamine	100
4.2.1 Käepideme eemaldamine	100
4.2.2 Käepideme paigaldamine	100
4.3 Riili vahetamine	101
4.3.1 Riili eemaldamine.....	101
4.3.2 Riili paigaldamine	101
4.4 Pudelialuse vahetamine	102
4.4.1 Pudelialuse eemaldamine.....	102
4.4.2 Pudelialuse paigaldamine	102
4.5 Ukseraami vahetamine	103
4.5.1 Ukseraami eemaldamine	103
4.5.2 Ukseraami paigaldamine	103
4.6 Mahutite vahetamine	104
4.6.1 Mahutite eemaldamine	104
4.6.2 Mahutite paigaldamine	104
4.7 LED-lambi vahetamine.....	105
4.7.1 LED-lambi eemaldamine	105
4.7.2 LED-lambi paigaldamine.....	106

i Selle dokumendiga seoses

1.1 Tähtis teave

1.1.1 Eesmärk

Need remondinõuanded toetavad tarbijat seadmete iseseisval remontimisel vastavalt kehtivale ökodisaini määrusele (03/2021).





Need sisaldavad teavet selle kohta, kuidas vahetada teatud varuosi, samuti hoiatusi ning ohtusid.

Küsimuste korral võtke ühendust meie klienditeenindusega. Meie vastutame kahjustuste eest ainult siis, kui remondinõuandeid on õigesti järgitud.

1.2 Sümbolite selgitus

1.2.1 Ohutasemed

Ohutasemed koosnevad sümbolist ja märksõnast. Märksõna viitab ohu raskusastmele.

Hoiatustase	Tähendus
 OHT	Hoiatusteadete eiramine põhjustab surma või raskeid kehavigastusi.
 HOIATUS	Hoiatusteadete eiramine võib põhjustada surma või raskeid kehavigastusi.
 ETTEVAATUST!	Hoiatusteadete eiramine võib põhjustada kergeid kehavigastusi.
 TÄHELEPANU!	Hoiatusteadete eiramine võib põhjustada varakahju.

Tabel 1: Ohutasemed



1.2.2 Ohusümbolid

Ohusümbolid on sümboolsed kujutised, mis viitavad ohu laadile.

Selles dokumendis kasutatakse alljärgnevaid ohusümboleid.

Ohusümbol	Tähendus
	Üldine ohuteade
	Elektripingest tingitud oht
	Plahvatusoht
	Lõikeoht
	Muljumisoht

i Selle dokumendiga seoses

Ohusümbol	Tähendus
	Kuumadest pindadest tingitud oht
	Tugevast magnetväljast tingitud oht
	Mitteioniseerivast kiirgusest tingitud oht

Tabel 2: Ohusümbolid

1.2.3 Hoiatuste struktuur

Selles dokumendis olevatel hoiatustel on standardiseeritud väljanägemine ja standardiseeritud struktuur.



	<div style="background-color: red; color: white; padding: 2px; display: inline-block;">⚠ OHT</div> Ohu tüüp ja allikas! Ohu/hoiatuse eiramise võimalikud tagajärjed. ▶ Meetmed ja ettevaatusabinõud ohu vältimiseks.
----------------------------------------------------------------------------------	---------------------------------------------------------------------------------------------------------------------------------------------------------------------------------------------------------------------------------------------





Alljärgnevas näiteks on näidatud hoiatust, millega hoiatatakse liikuvatest osadest tingitud elektrilöögiu eest. Nimetatud on meetet ohu vältimiseks.

	<div style="background-color: red; color: white; padding: 2px; display: inline-block;">⚠ OHT</div> Liikuvatest osadest tingitud elektrilöögi oht! Elektrilöögist tingitud surm ▶ Enne remonditöödega alustamist ühendage seadmed elektrivõrgust lahti vähemalt 60 sekundit varem.
-----------------------------------------------------------------------------------	----------------------------------------------------------------------------------------------------------------------------------------------------------------------------------------------------------------------------------------------------------------------------------------------------------

1.2.4 Üldised sümbolid

Selles dokumendis kasutatakse alljärgnevaid üldisi sümboleid.

Üld. sümbol	Tähendus
	Erinõuande tunnus (tekst ja/või graafik)
	Lihtsa nõuande tunnus (ainult tekst)
	Videojuhendi lingi tunnus

Üld. sümbol	Tähendus
	Vajalike tööriistade tunnus
	Vajalike eeltingimuste tunnus
	Seisukorra tunnus (kui..., siis...)
	Tulemuse tunnus
[Start]	Klahvi või nupu tunnus
[00123456]	Materjalinumbril tunnus
Olek	Kuvatava teksti/akna tunnus (seadme ekraanil)

Tabel 3: Üldised sümbolid

2.1 Üldised ohutusjuhised

2.1.1 Kõik kodumasinad

Liikuvatest osadest tingitud elektrilöögi oht!

- Elektriliste osade remondil tehtud vead võivad põhjustada elektrilööki!
- Lahutage seade vooluvõrgust vähemalt 60 sekundit enne tööle hakkamist.
- Pärast remonti peab olema tehtud ohutuskatse vastavalt standardile VDE 0701 või riiklikele määrustele.

Teravatest servadest tingitud vigastusoht!

- Kandke kaitsekindaid.

Rasketest ja liikuvatest osadest tingitud muljumisoht remondi-, puhastustööde, tõrkeotsingu ja hoolduse käigus

- Kandke turvakingi.
- Kinnitage rasked osad allakukkumise vastu.
- Ärge toppige kehaosi liikuvate osade vahele.



Oht seadme ohutusele/talitlusele!

- Kasutage ainult originaalvaruosasid.

Elektrostaatiliselt tundlike osade (ESD) kahjustamise oht!

- Ärge puudutage moduleid, kaasa arvatud ühendusi ega transportöörlinte.

Tööriistad ja abinõud

Määramine	Üksikasjad	Kujutised
Kaitseriie [00342013]	60 cm × 50 cm	
Kuuskantvõtmed [00340819]	2 mm, 2,5 mm, 3 mm, 4 mm, 5 mm, 6 mm, 8 mm	

4.1 Uksetihendi vahetamine

Nõue:

- ✓ Uks on lahti.

4.1.1 Uksetihendi eemaldamine

1. Vabastage uksetihend soonest paremast ja vasakust nurgast.

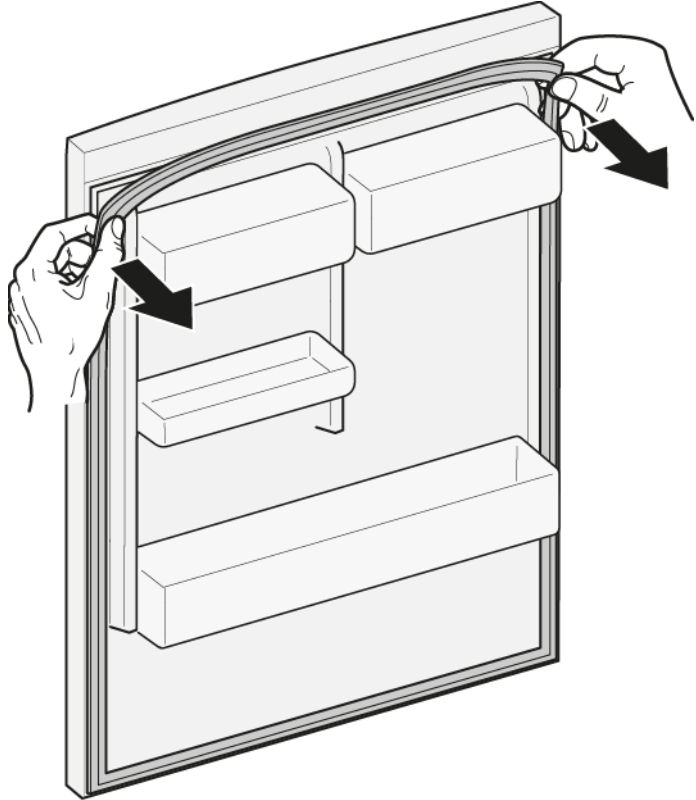

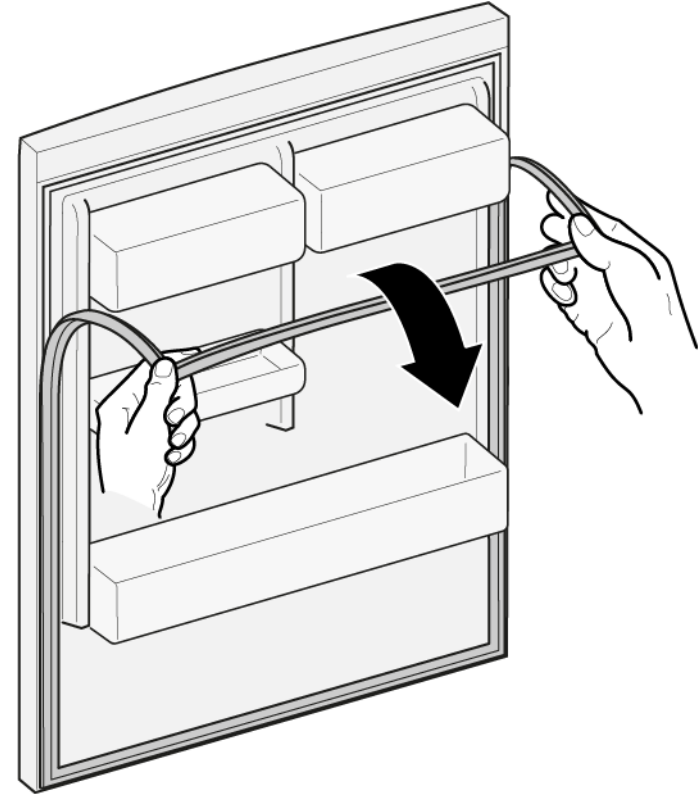

2. Tõmmake uksetihend soonest välja.



- ➡ Uksetihend on eemaldatud.

4.1.2 Uksetihendi paigaldamine

	Uue uksetihendi paksus võib veidi erineda vana tihendi paksusest. See ei mõjuta ukse sulgemist ja pikaajalist tööd.
	Kui teie seadmel on reguleeritavad hinged või hingekinnitused, saate sulgemismehhanismi hiljem sobivaks sättida.
	Väikesed augud uksetihendis on vajalikud õhutuseks. Need ei ole tootmisvead.

1. Kontrollige, kas tihendi soon on terve.

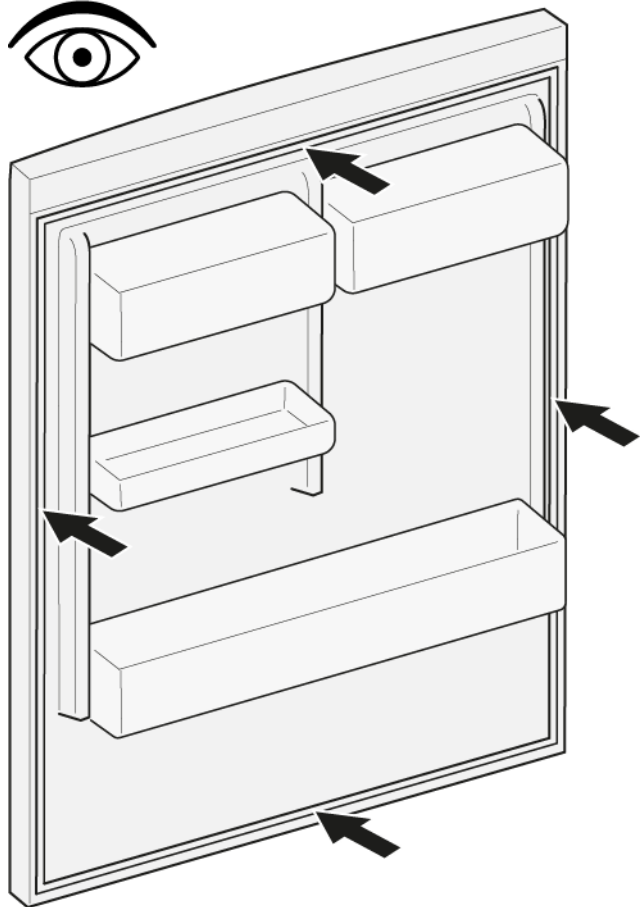

4. Lükake tihendi otsad soone üla- ja alanurka.

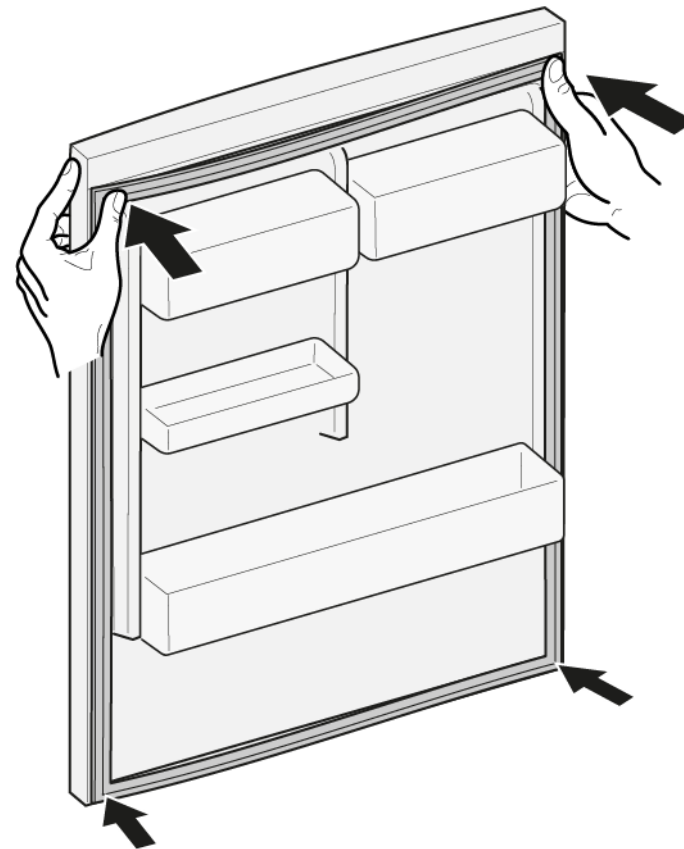

2.  Kui tihendi soon on kahjustatud,
- pöörduge klienditeeninduse poole.

3.  Uksetihendi kerge kõverdumine on normaalne ega mõjuta selle toimivust. Soovitav on uksetihend enne seadmesse paigaldamist sirgu tõmmata.

Soojendage uksetihendit fööni või sooja veega ja vormige seda käsitsi.

5. Vajutage terve tihend jupphaaval soonde.

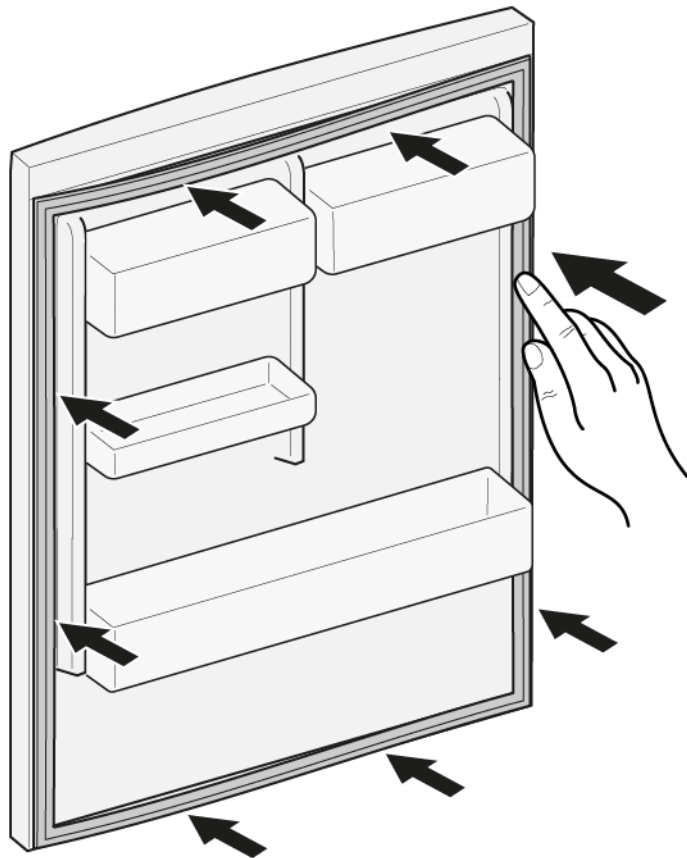

➡ Uksetihend on paigaldatud.

4.2 Käepideme vahetamine

Eritööriistad:

 Kuuskantvõtmed 2 mm, 2,5 mm, 3 mm, 4 mm, 5 mm, [00340819]
6 mm, 8 mm

Nõue:

- ✓ Seade on toitest lahutatud.
- ✓ Uks on lahti.

4.2.1 Käepideme eemaldamine

1. Keerake lahti kaks kruvi (1).
2. Eemaldage käepide (2).

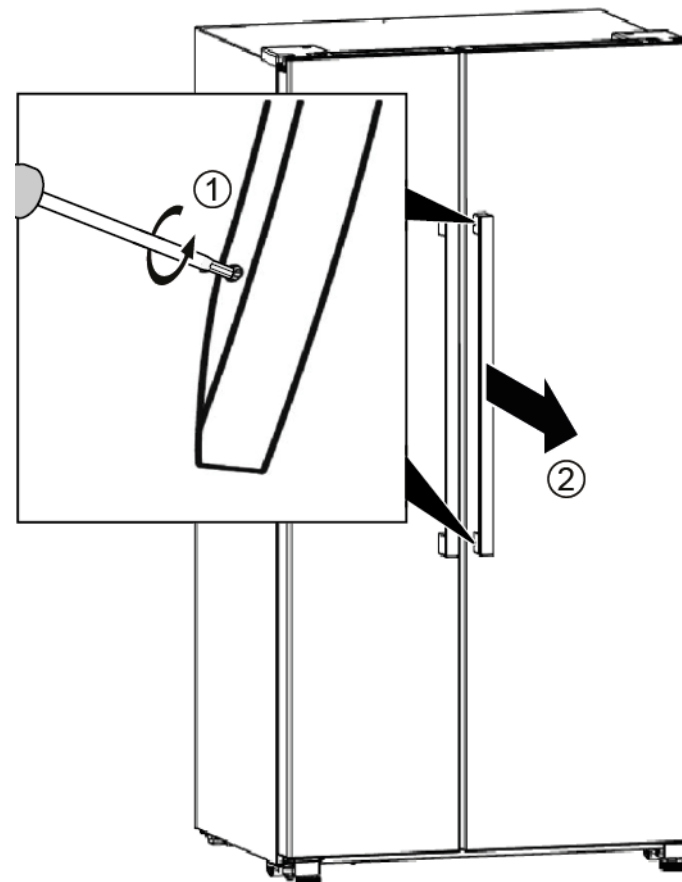

 Ukse käepide on eemaldatud.

2. Eemaldage teine käepide samamoodi.

4.2.2 Käepideme paigaldamine

- ▶ Paigaldage vastupidises järjekorras.

4.3 Riiuli vahetamine

Nõue:

- ✔️ Uks on lahti.

4.3.1 Riiuli eemaldamine

- ▶ Tõmmake riiul välja.

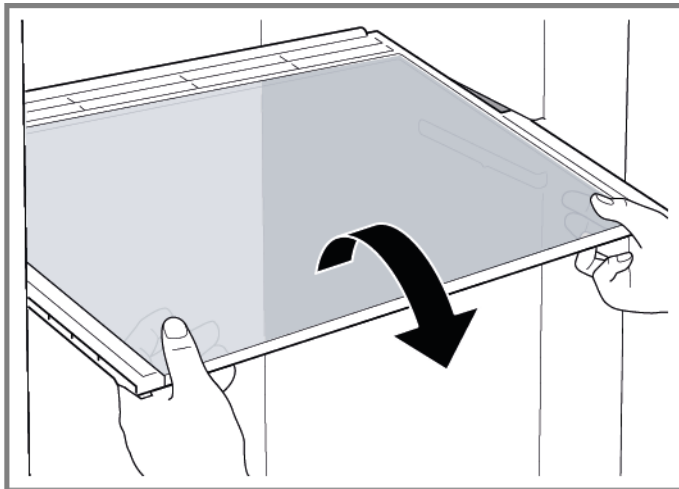

➡️ Riiul on eemaldatud.

4.3.2 Riiuli paigaldamine

- ▶ Paigaldage vastupidises järjekorras.

4.4 Pudelialuse vahetamine

Nõue:

- ✔️ Uks on lahti.

4.4.1 Pudelialuse eemaldamine

- ▶ Tõmmake pudelialus välja.

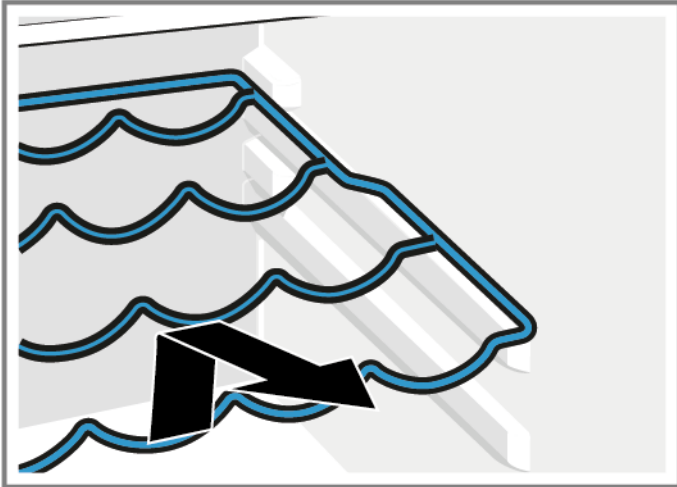

- ➡️ Pudelialus on eemaldatud.

4.4.2 Pudelialuse paigaldamine

- ▶ Paigaldage vastupidises järjekorras.

4.5 Ukseraami vahetamine

Nõue:

- ✓ Uks on lahti.

4.5.1 Ukseraami eemaldamine

- ▶ Tõstke ukseraam üles.

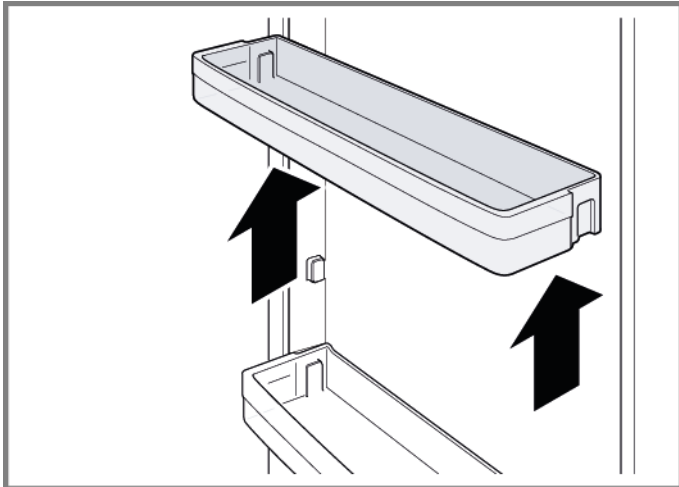

➡ Ukseraam on eemaldatud.

4.5.2 Ukseraami paigaldamine

- ▶ Paigaldage vastupidises järjekorras.

4.6 Mahutite vahetamine

Nõue:

- ✓ Uks on lahti.

4.6.1 Mahutite eemaldamine

- ▶ Tõstke mahuti täielikult välja, tõstke seda, et see hoidikust vabaneks, ja eemaldage mahuti.

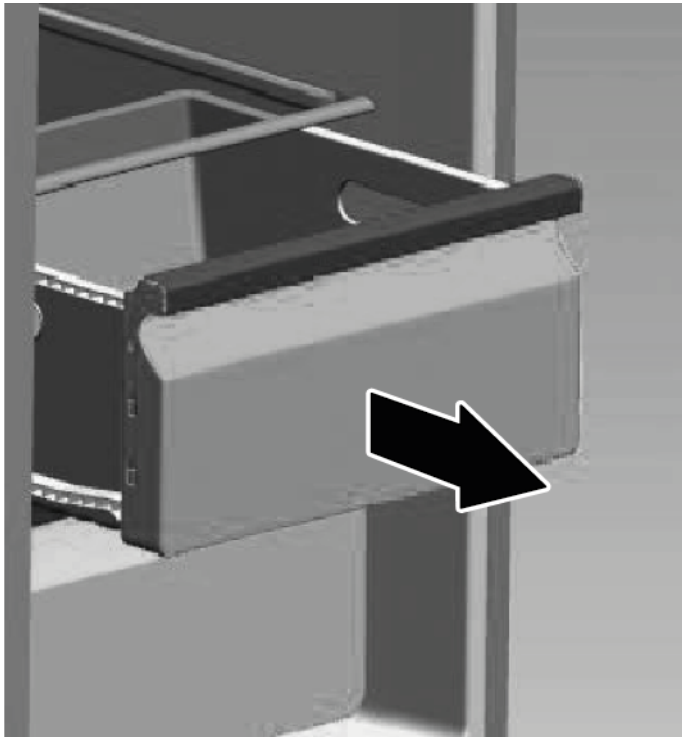

- ➡ Mahuti on eemaldatud.

4.6.2 Mahutite paigaldamine

- ▶ Paigaldage vastupidises järjekorras.

4.7 LED-lambi vahetamine



Teie seadmel on LED-tuli, mis ei vaja hooldust. Seda tuld tohib parandada ainult klienditeenindus või volitatud tehnik!



OHT

Liikuvatest osadest tingitud elektrilöögi oht!

Kui remonditööd on valesti tehtud, esineb elektrilöögist tingitud eluoht.

- ▶ Elektrilisi osasid peavad parandama kvalifitseeritud elektrikud.
- ▶ Pärast remonti peab olema tehtud ohutuskatse vastavalt standardile VDE 0701 või riiklikele määrustele.



ETTEVAATUST!

Teravad servad!

Lõikehaavad

- ▶ Kandke kaitsekindaid.

Nõue:

- ✓ Seade on toitest lahutatud.
- ✓ Uks on lahti.
- ✓ Ülemine riul on eemaldatud.

4.7.1 LED-lambi eemaldamine

1. Võtke LED-lambi kattest kahe käega kinni ja tõmmake alla.



- ➡ LED-lambi kate on eemaldatud.



2. Tõmmake ja võtke LED-lamp välja.



3. Lahutage klemm vooluvõrgust.





- ➡ LED-lamp on eemaldatud.

4.7.2 LED-lambi paigaldamine

- ▶ Paigaldage vastupidises järjekorras.

Korjausvinkit - Jääkaappipakastin

 Tämä asiakirja	108
1.1 Tärkeitä tietoja.....	108
1.1.1 Tarkoitus	108
1.2 Symboleiden merkitys.....	108
1.2.1 Vaaratasot.....	108
1.2.2 Varoitusmerkit.....	108
1.2.3 Varoitusten rakenne	109
1.2.4 Yleiset symbolit.....	109
 Turvallisuus	110
2.1 Yleiset turvallisuusohjeet.....	110
2.1.1 Kaikki kotitalouskoneet.....	110
 Työkalut ja apuvälineet	111
 Korjaus	112
4.1 Oven tiivisteeseen vaihtaminen.....	112
4.1.1 Oven tiivisteeseen poistaminen	112
4.1.2 Oven tiivisteeseen asennus	112
4.2 Ovenkahvan vaihtaminen.....	115
4.2.1 Ovenkahvan poistaminen	115
4.2.2 Ovenkahvan asennus.....	115
4.3 Hyllyn vaihtaminen	116
4.3.1 Hyllyn poistaminen	116
4.3.2 Hyllyn asennus	116
4.4 Pullohyllyn vaihtaminen.....	117
4.4.1 Pullohyllyn poistaminen	117
4.4.2 Pullohyllyn asennus	117
4.5 Ovihyllyn vaihtaminen.....	118
4.5.1 Ovihyllyn poistaminen	118
4.5.2 Ovihyllyn asennus.....	118
4.6 Lokeroiden vaihtaminen	119
4.6.1 Lokeroiden poistaminen	119
4.6.2 Lokeroiden asennus.....	119
4.7 LED-lampun vaihtaminen	120
4.7.1 LED-lampun poistaminen	120
4.7.2 LED-lampun asennus.....	121

Tämä asiakirja

1.1 Tärkeitä tietoja

1.1.1 Tarkoitus

Näiden korjausohjeiden tarkoituksena on auttaa kuluttajaa korjaamaan laitteita itse ekologista suunnittelua koskevan asetuksen (päivitys 03/2021) mukaisesti.



Ne sisältävät tietoja siitä, miten määrätyt varaosat voidaan vaihtaa. Lisäksi niihin sisältyy tietoja varoituksista ja riskeistä.

Ota yhteyttä huoltopalveluun, jos sinulla on kysyttävää. Vastamme vahingoista vain, jos korjausohjeita on noudatettu oikein.

1.2 Symboleiden merkitys

1.2.1 Vaaratasot

Varoitustasot koostuvat symbolista ja huomiosanasta. Huomiosanat ilmoittava vaaran vakavuuden.

Varoitustaso	Merkitys
 VAARA	Varoituksen laiminlyönti johtaa kuolemaan tai vakaviin loukkaantumisiin.
 VAROITUS	Varoituksen laiminlyönti voi johtaa kuolemaan tai vakaviin loukkaantumisiin.
 HUOMAA	Varoituksen laiminlyönti voi johtaa lieviin loukkaantumisiin.
HUOMIO!	Varoituksen laiminlyönti voi johtaa omaisuusvahinkoihin.

Taulukko 1: Vaaratasot

1.2.2 Varoitusmerkit

Varoitusmerkit ovat symboleita sisältäviä esityksiä, jotka osoittavat vaaran tyyppin.

Tässä asiakirjassa käytetään seuraavia varoitusmerkkejä:

Varoitusmerkki	Merkitys
	Yleinen varoitus
	Sähköjännitteestä aiheutuva vaara
	Räjähdysvaara
	Viiltohaavojen vaara
	Murskautumisen vaara

Tämä asiakirja

Varoitusmerkki	Merkitys
	Kuumista pinnoista aiheutuva vaara
	Voimakkaasta magneettikentästä aiheutuva vaara
	Ionisoimattomasta säteilystä aiheutuva vaara



Taulukko 2: Varoitusmerkit

1.2.3 Varoitusten rakenne

Tämän asiakirjan sisältämillä varoituksilla on standardoitu ulkonäkö ja rakenne.



	<div style="background-color: red; color: white; padding: 2px; text-align: center;"> VAARA</div> <p>Vaaran tyyppi ja lähde! Vaaran/varoituksen laiminlyönnistä mahdollisesti aiheutuvat seuraukset.</p> <ul style="list-style-type: none">▶ Vaaran ehkäisemiseen liittyvät toimenpiteet ja kiellot.
----------------------------------------------------------------------------------	----------------------------------------------------------------------------------------------------------------------------------------------------------------------------------------------------------------------------------------------------------------------------------------------------------------------------------------------------------------------------------------------------------------------

Seuraavassa esimerkissä näytetään varoitus, joka varoittaa jännitteisten osien aiheuttamasta sähköiskusta. Vaaran välttämiseksi suoritettava toimenpide mainitaan.

	<div style="background-color: red; color: white; padding: 2px; text-align: center;"> VAARA</div> <p>Jännitteisten osien aiheuttama sähköiskun vaara! Sähköiskun aiheuttama kuolema</p> <ul style="list-style-type: none">▶ Erotta laitteet sähkövirrasta vähintään 60 sekuntia ennen korjaustöiden aloittamista.
-----------------------------------------------------------------------------------	-----------------------------------------------------------------------------------------------------------------------------------------------------------------------------------------------------------------------------------------------------------------------------------------------------------------------------------------------------------------------------------------------------------------------------------

1.2.4 Yleiset symbolit

Tässä asiakirjassa käytetään seuraavia yleisiä symboleja:

Yl. symboli	Merkitys
	Erikoisohjeen tunniste (teksti ja/tai kaavio)
	Yksinkertaisen ohjeen tunniste (vain teksti)

Yl. symboli	Merkitys
	Video-opetusohjelmaan johtavan linkin tunniste
	Tarvittavien työkalujen tunniste
	Tarvittavien edellytysten tunniste
	Ehdon (jos ..., sitten ...) tunniste
	Tuloksen tunniste
	Näppäimen tai painikkeen tunniste
	Materiaalinumeron tunniste
	Näytetyn tekstin/ikkunan (laitteen näytössä) tunniste

Taulukko 3: Yleiset symbolit

2.1 Yleiset turvallisuusohjeet

2.1.1 Kaikki kotitalouskoneet

Jännitteisten osien aiheuttama sähköiskun vaara!

- Virheet sähkökomponentteja sisältävissä korjauksissa voivat johtaa sähköiskuun!
- Kytke kone irti verkkovirrasta vähintään 60 sekuntia ennen töiden aloittamista.
- Pyydä korjauksen jälkeen suorittamaan VDE 0701 -säädöksen tai maakohtaisten säädösten mukainen turvallisuustesti.

Terävistä reunoista aiheutuva loukkaantumisvaara!

- Käytä suojakäsineitä.

Painavista ja liikkuvista komponenteista aiheutuva murskautumisen riski korjauksen, kunnossapidon, vianetsinnän ja huollon aikana

- Käytä suojakenkiä.
- Estä painavien komponenttien putoaminen.
- Älä koske liikkuviin komponentteihin.



Laitteen turvallisuudelle/toiminnalle aiheutuva riski!

- Käytä vain alkuperäisiä varaosia.

Staattiselle sähkölle herkkien komponenttien (ESDS) vaurioitumisen riski!

- Älä koske moduuleihin, liitännät ja johdinreitit mukaan luettuna.

Työkalut ja apuvälineet

Nimitys	Yksityiskohdat	Kuvat
Suojapeite [00342013]	60 cm x 50 cm	
Kuusiokoloavaimet [00340819]	2 mm, 2,5 mm, 3 mm, 4 mm, 5 mm, 6 mm, 8 mm	

4.1 Oven tiiviste vaihtaminen

Vaatus:

- ✓ Ovi on auki.

4.1.1 Oven tiiviste poistaminen

1. Irrota oven tiiviste urasta oikeassa ja vasemmassa nurkassa.

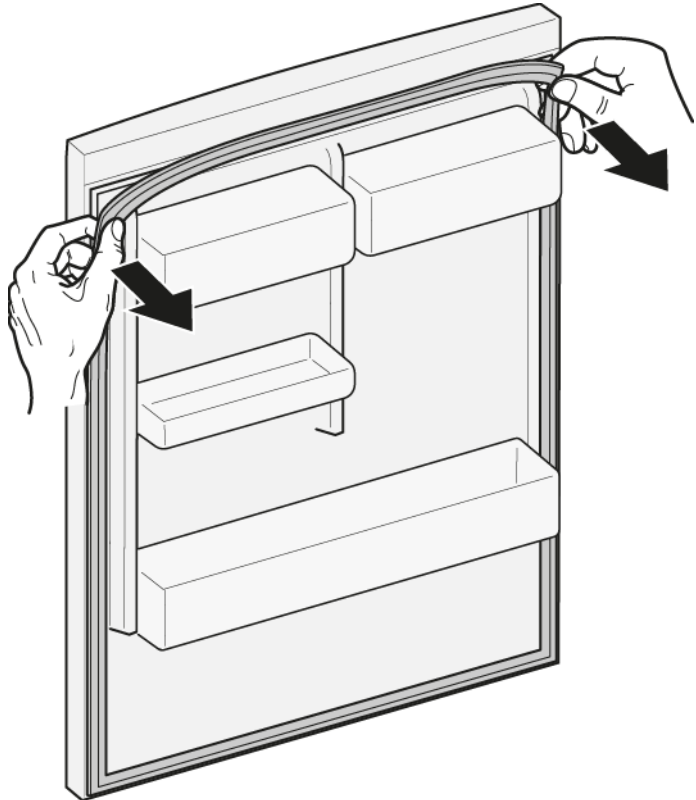

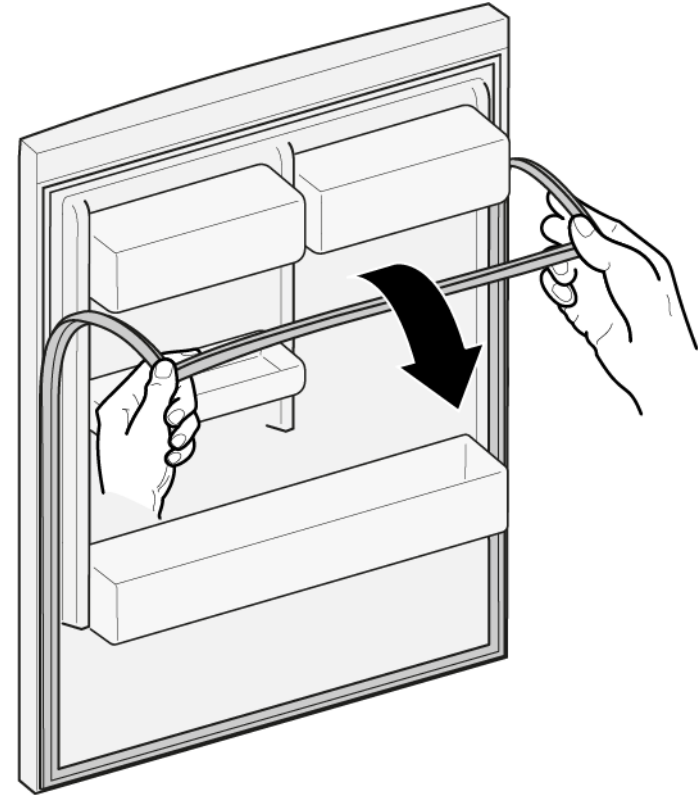

2. Vedä oven tiiviste ulos urasta.



- ➡ Oven tiiviste on poistettu.

4.1.2 Oven tiiviste asennus

	Uuden tiiviste paksuus voi poiketa hieman vanhan tiiviste paksuudesta. Sillä ei ole vaikutusta oven sulkeutumiseen eikä pitkän aikavälin toimintaan.
	Jos laitteessa on säädettävät saranat tai saranan kiinnittimet, voit optimoida sulkeutumista myöhemmin.
	Oven tiiviste sivuilla olevat pienet reiät ovat toiminnollisia (tarvitaan ilmanvaihtoa varten). Ne eivät ole tuotantovirheitä.

1. Tarkista, että tiivistettä varten oleva ura ei ole vioittunut.

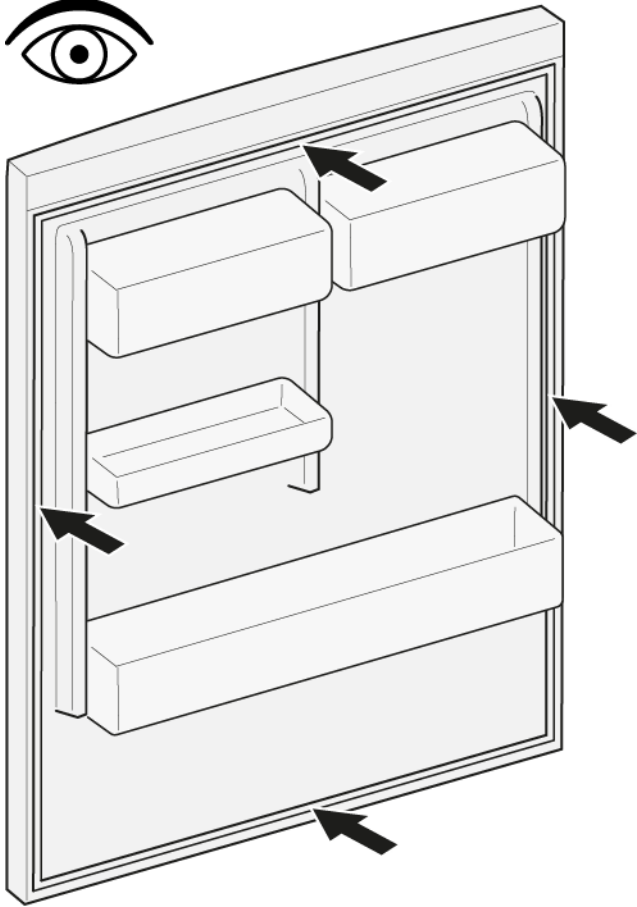

4. Työnnä tiivisteiden nurkat ylhäällä ja alhaalla uraan.

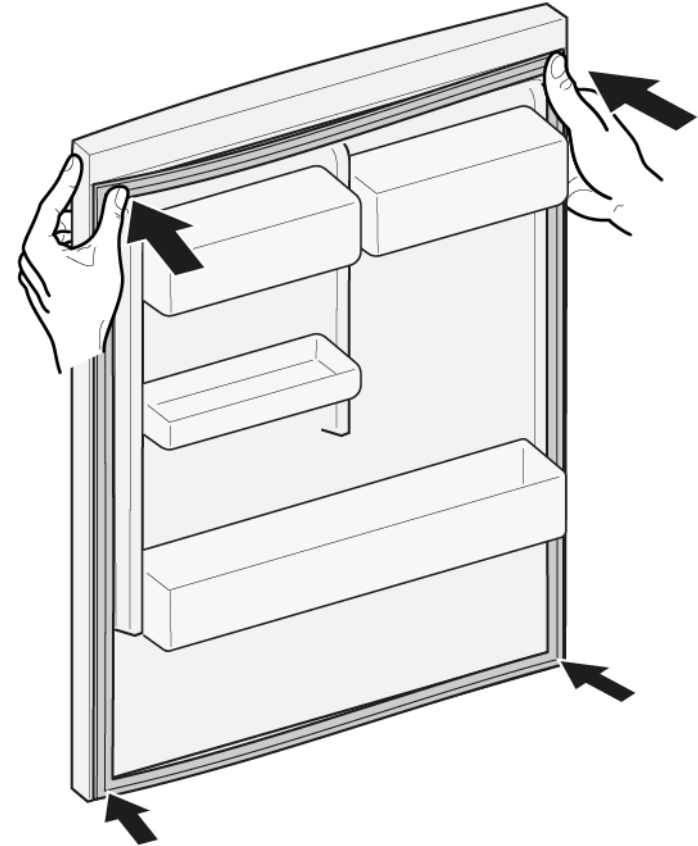

2.  Jos tiivisteiden ura on vioittunut.
- Ota yhteyttä asiakaspalveluun.

3.  Oven tiivisteiden pienet vääntymät ovat normaaleja eikä niillä ole vaikutusta sen toimintaan. Oven tiiviste kannattaa suoristaa, ennen kuin se asetetaan laitteeseen.

Kuumenna oven tiivistettä hiustenkuivaajalle tai kuumalla vedellä ja muotoile se käsin uudelleen.

5. Paina koko tiiviste vähitellen uraan.

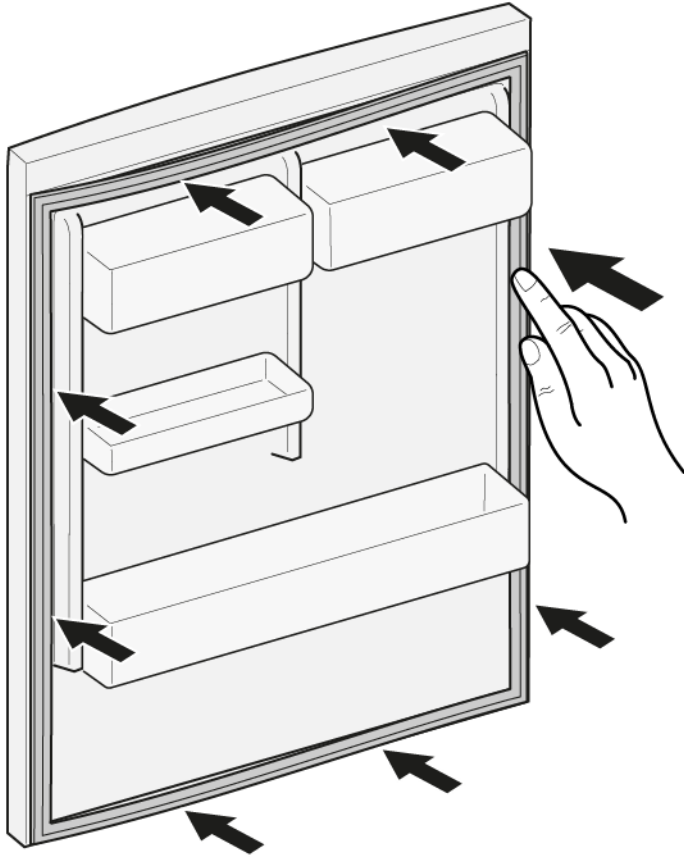

 Oven tiiviste on asennettu.

4.2 Ovenkahvan vaihtaminen

Erikoistyökalut:

 Kuusiokoloavaimet 2 mm, 2,5 mm, 3 mm, 4 mm, 5 mm, [00340819]
6 mm, 8 mm

Vaatus:

- ✓ Kone on erotettu teholähteestä.
- ✓ Ovi on auki.

4.2.1 Ovenkahvan poistaminen

1. Kierrä kaksi ruuvia auki (1).
2. Poista ovenkahva (2).

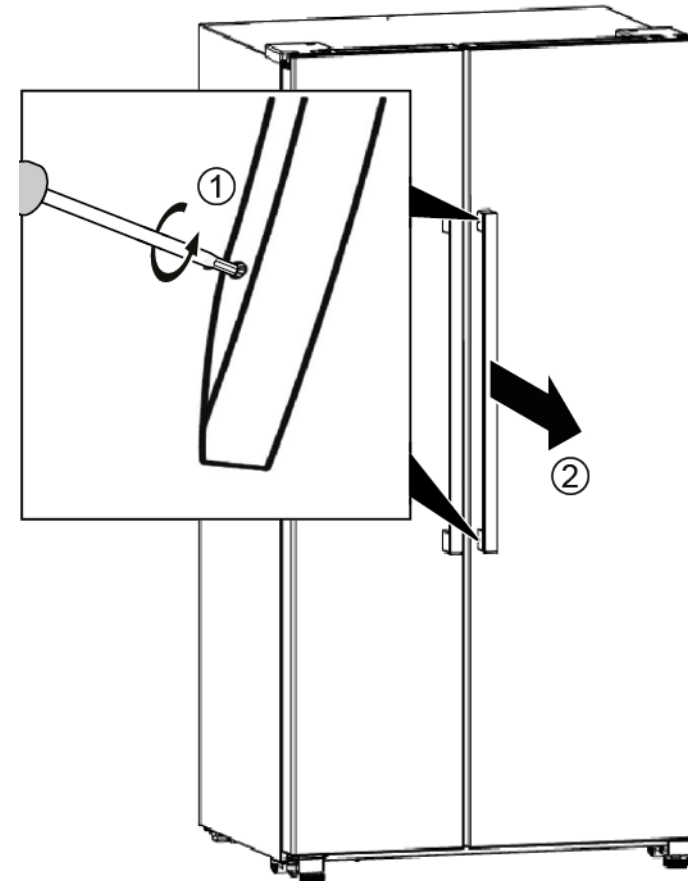

 Ovenkahva on poistettu.

2. Poista toinen ovenkahva samalla tavalla.

4.2.2 Ovenkahvan asennus

- Asenna vastakkaisessa järjestyksessä.

4.3 Hyllyn vaihtaminen

Vaatus:

- ✔ Ovi on auki.

4.3.1 Hyllyn poistaminen

- ▶ Vedä hylly ulos.

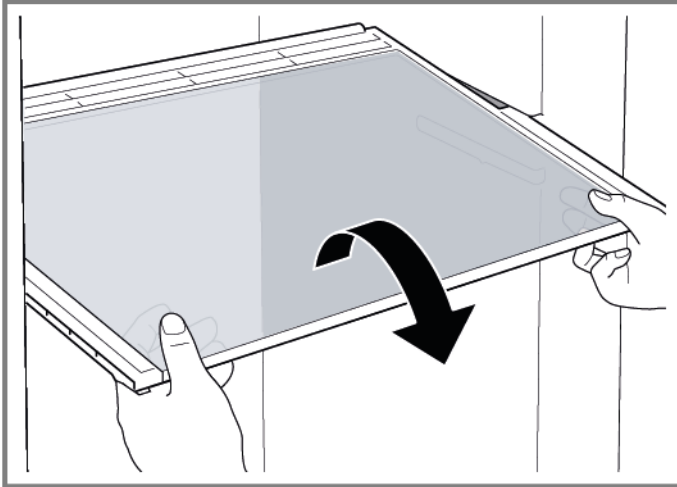

- ➡ Hylly on poistettu.

4.3.2 Hyllyn asennus

- ▶ Asenna vastakkaisessa järjestyksessä.

4.4 Pullohyllyn vaihtaminen

Vaatus:

- ✔ Ovi on auki.

4.4.1 Pullohyllyn poistaminen

- ▶ Vedä pullohylly ulos.

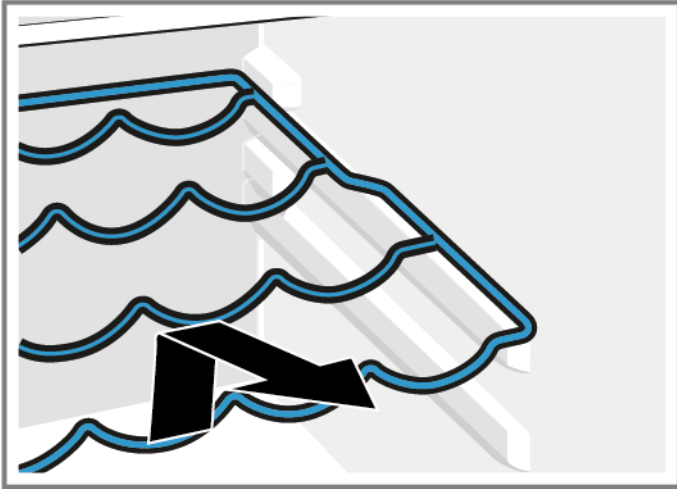

- ➡ Pullohylly on poistettu.

4.4.2 Pullohyllyn asennus

- ▶ Asenna vastakkaisessa järjestyksessä.

4.5 Ovihyllyn vaihtaminen

Vaatus:

- ✔ Ovi on auki.

4.5.1 Ovihyllyn poistaminen

- ▶ Nosta ovihylly pois yläsuuntaan.

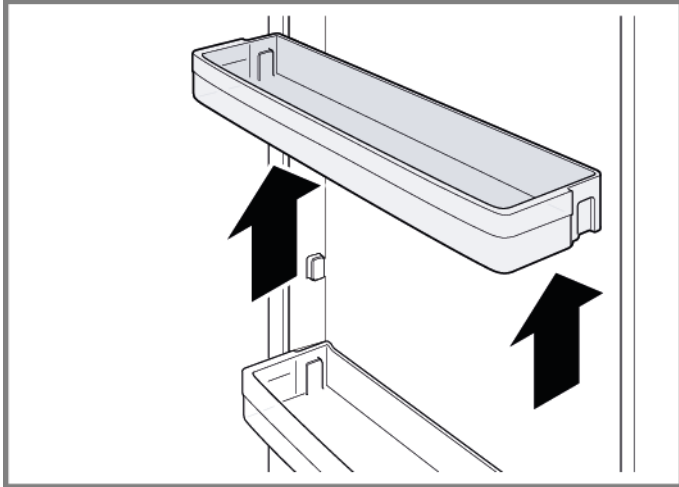

- ➡ Ovihylly on poistettu.

4.5.2 Ovihyllyn asennus

- ▶ Asenna vastakkaisessa järjestyksessä.

4.6 Lokeroiden vaihtaminen

Vaatus:

- ✔ Ovi on auki.

4.6.1 Lokeroiden poistaminen

- ▶ Vedä lokero kokonaan ulos, nosta sitä, jolloin se irtoaa pidikkeestä, ja ota se ulos.

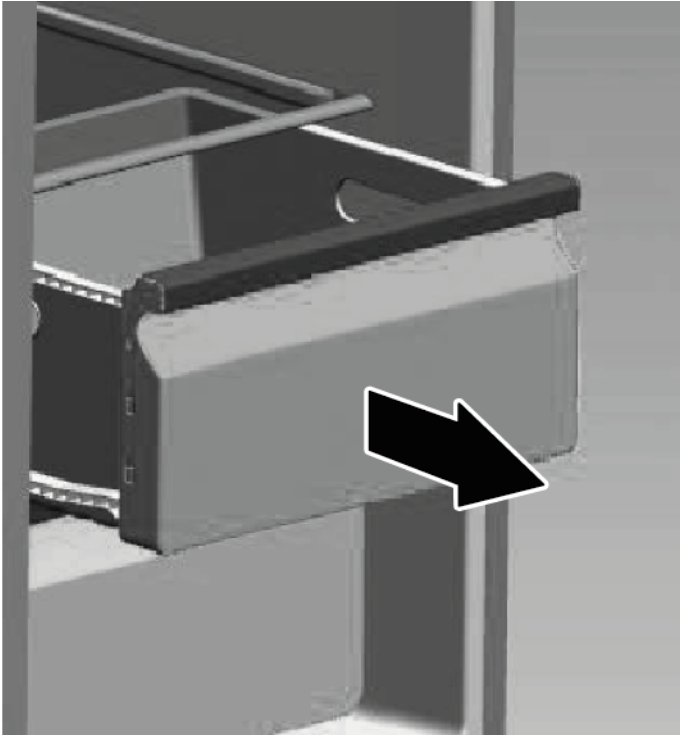



- ➡ Lokero on poistettu.

4.6.2 Lokeroiden asennus

- ▶ Asenna vastakkaisessa järjestyksessä.

4.7 LED-lampun vaihtaminen

 Laite on varustettu huoltovapaalla LED-valolla. Vain huoltopalvelu tai valtuutetut teknikot saavat korjata nämä valot!

 **VAARA**
Jännitteisten osien aiheuttama sähköiskun vaara!
Sähköiskusta aiheutuva hengenvaara väärän korjauksen tapauksessa

- ▶ Sähköosien korjaus tulisi antaa pätevien sähköasentajien suoritettavaksi.
- ▶ Pyydä korjauksen jälkeen suorittamaan VDE 0701 -säädöksen tai maakohtaisten säädösten mukainen turvallisuustesti.

 **HUOMAA**
Terävät reunat!
Viiltovammat

- ▶ Käytä suojakäsineitä.

Vaatus:

- ✔ Kone on erotettu tehollisesta.
- ✔ Ovi on auki.
- ✔ Ylähylly on poistettu.

4.7.1 LED-lampun poistaminen

1. Tartu kiinni LED-lampun suojuksesta kaksin käsin ja vedä sitä alas.



- ➡ LED-lampun suojus on poistettu.



2. Vedä LED-lamppu ulos



3. Irrota liitin



- ➡ LED-lamppu on poistettu.

4.7.2 LED-lampun asennus

- ▶ Asenna vastakkaisessa järjestyksessä.

Conseils de réparation - Réfrigérateur / Congélateur combiné

 A propos de ce document	123
1.1 Informations importantes.....	123
1.1.1 Objectif.....	123
1.2 Explication des symboles.....	123
1.2.1 Niveaux de risque.....	123
1.2.2 Symboles de danger.....	123
1.2.3 Structure des indications d'avertissement.....	124
1.2.4 Symboles généraux.....	124
 Sécurité	125
2.1 Consignes de sécurité générales.....	125
2.1.1 Tous les appareils électroménagers.....	125
 Outils et aides	126
 Réparation	127
4.1 Remplacer le joint de porte.....	127
4.1.1 Retirer le joint de porte.....	127
4.1.2 Monter le joint de porte.....	127
4.2 Remplacer la poignée de porte.....	130
4.2.1 Retirer la poignée de porte.....	130
4.2.2 Monter la poignée de porte.....	130
4.3 Remplacer la tablette.....	131
4.3.1 Retirer la tablette.....	131
4.3.2 Monter la tablette.....	131
4.4 Remplacer le casier à bouteilles.....	132
4.4.1 Retirer le casier à bouteilles.....	132
4.4.2 Monter le casier à bouteilles.....	132
4.5 Remplacer l'étagère de la porte.....	133
4.5.1 Retirer l'étagère de la porte.....	133
4.5.2 Monter l'étagère de la porte.....	133
4.6 Remplacer les bacs.....	134
4.6.1 Retirer les bacs.....	134
4.6.2 Monter les bacs.....	134
4.7 Remplacer la lampe LED.....	135
4.7.1 Retirer la lampe LED.....	135
4.7.2 Monter la lampe LED.....	136

i A propos de ce document

1.1 Informations importantes

1.1.1 Objectif

Les conseils de réparation qui suivent visent à permettre au consommateur de réparer l'appareil par lui-même, conformément au règlement sur l'écoconception (en vigueur le 03/2021).

Ils contiennent des informations sur le remplacement de certaines pièces de rechange précises, y compris des mises en garde.

Pour toute question, veuillez contacter notre service après-vente. Notre responsabilité pour les dommages est conditionnelle à l'observation des conseils de réparation.

1.2 Explication des symboles

1.2.1 Niveaux de risque

Les niveaux de risque se composent d'un symbole et d'un terme d'avertissement. Le mot d'avertissement caractérise la gravité du danger.









Niveau de dangerosité	Signification
 DANGER	Le non respect de la consigne d'avertissement provoque la mort ou des blessures graves.
 AVERTISSEMENT	Le non respect de la consigne d'avertissement peut provoquer la mort ou des blessures graves.
 PRUDENCE	Le non respect de la consigne d'avertissement peut provoquer des blessures légères.
 ATTENTION !	Le non respect de la consigne d'avertissement peut provoquer des dégâts matériels.

Tableau 1: Niveaux de risque

1.2.2 Symboles de danger

Les symboles de danger sont des représentations figuratives renseignant sur la nature du danger.

Ce document utilise les symboles de danger suivants:

Symbole de danger	Signification
	Consigne d'avertissement générale
	Danger engendré par la tension électrique
	Risque d'explosion
	Risque de blessures par coupure

i A propos de ce document





Symbole de danger	Signification
	Risque de blessures par écrasement
	Danger engendré par des surfaces très chaudes
	Danger engendré par un champ magnétique puissant
	Danger engendré par un rayonnement non ionisant

Tableau 2: Symboles de danger

1.2.3 Structure des indications d'avertissement

Les consignes d'avertissement figurant dans ce document ont un aspect uniforme et une structure uniforme.

	<p>⚠ DANGER</p> <p>Type et source du danger ! Conséquences possibles en cas de non-respect du danger / de l'avertissement.</p> <ul style="list-style-type: none"> ▶ Mesures et interdictions pour éviter le danger.
----------------------------------------------------------------------------------	-----------------------------------------------------------------------------------------------------------------------------------------------------------------------------------------------------------------------------------------------------------------

L'exemple suivant montre une consigne d'avertissement mettant en garde contre le risque d'électrocution. La mesure permettant d'éviter le danger est nommée.

	<p>⚠ DANGER</p> <p>Risque d'électrocution par des pièces conductrices de tension ! Mort par électrocution.</p> <ul style="list-style-type: none"> ▶ Débrancher l'appareil du secteur minimum 60 secondes avant de démarrer la réparation.
------------------------------------------------------------------------------------	---------------------------------------------------------------------------------------------------------------------------------------------------------------------------------------------------------------------------------------------------------------------------------------

1.2.4 Symboles généraux

Ce document utilise les symboles généraux suivants:











Symbole général	Signification
	Caractérisation d'une astuce particulière (texte et/ou graphique)
	Caractérisation d'une astuce simple (texte seul)
	Caractérisation d'un lien vers une vidéo
	Caractérisation d'outils nécessaires
	Caractérisation de conditions nécessaires
	Caractérisation d'une condition (si... , alors ...)
	Caractérisation d'un résultat
	Caractérisation d'une touche ou surface de commande
	Caractérisation d'une référence de pièce
	Caractérisation d'un texte affiché / fenêtre (sur l'afficheur)

Tableau 3: Symboles généraux

2.1 Consignes de sécurité générales

2.1.1 Tous les appareils électroménagers

Risque d'électrocution en raison de pièces sous tension!

- Des erreurs lors de réparations impliquant des composants électriques peuvent entraîner une décharge électrique!
- Débrancher l'appareil du secteur minimum 60 secondes avant de démarrer la réparation.
- Après la réparation, effectuer un test de sécurité selon VDE 0701 ou les réglementations spécifiques nationales.

Risque de blessures par coupure sur des bords tranchants!

- Porter des gants de protection.

Risque de casse durant la réparation, maintenance, dépannage et SAV en raison de composants lourds et mobiles

- Porter des chaussures de protection.
- Sécuriser les composants lourds contre le risque de chute.
- Ne pas coller les pièces du châssis sur les composants mobiles.



Risque lié à la sécurité / fonction de l'appareil!

- Utiliser uniquement des pièces détachées d'origine.

Risque d'endommagement des composants sensibles aux décharges électrostatiques!

- Ne pas toucher les modules, ni leur connexions et pistes conductrices.

Outils et aides

Désignation	Détails	Images
Tissu de protection [00342013]	60 cm x 50 cm	
Clés à douilles hexagonales [00340819]	2 mm, 2.5 mm, 3 mm, 4 mm, 5 mm, 6 mm, 8 mm	

4.1 Remplacer le joint de porte

Pré-requis:

- ✔ La porte est ouverte.

4.1.1 Retirer le joint de porte

1. Sortir le joint de porte de la rainure dans les coins gauche et droit.

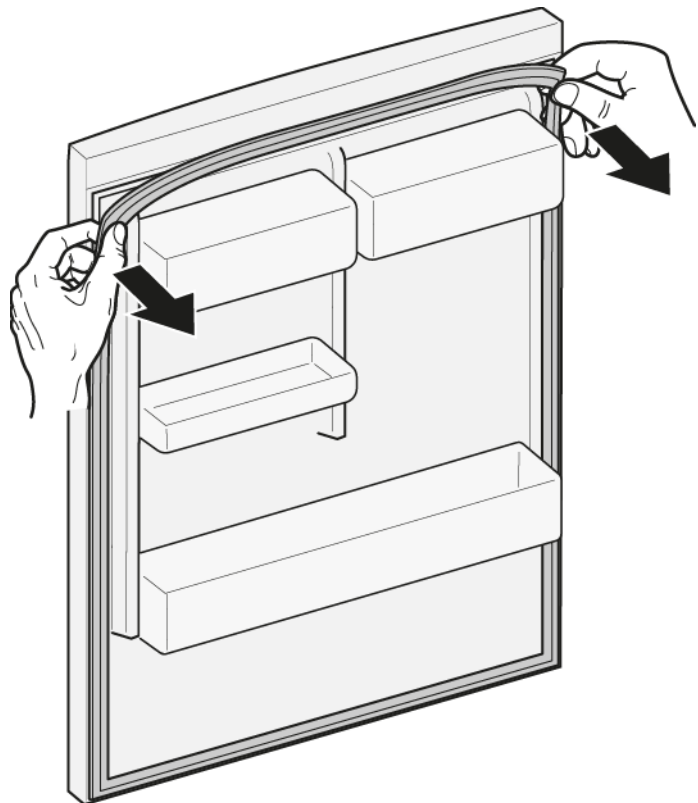

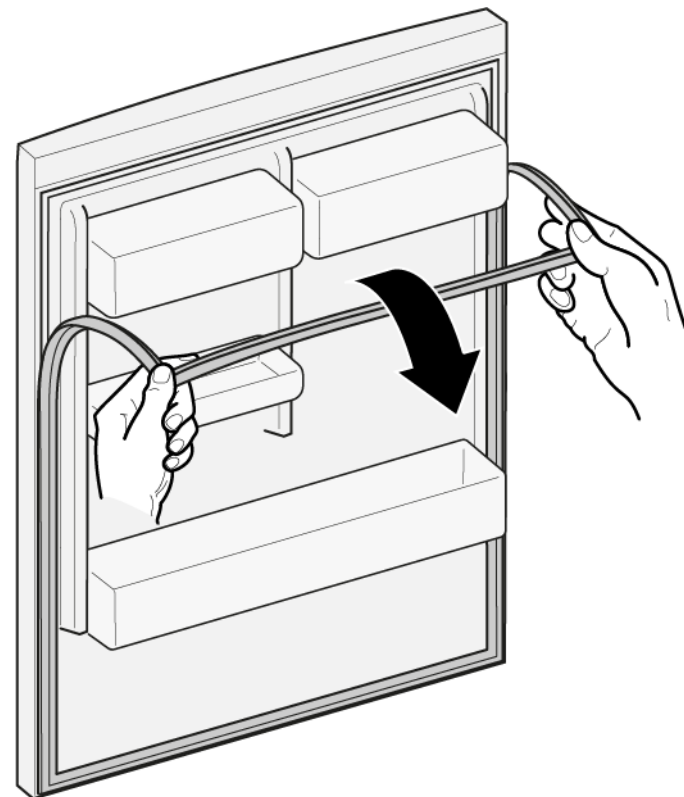

2. Retirer le joint de porte de la rainure.



- ➡ Le joint de porte est retiré.

4.1.2 Monter le joint de porte

	L'épaisseur du nouveau joint de porte peut différer légèrement de celle de l'ancien. Cela n'affectera en rien la fermeture ou le fonctionnement à long terme de la porte.
	Si votre appareil est doté de charnière ou d'attaches de charnières ajustables, vous pourrez optimiser le comportement de fermeture par la suite.
	Les petits trous latéraux dans les joints de porte sont fonctionnels (nécessaires pour la ventilation). Il ne s'agit pas de défauts de production.

Réparation

1. S'assurer de l'absence de dégâts dans les rainures qui doivent accueillir le joint.

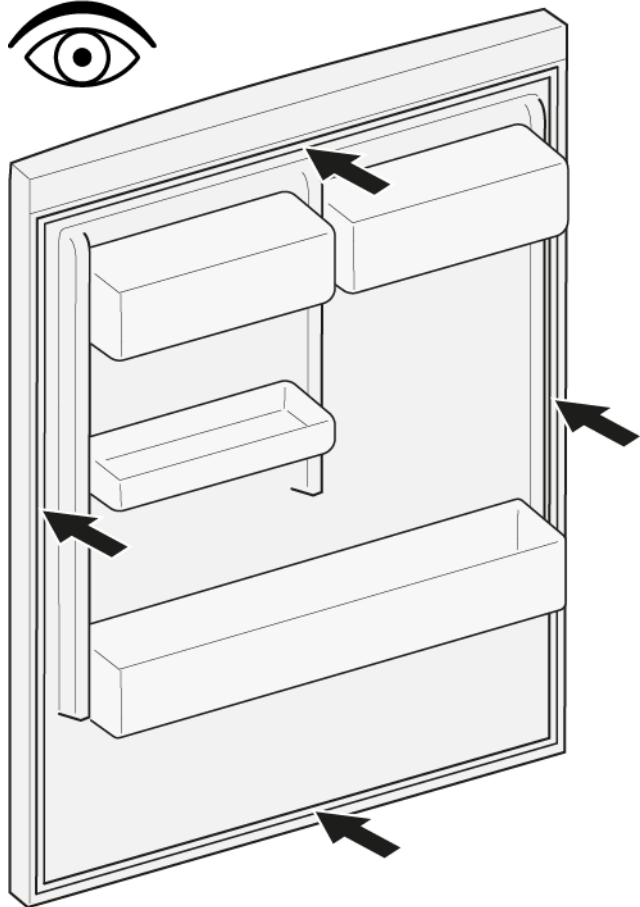

4. Pousser les coins du joint en haut et en bas dans la rainure.

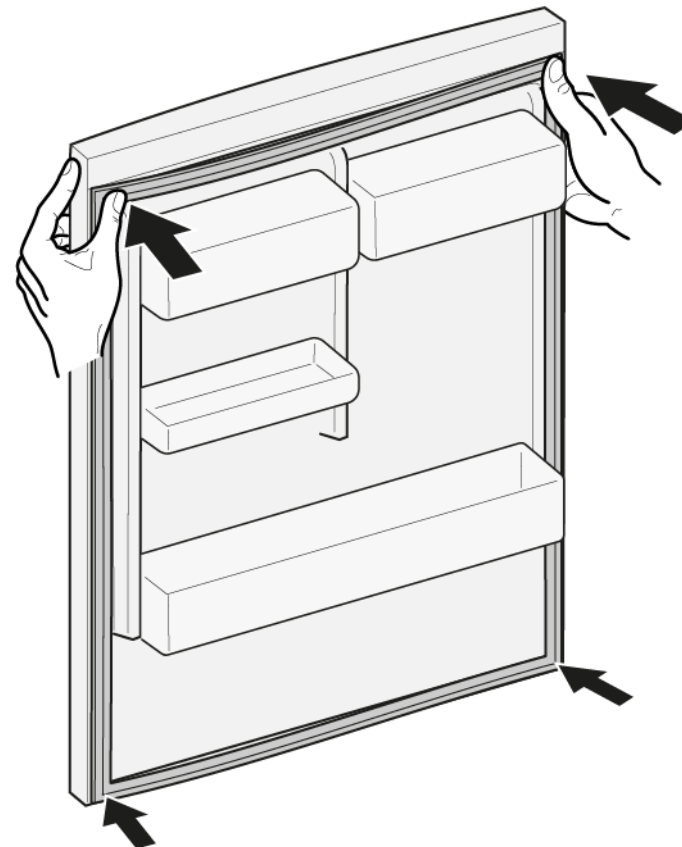

2.  Si la rainure de joint est endommagée.
- Contacter le service après-vente.

3.  Une légère déformation du joint est normale et ne saurait en affecter le fonctionnement. Il est recommandé de redresser le joint de porte avant de l'insérer dans l'appareil.

Réchauffer le joint de porte avec un sèche-cheveux ou de l'eau chaude et le reformer manuellement.

Réparation

5. Enfoncer progressivement le joint dans la rainure.

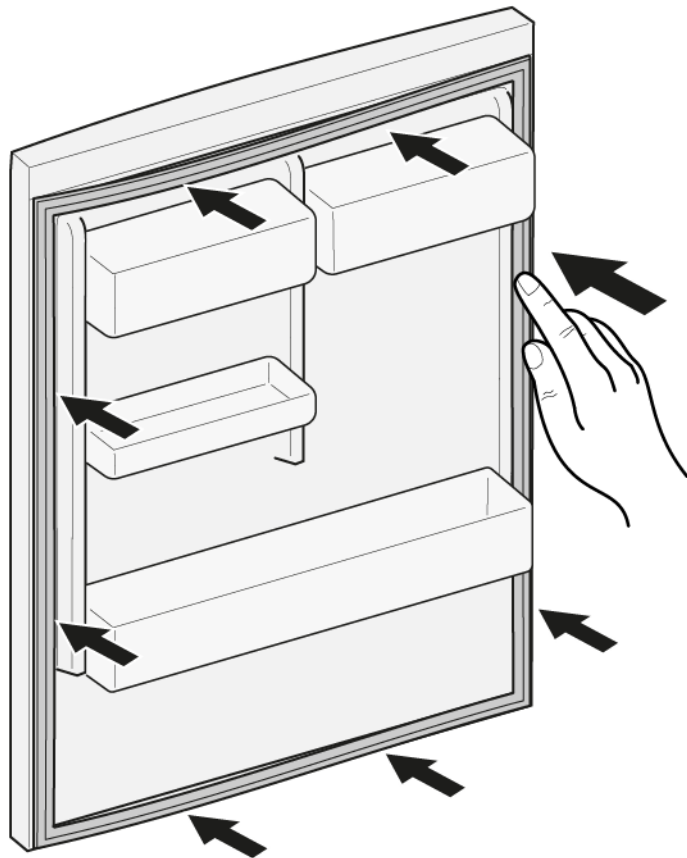



-  Le joint de porte est installé.

4.2 Remplacer la poignée de porte

Outillage nécessaire:

 Clés à douilles hexagonales 2 mm, 2.5 mm, 3 mm, 4 mm, 5 mm, 6 mm, 8 mm [00340819]

Pré-requis:

-  Appareil est déconnecté de l'alimentation.
-  La porte est ouverte.

4.2.1 Retirer la poignée de porte

1. 1. Dévisser deux vis (1).
2. 2. Retirer la poignée de porte (2).

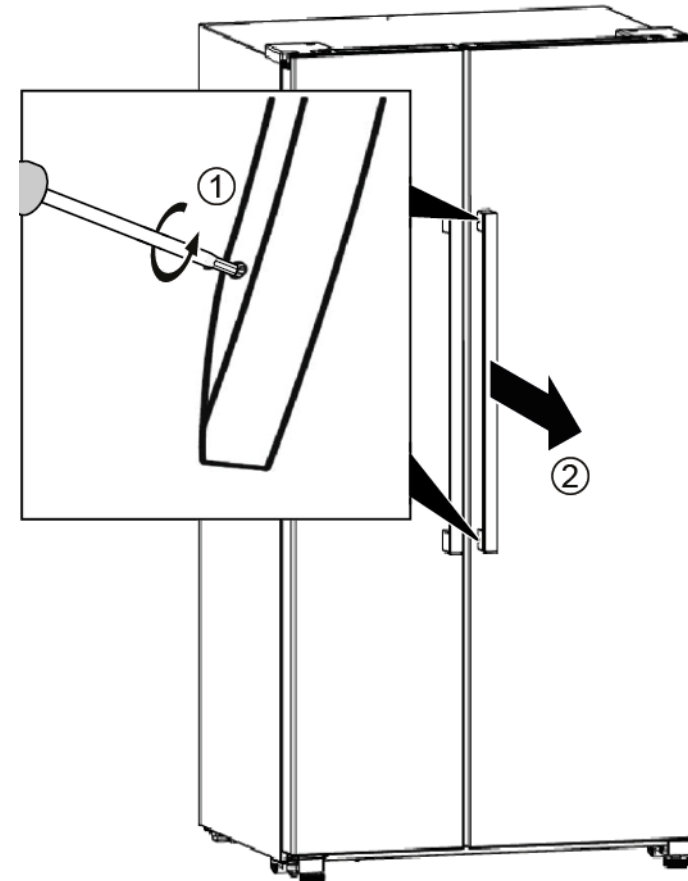

 La poignée de porte est retirée.

2. Retirer la deuxième poignée de porte de la même manière.

4.2.2 Monter la poignée de porte

- ▶ Le montage s'effectue dans l'ordre chronologique inverse.

4.3 Remplacer la tablette

Pré-requis:

- ✔ La porte est ouverte.

4.3.1 Retirer la tablette

- ▶ Extraire la tablette.

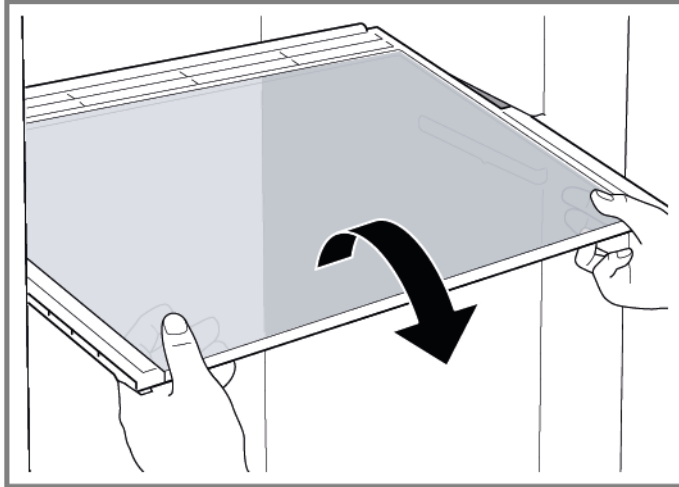

- ➡ La tablette est retirée.

4.3.2 Monter la tablette

- ▶ Le montage s'effectue dans l'ordre chronologique inverse.

4.4 Remplacer le casier à bouteilles

Pré-requis:

- ✔ La porte est ouverte.

4.4.1 Retirer le casier à bouteilles

- ▶ Extraire le casier à bouteilles.

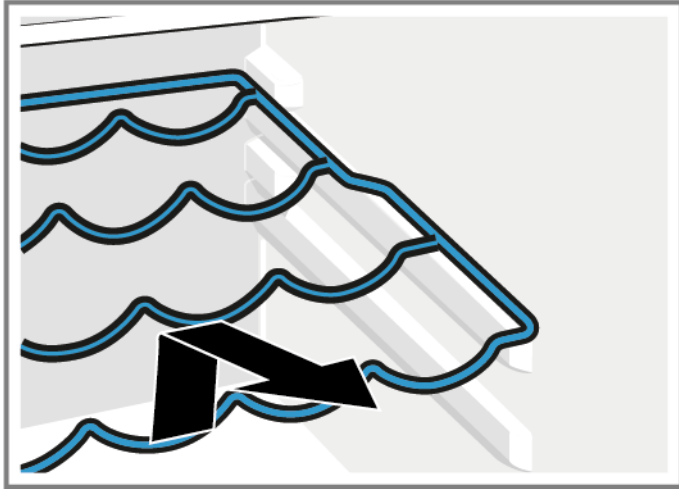

- ➡ Le casier à bouteilles est retiré.

4.4.2 Monter le casier à bouteilles

- ▶ Le montage s'effectue dans l'ordre chronologique inverse.

4.5 Remplacer l'étagère de la porte

Pré-requis:

- ✔ La porte est ouverte.

4.5.1 Retirer l'étagère de la porte

- ▶ Soulever l'étagère de la porte.

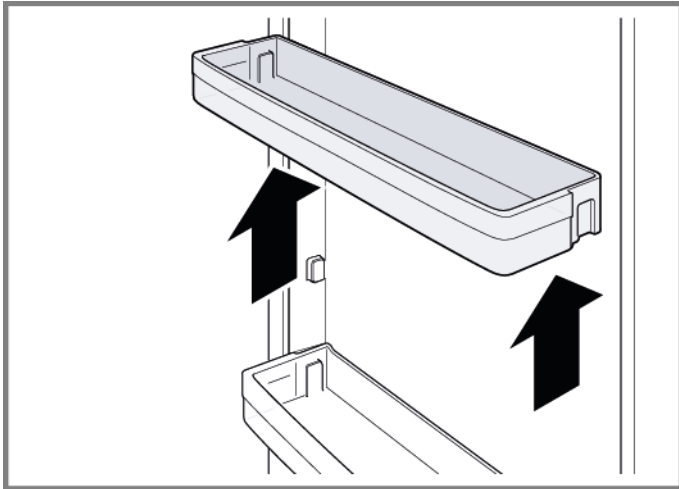

- ➡ L'étagère de la porte est retirée.

4.5.2 Monter l'étagère de la porte

- ▶ Le montage s'effectue dans l'ordre chronologique inverse.

4.6 Remplacer les bacs

Pré-requis:

- ✔ La porte est ouverte.

4.6.1 Retirer les bacs

- ▶ Extraire le bac au complet, le soulever pour le détacher du support et le retirer.

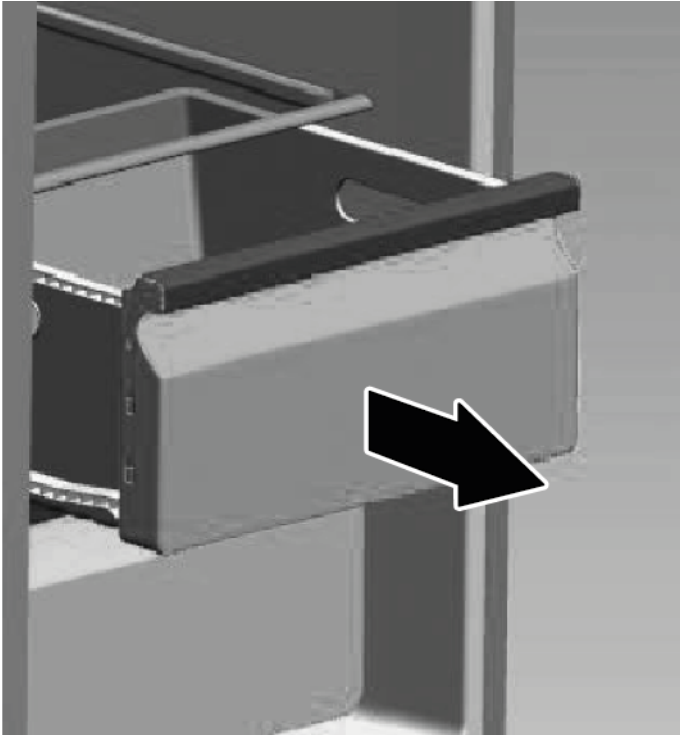



- ➡ Le bac est retiré.



4.6.2 Monter les bacs

- ▶ Le montage s'effectue dans l'ordre chronologique inverse.

4.7 Remplacer la lampe LED

	Votre appareil comprend un éclairage LED sans maintenance. Ces lampes peuvent être réparées exclusivement par le service après-vente ou un technicien autorisé.
-----------------------------------------------------------------------------------	-----------------------------------------------------------------------------------------------------------------------------------------------------------------

	 DANGER Risque d'électrocution en raison de pièces sous tension ! Risque d'électrocution en cas de réparation non conforme <ul style="list-style-type: none">▶ Les pièces électriques doivent être réparées par des techniciens qualifiés.▶ Après la réparation, effectuer un test de sécurité selon VDE 0701 ou les réglementations spécifiques nationales.
----------------------------------------------------------------------------------	------------------------------------------------------------------------------------------------------------------------------------------------------------------------------------------------------------------------------------------------------------------------------------------------------------------------------------------------------------------------------------------------------------------------------------------------------------------------------------------

	 PRUDENCE Arêtes vives ! Blessures par coupure <ul style="list-style-type: none">▶ Porter des gants de protection.
----------------------------------------------------------------------------------	---------------------------------------------------------------------------------------------------------------------------------------------------------------------------------------------------------------------------------------

Pré-requis:

- ✔ Appareil est déconnecté de l'alimentation.
- ✔ La porte est ouverte.
- ✔ La tablette supérieure est retirée.

4.7.1 Retirer la lampe LED

1. Saisir le cache de la lampe LED avec les deux mains et tirer vers le bas



- ➡ Le cache de la lampe LED est retiré.



2. Tirer et retirer la lampe LED



3. Débrancher le terminal



- ➡ La lampe LED est retirée

4.7.2 Monter la lampe LED

- ▶ Le montage s'effectue dans l'ordre chronologique inverse.

Reparatur Hinweise - Kühl- und Gefrierkombination

 Zu diesem Dokument	138
1.1 Wichtige Hinweise:	138
1.1.1 Zweck	138
1.2 Zeichenerklärung.....	138
1.2.1 Gefahrenstufen	138
1.2.2 Gefahrensymbole.....	138
1.2.3 Struktur der Warnhinweise.....	139
1.2.4 Allgemeine Symbole	139
 Sicherheit	140
2.1 Allgemeine Sicherheitshinweise	140
2.1.1 Alle Hausgeräte	140
 Werkzeuge und Hilfsmittel	141
 Instandsetzen	142
4.1 Austauschen der Türdichtung.....	142
4.1.1 Ausbauen der Türdichtung.....	142
4.1.2 Einbauen der Türdichtung	142
4.2 Austauschen des Türgriffs.....	145
4.2.1 Ausbauen des Türgriffs	145
4.2.2 Einbauen des Türgriffs	145
4.3 Austauschen der Ablage	146
4.3.1 Ausbauen der Ablage.....	146
4.3.2 Einbauen der Ablage.....	146
4.4 Austauschen der Flaschenablage.....	147
4.4.1 Ausbauen der Flaschenablage.....	147
4.4.2 Einbauen der Flaschenablage.....	147
4.5 Austauschen des Türabstellers.....	148
4.5.1 Ausbauen des Türabstellers	148
4.5.2 Einbauen des Türabstellers	148
4.6 Austauschen der Behälter	149
4.6.1 Ausbauen der Behälter.....	149
4.6.2 Einbauen der Behälter.....	149
4.7 Austauschen der LED-Lampe.....	150
4.7.1 Ausbauen der LED-Lampe	150
4.7.2 Einbauen der LED-Lampe	151

Zu diesem Dokument

1.1 Wichtige Hinweise:

1.1.1 Zweck

Diese Reparaturhinweise dienen zur Unterstützung des Kunden bei der selbständigen Geräte-Reparatur gemäß der entsprechenden Ökodesign-Richtlinie (ab 03/2021).

Sie enthalten Informationen zum Austausch bestimmter Ersatzteile sowie Warn- und Gefahrenhinweise.

Bitte wenden Sie sich in Zweifelsfällen an unseren Kundendienst. Bei nicht ordnungsgemäßer Befolgung der Reparaturhinweise ist die Schadenshaftung ausgeschlossen.

1.2 Zeichenerklärung

1.2.1 Gefahrenstufen

Die Gefahrenstufen bestehen aus einem Symbol und einem Signalwort. Das Signalwort kennzeichnet die Schwere der Gefahr.









Gefahrenstufe	Bedeutung
	Nichtbeachtung des Warnhinweises führt zu Tod oder schweren Verletzungen.
	Nichtbeachtung des Warnhinweises kann zu Tod oder schweren Verletzungen führen.
	Nichtbeachtung des Warnhinweises kann zu leichten Verletzungen führen.
	Nichtbeachtung des Warnhinweises kann zu Sachschäden führen.

Tabelle 1: Gefahrenstufen

1.2.2 Gefahrensymbole

Gefahrensymbole sind sinnbildliche Darstellungen, die einen Hinweis auf die Art der Gefahr geben.

In diesem Dokument werden folgende Gefahrensymbole verwendet:

Gefahrensymbol	Bedeutung
	Allgemeiner Warnhinweis
	Gefahr durch elektrische Spannung
	Gefahr durch Explosion
	Gefahr von Schnittverletzungen
	Gefahr von Quetschverletzungen

Zu diesem Dokument





Gefahrensymbol	Bedeutung
	Gefahr durch heiße Oberflächen
	Gefahr durch starkes Magnetfeld
	Gefahr durch nicht ionisierende Strahlung

Tabelle 2: Gefahrensymbole

1.2.3 Struktur der Warnhinweise

Warnhinweise haben in diesem Dokument ein einheitliches Aussehen und eine einheitliche Struktur.



	 GEFAHR
	<p>Art und Quelle der Gefahr! Mögliche Folgen bei Nichtbeachtung der Gefahr / des Warnhinweises.</p> <ul style="list-style-type: none"> ▶ Maßnahmen und Verbote zur Vermeidung der Gefahr.

Das folgende Beispiel zeigt einen Warnhinweis, der vor Stromschlaggefahr durch spannungsführende Teile warnt. Die Maßnahme zur Vermeidung der Gefahr wird genannt.

	 GEFAHR
	<p>Stromschlaggefahr durch spannungsführende Teile! Tod durch Stromschlag</p> <ul style="list-style-type: none"> ▶ Gerät mindestens 60 Sekunden vor Reparaturbeginn vom Netz trennen.

1.2.4 Allgemeine Symbole

In diesem Dokument werden folgende allgemeine Symbole verwendet:

Allg. Symbol	Bedeutung
	Kennzeichnung eines besonderen (Text und/oder Grafik) Tipps
	Kennzeichnung eines einfachen (nur Text) Tipps

Allg. Symbol	Bedeutung
	Kennzeichnung eines Links zu einer Videoanleitung
	Kennzeichnung erforderlicher Werkzeuge
	Kennzeichnung erforderlicher Voraussetzungen
	Kennzeichnung einer Bedingung (Wenn ..., dann ...)
	Kennzeichnung eines Ergebnisses
[Start]	Kennzeichnung einer Taste oder Schaltfläche
[00123456]	Kennzeichnung einer Materialnummer
Status	Kennzeichnung eines angezeigten Textes / Fensters (im Gerätedisplay)

Tabelle 3: Allgemeine Symbole

2.1 Allgemeine Sicherheitshinweise

2.1.1 Alle Hausgeräte

Stromschlaggefahr durch spannungsführende Teile!

- Wenn elektrische Komponenten fehlerhaft repariert werden, besteht Stromschlaggefahr!
- Das Gerät mindestens 60 Sekunden vor Beginn der Arbeiten vom Netz trennen.
- Nach der Reparatur muss eine Sicherheitsprüfung nach VDE 0701 oder länderspezifischen Vorschriften durchgeführt werden.

Verletzungsgefahr durch scharfe Kanten!

- Schutzhandschuhe tragen.

Quetschgefahr während Reparatur-, Wartungs-, Fehlersuche- und Servicearbeiten durch schwere sich bewegende Bauteile

- Schutzhandschuhe tragen.
- Schwere Bauteile gegen Herabfallen sichern.
- Körperteile nicht in sich bewegende Bauteile stecken.



Gefährdung der Gerätesicherheit/-funktion!

- Ausschließlich Originalersatzteile verwenden.

Gefahr der Beschädigung elektrostatisch gefährdeter Bauteile (elektrostatische Entladungen)!

- Die Module, einschließlich ihrer Anschlüsse und Leiterbahnen, keinesfalls berühren.

Werkzeuge und Hilfsmittel

Bezeichnung	Details	Bilder
Schutztuch [00342013]	60 cm x 50 cm	
Innensechskant- schlüssel [00340819]	2 mm, 2,5 mm, 3 mm, 4 mm, 5 mm, 6 mm, 8 mm	

4.1 Austauschen der Türdichtung

Voraussetzung:

- ✔ Die Tür ist offen.

4.1.1 Ausbauen der Türdichtung

1. Die Türdichtung aus der Kerbe in der rechten und linken Ecke lösen.

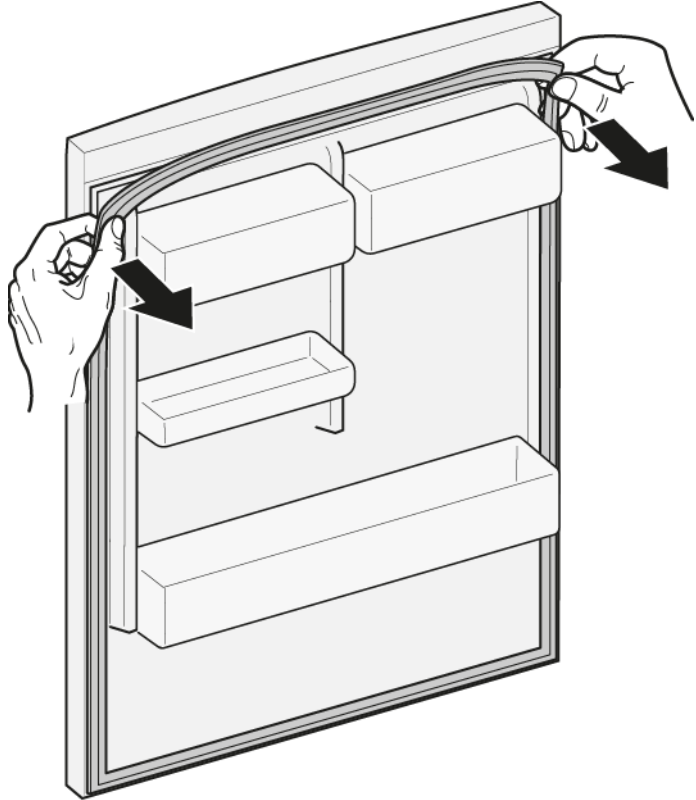

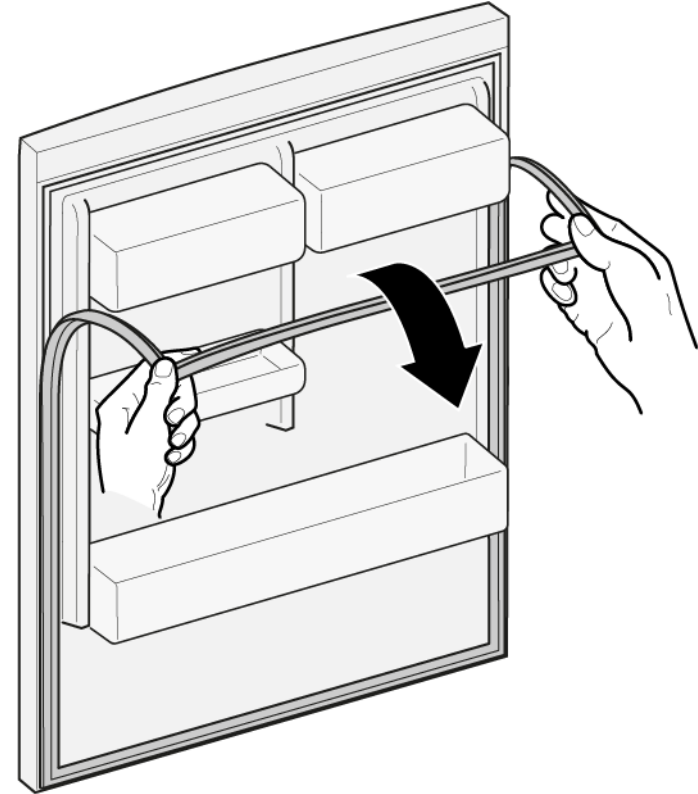

2. Die Türdichtung aus der Kerbe herausziehen.



- ➡ Die Türdichtung ist entfernt.

4.1.2 Einbauen der Türdichtung

	Die Dicke neuer Türdichtungen kann geringfügig von der Dicke alter Türdichtungen abweichen. Dies hat auf das Schließverhalten und die langfristige Funktion keinen Einfluss.
	Wenn das Gerät mit einstellbaren Scharnieren oder Scharnierbefestigungen ausgestattet ist, kann das Schließverhalten anschließend optimiert werden.
	Die kleinen seitlichen Löcher in der Türdichtung haben eine wichtige Funktion (für Lüftung erforderlich). Es handelt sich hierbei nicht um Produktionsfehler.

Instandsetzen

1. Die Dichtungskerbe auf Beschädigungen überprüfen.

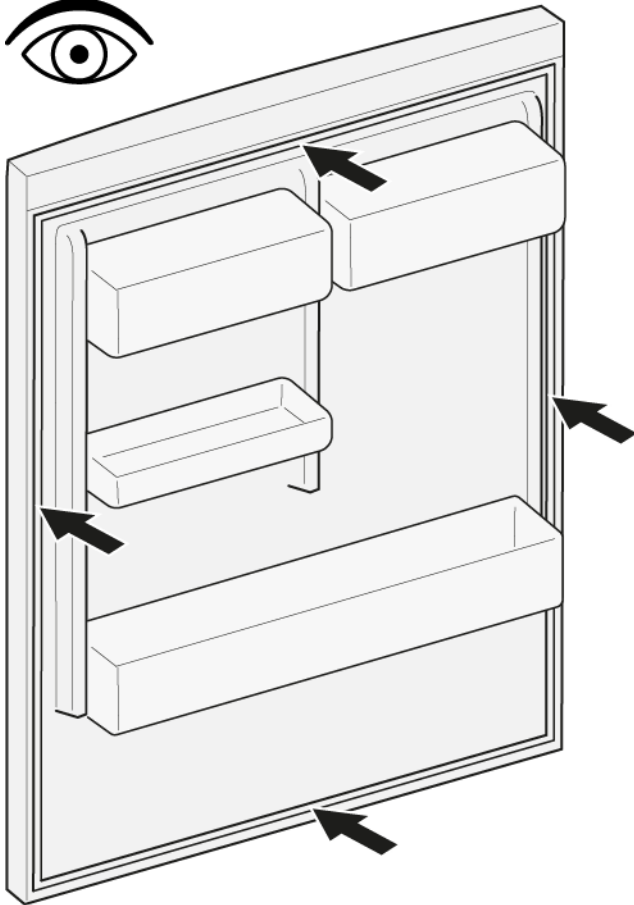

4. Die Dichtungsecken oben und unten in die Kerbe drücken.

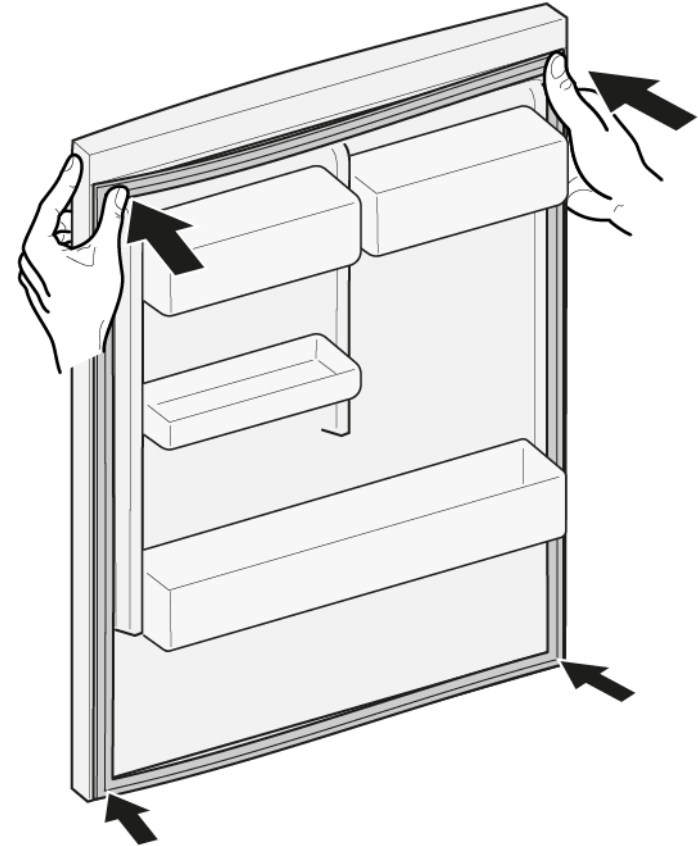

2.  Wenn die Dichtungskerbe beschädigt ist:
 - Den Kundendienst kontaktieren.

3.  Leichte Deformationen der Türdichtung sind normal und beeinträchtigen nicht die Funktion. Es wird empfohlen, die Türdichtung vor dem Einsetzen in das Gerät zu begradigen.

Die Türdichtung mit einem Haartrockner oder mit heißem Wasser erwärmen und von Hand in die richtige Form bringen.

Instandsetzen

5. Die gesamte Dichtung Stück für Stück in die Kerbe drücken.

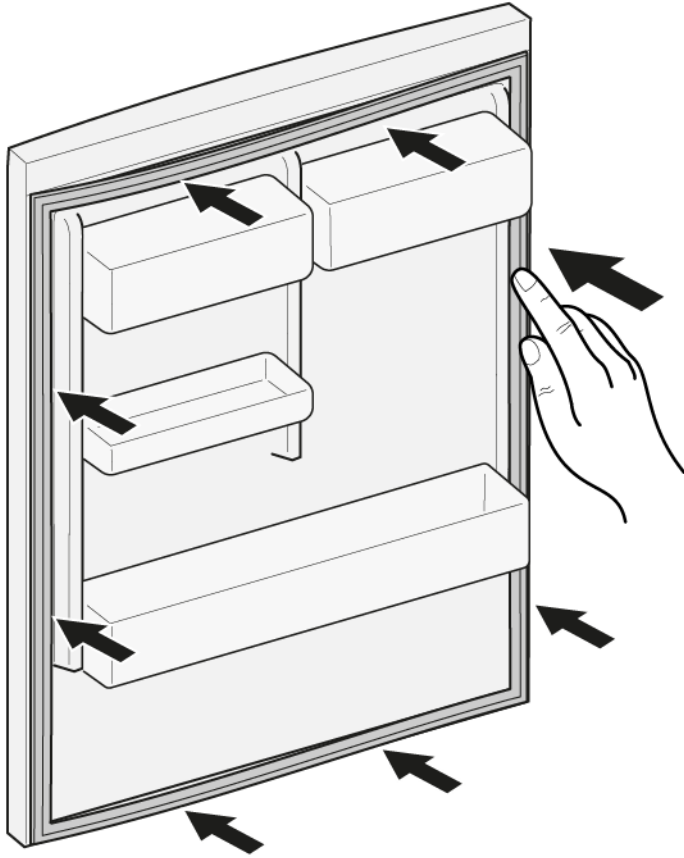



-  Die Türdichtung ist eingebaut.

4.2 Austauschen des Türgriffs

Spezielle Hilfsmittel:

 Innensechskantschlüssel 2 mm, 2,5 mm, 3 mm, 4 mm, 5 mm, [00340819]
6 mm, 8 mm

Voraussetzung:

-  Das Gerät ist spannungsfrei.
-  Die Tür ist offen.

4.2.1 Ausbauen des Türgriffs

1. 1. Die beiden Schrauben herausschrauben (1).
2. Den Türgriff entfernen (2).

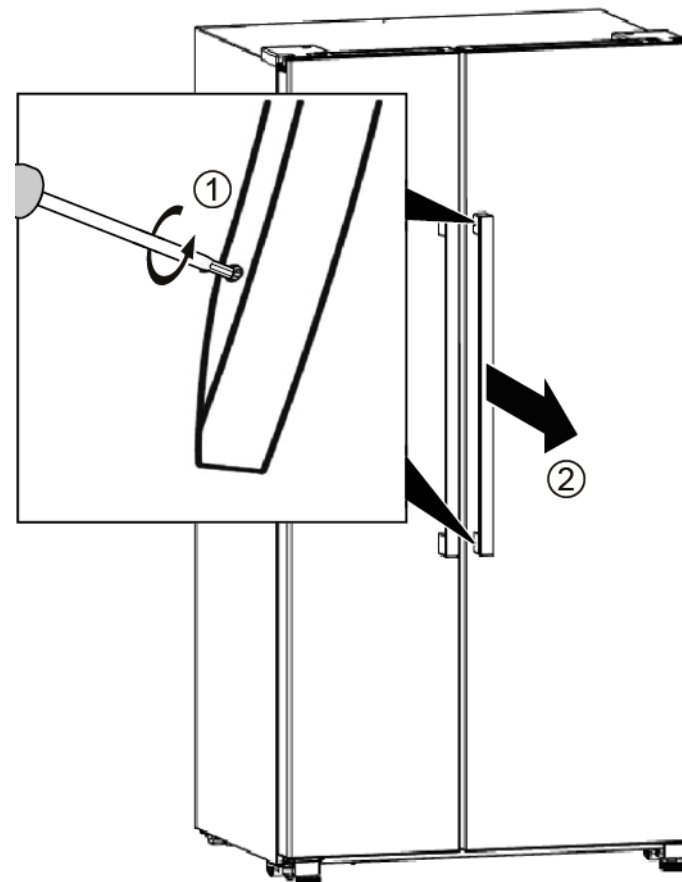

 Der Türgriff ist entfernt.

2. Den zweiten Türgriff auf die gleiche Art und Weise entfernen.

4.2.2 Einbauen des Türgriffs

- ▶ Der Einbau erfolgt in umgekehrter Reihenfolge.

4.3 Austauschen der Ablage

Voraussetzung:

- ✔ Die Tür ist offen.

4.3.1 Ausbauen der Ablage

- ▶ Die Ablage herausziehen.

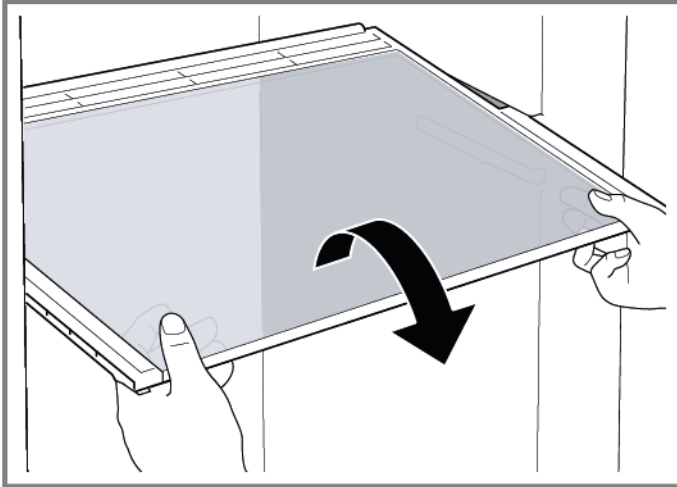

- ➡ Die Ablage ist entfernt.

4.3.2 Einbauen der Ablage

- ▶ Der Einbau erfolgt in umgekehrter Reihenfolge.

4.4 Austauschen der Flaschenablage

Voraussetzung:

- ✔ Die Tür ist offen.

4.4.1 Ausbauen der Flaschenablage

- ▶ Die Flaschenablage herausziehen.

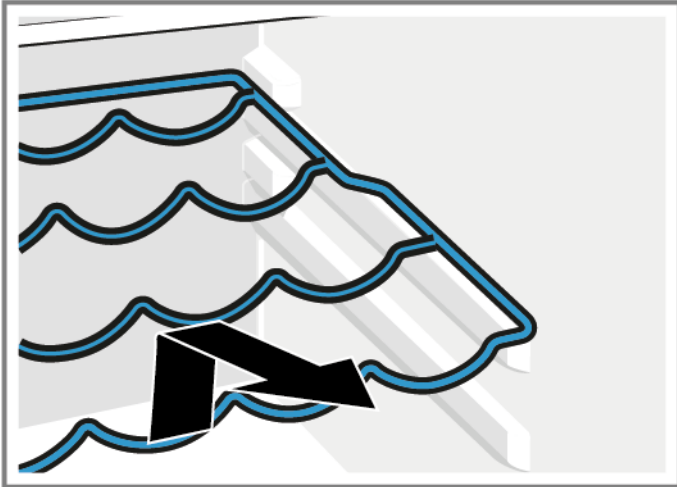

- ➡ Die Flaschenablage ist entfernt.

4.4.2 Einbauen der Flaschenablage

- ▶ Der Einbau erfolgt in umgekehrter Reihenfolge.

4.5 Austauschen des Türabstellers

Voraussetzung:

- ✔ Die Tür ist offen.

4.5.1 Ausbauen des Türabstellers

- ▶ Den Türabsteller anheben.

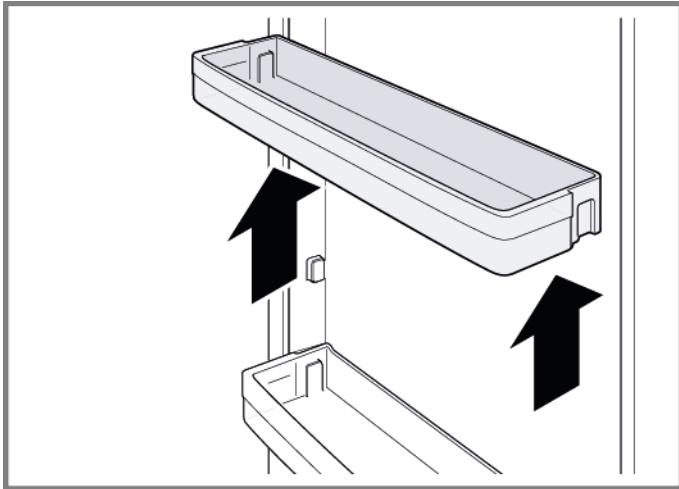

- ➡ Der Türabsteller ist entfernt.

4.5.2 Einbauen des Türabstellers

- ▶ Der Einbau erfolgt in umgekehrter Reihenfolge.

4.6 Austauschen der Behälter

Voraussetzung:

- ✔ Die Tür ist offen.

4.6.1 Ausbauen der Behälter

- ▶ Den Behälter vollständig herausziehen, durch Anheben aus der Halterung lösen und herausnehmen.

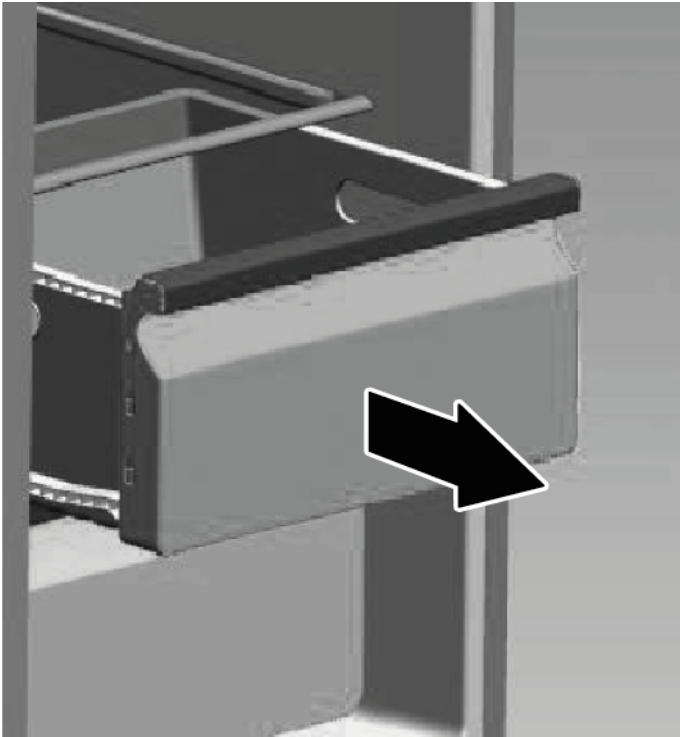

- ➡ Der Behälter ist entfernt.

4.6.2 Einbauen der Behälter

- ▶ Der Einbau erfolgt in umgekehrter Reihenfolge.

4.7 Austauschen der LED-Lampe

i Ihr Gerät ist mit einer wartungsfreien LED-Beleuchtung ausgestattet. Reparaturen an dieser Beleuchtung dürfen nur vom Kundendienst oder von autorisierten Fachkräften ausgeführt werden!

⚠️ GEFAHR
Stromschlaggefahr durch spannungsführende Teile!
Lebensgefahr durch Stromschlag bei unsachgemäßer Reparatur

- ▶ Elektroteile sollten von einer Elektrofachkraft repariert werden.
- ▶ Nach der Reparatur muss eine Sicherheitsprüfung nach VDE 0701 oder länderspezifischen Vorschriften durchgeführt werden.

⚠️ VORSICHT
Scharfe Kanten!
Schnittverletzungen

- ▶ Schutzhandschuhe tragen.

Voraussetzung:

- ✔ Das Gerät ist spannungsfrei.
- ✔ Die Tür ist offen.
- ✔ Die obere Ablage ist entfernt.

4.7.1 Ausbauen der LED-Lampe

1. Die Abdeckung der LED-Lampe mit beiden Händen fassen und nach unten ziehen.



- ➡ Die Abdeckung der LED-Lampe ist entfernt.



2. Die LED-Lampe herausziehen und entnehmen.



3. Den Anschluss ausstecken.







- ➡ Die LED-Lampe ist entfernt.

4.7.2 Einbauen der LED-Lampe

- ▶ Der Einbau erfolgt in umgekehrter Reihenfolge.

Υποδείξεις επισκευής - Ψυγειοκαταψύκτης

 Σχετικά με αυτό το έγγραφο	153
1.1 Σημαντικές πληροφορίες	153
1.1.1 Σκοπός.....	153
1.2 Επεξήγηση συμβόλων	153
1.2.1 Επίπεδα κινδύνου	153
1.2.2 Σύμβολα κινδύνου.....	153
1.2.3 Δομή των προειδοποιήσεων	154
1.2.4 Γενικά σύμβολα	154
 Ασφάλεια	155
2.1 Γενικές οδηγίες ασφαλείας	155
2.1.1 Όλες οι οικιακές συσκευές	155
 Εργαλεία και βοηθήματα	156
 Επισκευή	157
4.1 Αντικατάσταση στεγανοποιητικού πόρτας	157
4.1.1 Αφαίρεση στεγανοποιητικού πόρτας.....	157
4.1.2 Τοποθέτηση στεγανοποιητικού πόρτας	157
4.2 Αντικατάσταση λαβής πόρτας.....	160
4.2.1 Αφαίρεση λαβής πόρτας.....	160
4.2.2 Τοποθέτηση λαβής πόρτας.....	160
4.3 Αντικατάσταση ραφιού	161
4.3.1 Αφαίρεση ραφιού	161
4.3.2 Τοποθέτηση ραφιού	161
4.4 Αντικατάσταση επιφάνειας εναπόθεσης φιαλών	162
4.4.1 Αφαίρεση επιφάνειας εναπόθεσης φιαλών.....	162
4.4.2 Τοποθέτηση επιφάνειας εναπόθεσης φιαλών.....	162
4.5 Αντικατάσταση ραφιού πόρτας	163
4.5.1 Αφαίρεση ραφιού πόρτας	163
4.5.2 Τοποθέτηση ραφιού πόρτας	163
4.6 Αντικατάσταση συρταριών	164
4.6.1 Αφαίρεση συρταριών.....	164
4.6.2 Τοποθέτηση συρταριών.....	164
4.7 Αντικατάσταση λυχνίας LED.....	165
4.7.1 Αφαίρεση λυχνίας LED	165
4.7.2 Τοποθέτηση λάμπας LED.....	166

i Σχετικά με αυτό το έγγραφο

1.1 Σημαντικές πληροφορίες

1.1.1 Σκοπός

Αυτές οι συμβουλές επισκευών υποστηρίζουν τους καταναλωτές στην επισκευή των συσκευών από τους ίδιους, σύμφωνα με τον ισχύοντα κανονισμό οικολογικού σχεδιασμού (από τις 03/2021).





Περιέχουν πληροφορίες για την αντικατάσταση ορισμένων ανταλλακτικών, συμπεριλαμβανομένων προειδοποιήσεων και κινδύνων.

Σε περίπτωση ερωτήσεων, επικοινωνήστε με το τμήμα εξυπηρέτησης πελατών της εταιρείας μας. Φέρουμε ευθύνη για τις ζημιές εάν οι συμβουλές επισκευής έχουν ακολουθηθεί σωστά.

1.2 Επεξήγηση συμβόλων

1.2.1 Επίπεδα κινδύνου

Τα επίπεδα προειδοποίησης ασφάλειας αποτελούνται από ένα σύμβολο και μια λέξη. Η λέξη προειδοποίησης προσδιορίζει τη σοβαρότητα του κινδύνου.





Επίπεδο προειδοποίησης	Σημασία
 ΚΙΝΔΥΝΟΣ	Η μη τήρηση του προειδοποιητικού μηνύματος θα οδηγήσει σε θάνατο ή σε σοβαρούς τραυματισμούς.
 ΠΡΟΕΙΔΟΠΟΙΗΣΗ	Η μη τήρηση του προειδοποιητικού μηνύματος θα μπορούσε να οδηγήσει σε θάνατο ή σε σοβαρούς τραυματισμούς.
 ΠΡΟΣΟΧΗ	Η μη τήρηση του προειδοποιητικού μηνύματος θα μπορούσε να οδηγήσει σε μικρούς τραυματισμούς.
 ΠΡΟΣΟΧΗ!	Η μη τήρηση του προειδοποιητικού μηνύματος θα μπορούσε να οδηγήσει σε υλικές ζημιές της ιδιοκτησίας.

Πίνακας 1: Επίπεδα κινδύνου





1.2.2 Σύμβολα κινδύνου

Τα σύμβολα κινδύνου είναι συμβολικές αναπαραστάσεις που δίνουν μια ένδειξη για το είδος του κινδύνου.

Τα ακόλουθα σύμβολα κινδύνου χρησιμοποιούνται στο παρόν έγγραφο:

Σύμβολο κινδύνου	Σημασία
	Γενικό προειδοποιητικό μήνυμα
	Κίνδυνος από ηλεκτρική τάση
	Κίνδυνος έκρηξης
	Κίνδυνος κοψίματος

i Σχετικά με αυτό το έγγραφο

Σύμβολο κινδύνου	Σημασία
	Κίνδυνος σύνθλιψης
	Κίνδυνος από καυτές επιφάνειες
	Κίνδυνος από ισχυρό μαγνητικό πεδίο
	Κίνδυνος από μη ιονίζουσα ακτινοβολία

Πίνακας 2: Σύμβολα κινδύνου

1.2.3 Δομή των προειδοποιήσεων

.Οι προειδοποιήσεις σε αυτό το έγγραφο έχουν μια τυποποιημένη εμφάνιση και μια τυποποιημένη δομή.









	⚠ ΚΙΝΔΥΝΟΣ
Είδος και πηγή κινδύνου!	
Πιθανές συνέπειες εάν αγνοήσετε τον κίνδυνο/την προειδοποίηση.	
▶ Μέτρα και απαγορεύσεις για την πρόληψη του κινδύνου.	

Το παρακάτω παράδειγμα δείχνει μια προειδοποίηση που προειδοποιεί κατά της ηλεκτροπληξίας λόγω ηλεκτροφόρων μερών. Αναφέρεται το μέτρο για την αποφυγή του κινδύνου.

	⚠ ΚΙΝΔΥΝΟΣ
Κίνδυνος ηλεκτροπληξίας λόγω ηλεκτροφόρων μερών!	
Θάνατος από ηλεκτροπληξία	
▶ Αποσυνδέετε τις συσκευές από την παροχή ηλεκτρικού ρεύματος τουλάχιστον 60 δευτερόλεπτα πριν ξεκινήσετε τις επισκευές.	

1.2.4 Γενικά σύμβολα

Τα ακόλουθα γενικά σύμβολα χρησιμοποιούνται στο παρόν έγγραφο:

Γεν. σύμβολο	Σημασία
	Ταυτοποίηση μιας ειδικής συμβουλής (κειμένου ή/και γραφικών)
	Ταυτοποίηση μιας ειδικής συμβουλής (μόνο κειμένου)
	Ταυτοποίηση συνδέσμου ή εκπαιδευτικού βίντεο
	Ταυτοποίηση απαραίτητων εργαλείων
	Ταυτοποίηση απαραίτητων προϋποθέσεων
	Ταυτοποίηση μιας συνθήκης (αν ..., κατόπιν ...)
	Ταυτοποίηση αποτελέσματος
	Ταυτοποίηση ενός πλήκτρου ή κουμπιού
[00123456]	Ταυτοποίηση ενός κωδικού ανταλλακτικού
Κατάσταση	Ταυτοποίηση εμφανιζόμενου κειμένου/ παραθύρου (στην οθόνη της συσκευής)

Πίνακας 3: Γενικά σύμβολα

2.1 Γενικές οδηγίες ασφαλείας

2.1.1 Όλες οι οικιακές συσκευές

Κίνδυνος ηλεκτροπληξίας λόγω ηλεκτροφόρων μερών!

- Τα σφάλματα από επισκευές σε ηλεκτρικά εξαρτήματα μπορεί να προκαλέσουν ηλεκτροπληξία!
- Αποσυνδέστε τη συσκευή από την πρίζα για τουλάχιστον 60 δευτερόλεπτα πριν από την έναρξη των εργασιών.
- Μετά την επισκευή πραγματοποιήστε έλεγχο ασφαλείας σύμφωνα με το VDE 0701 ή κανονισμούς της συγκεκριμένης χώρας.

Κίνδυνος τραυματισμού από κοφτερές άκρες!

- Φοράτε προστατευτικά γάντια.

Κίνδυνος σύνθλιψης κατά την επισκευή, συντήρηση, αντιμετώπιση προβλημάτων και το σέρβις από βαριά και κινούμενα μέρη

- Φοράτε προστατευτικά υποδήματα.
- Ασφαλίστε τα βαριά μέρη από πτώση.
- Μην προσαρτάτε μέρη του πλαισίου στα κινούμενα μέρη.



Κίνδυνος για την ασφάλεια/τη λειτουργία της συσκευής!

- Χρησιμοποιείτε μόνο γνήσια ανταλλακτικά.

Κίνδυνος πρόκλησης βλάβης σε μέρη ευαίσθητα στον στατικό ηλεκτρισμό (ESDs)!

- Μην αγγίζετε τις μονάδες, συμπεριλαμβανομένων των συνδέσεων και των αγωγών των πλακετών.

Εργαλεία και βοηθήματα

Όνομασία	Λεπτομέριες	Εικόνες
Πανάκι προστασίας [00342013]	60 cm x 50 cm	
Εξάγωνα κλειδιά [00340819]	2 mm, 2,5 mm, 3 mm, 4 mm, 5 mm, 6 mm, 8 mm	

4.1 Αντικατάσταση στεγανοποιητικού πόρτας

Προϋπόθεση:

- ✔ Η πόρτα είναι ανοιχτή.

4.1.1 Αφαίρεση στεγανοποιητικού πόρτας

1. Απελευθερώστε το στεγανοποιητικό πόρτας από την εγκοπή στη δεξιά και αριστερή γωνία.

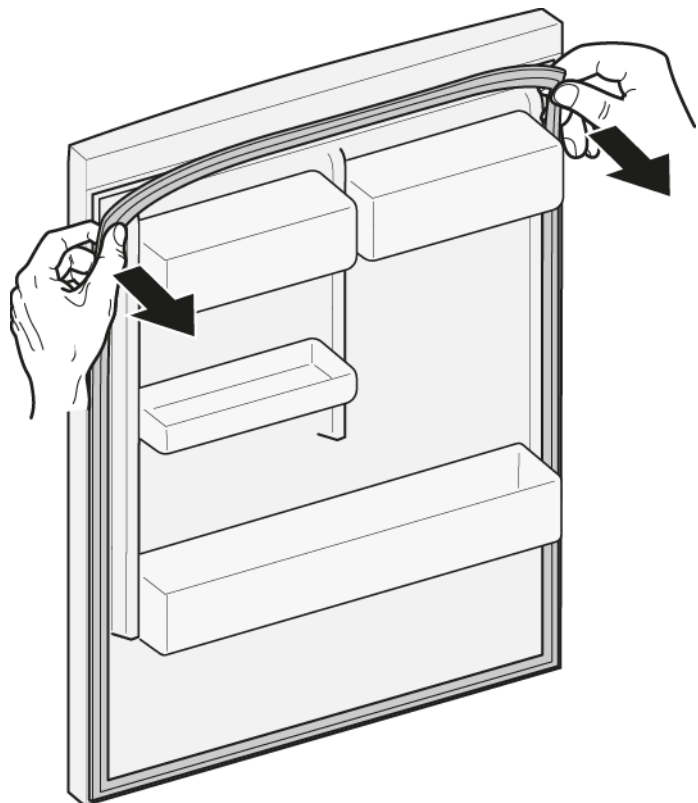

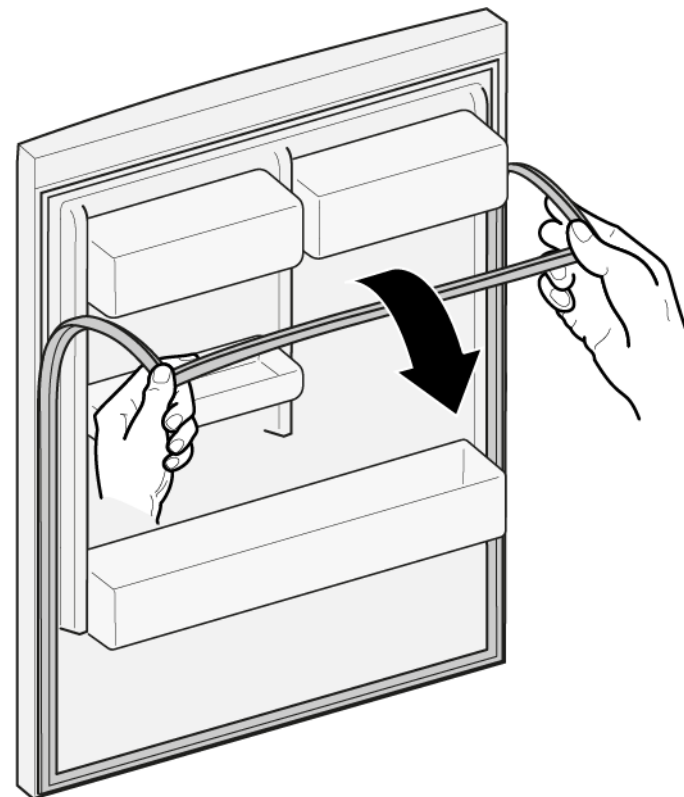

2. Τραβήξτε το στεγανοποιητικό πόρτας έξω από την εγκοπή.



- ➡ Το στεγανοποιητικό της πόρτας έχει αφαιρεθεί.

4.1.2 Τοποθέτηση στεγανοποιητικού πόρτας

	Το πάχος του νέου στεγανοποιητικού πόρτας μπορεί να αποκλίνει ελαφρώς από το πάχος του παλαιού στεγανοποιητικού πόρτας. Αυτό δεν θα επηρεάσει τη συμπεριφορά κλεισίματος και τη μακροπρόθεσμη λειτουργία.
	Εάν η συσκευή σας έχει προσαρμοζόμενους μεντεσέδες ή προσαρτήματα μεντεσέ, μπορεί να βελτιστοποιήσετε τη συμπεριφορά κλεισίματος αργότερα.
	Οι μικρές οπές πλευρικά στο στεγανοποιητικό της πόρτας είναι λειτουργικές (απαραίτητες για τον αερισμό). Δεν είναι κατασκευαστικά ελαττώματα.

1. Ελέγξτε την εγκοπή για το στεγανοποιητικό για ζημιές.

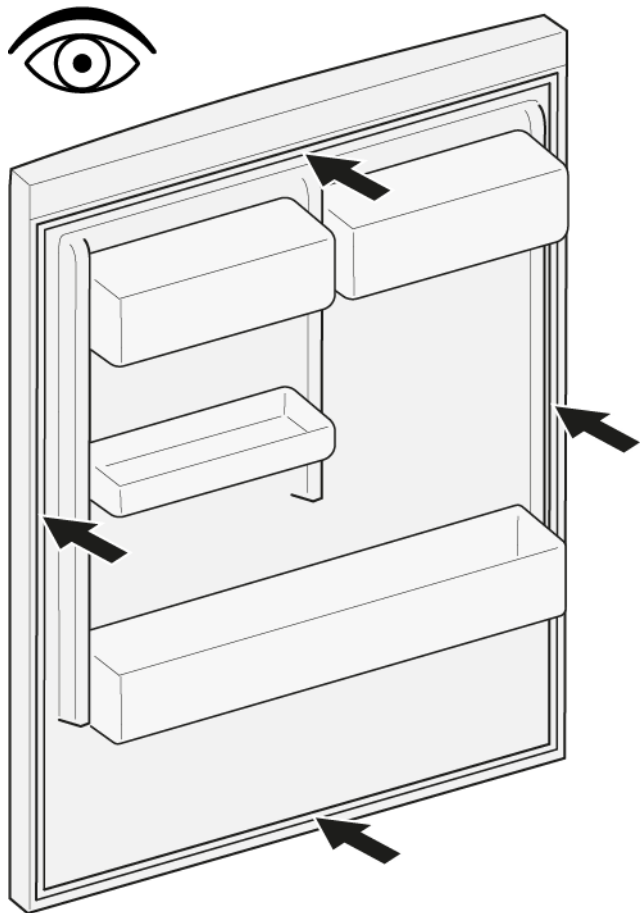

4. Πιέστε τις γωνίες του στεγανοποιητικού επάνω και κάτω στην εγκοπή.

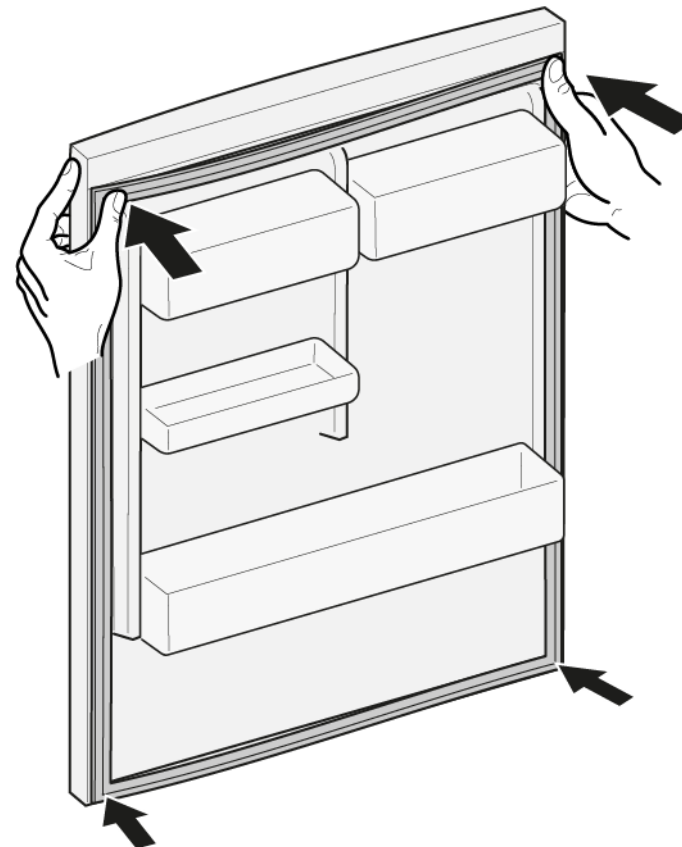



2. ⓘ Εάν η εγκοπή για στεγανοποιητικό είναι κατεστραμμένη.
- Επικοινωνήστε με την εξυπηρέτηση πελατών.

3. ⓘ Η ελαφριά παραμόρφωση του στεγανοποιητικού της πόρτας είναι φυσιολογική και δεν επηρεάζει τη λειτουργία της. Συνιστάται να ισιώνετε το στεγανοποιητικό της πόρτας πριν την τοποθετήσετε στη συσκευή.

Θερμάνετε το στεγανοποιητικό της πόρτας με πιστολάκι ή ζεστό νερό και αλλάξτε το σχήμα του με το χέρι.

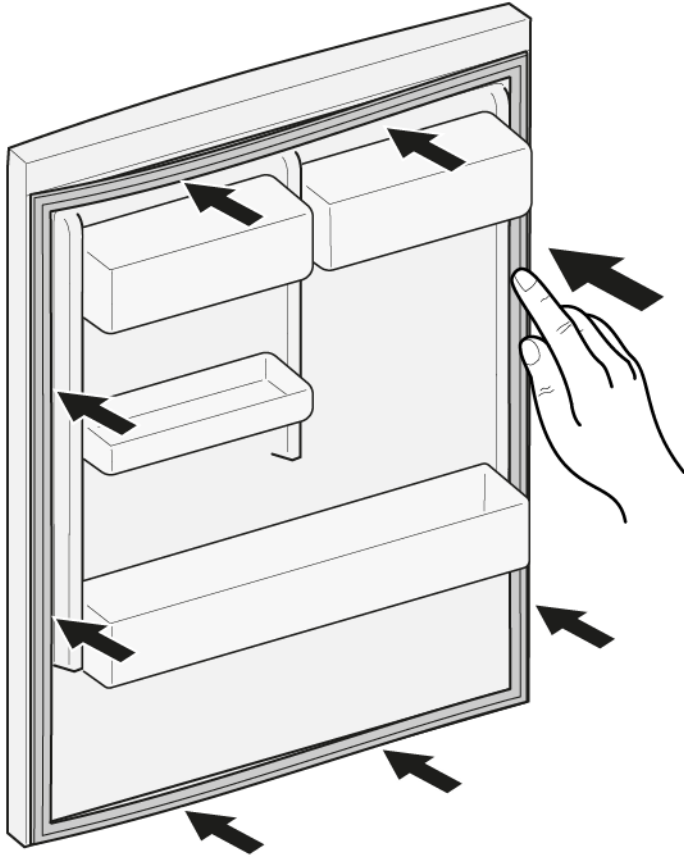
5. Πιέστε ολόκληρο το στεγανοποιητικό βήμα βήμα στο εσωτερικό της εγκοπής.



-  Το στεγανοποιητικό της πόρτας τοποθετήθηκε.

4.2 Αντικατάσταση λαβής πόρτας

Ειδικά βοηθητικά μέσα:

🌀 Εξάγωνο κλειδιά 2 mm, 2,5 mm, 3 mm, 4 mm, 5 mm, 6 mm, 8 mm [00340819]

Προϋπόθεση:

- ✔ Η συσκευή είναι αποσυνδεδεμένη από την παροχή τροφοδοσίας.
- ✔ Η πόρτα είναι ανοιχτή.

4.2.1 Αφαίρεση λαβής πόρτας

1. Ξεβιδώστε δύο βίδες (1).
2. Αφαιρέστε τη λαβή της πόρτας (2).

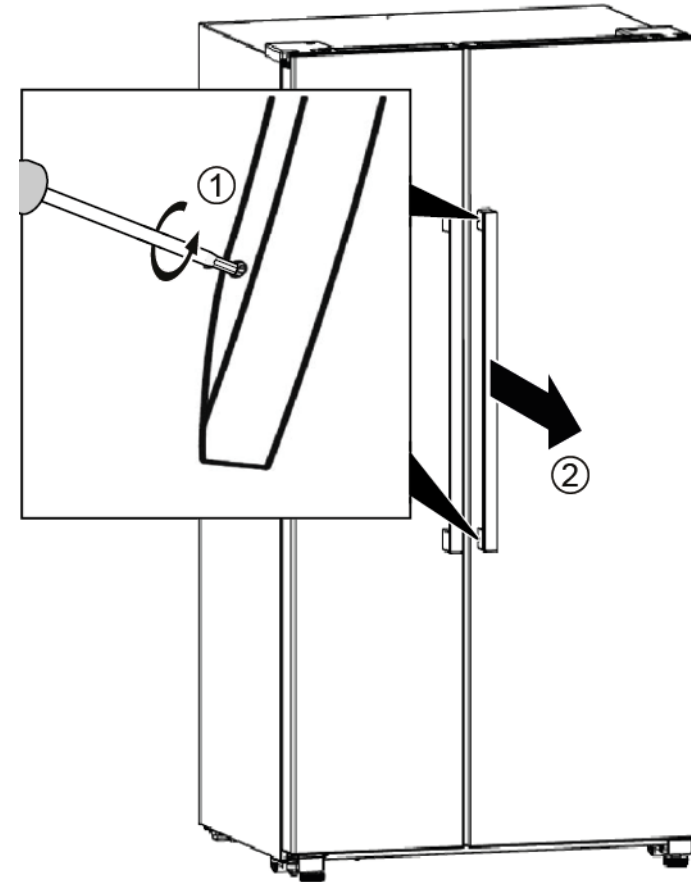

➡ Η λαβή της πόρτας έχει αφαιρεθεί.

2. Αφαιρέστε τη δεύτερη λαβή της πόρτας με τον ίδιο τρόπο.

4.2.2 Τοποθέτηση λαβής πόρτας

- ▶ Εγκαταστήστε με την αντίθετη σειρά.

4.3 Αντικατάσταση ραφιού

Προϋπόθεση:

- ✔ Η πόρτα είναι ανοιχτή.

4.3.1 Αφαίρεση ραφιού

- ▶ Τραβήξτε το ράφι προς τα έξω.

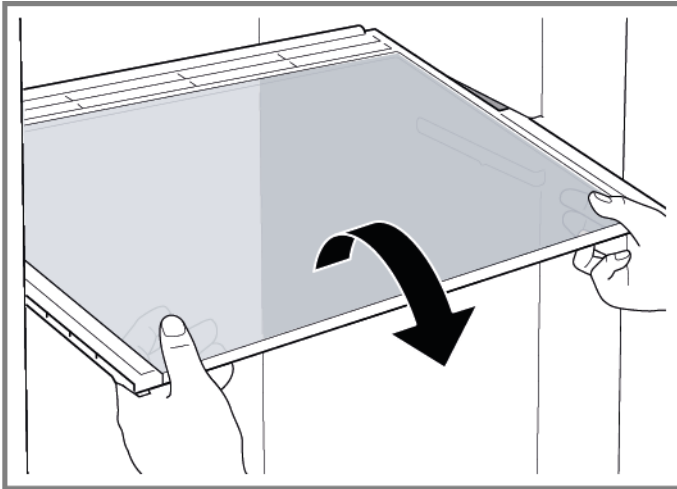

- ➡ Το ράφι αφαιρέθηκε.

4.3.2 Τοποθέτηση ραφιού

- ▶ Εγκαταστήστε με την αντίθετη σειρά.

4.4 Αντικατάσταση επιφάνειας εναπόθεσης φιαλών

Προϋπόθεση:

- ✔ Η πόρτα είναι ανοιχτή.

4.4.1 Αφαίρεση επιφάνειας εναπόθεσης φιαλών

- ▶ Τραβήξτε προς τα έξω την επιφάνεια εναπόθεσης φιαλών.

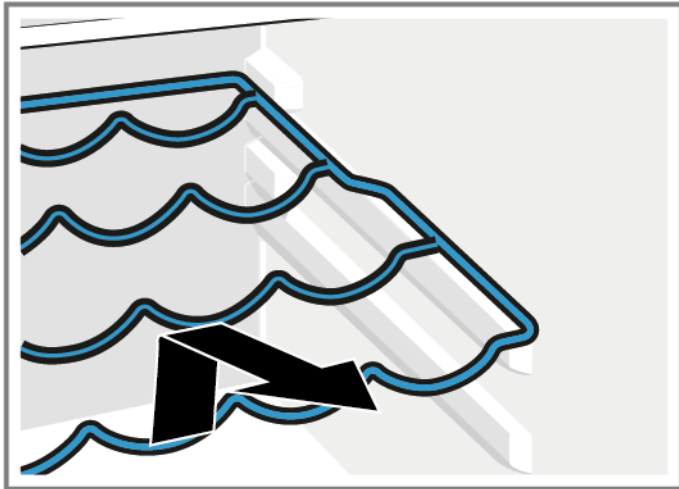

- ➡ Η επιφάνεια εναπόθεσης φιαλών έχει αφαιρεθεί.

4.4.2 Τοποθέτηση επιφάνειας εναπόθεσης φιαλών

- ▶ Εγκαταστήστε με την αντίθετη σειρά.

4.5 Αντικατάσταση ραφιού πόρτας

Προϋπόθεση:

- ✔ Η πόρτα είναι ανοιχτή.

4.5.1 Αφαίρεση ραφιού πόρτας

- ▶ Ανασηκώστε το ράφι πόρτας προς τα επάνω.

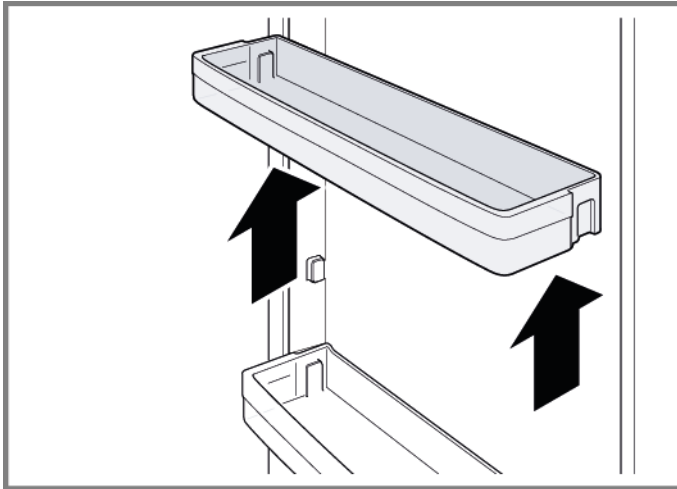

➡ Το ράφι πόρτας έχει αφαιρεθεί.

4.5.2 Τοποθέτηση ραφιού πόρτας

- ▶ Εγκαταστήστε με την αντίθετη σειρά.

4.6 Αντικατάσταση συρταριών

Προϋπόθεση:

- ✔ Η πόρτα είναι ανοιχτή.

4.6.1 Αφαίρεση συρταριών

- ▶ Τραβήξτε προς τα έξω το συρτάρι μέχρι τέρμα, ανασηκώστε για να απασφαλιστεί από το στήριγμα και αφαιρέστε το.

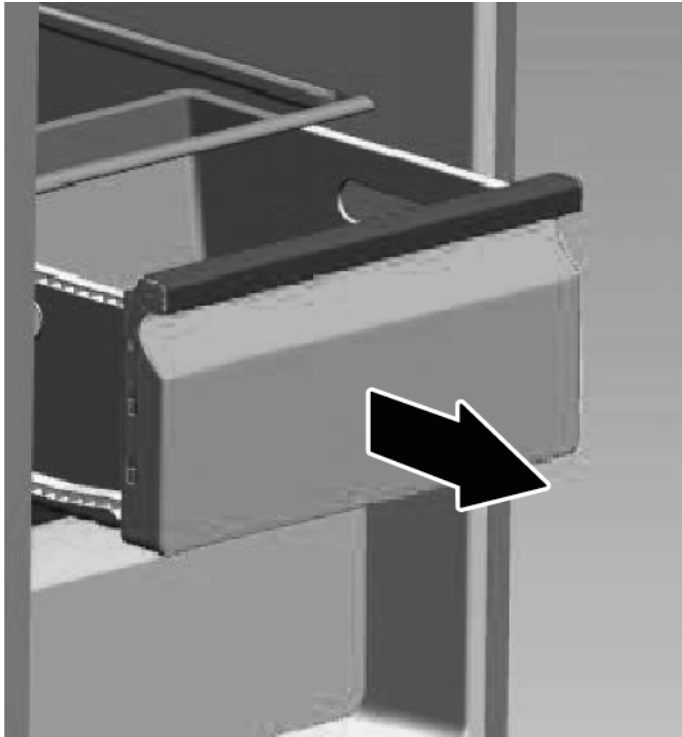

- ➡ Το συρτάρι αφαιρέθηκε.

4.6.2 Τοποθέτηση συρταριών

- ▶ Εγκαταστήστε με την αντίθετη σειρά.

4.7 Αντικατάσταση λυχνίας LED

i Η συσκευή διαθέτει ένα φως LED που δεν χρειάζεται συντήρηση. Αυτά τα φώτα μπορούν να επισκευαστούν μόνο από την εξυπηρέτηση πελατών ή από εξουσιοδοτημένους τεχνικούς!

⚠ ΚΙΝΔΥΝΟΣ
Κίνδυνος ηλεκτροπληξίας λόγω ηλεκτροφόρων μερών!
Κίνδυνος για τη ζωή από ηλεκτροπληξία σε περίπτωση ακατάλληλης επισκευής

- ▶ Τα ηλεκτρικά μέρη πρέπει να επισκευάζονται από εκπαιδευμένους ηλεκτρολόγους.
- ▶ Μετά την επισκευή πραγματοποιήστε έλεγχο ασφάλειας σύμφωνα με το VDE 0701 ή κανονισμούς της συγκεκριμένης χώρας.

⚠ ΠΡΟΣΟΧΗ
Αιχμηρές ακμές!
Τραυματισμοί από κοπή

- ▶ Φοράτε προστατευτικά γάντια.

Προϋπόθεση:

- ✔ Η συσκευή είναι αποσυνδεδεμένη από την παροχή τροφοδοσίας.
- ✔ Η πόρτα είναι ανοιχτή.
- ✔ Το επάνω ράφι αφαιρέθηκε.

4.7.1 Αφαίρεση λυχνίας LED

1. Πιάστε το κάλυμμα λάμπας LED με τα δύο χέρια και τραβήξτε προς τα κάτω



- ➡ Το κάλυμμα λάμπας LED αφαιρέθηκε.



2. Τραβήξτε και αφαιρέστε τη λάμπα LED.



3. Αποσυνδέστε τον ακροδέκτη.



- ➡ Η λάμπα LED αφαιρέθηκε.

4.7.2 Τοποθέτηση λάμπας LED

- ▶ Εγκαταστήστε με την αντίθετη σειρά.

Javítási útmutató - Hűtő-/fagyasztó-kombináció

 A dokumentummal kapcsolatos információk.....	168
1.1 Fontos tudnivalók	168
1.1.1 Cél	168
1.2 Szimbólummagyarázat	168
1.2.1 Veszélyességi szintek	168
1.2.2 Veszélyt jelző szimbólumok	168
1.2.3 A figyelmeztetések felépítése	169
1.2.4 Általános szimbólumok.....	169
 Biztonság	170
2.1 Általános biztonsági utasítások.....	170
2.1.1 Összes háztartási készülék	170
 Szerszámok és segédanyagok.....	171
 Javítás	172
4.1 A gumitömítés cseréje	172
4.1.1 A gumitömítés eltávolítása.....	172
4.1.2 A gumitömítés beszerelése.....	172
4.2 A fogantyú cseréje.....	175
4.2.1 A fogantyú eltávolítása	175
4.2.2 A fogantyú felszerelése	175
4.3 A polc cseréje	176
4.3.1 A polc eltávolítása	176
4.3.2 A polc beszerelése	176
4.4 A palacktartó cseréje	177
4.4.1 A palacktartó eltávolítása.....	177
4.4.2 A palacktartó telepítése	177
4.5 Az ajtópolc cseréje	178
4.5.1 Az ajtópolc eltávolítása.....	178
4.5.2 Az ajtópolc felhelyezése	178
4.6 A tárolók cseréje.....	179
4.6.1 A tárolók eltávolítása	179
4.6.2 Tárolók behelyezése	179
4.7 A LED-es égő cseréje	180
4.7.1 LED-es égő eltávolítása	180
4.7.2 LED-es égő beszerelése	181

i A dokumentummal kapcsolatos információk

1.1 Fontos tudnivalók

1.1.1 Cél

Ezek a javítási tanácsok támogatják a fogyasztót a készülékek otthoni megjavításában a környezettudatos tervezésről szóló rendeletnek (2021 márciusától alkalmazandó) megfelelően.





Információkat tartalmaznak bizonyos pótalkatrészek cseréjével kapcsolatban, ideértve a figyelmeztetéseket és a kockázatokat is.

Ha kérdése van, vegye fel a kapcsolatot a vevőszolgálattal. A károkért kizárólag akkor vállalunk felelősséget, ha a javítási tanácsokat pontosan betartották.

1.2 Szimbólummagyarázat

1.2.1 Veszélyességi szintek

A veszélyességi szintek egy szimbólumból és egy figyelmeztető mondatból állnak. A figyelmeztető mondat utal a veszély súlyosságára.





Veszélyességi szint	Jelentés
 VESZÉLY	A figyelmeztető üzenet figyelmen kívül hagyása halált vagy súlyos sérüléseket okoz.
 FIGYELMEZTETÉS	A figyelmeztető üzenet figyelmen kívül hagyása halált vagy súlyos sérüléseket okozhat.
 VIGYÁZAT	A figyelmeztető üzenet figyelmen kívül hagyása kisebb sérüléseket okozhat.
 FIGYELEM!	A figyelmeztető üzenet figyelmen kívül hagyása anyagi károkat okozhat.

Táblázat 1: Veszélyességi szintek

1.2.2 Veszélyt jelző szimbólumok

A veszélyt jelző szimbólumok a veszélyt ábrázoló szimbolikus ábrázolások.

A jelen dokumentumban az alábbi veszélyt jelző szimbólumok használatosak:

Veszélyt jelző szimbólum	Jelentés
	Általános figyelmeztető üzenet
	Elektromos feszültség veszélye
	Robbanásveszély
	Vágásveszély
	Zúzódásveszély

i A dokumentummal kapcsolatos információk

Veszélyt jelző szimbólum	Jelentés
	Forró felületek miatt fennálló veszély
	Erős mágneses mező miatt fennálló veszély
	Nem ionizáló sugárzás veszélye

Táblázat 2: Veszélyt jelző szimbólumok

1.2.3 A figyelmeztetések felépítése

A jelen dokumentumban lévő figyelmeztetések szabványosított megjelenésűek és felépítésűek.

	<p>⚠ VESZÉLY</p> <p>A veszély típusa és forrása! A veszély / figyelmeztetés figyelmen kívül hagyásának lehetséges következményei.</p> <ul style="list-style-type: none"> ▶ A veszély megelőzésére szolgáló intézkedések és tiltások.
--	-----------------------------------------------------------------------------------------------------------------------------------------------------------------------------------------------------------------------------------------------------------------------

Az alábbi példa egy olyan figyelmeztetést mutat be, amely az áram alatt lévő alkatrészek okozta áramütésre figyelmeztet. Megemlíti a veszély elkerülésére szolgáló intézkedést.

	<p>⚠ VESZÉLY</p> <p>Áramütés veszélye áram alatt lévő alkatrészek miatt! Halálos áramütés</p> <ul style="list-style-type: none"> ▶ A javítás megkezdése előtt legalább 60 másodperccel válassza le a készülékeket az elektromos hálózatról.
--	------------------------------------------------------------------------------------------------------------------------------------------------------------------------------------------------------------------------------------------------------------------------------

1.2.4 Általános szimbólumok

A jelen dokumentumban az alábbi általános szimbólumok használatosak:

Ált. szimbólum	Jelentés
	Különleges tanács (szöveg és/vagy grafika)

Ált. szimbólum	Jelentés
	Egyszerű tanács (csak szöveg)
	Videós oktatóanyagra mutató hivatkozás
	A szükséges eszközök
	A szükséges feltételek
	Feltétel (ha..., akkor...)
	Eredmény
[Indítás]	Billentyű vagy gomb
[00123456]	Anyagszám azonosítója
Állapot	Megjelenített szöveg / ablak (a készülék kijelzőjén)

Táblázat 3: Általános szimbólumok

2.1 Általános biztonsági utasítások

2.1.1 Összes háztartási készülék

Áramütés veszélye áram alatt lévő alkatrészek miatt!

- Az elektromos alkatrészek hibás javítása áramütéshez vezethet!
- A javítás megkezdése előtt legalább 60 másodperccel válassza le a készüléket az elektromos hálózatról.
- A javítás után végeztesse a VDE 0701-nek vagy az országspecifikus szabályozásoknak megfelelő vizsgálatot.

Éles peremek miatt fennálló sérülésveszély!

- Viseljen védőkesztyűt.

Zúzódásveszély a javítás, karbantartás, hibaelhárítás és szervizelés során a nehéz és mozgó alkatrészek miatt

- Viseljen védőcipőt.
- Biztosítsa leesés ellen a nehéz alkatrészeket.
- Ne dugja be a testrészeit a mozgó alkatrészek közé.



Sérülhet a készülék biztonsága / működése!

- Kizárólag eredeti pótalkatrészeket használjon.

Elektrosztatikailag érzékeny alkatrészek (ESD-k) károsodásának veszélye!

- Ne érintse meg a modulokat, ideértve a csatlakozásokat és a vezetőket.

Szerszámok és segédanyagok

Kijelölés	Részletek	Képek
Védőrongy [00342013]	60 cm x 50 cm	
Hatszögletű csőkulcsok [00340819]	2 mm, 2,5 mm, 3 mm, 4 mm, 5 mm, 6 mm, 8 mm	

4.1 A gumitömítés cseréje

Követelmény:

- ✓ Az ajtó nyitva van

4.1.1 A gumitömítés eltávolítása

1. Vegye ki a gumitömítést a barázdából a jobb és a bal sarokban.

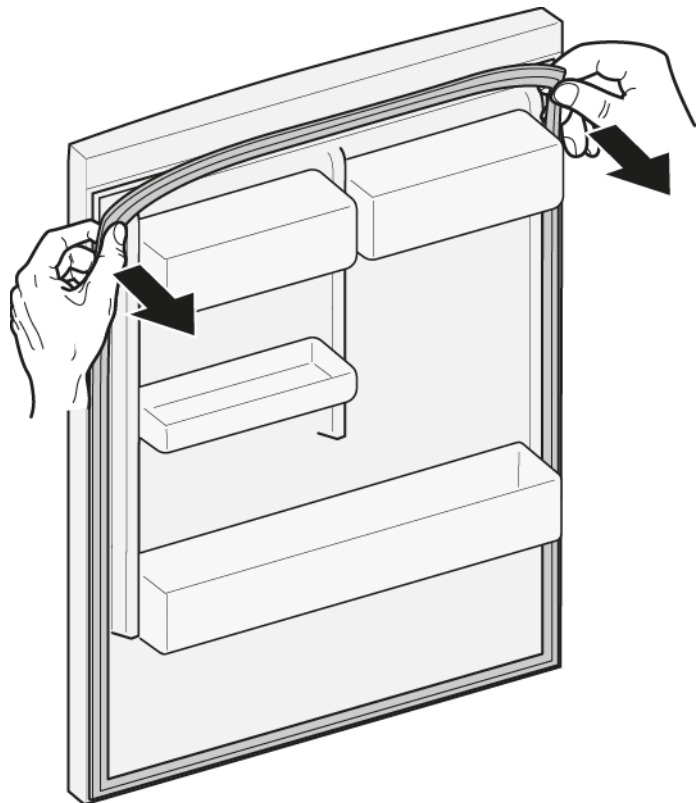

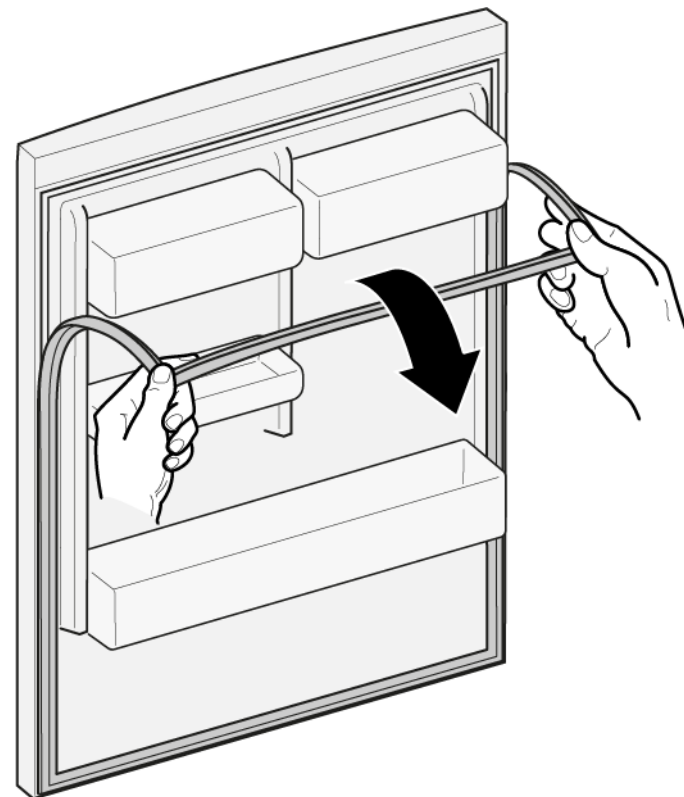

2. Húzza ki a gumitömítést a barázdából.



- ➡ Eltávolította a gumitömítést.

4.1.2 A gumitömítés beszerelése

	Az új gumitömítés vastagsága enyhén eltérhet a régi gumitömítés vastagságától. Ez nem befolyásolja az ajtócsukás módját és hosszú távú működését.
	Ha a készülékében beállítható zsanérok vagy zsanérrögzítések vannak, utólag optimalizálhatja a becsukás módját.
	A gumitömítésben lévő apró, oldalsó lyukak funkcionálisak (a szellőzéshez szükségesek). Ezek nem gyártási hibák.

1. Ellenőrizze a barázdát sérülések szempontjából.

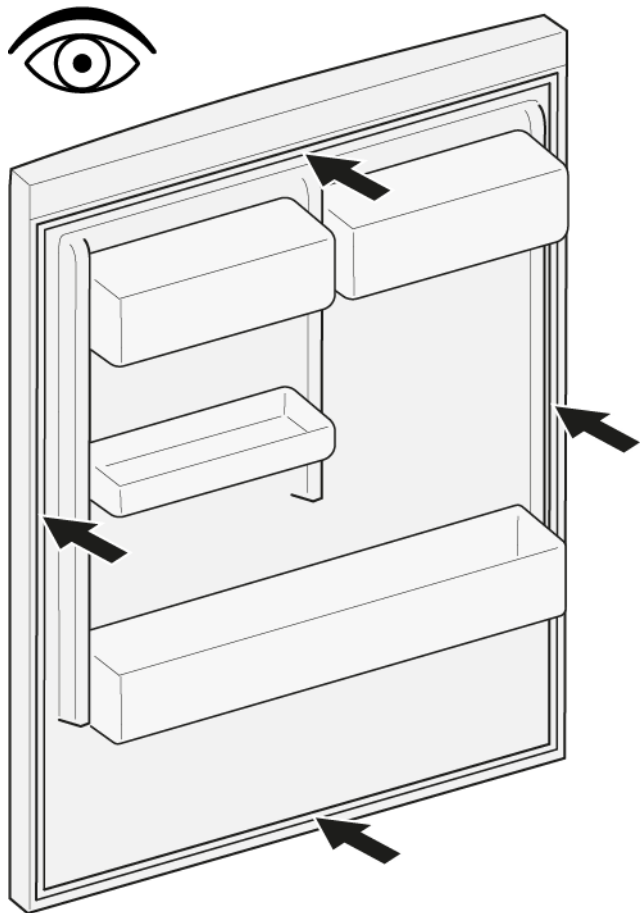

4. Nyomja a gumitömítés fenti és lenti sarkait a barázdába.

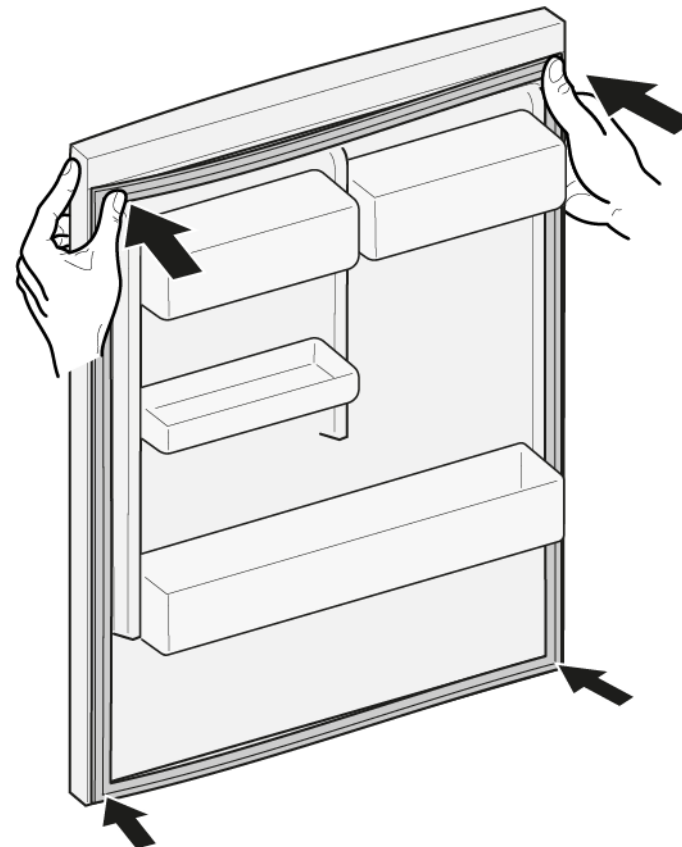



2. ⓘ Ha a gumitömítés barázdája sérült:
- Vegye fel a kapcsolatot az ügyfélszolgálattal.

3. ⓘ A gumitömítés enyhe deformálódása normális, és nem befolyásolja a működését. Javasolt a gumitömítés kiegyenesítése a készülékbe történő behelyezés előtt.

Hajszárítóval vagy forró vízzel melegítse fel a gumitömítést, és kézzel formázza újra.

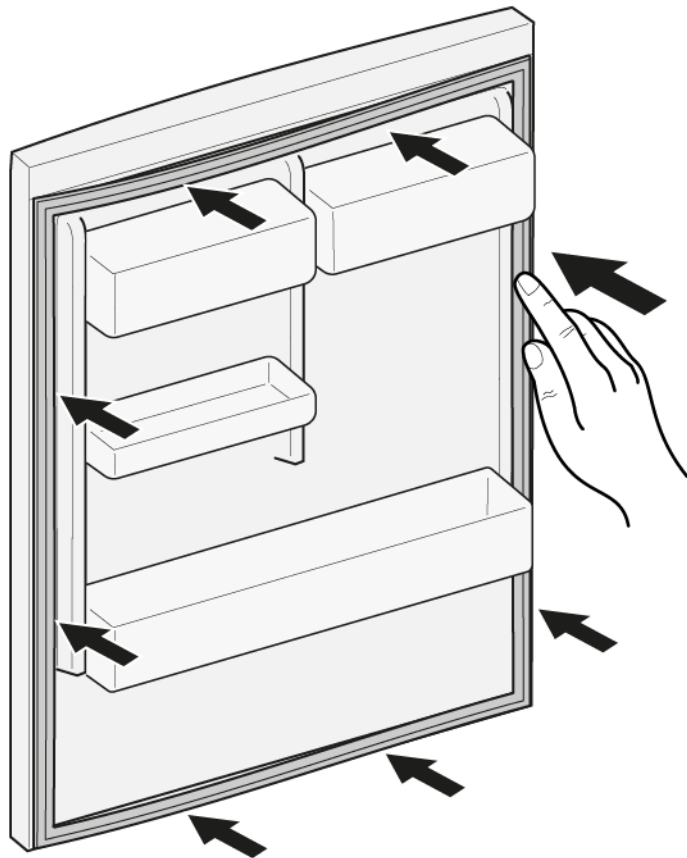
5. Nyomja a teljes gumiötmitést apránként a barázdába.



-  Beszerelte a gumiötmitést.

4.2 A fogantyú cseréje

Különleges eszközök

Hatszögletű csőkulcsok 2 mm, 2,5 mm, 3 mm, 4 mm, 5 mm, 6 mm, 8 mm [00340819]

Követelmény:

- ✓ A készüléket leválasztotta az áramellátásról.
- ✓ Az ajtó nyitva van

4.2.1 A fogantyú eltávolítása

1. Csavarja ki a két csavart (1).
2. Távolítsa el a fogantyút (2).

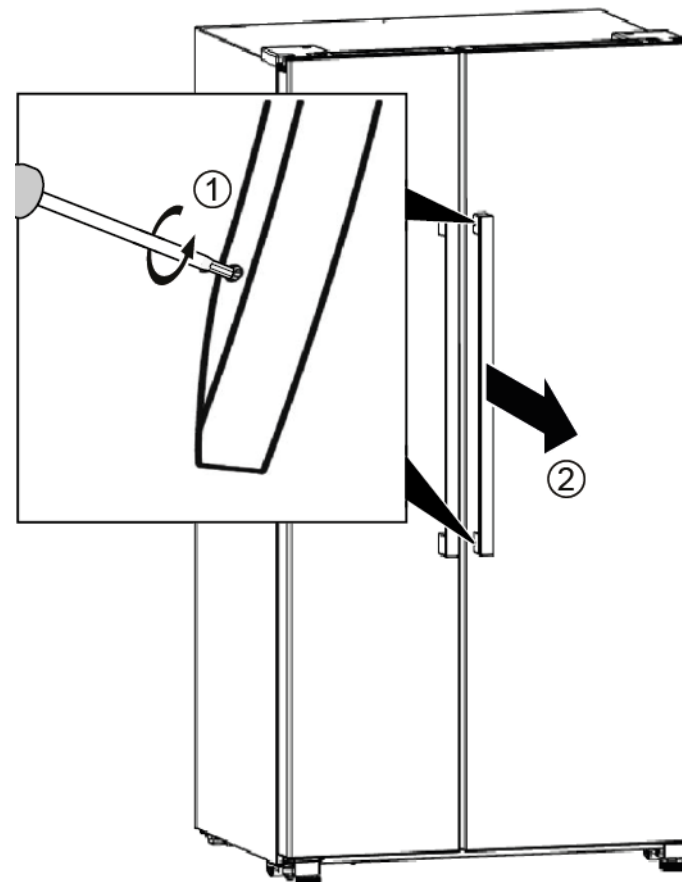

➡ Eltávolította a fogantyút.

2. A második ajtó fogantyújának eltávolítása ugyanígy történik.

4.2.2 A fogantyú felszerelése

- ▶ Az elhelyezést fordított sorrendben végezze.

4.3 A polc cseréje

Követelmény:

- ✔ Az ajtó nyitva van

4.3.1 A polc eltávolítása

- ▶ Húzza ki a polcot.

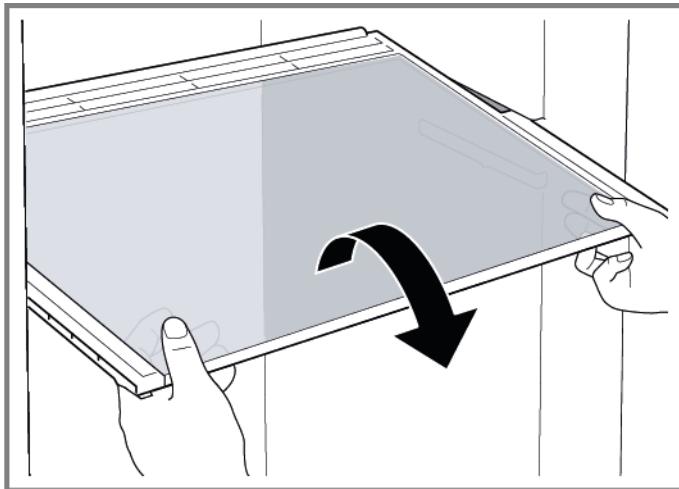

- ➡ Eltávolította a polcot.

4.3.2 A polc beszerelése

- ▶ Az elhelyezést fordított sorrendben végezze.

4.4 A palacktartó cseréje

Követelmény:

- ✔ Az ajtó nyitva van

4.4.1 A palacktartó eltávolítása

- ▶ Húzza ki a palacktartót.

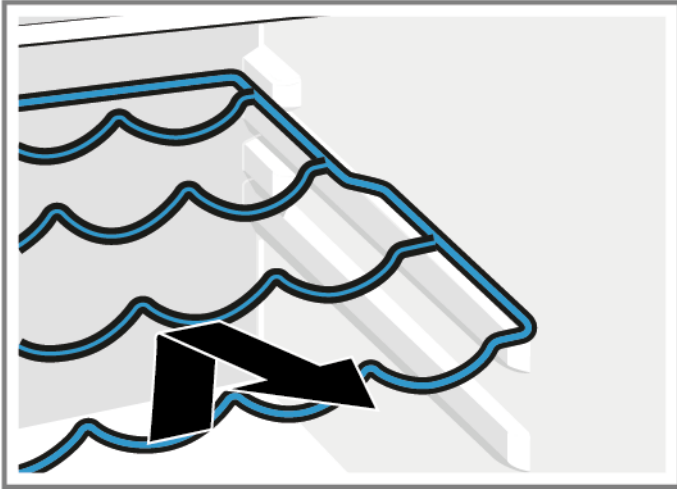

- ➡ Eltávolította a palacktartót.

4.4.2 A palacktartó telepítése

- ▶ Az elhelyezést fordított sorrendben végezze.

4.5 Az ajtópolc cseréje

Követelmény:

- ✔ Az ajtó nyitva van

4.5.1 Az ajtópolc eltávolítása

- ▶ Emelje fel az ajtópolcot.

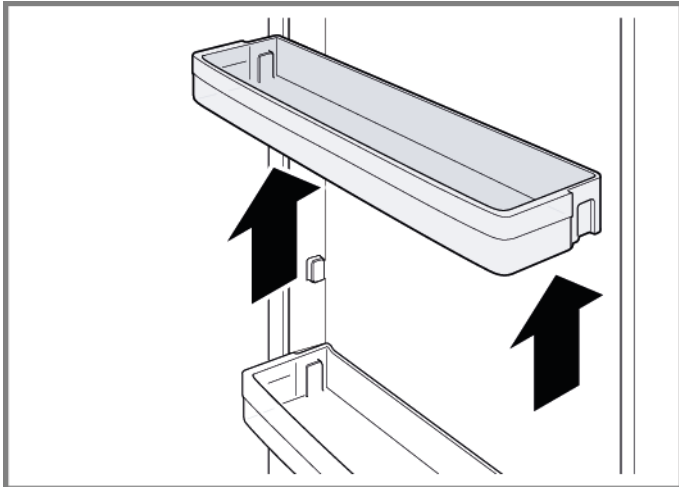

- ➡ Eltávolította az ajtópolcot.

4.5.2 Az ajtópolc felhelyezése

- ▶ Az elhelyezést fordított sorrendben végezze.

4.6 A tárolók cseréje

Követelmény:

- ✔ Az ajtó nyitva van

4.6.1 A tárolók eltávolítása

- ▶ Húzza ki teljesen a tárolót, emelje fel a tartóból való leválasztáshoz, és emelje ki.

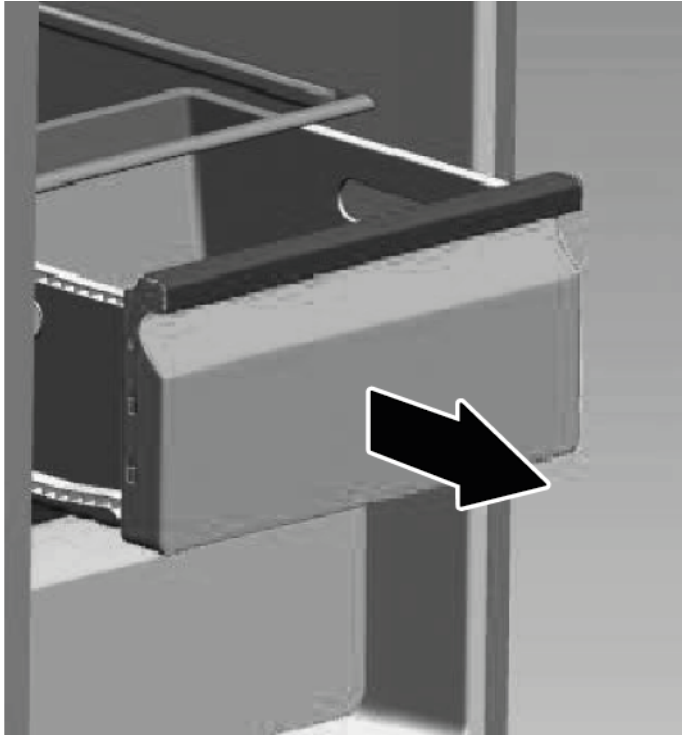

- ➡ Eltávolította a tárolót.

4.6.2 Tárolók behelyezése

- ▶ Az elhelyezést fordított sorrendben végezze.

4.7 A LED-es égő cseréje



A készüléke karbantartásmentes LED-világítással rendelkezik. A világítást kizárólag az ügyfélszolgálat vagy szakképzett technikusok javíthatják meg!



⚠ VESZÉLY

Áramütés veszélye áram alatt lévő alkatrészek miatt!

Életveszély a nem megfelelő javítás okozta áramütés miatt

- ▶ Az elektromos alkatrészek javítását kizárólag képzett elektroműszerész végezheti.
- ▶ A javítás után végeztesen a VDE 0701-nek vagy az országspecifikus szabályozásoknak megfelelő vizsgálatot.



⚠ VIGYÁZAT

Éles szélek!

Vágási sérülések

- ▶ Viseljen védőkesztyűt.

Követelmény:

- ✔ A készüléket leválasztotta az áramellátásról.
- ✔ Az ajtó nyitva van
- ✔ Eltávolította a felső polcot.

4.7.1 LED-es égő eltávolítása

1. Fogja meg két kézzel a LED-es égő burkolatát, és húzza lefelé



- ➡ Eltávolította a LED-es égő burkolatát.



2. Húzza meg és emelje ki a LED-es égőt.



3. Válassza le a terminált.



- ➡ Eltávolította a LED-es égőt.

4.7.2 LED-es égő beszerelése

- ▶ Az elhelyezést fordított sorrendben végezze.

Consigli di riparazione - Combinazione frigorifero / congelatore

 Utilizzo del documento	183
1.1 Avvertenze importanti	183
1.1.1 Scopo	183
1.2 Spiegazione dei simboli	183
1.2.1 Livelli di pericolo	183
1.2.2 Simboli di pericolo	183
1.2.3 Struttura degli avvertimenti	184
1.2.4 Simboli generici	184
 Sicurezza	185
2.1 Note generali sulla sicurezza	185
2.1.1 Tutti gli elettrodomestici	185
 Strumenti e ausili	186
 Riparazione	187
4.1 Sostituzione della guarnizione della porta	187
4.1.1 Smontaggio della guarnizione della porta	187
4.1.2 Montaggio della guarnizione della porta	187
4.2 Sostituzione della maniglia della porta	190
4.2.1 Smontaggio della maniglia della porta	190
4.2.2 Montaggio della maniglia della porta	190
4.3 Sostituzione del ripiano	191
4.3.1 Smontaggio del ripiano	191
4.3.2 Montaggio del ripiano	191
4.4 Sostituzione del portabottiglie	192
4.4.1 Smontaggio del portabottiglie	192
4.4.2 Montaggio del portabottiglie	192
4.5 Sostituzione del balconcino della porta	193
4.5.1 Smontaggio del balconcino della porta	193
4.5.2 Montaggio del balconcino della porta	193
4.6 Sostituzione dei cassetti	194
4.6.1 Estrazione dei cassetti	194
4.6.2 Inserimento dei cassetti	194
4.7 Sostituzione della luce a LED	195
4.7.1 Smontaggio della luce a LED	195
4.7.2 Montaggio della luce a LED	196

i Utilizzo del documento

1.1 Avvertenze importanti

1.1.1 Scopo

Queste istruzioni di riparazione spiegano ai clienti come riparare da soli gli elettrodomestici in conformità alle regole sull'Ecodesign vigenti (al 03/2021).

Contengono informazioni sulla sostituzione di pezzi di ricambio specifici e sulle avvertenze e i rischi correlati.

In caso di domande, contattare l'assistenza tecnica. Il mancato rispetto di tali istruzioni da parte dei clienti ci esonera da qualsiasi responsabilità.

1.2 Spiegazione dei simboli

1.2.1 Livelli di pericolo

I livelli di avvertimento corrispondono a un simbolo accompagnato da una parola di allerta. La parola di allerta identifica il livello di pericolo.





Livello di avvertimento	Significato
	Ignorare questo messaggio di avvertimento comporta rischio di morte o ferite gravi.
	Ignorare questo messaggio di avvertimento può comportare rischio di morte o ferite gravi.
	Ignorare questo messaggio di avvertimento può comportare ferite di minore gravità.
	Ignorare questo messaggio di avvertimento può comportare danni materiali.

Tabella 1: Livelli di pericolo

1.2.2 Simboli di pericolo

I simboli di pericolo sono illustrazioni che specificano la tipologia di rischio.

Nella presente documentazione vengono utilizzati i seguenti simboli di pericolo:

Simbolo di pericolo	Significato
	Messaggio di avvertimento generico
	Pericolo di scossa elettrica
	Pericolo di esplosione
	Rischio di ferite da taglio

Utilizzo del documento







Simbolo di pericolo	Significato
	Pericolo di schiacciamento
	Pericolo derivante da superfici calde
	Pericolo derivante da forti campi magnetici
	Pericolo derivante da radiazioni non ionizzanti

Tabella 2: Simboli di pericolo

1.2.3 Struttura degli avvertimenti

Gli avvertimenti presenti in questo manuale hanno una forma e una struttura standardizzati.

	<div style="background-color: red; color: white; padding: 2px; text-align: center;"> PERICOLO</div> <p>Tipo e origine del pericolo! Possibili conseguenze in caso di pericolo/avvertimento ignorato.</p> <ul style="list-style-type: none"> ▶ Misure e divieti volti a prevenire il pericolo.
----------------------------------------------------------------------------------	-----------------------------------------------------------------------------------------------------------------------------------------------------------------------------------------------------------------------------------------------------------------------------------------------------------------------------------------------------------------------------------------------------------------

L'esempio seguente mostra un avvertimento con rischio di folgorazione dovuto a componenti sotto tensione. È riportata la misura di precauzione per evitare il pericolo.

	<div style="background-color: red; color: white; padding: 2px; text-align: center;"> PERICOLO</div> <p>Rischio di scossa elettrica dovuto a componenti sotto tensione! Morte per folgorazione</p> <ul style="list-style-type: none"> ▶ Scollegare l'apparecchio dall'alimentazione per almeno 60 secondi prima di iniziare la riparazione.
------------------------------------------------------------------------------------	----------------------------------------------------------------------------------------------------------------------------------------------------------------------------------------------------------------------------------------------------------------------------------------------------------------------------------------------------------------------------------------------------------------------------------------------------------------

1.2.4 Simboli generici

Nel presente manuale vengono utilizzati i seguenti simboli generici:







Simbolo generico	Significato
	Identificazione di un suggerimento speciale (testo e/o grafica)
	Identificazione di un suggerimento semplice (solo testo)
	Identificazione di un link per un video tutorial
	Identificazione degli strumenti necessari
	Identificazione delle condizioni preve necessarie
	Identificazione di una condizione (se ..., allora ...)
	Identificazione di un risultato
[Avvio]	Identificazione di un tasto o di un pulsante
[00123456]	Identificazione di un codice articolo
Stato	Identificazione di un testo/finestra visualizzati (sul display dell'apparecchio)

Tabella 3: Simboli generici

2.1 Note generali sulla sicurezza

2.1.1 Tutti gli elettrodomestici

Rischio di scosse elettriche dovute a componenti sotto tensione!

- La riparazione non conforme dei componenti elettrici può causare scosse elettriche!
- Scollegare l'apparecchio dall'alimentazione per almeno 60 secondi prima di iniziare il lavoro.
- Ultimata la riparazione, occorre eseguire un test di sicurezza conforme alla norma VDE 0701 o alle norme specifiche del Paese.

Rischio di lesioni causate da bordi taglienti!

- Indossare guanti di protezione.

Rischio di schiacciamento dovuto a componenti pesanti e in movimento durante la riparazione, la manutenzione, la ricerca dei guasti e l'assistenza

- Indossare calzature antinfortunistiche.
- Fissare i componenti pesanti per impedire che cadano.
- Non inserire parti del corpo nei componenti in movimento.



Rischio per il funzionamento o la sicurezza dell'apparecchio!

- Utilizzare solo ricambi originali.

Rischio di danneggiamento di componenti sensibili a carica elettrostatica (ESD)!

- Non toccare i moduli, inclusi i collegamenti e le piste conduttive.

Strumenti e ausili

Designazione	Dettagli	Immagini
Panno di protezione [00342013]	60 cm x 50 cm	
Chiavi a brugola [00340819]	2 mm, 2,5 mm, 3 mm, 4 mm, 5 mm, 6 mm, 8 mm	

4.1 Sostituzione della guarnizione della porta

Prerequisiti:

- ✔ La porta è aperta.

4.1.1 Smontaggio della guarnizione della porta

1. Staccare la guarnizione della porta dalla scanalatura negli angoli destro e sinistro.

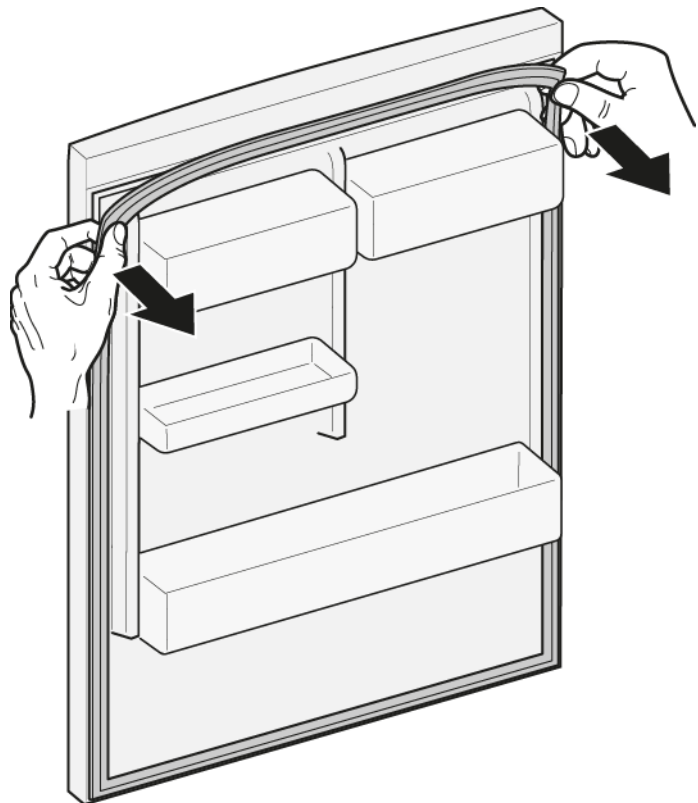

2. Estrarre la guarnizione della porta dalla scanalatura.

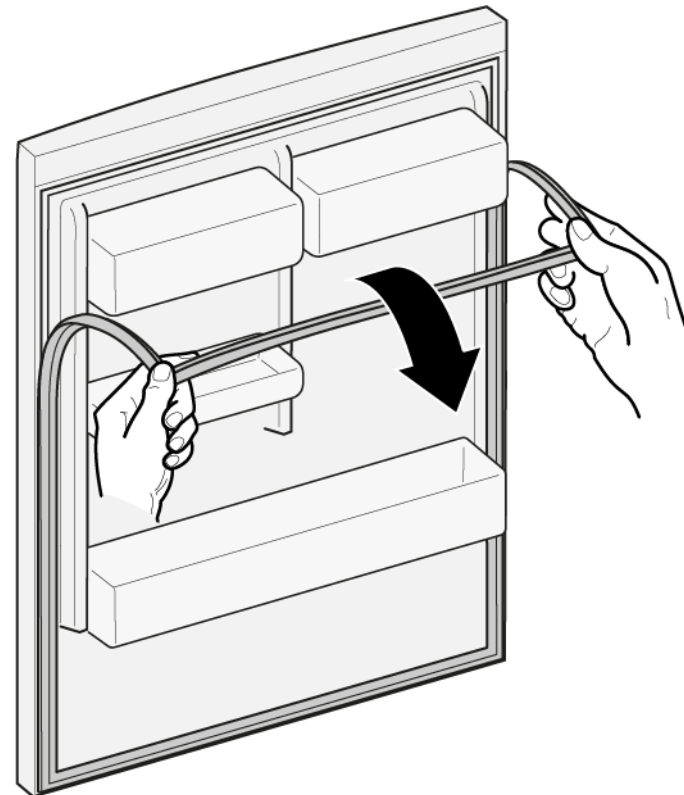

- ➡ La guarnizione della porta è rimossa.

4.1.2 Montaggio della guarnizione della porta



Lo spessore della nuova guarnizione della porta può essere leggermente diverso dallo spessore di quella vecchia. Ciò non incide sulla chiusura e sul funzionamento a lungo termine.



Se l'apparecchio è dotato di cerniere regolabili o accessori, è possibile ottimizzare il comportamento di chiusura.



I piccoli fori laterali nella guarnizione della porta sono funzionali (necessari per la ventilazione). Non si tratta di difetti di produzione.

Riparazione

1. Controllare che la scanalatura della guarnizione non sia danneggiata.

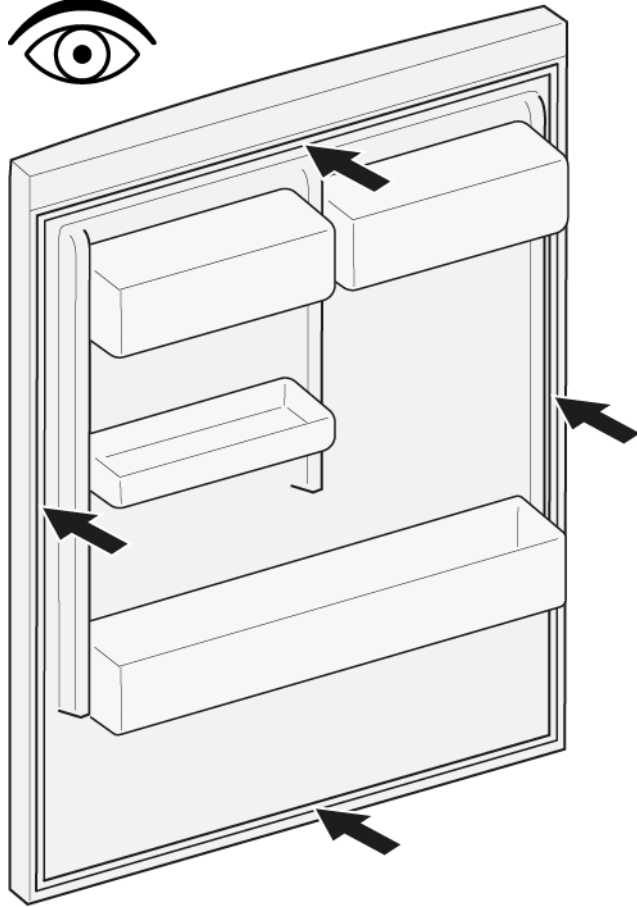

4. Spingere gli angoli della guarnizione nella scanalatura in alto e in basso.

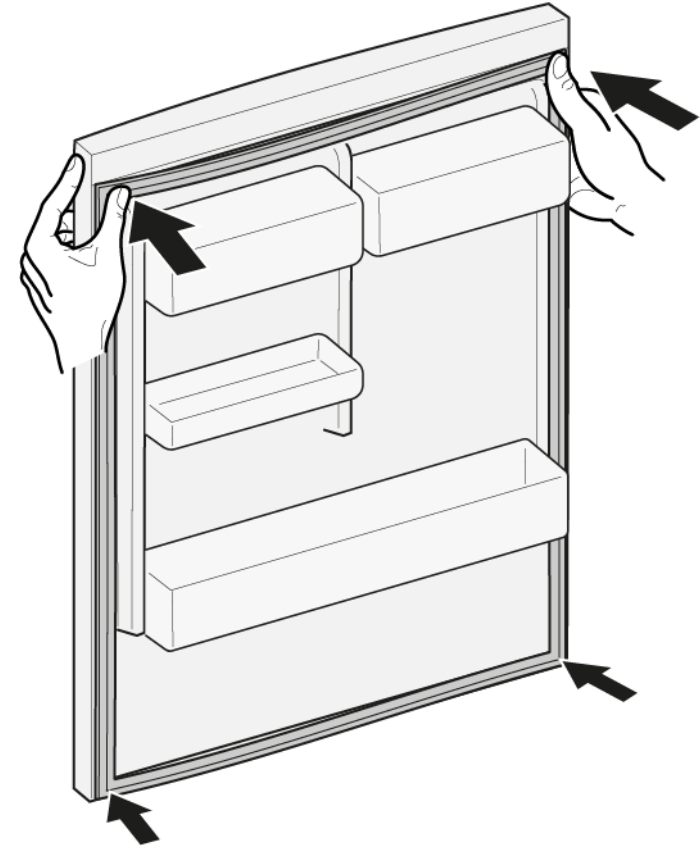

2.  Se la scanalatura della guarnizione è danneggiata.
- Contattare l'assistenza tecnica.

3.

	Una leggera deformazione della guarnizione della porta è normale e non incide sul funzionamento. Si consiglia di raddrizzare la guarnizione della porta prima di inserirla nell'apparecchio.
-------------------------------------------------------------------------------------	----------------------------------------------------------------------------------------------------------------------------------------------------------------------------------------------

Riscaldare la guarnizione della porta con un asciugacapelli o acqua calda e ridarle la forma manualmente.

Riparazione

5. Premere la guarnizione nella scanalatura un pezzo per volta.

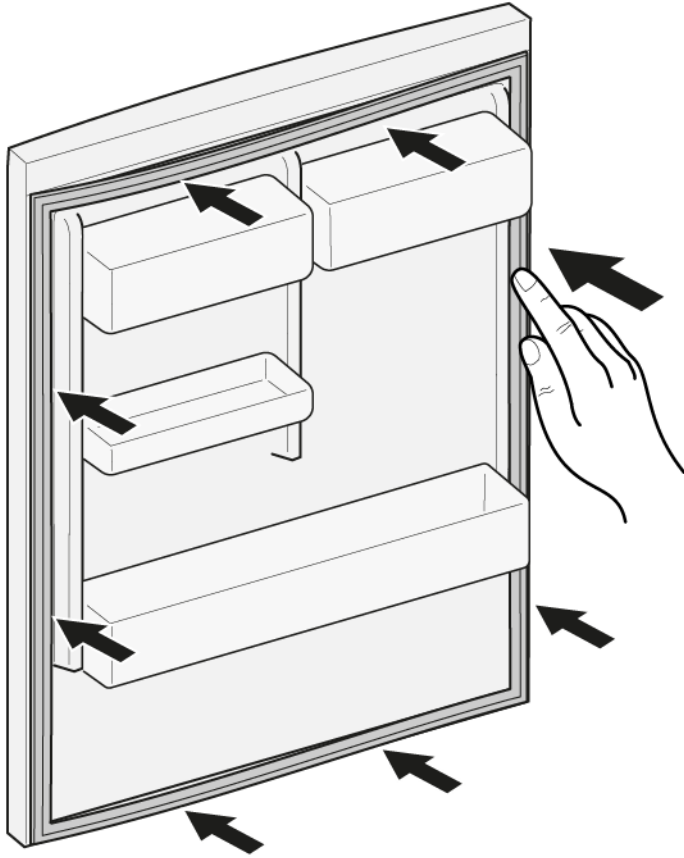



-  La guarnizione della porta è montata.

4.2 Sostituzione della maniglia della porta

Attrezzi speciali:

 Chiavi a brugola 2 mm, 2,5 mm, 3 mm, 4 mm, 5 mm, 6 mm, 8 mm [00340819]

Prerequisiti:

-  L'apparecchio è scollegato dalla rete elettrica.
-  La porta è aperta.

4.2.1 Smontaggio della maniglia della porta

1. 1. Svitare le due viti (1).
2. 2. Smontare la maniglia della porta (2).

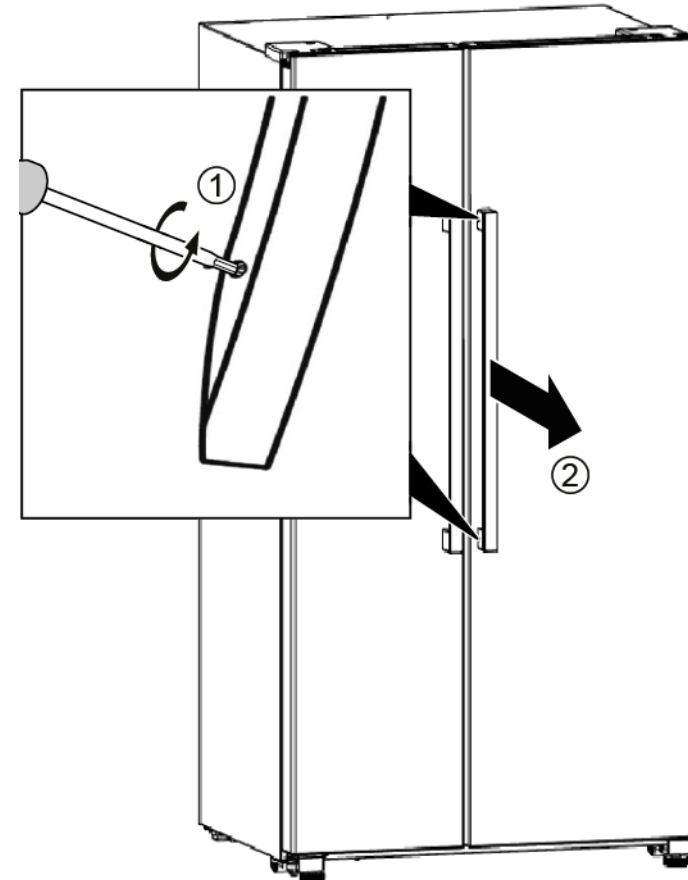

 La maniglia della porta è rimossa.

2. Togliere la seconda maniglia della porta nello stesso modo.

4.2.2 Montaggio della maniglia della porta

- ▶ Per il montaggio, seguire la procedura sopra descritta in senso opposto.

4.3 Sostituzione del ripiano

Prerequisiti:

- ✔ La porta è aperta.

4.3.1 Smontaggio del ripiano

- ▶ Estrarre il ripiano.

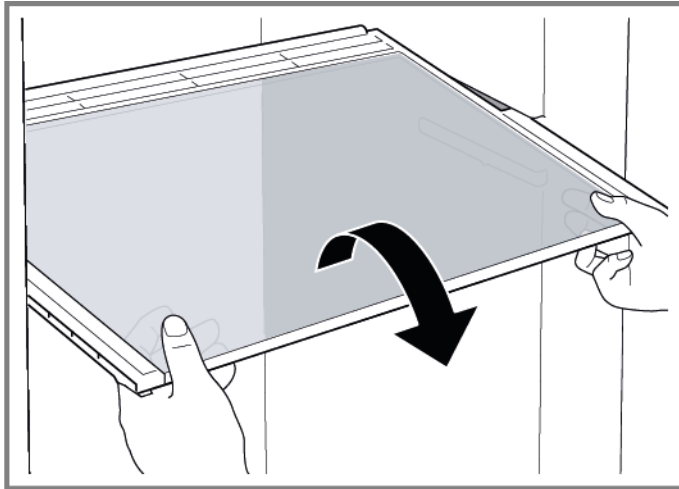

➡ Il ripiano è rimosso.

4.3.2 Montaggio del ripiano

- ▶ Per il montaggio, seguire la procedura sopra descritta in senso opposto.

4.4 Sostituzione del portabottiglie

Prerequisiti:

- ✔ La porta è aperta.

4.4.1 Smontaggio del portabottiglie

- ▶ Estrarre il portabottiglie.

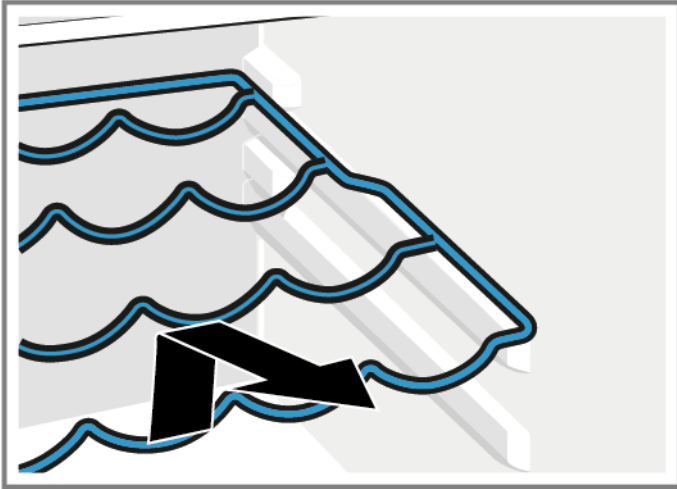

- ➡ Il portabottiglie è rimosso.

4.4.2 Montaggio del portabottiglie

- ▶ Per il montaggio, seguire la procedura sopra descritta in senso opposto.

4.5 Sostituzione del balconcino della porta

Prerequisiti:

- ✔ La porta è aperta.

4.5.1 Smontaggio del balconcino della porta

- ▶ Tirare il balconcino della porta verso l'alto.

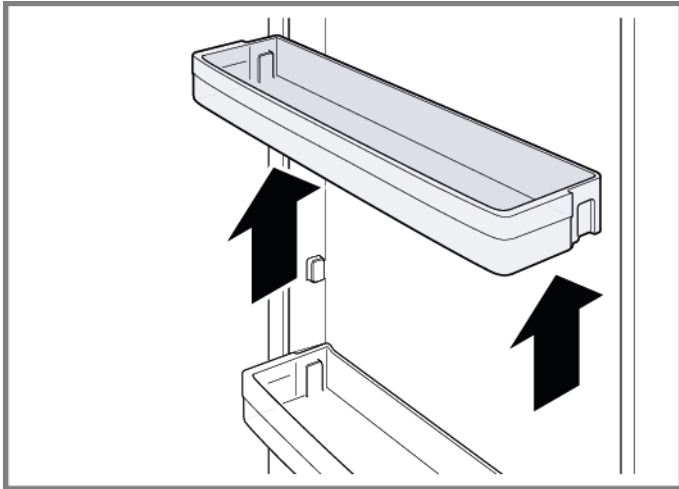

➡ Il balconcino della porta è rimosso.

4.5.2 Montaggio del balconcino della porta

- ▶ Per il montaggio, seguire la procedura sopra descritta in senso opposto.

4.6 Sostituzione dei cassetti

Prerequisiti:

- ✔ La porta è aperta.

4.6.1 Estrazione dei cassetti

- ▶ Tirare completamente fuori il cassetto, sollevarlo per staccarlo dal supporto ed estrarlo.

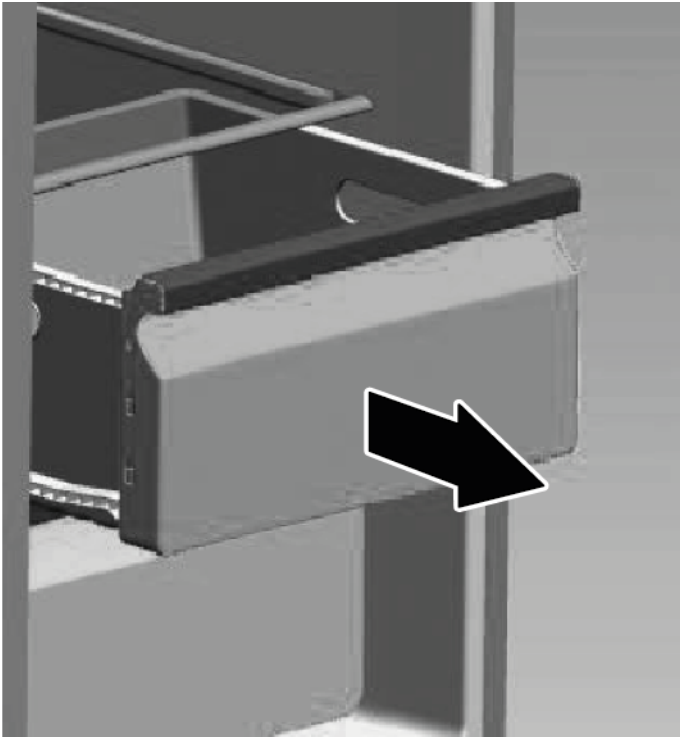



- ➡ Il cassetto è rimosso.

4.6.2 Inserimento dei cassetti

- ▶ Per il montaggio, seguire la procedura sopra descritta in senso opposto.

4.7 Sostituzione della luce a LED

 L'apparecchio è dotato di una luce a LED esente da manutenzione. Queste luci possono essere riparate esclusivamente dall'assistenza clienti o da tecnici autorizzati!

 **PERICOLO**
Rischio di scosse elettriche dovute a componenti sotto tensione!
Pericolo di morte dovuto a scosse elettriche in caso di riparazione non conforme

- ▶ Le parti elettriche devono essere riparate da elettricisti qualificati.
- ▶ Ultimata la riparazione, occorre eseguire un test di sicurezza conforme alla norma VDE 0701 o alle norme specifiche del Paese.

 **ATTENZIONE**
Bordi taglienti!
Ferite da taglio

- ▶ Indossare guanti di protezione.

Prerequisiti:

- ✔ L'apparecchio è scollegato dalla rete elettrica.
- ✔ La porta è aperta.
- ✔ Il ripiano superiore è rimosso.

4.7.1 Smontaggio della luce a LED

1. Afferrare il coperchio della luce a LED con due mani e tirarlo verso il basso.



- ➡ Il coperchio della luce a LED è rimosso.



2. Estrarre la luce a LED.



3. Scollegare il terminale.







- ➡ La luce a LED è rimossa.

4.7.2 Montaggio della luce a LED

- ▶ Per il montaggio, seguire la procedura sopra descritta in senso opposto.

Informācija par remontu - Dzesēšanas un saldēšanas kombinācija

 Par šo dokumentu	198
1.1 Būtiska informācija	198
1.1.1 Mērķis	198
1.2 Simbolu skaidrojums.....	198
1.2.1 Bīstamības līmeņi	198
1.2.2 Bīstamības simboli	198
1.2.3 Brīdinājumu struktūra	199
1.2.4 Vispārīgie simboli.....	199
 Drošība	200
2.1 Vispārējie drošības norādījumi	200
2.1.1 Visām mājsaimniecības ierīcēm	200
 Piederumi un palīgļīdzekļi	201
 Remonts	202
4.1 Durvju blīvslēga nomaiņa	202
4.1.1 Durvju blīvslēga noņemšana	202
4.1.2 Durvju blīvslēga uzstādīšana	202
4.2 Durvju roktura nomaiņa.....	205
4.2.1 Durvju roktura noņemšana.....	205
4.2.2 Durvju roktura uzstādīšana	205
4.3 Plaukta nomaiņa.....	206
4.3.1 Plaukta izņemšana.....	206
4.3.2 Plaukta uzstādīšana	206
4.4 Pudeļu plaukta nomaiņa.....	207
4.4.1 Pudeļu plaukta izņemšana.....	207
4.4.2 Pudeļu plaukta uzstādīšana	207
4.5 Durvju plaukta nomaiņa	208
4.5.1 Durvju plaukta noņemšana	208
4.5.2 Durvju plaukta uzstādīšana.....	208
4.6 Tvertņu nomaiņa	209
4.6.1 Tvertņu izņemšana.....	209
4.6.2 Tvertņu uzstādīšana.....	209
4.7 LED spuldzes nomaiņa	210
4.7.1 LED spuldzes izņemšana	210
4.7.2 LED spuldzes uzstādīšana	211

i Par šo dokumentu

1.1 Būtiska informācija

1.1.1 Mērķis

Šie labošanas ieteikumi ir paredzēti patērētājam, patstāvīgi labojot ierīces, saskaņā ar piemērojamo Ekodizaina regulu (sākot no 03.2021.).



Tajā ir sniegta informācija par to, kā nomainīt noteiktas rezerves daļas, kā arī brīdinājumi un riski.

Jautājumu gadījumā lūdzam sazināties ar mūsu klientu apkalpošanas dienestu. Mēs esam atbildīgi par zaudējumiem tikai tad, ja ir pienācīgi ievēroti šie labošanas ieteikumi.

1.2 Simbolu skaidrojums

1.2.1 Bīstamības līmeņi

Brīdinājuma līmeņus veido simbols un signālvārds. Signālvārds apzīmē bīstamības pakāpi.





Brīdinājuma līmenis	Nozīme
 BĪSTAMI	Brīdinājuma paziņojuma neievērošanas rezultātā iestāsies nāve vai radīsies smagas traumas.
 BRĪDINĀJUMS	Brīdinājuma paziņojuma neievērošanas rezultātā var iestāties nāve vai rasties smagas traumas.
 ESJET PIESARDŽĪGI	Brīdinājuma paziņojuma neievērošanas rezultātā var rasties nelielas traumas.
 UZMANĪBU!	Brīdinājuma paziņojuma neievērošanas rezultātā var rasties kaitējums īpašumam.

Tabula 1: Bīstamības līmeņi



1.2.2 Bīstamības simboli

Bīstamības simboli ir simboliski apzīmējumi, kas sniedz norādes par bīstamības veidu.

Šajā dokumentā ir izmantoti šādi bīstamības simboli:

Bīstamības simbols	Nozīme
	Vispārējs brīdinājuma paziņojums
	Elektriskā sprieguma radīts apdraudējums
	Sprādzienbīstamības risks
	Griezumu bīstamība
	Saspiešanas bīstamība

i Par šo dokumentu

Bīstamības simbols	Nozīme
	Karstu virsmu radīta bīstamība
	Spēcīgu magnētisko lauku radīta bīstamība
	Nejonizējoša starojuma radīta bīstamība

Tabula 2: Bīstamības simboli

1.2.3 Brīdinājumu struktūra

Šajā dokumentā sniegtajiem brīdinājumiem ir standartizēts noformējums un standartizēta struktūra.



	<p>⚠ BĪSTAMI</p> <p>Bīstamības veids un avots! Iespējamās sekas, kas rodas, neievērojot bīstamības paziņojumu / brīdinājumu.</p> <ul style="list-style-type: none"> ▶ Bīstamības novēršanas pasākumi un aizliegumi.
----------------------------------------------------------------------------------	------------------------------------------------------------------------------------------------------------------------------------------------------------------------------------------------------------------------------------------------------





Nākamajā piemērā ir parādīts brīdinājums, kas apzīmē elektrotrieciena risku, ko rada spriegumaktīvas detaļas. Ir norādīts bīstamības novēršanas pasākums.

	<p>⚠ BĪSTAMI</p> <p>Elektrotrieciena risks, ko rada spriegumaktīvas detaļas! Nāvējošs elektrotrieciens</p> <ul style="list-style-type: none"> ▶ Atvienojiet iekārtas no strāvas padeves vismaz 60 sekundes pirms labošanas sākšanas.
------------------------------------------------------------------------------------	-----------------------------------------------------------------------------------------------------------------------------------------------------------------------------------------------------------------------------------------------------------------------

1.2.4 Vispārīgie simboli

Šajā dokumentā ir izmantoti šādi vispārīgie simboli:

Visp. simbols	Nozīme
	Īpašu ieteikumu apzīmējums (teksts un/ vai grafika)
	Vienkāršu ieteikumu apzīmējums (tikai teksts)

Visp. simbols	Nozīme
	Video pamācības saites apzīmējums
	Nepieciešamo rīku apzīmējums
	Nepieciešamo priekšnosacījumu apzīmējums
	Nosacījuma apzīmējums (ja ..., tad ...)
	Rezultāta apzīmējums
[Sākt]	Taustiņa vai pogas apzīmējums
[00123456]	Materiāla numura apzīmējums
Statuss	Attēlotā teksta / loga apzīmējums (iekārtas displejā)

Tabula 3: Vispārīgie simboli

2.1 Vispārējie drošības norādījumi

2.1.1 Visām mājsaimniecības ierīcēm

Elektrotrieciena risks spriegumaktīvu daļu dēļ!

- Ja remonts, kas skar elektriskās daļas, ir veikts kļūdaini, pastāv elektrotrieciena risks!
- Ierīcei ir jābūt atvienotai no tīkla vismaz 60 sekundes, pirms sāk darbu.
- Pēc remonta ierīces drošība ir jāpārbauda atbilstīgi noteikumiem VDE 0701 vai valsts noteikumiem.

Savainojumu risks asu malu dēļ!

- Valkājiet aizsargcimdus.

Saspiešanas risks labošanas, uzturēšanas, traucējumu novēršanas un apkopes laikā, ko rada smagas un kustīgas detaļas

- Valkājiet aizsargapavus.
- Nostipriniet smagas detaļas, lai tās nenokristu.
- Neievietojiet ķermeņa daļas kustīgās detaļās.



Ierīces drošības / darbības traucējuma risks!

- Izmantojiet tikai oriģinālās rezerves daļas.

Pret elektrostatisko izlādi jutīgu daļu (ESDS) bojājuma risks!

- Neaiztieciet moduļus, ieskaitot savienojumus un vadojumu.

Piederumi un palīglīdzekļi

Apzīmējums	Sīkāka informācija	Attēli
Aizsargdrāna [00342013]	60 cm x 50 cm	
Sešstūra galatslēga [00340819]	2 mm, 2,5 mm, 3 mm, 4 mm, 5 mm, 6 mm, 8 mm	

4.1 Durvju blīvslēga nomaīņa

Prasība:

- ✓ Durvīm ir jābūt atvērtām.

4.1.1 Durvju blīvslēga noņemšana

1. Atbrīvojiet durvju blīvslēgu no rievas labajā un kreisajā pusē.

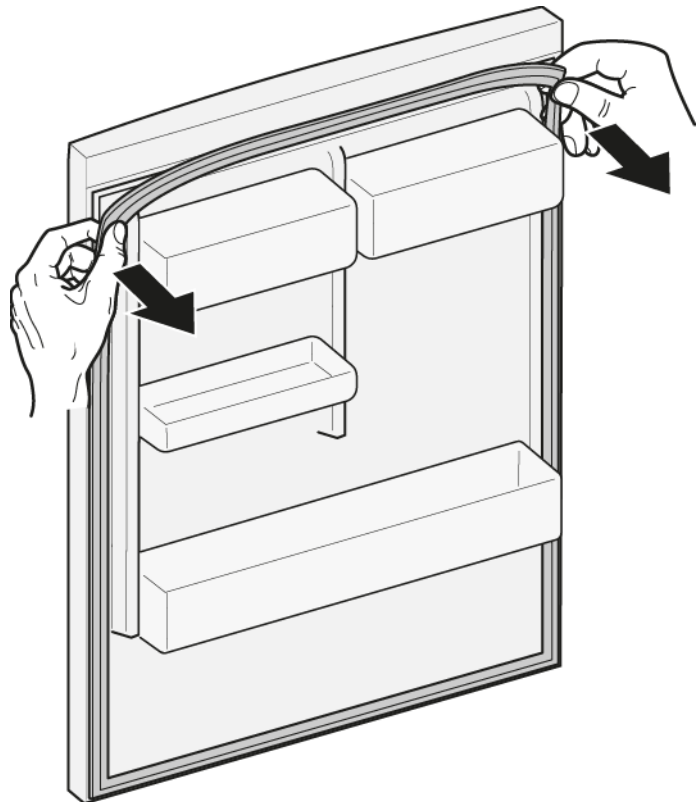

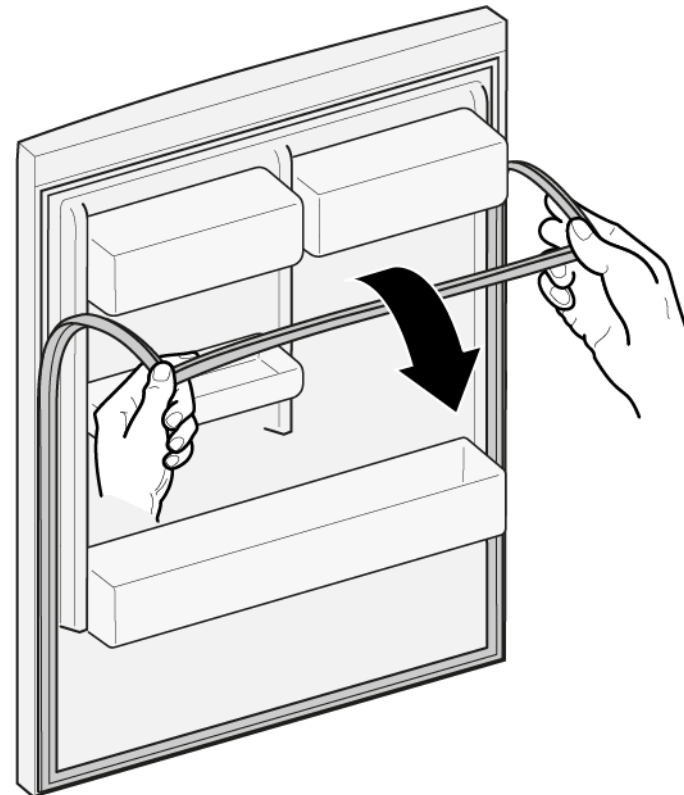

2. Izvelciet durvju blīvslēgu no rievas.



- ➡ Durvju blīvslēgs ir noņemts.

4.1.2 Durvju blīvslēga uzstādīšana

	Jaunā durvju blīvslēga biezums var mazliet atšķirties no vecā durvju blīvslēga biezuma. Tas neietekmē aizvēršanos un darbību ilgtermiņā.
	Ja ierīces viras var regulēt vai tai ir viru savienojumi, vēlāk aizvēršanos var pielāgot.
	Mazie caurumi durvju blīvslēga sānos ir funkcionāli (nodrošina ventilāciju). Tie nav ražošanas defekti.

1. Pārbaudiet, ka blīvslēga rieta nav bojāta.

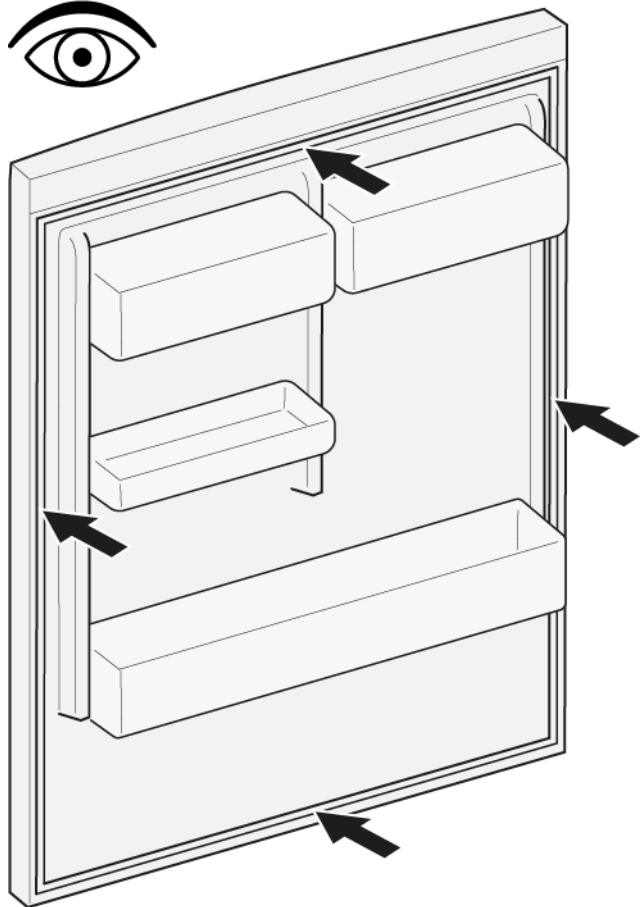

4. Iespiediet blīvslēga augšējos un apakšējos stūrus rieta.

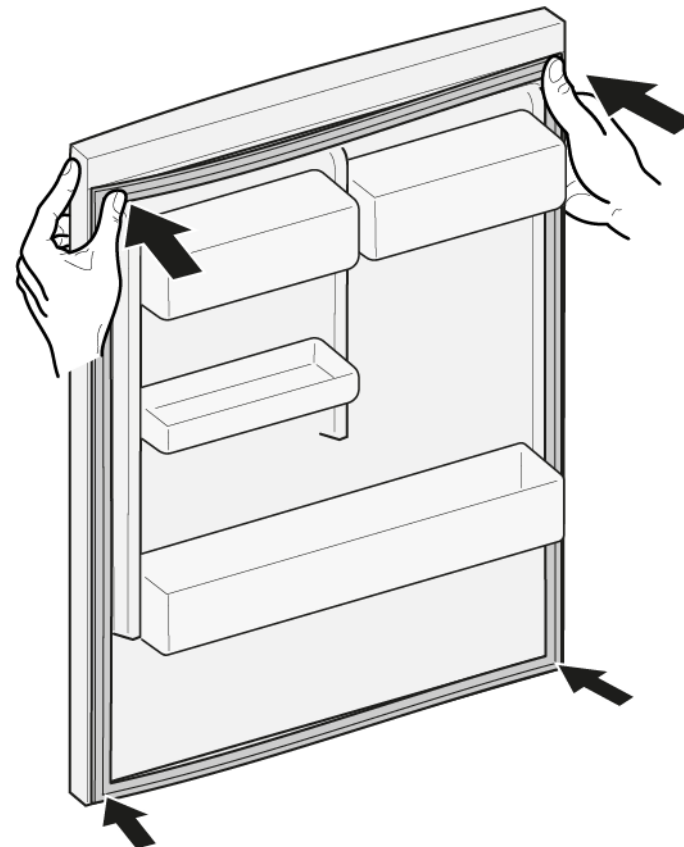

2.  Ja blīvslēga rieta ir bojāta
- Sazinieties ar klientu apkalpošanas dienesta pārstāvi.

3.  Durvju blīvslēgs var būt mazliet deformējies, kas neietekmē tā darbību. Pirms durvju blīvslēgu ieliek ierīcē, to ir ieteicams iztaisnot.

Sasildiet durvju blīvslēgu ar matu fēnu vai karstā ūdenī un ar rokām atjaunojiet tā formu.

5. Pakāpeniski iespiediet visu blīvslēgu rievā.

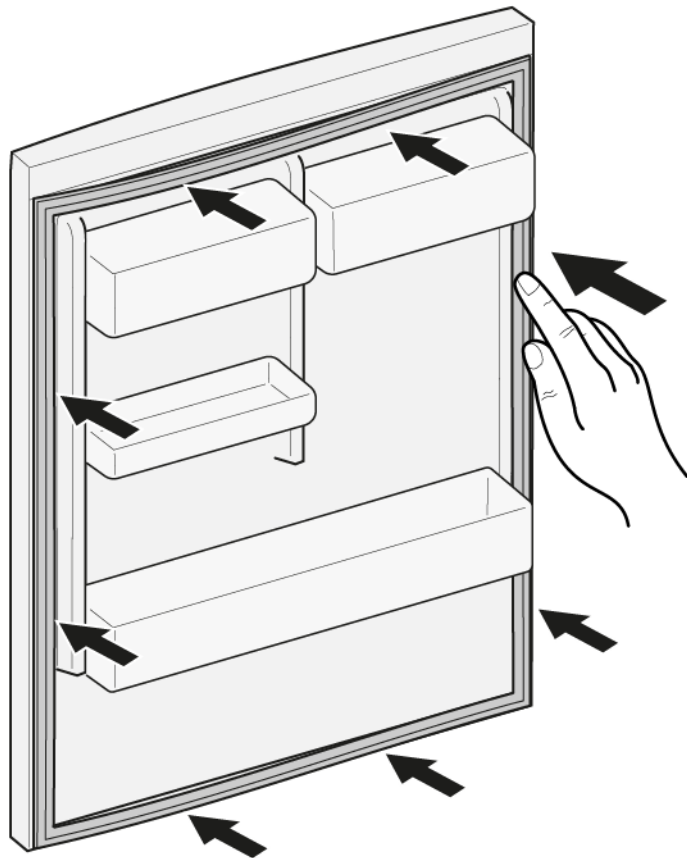

 Durvju blīvslēgs ir uzstādīts.

4.2 Durvju roktura nomaiņa

Speciāli rīki:

Sešstūra galatslēga 2 mm, 2,5 mm, 3 mm, 4 mm, 5 mm, [00340819]
6 mm, 8 mm

Prasība:

- ✓ Ierīces elektropadevei ir jābūt atvienotai.
- ✓ Durvīm ir jābūt atvērtām.

4.2.1 Durvju roktura noņemšana

1. Izskrūvējiet abas skrūves (1).
2. Noņemiet durvju rokturi (2).

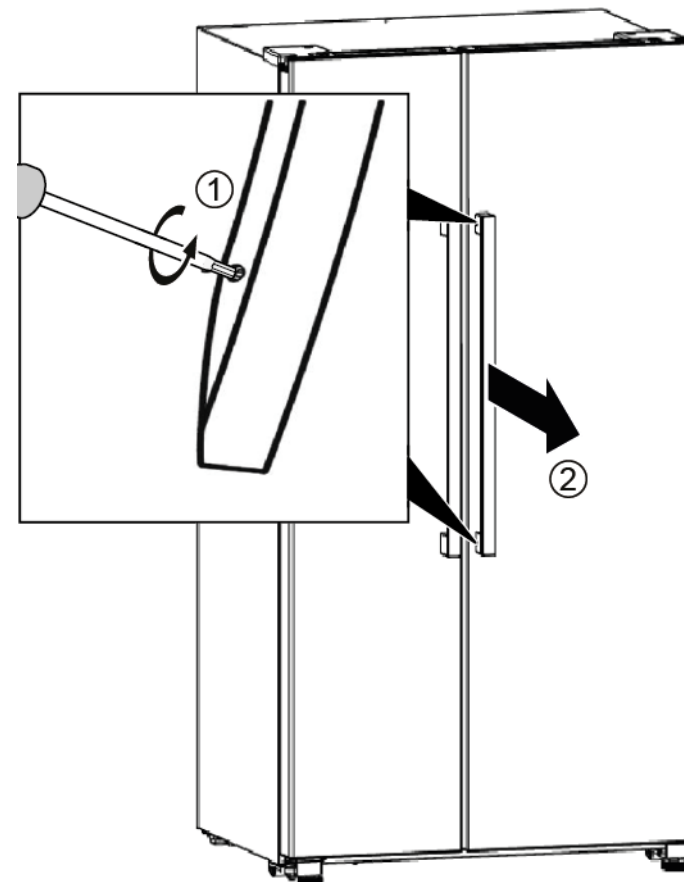

➡ Durvju rokturis ir noņemts.

2. Tāpat noņemiet otru durvju rokturi.

4.2.2 Durvju roktura uzstādīšana

- ▶ Uzstādiet apgrieztā kārtībā.

4.3 Plaukta nomaiņa

Prasība:

- ✔ Durvīm ir jābūt atvērtām.

4.3.1 Plaukta izņemšana

- ▶ Izvelciet plauktu.

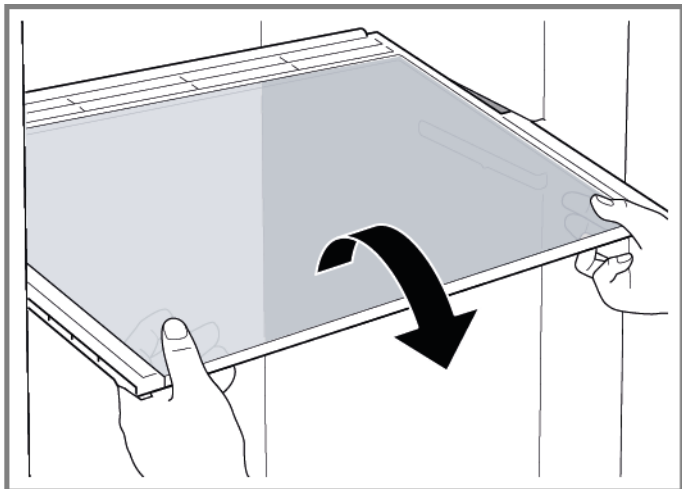

- ➡ Plaukts ir izņemts.

4.3.2 Plaukta uzstādīšana

- ▶ Uzstādiet apgrieztā kārtībā.

4.4 Pudeļu plaukta nomaiņa

Prasība:

- ✔ Durvīm ir jābūt atvērtām.

4.4.1 Pudeļu plaukta izņemšana

- ▶ Izvelciet pudeļu plauktu.

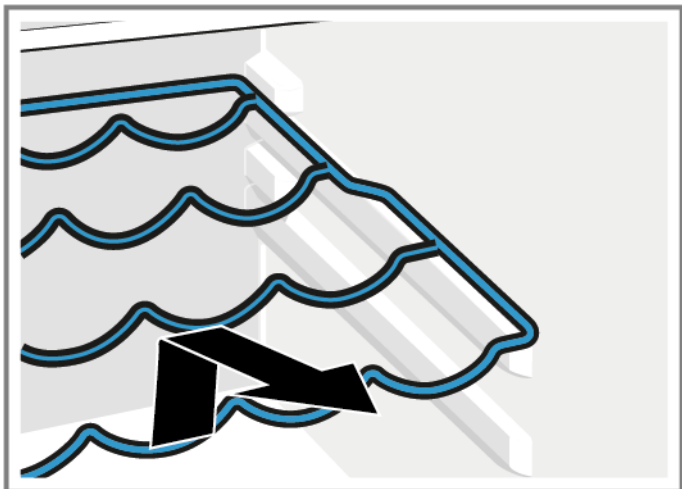

- ➡ Pudeļu plaukts ir izņemts.

4.4.2 Pudeļu plaukta uzstādīšana

- ▶ Uzstādiet apgrieztā kārtībā.

4.5 Durvju plaukta nomaiņa

Prasība:

- ✔ Durvīm ir jābūt atvērtām.

4.5.1 Durvju plaukta noņemšana

- ▶ Paceliet durvju plauktu uz augšu.

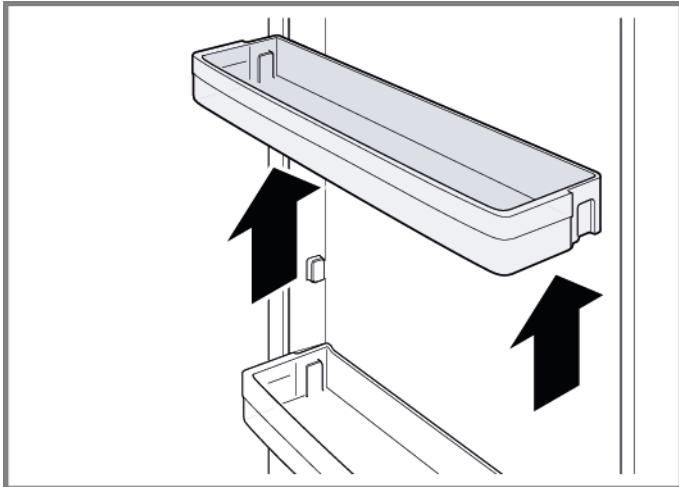

- ➡ Durvju plaukts ir noņemts.

4.5.2 Durvju plaukta uzstādīšana

- ▶ Uzstādiet apgrieztā kārtībā.

4.6 Tvertņu nomaiņa

Prasība:

- ✔ Durvīm ir jābūt atvērtām.

4.6.1 Tvertņu izņemšana

- ▶ Tvertni pilnībā izvelciet, paceliet, lai atbrīvotu no turētāja, un izņemiet.

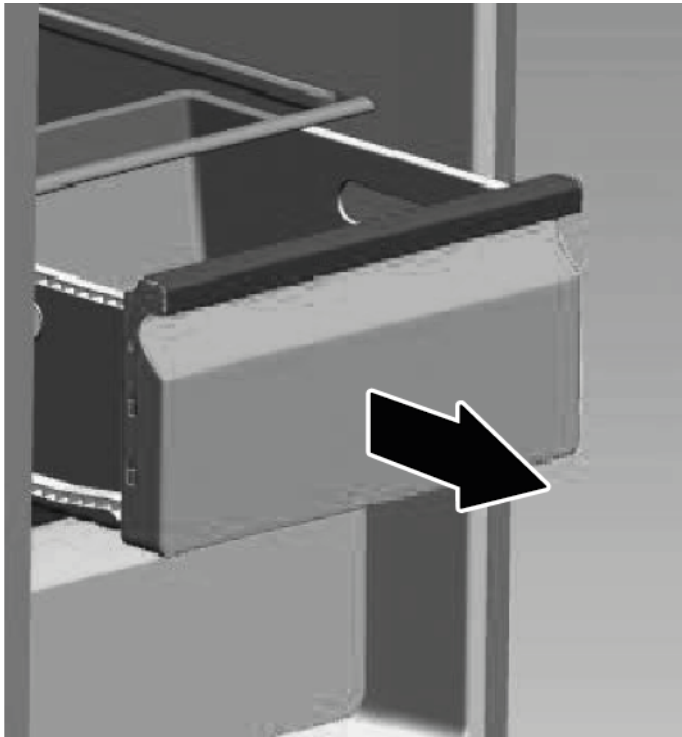



- ➡ Tvertne ir izņemta.

4.6.2 Tvertņu uzstādīšana

- ▶ Uzstādiet apgrieztā kārtībā.

4.7 LED spuldzes nomaiņa

	Ierīcē ir LED gaismeklis, kam nav jāveic apkope. Šo gaismekli drīkst remontēt tikai klientu apkalpošanas dienesta pārstāvis vai pilnvarots tehniķis!
-----------------------------------------------------------------------------------	---------------------------------------------------------------------------------------------------------------------------------------------------------

	⚠ BĪSTAMI Elektrotrieciena risks spriegumaktīvu daļu dēļ! Dzīvības apdraudējums nepareiza remonta izraisīta elektrotrieciena dēļ. <ul style="list-style-type: none">▶ Elektriskās daļas ir jāremontē kvalificētam elektriķim.▶ Pēc remonta ierīces drošība ir jāpārbauda atbilstīgi noteikumiem VDE 0701 vai valsts noteikumiem.
----------------------------------------------------------------------------------	-----------------------------------------------------------------------------------------------------------------------------------------------------------------------------------------------------------------------------------------------------------------------------------------------------------------------------------------------------------------------------

	⚠ ESIET PIESARDZĪGI Asas malas! Grieztas brūces <ul style="list-style-type: none">▶ Lietojiet aizsargcimdus.
----------------------------------------------------------------------------------	------------------------------------------------------------------------------------------------------------------------------------------------

Prasība:

- ✓ Ierīces elektropadevei ir jābūt atvienotai.
- ✓ Durvīm ir jābūt atvērtām.
- ✓ Augšējam plauktam ir jābūt izņemtam.

4.7.1 LED spuldzes izņemšana

1. LED gaismekļa pārsegu satveriet ar abām rokām un novelciet.



- ➡ LED gaismekļa pārsegs ir noņemts.



2. LED spuldzi pavelciet un izņemiet.



3. Atvienojiet spaili.







- ➡ LED spuldze ir izņemta.

4.7.2 LED spuldzes uzstādīšana

- ▶ Uzstādiet apgrieztā kārtībā.

Informacija apie remontą - Šaldymo prietaiso ir šaldiklio kombinacija

 Dėl šio dokumento	213
1.1 Svarbi informacija	213
1.1.1 Paskirtis	213
1.2 Simbolių paaiškinimas	213
1.2.1 Pavojaus lygiai.....	213
1.2.2 Pavojaus simboliai	213
1.2.3 Įspėjimų struktūra.....	214
1.2.4 Bendrieji simboliai	214
 Sauga	215
2.1 Bendrosios saugos instrukcijos.....	215
2.1.1 Visi buitiniai prietaisai	215
 Įrankiai ir pagalbinės priemonės	216
 Remontas	217
4.1 Durelių tarpiklio keitimas	217
4.1.1 Durelių tarpiklio išėmimas.....	217
4.1.2 Durelių tarpiklio įdėjimas.....	217
4.2 Durelių rankenos keitimas	220
4.2.1 Durelių rankenos nuėmimas	220
4.2.2 Durelių rankenos tvirtinimas.....	220
4.3 Lentynos keitimas.....	221
4.3.1 Lentynos nuėmimas	221
4.3.2 Lentynos įdėjimas	221
4.4 Butelių padėklo keitimas	222
4.4.1 Butelių padėklo išėmimas	222
4.4.2 Butelių padėklo įdėjimas	222
4.5 Durelių lentynos keitimas	223
4.5.1 Durelių lentynos išėmimas.....	223
4.5.2 Durelių lentynos įdėjimas.....	223
4.6 Talpyklų keitimas.....	224
4.6.1 Talpyklų išėmimas	224
4.6.2 Talpyklų įdėjimas	224
4.7 LED lemputės keitimas	225
4.7.1 LED lemputės išėmimas.....	225
4.7.2 LED lemputės įdėjimas.....	226

i Dėl šio dokumento

1.1 Svarbi informacija

1.1.1 Paskirtis

Šios remonto nuorodos padeda naudotojui pataisyti prietaisus patiems pagal galiojantį ekologinio projektavimo reglamentą (2021 m. kovo mėn. redakcija).

Jose pateikta informacija, kaip pakeisti tam tikras atsargines dalis, įskaitant ir įspėjimus bei riziką.

Jei kiltų klausimų, kreipkitės į mūsų klientų aptarnavimo tarnybą. Mes atsakysime už žalą tik tuo atveju, jei bus tinkamai laikomasi remonto nuorodų.

1.2 Simbolių paaiškinimas

1.2.1 Pavojaus lygiai

Įspėjimo lygiai susideda iš simbolio ir signalinio žodžio. Signalinis žodis nurodo pavojaus sunkumą.





Įspėjimo lygis	Reikšmė
 PAVOJUS	Nepaisant įspėjamojo pranešimo, ištinka mirtis arba sunkūs sužalojimai.
 ĮSPĖJIMAS	Nepaisant įspėjamojo pranešimo, gali ištikti mirtis arba sunkūs sužalojimai.
 PERSPĖJIMAS	Nepaisant įspėjamojo pranešimo, galimi nedideli sužalojimai.
DĖMESIO!	Nepaisant įspėjamojo pranešimo, gali būti sugadintas turtas.

Lentelė 1: Pavojaus lygiai



1.2.2 Pavojaus simboliai

Pavojaus simboliai yra simboliniai atvaizdai, nurodantys pavojaus rūšį.

Šiame: dokumente naudojami tokie pavojaus simboliai

Pavojaus simbolis	Reikšmė
	Bendras įspėjamasis pranešimas
	Pavojinga elektros įtampa
	Sprogimo pavojus
	Įpjovimo pavojus
	Prispaudimo pavojus

i Dėl šio dokumento

Pavojaus simbolis	Reikšmė
	Pavojus dėl karštų paviršių
	Pavojus dėl stipraus magnetinio lauko
	Pavojus dėl nejonizuojančiosios spinduliuotės

Lentelė 2: Pavojaus simboliai

1.2.3 Įspėjimų struktūra

Šiame dokumente pateikiami įspėjimai yra standartizuotos išvaizdos ir standartizuotos struktūros.



	<div style="background-color: red; color: white; padding: 2px; display: inline-block;">⚠ PAVOJUS</div> <p>Pavojaus tipas ir šaltinis! Galimos pasekmės, jei nepaisoma pavojaus / įspėjimo.</p> <ul style="list-style-type: none"> ▶ Priemonės ir draudimai pavojui išvengti.
----------------------------------------------------------------------------------	---------------------------------------------------------------------------------------------------------------------------------------------------------------------------------------------------------------------------------------------------------------------------------------------------------------





Šiame pavyzdyje parodytas įspėjimas, įspėjantis apie elektros smūgį dėl dalių su įtampa. Paminėta priemonė, kaip išvengti pavojaus.

	<div style="background-color: red; color: white; padding: 2px; display: inline-block;">⚠ PAVOJUS</div> <p>Elektros smūgio pavojus dėl dalių, kuriose yra įtampa! Mirtis dėl elektros smūgio</p> <ul style="list-style-type: none"> ▶ Prieš pradėdami remontą, ne mažiau kaip prieš 60 sekundžių atjunkite prietaisus nuo elektros tiekimo.
-----------------------------------------------------------------------------------	-----------------------------------------------------------------------------------------------------------------------------------------------------------------------------------------------------------------------------------------------------------------------------------------------------------------------------------------------------------------------------

1.2.4 Bendrieji simboliai

Šiame dokumente naudojami tokie bendrieji simboliai:

Bendr. simbolis	Reikšmė
	Žymi specialų patarimą (tekstas ir (arba) grafika)
	Žymi paprastą patarimą (tik tekstas)
	Žymi nuorodą į vaizdo pamoką

Bendr. simbolis	Reikšmė
	Žymi reikalingus įrankius
	Žymi reikalingas prielaidas
	Žymi sąlygą (jei ..., tai ...)
	Žymi rezultatą
<code>[Paleisti]</code>	Žymi klavišą arba ekrano mygtuką
<code>[00123456]</code>	Žymi dalies numerį
<code>Būsena</code>	Žymi rodomą tekstą / langą (prietaiso ekrane)

Lentelė 3: Bendrieji simboliai

2.1 Bendrosios saugos instrukcijos

2.1.1 Visi būtiniai prietaisai

Elektros smūgio pavojus dėl dalių, kuriose yra įtampa!

- Elektrinių konstrukcinių dalių remonto klaidos gali sukelti elektros smūgį!
- Prieš pradėdami dirbti, ne mažiau kaip prieš 60 sekundžių atjunkite prietaisą nuo maitinimo.
- Po remonto pasirūpinkite, kad būtų atliktas saugos bandymas pagal VDE 0701 arba šalyje galiojančius reglamentus.

Pavojus susižeisti į aštrias briaunas!

- Mūvėkite apsaugines pirštines.

Prispaudimo rizika remonto, einamosios techninės priežiūros, sutrikimų šalinimo ir techninės priežiūros metu dėl sunkių ir judančių konstrukcinių dalių

- Avėkite apsauginius batus.
- Apsaugokite sunkias konstrukcines dalis, kad jos nenukristų.
- Neartinkite kūno dalių prie judančių konstrukcinių dalių.



Rizika prietaiso saugai / veikimui!

- Naudokite tik originalias atsargines dalis.

Elektrostatškai jautrių konstrukcinių dalių (ESD) pažeidimo rizika!

- Nelieskite modulių, o taip pat ir jų jungčių bei laidininkų kelių.

Įrankiai ir pagalbinės priemonės

Paskyrimas	Išsami informacija	Vaizdai
Apsauginis audinys [00342013]	60 cm x 50 cm	
Šešiabriauniai veržliarakčiai su antgaliais [00340819]	2 mm, 2,5 mm, 3 mm, 4 mm, 5 mm, 6 mm, 8 mm	

4.1 Durelių tarpiklio keitimas

Reikalavimas.

- ✔ Durelės turi būti atidarytos.

4.1.1 Durelių tarpiklio išėmimas

1. Išimkite durelių tarpiklį iš griovelio dešiniame ir kairiajame kampe.

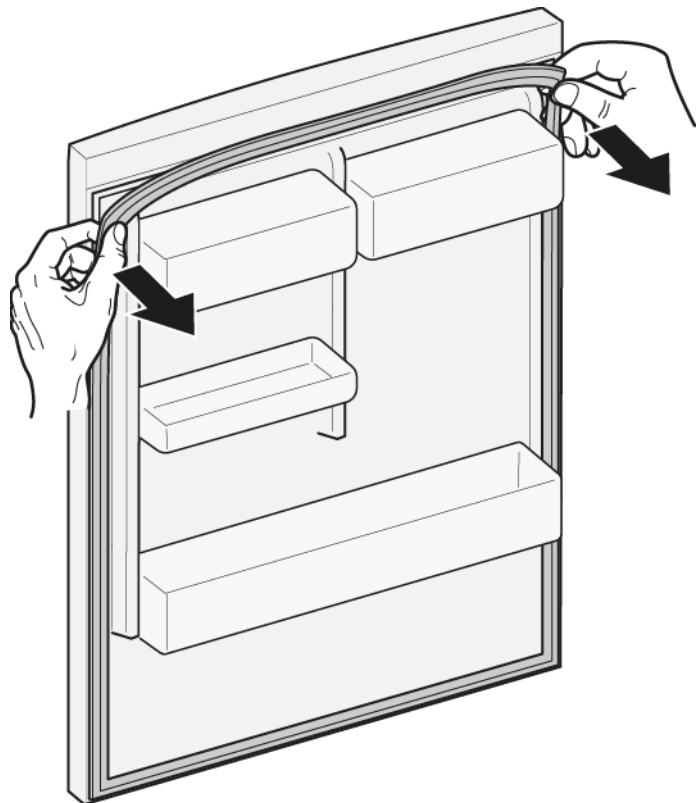

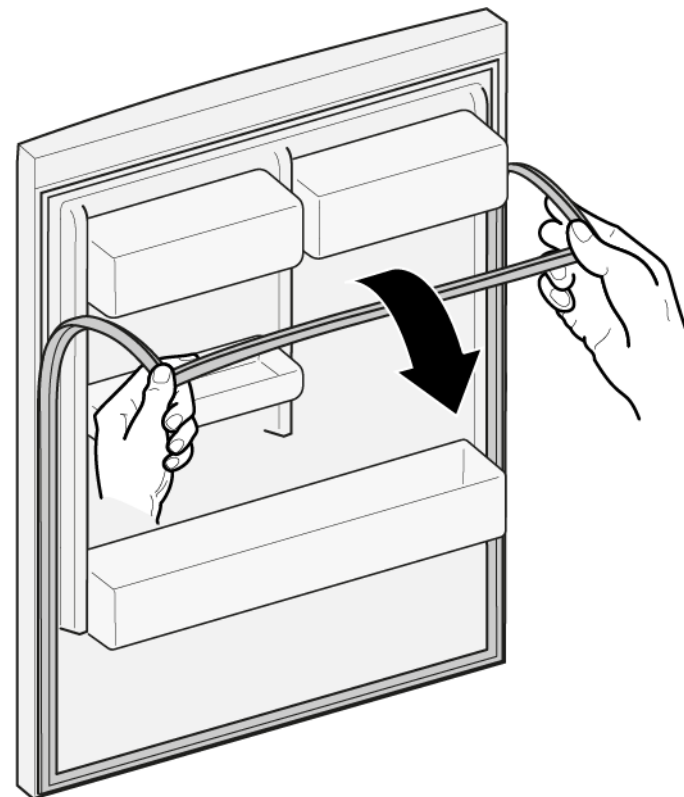

2. Ištraukite durelių tarpiklį iš griovelio.



- ➡ Durelių tarpiklis išimtas.

4.1.2 Durelių tarpiklio įdėjimas

	Naujo durelių tarpiklio storis gali šiek tiek skirtis nuo seno durelių tarpiklio storio. Dėl to durelės vis tiek užsidarys, o tarpiklį bus galima naudoti ilgai.
	Jei jūsų prietaiso vyriai arba vyrio priedai reguliuojami, uždarymo funkciją vėliau galima optimizuoti.
	Nedidelės šoninės skylutės durelių tarpikyje turi savo funkciją (reikalingos ventiliacijai). Tai nėra gamybinis brokas.

1. Patikrinkite griovelį, ar nėra tarpiklį galinčių pažeisti vietų.

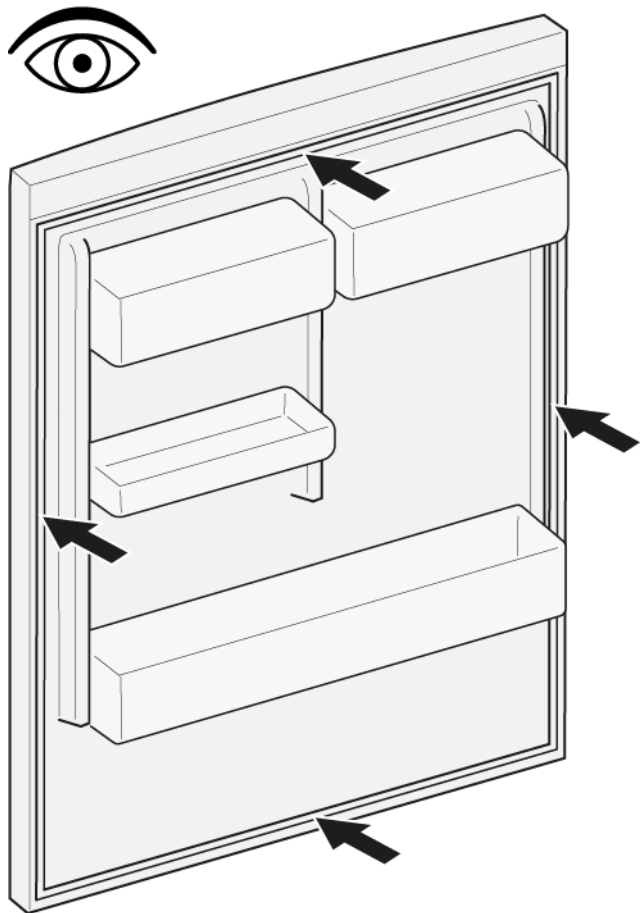

4. Įspauskite tarpiklio kampus viršuje ir apačioje į griovelį.

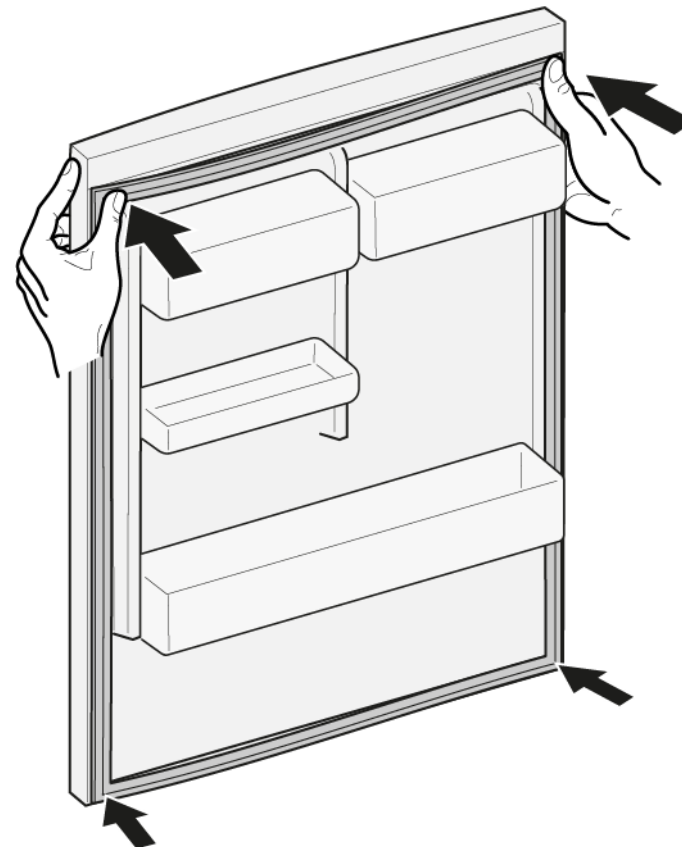

2.  Jei tarpiklio griovelis pažeistas.
- Kreipkitės į klientų aptarnavimo tarnybą.

3.  Nedidelės durelių tarpiklio deformacijos yra įprastas požymis ir nepaveikia tarpiklio funkcinių savybių. Prieš įdedant durelių tarpiklį į prietaisą, rekomenduojama jį ištiesinti.

Pašildykite durelių tarpiklį plaukų džiovintuvu arba karštu vandeniu ir iš naujo suteikite formą rankiniu būdu.

5. Po truputį įspauskite į griovelį visą tarpiklį.

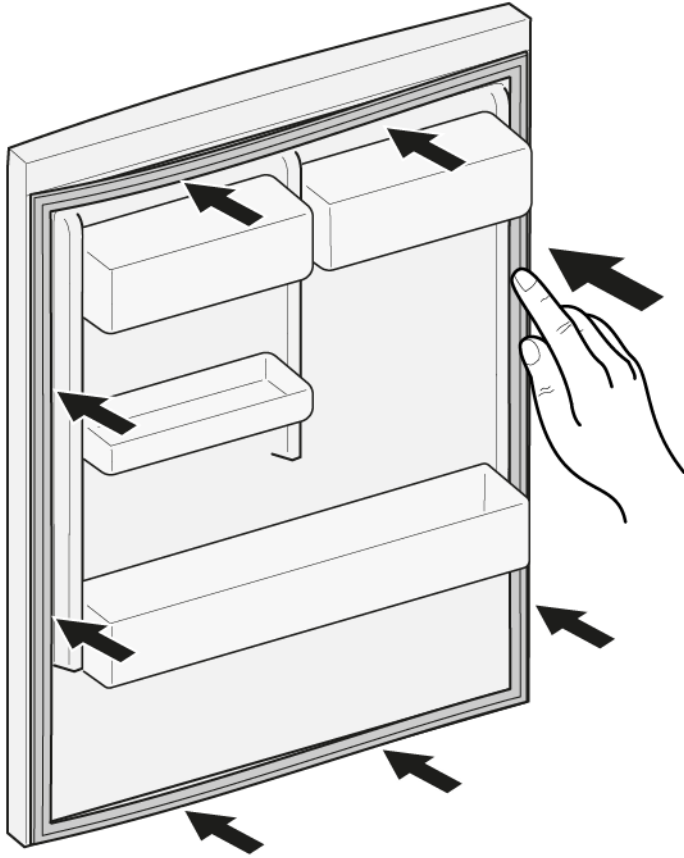

 Durelių tarpiklis įdėtas.

4.2 Durelių rankenos keitimas

Specialūs įrankiai.

- Šešiabriauniai varžliarakčiai su antgaliais 2 mm, 2,5 mm, 3 mm, 4 mm, 5 mm, 6 mm, 8 mm [00340819]

Reikalavimas.

- ✓ Prietaisas turi būti atjungtas nuo maitinimo šaltinio.
- ✓ Durelės turi būti atidarytos.

4.2.1 Durelių rankenos nuėmimas

1. Išsukite du varžtus (1).
2. Nuimkite durelių rankeną (2).

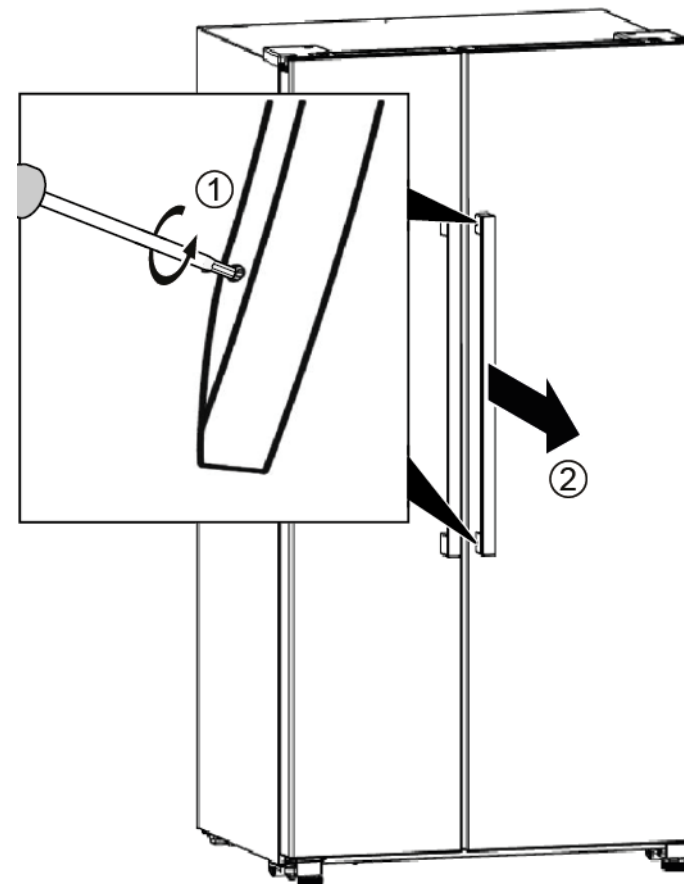

➡ Durelių rankena nuimta.

2. Tokiu pačiu būdu nuimkite ir antrą durelių rankeną.

4.2.2 Durelių rankenos tvirtinimas

- ▶ Uždėkite atvirkščia eilės tvarka.

4.3 Lentynos keitimas

Reikalavimas.

- ✔ Durelės turi būti atidarytos.

4.3.1 Lentynos nuėmimas

- ▶ Ištraukite lentyną.

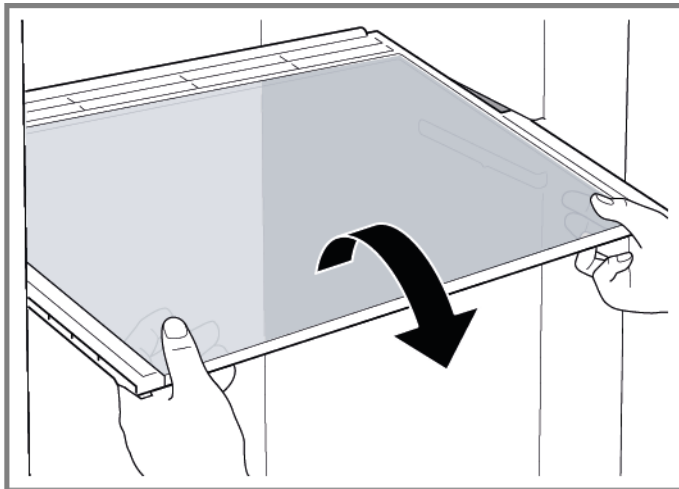

- ➡ Lentyna išimta.

4.3.2 Lentynos įdėjimas

- ▶ Uždėkite atvirkščia eilės tvarka.

4.4 Butelių padėklo keitimas

Reikalavimas.

- ✔ Durelės turi būti atidarytos.

4.4.1 Butelių padėklo išėmimas

- ▶ Ištraukite butelių padėklą.

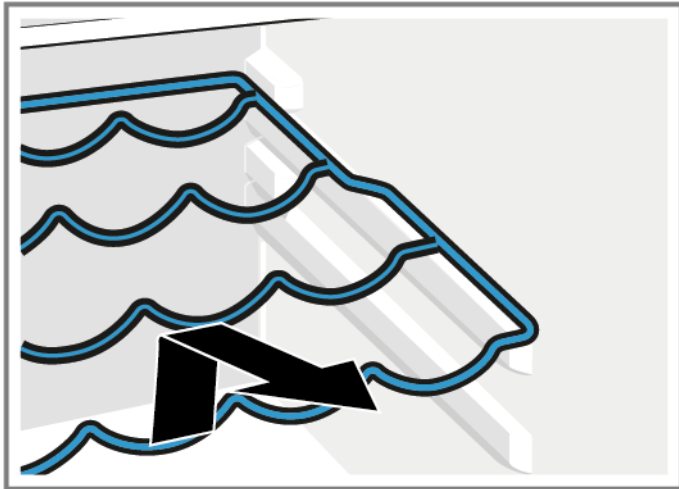

- ➔ Butelių padėklas išimtas.

4.4.2 Butelių padėklo įdėjimas

- ▶ Uždėkite atvirkščia eilės tvarka.

4.5 Durelių lentynos keitimas

Reikalavimas.

- ✔ Durelės turi būti atidarytos.

4.5.1 Durelių lentynos išėmimas

- ▶ Pakelkite durelių lentyną į viršų.

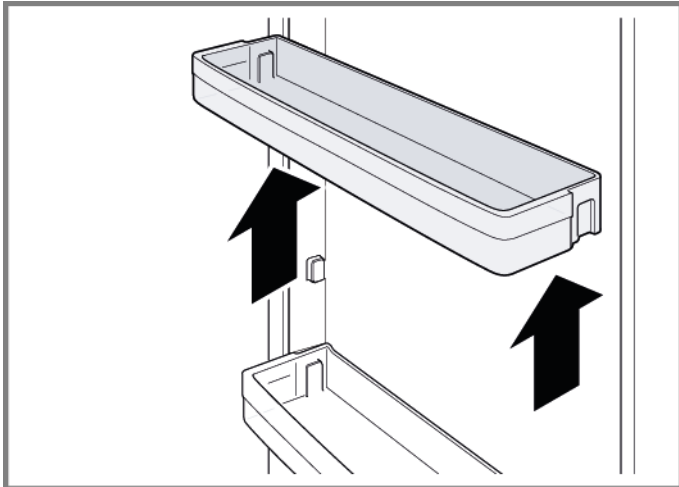

- ➡ Durelių lentyna išimta.

4.5.2 Durelių lentynos įdėjimas

- ▶ Uždėkite atvirkščia eilės tvarka.

4.6 Talpyklų keitimas

Reikalavimas.

- ✔ Durelės turi būti atidarytos.

4.6.1 Talpyklų išėmimas

- ▶ Ištraukite talpyklą iki pat galo, kilstelėkite, kad atkabintumėte nuo laikiklio, ir išimkite.

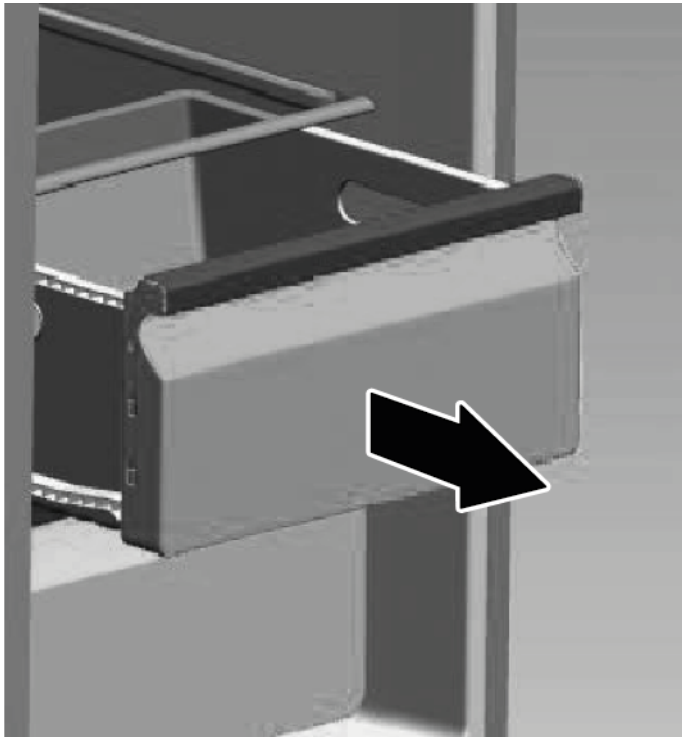

- ➡ Talpykla išimta.

4.6.2 Talpyklų įdėjimas

- ▶ Uždėkite atvirkščia eilės tvarka.

4.7 LED lemputės keitimas

i Jūsų prietaise įrengta techninės priežiūros nereikalaujanti LED lemputė. Šią lemputę gali taisyti tik klientų aptarnavimo tarnybos specialistai arba įgalioti technikai!

⚠ PAVOJUS
Elektros smūgio pavojus dėl dalių, kuriose yra įtampa!
Pavojus gyvybei dėl elektros smūgio netinkamo remonto atveju

- ▶ Elektrines dalis remontuoti turi kvalifikuoti elektrikai.
- ▶ Po remonto pasirūpinkite, kad būtų atliktas saugos bandymas pagal VDE 0701 arba šalyje galiojančius reglamentus.

⚠ PERSPĖJIMAS
Aštrios briaunos!
Galima įsipjauti

- ▶ Mūvėkite apsaugines pirštines.

Reikalavimas.

- ✓ Prietaisas turi būti atjungtas nuo maitinimo šaltinio.
- ✓ Durelės turi būti atidarytos.
- ✓ Viršutinė lentyna išimta.

4.7.1 LED lemputės išėmimas

1. Suimkite LED lemputės dangtelį dviem rankomis ir patraukite žemyn



- ➡ LED lemputės dangtelis nuimtas.



2. Patraukite ir išimkite LED lemputę



3. Atjunkite gnybtą



- ➡ LED lemputė išimta.

4.7.2 LED lemputės įdėjimas

- ▶ Uždėkite atvirkščia eilės tvarka.

Reparasjonstips - Kjøle-/frysekombinasjon

 Om dette dokumentet	228
1.1 Viktig informasjon	228
1.1.1 Formål.....	228
1.2 Forklaring av symboler.....	228
1.2.1 Farenivåer	228
1.2.2 Faresymboler.....	228
1.2.3 Advarslenes struktur	229
1.2.4 Generelle symboler	229
 Sikkerhet	230
2.1 Generelle sikkerhetsinstruksjoner	230
2.1.1 Alle husholdningsapparater	230
 Verktøy og hjelpemidler	231
 Reparasjon	232
4.1 Utskiftning av dørpakning.....	232
4.1.1 Demontering av dørpakning.....	232
4.1.2 Montering av dørpakning	232
4.2 Utskiftning av dørhåndtak.....	235
4.2.1 Demontering av dørhåndtak	235
4.2.2 Montering av dørhåndtak.....	235
4.3 Utskiftning av hylle.....	236
4.3.1 Demontering av hylle.....	236
4.3.2 Montering av hylle	236
4.4 Utskiftning av flaskehylle	237
4.4.1 Demontering av flaskehylle.....	237
4.4.2 Montering av flaskehylle	237
4.5 Utskiftning av dørrack	238
4.5.1 Demontering av dørrack	238
4.5.2 Montering av dørrack	238
4.6 Utskiftning av beholdere.....	239
4.6.1 Demontering av beholdere.....	239
4.6.2 Montering av beholdere.....	239
4.7 Utskiftning av LED-lampe.....	240
4.7.1 Demontering av LED-lampe.....	240
4.7.2 Montering av LED-lampe	241

i Om dette dokumentet

1.1 Viktig informasjon

1.1.1 Formål

Disse tipsene om reparasjon skal hjelpe kunden til selv å kunne reparere apparater i samsvar med gjeldende regulering av øko-design (med gyldighet 03/2021).





De inneholder informasjon om hvordan definerte reservedeler skiftes, inklusive advarsler og risikoer.

Kontakt vår kundeservice dersom du har spørsmål. Vi påtar oss kun ansvar for skader dersom tipsene om reparasjon er korrekt fulgt.

1.2 Forklaring av symboler

1.2.1 Farenivåer

Advarslene som viser farenivå, består av et symbol og et signalord. Signalordet viser hvor alvorlig faren er.





Advarsel som viser farenivå	Betydning
 FARE	Dersom advarselen ignoreres, vil det føre til død eller alvorlige personskader.
 ADVARSEL	Dersom advarselen ignoreres, kan det føre til død eller alvorlige personskader.
 FORSIKTIG	Dersom advarselen ignoreres, kan det føre til mindre personskader.
 OBS!	Dersom advarselen ignoreres, kan det føre til materiell skade.

Tabell 1: Farenivåer



1.2.2 Faresymboler

Faresymboler er symbolske fremstillinger som gir en indikasjon av hvilken type fare det dreier seg om.

Følgende faresymboler brukes i dette dokumentet:

Faresymbol	Betydning
	Generell advarsel
	Fare for elektrisk støt
	Eksplisjonsfare
	Fare for å skjære seg
	Klemfare



i Om dette dokumentet

Faresymbol	Betydning
	Fare på grunn av varme overflater
	Fare på grunn av sterkt magnetfelt
	Fare fra ikke-ioniserende stråling



Tabell 2: Faresymboler

1.2.3 Advarslenes struktur

Advarslene i dette dokumentet har standardisert utseende og standardisert struktur.



	<div style="background-color: red; color: white; padding: 2px; text-align: center;">  FARE </div> <p>Faretype og kilde til fare! Mulige konsekvenser dersom fare/advarsel ignoreres.</p> <ul style="list-style-type: none"> ▶ Tiltak og forbud for å forebygge fare.
----------------------------------------------------------------------------------	---------------------------------------------------------------------------------------------------------------------------------------------------------------------------------------------------------------------------------------------------------------------------------------------------------------------------------------------------------------------------------------------------







Eksemplet nedenfor viser en advarsel mot elektrisk støt på grunn av strømførende deler. Tiltaket for å unngå faren er angitt.

	<div style="background-color: red; color: white; padding: 2px; text-align: center;">  FARE </div> <p>Fare for elektrisk støt på grunn av strømførende deler! Død på grunn av drepende elektrisk støt</p> <ul style="list-style-type: none"> ▶ Koble apparatene fra strømforsyningen i minst 60 sekunder før reparasjonene startes.
-----------------------------------------------------------------------------------	-----------------------------------------------------------------------------------------------------------------------------------------------------------------------------------------------------------------------------------------------------------------------------------------------------------------------------------------------------------------------------------------------------------------------------------------------------------------

1.2.4 Generelle symboler

Følgende generelle symboler brukes i dette dokumentet:

Gen. symbol	Betydning
	Identifisering av et spesielt tips (tekst og/eller grafikk)
	Identifisering av et enkelt tips (kun tekst)
	Identifisering av en lenke til en opplæringsvideo

Gen. symbol	Betydning
	Identifisering av nødvendig verktøy
	Identifisering av nødvendige forutsetninger
	Identifisering av en betingelse (hvis ..., så ...)
	Identifisering av et resultat
	Identifisering av en tast eller knapp
	Identifisering av et materialnummer
	Identifisering av vist tekst/vindu (i apparatets display)

Tabell 3: Generelle symboler

2.1 Generelle sikkerhetsinstruksjoner

2.1.1 Alle husholdningsapparater

Fare for elektrisk støt på grunn av strømførende deler!

- Feil ved reparasjoner hvor elektriske komponenter er involvert, kan føre til elektrisk støt!
- Koble apparatet fra strømmettet i minst 60 sekunder før arbeidet startes.
- Etter reparasjonen må du sørge for at det utføres en sikkerhetstest iht. VDE 0701 eller gjeldende forskrifter i det respektive land.

Fare for personskade på grunn av skarpe kanter!

- Bruk vernehansker.

Fare for å knuse legemsdeler under reparasjoner, vedlikehold, feilsøking og service på grunn av tunge og bevegelige komponenter

- Bruk vernesko.
- Sikre tunge komponenter for å hindre at de faller ned.
- Ikke stikk kroppsdelene inn i bevegelige komponenter.



Fare for apparatets sikkerhet/funksjon!

- Bruk kun originale reservedeler.

Fare for skade på deler som er følsomme overfor elektrostatisk utlading (ESD)!

- Ikke berør modulene, inklusive tilkoblinger og ledere.

Verktøy og hjelpemidler

Betegnelse	Detaljer	Bilder
Beskyttelsesklut [00342013]	60 cm x 50 cm	
Sekskant-pipenøkkel [00340819]	2 mm, 2,5 mm, 3 mm, 4 mm, 5 mm, 6 mm, 8 mm	

4.1 Utskiftning av dørpakning

Forutsetning:

- ✔ Døren er åpen.

4.1.1 Demontering av dørpakning

1. Løsne dørpakningen fra sporet i høyre og venstre hjørne.

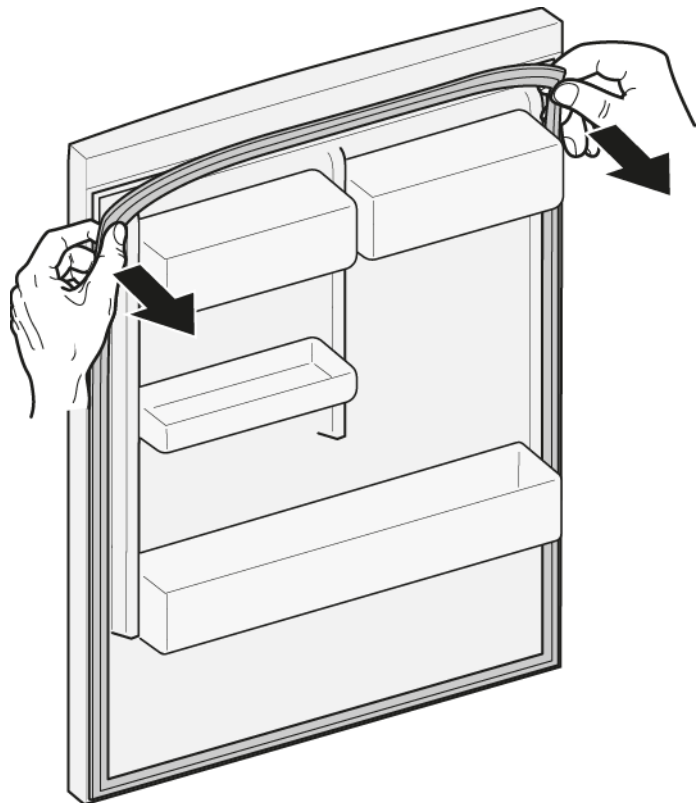

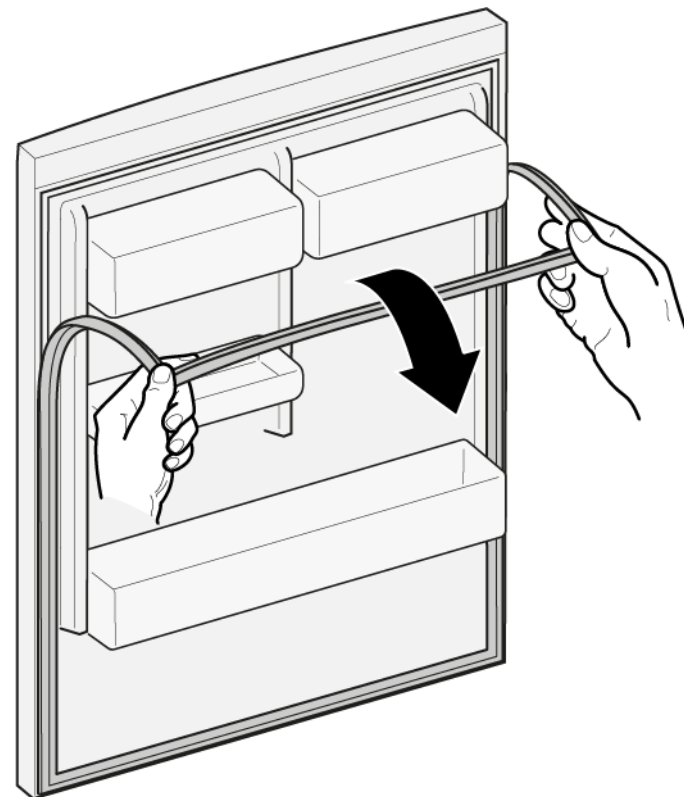

2. Trekk pakningen ut av sporet.



- ➡ Dørpakningen er demontert.

4.1.2 Montering av dørpakning

	Tykkelsen på den nye dørpakningen kan avvike litt fra tykkelsen på den gamle dørpakningen. Det har ingen innvirkning på lukkeatferd og langvarig funksjon.
	Hvis apparatet har justerbare hengsler eller hengslefester, kan du optimalisere lukkeatferden etterpå.
	Små sidehull i dørpakningen har en funksjon (nødvendige for ventilasjonen). Det dreier seg ikke om produksjonsfeil.

Reparasjon

1. Kontroller at sporet for pakningen ikke har skader.

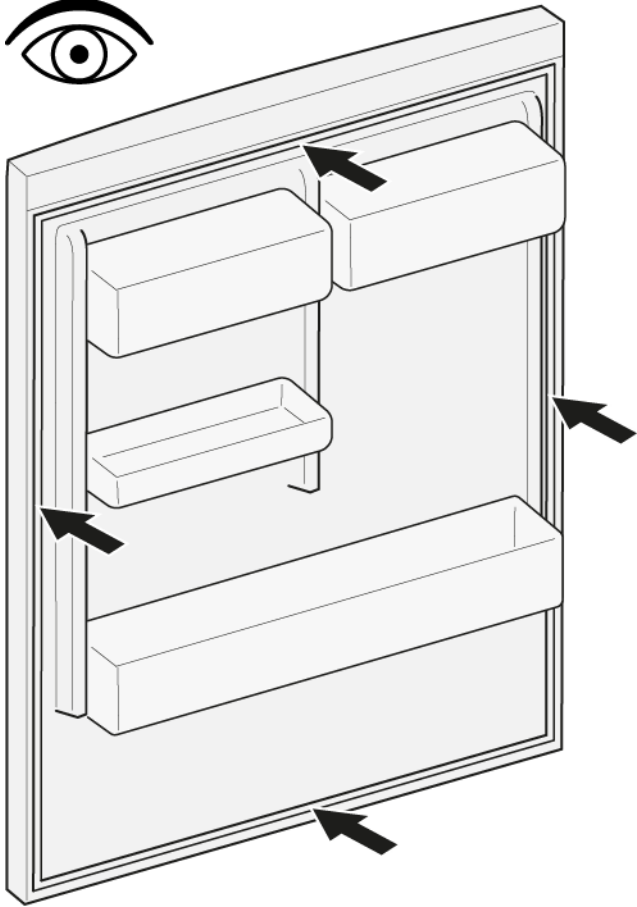

2.  Hvis sporet for pakningen er skadet:
 - Kontakt kundeservice.

3.  Litt deformasjon av dørpakningen er normalt og har ingen innvirkning på funksjonen. Det anbefales å rette ut dørpakningen før den settes inn i apparatet.

Varm opp dørpakningen med en føn eller varmt vann og form den på nytt med hendene.

4. Skyv pakningens hjørner øverst og nederst inn i sporet.

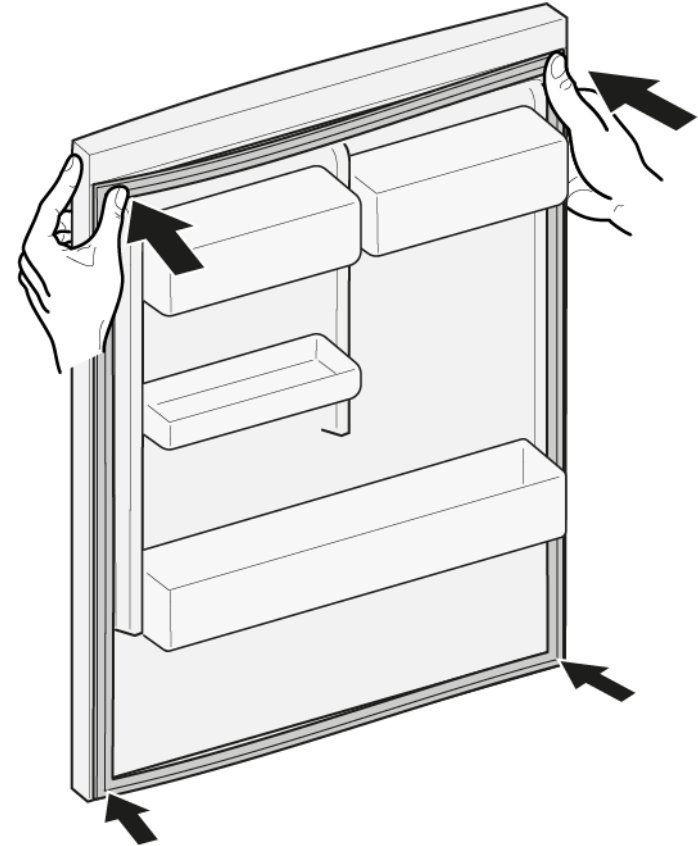

Reparasjon

5. Trykk hele pakningen inn i sporet trinn for trinn.

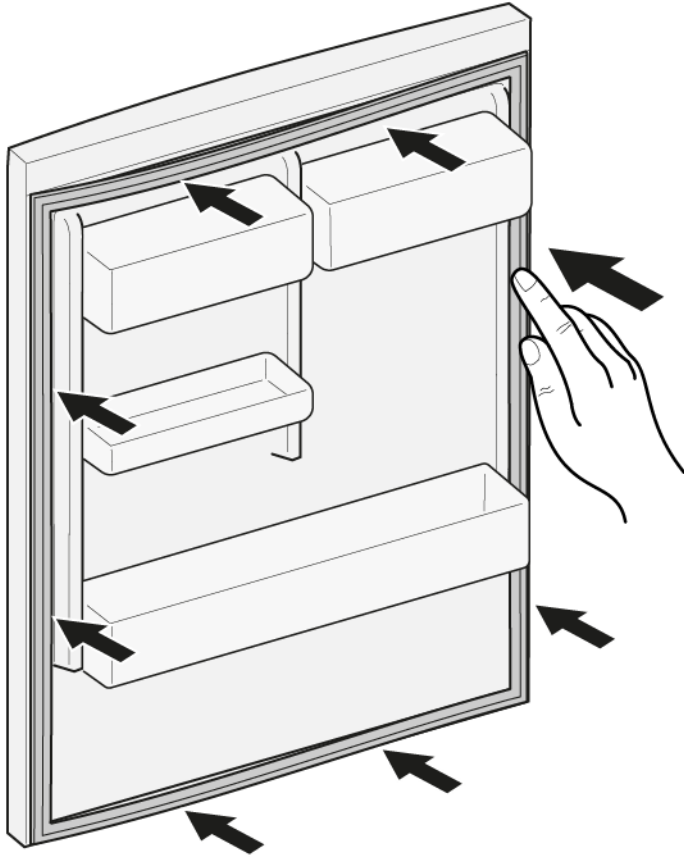

 Dørpakningen er montert.

4.2 Utskiftning av dørhåndtak

Spesielle hjelpemidler:

🔧 Sekskant-pipenøkkel 2 mm, 2,5 mm, 3 mm, 4 mm, 5 mm, [00340819]
6 mm, 8 mm

Forutsetning:

- ✔ Apparatet kobles fra strømforsyningen.
- ✔ Døren er åpen.

4.2.1 Demontering av dørhåndtak

1. Skru ut to skruer (1).
2. Demonter dørhåndtaket (2).

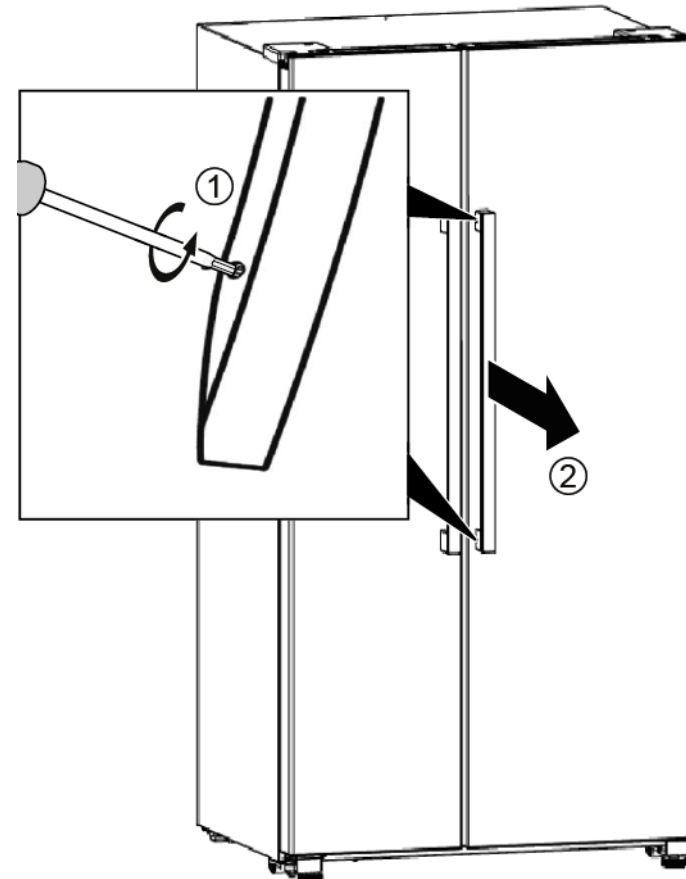

➡ Dørhåndtaket er demontert.

2. Demonter det andre dørhåndtaket på samme måte.

4.2.2 Montering av dørhåndtak

- ▶ Monteres i motsatt rekkefølge.

4.3 Utskiftning av hylle

Forutsetning:

- ✔ Døren er åpen.

4.3.1 Demontering av hylle

- ▶ Trekk ut hyllen.

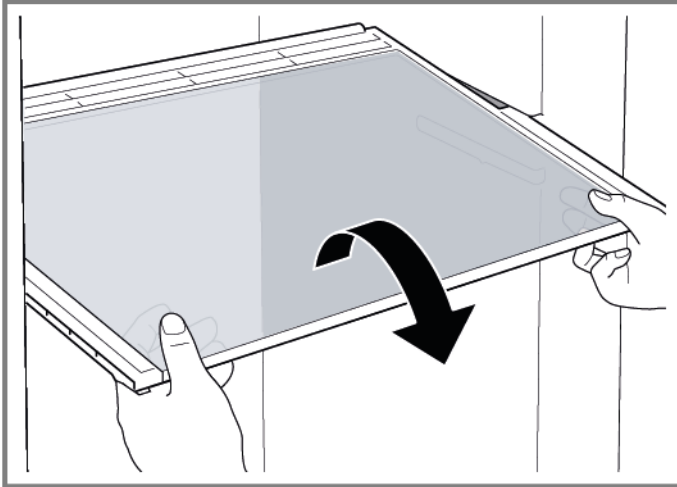

- ➡ Hyllen er demontert.

4.3.2 Montering av hylle

- ▶ Monteres i motsatt rekkefølge.

4.4 Utskiftning av flaskehylle

Forutsetning:

- ✔ Døren er åpen.

4.4.1 Demontering av flaskehylle

- ▶ Trekk ut flaskehyllen.

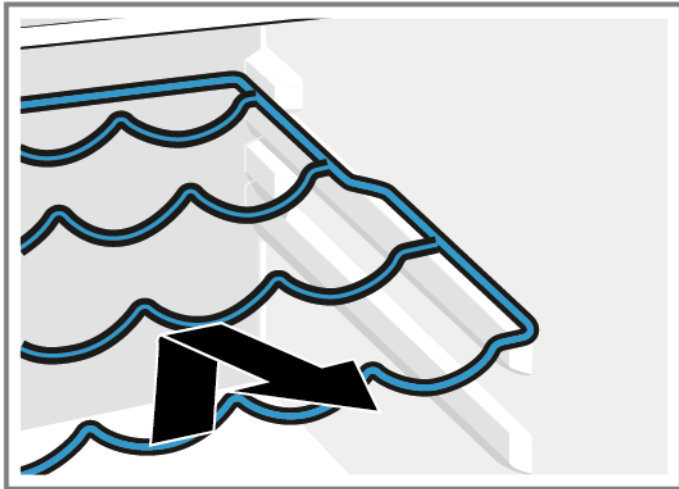

- ➡ Flaskehyllen er demontert.

4.4.2 Montering av flaskehylle

- ▶ Monteres i motsatt rekkefølge.

4.5 Utskiftning av dørrack

Forutsetning:

- ✔ Døren er åpen.

4.5.1 Demontering av dørrack

- ▶ Løft dørracken opp.

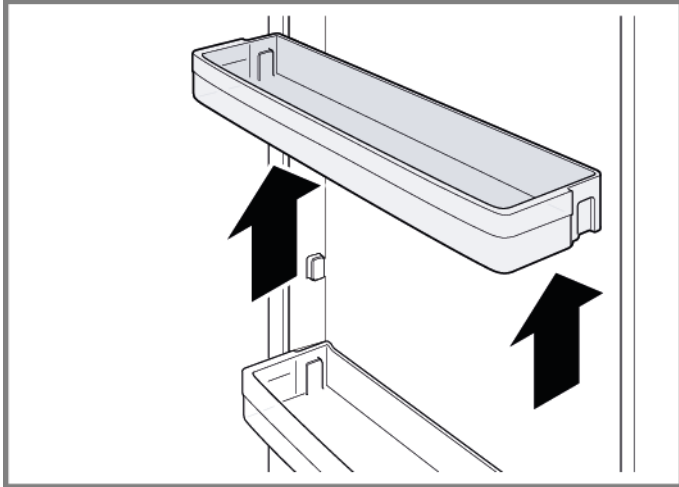

➡ Dørracken er demontert.

4.5.2 Montering av dørrack

- ▶ Monteres i motsatt rekkefølge.

4.6 Utskiftning av beholdere

Forutsetning:

- ✔ Døren er åpen.

4.6.1 Demontering av beholdere

- ▶ Trekk beholderen helt ut, løft den for å løsne den fra holderen og ta den ut.

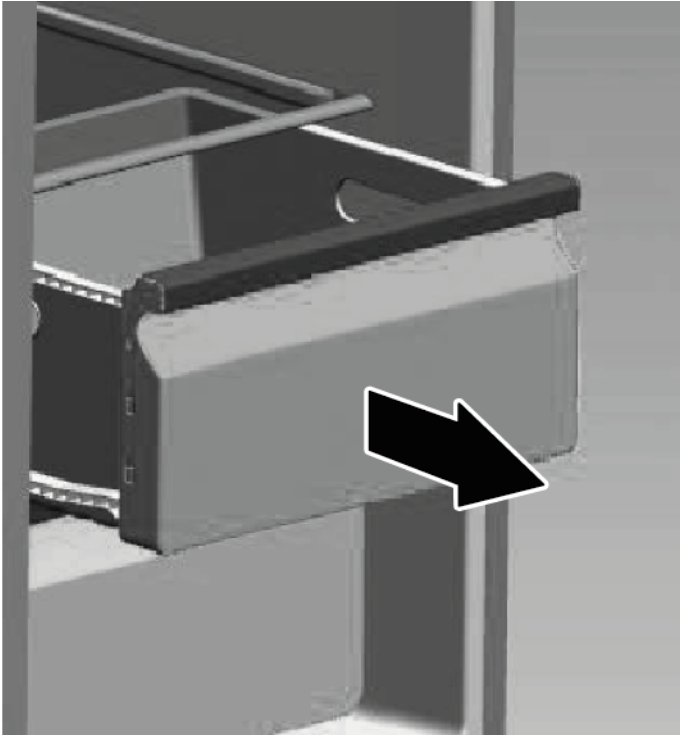

- ➡ Beholderen er demontert.

4.6.2 Montering av beholdere

- ▶ Monteres i motsatt rekkefølge.

Reparasjon

4.7 Utskiftning av LED-lampe

	Apparatet har en vedlikeholdsfri LED-lampe. Disse lampene skal kun repareres av kundeservice eller autoriserte teknikere!
-----------------------------------------------------------------------------------	---------------------------------------------------------------------------------------------------------------------------

	FARE Fare for elektrisk støt på grunn av strømførende deler! Livsfare på grunn av elektrisk støt ved feil reparasjon <ul style="list-style-type: none">▶ Elektriske deler skal repareres av kvalifiserte elektrikere.▶ Etter reparasjonen må du sørge for at det utføres en sikkerhets-test iht. VDE 0701 eller gjeldende forskrifter i det respektive land.
----------------------------------------------------------------------------------	---------------------------------------------------------------------------------------------------------------------------------------------------------------------------------------------------------------------------------------------------------------------------------------------------------------------------------------------------------------------------------------------------------

	FORSIKTIG Skarpe kanter! Kuttskader <ul style="list-style-type: none">▶ Bruk vernehansker.
----------------------------------------------------------------------------------	------------------------------------------------------------------------------------------------------------------------------

Forutsetning:

- ✔ Apparatet kobles fra strømforsyningen.
- ✔ Døren er åpen.
- ✔ Øvre hylle er demontert.

4.7.1 Demontering av LED-lampe

1. Grip fatt i LED lampedekslet med to hender og trekk det ned



- ➡ LED-lampedekslet er demontert.



2. Trekk og ta LED-lampen ut



3. Koble fra terminalen



- ➡ LED-lampen er demontert.

4.7.2 Montering av LED-lampe

- ▶ Monteres i motsatt rekkefølge.

Wskazówki naprawy - Chłodziarko-zamrażarka

 Informacje dotyczące dokumentu	243
1.1 Ważne informacje.....	243
1.1.1 Cel dokumentu	243
1.2 Objaśnienie symboli ostrzegawczych.....	243
1.2.1 Oznaczenie poziomów niebezpieczeństwa	243
1.2.2 Symbole ostrzegawcze.....	243
1.2.3 Budowa ostrzeżeń	244
1.2.4 Ogólne symbole.....	244
 Bezpieczeństwo	245
2.1 Ogólne informacje dotyczące bezpieczeństwa.....	245
2.1.1 Wszystkie sprzęty gospodarstwa domowego	245
 Narzędzia i pomoce techniczne	246
 Naprawy	247
4.1 Wymiana uszczelki drzwiczek	247
4.1.1 Demontaż uszczelki drzwiczek.....	247
4.1.2 Montaż uszczelki drzwiczek.....	247
4.2 Wymiana uchwyty drzwiczek.....	250
4.2.1 Demontaż uchwyty drzwiczek	250
4.2.2 Montaż uchwyty drzwiczek	250
4.3 Wymiana półki.....	251
4.3.1 Demontaż półki	251
4.3.2 Montaż półki	251
4.4 Wymiana podstawki na butelki	252
4.4.1 Demontaż podstawki na butelki.....	252
4.4.2 Montaż podstawki na butelki	252
4.5 Wymiana półki drzwiczek	253
4.5.1 Demontaż półki drzwiczek	253
4.5.2 Montaż półki drzwiczek.....	253
4.6 Wymiana pojemników	254
4.6.1 Demontaż pojemników	254
4.6.2 Montaż pojemników	254
4.7 Wymiana żarówki LED.....	255
4.7.1 Demontaż żarówki LED	255
4.7.2 Montaż żarówki LED	256

i Informacje dotyczące dokumentu

1.1 Ważne informacje

1.1.1 Cel dokumentu

Niniejsze wskazówki naprawcze mają na celu zapewnienie użytkownikowi pomocy w samodzielnej naprawie posiadanych urządzeń w sposób zgodny z obowiązującymi przepisami w sprawie ekoprojektu (stan na 03/2021).

Zawierają one informacje na temat wymiany określonych części zamiennych oraz ostrzeżenia i informacje o zagrożeniach.

W razie pytań należy się skontaktować z naszym działem serwisowym. Odpowiedzialność za szkody ponosimy tylko pod warunkiem prawidłowego stosowania się do wskazówek naprawczych.

1.2 Objasnienie symboli ostrzegawczych

1.2.1 Oznaczenie poziomów niebezpieczeństwa

Poziom ryzyka jest określany przy pomocy symbolu oraz wyrazu. Wyraz określa poziom ryzyka.



Symbol	Znaczenie
 NIEBEZPIECZEŃSTWO	Bezpośrednio zagrażające niebezpieczeństwo, które przy niezachowaniu odpowiednich środków ostrożności może doprowadzić do śmierci lub poważnych obrażeń.
 OSTRZEŻENIE	Prawdopodobieństwo wystąpienia niebezpieczeństwa, które przy niezachowaniu odpowiednich środków ostrożności może doprowadzić do śmierci lub poważnych obrażeń.
 WAŻNE	Prawdopodobieństwo wystąpienia niebezpieczeństwa, które przy niezachowaniu odpowiednich środków ostrożności może doprowadzić do powstania lekkich obrażeń.
UWAGA!	Ostrzeżenie dot. możliwości powstania szkody materialnej.

Tabela 1: Oznaczenie poziomów niebezpieczeństwa

1.2.2 Symbole ostrzegawcze

Symbole ostrzegawcze reprezentują graficznie źródło potencjalnego ryzyka.

W poniższym dokumencie użyto następujących symboli:

Symbole ostrzegawcze	Znaczenie
	Ogólne ostrzeżenie
	Niebezpieczeństwo od napięcia elektrycznego
	Ryzyko wybuchu

i Informacje dotyczące dokumentu







Symbole ostrzegawcze	Znaczenie
	Ryzyko obrażeń (rozcięć)
	Ryzyko zmiążdżenia
	Ryzyko oparzenia
	Silne pole magnetyczne
	Promieniowanie nie-jonizujące

Tabela 2: Symbole ostrzegawcze

1.2.3 Budowa ostrzeżeń

Ostrzeżenia podane w dokumencie mają standardową budowę.

	<p>NIEBEZPIECZEŃSTWO</p> <p>Typ i źródło ryzyka!! Konsekwencje zignorowania.</p> <ul style="list-style-type: none"> ▶ Środki ochronne.
-----------------------------------------------------------------------------------	-------------------------------------------------------------------------------------------------------------------------------------------------------------------------

Kolejne ostrzeżenie wskazuje, jako źródło możliwość porażenia prądem. Wskazano czynności, które mają za zadanie ograniczenie ryzyka.

	<p>NIEBEZPIECZEŃSTWO</p> <p>Ryzyko porażenia prądem, ze względu na elementy będące pod napięciem! Zagrożenie życia poprzez porażenie prądem</p> <ul style="list-style-type: none"> ▶ Odłączyć urządzenie od zasilania sieciowego na 60 sekund przed rozpoczęciem naprawy.
------------------------------------------------------------------------------------	------------------------------------------------------------------------------------------------------------------------------------------------------------------------------------------------------------------------------------------------------------------------------------------------------------

1.2.4 Ogólne symbole

Poniższe symbole są używane w dokumentacji:







Symbol	Znaczenie
	Identyfikacja specjalnej wskazówki (tekst lub grafika)
	Identyfikacja prostej wskazówki (tylko tekst)
	Identyfikacja linku do pliku wideo
	Identyfikacja narzędzi
	Identyfikacja wstępnych warunków
	Identyfikacja warunku (jeżeli)
	Identyfikacja rezultatu
[Start]	Identyfikacja przycisku
[00123456]	Identyfikacja numeru materiału
Status	Identyfikacja wyświetlanego tekstu / komunikatu (na wyświetlaczu)

Tabela 3: Ogólne symbole

2.1 Ogólne informacje dotyczące bezpieczeństwa

2.1.1 Wszystkie sprzęty gospodarstwa domowego

Ryzyko porażenia prądem elektrycznym wskutek kontaktu z elementami znajdującymi się pod napięciem!

- Błędna naprawa części elektrycznych może spowodować porażenie prądem elektrycznym!
- Co najmniej 60 sekund przed przystąpieniem do pracy odłączyć urządzenie od sieci elektrycznej.
- Po naprawie należy przeprowadzić test bezpieczeństwa zgodny z przepisami normy VDE 0701 (Niemcy) lub odpowiednimi przepisami obowiązującymi w kraju użytkowania.

Ryzyko zranienia o ostre krawędzie!

- Używać rękawic ochronnych.

Ryzyko zmiążdżenia podczas naprawy, obsługi lub diagnozy, ze względu na ciężkie i ruchome elementy

- Stosować obuwie ochronne.
- Zabezpieczyć ciężkie elementy przed upadkiem.
- Nie dotykać ruchomych elementów podczas pracy urządzenia.



Zagrożenie dla bezpieczeństwa użytkownika i działania urządzenia!

- Używać tylko oryginalnych części zamiennych.

Ryzyko uszkodzenia komponentów wrażliwych na wyładowania elektrostatyczne (ESD)!

- Nie dotykać modułów, włącznie ze złączami i ścieżkami przewodzącymi.

Narzędzia i pomoce techniczne

Przeznaczenie	Detale	Zdjęcia
Tkanina ochronna [00342013]	60 cm x 50 cm	
Klucze gniazdowe sześciokątne [00340819]	2 mm, 2,5 mm, 3 mm, 4 mm, 5 mm, 6 mm, 8 mm	

4.1 Wymiana uszczelki drzwiczek

Warunek:

- ✔ Drzwiczki są otwarte.

4.1.1 Demontaż uszczelki drzwiczek

1. Poluzować uszczelkę drzwiczek w rowku w prawym i lewym narożniku.

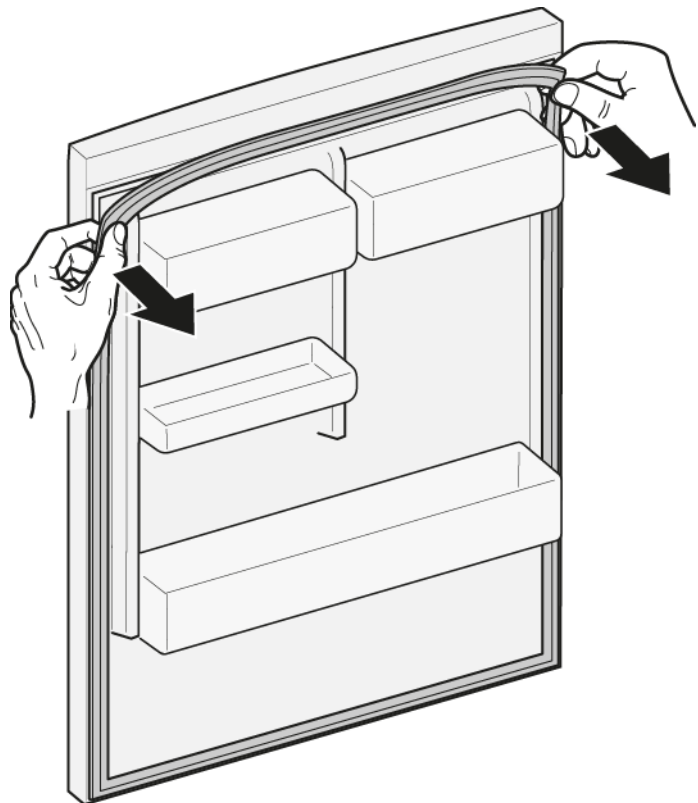

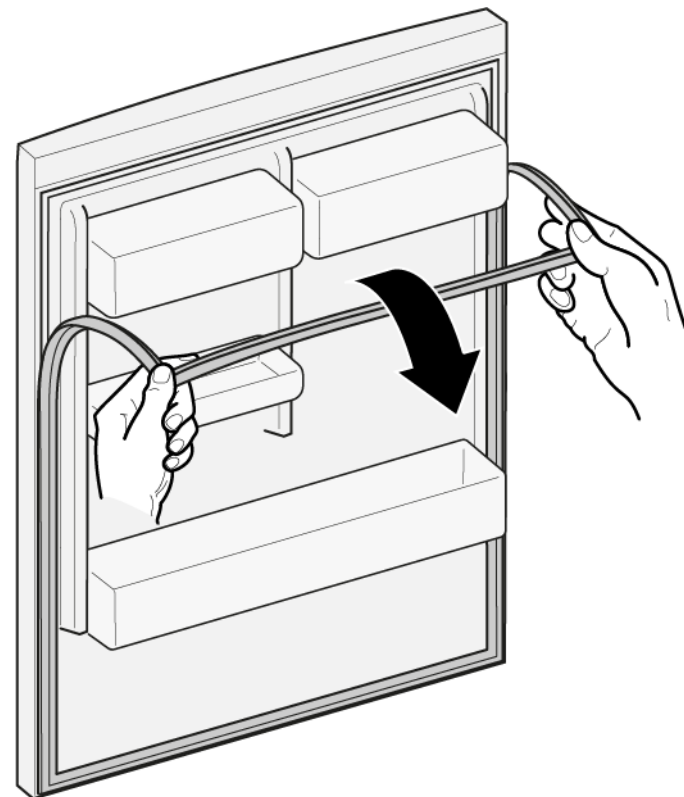

2. Wyciągnąć uszczelkę drzwiczek z rowka.



- ➡ Uszczelka drzwiczek została zdemontowana.

4.1.2 Montaż uszczelki drzwiczek

	Grubość nowej uszczelki drzwiczek może się nieco różnić od grubości starej uszczelki drzwiczek. Nie ma to wpływu na jakość zamykania drzwiczek i i działanie urządzenia.
	Jeżeli urządzenie posiada regulowane zawiasy lub elementy mocujące zawiasów, można przy ich użyciu regulować sposób zamykania drzwiczek.
	Małe boczne otwory w uszczelce drzwiczek są elementami funkcyjnymi (zapewniają wentylację). Nie stanowią one wad produkcyjnych.

1. Skontrolować rowek uszczelki pod kątem uszkodzeń.

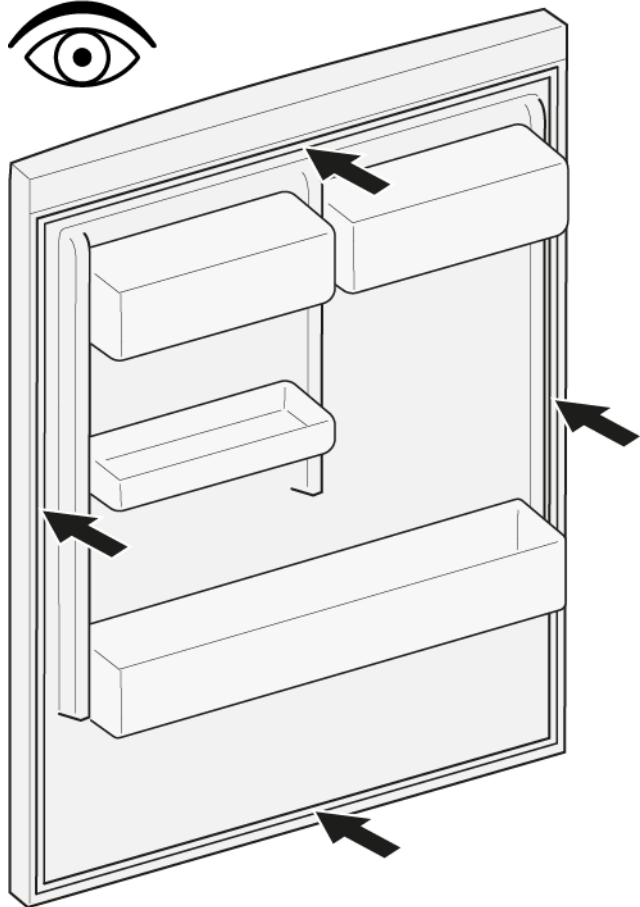

4. Wcisnąć narożniki uszczelki do rowka u dołu i u góry.

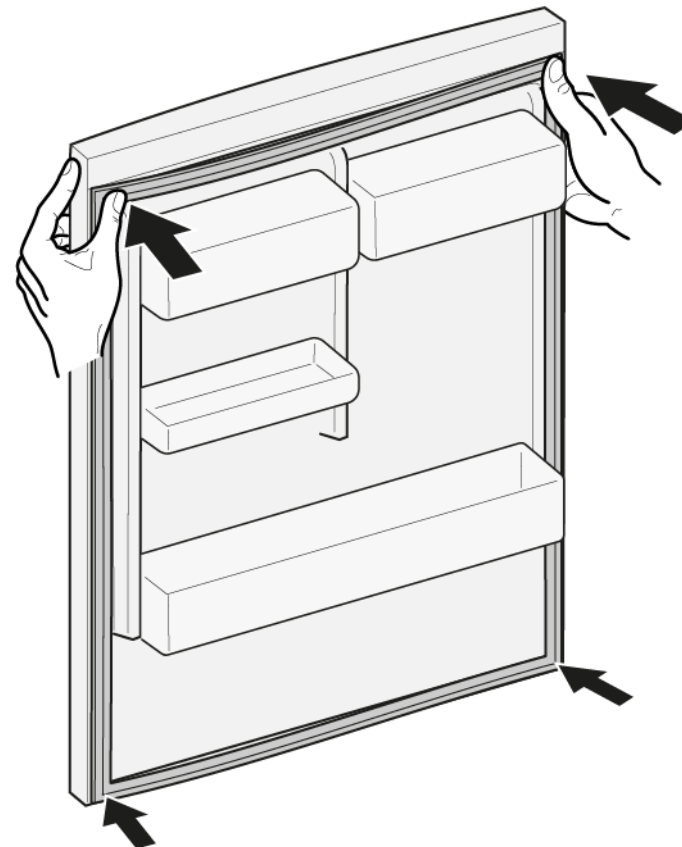

2.  Jeżeli rowek uszczelki jest uszkodzony.
- Skontaktować się z serwisem.

3.

	Lekka deformacja uszczelki drzwiczek jest normalna i nie wpływa na jej funkcję. Zaleca się wyprostowanie uszczelki drzwiczek przed jej zamocowaniem w urządzeniu.
-------------------------------------------------------------------------------------	-------------------------------------------------------------------------------------------------------------------------------------------------------------------

Ogrzać uszczelkę drzwiczek suszarką do włosów lub nadać jej żądany kształt rękami.

5. Krok po kroku wcisnąć uszczelkę do rowka na całym obwodzie.

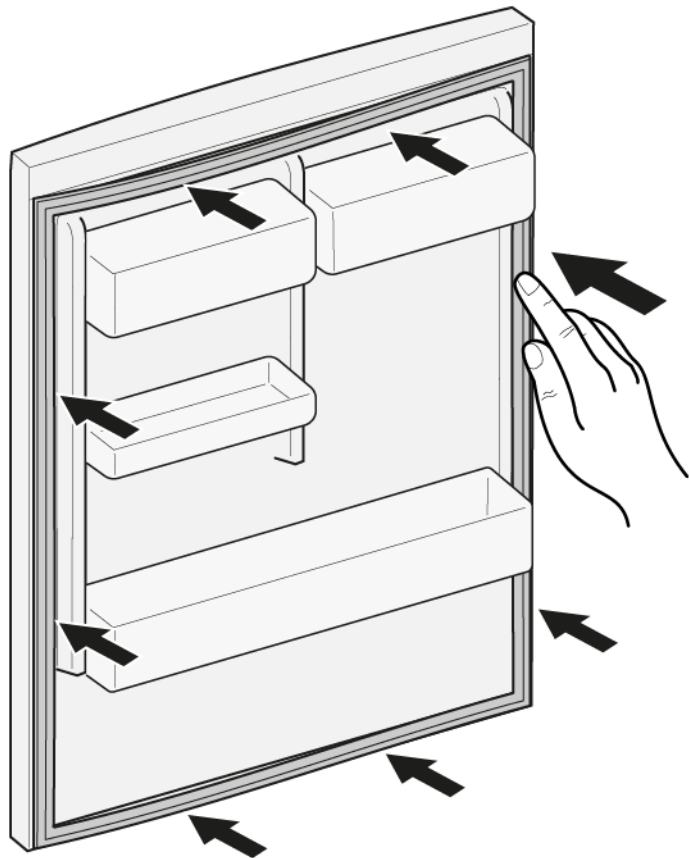



 Uszczelka drzwiczek została zamontowana.

4.2 Wymiana uchwyty drzwiczek

Pomoce specjalne

 Klucze gniazdowe sześciokątne 2 mm, 2,5 mm, 3 mm, 4 mm, 5 mm, 6 mm, 8 mm [00340819]

Warunek:

-  Urządzenie jest odłączone od źródła zasilania energią elektryczną.
-  Drzwiczki są otwarte.

4.2.1 Demontaż uchwyty drzwiczek

1. Wykręcić dwie śruby (1).
2. Zdjąć uchwyt drzwiczek (2).

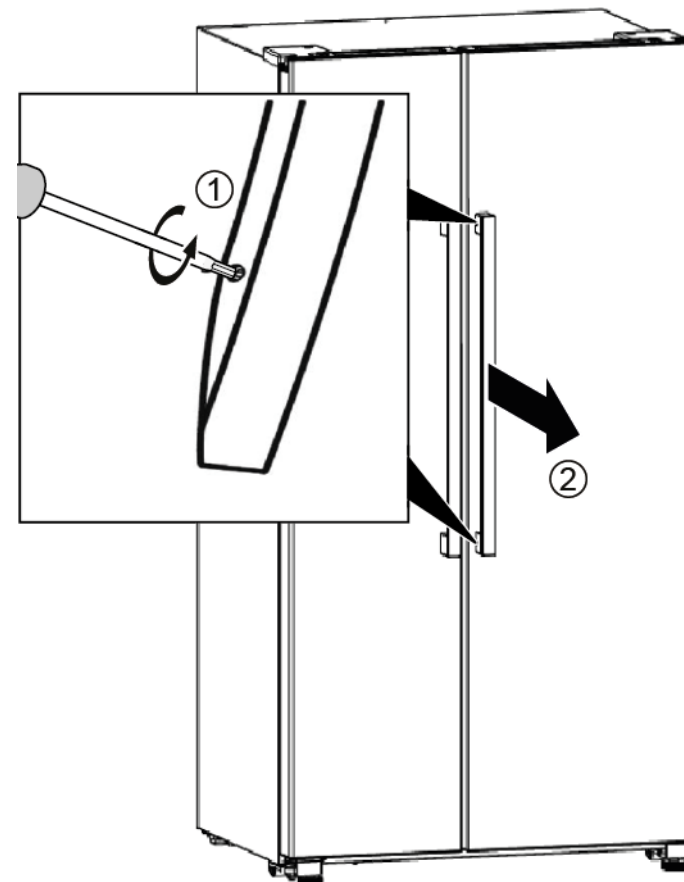

 Uchwyt drzwiczek został zdemontowany.

2. Zdemontować uchwyt drugich drzwiczek w taki sam sposób.

4.2.2 Montaż uchwyty drzwiczek

- ▶ Montaż w odwrotnej kolejności.

4.3 Wymiana półki

Warunek:

- ✔ Drzwiczki są otwarte.

4.3.1 Demontaż półki

- ▶ Wyciągnąć półkę.

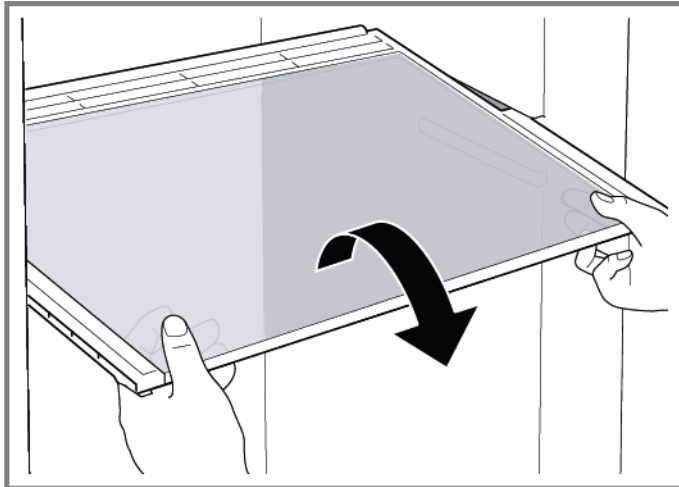

- ➡ Półka jest wyjęta.

4.3.2 Montaż półki

- ▶ Montaż w odwrotnej kolejności.

4.4 Wymiana podstawki na butelki

Warunek:

- ✔ Drzwiczki są otwarte.

4.4.1 Demontaż podstawki na butelki

- ▶ Wyciągnąć podstawkę na butelki.

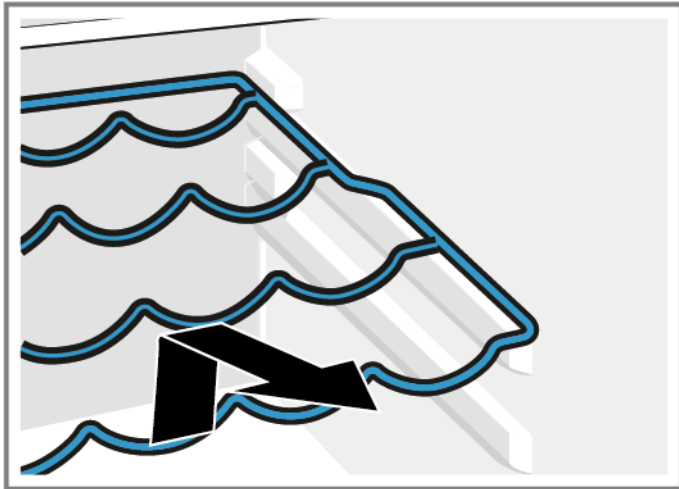

- ➡ Podstawka na butelki jest wyjęta.

4.4.2 Montaż podstawki na butelki

- ▶ Montaż w odwrotnej kolejności.

4.5 Wymiana półki drzwiczek

Warunek:

- ✔ Drzwiczki są otwarte.

4.5.1 Demontaż półki drzwiczek

- ▶ Podnieść półkę drzwiczek do góry.

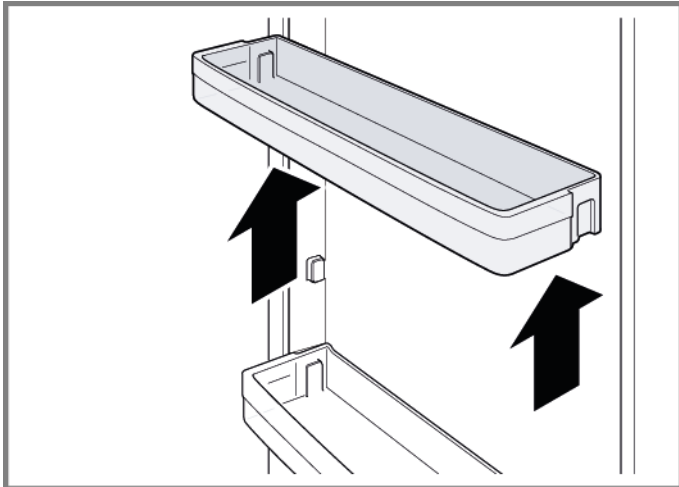

- ➡ Półka drzwiczek została zdemontowana.

4.5.2 Montaż półki drzwiczek

- ▶ Montaż w odwrotnej kolejności.

4.6 Wymiana pojemników

Warunek:

- ✔ Drzwiczki są otwarte.

4.6.1 Demontaż pojemników

- ▶ Wyciągnąć pojemnik do końca, podnieść go w celu odłączenia od uchwyty i wyjąć.

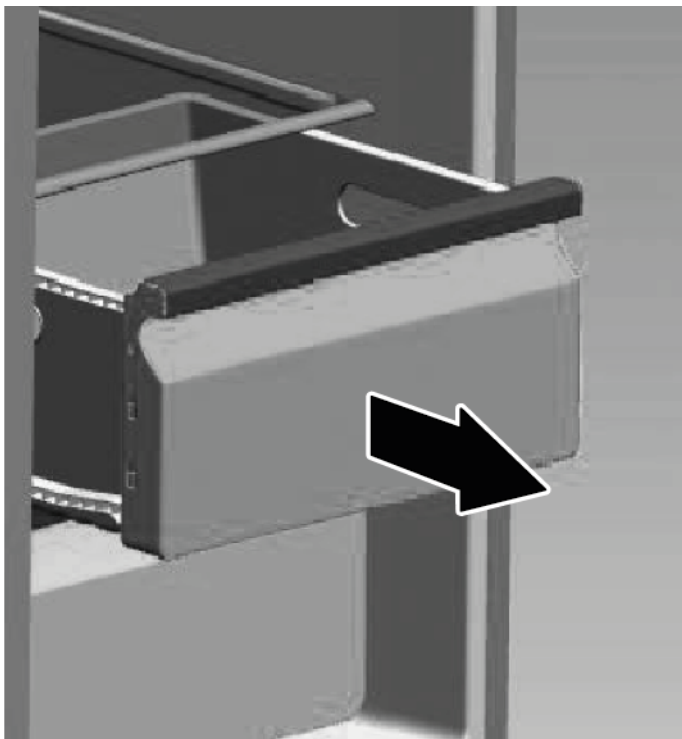



- ➡ Pojemnik został wyjęty.

4.6.2 Montaż pojemników

- ▶ Montaż w odwrotnej kolejności.

4.7 Wymiana żarówki LED

 Urządzenie posiada bezobsługowe oświetlenie LED. Tego rodzaju elementy oświetleniowe mogą być naprawiane wyłącznie przez serwis lub autoryzowanych techników!

 **NIEBEZPIECZEŃSTWO**
Ryzyko porażenia prądem elektrycznym wskutek kontaktu z elementami znajdującymi się pod napięciem!
Niebezpieczeństwo utraty życia wskutek porażenia prądem elektrycznym w przypadku nieprawidłowej naprawy

- ▶ Części elektryczne powinny być naprawiane przez wykwalifikowanych elektryków.
- ▶ Po naprawie należy przeprowadzić test bezpieczeństwa zgodny z przepisami normy VDE 0701 (Niemcy) lub odpowiednimi przepisami obowiązującymi w kraju użytkowania.

 **WAŻNE**
Ostre krawędzie!
Rany cięte

- ▶ Zawsze używaj rękawic ochronnych.

Warunek:

- ✔ Urządzenie jest odłączone od źródła zasilania energią elektryczną.
- ✔ Drzwiczki są otwarte.
- ✔ Górna półka jest wyjęta.

4.7.1 Demontaż żarówki LED

1. Chwycić pokrywę żarówki LED obiema rękami i pociągnąć na dół



-  Pokrywa żarówki LED jest wymontowana.



2. Pociągnąć i wyjąć żarówkę LED



3. Odłączyć zacisk



➡ Żarówka LED jest wymontowana.

4.7.2 Montaż żarówki LED

- ▶ Montaż w odwrotnej kolejności.

Dicas de resolução - Combinado de refrigeração/congelação

 Sobre este documento	258
1.1 Informação importante	258
1.1.1 Finalidade.....	258
1.2 Explicação dos símbolos.....	258
1.2.1 Níveis de perigo.....	258
1.2.2 Símbolos de perigo	258
1.2.3 Estrutura dos avisos.....	259
1.2.4 Símbolos gerais	259
 Segurança	260
2.1 Instruções gerais de segurança.....	260
2.1.1 Todos os eletrodomésticos	260
 Ferramentas e auxiliares	261
 Reparação	262
4.1 Substituir a junta da porta	262
4.1.1 Remover a junta da porta	262
4.1.2 Instalar a junta da porta.....	262
4.2 Substituir o puxador da porta	265
4.2.1 Remover o puxador da porta	265
4.2.2 Instalar o puxador da porta	265
4.3 Substituir a prateleira	266
4.3.1 Remover a prateleira.....	266
4.3.2 Instalar a prateleira	266
4.4 Substituir o suporte para garrafas.....	267
4.4.1 Remover o suporte para garrafas.....	267
4.4.2 Instalar o suporte para garrafas	267
4.5 Substituir a prateleira da porta.....	268
4.5.1 Remover a prateleira da porta.....	268
4.5.2 Instalar a prateleira da porta	268
4.6 Substituir recipientes	269
4.6.1 Remover recipientes	269
4.6.2 Instalar recipientes	269
4.7 Substituir a lâmpada LED.....	270
4.7.1 Remover a lâmpada LED	270
4.7.2 Instalar a lâmpada LED	271

i Sobre este documento

1.1 Informação importante

1.1.1 Finalidade

Estas dicas de reparação auxiliam o consumidor na reparação de aparelhos por ele próprio de acordo com o regulamento de "Eco-design" aplicável (a partir de 03/2021).

Estas contêm informações sobre como substituir peças sobressalentes definidas, incluindo avisos e riscos.

Em caso de dúvidas, entre em contacto com o nosso serviço de apoio ao cliente. Apenas nos responsabilizaremos por danos se as dicas de reparação tiverem sido devidamente seguidas.

1.2 Explicação dos símbolos

1.2.1 Níveis de perigo

Os níveis de aviso são compostos por um símbolo e uma palavra sinal. A palavra-sinal indica a gravidade do perigo.









Nível de aviso	Significado
	A não observância da mensagem de aviso resulta em morte ou ferimentos graves.
	A não observância da mensagem de aviso pode resultar em morte ou ferimentos graves.
	A não observância da mensagem de aviso pode resultar em ferimentos ligeiros.
	A não observância da mensagem de aviso pode resultar em danos materiais.

Tabela 1: Níveis de perigo

1.2.2 Símbolos de perigo

Os símbolos de perigo são representações simbólicas que dão uma indicação do tipo de perigo.

Neste documento são utilizados os seguintes símbolos de perigo:

Símbolo de perigo	Significado
	Mensagem geral de aviso
	Perigo de tensão elétrica
	Risco de explosão
	Perigo de cortes

i Sobre este documento





Símbolo de perigo	Significado
	Perigo de esmagamento
	Perigo de superfícies quentes
	Perigo de campo eletromagnético intenso
	Perigo de radiação não-ionizante

Tabela 2: Símbolos de perigo

1.2.3 Estrutura dos avisos

Os avisos neste documento possuem um aspeto normalizado e uma estrutura normalizada.

	<div style="background-color: red; color: white; padding: 2px; text-align: center;">⚠ PERIGO</div> <p>Tipo e origem do perigo! Possíveis consequência de ignorar o perigo / aviso.</p> <ul style="list-style-type: none"> ▶ Medidas e proibições para prevenir o perigo.
----------------------------------------------------------------------------------	-----------------------------------------------------------------------------------------------------------------------------------------------------------------------------------------------------------------------------------------------------------------------------------------------------------

O seguinte exemplo mostra um aviso que adverte contra choques elétricos devido a partes sob tensão. A medida para evitar o perigo é mencionada.

	<div style="background-color: red; color: white; padding: 2px; text-align: center;">⚠ PERIGO</div> <p>Risco de choque elétrico devido a partes sob tensão! Morte por eletrocussão</p> <ul style="list-style-type: none"> ▶ Desligue os aparelhos da alimentação elétrica pelo menos 60 segundos antes de iniciar as reparações.
------------------------------------------------------------------------------------	------------------------------------------------------------------------------------------------------------------------------------------------------------------------------------------------------------------------------------------------------------------------------------------------------------------------------------------------------------------

1.2.4 Símbolos gerais

Neste documento são utilizados os seguintes símbolos gerais:







Símbolo ger.	Significado
	Identificação de uma dica especial (texto e/ou ilustração)
	Identificação de uma dica simples (apenas texto)
	Identificação de uma ligação para um tutorial em vídeo
	Identificação das ferramentas necessárias
	Identificação das condições prévias necessárias
	Identificação de uma condição (se ..., então ...)
	Identificação de um resultado
Iniciar	Identificação de uma tecla ou botão
[00123456]	Identificação de um número de material
Estado	Identificação de um texto exibido / janela (no visor do aparelho)

Tabela 3: Símbolos gerais

2.1 Instruções gerais de segurança

2.1.1 Todos os eletrodomésticos

Risco de choque elétrico devido a partes sob tensão!

- Erros por reparações envolvendo componentes elétricos podem provocar choques elétricos!
- Desligue o aparelho da rede elétrica pelo menos 60 segundos antes de iniciar o trabalho.
- Após a reparação, solicite a realização de um teste de segurança de acordo com VDE 0701 ou os regulamentos específicos do país.

Risco de ferimentos causados por arestas vivas!

- Use luvas de proteção.

Risco de esmagamento durante trabalhos de reparação, manutenção, resolução de problemas e serviço devido a componentes pesados e móveis

- Use calçado de proteção.
- Proteja os componentes pesados contra quedas.
- Não introduzir partes do corpo em componentes móveis.



Risco para a segurança/funcionamento do aparelho!

- Utilize apenas peças sobressalentes originais.

Risco de danos em componentes electrostaticamente sensíveis (ESDs)!

- Não toque nos módulos, incluindo ligações e percursos condutores.

Ferramentas e auxiliares

Designação	Detalhes	Imagens
Pano protetor [00342013]	60 cm x 50 cm	
Chaves de caixa sextavadas [00340819]	2 mm, 2.5 mm, 3 mm, 4 mm, 5 mm, 6 mm, 8 mm	

4.1 Substituir a junta da porta

Pré-requisito:

- ✔ A porta está aberta.

4.1.1 Remover a junta da porta

1. Solte a junta da porta da ranhura nos cantos direito e esquerdo.

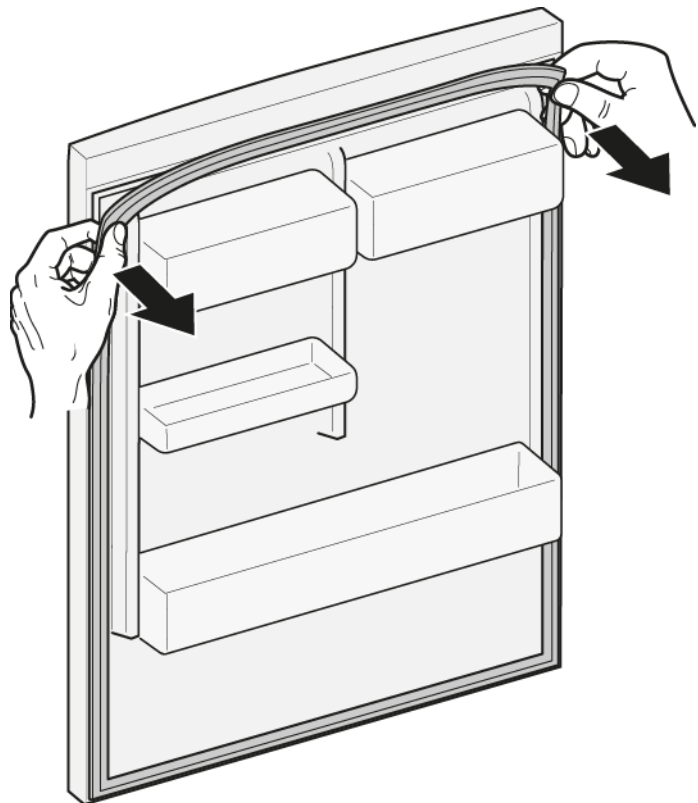

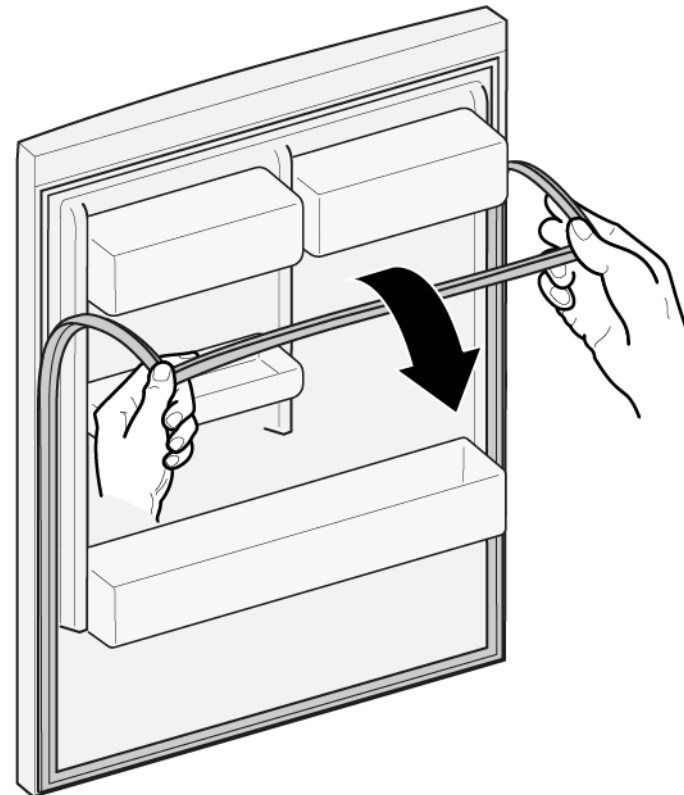

2. Puxe a junta da porta para fora da ranhura.



- ➡ A junta da porta está removida.

4.1.2 Instalar a junta da porta

	A espessura da nova junta da porta pode divergir ligeiramente da da junta antiga da porta. Isto não afetará o comportamento de fecho nem o funcionamento a longo termo.
	Se o seu aparelho dispor de dobradiças ou fixações de dobradiça ajustáveis, poderá otimizar o comportamento de fecho subsequentemente.
	Os pequenos orifícios laterais na junta da porta são funcionais (necessários à ventilação). Não se trata de falhas de produção.

Reparação

1. Verifique se a ranhura para a junta apresenta danos.

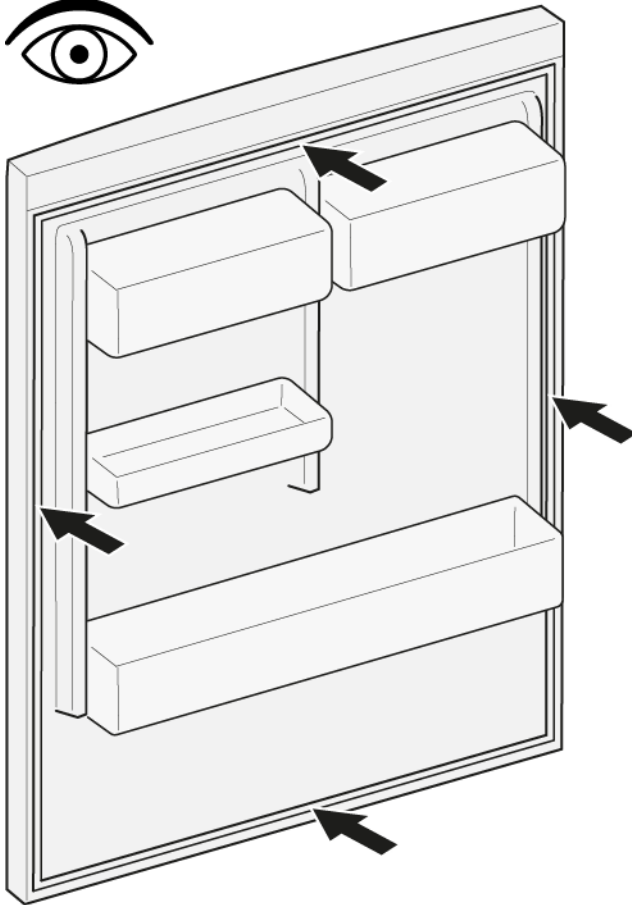

4. Empurre os cantos da junta em cima e em baixo para ranhura.

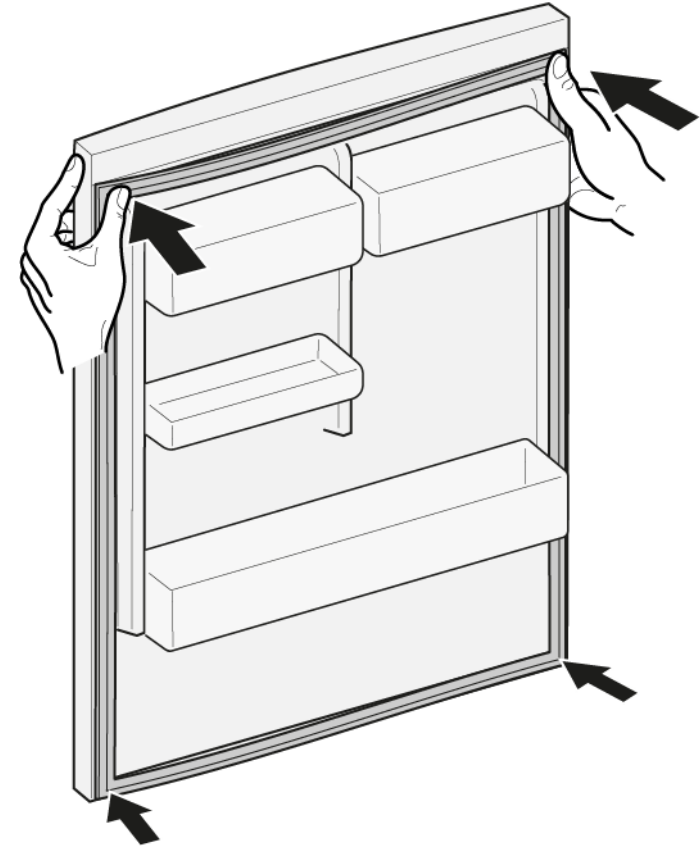

2.  Se a ranhura para a junta estiver danificada,
- contacte o serviço de apoio ao consumidor.

3.  Uma deformação ligeira da junta da porta é normal e não afeta o seu funcionamento. Recomenda-se que a junta da porta seja endireitada antes de ser inserida no aparelho.

Aqueça a junta da porta com a um secador de cabelo ou água quente e mude a sua forma manualmente.

Reparação

5. Pressione a junta inteira gradualmente para dentro da ranhura.

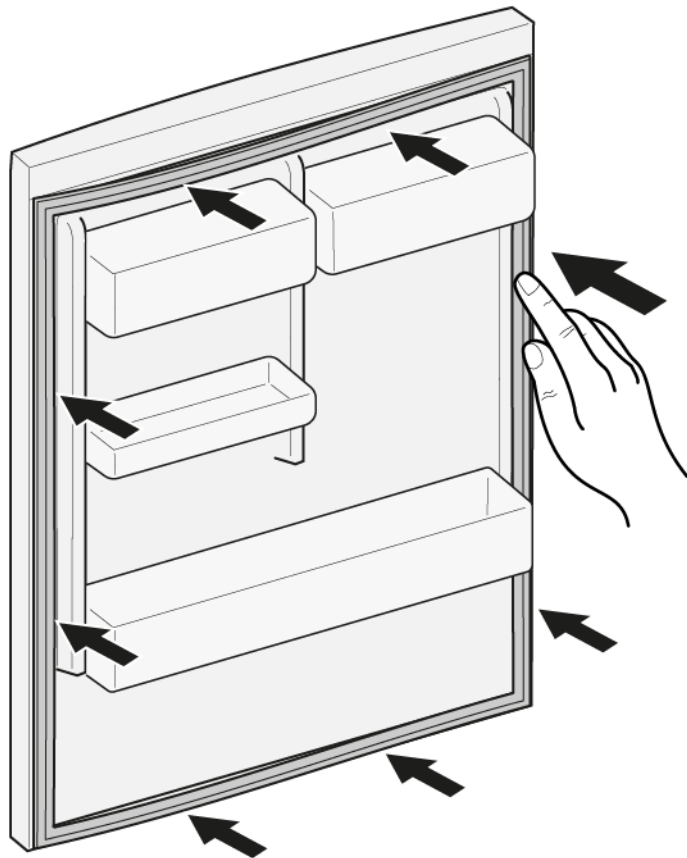



-  A junta da porta está instalada.

4.2 Substituir o puxador da porta

Ferramentas necessárias:

 Chaves de caixa sextavadas 2 mm, 2.5 mm, 3 mm, 4 mm, 5 mm, 6 mm, 8 mm [00340819]

Pré-requisito:

-  O aparelho está desligado da alimentação elétrica.
-  A porta está aberta.

4.2.1 Remover o puxador da porta

1. 1. Desaperte dois parafusos (1).
2. 2. Remova o puxador da porta (2).

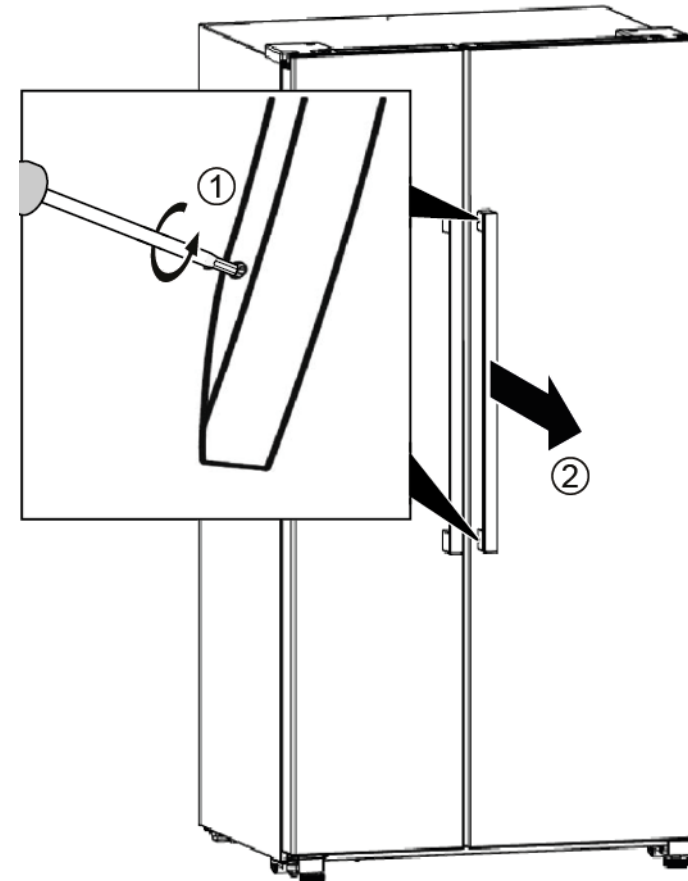

 O puxador da porta está removido.

2. Remova o segundo puxador da porta da mesma forma.

4.2.2 Instalar o puxador da porta

- ▶ Instale pela ordem inversa.

4.3 Substituir a prateleira

Pré-requisito:

- ✔ A porta está aberta.

4.3.1 Remover a prateleira

- ▶ Puxe a prateleira para fora.

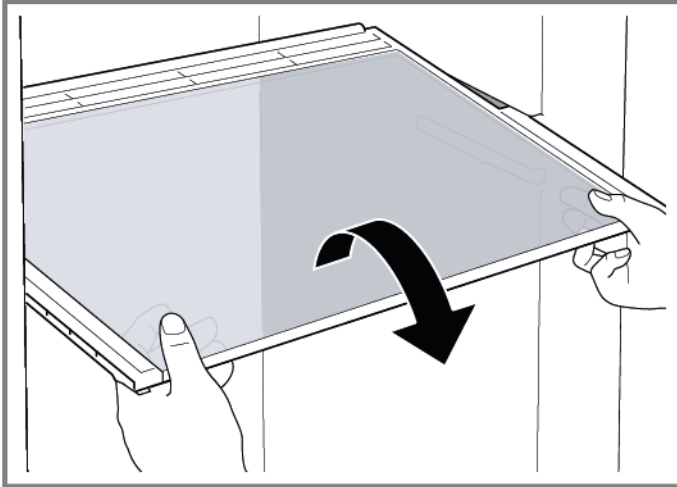

➡ A prateleira está removida.

4.3.2 Instalar a prateleira

- ▶ Instale pela ordem inversa.

4.4 Substituir o suporte para garrafas

Pré-requisito:

- ✔ A porta está aberta.

4.4.1 Remover o suporte para garrafas

- ▶ Puxe para fora o suporte para garrafas.

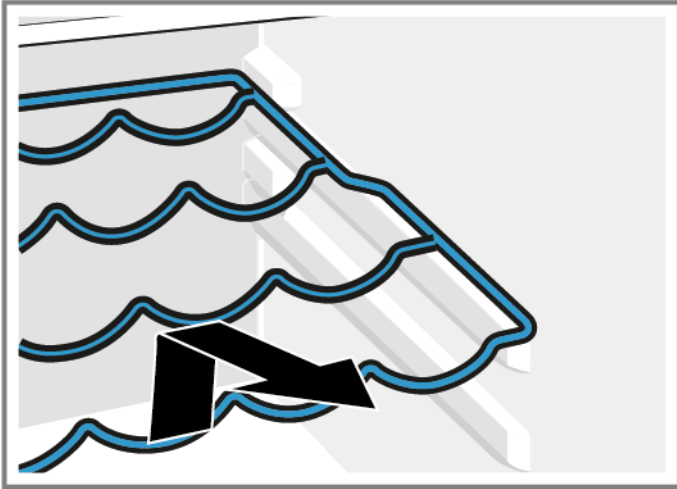

- ➡ O suporte para garrafas está removido.

4.4.2 Instalar o suporte para garrafas

- ▶ Instale pela ordem inversa.

4.5 Substituir a prateleira da porta

Pré-requisito:

- ✔ A porta está aberta.

4.5.1 Remover a prateleira da porta

- ▶ Levante a prateleira da porta.

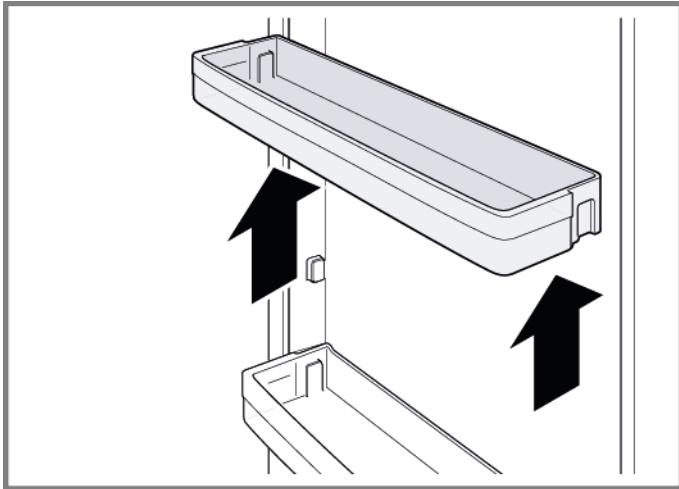

➡ A prateleira da porta está removida.

4.5.2 Instalar a prateleira da porta

- ▶ Instale pela ordem inversa.

4.6 Substituir recipientes

Pré-requisito:

- ✔ A porta está aberta.

4.6.1 Remover recipientes

- ▶ Puxe o recipiente para fora inteiramente, levante-o para o desprender do suporte e retire-o.

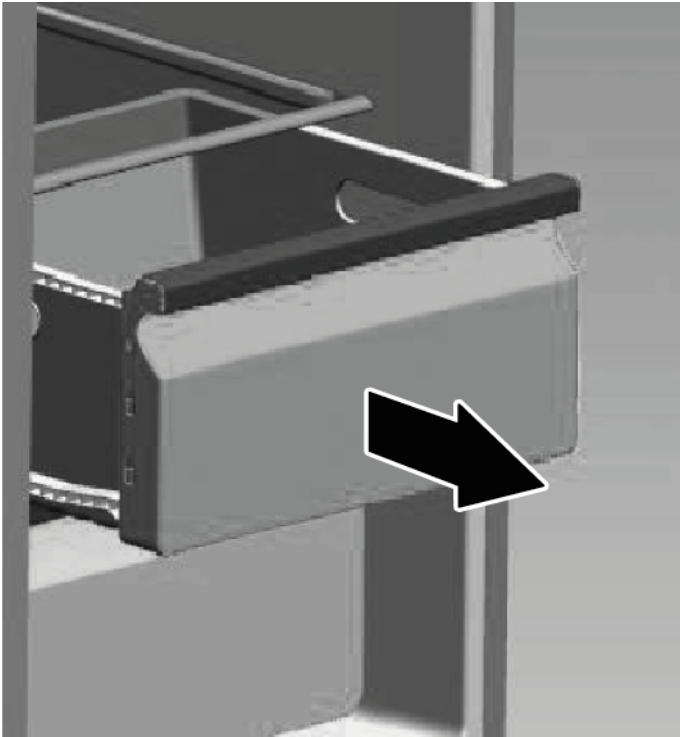

- ➡ O recipiente está removido.

4.6.2 Instalar recipientes

- ▶ Instale pela ordem inversa.

4.7 Substituir a lâmpada LED



O seu aparelho dispõe de uma iluminação LED isenta de manutenção. Estas iluminações só podem ser reparadas pelo serviço de apoio ao consumidor ou por técnicos autorizados!



⚠️ PERIGO

Risco de choque elétrico devido a partes sob tensão!

Risco de vida devido a choque elétrico em caso de reparação inadequada

- ▶ As partes elétricas devem ser reparadas por um electricista qualificado.
- ▶ Após a reparação, solicite a realização de um teste de segurança de acordo com VDE 0701 ou os regulamentos específicos do país.



⚠️ CUIDADO

Arestas vivas!

Lesões por corte

- ▶ Use luvas de proteção.

Pré-requisito:

- ✔ O aparelho está desligado da alimentação elétrica.
- ✔ A porta está aberta.
- ✔ A prateleira superior está removida.

4.7.1 Remover a lâmpada LED

1. Segure a tampa da lâmpada LED com as duas mãos e puxe para baixo



- ➡ A tampa da lâmpada LED está removida.



2. Puxe e retire a lâmpada LED



3. Desconecte o terminal



- ➡ A lâmpada LED está removida.

4.7.2 Instalar a lâmpada LED

- ▶ Instale pela ordem inversa.

Indicii pentru reparații - Combinație aparat de răcire/congelare

 Referitor la acest document	273
1.1 Informații importante	273
1.1.1 Aplicabilitatea	273
1.2 Explicația simbolurilor	273
1.2.1 Nivelurile de pericol.....	273
1.2.2 Simbolurile de pericol.....	273
1.2.3 Structura avertismentelor.....	274
1.2.4 Simbolurile generale	274
 Siguranța	275
2.1 Instrucțiuni generale de siguranță	275
2.1.1 Toate aparatele electrocasnice	275
 Instrumente și materiale utile	276
 Repararea	277
4.1 Înlocuirea garniturii ușii	277
4.1.1 Demontarea garniturii ușii.....	277
4.1.2 Montarea garniturii ușii	277
4.2 Înlocuirea mânerului ușii	280
4.2.1 Demontarea mânerului ușii	280
4.2.2 Montarea mânerului ușii	280
4.3 Repoziționarea raftului	281
4.3.1 Demontarea raftului.....	281
4.3.2 Montarea raftului	281
4.4 Repoziționarea suportului pentru sticle.....	282
4.4.1 Demontarea suportului pentru sticle	282
4.4.2 Montarea suportului pentru sticle	282
4.5 Repoziționarea raftului pentru ușă	283
4.5.1 Demontarea raftului pentru ușă.....	283
4.5.2 Montarea raftului pentru ușă	283
4.6 Repoziționarea containerelor.....	284
4.6.1 Demontarea containerelor	284
4.6.2 Montarea containerelor.....	284
4.7 Înlocuirea lămpii LED	285
4.7.1 Demontarea lămpii LED	285
4.7.2 Montarea lămpii LED.....	286

i Referitor la acest document

1.1 Informații importante

1.1.1 Aplicabilitatea

Aceste instrucțiuni de reparare îl ajută pe client să își repare singur aparatele, în conformitate cu normele de proiectare ecologică aplicabile (începând cu 03/2021).





Acestea conțin informații privind modul de înlocuire a pieselor de schimb specifice, inclusiv avertismente și pericole.

Dacă aveți întrebări, vă rugăm să luați legătura cu serviciul relații clienți. Ne asumăm răspunderea pentru daune numai dacă instrucțiunile de reparare au fost respectate pe deplin.

1.2 Explicația simbolurilor

1.2.1 Nivelurile de pericol

Nivelurile de alertă sunt reprezentate printr-un simbol și un cuvânt de avertizare. Cuvântul de avertizare indică gravitatea pericolului.





Nivelul de alertă	Semnificație
 PERICOL	Nerespectarea mesajului de avertizare va provoca accidente grave sau decesul.
 AVERTISMENT	Nerespectarea mesajului de avertizare ar putea provoca accidente grave sau decesul.
 ATENȚIONARE	Nerespectarea mesajului de avertizare ar putea provoca accidente ușoare.
 ATENȚIE!	Nerespectarea mesajului de avertizare ar putea provoca daune asupra proprietății.

Tabel 1: Nivelurile de pericol



1.2.2 Simbolurile de pericol

Simbolurile de pericol sunt reprezentări simbolice care indică tipul de pericol.

În acest document sunt utilizate simbolurile de pericol de mai jos:

Simbol de pericol	Semnificație
	Mesaj de avertizare general
	Pericol din cauza tensiunii electrice
	Pericol de explozie
	Pericol de tăiere
	Pericol de zdrobire



Referitor la acest document

Simbol de pericol	Semnificație
	Pericol din cauza suprafețelor fierbinți
	Pericol din cauza câmpului magnetic puternic
	Pericol din cauza radiației neionizante

Tabel 2: Simbolurile de pericol

1.2.3 Structura avertismentelor

Avertismentele din acest document au un aspect și o structură standard.



	<div style="background-color: red; color: white; padding: 2px; text-align: center;"> PERICOL</div> <p>Tipul și sursa pericolului! Consecințele posibile ale ignorării pericolului/avertismentului.</p> <ul style="list-style-type: none"> ▶ Măsuri și interdicții pentru prevenirea pericolului.
----------------------------------------------------------------------------------	--------------------------------------------------------------------------------------------------------------------------------------------------------------------------------------------------------------------------------------------------------------------------------------------------------------------------------------------------------------------------------------------------------------------





Exemplul următor prezintă un avertisment privind electrocutarea din cauza pieselor sub tensiune. Se menționează măsura necesară pentru a evita pericolul.

	<div style="background-color: red; color: white; padding: 2px; text-align: center;"> PERICOL</div> <p>Pericol de electrocutare din cauza pieselor sub tensiune! Deces prin electrocutare</p> <ul style="list-style-type: none"> ▶ Deconectați aparatele de la sursa de alimentare cu tensiune cu cel puțin 60 de secunde înainte de a începe reparațiile.
-----------------------------------------------------------------------------------	-----------------------------------------------------------------------------------------------------------------------------------------------------------------------------------------------------------------------------------------------------------------------------------------------------------------------------------------------------------------------------------------------------------------------------------------------------------------------------

1.2.4 Simbolurile generale

În acest document sunt utilizate simbolurile generale de mai jos:

Simbol general	Semnificație
	Identificarea unei recomandări speciale (text și/sau grafică)
	Identificarea unei recomandări simple (numai text)

Simbol general	Semnificație
	Identificarea unui link spre un videoclip instructiv
	Identificarea sculelor necesare
	Identificarea condițiilor preliminare necesare
	Identificarea unei stări (dacă..., apoi...)
	Identificarea unui rezultat
[Pornire]	Identificarea unei taste sau a unui buton
[00123456]	Identificarea unui număr de serie
Stare	Identificarea unui text/unei ferestre afișate (pe ecranul aparatului)

Tabel 3: Simbolurile generale

2.1 Instrucțiuni generale de siguranță

2.1.1 Toate aparatele electrocasnice

Pericol de electrocutare din cauza pieselor sub tensiune!

- Erorile care au loc în timpul reparațiilor efectuate la componentele electrice pot să ducă la electrocutări!
- Deconectați aparatul de la sursa de alimentare cu tensiune cu cel puțin 60 de secunde înainte de a începe lucrările.
- După reparație, este obligatorie efectuarea unei verificări de siguranță conform cu VDE 0701 sau cu reglementările naționale respective.

Pericol de rănire din cauza muchiilor ascuțite!

- Purtați mănuși de protecție.

Pericol de zdrobire în timpul lucrărilor de reparație, întreținere, depanare și service, din cauza componentelor grele și mobile

- Purtați încălțăminte de protecție.
- Fixați componentele grele împotriva căderii.
- Nu vă sprijiniți cu părți ale corpului de componentele mobile.



Pericol pentru siguranța/funcționarea aparatului!

- Utilizați numai piese de schimb originale.

Pericol de deteriorare a componentelor sensibile la electricitatea statică (ESD)!

- Nu atingeți modulele, inclusiv conexiunile și căile conductorilor.

Instrumente și materiale utile

Desemnare	Detalii	Imagini
Material textil de protecție [00342013]	60 cm x 50 cm	
Chei cu locaș hexagonal [00340819]	2 mm, 2,5 mm, 3 mm, 4 mm, 5 mm, 6 mm, 8 mm	

4.1 Înlocuirea garniturii ușii

Cerință:

- ✔ Ușa este deschisă.

4.1.1 Demontarea garniturii ușii

1. Îndepărtați garnitura ușii din canelura colțurilor din dreapta și stânga.

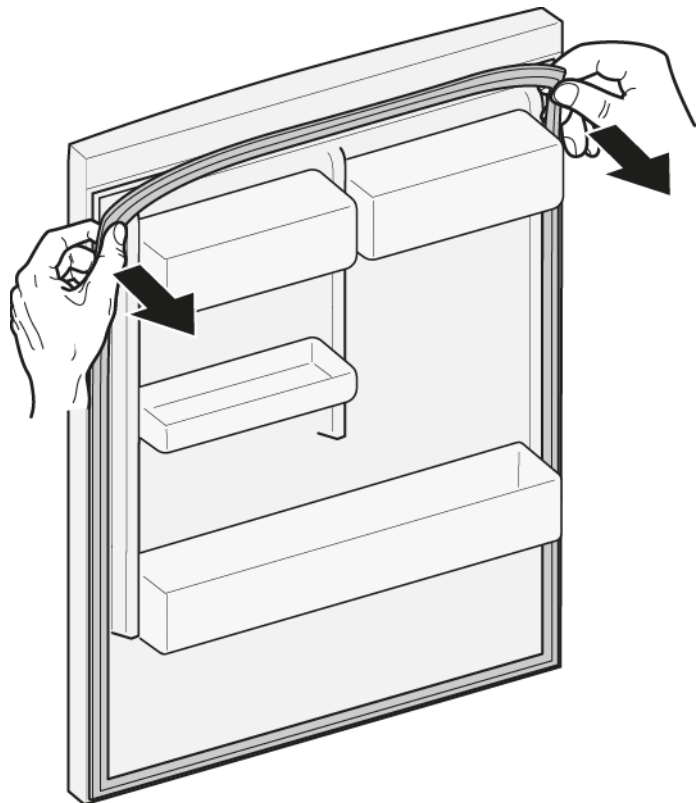

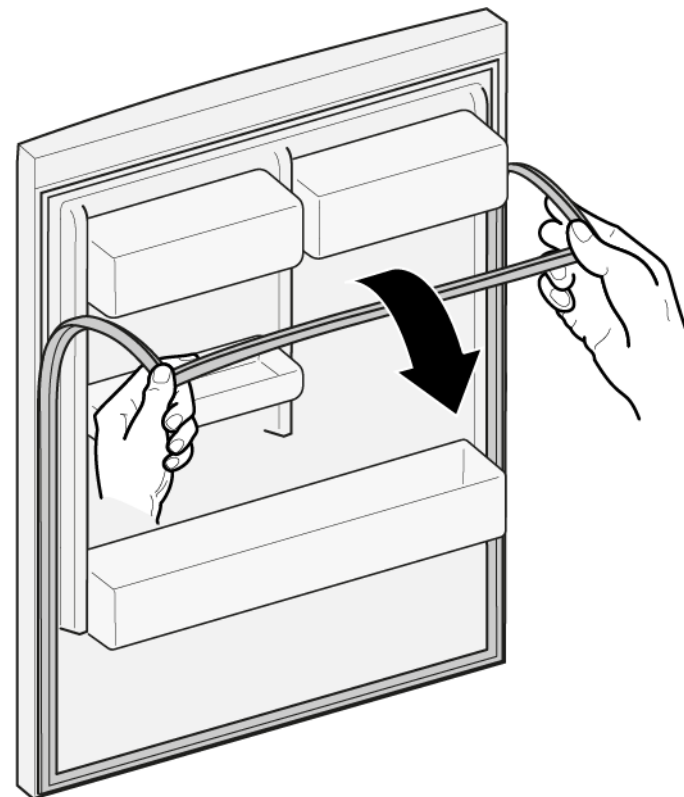

2. Demontați garnitura ușii din canelură.



- ➡ Garnitura ușii este demontată.

4.1.2 Montarea garniturii ușii

	Grosimea garniturii noi a ușii poate fi ușor diferită față de grosimea garniturii vechi a ușii. Acest lucru nu va afecta comportamentul de închidere și funcționarea pe termen lung.
	Dacă aparatul dumneavoastră are balamale reglabile sau accesorii pentru balamale, puteți optimiza comportamentul de închidere în consecință.
	Orificiile de mici dimensiuni practicate în garnitura ușii au rol funcțional (sunt necesare pentru ventilație). Ele nu sunt defecte ale produsului.

Repararea

1. Verificați canelura pentru montarea garniturii și asigurați-vă că nu prezintă defecte.

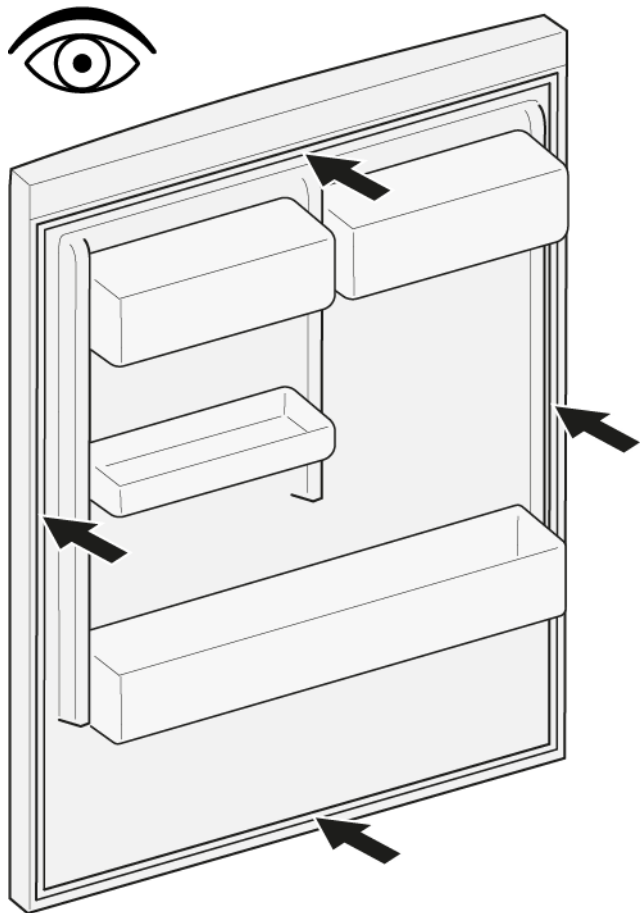

4. Împingeți colțurile de sus și de jos ale garniturii în canelură.



2.  Dacă canelura pentru montarea garniturii prezintă defecte, este deteriorată.
- Contactați departamentul de service pentru clienți.

3.  O deformare ușoară a garniturii ușii este normală și nu afectează funcționarea acesteia. Se recomandă să îndreptați garnitura ușii înainte de a o introduce în aparat.

Încălziți garnitura ușii cu un uscător de păr sau cu apă fierbinte și remodelați-o cu mâna.

Repararea

5. Apăsați întreaga garnitură în canelură, pas cu pas.

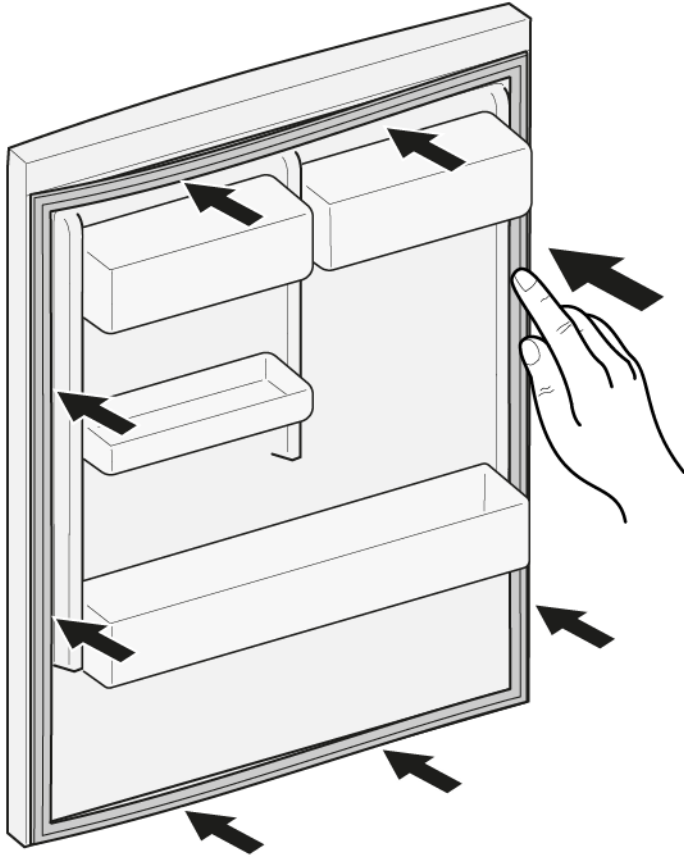



 Garnitura ușii este montată.

4.2 Înlocuirea mânerului ușii

Scule speciale:

 Chei cu locaș hexagonal 2 mm, 2,5 mm, 3 mm, 4 mm, 5 mm, 6 mm, 8 mm [00340819]

Cerință:

-  Aparatul este deconectat de la sursa de energie electrică.
-  Ușa este deschisă.

4.2.1 Demontarea mânerului ușii

1. 1. Deșurubați două șuruburi (1).
2. Demontați mânerul ușii (2).

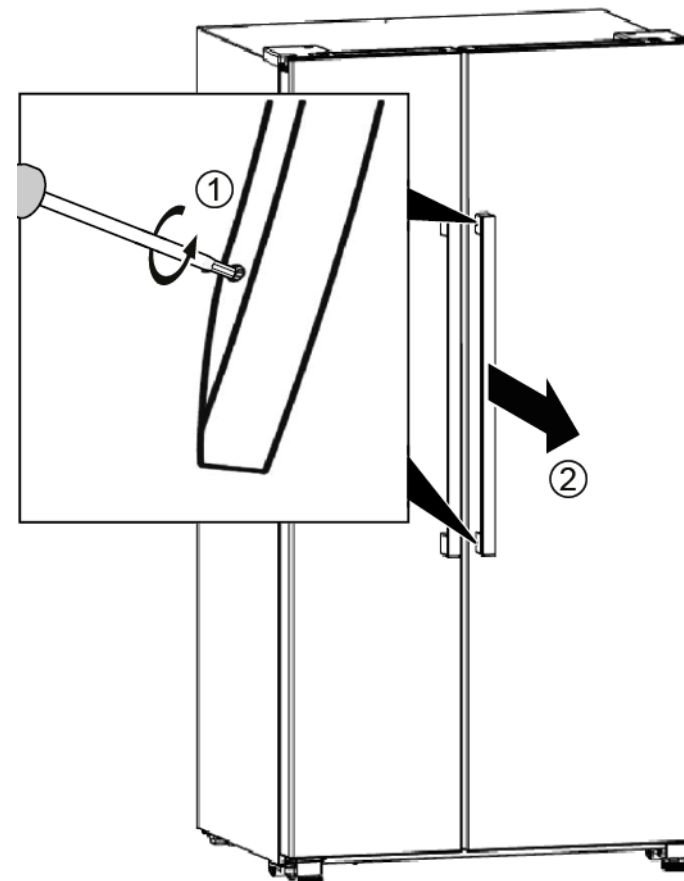

 Mânerul ușii este demontat.

2. Demontați mânerul celei de-a doua uși în același mod.

4.2.2 Montarea mânerului ușii

- ▶ Montați urmând procedura de demontare în ordine inversă.

4.3 Repoziționarea raftului

Cerință:

- ✔ Ușa este deschisă.

4.3.1 Demontarea raftului

- ▶ Scoateți raftul.

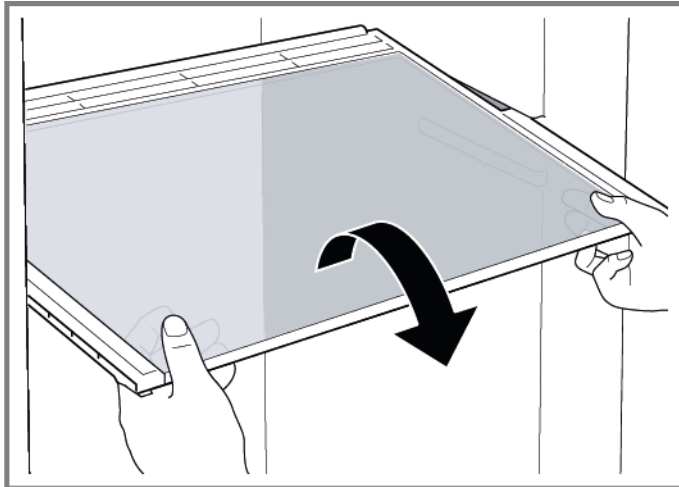

- ➡ Raftul este demontat.

4.3.2 Montarea raftului

- ▶ Montați urmând procedura de demontare în ordine inversă.

4.4 Repoziționarea suportului pentru sticle

Cerință:

- ✔ Ușa este deschisă.

4.4.1 Demontarea suportului pentru sticle

- ▶ Trageți suportul pentru sticle pentru a-l scoate.

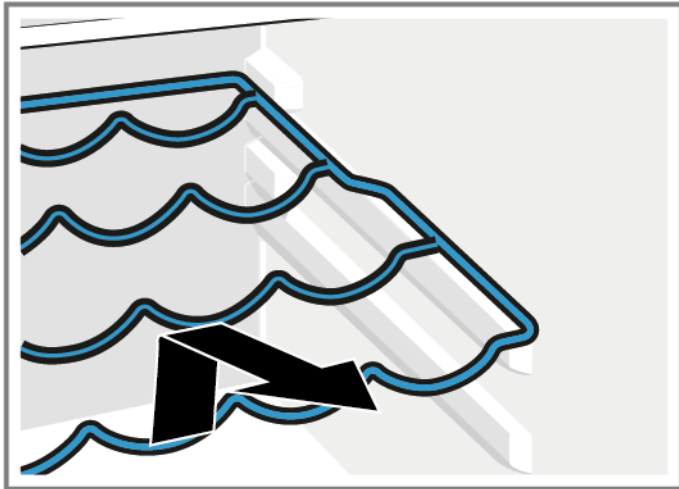

- ➡ Suportul pentru sticle este demontat.

4.4.2 Montarea suportului pentru sticle

- ▶ Montați urmând procedura de demontare în ordine inversă.

4.5 Repoziționarea raftului pentru ușă

Cerință:

- ✔ Ușa este deschisă.

4.5.1 Demontarea raftului pentru ușă

- ▶ Ridicați raftul pentru ușă.

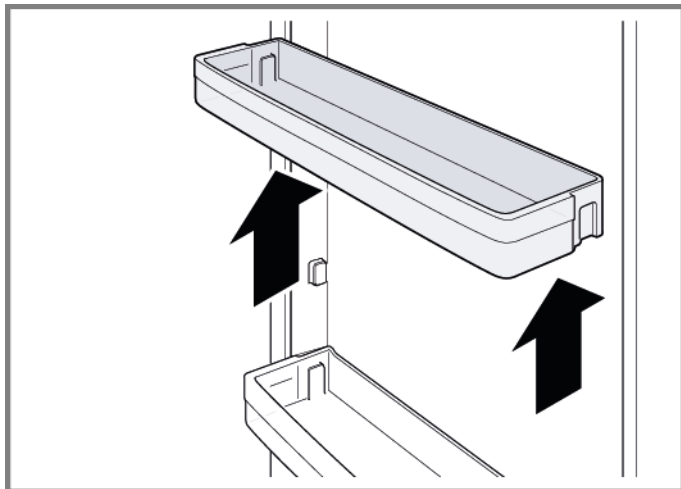

- ➡ Raftul pentru ușă este demontat.

4.5.2 Montarea raftului pentru ușă

- ▶ Montați urmând procedura de demontare în ordine inversă.

4.6 Repoziționarea containerelor

Cerință:

- ✔ Ușa este deschisă.

4.6.1 Demontarea containerelor

- ▶ Trageți containerul complet afară, ridicați-l pentru a-l detașa din suport și scoateți-l.

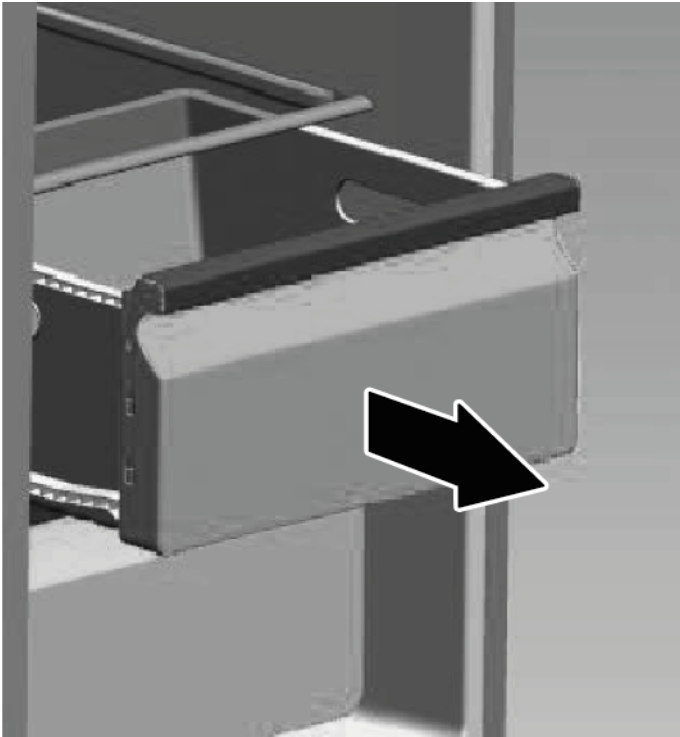



- ➡ Containerul este demontat.

4.6.2 Montarea containerelor

- ▶ Montați urmând procedura de demontare în ordine inversă.

4.7 Înlocuirea lămpii LED

	Aparatul dumneavoastră este echipat cu o lampă LED care nu necesită întreținere. Acele lămpi pot fi înlocuite numai de către departamentul de service pentru clienți sau de către tehnicieni autorizați!
-----------------------------------------------------------------------------------	-------------------------------------------------------------------------------------------------------------------------------------------------------------------------------------------------------------

	⚠ PERICOL Pericol de electrocutare din cauza pieselor sub tensiune! Pericol de moarte prin electrocutare în cazul unei reparații necorespunzătoare <ul style="list-style-type: none">▶ Componentele electrice trebuie reparate de către electricieni calificați.▶ După reparație, este obligatorie efectuarea unei verificări de siguranță conform cu VDE 0701 sau cu reglementările naționale respective.
----------------------------------------------------------------------------------	-------------------------------------------------------------------------------------------------------------------------------------------------------------------------------------------------------------------------------------------------------------------------------------------------------------------------------------------------------------------------------------------------------------------------------------------------------

	⚠ ATENȚIONARE Marginea ascuțită! Rănire prin tăiere <ul style="list-style-type: none">▶ Purtați mănuși de protecție.
----------------------------------------------------------------------------------	--------------------------------------------------------------------------------------------------------------------------------------------------------

Cerință:

- ✔ Aparatul este deconectat de la sursa de energie electrică.
- ✔ Ușa este deschisă.
- ✔ Raftul de sus este demontat.

4.7.1 Demontarea lămpii LED

1. Țineți capacul lămpii LED cu ambele mâini și trageți-l în jos



- ➡ Capacul lămpii LED este demontat.



2. Trageți lampa LED și scoateți-o afară



3. Deconectați terminalul



➡ Lampa LED este demontată.

4.7.2 Montarea lămpii LED

- ▶ Montați urmând procedura de demontare în ordine inversă.

Poznámky k opravám - Kombinácia chladničky a mrazničky

 O tomto dokumente	288
1.1 Dôležité informácie	288
1.1.1 Účel	288
1.2 Vysvetlenie symbolov	288
1.2.1 Úrovne nebezpečenstva	288
1.2.2 Symboly označujúce riziká.....	288
1.2.3 Štruktúra varovaní.....	289
1.2.4 Všeobecné symboly	289
 Bezpečnosť	290
2.1 Všeobecné bezpečnostné pokyny	290
2.1.1 Všetky domáce spotrebiče.....	290
 Nástroje a pomôcky	291
 Oprava	292
4.1 Výmena tesnenia dvierok	292
4.1.1 Odoberanie tesnenia dvierok	292
4.1.2 Montáž tesnenia dvierok.....	292
4.2 Výmena dverovej úchytky	295
4.2.1 Odoberanie dverovej úchytky.....	295
4.2.2 Montáž dverovej úchytky	295
4.3 Výmena odkladacej plochy.....	296
4.3.1 Odobratie odkladacej plochy.....	296
4.3.2 Montáž odkladacej plochy	296
4.4 Výmena odkladacieho priestoru na fľaše.....	297
4.4.1 Odobratie odkladacieho priestoru na fľaše.....	297
4.4.2 Montáž odkladacieho priestoru na fľaše	297
4.5 Výmena poličky v dvierkach	298
4.5.1 Odobratie poličky v dvierkach	298
4.5.2 Montáž poličky do dvierok	298
4.6 Výmena nádob	299
4.6.1 Odobratie nádob	299
4.6.2 Montáž nádob.....	299
4.7 Výmena LED žiarovky.....	300
4.7.1 Odobratie LED žiarovky.....	300
4.7.2 Montáž LED žiarovky	301

i O tomto dokumente

1.1 Dôležité informácie

1.1.1 Účel

Tieto pokyny pre opravu pomáhajú spotrebiteľovi pri vlastnej oprave spotrebičov podľa nariadenia o ekodizajne (z marca 2021).

Obsahujú informácie o výmene určených náhradných dielov vrátane varovaní a rizík.

Ak máte otázky, kontaktujte náš zákaznícky servis. Za poškodenia ručíme len vtedy, ak pokyny boli dodržané správne.

1.2 Vysvetlenie symbolov

1.2.1 Úrovne nebezpečenstva

Úroveň varovania obsahuje symbol a signalizačné slovo. Signalizačné slovo naznačuje mieru nebezpečenstva.





Úroveň varovania	Význam
 NEBEZPEČENSTVO	Následkom nerešpektovania varovného hlásenia je úmrtie alebo vážne zranenia.
 VAROVANIE	Možným následkom nerešpektovania varovného hlásenia je úmrtie alebo vážne zranenia.
 UPOZORNENIE	Možným následkom nerešpektovania varovného hlásenia sú mierne zranenia.
 POZOR!	Možným následkom nerešpektovania varovného hlásenia je poškodenie majetku.

Tabuľka 1: Úrovne nebezpečenstva



1.2.2 Symboly označujúce riziká

Symboly označujúce riziká sú symbolické znázornenia, ktoré naznačujú druh nebezpečenstva.

V tomto dokumente sa používajú nasledujúce symboly označujúce riziká:

Symbol označujúci riziko	Význam
	Všeobecné varovné hlásenie
	Nebezpečenstvo v súvislosti s elektrickým napätím
	Nebezpečenstvo výbuchu
	Nebezpečenstvo porezania
	Nebezpečenstvo pomliaždenia

i O tomto dokumente

Symbol označujúci riziko	Význam
	Nebezpečenstvo v súvislosti s horúcimi povrchmi
	Nebezpečenstvo v súvislosti s magnetickým poľom
	Nebezpečenstvo v súvislosti s neionizujúcou radiáciou

Tabuľka 2: Symboly označujúce riziká

1.2.3 Štruktúra varovaní

Varovania v tomto dokumente majú štandardný vzhľad a štandardnú štruktúru.



	<p>⚠ NEBEZPEČENSTVO</p> <p>Druh a zdroj nebezpečenstva! Možné následky pri ignorovaní nebezpečenstva/varovania.</p> <ul style="list-style-type: none"> ▶ Opatrenia a zákazy na zabránenie nebezpečenstvu.
----------------------------------------------------------------------------------	--------------------------------------------------------------------------------------------------------------------------------------------------------------------------------------------------------------------------------------------





Nasledujúci príklad znázorňuje varovanie pred zásahom elektrickým prúdom pri dotyku s časťami pod napätím. Je uvedené opatrenie na predídenie nebezpečenstvu.

	<p>⚠ NEBEZPEČENSTVO</p> <p>Nebezpečenstvo úrazu elektrickým prúdom pri dotyku s časťami pod napätím! Úmrtie v dôsledku zásahu elektrickým prúdom</p> <ul style="list-style-type: none"> ▶ Odpojte spotrebiče od elektrického zdroja aspoň 60 sekúnd pred začiatkom opráv.
-----------------------------------------------------------------------------------	------------------------------------------------------------------------------------------------------------------------------------------------------------------------------------------------------------------------------------------------------------------------------------------------------------

1.2.4 Všeobecné symboly

V tomto dokumente sa používajú nasledujúce všeobecné symboly:

Všeob. symbol	Význam
	Označenie špeciálneho pokynu (textové a/alebo grafické)
	Označenie jednoduchého pokynu (len textové)

Všeob. symbol	Význam
	Označenie prepojenia na videonávod
	Označenie požadovaných nástrojov
	Označenie požadovaných podmienok
	Označenie podmienky (ak ..., potom ...)
	Označenie výsledku
[Spustenie]	Označenie klávesu alebo tlačidla
[00123456]	Označenie čísla materiálu
Stav	Označenie zobrazeného textu/okna (na displeji spotrebiča)

Tabuľka 3: Všeobecné symboly

2.1 Všeobecné bezpečnostné pokyny

2.1.1 Všetky domáce spotrebiče

Nebezpečenstvo úrazu elektrickým prúdom pri dotyku s časťami pod napätím!

- Chyby pri opravách na elektrických komponentoch môžu spôsobiť zásah elektrickým prúdom!
- Odpojte spotrebič od elektrickej siete aspoň 60 sekúnd pred začiatkom práce.
- Po oprave zariadenia vykonajte bezpečnostný test v súlade s nariadením VDE 0701 alebo s miestnymi nariadeniami.

Riziko poranenia na ostrých hranách!

- Noste ochranné rukavice.

Riziko pomliaždenia počas opravy, údržby, riešenia problémov a servisu na ťažkých a pohybujúcich sa komponentoch

- Noste ochrannú obuv.
- Zaisťte ťažké komponenty proti pádu.
- Nesiahajte končatinami do pohybujúcich sa komponentov.



Riziko ohrozenia bezpečnosti/funkčnosti spotrebiča!

- Používajte len originálne náhradné diely.

Riziko poškodenia elektrostaticky citlivých komponentov (ESD)!

- Nedotýkajte sa modulov vrátane prípojok a vedení vodičov.

Nástroje a pomôcky

Označenie	Detaily	Snímky
Ochranná látka [00342013]	60 cm x 50 cm	
Šesťhranné imbu- sové kľúče [00340819]	2 mm, 2,5 mm, 3 mm, 4 mm, 5 mm, 6 mm, 8 mm	

4.1 Výmena tesnenia dvierok

Požiadavka:

- ✔ Dvierka sú otvorené.

4.1.1 Odoberanie tesnenia dvierok

1. Uvoľnite tesnenie dvierok z drážky na pravom a ľavom rohu.

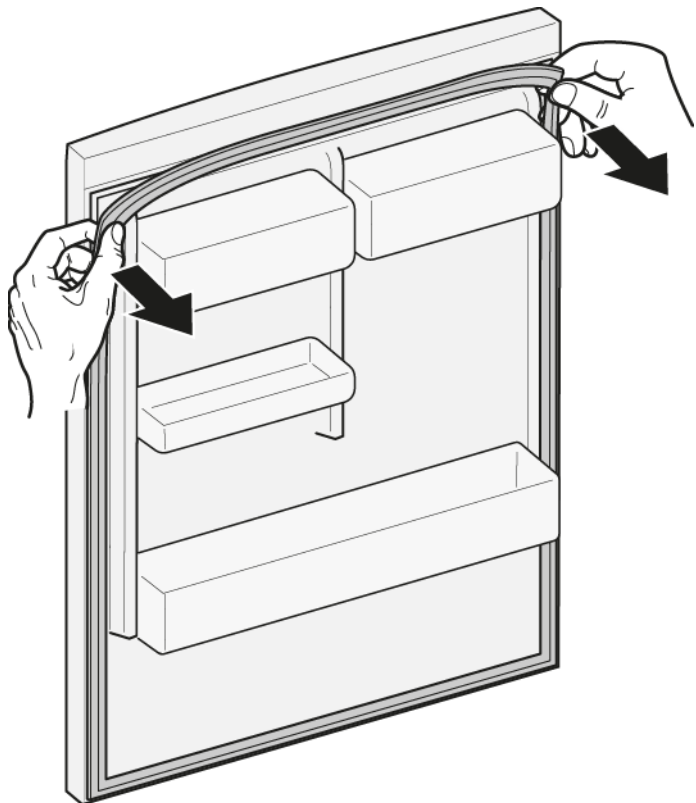

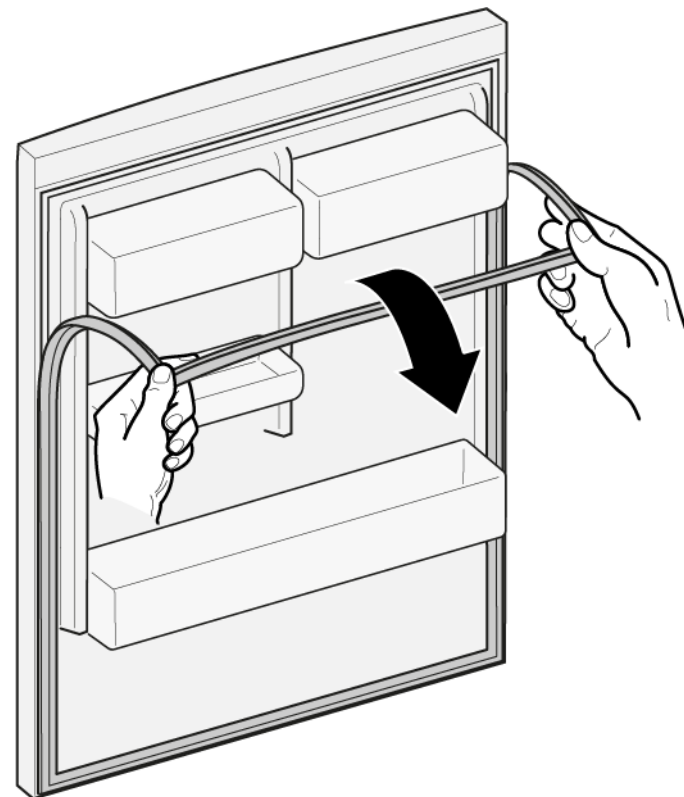

2. Vytiahnite tesnenie z drážky.



- ➡ Tesnenie dvierok je odobraté.

4.1.2 Montáž tesnenia dvierok

	Hrúbka nového tesnenia dvierok sa môže mierne odlišovať od hrúbky starého tesnenia dvierok. Neovplyvní to zatváranie ani funkčnosť z dlhodobého hľadiska.
	Ak má váš spotrebič nastaviteľné závesy alebo závesové úchytky, postupne môžete optimalizovať spôsob zatvárania.
	Malé bočné diery v tesnení dvierok majú svoju funkciu (sú potrebné na vetranie). Nie sú výrobnou chybou.

1. Skontrolujte poškodenie drážky na tesnenie.

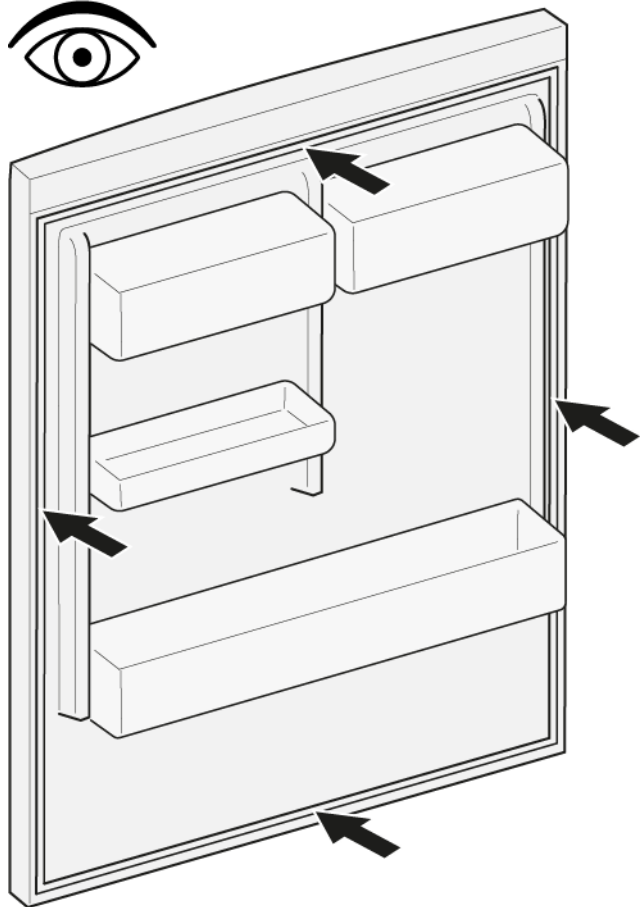

4. Hore a dole vtláčte rohy tesnenia do drážky.

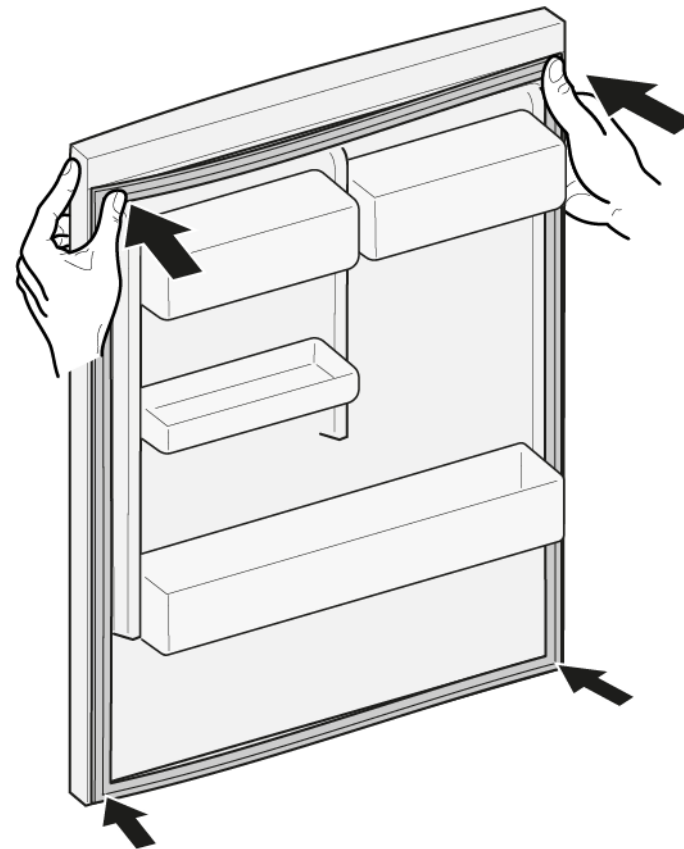

2.  Ak je drážka tesnenia je poškodená.
- Kontaktujte zákaznícky servis.

3.  Mierna deformácia tesnenia dvierok je normálna a neovplyvňuje jeho funkciu. Odporúča sa vyrovnať tesnenie pred jeho vloženíom do spotrebiča.

Nahrejte tesnenie dvierok použitím fénu alebo horúcej vody a manuálne ho vytvarujte.

5. Jedno miesto po druhom vtlačte celé tesnenie do drážky.

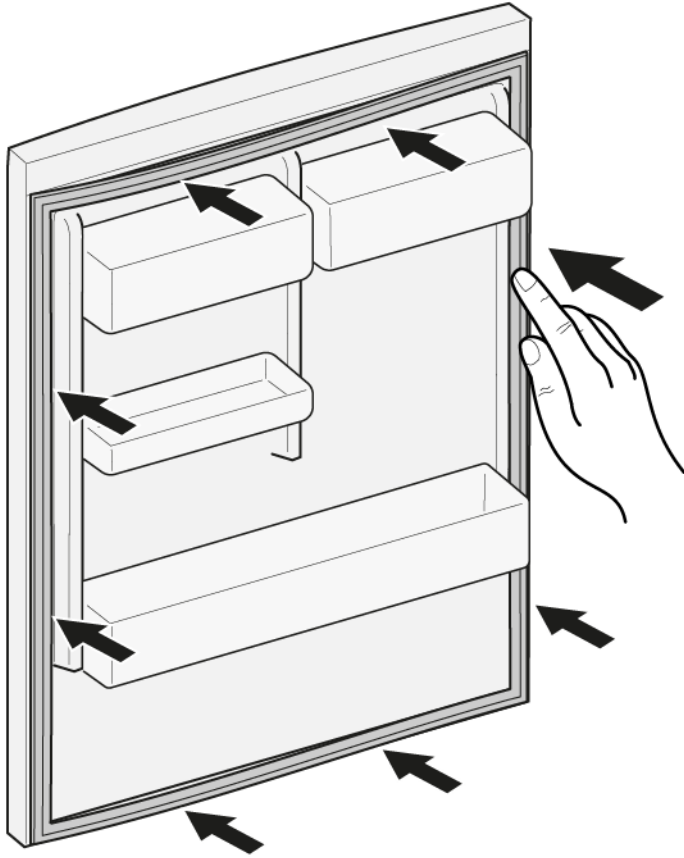



-  Tesnenie dvierok je namontované.

4.2 Výmena dverovej úchytky

Špeciálne nástroje:

-  Šesťhranné imbusové kľúče 2 mm, 2,5 mm, 3 mm, 4 mm, 5 mm, 6 mm, 8 mm [00340819]

Požiadavka:

-  Spotrebič je odpojený od elektrického napájania.
-  Dvierka sú otvorené.

4.2.1 Odoberanie dverovej úchytky

1. Odskrutkujte dve skrutky (1).
2. Odoberte dverovú úchytku (2).

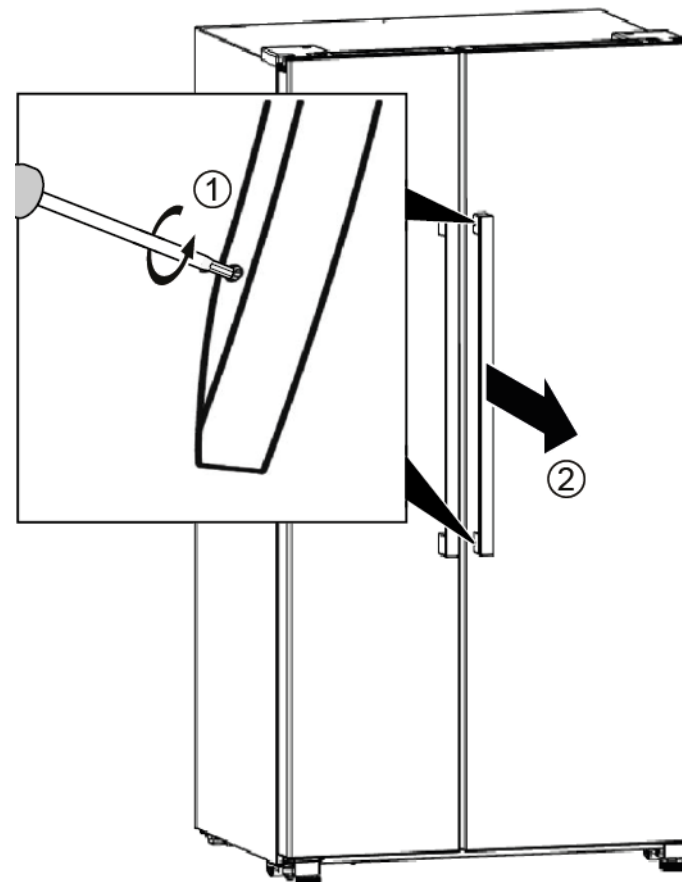

 Dverová úchytka je odobratá.

2. Druhú dverovú úchytku odoberte rovnakým spôsobom.

4.2.2 Montáž dverovej úchytky

- ▶ Pri montáži postupujte v opačnom poradí krokov demontáže.

4.3 Výmena odkladacej plochy

Požiadavka:

- ✔ Dvierka sú otvorené.

4.3.1 Odobratie odkladacej plochy

- ▶ Vytiahnite odkladaciu plochu.

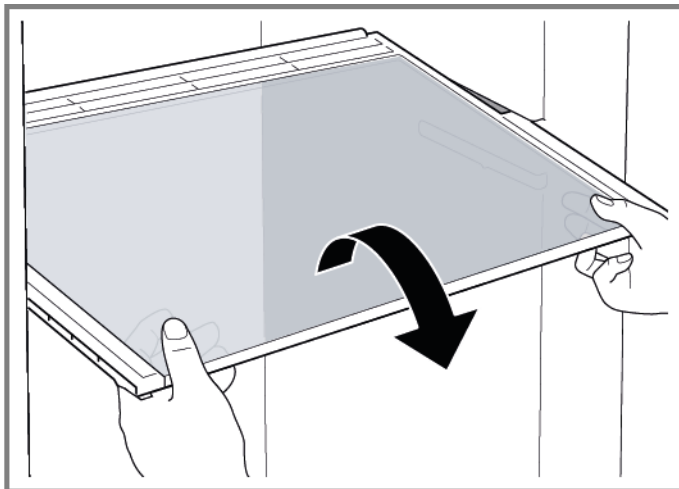

- ➡ Odkladacia plocha je odobratá.

4.3.2 Montáž odkladacej plochy

- ▶ Pri montáži postupujte v opačnom poradí krokov demontáže.

4.4 Výmena odkladacieho priestoru na fľaše

Požiadavka:

- ✔ Dvierka sú otvorené.

4.4.1 Odobratie odkladacieho priestoru na fľaše

- ▶ Vytiahnite odkladací priestor na fľaše.

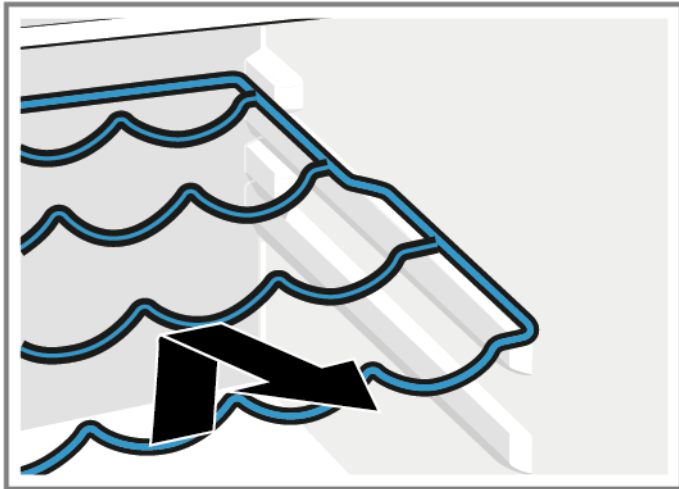

- ➡ Odkladací priestor na fľaše je odobratý.

4.4.2 Montáž odkladacieho priestoru na fľaše

- ▶ Pri montáži postupujte v opačnom poradí krokov demontáže.

4.5 Výmena poličky v dvierkach

Požiadavka:

- ✔ Dvierka sú otvorené.

4.5.1 Odobratie poličky v dvierkach

- ▶ Poličku v dvierkach zodvihnite smerom nahor.

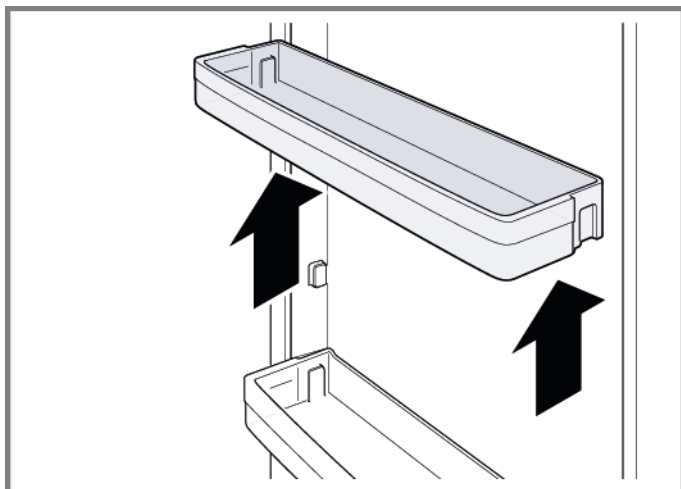

- ➡ Polička v dvierkach je odobratá.

4.5.2 Montáž poličky do dvierok

- ▶ Pri montáži postupujte v opačnom poradí krokov demontáže.

4.6 Výmena nádob

Požiadavka:

- ✔ Dvierka sú otvorené.

4.6.1 Odoberanie nádob

- ▶ Vysuňte nádobu, zdvihnutím ju odpojte z držiaka a vyberte ju.

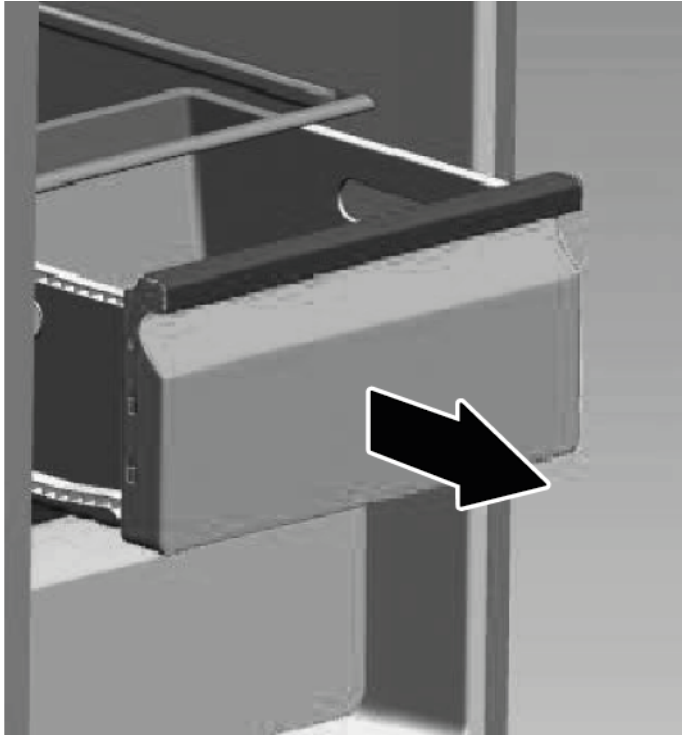



- ⬅ Nádobu je odobratá.

4.6.2 Montáž nádob

- ▶ Pri montáži postupujte v opačnom poradí krokov demontáže.

4.7 Výmena LED žiarovky

	Vo výbave vášho spotrebiča je bezúdržbové LED svetlo. Tieto svetlá môže opravovať len zákaznícky servis alebo oprávnený technik!
-----------------------------------------------------------------------------------	----------------------------------------------------------------------------------------------------------------------------------

	⚠ NEBEZPEČENSTVO
	<p>Nebezpečenstvo úrazu elektrickým prúdom pri dotyku s časťami pod napätím! Ohrozenie života spôsobené elektrickým zásahom v prípade nesprávnej opravy</p> <ul style="list-style-type: none"> ▶ Elektrické diely má opravovať kvalifikovaný elektrikár. ▶ Po oprave zariadte vykonanie bezpečnostného testu v súlade s nariadením VDE 0701 alebo s miestnymi nariadeniami.

	⚠ UPOZORNENIE
	<p>Ostré hrany! Rezné poranenia</p> <ul style="list-style-type: none"> ▶ Noste ochranné rukavice.

Požiadavka:

- ✔ Spotrebič je odpojený od elektrického napájania.
- ✔ Dvierka sú otvorené.
- ✔ Horná odkladacia plocha je odobratá.

4.7.1 Odobratie LED žiarovky

1. Chyťte kryt LED žiarovky dvomi rukami a potiahnite nadol



2. Kryt LED žiarovky je odobratý.



2. Potiahnite a vyberte LED žiarovku



3. Odpojte kontakt



3. LED žiarovka je odobratá.

4.7.2 Montáž LED žiarovky

- ▶ Pri montáži postupujte v opačnom poradí krokov demontáže.

Nasveti za popravilo - Hladilno-zamrzovalna kombinacija

 V zvezi s tem dokumentom	303
1.1 Pomembne informacije	303
1.1.1 Namen	303
1.2 Razlaga simbolov	303
1.2.1 Stopnje nevarnosti	303
1.2.2 Simboli za nevarnost	303
1.2.3 Struktura opozoril	304
1.2.4 Splošni simboli	304
 Varnost.....	305
2.1 Splošna varnostna navodila	305
2.1.1 Vsi gospodinjski aparati	305
 Orodja in pripomočki.....	306
 Popravilo	307
4.1 Zamenjava tesnila vrat	307
4.1.1 Odstranjevanje tesnila vrat	307
4.1.2 Namestitev tesnila vrat	307
4.2 Zamenjava ročaja vrat	310
4.2.1 Odstranjevanje ročaja vrat	310
4.2.2 Namestitev ročaja vrat	310
4.3 Zamenjava police	311
4.3.1 Odstranjevanje police	311
4.3.2 Namestitev police	311
4.4 Zamenjava nosilca za steklenice	312
4.4.1 Odstranjevanje nosilca za steklenice	312
4.4.2 Namestitev nosilca za steklenice	312
4.5 Zamenjava vratnega predala	313
4.5.1 Odstranjevanje vratnega predala	313
4.5.2 Namestitev vratnega predala	313
4.6 Zamenjava predalov	314
4.6.1 Odstranjevanje predalov	314
4.6.2 Namestitev predalov	314
4.7 Zamenjava luči LED	315
4.7.1 Odstranjevanje luči LED	315
4.7.2 Namestitev luči LED	316

i V zvezi s tem dokumentom

1.1 Pomembne informacije

1.1.1 Namen

Ti namigi za popravila uporabnika podpirajo pri lastnoročnem popravilu aparatov skladno z veljavno direktivo glede okoljsko primerne zasnove (od marca 2021).

Vsebujejo informacije o tem, kako zamenjati določene rezervne dele, vključno z opozorili in tveganji.

Če imate kakšna vprašanja, se obrnite na našo servisno službo. Za škodo bomo odgovorni le, če ste namige za popravila upoštevali pravilno.

1.2 Razlaga simbolov

1.2.1 Stopnje nevarnosti

Stopnje opozoril so sestavljene iz simbola in signalne besede. Signalna beseda označuje stopnjo nevarnosti.





Stopnja opozorila	Pomen
 NEVARNOST	Neupoštevanje opozorilnega sporočila bo povzročilo smrt ali hude poškodbe.
 OPOZORILO	Neupoštevanje opozorilnega sporočila lahko povzroči smrt ali hude poškodbe.
 PREVIDNO	Neupoštevanje opozorilnega sporočila lahko povzroči manjše poškodbe.
 POZOR!	Neupoštevanje opozorilnega sporočila lahko povzroči škodo na lastnini.

Preglednica 1: Stopnje nevarnosti



1.2.2 Simboli za nevarnost

Simboli za nevarnost so simbolni prikazi, ki podajajo informacije o vrsti nevarnosti.

V tem dokumentu so uporabljeni naslednji simboli za nevarnost:

Simbol za nevarnost	Pomen
	Splošno opozorilno sporočilo
	Nevarnost zaradi električne napetosti
	Nevarnost eksplozije
	Nevarnost ureznin
	Nevarnost zmečkanin

i V zvezi s tem dokumentom

Simbol za nevarnost	Pomen
	Nevarnost zaradi vročih površin
	Nevarnost zaradi močnega magnetnega polja
	Nevarnost zaradi neionizirajočega sevanja

Preglednica 2: Simboli za nevarnost

1.2.3 Struktura opozoril

Opozorila v tem dokumentu imajo standardiziran videz in standardizirano strukturo.



	<div style="background-color: red; color: white; padding: 2px; text-align: center;">⚠ NEVARNOST</div> <p>Vrsta in vir nevarnosti! Morebitne posledice ob neupoštevanju nevarnosti/opozorila.</p> <ul style="list-style-type: none"> ▶ Ukrepi in prepovedi za preprečevanje nevarnosti.
----------------------------------------------------------------------------------	-------------------------------------------------------------------------------------------------------------------------------------------------------------------------------------------------------------------------------------------------------------------------------------------------------------------------





V naslednjem primeru je prikazano opozorilo, ki opozarja pred električnim udarom zaradi delov pod napetostjo. Naveden je ukrep za preprečevanje nevarnosti.

	<div style="background-color: red; color: white; padding: 2px; text-align: center;">⚠ NEVARNOST</div> <p>Nevarnost električnega udara zaradi delov pod napetostjo! Smrt zaradi električnega udara</p> <ul style="list-style-type: none"> ▶ Izključite aparate iz električnega omrežja vsaj 60 sekund pred začetkom popravil.
-----------------------------------------------------------------------------------	---------------------------------------------------------------------------------------------------------------------------------------------------------------------------------------------------------------------------------------------------------------------------------------------------------------------------------------------------------------

1.2.4 Splošni simboli

V tem dokumentu so uporabljeni naslednji splošni simboli:

Splošni simbol	Pomen
	Identifikacija posebnega nasveta (besedilo in/ali slika)
	Identifikacija preprostega nasveta (samo besedilo)
	Identifikacija povezave na video vadnico

Splošni simbol	Pomen
	Identifikacija potrebnih orodij
	Identifikacija potrebnih predpogojev
	Identifikacija pogoja (če ..., potem ...)
	Identifikacija rezultata
Začetek	Identifikacija tipke ali gumba
[00123456]	Identifikacija številke dela
Stanje	Identifikacija prikazanega besedila/okna (na zaslonu aparata)

Preglednica 3: Splošni simboli

2.1 Splošna varnostna navodila

2.1.1 Vsi gospodinjski aparati

Nevarnost električnega udara zaradi delov pod napetostjo!

- Napake zaradi popravil električnih komponent lahko povzročijo električni udar!
- Aparat izključite iz električnega omrežja vsaj 60 sekund pred začetkom del.
- Po popravilu je treba izvesti preizkus varnosti v skladu z VDE 0701 ali predpisi, ki veljajo za posamezno državo.

Nevarnost poškodb zaradi ostrih robov!

- Uporabljajte zaščitne rokavice.

Nevarnost zmečkanin med popravili, vzdrževanjem, odpravljanjem težav ali servisom zaradi težkih in premikajočih se komponent

- Uporabljajte zaščitne čevlje.
- Težke komponente zavarujte pred padanjem.
- Delov telesa ne vstavljajte v premikajoče se komponente.



Tveganje za varnost/delovanje aparata!

- Uporabljajte le originalne nadomestne dele.

Tveganje poškodb elektrostatično občutljivih komponent (ESD)!

- Ne dotikajte se modulov, vključno s povezavami in potmi vodnika.

Orodja in pripomočki

Oznaka	Podrobnosti	Slike
Zaščitna krpa [00342013]	60 cm x 50 cm	
Šestrobi ključi [00340819]	2 mm, 2,5 mm, 3 mm, 4 mm, 5 mm, 6 mm, 8 mm	

4.1 Zamenjava tesnila vrat

Zahteva:

- ✔ Vrata so odprta.

4.1.1 Odstranjevanje tesnila vrat

1. V levem in desnem kotu sprostite tesnilo vrat iz utora.

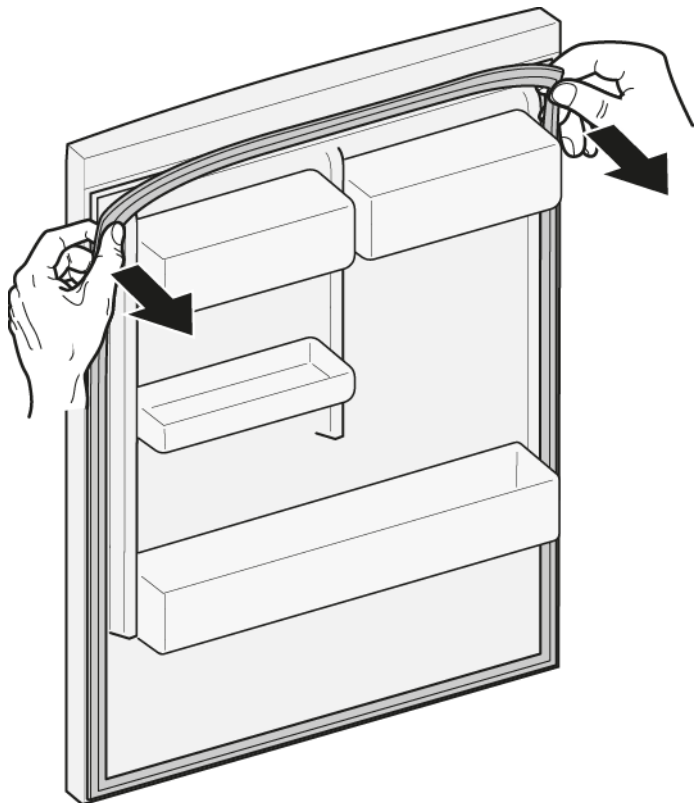

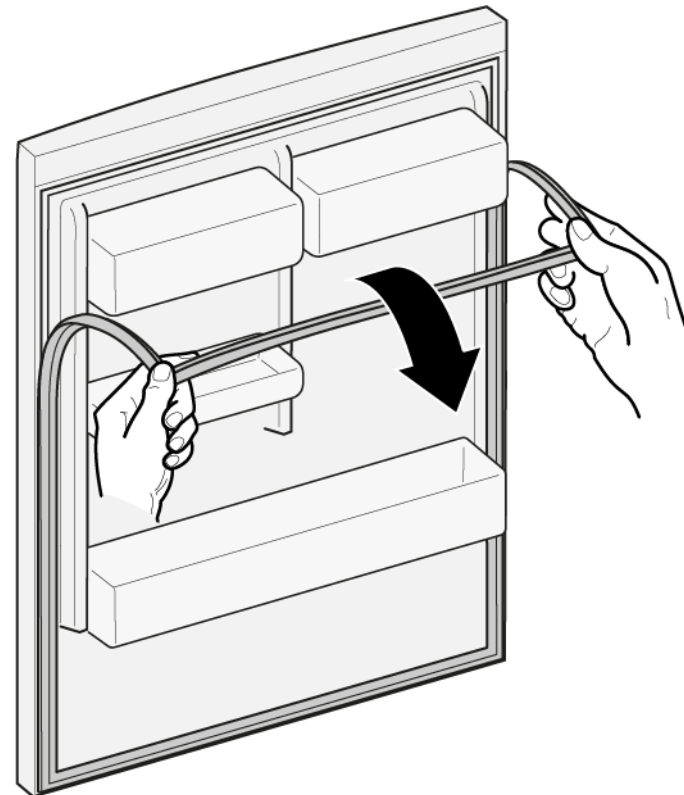

2. Tesnilo vrat izvlecite iz utora.



- ➡ Tesnilo vrat je odstranjeno.

4.1.2 Namestitev tesnila vrat

	Debelina novega tesnila vrat se lahko nekoliko razlikuje od starega tesnila vrat. To ne vpliva na zapiranje in dolgoročno delovanje aparata.
	Če ima aparat nastavljive tečaje ali priključke tečajev, lahko zapiranje naknadno tudi prilagodite.
	Majhne stranske luknje v tesnilu vrat imajo svoj namen (potrebne so za prezračevanje). Ne gre za proizvodne napake.

Popravilo

1. Preverite, ali je utor za tesnilo poškodovan.

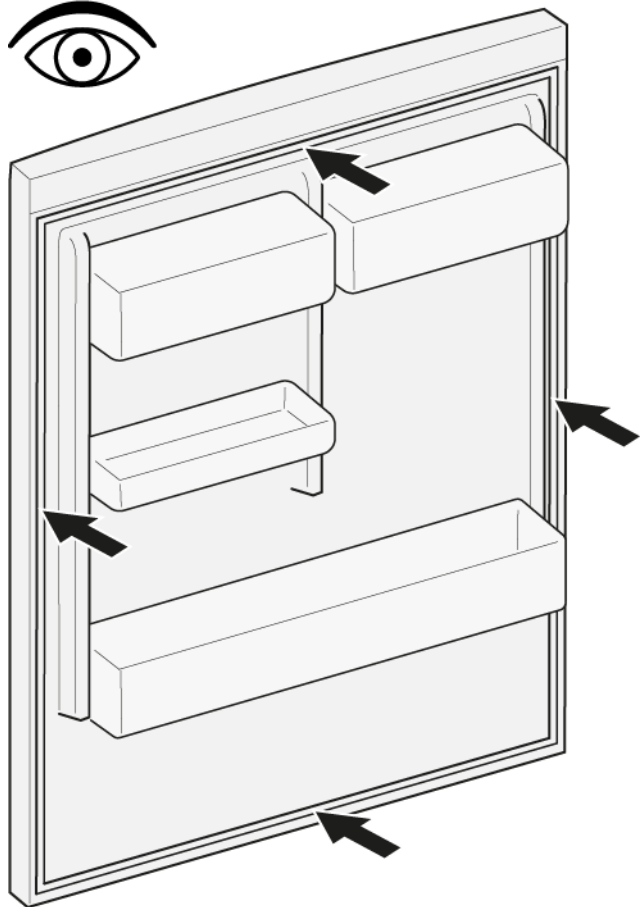

4. Vogale tesnila zgoraj in spodaj potisnite v utor.

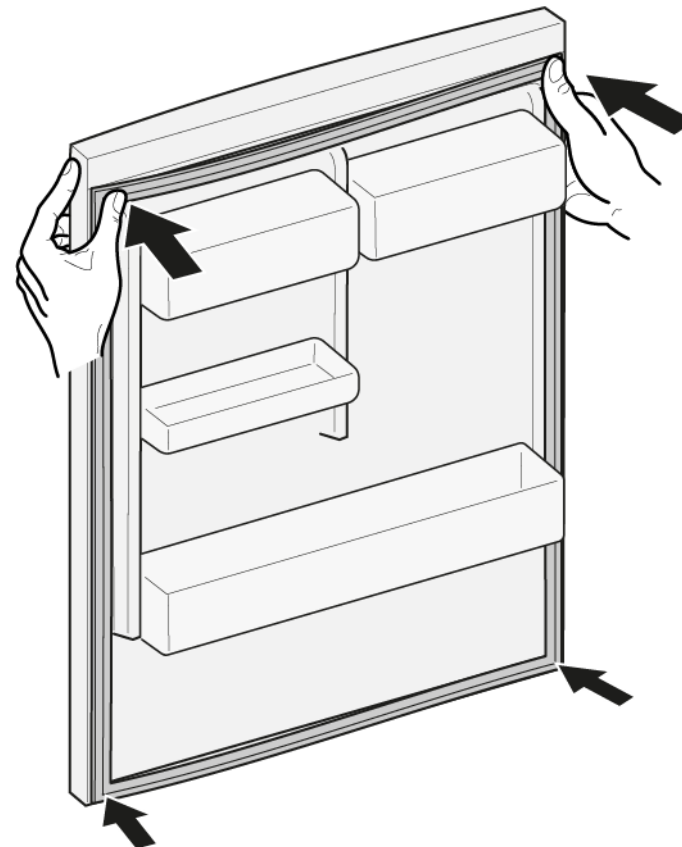

2.  Če je utor za tesnilo poškodovan:
 - se obrnite na našo servisno službo.

3.  Majhna deformacija tesnila vrat je običajna in ne vpliva na njegovo delovanje. Priporočljivo je, da tesnilo vrat pred namestitvijo v aparat poravnate.

Tesnilo vrat lahko segrejete s sušilnikom za lase ali toplo vodo, da ga ročno preoblikujete.

Popravilo

5. Celotno tesnilo korak po koraku potisnite v utor.

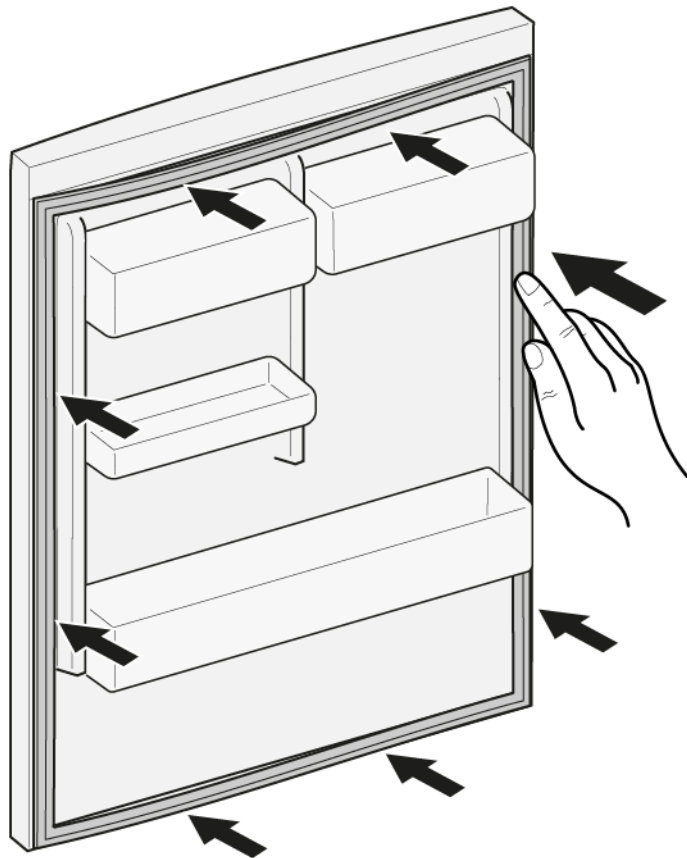



 Tesnilo vrat je nameščeno.

4.2 Zamenjava ročaja vrat

Posebna orodja:

 Šestrobi ključi 2 mm, 2,5 mm, 3 mm, 4 mm, 5 mm, 6 mm, 8 mm [00340819]

Zahteva:

-  Aparat je odklopljen iz omrežne napetosti.
-  Vrata so odprta.

4.2.1 Odstranjevanje ročaja vrat

1. Odvijte vijaka (1).
2. Odstranite ročaj vrat (2).

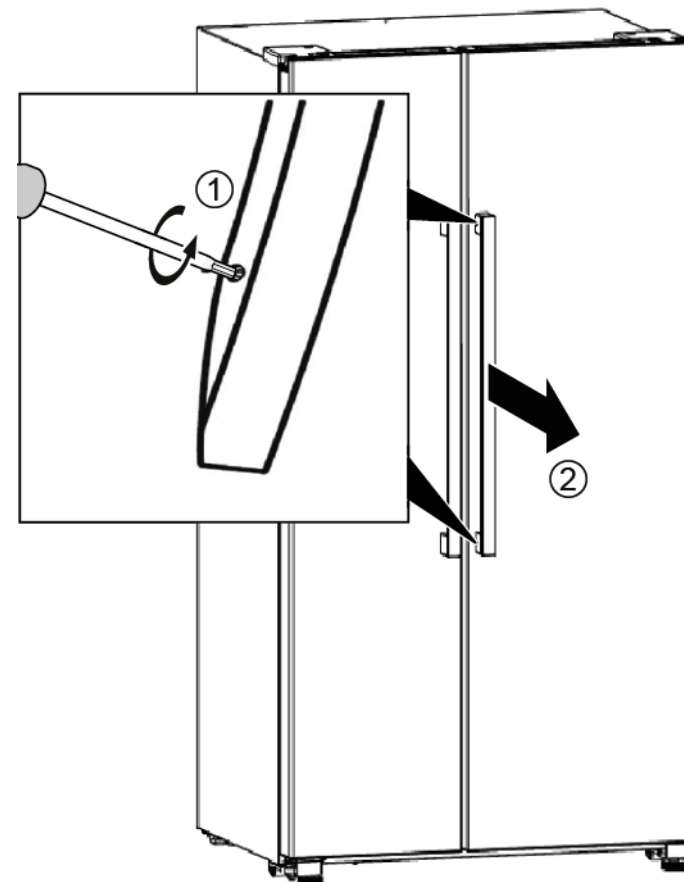

 Ročaj vrat je odstranjen.

2. Ročaj drugih vrat odstranite na enak način.

4.2.2 Namestitev ročaja vrat

- ▶ Namestite v obratnem vrstnem redu.

4.3 Zamenjava police

Zahteva:

- ✔ Vrata so odprta.

4.3.1 Odstranjevanje police

- ▶ Izvlecite polico.

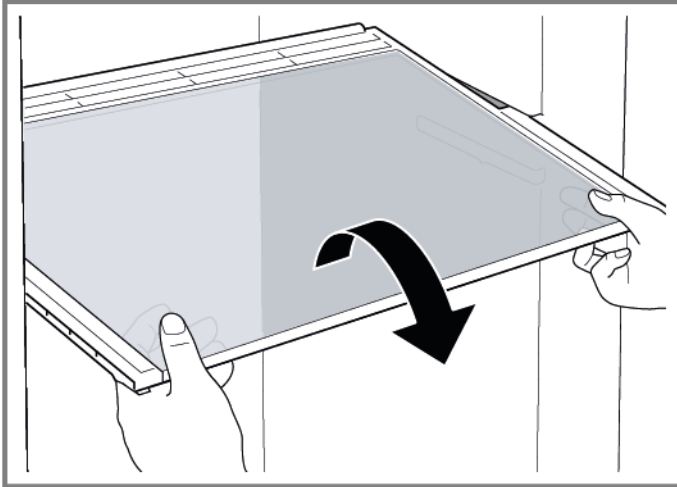

- ➡ Polica je odstranjena.

4.3.2 Namestitev police

- ▶ Namestite v obratnem vrstnem redu.

4.4 Zamenjava nosilca za steklenice

Zahteva:

- ✔ Vrata so odprta.

4.4.1 Odstranjevanje nosilca za steklenice

- ▶ Izvlecite nosilec za steklenice.

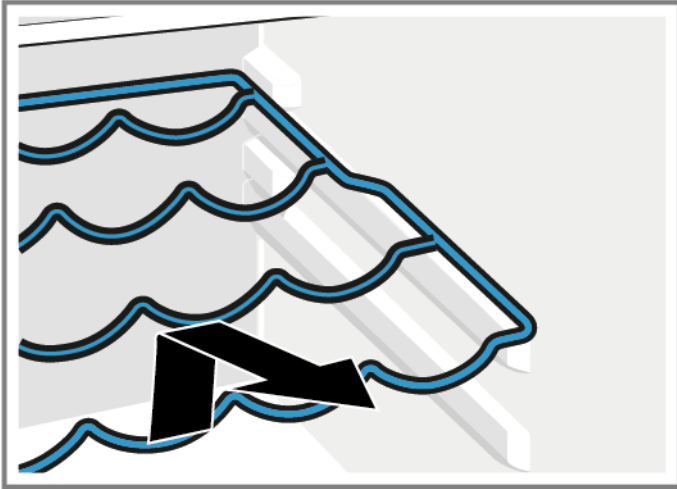

- ➡ Nosilec za steklenice je odstranjen.

4.4.2 Namestitev nosilca za steklenice

- ▶ Namestite v obratnem vrstnem redu.

4.5 Zamenjava vratnega predala

Zahteva:

- ✔ Vrata so odprta.

4.5.1 Odstranjevanje vratnega predala

- ▶ Dvignite vrtni predal navzgor.

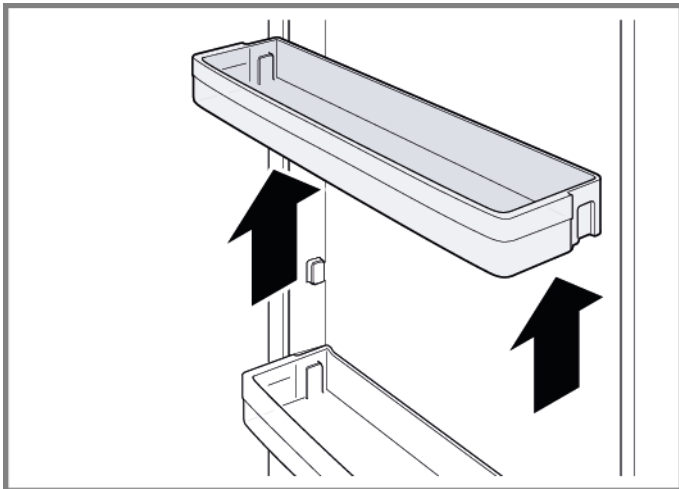

- ➡ Vratni predal je odstranjen.

4.5.2 Namestitev vratnega predala

- ▶ Namestite v obratnem vrstnem redu.

4.6 Zamenjava predalov

Zahteva:

- ✔ Vrata so odprta.

4.6.1 Odstranjevanje predalov

- ▶ Predal izvlecite do konca, ga privzdignite, da ga snamete z držala, in ga odstranite.

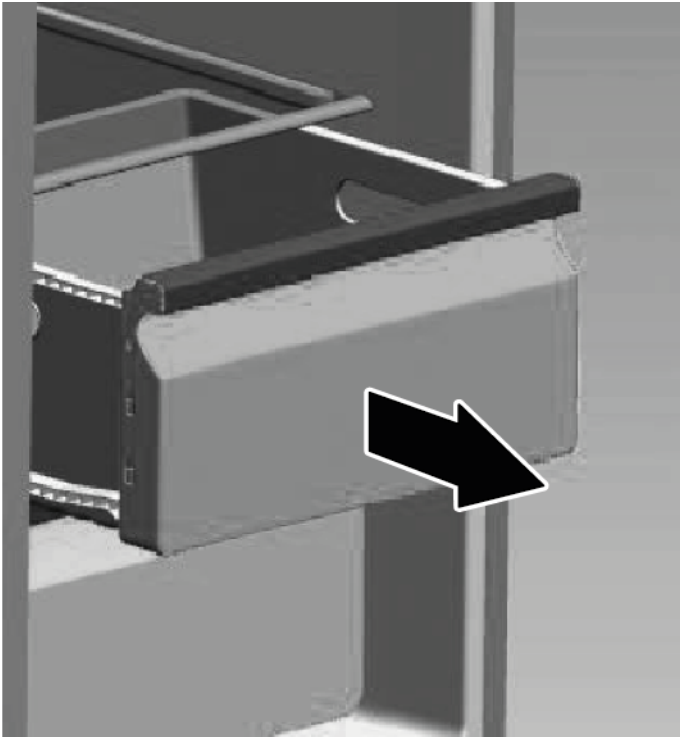

- ➡ Predal je odstranjen.

4.6.2 Namestitev predalov

- ▶ Namestite v obratnem vrstnem redu.

4.7 Zamenjava luči LED



Vaš aparat je opremljen z osvetlitvijo LED, ki ne potrebuje vzdrževanja. To vrsto osvetlitve lahko popravi samo servisna služba ali pooblaščen strokovno osebje!



⚠️ NEVARNOST

Nevarnost električnega udara zaradi delov pod napetostjo!

Življenjska nevarnost zaradi električnega udara v primeru nepravilnega popravila

- ▶ Električne dele mora popraviti kvalificiran električar.
- ▶ Po popravilu je treba izvesti preizkus varnosti v skladu z VDE 0701 ali predpisi, ki veljajo za posamezno državo.



⚠️ PREVIDNO

Ostri robovi!

Ureznine

- ▶ Uporabljajte zaščitne rokavice.

Zahteva:

- ✔ Aparat je odklopljen iz omrežne napetosti.
- ✔ Vrata so odprta.
- ✔ Zgornja polica je odstranjena.

4.7.1 Odstranjevanje luči LED

1. Pokrov luči LED primite z obema rokama in ga povlecite k sebi.



- ➡ Pokrov luči LED je odstranjen.



2. Izvlecite in odstranite luč LED



3. Odklopite terminal







- ➡ Luč LED je odstranjena.

4.7.2 Namestitev luči LED

- ▶ Namestite v obratnem vrstnem redu.

Consejos de reparación - Frigorífico / congelador

 En relación con este documento	318
1.1 Información importante	318
1.1.1 Finalidad	318
1.2 Explicación de símbolos generales	318
1.2.1 Niveles de peligrosidad	318
1.2.2 Símbolos de peligro	318
1.2.3 Estructura de las advertencias	319
1.2.4 Símbolos generales	319
 Seguridad	320
2.1 Instrucciones generales de seguridad	320
2.1.1 Todos los aparatos electrodomésticos.....	320
 Herramientas y auxiliares	321
 Reparación	322
4.1 Sustituir la junta de la puerta	322
4.1.1 Retirar la junta de la puerta.....	322
4.1.2 Montar la junta de la puerta	322
4.2 Sustituir el tirador de la puerta.....	325
4.2.1 Retirar el tirador de la puerta	325
4.2.2 Montar el tirador de la puerta	325
4.3 Sustituir el estante	326
4.3.1 Extraer el estante	326
4.3.2 Montar el estante	326
4.4 Sustituir la bandeja botellero	327
4.4.1 Extraer la bandeja botellero	327
4.4.2 Montar la bandeja botellero	327
4.5 Sustituir el estante de la puerta	328
4.5.1 Extraer el estante de la puerta	328
4.5.2 Montar el estante de la puerta.....	328
4.6 Sustituir cajóns.....	329
4.6.1 Extraer cajóns.....	329
4.6.2 Montar cajóns	329
4.7 Sustituir la lámpara LED	330
4.7.1 Desmontar la lámpara LED.....	330
4.7.2 Montar la lámpara LED.....	331

i En relación con este documento

1.1 Información importante

1.1.1 Finalidad

Estas indicaciones de reparación sirven como ayuda al consumidor para reparar aparatos por su cuenta conforme al reglamento aplicable sobre diseño ecológico (a partir de 03/2021).

Contienen información sobre cómo sustituir repuestos determinados e incluye las advertencias y los riesgos.

En caso de dudas, póngase en contacto con nuestro departamento de atención al cliente. Solo asumiremos la responsabilidad por daños si las indicaciones de reparación se han seguido correctamente.

1.2 Explicación de símbolos generales

1.2.1 Niveles de peligrosidad

Los niveles de peligro consisten en un símbolo y una palabra de advertencia. La palabra de advertencia identifica la gravedad del peligro.





Nivel de peligro	Significado
 PELIGRO	Si no se tiene en cuenta la advertencia, ocasionará la muerte o lesiones graves.
 ADVERTENCIA	Si no se tiene en cuenta la advertencia, puede ocasionar la muerte o lesiones graves.
 PRECAUCIÓN	Si no se tiene en cuenta la advertencia, puede ocasionar lesiones de carácter leve.
ATENCIÓN	Si no se tiene en cuenta la advertencia, puede ocasionar daños materiales.

Tabla 1: Niveles de peligrosidad

1.2.2 Símbolos de peligro

Los símbolos de peligro son una representación simbólica que indica el tipo de peligrosidad.

En este documento se utilizan los siguientes símbolos de peligro:

Símbolo de peligro	Significado
	Advertencia general
	Peligro de lesiones por corriente eléctrica
	Riesgo de explosión
	Peligro de lesiones a causa de cortes

i En relación con este documento





Símbolo de peligro	Significado
	Peligro de lesiones por aplastamiento
	Peligro de lesiones por superficies calientes
	Peligro a causa de campos magnéticos de gran potencia
	Peligro derivado de radiación no ionizante

Tabla 2: Símbolos de peligro

1.2.3 Estructura de las advertencias

Las advertencias de este documento tienen una apariencia y una estructura uniformes.

	<div style="background-color: red; color: white; padding: 2px; text-align: center;">⚠ PELIGRO</div> <p>¡Tipo y fuente del peligro! Posibles consecuencias de ignorar el peligro / la advertencia.</p> <ul style="list-style-type: none"> ▶ Medidas y prohibiciones para prevenir el peligro.
----------------------------------------------------------------------------------	-------------------------------------------------------------------------------------------------------------------------------------------------------------------------------------------------------------------------------------------------------------------------------------------------------------------------------

El ejemplo siguiente muestra una advertencia de descarga eléctrica a causa de piezas o partes cargadas con tensión. Se menciona la medida para evitar el peligro.

	<div style="background-color: red; color: white; padding: 2px; text-align: center;">⚠ PELIGRO</div> <p>¡Riesgo de descarga eléctrica debido a partes con tensión! Muerte por electrocución</p> <ul style="list-style-type: none"> ▶ Desconectar el aparato de la red al menos 60 segundos antes de comenzar con la reparación.
------------------------------------------------------------------------------------	-----------------------------------------------------------------------------------------------------------------------------------------------------------------------------------------------------------------------------------------------------------------------------------------------------------------------------------------------------------------

1.2.4 Símbolos generales

En este documento se utilizan los siguientes símbolos generales:

Símbolo general	Significado
	Identificación de una indicación especial (texto y/o gráfico)







Símbolo general	Significado
	Identificación de un consejo simple (solo texto)
	Identificación de un enlace a un video tutorial
	Identificación de una herramienta requerida
	Identificación de una condición previa (prerrequisito)
	Identificación de una condición (si ..., entonces ...)
	Identificación de un resultado
Iniciar	Identificación de una tecla o botón
[00123456]	Identificación de un número de material
Estado	Identificación del texto / ventana mostrado (en el display del aparato)

Tabla 3: Símbolos generales

2.1 Instrucciones generales de seguridad

2.1.1 Todos los aparatos electrodomésticos

¡Riesgo de descarga eléctrica debido a piezas con tensión!

- ¡Los errores en las reparaciones que incluyan componentes eléctricos pueden provocar una descarga eléctrica!
- Desconectar el aparato de la red durante al menos 60 segundos antes de comenzar con el trabajo.
- Después de la reparación, encargar una prueba de seguridad conforme a VDE 0701 o los reglamentos específicos del país.

¡Riesgo de lesiones debido a bordes afilados!

- Usar guantes de protección.

Riesgo de aplastamiento durante la reparación, mantenimiento, resolución de problemas y servicio debido a componentes pesados y móviles

- Usar calzado de seguridad.
- Asegure los componentes pesados para que no se caigan.
- No pegue partes del cuerpo en componentes móviles.



¡Riesgo para la seguridad/el funcionamiento del aparato!

- Utilizar únicamente los repuestos originales.

¡Riesgo de daños de los componentes sensibles a cargas electrostáticas (ESD)!

- No tocar los módulos, incluidas las conexiones y las pistas conductoras.

Herramientas y auxiliares

Designacion	Detalles	Imágenes
Paño de protección [00342013]	60 cm x 50 cm	
Puntas llaves Allen hexagonales [00340819]	2 mm, 2,5 mm, 3 mm, 4 mm, 5 mm, 6 mm, 8 mm	

4.1 Sustituir la junta de la puerta

Requisito:

- ✔ La puerta está abierta.

4.1.1 Retirar la junta de la puerta

1. Soltar la junta de la puerta de la ranura por las esquinas izquierda y derecha.

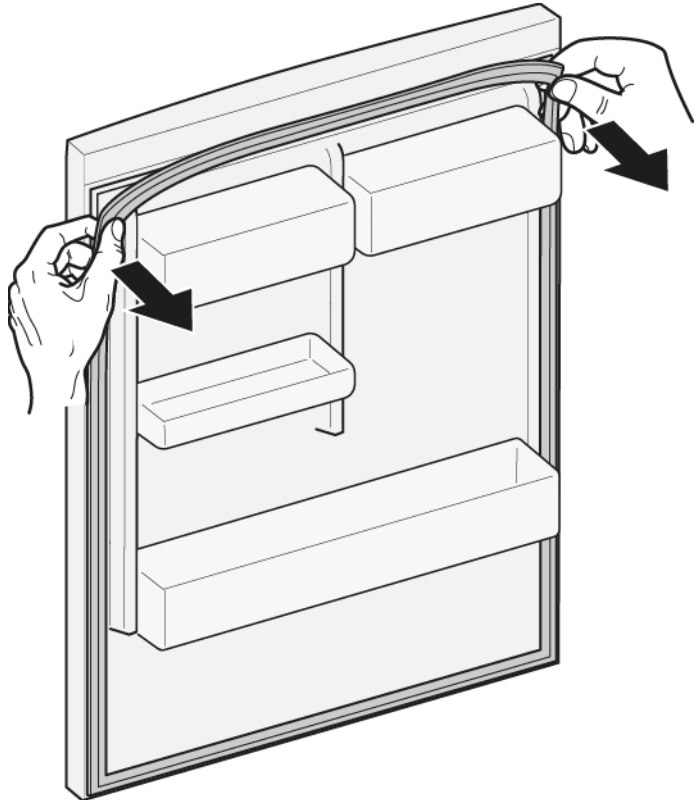

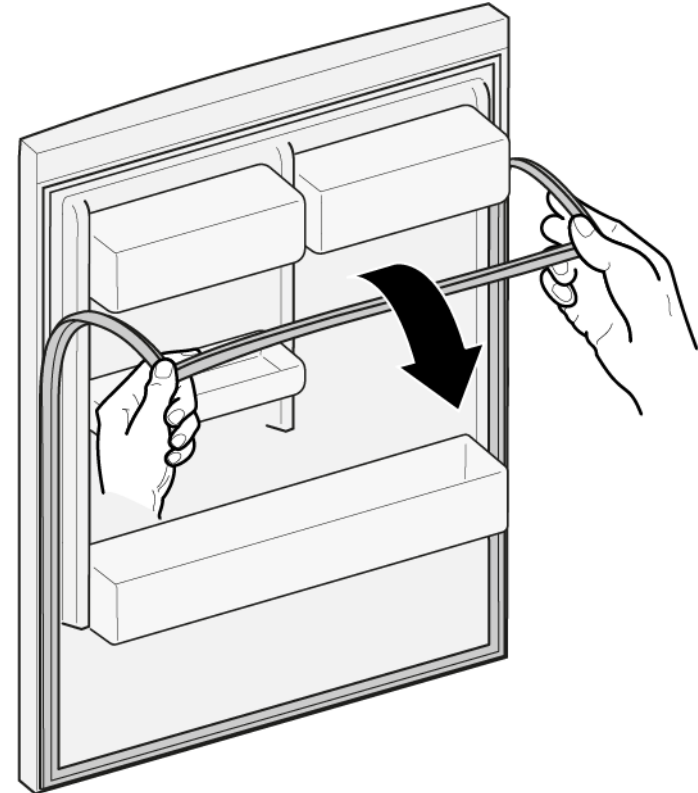

2. Sacar la junta de la puerta de la ranura.



- ➡ Se ha retirado la junta de la puerta.

4.1.2 Montar la junta de la puerta

	El grosor de la nueva junta de la puerta puede diferir ligeramente del grosor de la junta usada. Esto no afectará al comportamiento de cierre ni al funcionamiento a largo plazo.
	Si su aparato tienen bisagras ajustables o accesorios de bisagra, puede optimizar el comportamiento de cierre.
	Los pequeños agujeros laterales de la junta de la puerta son funcionales (necesarios para la ventilación). No se trata de un fallo de producción.

Reparación

1. Comprobar si la ranura de la junta presenta daños.

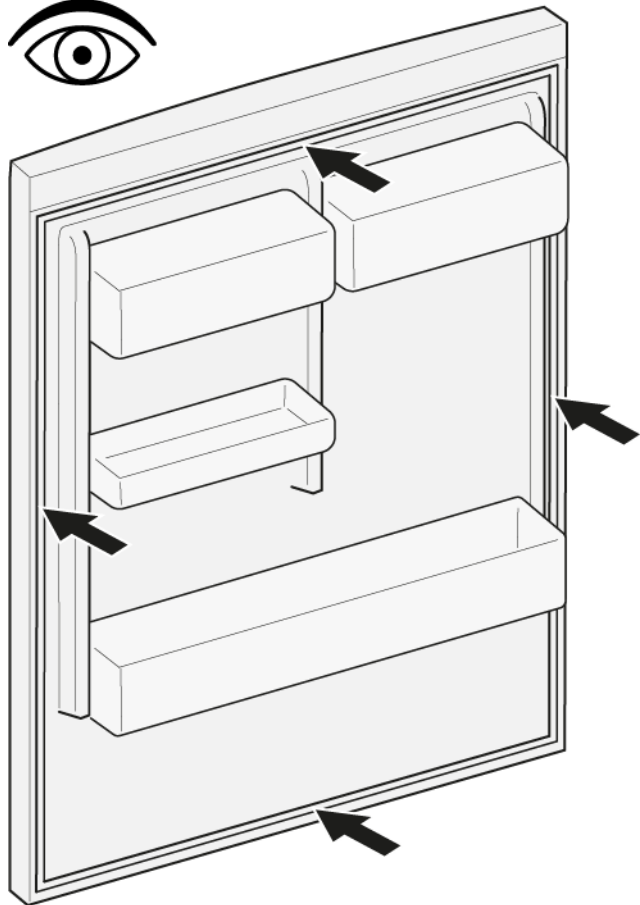

4. Presionar las esquinas de la junta en la parte superior y la inferior de la ranura.

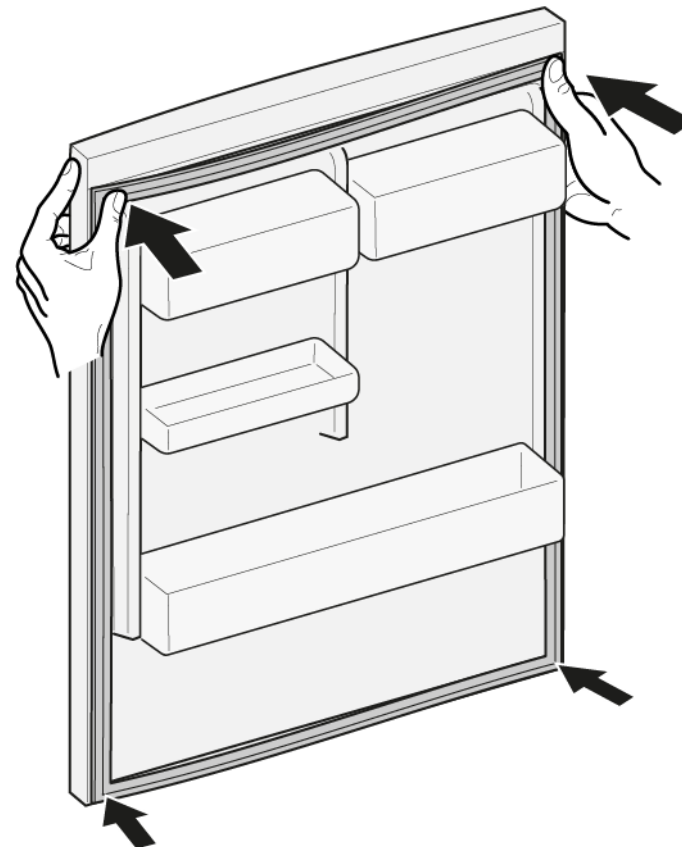

2.  Si la ranura de la junta está dañada.
- Contactar con el servicio de atención al cliente.

3.

	Una ligera deformación de la junta de la puerta es normal y no afecta a su función. Se recomienda alisar la junta de la puerta antes de insertarla en el aparato.
-------------------------------------------------------------------------------------	-------------------------------------------------------------------------------------------------------------------------------------------------------------------

Calentar ligeramente la junta de la puerta con un secador de pelo o agua caliente y volver a darle forma con las manos.

Reparación

5. Presionar metiendo toda la junta paso a paso en la ranura.

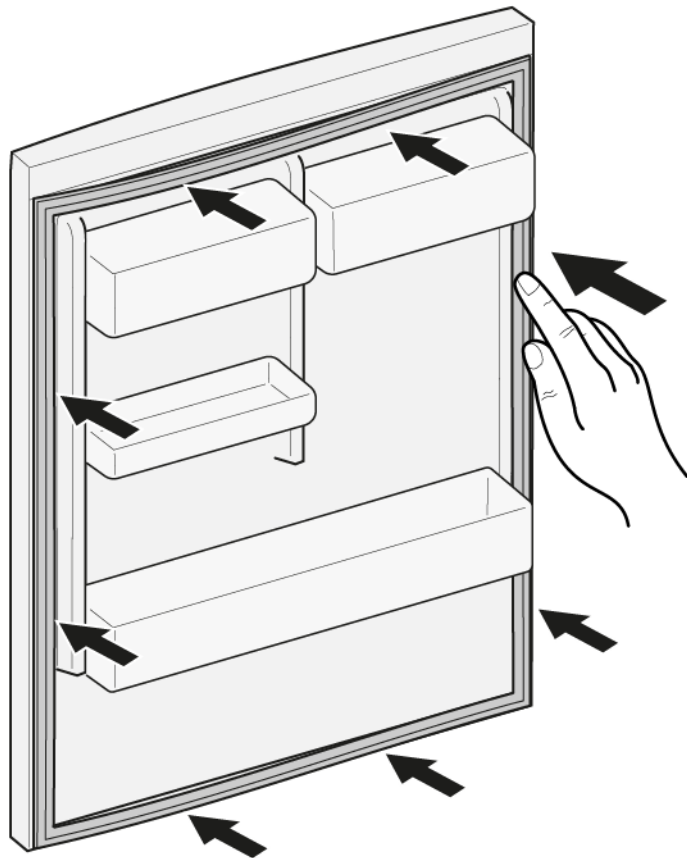



-  La junta de la puerta está montada.

4.2 Sustituir el tirador de la puerta

Herramientas necesarias:

-  Puntas llaves Allen hexagona- 2 mm, 2,5 mm, 3 mm, 4 mm, 5 mm, [00340819]
les 6 mm, 8 mm

Requisito:

-  El aparato está desconectado del suministro eléctrico.
-  La puerta está abierta.

4.2.1 Retirar el tirador de la puerta

1. Desatornillar los dos tornillos (1).
2. Retirar el tirador de la puerta (2).

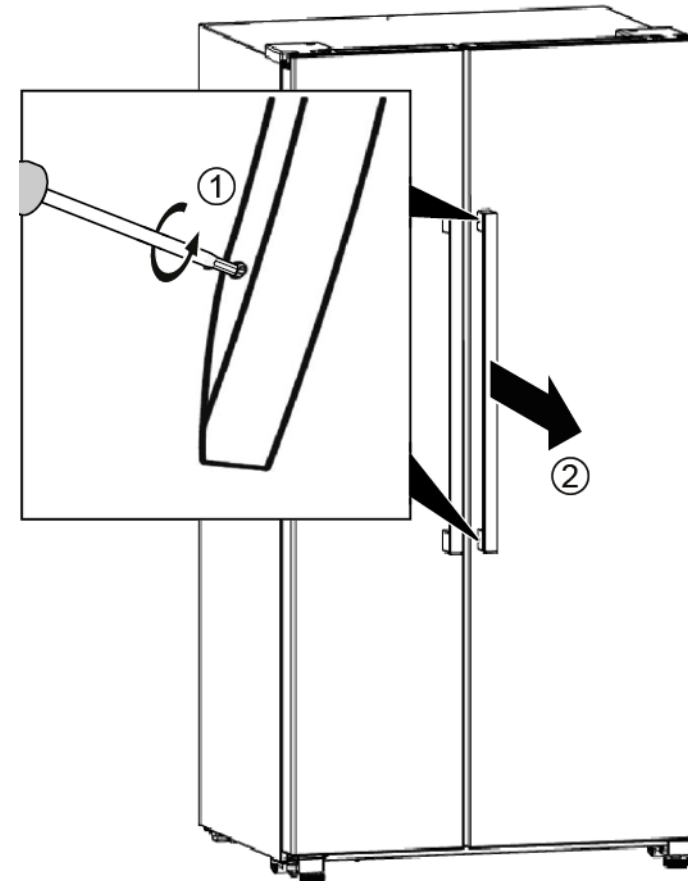

 Se ha retirado el tirador de la puerta.

2. Retirar el tirador de la segunda puerta del mismo modo.

4.2.2 Montar el tirador de la puerta

- ▶ Montar en orden inverso.

4.3 Sustituir el estante

Requisito:

- ✔ La puerta está abierta.

4.3.1 Extraer el estante

- ▶ Sacar el estante.

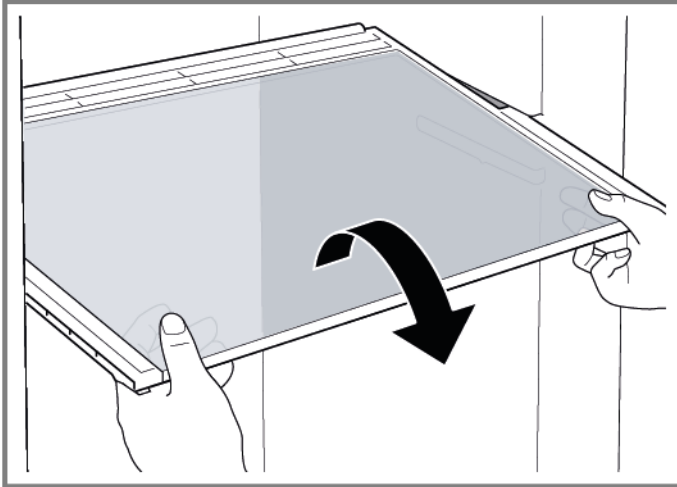

➡ Se ha retirado el estante.

4.3.2 Montar el estante

- ▶ Montar en orden inverso.

4.4 Sustituir la bandeja botellero

Requisito:

- ✔ La puerta está abierta.

4.4.1 Extraer la bandeja botellero

- ▶ Sacar la bandeja botellero.

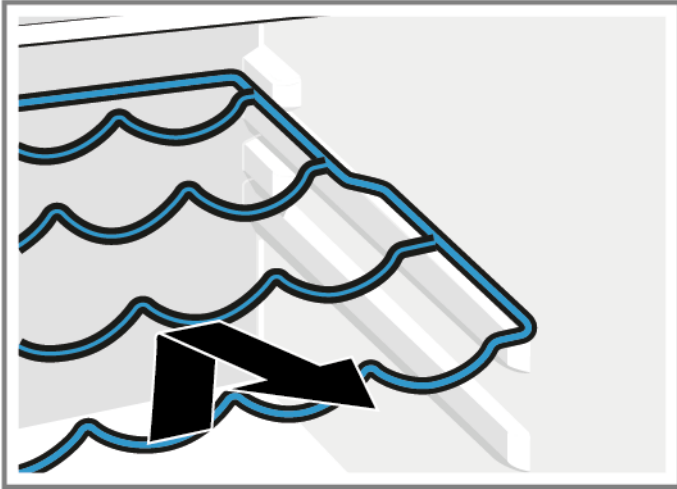

- ➡ Se ha retirado la bandeja botellero.

4.4.2 Montar la bandeja botellero

- ▶ Montar en orden inverso.

4.5 Sustituir el estante de la puerta

Requisito:

- ✔ La puerta está abierta.

4.5.1 Extraer el estante de la puerta

- ▶ Sacar hacia arriba el estante de la puerta.

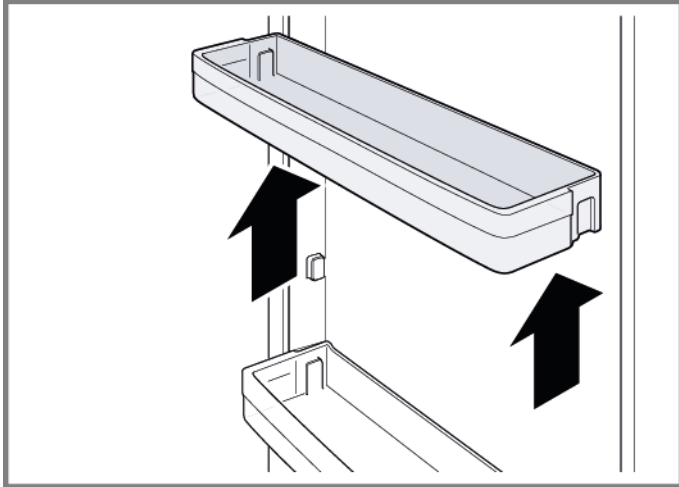

- ➡ Se ha retirado el estante de la puerta.

4.5.2 Montar el estante de la puerta

- ▶ Montar en orden inverso.

4.6 Sustituir cajóns

Requisito:

- ✔ La puerta está abierta.

4.6.1 Extraer cajóns

- ▶ Sacar por completo el cajón, levantarlo para desengancharlo del soporte y retirarlo.

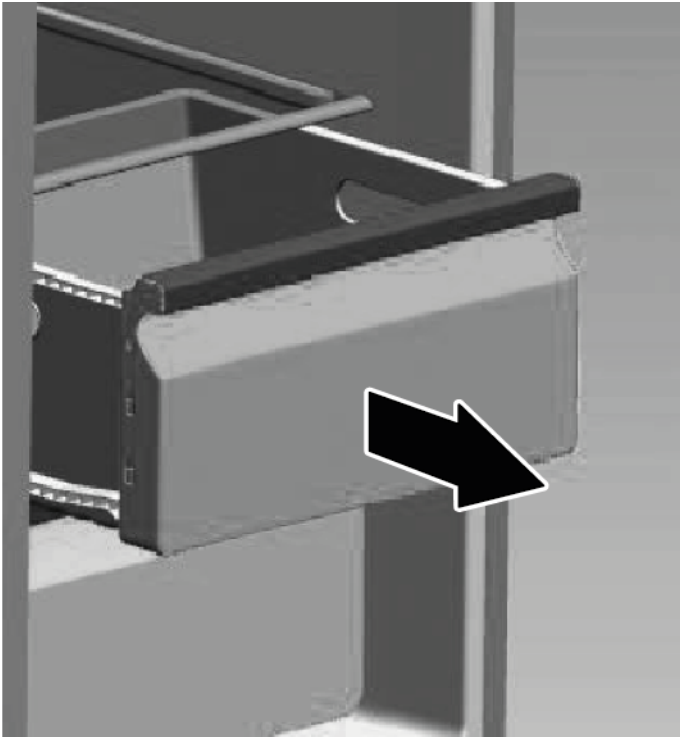

- ➡ Se ha retirado el cajón.

4.6.2 Montar cajóns

- ▶ Montar en orden inverso.

4.7 Sustituir la lámpara LED

i Su aparato cuenta con una iluminación LED exenta de mantenimiento. ¡Solo el servicio de atención al cliente o los técnicos autorizados pueden reparar esta iluminación!

⚠ PELIGRO
¡Riesgo de descarga eléctrica debido a piezas con tensión!
Peligro mortal por descarga eléctrica en caso de reparación inadecuada

- ▶ Las piezas eléctricas deberían ser reparadas por electricistas cualificados.
- ▶ Después de la reparación, encargar una prueba de seguridad conforme a VDE 0701 o los reglamentos específicos del país.

⚠ PRECAUCIÓN
¡Bordes o cantos cortantes!
Peligro de cortes

- ▶ Usar guantes de seguridad.

Requisito:

- ✔ El aparato está desconectado del suministro eléctrico.
- ✔ La puerta está abierta.
- ✔ Se ha retirado el estante superior.

4.7.1 Desmontar la lámpara LED

1. Sujetar la tapa de la lámpara LED con las dos manos y tirar hacia abajo.



- ➡ Se ha retirado la tapa de la lámpara LED.



2. Tirar y retirar lámpara LED.



3. Desenchufar el terminal.



- ➡ Se ha retirado la lámpara LED.

4.7.2 Montar la lámpara LED

- ▶ Montar en orden inverso.

Reparationsinformation - Kyl-/ fryskombination

 Om detta dokument	333
1.1 Viktig information.....	333
1.1.1 Syfte	333
1.2 Symbolförklaringar.....	333
1.2.1 Faronivåer	333
1.2.2 Risksymboler.....	333
1.2.3 Varningarnas struktur.....	334
1.2.4 Allmänna symboler.....	334
 Säkerhet	335
2.1 Allmänna säkerhetsanvisningar.....	335
2.1.1 Alla hushållsmaskiner.....	335
 Verktyg och hjälpmedel	336
 Reparation	337
4.1 Byta dörrpackning.....	337
4.1.1 Ta bort dörrpackning	337
4.1.2 Montera dörrpackning	337
4.2 Byta dörrhandtag.....	340
4.2.1 Ta bort dörrhandtag	340
4.2.2 Montera dörrhandtag.....	340
4.3 Byta hylla	341
4.3.1 Ta bort hylla.....	341
4.3.2 Montera hylla.....	341
4.4 Byta flaskhylla	342
4.4.1 Ta bort flaskhylla.....	342
4.4.2 Montera flaskhylla	342
4.5 Byta dörrhylla	343
4.5.1 Ta bort dörrhylla.....	343
4.5.2 Montera dörrhylla	343
4.6 Byta fack.....	344
4.6.1 Ta bort fack	344
4.6.2 Montera fack.....	344
4.7 Byta LED-lampa	345
4.7.1 Ta bort LED-lampa.....	345
4.7.2 Montera LED-lampa	346

i Om detta dokument

1.1 Viktig information

1.1.1 Syfte

Dessa reparationstips hjälper kunden att själv reparera maskiner enligt gällande ekodesignbestämmelser (som gäller 03/2021).





De innehåller information om hur vissa reservdelar ska bytas samt tillhörande varningar och risker.

Kontakta vår kundtjänst om du har frågor. Vi åtar oss bara ansvar för skador om reparationstipsen har följts korrekt.

1.2 Symbolförklaringar

1.2.1 Faronivåer

Varningsnivåerna består av en symbol och ett signalord. Signalordet visar hur allvarlig faran är.





Varningsnivå	Innebörd
	Om inte varningsmeddelandet följs kommer det att leda till dödsfall eller allvarliga personskador.
	Om inte varningsmeddelandet följs kan det leda till dödsfall eller allvarliga personskador.
	Om inte varningsmeddelandet följs kan det leda till lättare personskador.
	Om inte varningsmeddelandet följs kan det leda till materialskador.

Grafik 1: Faronivåer



1.2.2 Risksymboler

Risksymboler är symboler som visar typen av fara.

Följande risksymboler används i detta dokument:

Risksymbol	Innebörd
	Allmänt varningsmeddelande
	Fara på grund av elektrisk spänning
	Explosionsrisk
	Fara för skärskador
	Fara för krosskador

i Om detta dokument

Risksymbol	Innebörd
	Fara på grund av heta ytor
	Fara på grund av starka magnetfält
	Fara på grund av icke-joniserande strålning

Grafik 2: Risksymboler

1.2.3 Varningarnas struktur

Varningar i detta dokument har ett standardiserat utseende och en standardiserad struktur.



	 FARA! Farans typ och ursprung! Möjliga konsekvenser av att faran/varningen ignoreras. ▶ Åtgärder och förbud för att förebygga faran.
----------------------------------------------------------------------------------	-----------------------------------------------------------------------------------------------------------------------------------------------------------------------------------------------------------------------------------------------





Följande exempel visar en varning som varnar för elstötar från strömförande delar. Det står vilken åtgärd som förebygger faran.

	 FARA! Risk för elstötar på grund av strömförande delar! Dödsfall på grund av elstötar ▶ Koppla bort maskiner från elförsörjningen minst 60 sekunder innan reparationer påbörjas.
-----------------------------------------------------------------------------------	--------------------------------------------------------------------------------------------------------------------------------------------------------------------------------------------------------------------------------------------------------------------------------------------

1.2.4 Allmänna symboler

Följande allmänna symboler används i detta dokument:

Allm. symbol	Innebörd
	Identifiering av ett särskilt tips (text och/eller bild)
	Identifiering av ett enkelt tips (endast text)

Allm. symbol	Innebörd
	Identifiering av en länk till en videohandledning
	Identifiering av verktyg som behövs
	Identifiering av villkor som måste vara uppfyllda
	Identifiering av ett tillstånd (om ..., så ...)
	Identifiering av ett resultat
[Start]	Identifiering av en tangent eller knapp
[00123456]	Identifiering av ett materialnummer
Status	Identifiering av text/fönster som visas (i maskinens display)

Grafik 3: Allmänna symboler

2.1 Allmänna säkerhetsanvisningar

2.1.1 Alla hushållsmaskiner

Risk för elstötar på grund av strömförande delar!

- Fel vid reparationer som berör elkomponenter kan orsaka elstötar!
- Koppla bort maskinen från elnätet minst 60 sekunder innan arbetet påbörjas.
- Låt utföra ett säkerhetstest efter reparationen, i enlighet med VDE 0701 eller landsspecifika regler.

Risk för personskador på grund av vassa kanter!

- Använd skyddshandskar.

Risk för krosskador vid reparation, underhåll, felsökning och service på grund av tunga och rörliga komponenter

- Använd skyddsskor.
- Säkra tunga komponenter så att de inte faller ner.
- Stick inte in kroppsdelar i rörliga komponenter.



Risk för maskinens säkerhet/funktion!

- Använd endast originaldelar.

Risk för skador på komponenter känsliga för statisk elektricitet (ESD)!

- Rör inte modulerna samt anslutningar och strömförande ledningar.

Verktvg och hj4lpmedel

Beteckning	Detaljer	Bilder
Skyddstrasa [00342013]	60 cm x 50 cm	
Hylsnycklar sexkant [00340819]	2 mm, 2,5 mm, 3 mm, 4 mm, 5 mm, 6 mm, 8 mm	

4.1 Byta dörrpackning

Förutsättning:

- ✔ Dörren är öppen.

4.1.1 Ta bort dörrpackning

1. Lossa dörrpackningen från spåret i högra och vänstra hörnet.

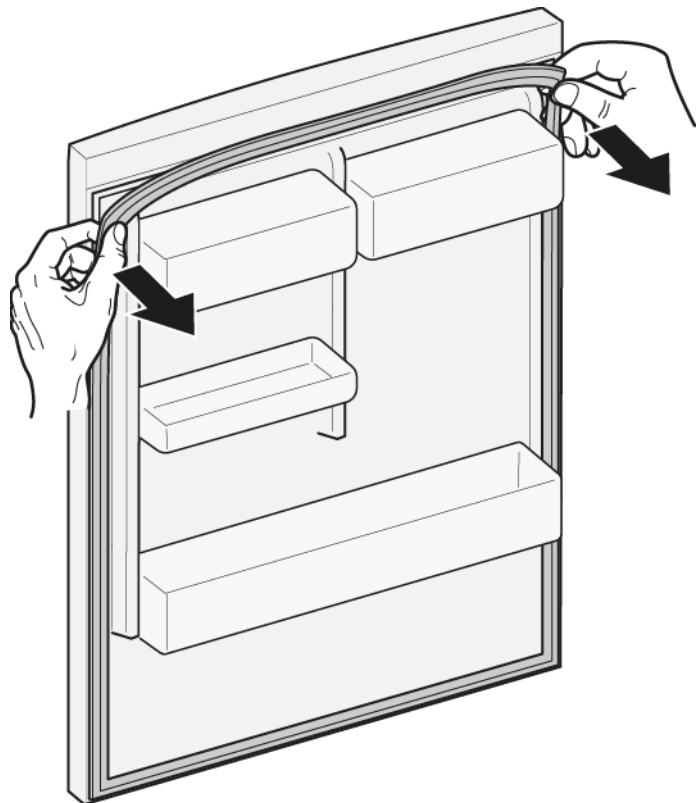

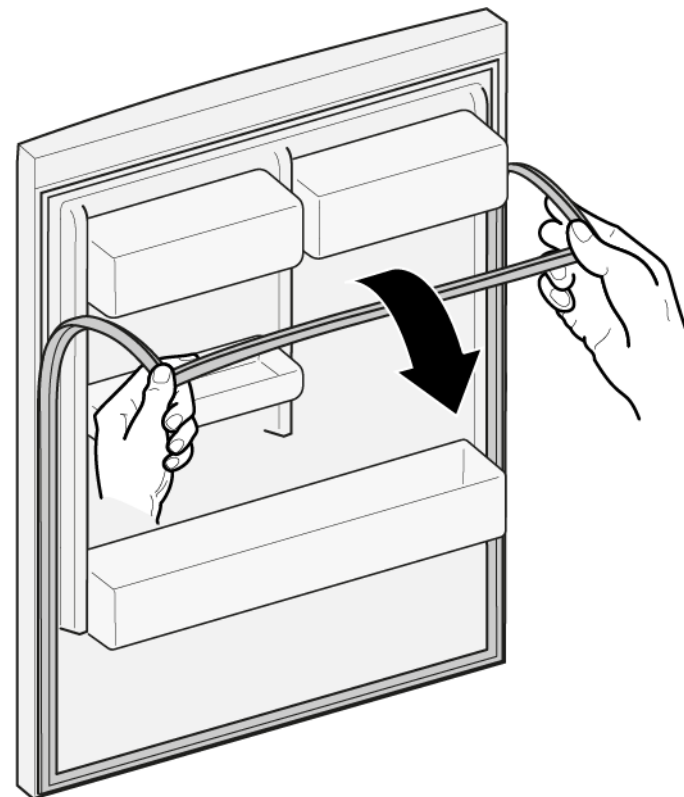

2. Dra ut dörrpackningen från spåret.



- ➡ Dörrpackningen har tagits bort.

4.1.2 Montera dörrpackning

	Den nya dörrpackningens tjocklek kan avvika något från den gamla dörrpackningens tjocklek. Detta kommer inte påverka stängningsegenskaperna eller funktionen långsiktigt.
	Om apparaten har justerbara gångjärn eller gångjärnsfästen kan du optimera stängningsegenskaperna senare.
	Små sidohål i dörrpackningen fyller en funktion (krävs för ventilation). Dessa utgör inga tillverkningsfel.

Reparation

1. Kontrollera om spåret för packningen har skador.

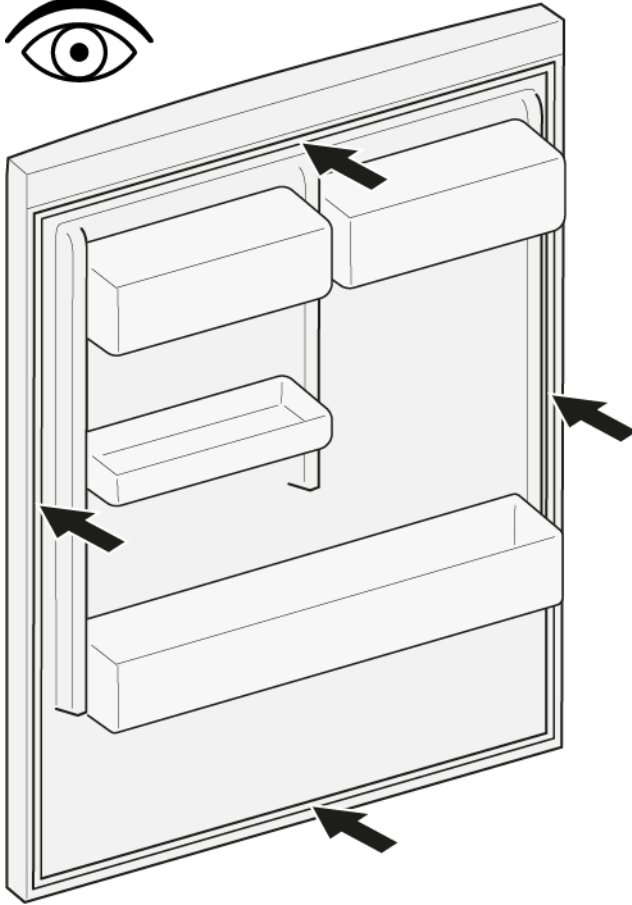

4. Tryck in packningens hörn längst upp och längst ner i spåret.

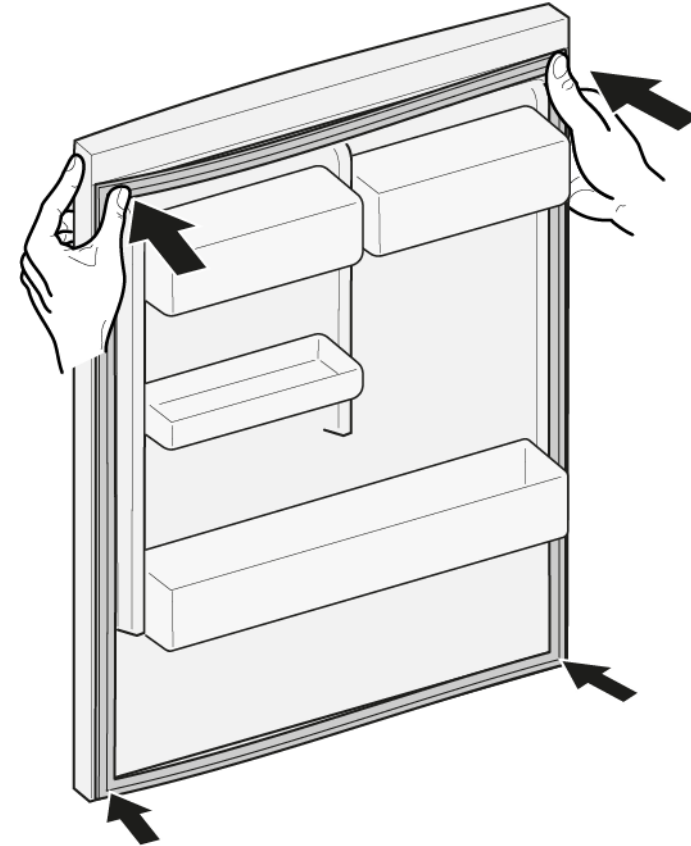

2.  Om spåret för packningen är skadat:
 - Kontakta kundtjänst.

3.  Viss deformation av dörrpackningen är normalt och påverkar inte packningens funktion. Det rekommenderas att man sträcker dörrpackningen innan den sätts in i apparaten.

Värm dörrpackningen med en hårtork eller hett vatten och forma om den med händerna.

Reparation

5. Tryck in hela packningen i spåret bit för bit.

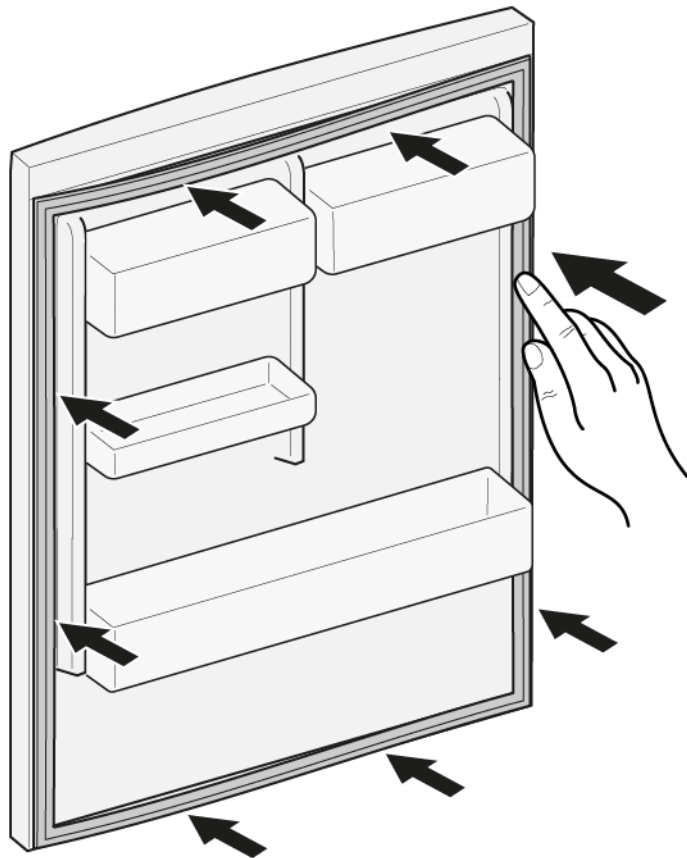



 Dörrpackningen är monterad.

4.2 Byta dörrhandtag

Nödvändiga verktyg:

 Hylsnycklar sexkant 2 mm, 2,5 mm, 3 mm, 4 mm, 5 mm, 6 mm, 8 mm [00340819]

Förutsättning:

-  Apparaten är bortkopplad från strömförsörjning.
-  Dörren är öppen.

4.2.1 Ta bort dörrhandtag

1. Skruva ur de två skruvarna (1).
2. Ta bort dörrhandtaget (2).

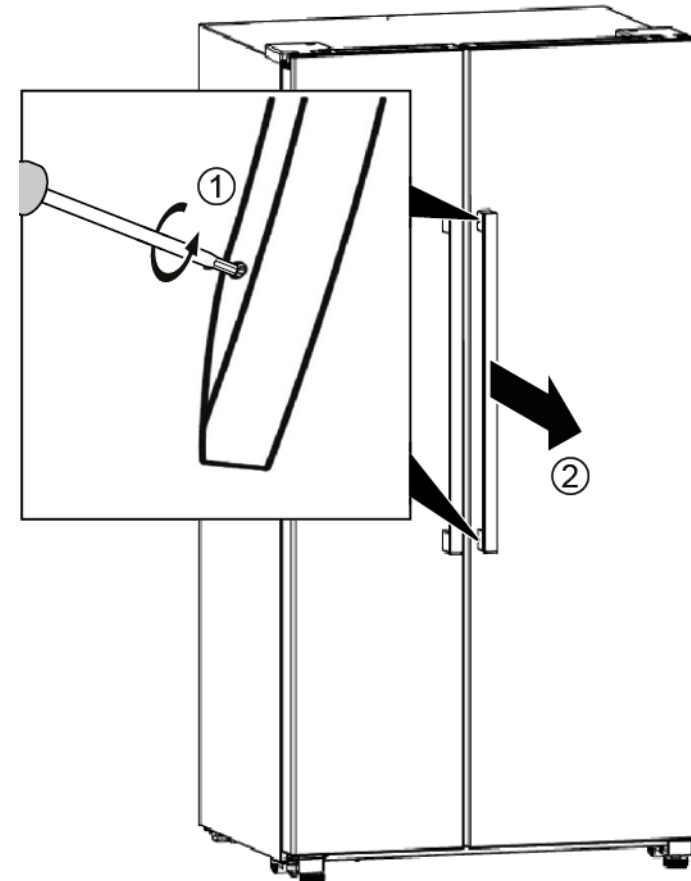

 Dörrhandtaget har tagits bort.

2. Ta bort dörrhandtaget för den andra dörren på samma sätt.

4.2.2 Montera dörrhandtag

- ▶ Montera i omvänd ordning.

4.3 Byta hylla

Förutsättning:

- ✔ Dörren är öppen.

4.3.1 Ta bort hylla

- ▶ Dra ut hyllan.

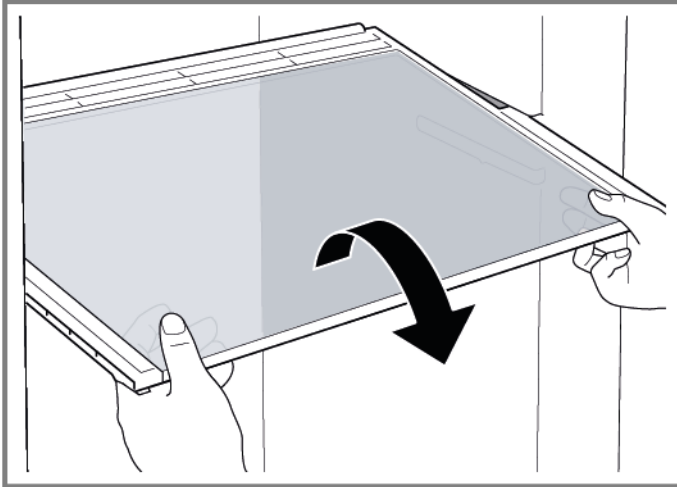

- ➡ Hyllan har tagits bort.

4.3.2 Montera hylla

- ▶ Montera i omvänd ordning.

4.4 Byta flaskhylla

Förutsättning:

- ✓ Dörren är öppen.

4.4.1 Ta bort flaskhylla

- ▶ Dra ut flaskhyllan.

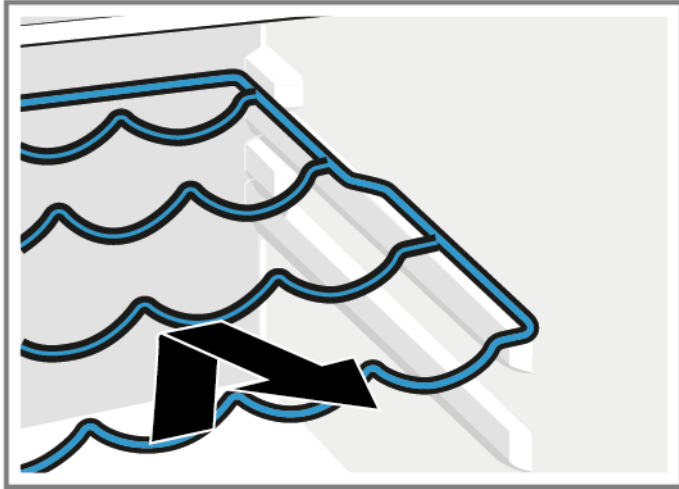

- ➡ Flaskhyllan har tagits bort.

4.4.2 Montera flaskhylla

- ▶ Montera i omvänd ordning.

4.5 Byta dörrhylla

Förutsättning:

- ✔ Dörren är öppen.

4.5.1 Ta bort dörrhylla

- ▶ Lyft dörrhyllan uppåt.

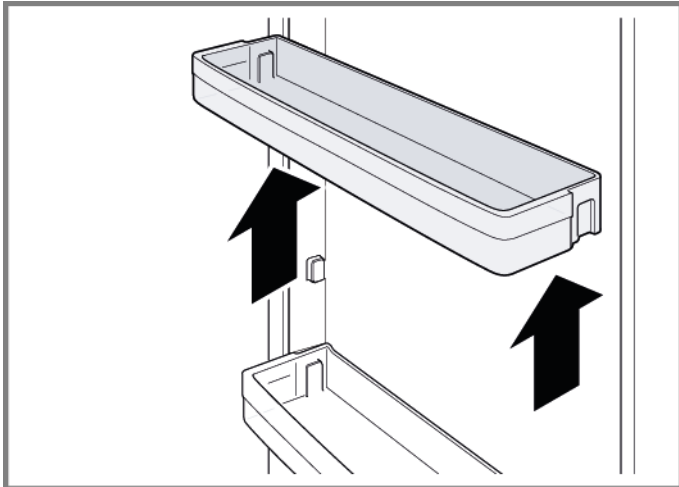

- ➡ Dörrhyllan har tagits bort.

4.5.2 Montera dörrhylla

- ▶ Montera i omvänd ordning.

4.6 Byta fack

Förutsättning:

- ✔ Dörren är öppen.

4.6.1 Ta bort fack

- ▶ Dra ut facket helt, lyft upp det så att det lossnar från hållaren och ta ut det.

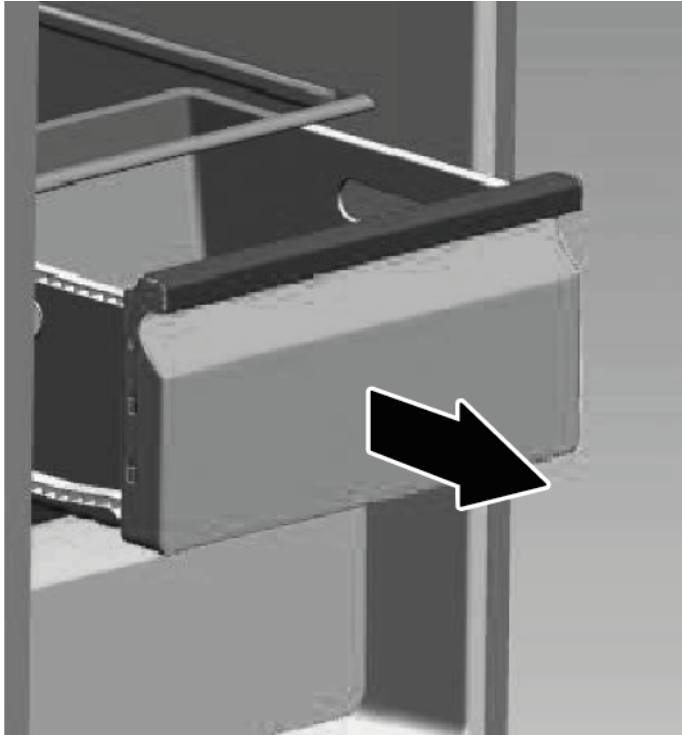

- ➡ Facket har tagits bort.

4.6.2 Montera fack

- ▶ Montera i omvänd ordning.

4.7 Byta LED-lampa



Din apparat har en underhållsfri LED-lampa.
Dessa lampor får endast bytas av kundtjänst eller auktoriserade tekniker!



FARA!

Risk för elstötar på grund av strömförande delar!

Livsfara på grund av elstötar vid felaktiga reparationer

- ▶ Elektriska delar ska repareras av behörig elektriker.
- ▶ Låt utföra ett säkerhetstest efter reparationen, i enlighet med VDE 0701 eller landsspecifika regler.



FÖRSIKTIGT!

Vassa kanter!

Skärskador

- ▶ Använd skyddshandskar.

Förutsättning:

- ✓ Apparaten är bortkopplad från strömförsörjning.
- ✓ Dörren är öppen.
- ✓ Den övre hyllan har tagits bort.

4.7.1 Ta bort LED-lampa

1. Ta tag i LED-lamphöljet med båda händerna och dra nedåt



- ➡ LED-lamphöljet har tagits bort.



2. Dra i och ta ut LED-lampan



3. Koppla loss kontakten



- ➡ LED-lampan har tagits bort.

4.7.2 Montera LED-lampa

- ▶ Montera i omvänd ordning.

Onarım İpuçları - Soğutucu/Dondurucu kombine cihazı

 Bu doküman hakkında	348
1.1 Önemli bilgi	348
1.1.1 Amacı.....	348
1.2 Sembollerinin açıklaması	348
1.2.1 Tehlike kademeleri	348
1.2.2 Tehlike sembolleri	348
1.2.3 İkaz bilgilerinin yapısı	349
1.2.4 Genel semboller.....	349
 Güvenlik	350
2.1 Genel Güvenlik bilgileri	350
2.1.1 Tüm ev gereçleri	350
 Ekipman ve yardım	351
 Onarım	352
4.1 Kapı contasının değiştirilmesi	352
4.1.1 Kapı contasının çıkartılması	352
4.1.2 Kapı contasının takılması	352
4.2 Kapı tutamağının değiştirilmesi.....	355
4.2.1 Kapı tutamağının çıkartılması	355
4.2.2 Kapı tutamağının takılması	355
4.3 Raf yüzeyinin değiştirilmesi	356
4.3.1 Raf yüzeyinin çıkartılması	356
4.3.2 Raf yüzeyinin takılması.....	356
4.4 Şişe rafının değiştirilmesi	357
4.4.1 Şişe rafının çıkartılması	357
4.4.2 Şişe rafının takılması.....	357
4.5 Kapı rafının değiştirilmesi	358
4.5.1 Kapı rafının çıkartılması.....	358
4.5.2 Kapı rafının takılması	358
4.6 Kapların değiştirilmesi.....	359
4.6.1 Kapların çıkartılması	359
4.6.2 Kapların takılması	359
4.7 LED lambanın değiştirilmesi	360
4.7.1 LED lambanın çıkartılması.....	360
4.7.2 LED lambanın takılması	361

i Bu doküman hakkında

1.1 Önemli bilgi

1.1.1 Amacı

Bu onarım ipuçları, tüketicinin cihazları, geçerli eko-tasarım yönetmeliğine göre (03/2021 itibarıyla) kendi başına onarması için destek sunar.

İpuçları, tanımlanmış yedek parçaların nasıl değiştirilmesi gerektiğine dair bilgiler, uyarılar ve söz konusu riskleri içerir.

Sorularınız varsa, lütfen yetkili servisimizle irtibata geçiniz. Yalnızca onarım ipuçlarına gerektiği gibi uyulduğu takdirde hasarlar için sorumluluk üstleniriz.

1.2 Sembollerinin açıklaması

1.2.1 Tehlike kademeleri

Tehlike kademeleri bir sembolden ve bir sinyal kelimesinden oluşur. Sinyal kelimesi tehlikenin şiddetini ve önemini tanımlar.





Tehlike kademesi	Anlamı
 TEHLİKE	İkaz bilgisinin dikkate alınmaması ölüme veya ağır yaralanmalara sebep olur.
 UYARI	İkaz bilgisinin dikkate alınmaması ölüme veya ağır yaralanmalara sebep olabilir.
 DİKKAT	İkaz bilgisinin dikkate alınmaması hafif yaralanmalara sebep olabilir.
DİKKATI	İkaz bilgisinin dikkate alınmaması maddi hasarların oluşmasına sebep olabilir.

Tablo 1: Tehlike kademeleri



1.2.2 Tehlike sembolleri

Tehlike sembolleri, tehlike türü hakkında bilgi veren anlamlı resimsel gösterimlerdir.

Bu dokümanda aşağıdaki tehlike sembolleri kullanılmıştır:

Tehlike sembolü	Anlamı
	Genel ikaz bilgisi
	Elektrik geriliminden kaynaklanan tehlike
	Patlamadan kaynaklanan tehlike
	Kesmeden dolayı yaralanma tehlikesi
	Sıkışıp ezilmeden dolayı yaralanma tehlikesi

i Bu doküman hakkında

Tehlike sembolü	Anlamı
	Sıcak yüzeylerden kaynaklanan tehlike
	Güçlü elektromanyetik alan tehlikesi
	İyonizasyon olmayan ışınlardan kaynaklanan tehlike

Tablo 2: Tehlike sembolleri

1.2.3 İkaz bilgilerinin yapısı

Bu dokümandaki ikaz bilgilerinin standart olarak görünüşü ve yapısı aynıdır.



	⚠ TEHLİKE Tehlikenin türü ve kaynağı!! Tehlike / ikaz bilgisinin dikkate alınmamasının sonucu. ► Tehlikeye karşı korunmak için yapılacak işlem ve yasaklar.
----------------------------------------------------------------------------------	------------------------------------------------------------------------------------------------------------------------------------------------------------------------------------







Aşağıdaki örnekte, gerilim ileten parçalar nedeniyle oluşabilecek elektrik çarpması tehlikesi hakkında uyarıda bulunan bir ikaz bilgisi gösterilmiştir. Tehlikeyi önlemek için alınması gereken önlemler belirtilmiştir.

	⚠ TEHLİKE Gerilim ileten parçalar nedeniyle elektrik çarpması tehlikesi!! Elektrik çarpması sebebiyle ölüm ► Onarıma başlamadan önce cihazın elektrik şebeke bağlantısını en az 60 saniye süreyle sökün.
-----------------------------------------------------------------------------------	---------------------------------------------------------------------------------------------------------------------------------------------------------------------------------------------------------------------------------

1.2.4 Genel semboller

Bu dokümanda aşağıdaki genel semboller kullanılmıştır:

Genel sembol	Anlamı
	Özel ipucu işareti (metin ve/veya grafik)
	Basit ipucu işareti (yalnızca metin)
	Video linki işareti

Genel sembol	Anlamı
	Gerekli araçlar işareti
	Ön koşulların işareti
	Koşul işareti (... olursa olur)
	Sonuç işareti
	Tuş veya düğme işareti
	Malzeme numarası işareti
	Gösterilen yazı / ekran işareti (cihaz ekranındaki)

Tablo 3: Genel semboller

2.1 Genel Güvenlik bilgileri

2.1.1 Tüm ev gereçleri

Gerilim ileten parçalar nedeniyle elektrik çarpması tehlikesi!

- Elektrikli bileşenlerde yapılan onarımlarda hatalar, elektrik çarpmasına neden olabilir!
- Cihaz çalışmalara başlamadan en az 60 saniye önce elektrik şebekesinden ayrılmalıdır.
- Onarım sonrasında VDE 0701 veya ülkeye özel düzenlemeler uyarınca bir güvenlik testi gerçekleştirilmelidir.

Keskin kenarlar nedeniyle yaralanma tehlikesi!

- Koruyucu eldiven kullanılmalıdır.

Ağır ve hareketli parçaların onarım, bakım, hata arama ve servis işlemlerinde yaratabileceği ezilme riskleri

- Koruyucu ayakkabı giyin.
- Yere düşmemesi için ağır parçaları emniyete alın.
- Hareketli parçaların arasına gövde parçaları koymayın.



Cihaz güvenliğinde / fonksiyonda tehlike!

- Yalnızca orijinal parçalar kullanılmalıdır.

Elektrostatik hassasiyeti olan bileşenlerde hasar tehlikesi (ESD)!

- Bağlantılar ve iletken yolları da dahil olmak üzere modüllere dokunmayın.

Ekipman ve yardım

Tanımlama	Detaylar	Görüntüler
Koruyucu bez [00342013]	60 cm x 50 cm	
Altıgen lokma anahtarlar [00340819]	2 mm, 2,5 mm, 3 mm, 4 mm, 5 mm, 6 mm, 8 mm	

4.1 Kapı contasının değiştirilmesi

Ön koşul:

- ✓ Kapı açık.

4.1.1 Kapı contasının çıkartılması

1. Kapı contasını sağ ve sol köşedeki oluklardan kurtarın.

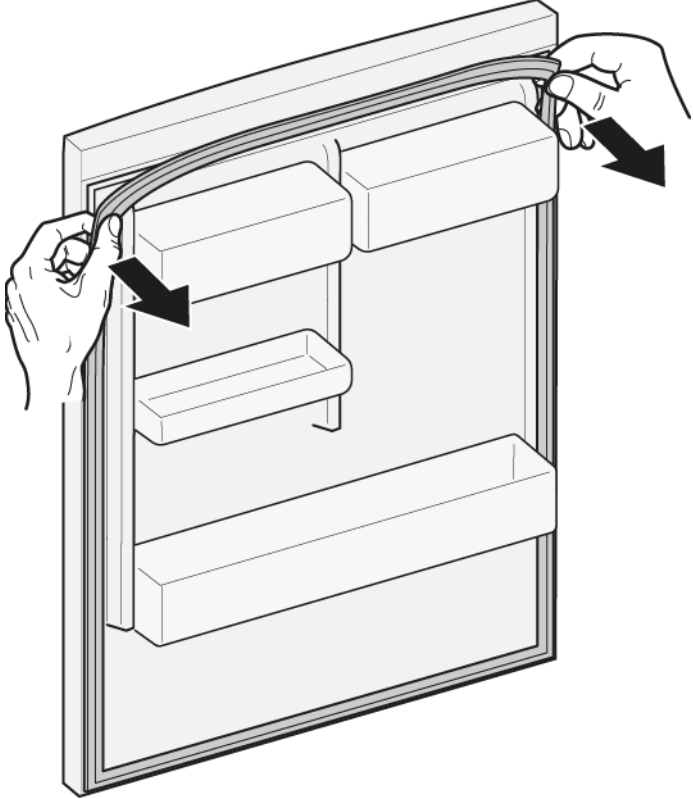

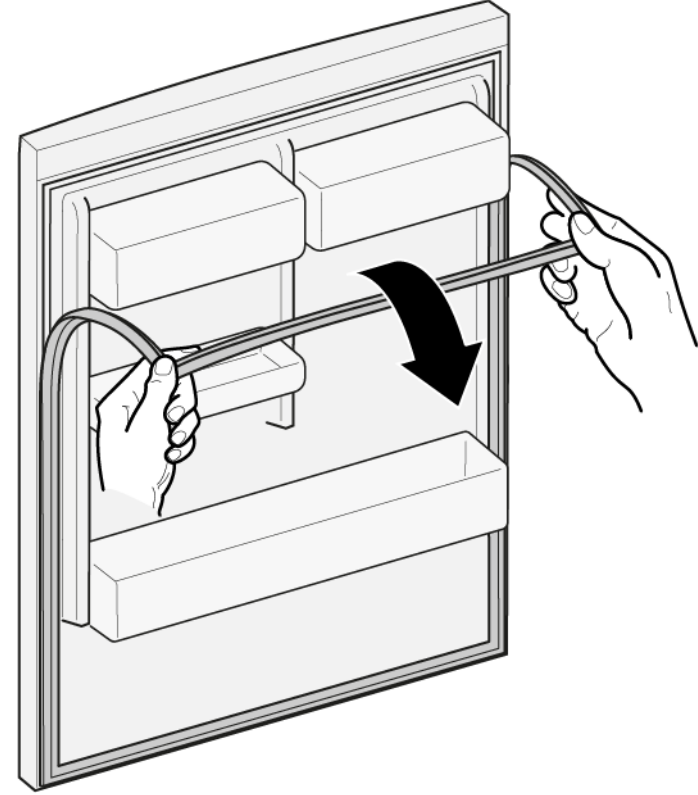

2. Kapı contasını oluktan dışarı çekin.



- ➡ Kapı contası çıkartılmıştır.

4.1.2 Kapı contasının takılması

	Yeni kapı contasının kalınlığı, eski kapı contasının kalınlığından biraz farklı olabilir. Bu, kapının kapanma özelliğini ve uzun süreli işlevini etkilemez.
	Cihazınızda ayarlanabilir menteşeler veya menteşe ekleri varsa, kapının kapanma özelliğini daha sonra optimize edebilirsiniz.
	Kapı contasındaki küçük yan delikler işlevseldir (havalandırma için gereklidir). Bunlar üretim hatası değildir.

1. Conta için oluğu hasar bakımından kontrol edin.

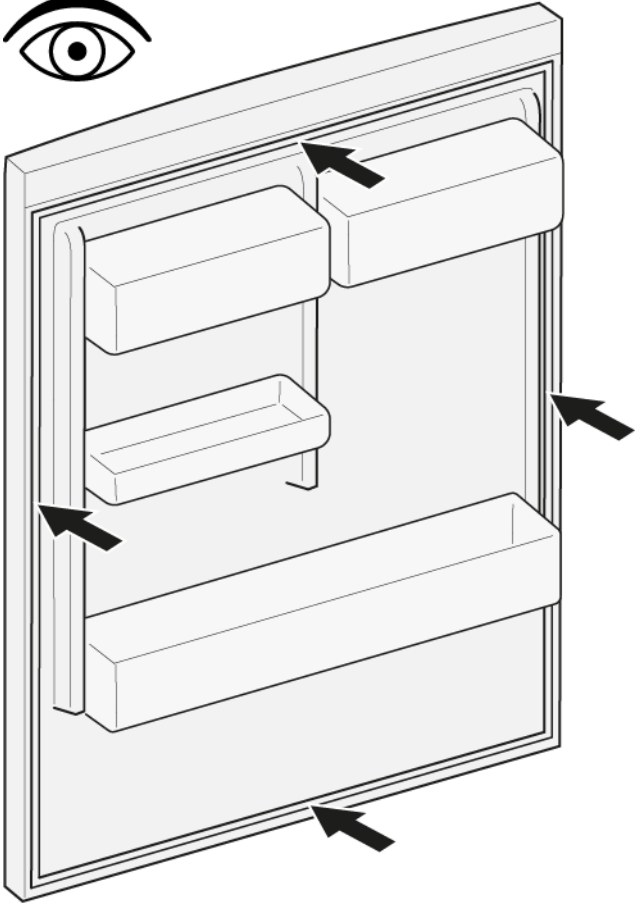

4. Contanın köşelerini üstten ve alttan oluğa itin.

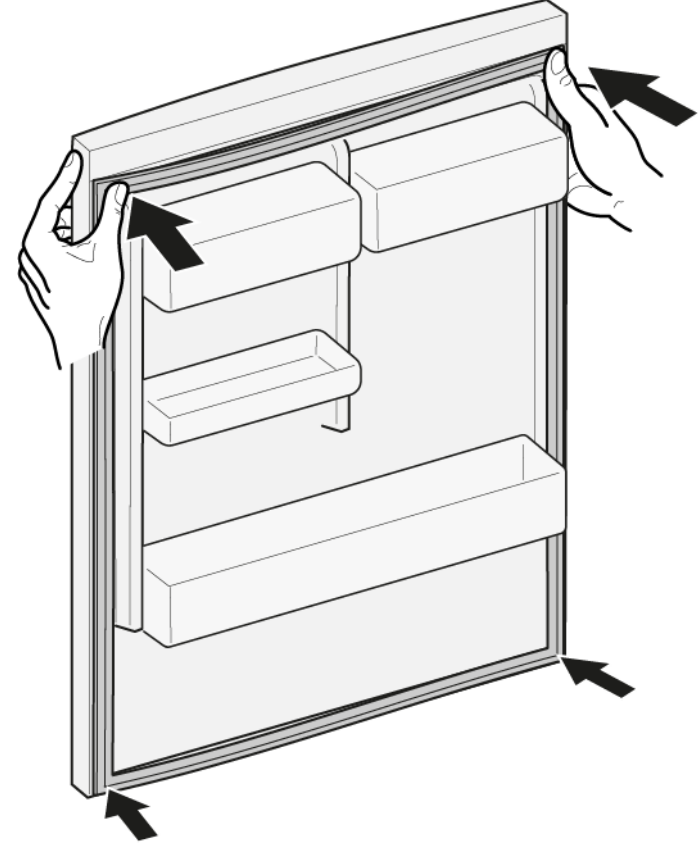



2.  Conta için oluk hasarlı ise,
- Müşteri hizmetleriyle irtibata geçin.

3.  Kapı contasında hafif deformasyon normaldir ve contanın işlevini etkilemez. Kapı contasını cihaza yerleştirmeden önce contanın düzleştirilmesi önerilir.

Kapı contasını bir saç kurutma makinesi veya sıcak suyla ısıtın ve manuel olarak şekillendirin.

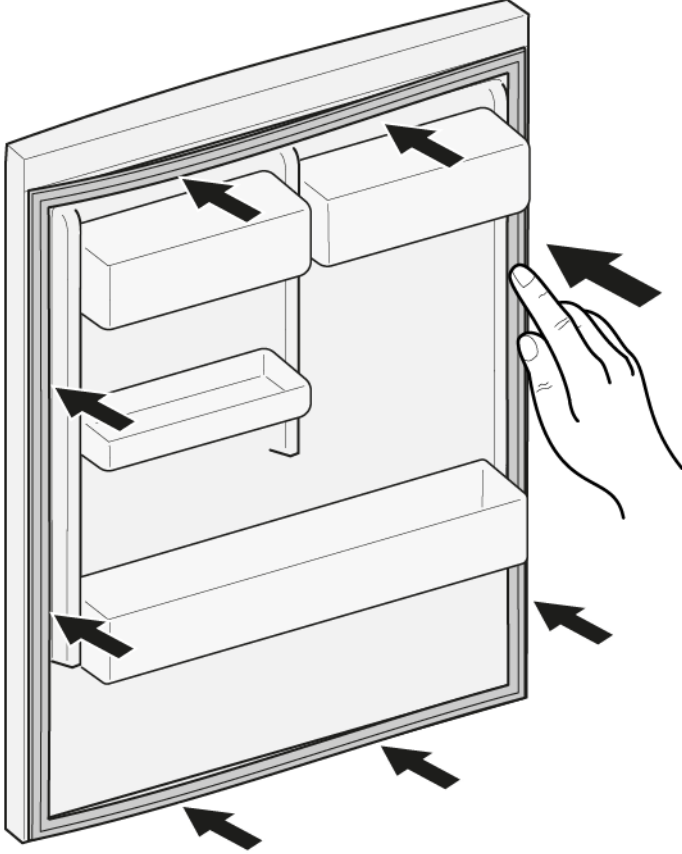
5. Contanın tamamını adım adım oluğun içine bastırın.



 Kapı contası takılmıştır.

4.2 Kapı tutamağının değiştirilmesi

Özel yardımcı ekipman:

Altıgen lokma anahtarlar 2 mm, 2,5 mm, 3 mm, 4 mm, 5 mm, 6 mm, 8 mm [00340819]

Ön koşul:

- ✓ Cihazın fişi çekilir.
- ✓ Kapı açık.

4.2.1 Kapı tutamağının çıkartılması

1. Vidaları sökün (1).
2. Kapı tutamağını çıkartın (2).

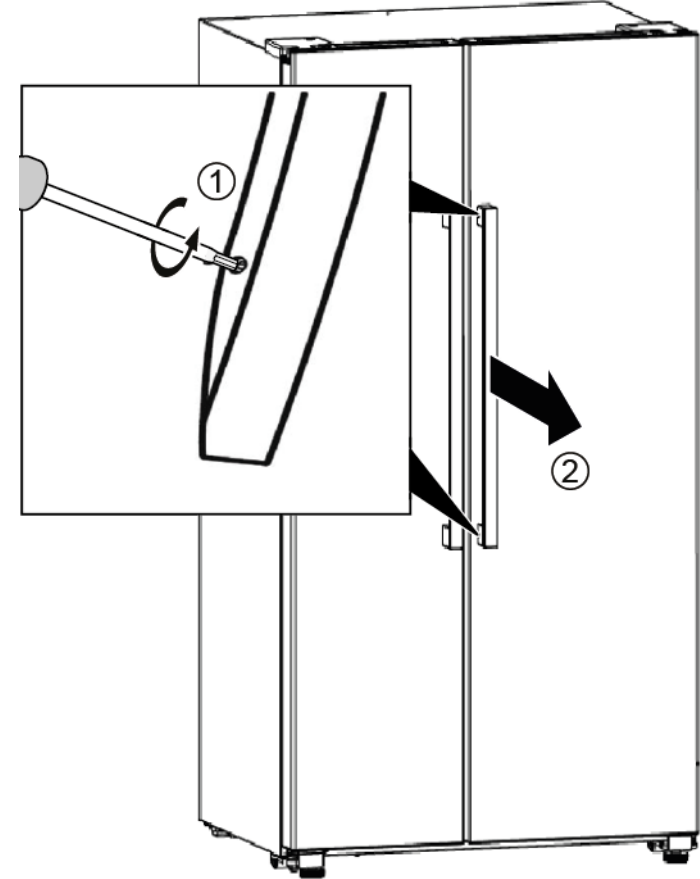

➡ Kapı tutamağı çıkartılmıştır.

2. İkinci kapı tutamağını da aynı şekilde çıkartın.

4.2.2 Kapı tutamağının takılması

- ▶ Ters sıra ile monte edin.

4.3 Raf yüzeyinin değiştirilmesi

Ön koşul:

- ✔ Kapı açık.

4.3.1 Raf yüzeyinin çıkartılması

- ▶ Raf yüzeyini dışarı çekin.

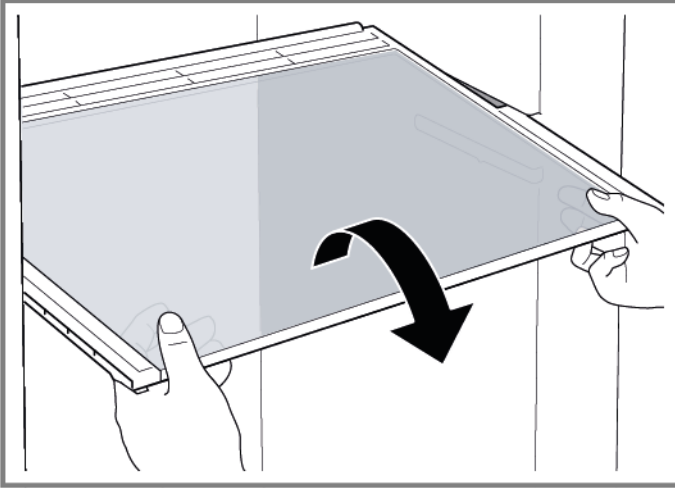

- ➡ Raf yüzeyi çıkartılmıştır.

4.3.2 Raf yüzeyinin takılması

- ▶ Ters sıra ile monte edin.

4.4 Şiše rafının değiştirilmesi

Ön koşul:

- ✔ Kapı açık.

4.4.1 Şiše rafının çıkartılması

- ▶ Şiše rafını dışarı çekin.

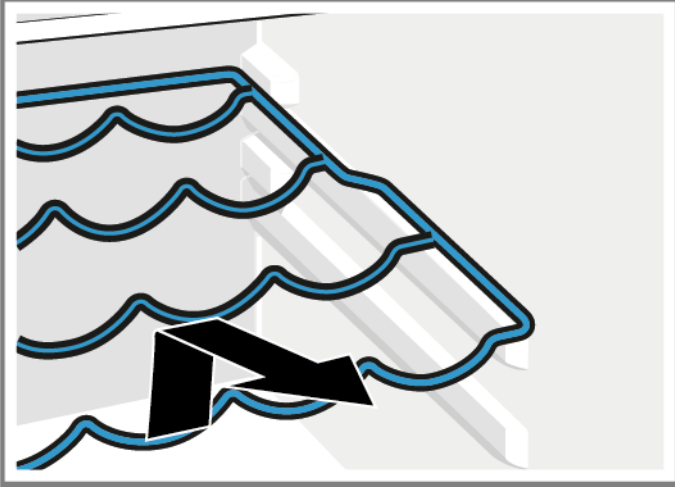

- ➡ Şiše rafı çıkartılmıştır.

4.4.2 Şiše rafının takılması

- ▶ Ters sıra ile monte edin.

4.5 Kapı rafının değiştirilmesi

Ön koşul:

- ✔ Kapı açık.

4.5.1 Kapı rafının çıkartılması

- ▶ Kapı rafını yukarıya doğru kaldırın.

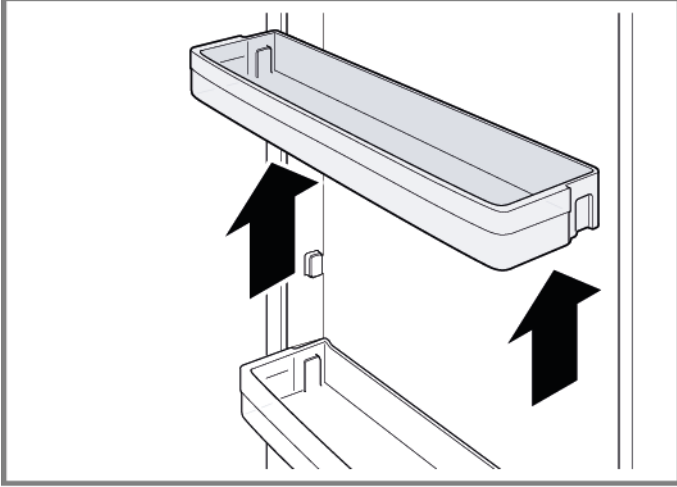

➡ Kapı rafı çıkartılmıştır.

4.5.2 Kapı rafının takılması

- ▶ Ters sıra ile monte edin.

4.6 Kapların deęiřtirilmesi

Ön koşul:

- ✓ Kapı açık.

4.6.1 Kapların çıkartılması

- ▶ Kapı tamamen dışarı çekini tutucudan ayırmak için kaldırın ve çıkartın.

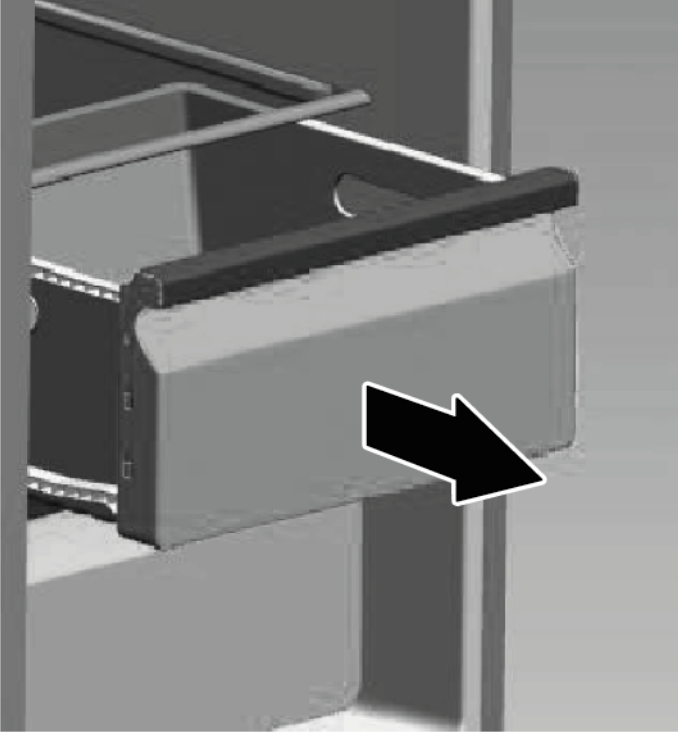

- ➡ Kap çıkartılmıştır.

4.6.2 Kapların takılması

- ▶ Ters sıra ile monte edin.

4.7 LED lambanın değiştirilmesi

i Cihazınızda bakım gerektirmeyen bir LED ışık bulunmaktadır. Bu ışıklar sadece müşteri hizmetleri veya yetkili teknisyenler tarafından değiştirilebilir!

⚠ TEHLİKE
Gerilim ileten parçalar nedeniyle elektrik çarpması tehlikesi!!
Onarımın düzgün yapılmaması nedeniyle elektrik çarpması sonucu hayati tehlike

- ▶ Elektrikli parçaların onarımı kalifiye bir elektrik uzmanı tarafından gerçekleştirilmelidir.
- ▶ Onarım sonrasında VDE 0701 veya ülkeye özel düzenlemeler uyarınca bir güvenlik testi gerçekleştirilmelidir.

⚠ DİKKAT
Keskin köşeler!
Kesik yaralanmaları

- ▶ Koruyucu eldiven kullanılmalıdır.

Ön koşul:

- ✓ Cihazın fişi çekilir.
- ✓ Kapı açık.
- ✓ Üst raf yüzeyi çıkartılmıştır.

4.7.1 LED lambanın çıkartılması

1. LED lamba kapağını iki elinizle tutun ve aşağıya çekin



- ➡ LED lamba kapağı çıkartılmıştır.



2. LED lambasını çekerek çıkartın



3. Terminalin fişini çekin



- ➡ LED lamba çıkartılmıştır.

4.7.2 LED lambanın takılması

- ▶ Ters sıra ile monte edin.