



BOSCH



Register your
new device on
MyBosch now and
get free benefits:
**[bosch-home.com/
welcome](https://bosch-home.com/welcome)**

Microwave Oven

CMA585M.0.

CMA.583M.0.

CMA583M.1.

[en] User manual and installation instructions

Table of contents

INFORMATION FOR USE

1	Safety	2
2	Preventing material damage	6
3	Environmental protection and saving energy	6
4	Familiarising yourself with your appliance	8
5	Accessories	11
6	Before using for the first time	11
7	Basic operation	12
8	Microwave	13
9	Automatic programmes	15
10	Time-setting options	17
11	Childproof lock	18
12	Basic settings	18
13	Cleaning and servicing	19
14	Troubleshooting	21
15	Disposal	22
16	Customer Service	22
17	How it works	23
18	INSTALLATION INSTRUCTIONS	37
18.2	Safe installation	37

1 Safety

Observe the following safety instructions.

1.1 General information

- Read this instruction manual carefully.
- Keep the instruction manual and the product information safe for future reference or for the next owner.
- Do not connect the appliance if it has been damaged in transit.

1.2 Intended use

Only a licensed professional may connect appliances without plugs. Damage caused by incorrect connection is not covered under the warranty.

The appliance can only be used safely if it is correctly installed according to the safety instructions. The installer is responsible for ensuring that the appliance works perfectly at its installation location.

Only use this appliance:

- To prepare meals and drinks.
- For household use and similar applications, such as: In kitchens for employees in shops, offices and other commercial sectors; in agriculture; by customers in hotels and other residential facilities; in bed and breakfasts.
- up to an altitude of max. 4000 m above sea level.

This appliance complies with the standards EN 55011 and CISPR 11. It is a group 2, class B product. Group 2 means that microwaves are produced for the purpose of heating food. Class B means that the appliance is suitable for private households.

1.3 Restriction on user group

This appliance may be used by children aged 15 or over and by people who have reduced physical, sensory or mental abilities or inadequate experience and/or knowledge, provided that they are supervised or have been instructed on how to use the appliance safely and have understood the resulting dangers.

Do not let children play with the appliance. Children must not perform cleaning or user maintenance unless they are at least 15 years old and are being supervised.

Keep children under the age of 8 years away from the appliance and power cable.

1.4 Safe use

WARNING – Risk of fire!

Combustible objects that are left in the cooking compartment may catch fire.

- ▶ Never store combustible objects in the cooking compartment.
- ▶ If smoke is emitted, the appliance must be switched off or the plug must be pulled out and the door must be held closed in order to stifle any flames.

Loose food remnants, fat and meat juices may catch fire.

- ▶ Before using the appliance, remove the worst of the food residues and remnants from the cooking compartment, heating elements and accessories.

Opening the appliance door creates a draught. Greaseproof paper may come into contact with the heating element and catch fire.

- ▶ Never place greaseproof paper loosely over accessories when preheating the appliance and while cooking.
- ▶ Always cut greaseproof paper to size and use a plate or baking tin to hold it down.

Overheating of the appliance may cause a fire. If the appliance is installed behind a decorative door or unit door, this will result in a build-up of heat during operation with the decorative door or unit door closed.

- ▶ Only operate the appliance when the decorative door or unit door is open.

⚠ WARNING – Risk of burns!

The appliance and its parts that can be touched become hot during use.

- ▶ Caution should be exercised here in order to avoid touching heating elements.
- ▶ Young children under 8 years of age must be kept away from the appliance.

Accessories and cookware get very hot.

- ▶ Always use oven gloves to remove accessories or cookware from the cooking compartment.

When the cooking compartment is hot, any alcoholic vapours inside may catch fire. The appliance door may spring open. Hot steam and jets of flame may escape.

- ▶ Only use small quantities of drinks with a high alcohol content in food.
- ▶ Do not heat spirits ($\geq 15\%$ vol.) when undiluted (e.g. for marinating or pouring over food).
- ▶ Open the appliance door carefully.

⚠ WARNING – Risk of scalding!

The accessible parts of the appliance become hot during operation.

- ▶ Never touch these hot parts.
- ▶ Keep children at a safe distance.

Hot steam may escape when you open the appliance door. Steam may not be visible, depending on the temperature.

- ▶ Open the appliance door carefully.
- ▶ Keep children at a safe distance.

If there is water in the cooking compartment when it is hot, this may create hot steam.

- ▶ Never pour water into the cooking compartment when the cooking compartment is hot.

⚠ WARNING – Risk of injury!

Scratched glass in the appliance door may develop into a crack.

- ▶ Do not use any harsh or abrasive cleaners or sharp metal scrapers to clean the glass on the appliance door, as they may scratch the surface.

The hinges on the appliance door move when the door is opened and closed, which could trap your fingers.

- ▶ Keep your hands away from the hinges.

Components inside the appliance door may have sharp edges.

- ▶ Wear protective gloves.

Cracks, splinters or breaks in the glass turntable are dangerous.

- ▶ Never allow hard objects to strike the turntable.
- ▶ Handle the turntable with care.

Alcoholic vapours may catch fire in the hot cooking compartment, and the appliance door may spring open and may fall off. The door panels may shatter and fragment.

→ *"Preventing material damage", Page 6*

- ▶ Only use small quantities of drinks with a high alcohol content in food.
- ▶ Do not heat spirits ($\geq 15\%$ vol.) when undiluted (e.g. for marinating or pouring over food).
- ▶ Open the appliance door carefully.

⚠ WARNING – Risk of electric shock!

Improper repairs are dangerous.

- ▶ Repairs to the appliance should only be carried out by trained specialist staff.
- ▶ Only use genuine spare parts when repairing the appliance.
- ▶ If the power cord of this appliance is damaged, it must be replaced by the manufacturer, the manufacturer's Customer Service or a similarly qualified person in order to prevent any risk.

If the insulation of the power cord is damaged, this is dangerous.

- ▶ Never let the power cord come into contact with hot appliance parts or heat sources.
- ▶ Never let the power cord come into contact with sharp points or edges.
- ▶ Never kink, crush or modify the power cord.

An ingress of moisture can cause an electric shock.

- ▶ Do not use steam- or high-pressure cleaners to clean the appliance.

If the appliance or the power cord is damaged, this is dangerous.

- ▶ Never operate a damaged appliance.
- ▶ Never operate an appliance with a cracked or fractured surface.
- ▶ Never pull on the power cord to unplug the appliance. Always unplug the appliance at the mains.
- ▶ If the appliance or the power cord is damaged, immediately unplug the power cord or switch off the fuse in the fuse box.
- ▶ Call customer services. → *Page 22*

⚠ WARNING – Risk of suffocation!

Children may put packaging material over their heads or wrap themselves up in it and suffocate.

- ▶ Keep packaging material away from children.
- ▶ Do not let children play with packaging material.

Children may breathe in or swallow small parts, causing them to suffocate.

- ▶ Keep small parts away from children.
- ▶ Do not let children play with small parts.

1.5 Microwave

CAREFULLY READ THE IMPORTANT SAFETY INSTRUCTIONS AND KEEP THEM SAFE FOR FUTURE USE

⚠ WARNING – Risk of fire!

Using the appliance for anything other than its intended purpose is dangerous and may cause damage. For example, heated slippers and pillows filled with grain or cereal may catch fire, even several hours later.

- ▶ Never dry food or clothing with the appliance.
- ▶ Never heat up slippers, pillows filled with grain or cereal, sponges, damp cleaning cloths or similar with the appliance.
- ▶ The appliance must only be used to prepare food and drink.

Food and its packaging and containers may catch fire.

- ▶ Never heat food in heat-retaining packaging.
- ▶ Do not leave food unattended while it is heating in containers made of plastic, paper or other combustible materials.
- ▶ Never set the microwave power too high or the cooking time too long. Follow the instructions provided in this user manual.
- ▶ Never use the microwave to dry food.
- ▶ Never defrost or heat food with a low water content, such as bread, at too high a microwave power or for too long.

Cooking oil may catch fire.

- ▶ Never use the microwave to heat cooking oil on its own.

⚠ WARNING – Risk of explosion!

Liquids and other food may easily explode when in containers that have been tightly sealed.

- ▶ Never heat liquids or other food in containers that have been tightly sealed.

⚠ WARNING – Risk of burns!

Foods with peel or skin may burst or explode during heating, or even afterwards.

- ▶ Never cook eggs in their shell or heat hard-boiled eggs in their shell.
- ▶ Never cook shellfish or crustaceans.
- ▶ Always prick the yolk of eggs before microwaving.
- ▶ The skin of foods that have a peel or skin, such as apples, tomatoes, potatoes and sausages, may burst. Before heating, prick the peel or skin.

Heat is not distributed evenly through baby food.

- ▶ Never heat baby food in closed containers.

- ▶ Always remove the lid or teat.
- ▶ Stir or shake well after heating.
- ▶ Check the temperature before giving the food or drink to a child.

Heated food gives off heat. The cookware may become hot.

- ▶ Always use oven gloves to remove cookware or accessories from the cooking compartment.

Airtight packaging may burst when food is heated.

- ▶ Always follow the instructions on the packaging.
- ▶ Always use oven gloves to remove the dishes from the cooking compartment.

The accessible parts of the appliance become hot during operation.

- ▶ Never touch these hot parts.
- ▶ Keep children at a safe distance.

Using the appliance for anything other than its intended purpose is dangerous. This is because, for instance, overheated slippers, pillows filled with grain or cereal, sponges and damp cleaning cloths, etc., may cause burns to the skin.

- ▶ Never dry food or clothing with the appliance.
- ▶ Never heat up slippers, pillows filled with grain or cereal, sponges, damp cleaning cloths or similar with the appliance.
- ▶ The appliance must only be used to prepare food and drink.

⚠ WARNING – Risk of scalding!

There is a possibility of delayed boiling when a liquid is heated. This means that the liquid reaches the boiling temperature without the usual steam bubbles rising to the surface. Exercise caution even when only gently shaking the container. The hot liquid may suddenly boil over and splatter.

- ▶ Always place a spoon in the container when heating liquids. This prevents delayed boiling.

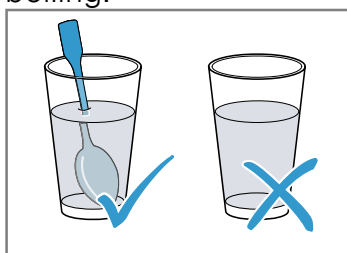

⚠ WARNING – Risk of injury!

Unsuitable cookware may crack. Porcelain or ceramic cookware can have small perforations in the handles and lid. These perforations conceal a cavity below. If moisture penetrates this cavity, it could cause the cookware to crack.

- ▶ Only use microwave-safe cookware. Cookware and containers made from metal or cookware with metal edging may lead to sparks being formed during simple microwave operation. The appliance is damaged.
- ▶ Never use metal containers during microwave-only operation.
- ▶ Only use microwave-safe cookware or use the microwave in combination with a type of heating.

⚠ WARNING – Risk of electric shock!

The appliance uses a high voltage.

- ▶ Never remove the casing.

⚠ WARNING – Risk of serious harm to health!

Inadequate cleaning may destroy the surface of the appliance, reduce its service life, and lead to dangerous situations, such as escaping microwave energy.

- ▶ Clean the appliance on a regular basis, and remove any food residue immediately.
- ▶ Always keep the cooking compartment, door seal, door and door stop clean.
→ "Cleaning and servicing", Page 19

Never operate the appliance if the cooking compartment door or the door seal is damaged. Microwave energy may escape.

- ▶ Never use the appliance if the cooking compartment door, the door seal or the plastic door frame is damaged.
- ▶ Any repair work must only be carried out by customer service.

Microwave energy will escape from appliances that do not have any casing.

- ▶ Never remove the casing.
- ▶ For any maintenance or repair work, contact the customer service.

2 Preventing material damage

2.1 General

ATTENTION!

Alcoholic vapours may catch fire in the hot cooking compartment and cause permanent damage to the appliance. The appliance door may spring open due to an explosion and it may fall off. The door panels may shatter and fragment. Due to the resulting negative pressure, the cooking compartment may become considerably deformed inwards.

- ▶ Do not heat spirits ($\geq 15\%$ vol.) when undiluted (e.g. for marinating or pouring over food).

When the cooking compartment is hot, any water inside it will create steam. The change in temperature may cause damage.

- ▶ Never pour water into the cooking compartment when it is still hot.

The prolonged presence of moisture in the cooking compartment leads to corrosion.

- ▶ Always wipe away the condensation after cooking. Always allow the cooking compartment to cool down with the door closed after cooking at high temperatures.
- ▶ Do not keep moist food in the cooking compartment for a long time with the door closed.
- ▶ Do not store food in the cooking compartment.
- ▶ Take care not to trap anything in the appliance door.

If the seal is very dirty, the appliance door will no longer close properly during operation. This may damage the front of adjacent kitchen units.

- ▶ Keep the seal clean at all times.
- ▶ Never operate the appliance if the seal is damaged or missing.

Sitting or placing objects on the appliance door may damage it.

- ▶ Do not place, hang or support objects on the appliance door.

With certain models, accessories may scratch the door pane when closing the appliance door.

- ▶ Always push accessories fully into the cooking compartment.

2.2 Microwave

Follow these instructions when using the microwave.

ATTENTION!

Metal touching the wall of the cooking compartment will cause sparks, which may damage the appliance or the inner door pane.

- ▶ Metal (e.g. a spoon in a glass) must be kept at least 2 cm from the cooking compartment walls and the inside of the door.

Placing aluminium containers in the appliance may cause sparks, which will damage the appliance.

- ▶ Do not use aluminium containers in the appliance.

Operating the appliance without food in the cooking compartment may lead to overloading.

- ▶ Do not switch on the microwave unless there is food inside. The only exception to this rule is when performing a short cookware test.

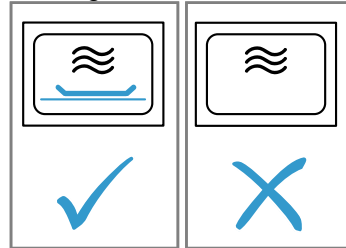

If you prepare several bags of microwave popcorn in immediate succession at a microwave power level that is too high, the cooking compartment may be damaged.

- ▶ Leave the appliance to cool down for several minutes between each use.
- ▶ Never set a microwave power level that is too high.
- ▶ Use a maximum microwave output of 600 watts.
- ▶ Always place the popcorn bag on a glass plate.

The microwave feed is damaged by the removal of the cover.

- ▶ Never remove the cover of the microwave feed in the cooking compartment.

Liquid that penetrates the interior of the appliance may damage the turntable drive.

- ▶ Monitor the cooking process.
- ▶ Set a shorter cooking time first and, if necessary, increase the cooking time.
- ▶ Never use the appliance without the turntable.

Using unsuitable cookware may result in damage.

- ▶ When using the grill, the microwave combi mode or the hot air, only use tableware that can withstand the high temperatures.

3 Environmental protection and saving energy

3.1 Disposing of packaging

The packaging materials are environmentally compatible and can be recycled.

- ▶ Sort the individual components by type and dispose of them separately.

3.2 Saving energy

If you follow these instructions, your appliance will use less power.

Only preheat the appliance if the recipe or the recommended settings tell you to do so.

- Not preheating the appliance can reduce the energy used.

Use dark-coloured, black-coated or enamelled baking tins.

- These types of baking tin absorb the heat particularly well.

When cooking multiple dishes, do so in succession or in parallel.

- The cooking compartment is heated after cooking the first dish. This reduces the cooking time for the following dishes.

If the cooking time is relatively long, you can switch the appliance off 10 minutes before the cooking time ends.

- There will be enough residual heat to finish cooking the dish.

Allow frozen food to defrost before cooking.

- This saves the energy that would otherwise be required to defrost it.

Open the appliance door as little as possible during operation.

- This will maintain the temperature in the cooking compartment and eliminate the need for the appliance to reheat.

Heat two cups of liquid at the same time.

- Heating several dishes at the same time requires less energy than heating dishes one after the other.

Hide the clock in standby mode.

- The appliance saves energy in standby mode.

Note:

The appliance requires:

- A maximum of 1 W in standby mode with the display switched on
- A maximum of 0.5 W in standby mode with the display switched off

4 Familiarising yourself with your appliance

4.1 Controls

You can use the control panel to configure all functions of your appliance and to obtain information about the operating status.

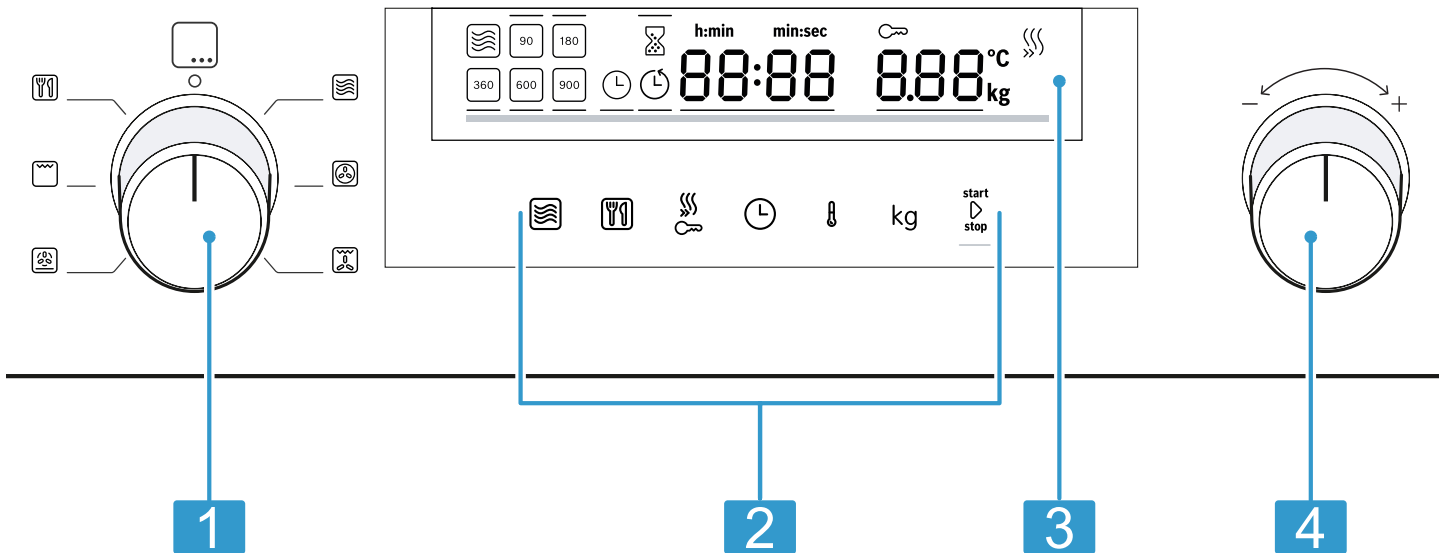

On certain models, specific details such as the colour and shape may differ from those pictured.

1	Function selector
2	Touch fields
3	Display
4	Rotary selector

Function selector

Use the function selector to set the types of heating and other functions.
On some product variants, the function selector can be pushed in.

If you turn the function selector from the off position to a function, it takes a few seconds for the relevant function to be available.

Rotary selector

Use the rotary selector to change the settings values shown in the display.
On some product variants, the rotary selector can be pushed in.
In selection lists, e.g. programmes, the first selection follows the last.
For values, e.g. weight, turn the rotary selector back the other way when you reach the minimum or maximum value.

Touch fields

Touch fields are touch-sensitive surfaces. To select a function, touch the relevant field.

Symbol	Name	Use
	Microwave	Select the microwave power levels or switch on the microwave function for a type of heating.
	Automatic programmes	Call up the selection of automatic programmes.
	Rapid preheating/childproof lock	Press briefly: Activate/deactivate rapid preheating. Press and hold: Activate or deactivate the childproof lock.
	Time-setting options	Timer, cooking time or set the time.

Symbol	Name	Use
⊖	Temperature	Select set the temperature.
kg	Weight	Select set the weight.
start▷stop	Start/stop	Press briefly: Start or stop operation. Press and hold: End operation. The settings are reset.

Display

You can see the current setting values or options in the display.



Active value	The directly adjustable value is highlighted white with a red bar underlined. You can use the rotary selector to change the active value.
--------------	---

Passive value	You cannot directly adjust values outside of the brackets. If you want to change a value, you must first activate the value.
---------------	--

Display elements

Here you can find a short explanation of the various display elements.

Symbol	Name	Meaning
⌚	Timer	If the symbol is highlighted, the timer appears in the display.
🕒	Cooking time	If the symbol is highlighted, the cooking time appears in the display.
🕒	Clock	If the symbol is highlighted, the clock appears in the display.
h:min	Hours/minutes	The time is displayed in hours and minutes.
min:sec	Minutes/seconds	The time is displayed in minutes and seconds.
🔒	Childproof lock	If this symbol is highlighted, the childproof lock is activated.
🔥	Rapid heating	If the symbol is highlighted, rapid heating is activated.
°C	Temperature	The temperature is displayed in °C.
kg	Weight	The weight is displayed in kg.

Temperature display

The temperature display shows the heating progress.

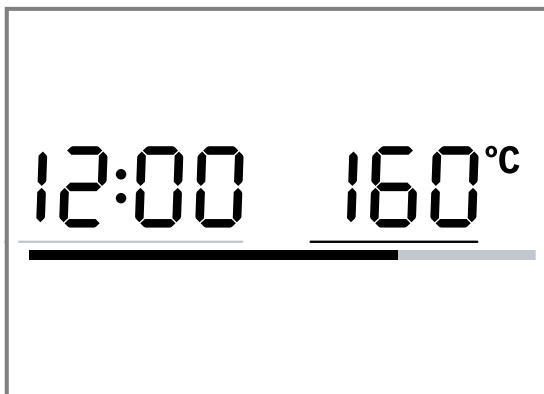

After starting operation, the red line in the lower area of the display shows the heating up progress of the interior temperature. The line gradually turns red as the appliance heats up. When the line turns completely red, the appliance has reached the set temperature. When using the grill, the heating line turns red immediately.

When using the microwave, there is no temperature display.







Due to thermal inertia, the temperature displayed may differ slightly from the actual temperature inside the cooking compartment.

Night mode

To save energy, the control panel brightness is automatically reduced to a lower level between 10 p.m. and 5.59 a.m.

4.2 Types of heating

Here you can find an overview of the types of heating. You can find recommendations on using the types of heating.

Symbol	Name	Temperature/ levels	Use
	Microwave	Microwave power settings: <ul style="list-style-type: none"> ▪ 90 W ▪ 180 W ▪ 360 W ▪ 600 W ▪ 900 W 	For defrosting, cooking and heating foods and liquids.
	Hot air	40 °C 100-230 °C	Let yeast dough rise, defrost cream cakes. For baking and roasting on one level.
	Hot air grilling	100-230 °C	Roasting poultry, whole fish and large pieces of meat.
	Pizza setting	100-230 °C	For cooking pizza and dishes that require a lot of heat from underneath.
	Grill	Grill settings: <ul style="list-style-type: none"> ▪ 1 = low ▪ 2 = medium ▪ 3 = high 	Grilling flat items such as steak and sausages, or making toast. Browning food.
	Programmes	-	There are preprogrammed settings for many dishes.

Note: For each type of heating, the appliance specifies a default temperature. You can accept this value or change it in the relevant area.

4.3 Cooking compartment

The functions in the cooking compartment make your appliance easier to use.

Interior lighting

When you open the appliance door, the light in the cooking compartment switches on. If the appliance door remains open for longer than 15 minutes, the light switches off again.

In most operating modes, the interior lighting switches on as soon as operation starts. The interior lighting switches off again when operation stops.

You can specify whether you want the interior lighting to switch on during operation in the basic settings.

→ Page 18

Cooling fan

The cooling fan switches on and off as required. The hot air escapes through the ventilation slots above the appliance door.

ATTENTION!

Covering the ventilation slots will cause the appliance to overheat.

- ▶ Do not cover the ventilation slots.

To cool the cooking compartment more quickly after operation, the cooling fan continues to run for a certain period afterwards. If the appliance is running in microwave operation, the appliance remains cool, but the cooling fan still switches on. The cooling fan may continue to run even when microwave operation has ended.

Condensation

Condensation can occur in the cooking compartment and on the appliance door when cooking. Condensation is normal and does not adversely affect appliance operation. Wipe away the condensation after cooking.

5 Accessories

Use original accessories. These have been made especially for your appliance. The accessories supplied may differ depending on the appliance model.

Accessories	Use
Tall wire rack	<ul style="list-style-type: none"> ■ Wire rack for grilling and browning ■ Wire rack as a place for the cookware ■ Wire rack for placing onto the turntable
Turntable	<ul style="list-style-type: none"> ■ Turntable as a support for wire racks ■ Turntable onto which you can directly place food that requires a lot of heat from below
Low wire rack	<ul style="list-style-type: none"> ■ Wire rack for the microwave ■ Wire rack for baking and frying in oven operation ■ Wire rack for placing onto the turntable

4.4 Appliance door

If you open the appliance door during operation, operation stops. If the appliance door is closed, you can continue operation with **start**▷**stop**.

5.1 Other accessories

You can purchase other accessories from our customer service, specialist retailers or online. You will find a comprehensive range of products for your appliance in our brochures and online: www.bosch-home.com Accessories are appliance-specific. When purchasing accessories, always quote the exact product number (E no.) of your appliance. You can find out which accessories are available for your appliance in our online shop or from our customer service.

Glass roasting dish

Use

- Stews
- Bakes

Pizza tray

Use

- Tray bakes
- Biscuits

6 Before using for the first time

Configure the settings for initial start-up. Clean the appliance and accessories.

6.1 Inserting the turntable

Never use the appliance without the turntable. The turntable must turn for all types of heating. The maximum load for the turntable is 5 kg.

- ▶ Place the turntable **[a]** onto the driver **[b]** in the centre of the cooking compartment floor.

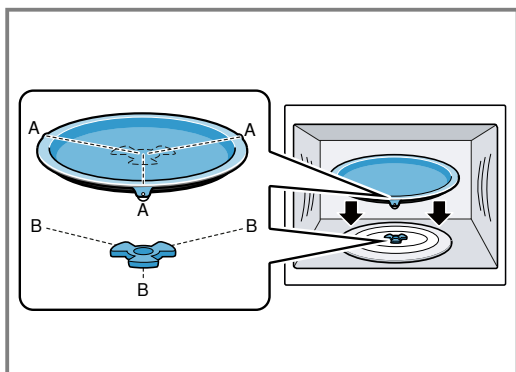

The turntable must sit straight on the driver.

Note: The turntable turns clockwise or anti-clockwise, and is cut-resistant. You can cut food directly on the turntable.

6.2 Performing the initial configuration

After connecting the appliance to the power supply or following a power cut, the following prompt appears in the display for the setting the time. It may take a few seconds for the prompt to appear.

- ▶ Connect the appliance to the power supply.
- ✓ 12:00 flashes in the display and ⏰ lights up.

Setting the time

1. Set the time using the rotary selector.
2. Press ⏰.
- ✓ The time is set.

Note: In order to reduce the energy consumption of your appliance in standby, you can hide the time.

6.3 Cleaning the appliance before using it for the first time

Clean the cooking compartment and accessories before using the appliance to prepare food for the first time.

1. Make sure that there is no leftover packaging, accessories or other objects in the cooking compartment.
 2. Close the appliance door.
 3. Use the function selector to set Hot air .
 4. Use the rotary selector to set the temperature to 180 °C.
 5. Press **start▷stop** .
- ✓ The appliance starts.

6. After one hour, press **start▷stop** .
 7. Turn the function selector to the off position.
- ✓ The appliance is cleaned.
 - ✓ The appliance is switched off.

6.4 Cleaning the accessories

- ▶ Clean the accessory thoroughly with soapy water and a soft dish cloth.

7 Basic operation

7.1 Switching on the appliance

- ▶ Turn the function selector to switch on the appliance.
- ✓ The appliance is ready to use.
- ✓ A default value appears in the display.

7.2 Switching off the appliance

Switch your appliance off when you are not using it. If no settings are applied for an extended period, the appliance switches itself off automatically.

- ▶ Turn the function selector to the off position.
- ✓ The appliance stops any ongoing functions.
- ✓ The time appears in the display.
- ✓ Some displays also remain visible in the display when the appliance has been switched off.

7.3 Setting the type of heating and temperature

1. Use the function selector to set the required type of heating.
- ✓ A default value appears in the display.
2. If necessary, change the settings. To do this, touch the appropriate field and use the rotary selector to change the value.
3. Press **start▷stop** .
- ✓ The appliance starts.
 - ✓ **start▷stop** lights up.
 - ✓ With a type of heating with temperature, the temperature display lights up gradually.
4. If necessary, use the rotary selector to change the temperature while the oven is in operation.
- When the appliance is in operation, you cannot set the temperature to 40 °C.

7.4 Pausing operation

You can pause operation at any time.

1. Press **start▷stop** or open the appliance door.
- ✓ Operation is paused.
 - ✓ **start▷stop** flashes.
2. To continue operation, close the appliance door and press **start▷stop** .
- ✓ Operation continues.
 - ✓ **start▷stop** lights up.

7.5 Stopping operation



You can stop operation at any time.

- ▶ Turn the function selector to the off position. The fan may continue to run after operation has been paused or stopped.
- ✓ The appliance stops any ongoing functions.

7.6 Rapid heating



To save time, you can shorten the preheat time for certain types of heating from a minimum temperature of 100 °C.

You can use rapid heat-up for the following types of heating:



-  Hot air, exception: Hot air 40 °C
-  Hot air grilling
-  Pizza setting

Configuring rapid heating

To ensure an even cooking result, do not place the accessory with the food in the cooking compartment until rapid heating has finished. Do not set a cooking time until rapid heating has finished.

1. Set a suitable type of heating and a temperature of at least 100 °C.
 2. Press .
- ✓  lights up in the display.
3. Press **start▷stop** .
- ✓ Rapid heating starts.
 - ✓ **start▷stop** lights up.
 - ✓ Once the set temperature has been reached, the rapid heating process ends. A signal sounds and  goes out in the display. Your appliance continues to run with the set type of heating and temperature.
 - ✓ Rapid heating is automatically deactivated within no more than 15 minutes.

Cancelling rapid heating

- ▶ Press .
- ✓  goes out in the display. Your appliance continues to run with the set type of heating and temperature.

7.7 Safety switch-off function

For your safety, the appliance has a safety switch-off function. The appliance is automatically switched off if it has been in operation for an extended period.

How long the appliance waits before switching itself off depends on the setting:

- Hot air 40 °C: 24 hours
- Hot air 100-230 °C, circulated air grilling and pizza setting: 5 hours
- Grill: 90 minutes

If the appliance has been switched off by the safety switch-off function, **E2** is shown on the display. You can confirm this message by pressing **start**▷**stop**.

8 Microwave

You can use the microwave to cook, heat up, bake or defrost food very quickly. The microwave can be used on its own or in combination with a type of heating.

8.1 Microwave power settings

Here you can find an overview of the different microwave power settings and when to use them.

Microwave output in watts	Maximum cooking time	Use
90 W	1:30 hours	Defrosting delicate foods.
180 W	1:30 hours	Defrosting food and continued cooking.
360 W	1:30 hours	Cooking meat and fish or heating delicate foods.
600 W	1:30 hours	Heating and cooking food.
900 W	30 minutes	Heating liquids. The maximum power setting is not designed for heating food.

Default settings

The appliance suggests a cooking time for each microwave power setting. You can accept this value or change it in the relevant area.

8.2 Microwave-safe cookware and accessories

To heat food evenly and avoid damaging your appliance, it is important to use the right cookware and accessories.

Read the manufacturer's instructions before using any cookware in the microwave. If in doubt, carry out a cookware test. Testing cookware for microwave suitability → *Page 14*

Microwave-safe

Cookware and accessories	Reason
Cookware made from heat-resistant, microwave-safe material: <ul style="list-style-type: none"> ■ Glass ■ Glass ceramic ■ Porcelain ■ Temperature-resistant plastic ■ Fully glazed ceramic without cracks 	Microwaves do not damage heat-resistant material.

Cookware and accessories	Reason
Accessories supplied: Wire rack	The wire rack supplied has been designed specifically for the appliance and is therefore suitable for microwave use.
Metal cutlery	You can use metal cutlery, e.g. place a spoon in a glass, to prevent delayed boiling. Note: Metal may create sparks, which could damage the cooking compartment and the inner door pane. Metal must be kept at least 2 cm from the cooking compartment walls and the inside of the door.

Not microwave-safe

Cookware and accessories	Reason
Metal cookware	Microwaves cannot pass through metal. The food is barely heated or not heated at all.
Cookware with gold or silver decoration	Microwaves can damage gold and silver decoration. Only use this kind of cookware if the manufacturer guarantees that it is microwave-safe.

Microwave-safe in MicroCombi mode

In MicroCombi mode, a microwave output of up to 600 W watts can be added to a type of heating. This means that metal dishes can be used in MicroCombi mode.

Cookware and accessories	Reason
Accessories supplied	The accessories supplied, e.g. the wire rack, do not create sparks in MicroCombi mode.
Metal baking tins	Cakes will brown both on top and on the bottom, as baking tins made of metal conduct heat more efficiently. Note: Metal may create sparks, which could damage the cooking compartment and the inner door pane. Metal must be kept at least 2 cm from the cooking compartment walls and the inside of the door.

8.3 Testing cookware for microwave suitability

Test cookware to see whether it is suitable for microwave use. Testing cookware is the only time the appliance should be operated in microwave mode without any food inside.

⚠ WARNING – Risk of scalding!

The accessible parts of the appliance become hot during operation.

- ▶ Never touch these hot parts.
- ▶ Keep children at a safe distance.

1. Place the empty cookware in the cooking compartment.
2. Set the appliance to run for 30 seconds to 1 minute at maximum power.
3. Press **start▷stop** to start.
4. Check the cookware several times:
 - If the cookware is cold or warm to the touch, it is suitable for microwave use.
 - If the cookware becomes hot or sparks are created, stop the cookware test. The cookware is not microwave-safe.

8.4 Configuring the microwave settings



Different power levels and settings are available for different types of food and recipes.

ATTENTION!

Operating the appliance without food in the cooking compartment may lead to overloading.

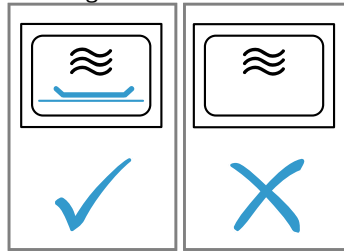
- ▶ Do not switch on the microwave unless there is food inside. The only exception to this rule is when performing a short cookware test.



1. Read the safety instructions → *Page 4* and the section on how to prevent material damage → *Page 6*.
2. Read the information on microwave-safe cookware and accessories. → *Page 13*
3. Set the function selector to .
4. To set the required microwave power setting, press .
5. Use the rotary selector to set the required cooking time.
6. Press **start▷stop** to start.
You can change the cooking time at any time during operation using the rotary selector.
- ✓ The cooking time starts to count down and the microwave starts.
- ✓ Once the cooking time has elapsed, the microwave stops and a signal sounds.
7. When the dish is cooked, turn the function selector to the off position.

8.5 Intervals for the time settings

The interval for setting a cooking time in microwave operation changes with the length of the cooking time.

Cooking time	Interval
0–1 minutes	5 seconds
1-3 minutes	10 seconds
3–15 minutes	30 seconds
15 minutes – 1 hour	1 minute
1 hour – 1 hour 30 minutes	5 minutes

8.6 Changing the microwave power

- ▶ Press .
Repeatedly pressing switches from the highest to the lowest microwave power setting.
If the microwave function is only added after starting, the appliance pauses. Press **start▷stop** to start.

8.7 Pausing operation

You can pause operation at any time.

1. Press **start▷stop** or open the appliance door.
 - ✓ Operation is paused.
 - ✓ **start▷stop** flashes.
2. To continue operation, close the appliance door and press **start▷stop**.
 - ✓ Operation continues.

- ✓ start▷stop lights up.





8.8 Stopping operation

You can stop operation at any time.

- ▶ Turn the function selector to the off position.
The fan may continue to run after operation has been paused or stopped.
- ✓ The appliance stops any ongoing functions.

8.9 MicroCombi

To reduce the cooking time, you can use certain types of heating in combination with microwave mode. MicroCombi mode can be used with the following types of heating:

-  Hot air
-  Circulated air grill
-  Grill
-  Pizza setting

Exceptions:

-  Microwave power setting 900 W
-  Hot air 40 °C

Configuring MicroCombi mode

Switch on microwave mode in addition to a type of heating.

1. Set the function selector to a combinable type of heating.
 - ✓ A default value for the temperature is displayed.
2. Set the temperature using the rotary selector.
3. To set the required microwave power setting, press .
 - ✓ A default value for the cooking time is displayed.
4. Use the rotary selector to set the cooking time.
5. Press start▷stop to start.
 - ✓ The cooking time counts down and MicroCombi mode starts.
 - ✓ Once the cooking time has elapsed, MicroCombi mode ends automatically and a signal sounds.

Changing the microwave power

- ▶ Press .
Repeatedly pressing switches from the highest to the lowest microwave power setting.
If the microwave function is only added after starting, the appliance pauses. Press start▷stop to start.

Pausing operation

You can pause operation at any time.

1. Press start▷stop or open the appliance door.

- ✓ Operation is paused.
 - ✓ start▷stop flashes.
2. To continue operation, close the appliance door and press start▷stop.
 - ✓ Operation continues.
 - ✓ start▷stop lights up.





Stopping operation

You can stop operation at any time.

- ▶ Turn the function selector to the off position.
The fan may continue to run after operation has been paused or stopped.
- ✓ The appliance stops any ongoing functions.

8.10 Heating and drying the cooking compartment

Always dry the cooking compartment after operation to ensure that no moisture remains.

1. Allow the appliance to cool down.
2. Remove the worst of the food residues from the cooking compartment immediately.
3. Wipe any humidity from the cooking compartment floor.
4. Use the function selector to set the  type of heating.
5. Press .
6. Use the rotary selector to set the temperature to 150 °C.
7. Press  twice.
 - ✓  is highlighted in the display.
8. Use the rotary selector to set a cooking time of 15 minutes.
9. Press start▷stop to start.
 - ✓ The drying process starts and ends after 15 minutes.
10. Open the appliance door to allow the steam to escape.

8.11 Drying the cooking compartment by hand

Always dry the cooking compartment after operation to ensure that no moisture remains.

1. Allow the appliance to cool down.
2. Remove the worst of the food residues from the cooking compartment.
3. Dry the cooking compartment with a sponge.
4. Leave the appliance door open for 1 hour so that the cooking compartment dries completely.

9 Automatic programmes

Automatic programmes can help you prepare different dishes by selecting the optimal settings automatically.

9.1 Tips on configuring the settings for dishes

Follow these tips to achieve optimal cooking results.

- Only use food that is in perfect condition.
- Only use meat at refrigerator temperature.
- Only use frozen food straight from the freezer.
- Take the food out of its packaging and weigh it. If you cannot set the exact weight on the appliance, round the weight up or down.
- Place the food in the cold cooking compartment.
- Always use microwave-safe, heat-resistant cookware, for example made of glass or ceramic.

9.2 Overview of the dishes

The appliance prompts you to enter the weight. You can only enter weights within the intended weight range.

Tip: Stick the programme sticker to your appliance. You can therefore access the programmes faster and more easily.

Defrost

No.	Foods	Accessories	Weight range in kg	Information
<i>PD1</i>	Minced meat	Shallow cookware without lid On the lower wire rack	0,2-1,0	After turning, remove any minced meat that has already defrosted.
<i>PD2</i>	Pieces of meat	Shallow cookware without lid On the lower wire rack	0,2-1,0	Drain off any liquid when turning and under no circumstances use it for other purposes or allow it to come into contact with other foods.
<i>PD3</i>	Chicken, chicken pieces	Shallow cookware without lid On the lower wire rack	0,4-1,8	Drain off any liquid when turning and under no circumstances use it for other purposes or allow it to come into contact with other foods.
<i>PD4</i>	Bread	Shallow cookware without lid On the lower wire rack	0,2-1,0	Bread should only be defrosted in the required amounts, as it quickly becomes stale. If possible, separate the slices.

Cooking programmes





No.	Foods	Accessories	Weight range in kg	Information
<i>PD5</i>	Rice	Cookware with lid On the lower wire rack	0,05-0,2	Do not use boil-in-the-bag rice. Rice foams a lot during cooking. Enter the uncooked weight (without liquid). Add two to two and a half times the amount of liquid to the rice.
<i>PD6</i>	Potatoes	Cookware with lid On the lower wire rack	0,15-1,0	Cut into pieces of equal size. Add 1 tbsp water per 100 g.
<i>PD7</i>	Vegetables	Cookware with lid On the lower wire rack	0,15-1,0	Cut into pieces of equal size. Add 1 tbsp water per 100 g.

Combi cooking programmes

No.	Foods	Accessories	Weight range in kg	Information
<i>PD8</i>	Bake, frozen	Cookware without lid On the lower wire rack	0,4-1,2	The bake should not be thicker than 3 cm.
<i>PD9</i>	Chicken, whole	Cookware without lid On the lower wire rack	0,5-2,0	Breast side down.
<i>PD10</i>	Sirloin, medium	Cookware without lid On the lower wire rack	0,5-1,5	
<i>PD11</i>	Pork neck joint	Cookware with lid On the lower wire rack	0,5-2,0	





No.	Foods	Accessories	Weight range in kg	Information
P 12	Lamb, medium	Cookware with lid On the lower wire rack	0,8-2,0	Shoulder joint or boned leg of lamb
P 13	Meatloaf	Cookware without lid On the lower wire rack	0,5-1,5	The meat loaf should not be thicker than 7 cm.
P 14	Fish, whole	Cookware without lid On the lower wire rack	0,3-1,0	Scale the fish beforehand. Place the fish in the cookware in its "swimming position".
P 15	Rice stew with fresh ingredients	Deep cookware with lid On the lower wire rack	0,05-0,2	Add one part rice, three parts water, four parts vegetables. Only use fresh ingredients. Only enter the weight of the rice.

9.3 Applying settings for dishes

- Set the function selector to .
 - The display shows the first dish number and a default value for the weight.
- Use the rotary selector to set the required weight.
- Press **kg**.
- Turn the rotary selector to set the weight.
 - Before starting, you can use  and **kg** to switch between the dish and the weight.
 - The appliance automatically sets the right cooking time.
- Press **start** .
 - After starting, the dish and weight cannot be changed. The set weight can be displayed with **kg**.
 - The appliance starts.
 - start**  lights up.
 - You will see the cooking time counting down.
 - For some programmes, a short audible signal sounds when you have to stir or turn the dish.
- When the cooking time has elapsed:
 - A signal sounds. The appliance stops heating.
 - Turn the function selector to the off position.

9.4 Pausing operation

You can pause operation at any time.

- Press **start**  or open the appliance door.
 - Operation is paused.
 - start**  flashes.
- To continue operation, close the appliance door and press **start** .
 - Operation continues.
 - start**  lights up.

9.5 Stopping operation

You can stop operation at any time.





- Turn the function selector to the off position.
 - The fan may continue to run after operation has been paused or stopped.
- The appliance stops any ongoing functions.

10 Time-setting options

Your appliance features time-setting options that you can use to set the cooking time and the timer.



10.1 Checking the time-setting options

Requirement: If multiple time-setting options are set, the corresponding symbols light up. During operation, the timer and cooking time are available. In standby, the timer and the time are available.

- Press  until ,  or  is in focus.
- The respective value is shown in the display.

10.2 Changing the time

Requirement: To change the time on the clock, the appliance must be switched off.

- Press  twice.
 -  and the time appear on the display.
- Set the time using the rotary selector.
- Press .
 - The time is set.





- If  is not pressed, the set value is applied after a few seconds.

Note: In order to reduce the energy consumption of your appliance in standby, you can hide the time.

10.3 Cooking time

You can set a time after which operation ends automatically. The maximum cooking time is 23 hours and 59 minutes.

Setting the cooking time

- Set the type of heating and temperature.
- Press  until  is in focus.
- Use the rotary selector to set the required cooking time.
- Press **start** .
 - The appliance starts.
 - start**  lights up.
 - You will see the cooking time counting down.

Ending the cooking time

Requirement: A signal sounds. The appliance stops heating. **00:00** is shown in the display.

1. Press .
- ✓ The signal is switched off.
2. Turn the function selector to the off position.
- ✓ The appliance is switched off.

Changing the cooking time

- ▶ Change the cooking time using the rotary selector.
- ✓ After a few seconds, the display shows the changed cooking time.
- ✓ You will see the cooking time counting down.

Clearing the cooking time



1. If the timer function has been set, press .
2. Use the rotary selector to set the cooking time to **00:00**.
- ✓ After a few seconds, the cooking time is cleared. The appliance does not interrupt operation.

10.4 Timer

You can specify for a signal to sound after a certain period of time. The maximum duration of the timer is 24 hours.

The timer works independently of the operation and other time-setting options. The timer signal is different to the other signals the appliance sounds.

Setting the timer

1. Press  until  is in focus.
2. Use the rotary selector to set the required timer duration.
- ✓ After a few seconds, the appliance displays the set timer duration.
- ✓ The timer starts.
- ✓  lights up in the display.
- ✓ You will see the timer duration counting down.

Ending the timer

Requirement: A signal sounds. **00:00** is shown in the display.

- ▶ Press any symbol.
- ✓ The timer is switched off.

Changing the timer

- ▶ Use the rotary selector to change the timer duration.
- ✓ After a few seconds, the appliance displays the set timer duration.

Cancelling the timer



- ▶ Use the rotary selector to set the timer duration to **0:00**.
- ✓ The timer is switched off.

11 Childproof lock

You can secure your appliance to prevent children from accidentally switching it on or changing the settings.

11.1 Activating the childproof lock

Requirement: The appliance is switched off.

- ▶ Press and hold  for approx. 4 seconds.
- ✓ The control panel is locked.
- ✓ The  symbol appears in the display.

- ✓ If a timer duration has been set, this continues to count down. While the childproof lock is active, the timer duration cannot be changed. Signal tones, e.g. when the timer duration has elapsed, can be ended by pressing any button

11.2 Deactivating the childproof lock



- ▶ Press and hold  for approx. 4 seconds.
- ✓ The control panel is unlocked.

12 Basic settings

You can configure the basic settings for your appliance to meet your needs.

12.1 Overview of the basic settings

Here you can find an overview of the basic settings and factory settings. The basic settings depend on the features of your appliance.

Indicator	Basic setting	Selection	Description
	Signal duration	1 = short = 10 seconds 2 = medium = 30 seconds ¹ 3 = long = 2 minutes	Set the signal duration for after a cooking time elapses or the timer reaches zero.
	Button tone	0 = off 1 = on ¹	Switch the button tones on or off.

¹ Factory setting (may vary according to model)

Indicator	Basic setting	Selection	Description
c03	Display brightness	1 = low 2 = medium ¹ 3 = high	Set the brightness of the display.
c04	Time indicator	0 = off 1 = on ¹	Show the clock time in the display.
c05	Interior lighting	0 = off 1 = on ¹	Switch the interior lighting on or off.
c06	Factory setting	0 = off ¹ 1 = on	Reset the changed settings to the factory settings.
c08	Signal volume	1 = low 2 = medium ¹ 3 = high	Setting the signal volume.

¹ Factory setting (may vary according to model)

12.2 Changing the basic settings

Requirement: The appliance must be switched off.

- Press and hold ☺ for a few seconds.
 - ✓ The first basic setting is shown on the display.
- Use the rotary selector to change the basic setting.
- Press ☺.
 - ✓ The next basic setting is shown on the display.
- Use ☺ to select all of the required basic settings and change the values.

- To save the changes, press and hold ☺ for a few seconds.

Note: The changes to the basic settings will be retained even after a power cut.

12.3 Discarding changes to the basic settings

- ▶ Turn the function selector.
- ✓ All changes are discarded and not saved.

13 Cleaning and servicing

To keep your appliance working efficiently for a long time, it is important to clean and maintain it carefully.

13.1 Cleaning products

Only use suitable cleaning products.

WARNING – Risk of electric shock!

An ingress of moisture can cause an electric shock.

- ▶ Do not use steam- or high-pressure cleaners to clean the appliance.

ATTENTION!

Unsuitable cleaning products may damage the surfaces of the appliance.

- ▶ Do not use harsh or abrasive detergents.
- ▶ Do not use cleaning products with a high alcohol content.
- ▶ Do not use hard scouring pads or cleaning sponges.
- ▶ Do not use any special cleaners for cleaning the appliance while it is hot.
- ▶ Only use glass cleaners, glass scrapers or stainless steel care products if recommended in the cleaning instructions for the relevant part.
- ▶ Wash sponge cloths thoroughly before use.

You can find out which cleaning products are suitable for each surface or part of the appliance in the individual cleaning instructions.

13.2 Cleaning the appliance

Clean the appliance as specified. This will ensure that the different parts and surfaces of the appliance are not damaged by incorrect cleaning or unsuitable cleaning products.

WARNING – Risk of burns!

The appliance and its parts that can be touched become hot during use.

- ▶ Caution should be exercised here in order to avoid touching heating elements.
- ▶ Young children under 8 years of age must be kept away from the appliance.

WARNING – Risk of fire!

Loose food remnants, fat and meat juices may catch fire.

- ▶ Before using the appliance, remove the worst of the food residues and remnants from the cooking compartment, heating elements and accessories.

- Read the information on cleaning products.
→ Page 19
- Observe the information on cleaning the appliance components or surfaces.
- Unless otherwise specified:
 - Clean the components of the appliance with hot soapy water and a dish cloth.
 - Dry with a soft cloth.

13.3 Cleaning the cooking compartment

ATTENTION!

Incorrect cleaning may damage the cooking compartment.

- ▶ Do not use oven spray, abrasive materials or other aggressive oven cleaners.

1. Read the information on cleaning products.
→ Page 19
2. Clean with hot soapy water or a vinegar solution.
3. Use oven cleaner to remove very heavy soiling. Only use oven cleaner when the cooking compartment is cold.

Tip: To eliminate unpleasant odours, heat up a cup of water with a few drops of lemon juice for 1 to 2 minutes at maximum microwave power setting. Always place a spoon in the container to prevent delayed boiling.

4. Wipe out the cooking compartment with a soft cloth.
5. Leave the cooking compartment to dry with the door open.

Cleaning the recess in the cooking compartment

1. Read the information on cleaning products.
→ Page 19
2. **ATTENTION!**
Water may run through the turntable driver into the interior of the appliance and may damage the appliance.
 - ▶ Never clean the recess in the cooking compartment with a wet cloth.

Clean the recess in the cooking compartment with a damp cloth.

Cleaning the turntable

1. Read the information on cleaning products.
→ Page 19
2. Remove the turntable.
3. Clean the turntable with hot soapy water and a soft dish cloth.
4. Dry with a soft cloth.
5. Reinsert the turntable.
Ensure that the turntable engages correctly.

13.4 Cleaning the front of the appliance

ATTENTION!

Incorrect cleaning may damage the front of the appliance.

- ▶ Do not use glass cleaner, metal scrapers or glass scrapers for cleaning.
- ▶ To prevent corrosion on stainless steel fronts, remove any limescale, grease, starch and albumin (e.g. egg white) stains immediately.
- ▶ On stainless steel surfaces, use special stainless steel cleaning products suitable for hot surfaces.

1. Read the information on cleaning products.
→ Page 19
2. Clean the front of the appliance using hot soapy water and a dish cloth.

Note: Slight differences in colour on the front of the appliance are caused by the use of different materials, such as glass, plastic and metal.

3. For stainless steel appliance fronts, apply a thin layer of the stainless steel cleaning product with a soft cloth.
You can obtain the stainless steel cleaning products from the after-sales service or the online shop.
4. Dry with a soft cloth.

13.5 Cleaning the control panel

ATTENTION!

Incorrect cleaning may damage the control panel.

- ▶ Never wipe the control panel with a wet cloth.
1. Read the information on cleaning products.
→ Page 19
 2. Clean the control panel using a microfibre cloth or a soft, damp cloth.
 3. Dry with a soft cloth.

13.6 Cleaning the accessories

1. Read the information on cleaning products.
→ Page 19
2. Soften baked-on food remnants with a damp dish cloth and hot soapy water.
3. Clean the accessory with hot soapy water and a soft dish cloth or a scrubbing brush.
4. Clean the wire rack with stainless steel cleaner or in the dishwasher.
Use steel wool or oven cleaner to remove very heavy soiling.
5. Dry with a soft cloth.

13.7 Cleaning the door seal

ATTENTION!

Incorrect cleaning may damage the door seal.

- ▶ Do not use metal scrapers or glass scrapers for cleaning.
 - ▶ Do not use abrasive cleaning agents.
1. Read the information on cleaning products.
→ Page 19
 2. Clean the door seal with hot soapy water and a soft dish cloth.
 3. Dry with a soft cloth.

13.8 Drying the cooking compartment by hand

WARNING – Risk of burns!

The appliance will become hot during operation.

- ▶ Allow the appliance to cool down before cleaning it.
1. Remove any food remnants from the cooking compartment.
 2. Dry the cooking compartment with a soft cloth.
 3. Leave the appliance door open until the cooking compartment has dried completely.

13.9 Cleaning aid

The cleaning aid is a quick alternative for occasionally cleaning the cooking compartment. The cleaning aid softens dirt by vaporising the soapy water. The dirt can then be removed more easily.

Setting the cleaning aid

1. Add a few drops of washing-up liquid to a cup of water.
2. Place a spoon in the cup to prevent delayed boiling.
3. Place the cup in the centre of the cooking compartment.
4. Set the microwave output to 600 W.
5. Set the cooking time to 5 minutes.
6. Start the microwave.
7. Once the cooking time has elapsed, leave the doors closed for an additional three minutes.
8. Wipe out the cooking compartment with a soft cloth.
9. Leave the cooking compartment to dry with the door open.

14 Troubleshooting

You can rectify minor faults on your appliance yourself. Read the troubleshooting information before contacting after-sales service. This will avoid unnecessary costs.

WARNING – Risk of injury!

Improper repairs are dangerous.

- ▶ Repairs to the appliance should only be carried out by trained specialist staff.
- ▶ If the appliance is defective, call Customer Service. → "Customer Service", Page 22

WARNING – Risk of electric shock!

Improper repairs are dangerous.

- ▶ Repairs to the appliance should only be carried out by trained specialist staff.
- ▶ Only use genuine spare parts when repairing the appliance.
- ▶ If the power cord of this appliance is damaged, it must be replaced by the manufacturer, the manufacturer's Customer Service or a similarly qualified person in order to prevent any risk.

14.1 Malfunctions

Fault	Cause and troubleshooting
The appliance is not working.	The mains plug of the power cord is not plugged in. <ul style="list-style-type: none"> ▶ Connect the appliance to the power supply.
	The circuit breaker in the fuse box has tripped. <ul style="list-style-type: none"> ▶ Check the circuit breaker in the fuse box.
	There has been a power cut. <ul style="list-style-type: none"> ▶ Check whether the lighting in your room or other appliances are working.
	Malfunction <ol style="list-style-type: none"> 1. Switch off the fuse in the fuse box. 2. Switch the fuse back on after approx. 10 seconds. <ul style="list-style-type: none"> ✓ If the fault was a one-off, the message disappears. 3. If the message appears again, call the after-sales service. Please specify the exact error message when calling. <ul style="list-style-type: none"> → "Customer Service", Page 22
Appliance is not heating, colon is flashing in the display.	Demo mode is activated. <ol style="list-style-type: none"> 1. Briefly disconnect the appliance from the power supply by switching the circuit breaker in the fuse box off and then on again. 2. Deactivate demo mode within 5 minutes by changing the basic setting $\epsilon 7$ to $\bar{\epsilon}$.
Microwave mode is cancelled.	Malfunction <ol style="list-style-type: none"> 1. Switch off the fuse in the fuse box. 2. Switch the fuse back on after approx. 10 seconds. <ul style="list-style-type: none"> ✓ If the fault was a one-off, the message disappears. 3. If the message appears again, call the after-sales service. Please specify the exact error message when calling. <ul style="list-style-type: none"> → "Customer Service", Page 22
Food takes longer than usual to heat up.	The microwave power setting is set too low. <ul style="list-style-type: none"> ▶ Set a higher microwave power setting.
	You have placed a larger amount of food than normal in the appliance. <ul style="list-style-type: none"> ▶ Set a longer cooking time. <ul style="list-style-type: none"> You need double the time when you have double the amount.
	The food is colder than usual. <ul style="list-style-type: none"> ▶ Turn or stir the food from time to time during cooking.
Microwave not working.	Door is not fully closed. <ul style="list-style-type: none"> ▶ Check whether food remains or foreign material are trapped in the door.

Fault	Cause and troubleshooting
Microwave not working.	has not been pressed. ▶ Press .
12:00 flashes in the display and the ☹ symbol lights up.	There has been a power cut. ▶ Reset the time. → "Setting the time", Page 11
The appliance is not in operation. A cooking time is shown in the display.	has not been pressed. ▶ Press .

14.2 Information on display panel

Fault	Cause and troubleshooting
The message $E1$ appears on the display.	The thermal safety switch-off function has been activated. ▶ Call → "Customer Service", Page 22.
The message $E2$ appears in the display.	The automatic safety cut-out function has been activated. ▶ Press any button.
The message $E4$ appears on the display.	The thermal safety switch-off function has been activated. ▶ Call → "Customer Service", Page 22.
The message $E11$ appears in the display.	Moisture in the control panel. ▶ Allow the control panel to dry.
The message $E17$ appears on the display.	Rapid heat-up has failed ▶ Call → "Customer Service", Page 22.

15 Disposal

15.1 Disposing of old appliance

Valuable raw materials can be reused by recycling.

1. Unplug the appliance from the mains.
2. Cut through the power cord.
3. Dispose of the appliance in an environmentally friendly manner.
Information about current disposal methods are available from your specialist dealer or local authority.



This appliance is labelled in accordance with European Directive 2012/19/EU concerning used electrical and electronic appliances (waste electrical and electronic equipment - WEEE).
The guideline determines the framework for the return and recycling of used appliances as applicable throughout the EU.

16 Customer Service

Detailed information on the warranty period and terms of warranty in your country is available from our after-sales service, your retailer or on our website.

If you contact Customer Service, you will require the product number (E-Nr.) and the production number (FD) of your appliance.

The contact details for Customer Service can be found in the enclosed Customer Service directory or on our website.

This product contains light sources from energy efficiency class G. These light sources are available as a spare part and should only be replaced by trained specialist staff.

16.1 Product number (E-Nr.) and production number (FD)

You can find the product number (E-Nr.) and the production number (FD) on the appliance's rating plate. You will see the rating plate with these numbers if you open the appliance door.

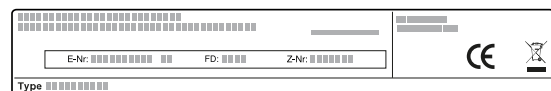

Make a note of your appliance's details and the Customer Service telephone number to find them again quickly.

17 How it works

Here, you can find the ideal settings for various dishes as well as the best accessories and cookware. We have tailored these recommendations to your appliance.

17.1 What is the best way to proceed?

In this section, you will find out the best way to proceed using step-by-step instructions to make optimal use of the recommended settings. You will get information on many meals, with details and tips on how to best use and set your appliance.

Tip: Your appliance has programmed settings for a selection of dishes. If you want to be guided by the appliance, use the automatic programmes.

WARNING – Risk of burns!

Foods with peel or skin may burst or explode during heating, or even afterwards.

- ▶ Never cook eggs in their shell or heat hard-boiled eggs in their shell.
- ▶ Never cook shellfish or crustaceans.
- ▶ Always prick the yolk of eggs before microwaving.
- ▶ The skin of foods that have a peel or skin, such as apples, tomatoes, potatoes and sausages, may burst. Before heating, prick the peel or skin.

1. Select a suitable dish from the overviews.

Tips

- If you are using the appliance for the first time, proceed in accordance with the following basic information:
 - → "Safety", Page 2
 -
 - → "Condensation", Page 11
- If you do not find the exact dish or application that you want to prepare or implement, look for a similar dish and take the general information into consideration.

2. Remove any accessories from the cooking compartment.
3. Select suitable cookware and accessories.

Defrosting with the microwave

Recommended settings for using the microwave to defrost food.

Note:

Cooking tips

- Use microwave-safe cookware without a lid.
- Turn or stir the food 2–3 times during this time. When turning, remove any liquid that escapes during defrosting.
- After defrosting, leave the food to rest for 10–60 minutes.
- Delicate parts such as the legs and wings of chicken or fatty outer layers of roasts can be covered with small pieces of aluminium foil. The foil must not touch the cooking compartment walls. You can remove the foil halfway through the defrosting time.
- Place the frozen food in an open container on the wire rack.

Use the cookware and accessories listed in the recommended settings.

4. Only preheat the appliance if the recipe or the recommended settings tell you to do so.
5. Use the recommended settings when configuring the appliance settings.
6.  **WARNING – Risk of scalding!**
Hot steam may escape when you open the appliance door. Steam may not be visible, depending on the temperature.
 - ▶ Open the appliance door carefully.
 - ▶ Keep children at a safe distance.

When the dish is ready, switch off the appliance.

17.2 Defrosting, heating and cooking with the microwave

Recommended settings for defrosting, heating and cooking with the microwave.

The cooking time depends on the cookware, as well as on the temperature, composition and quantity of the food. This is why temperature ranges are given in the tables. Begin with the lower temperature and, if necessary, use a higher setting the next time. If you use different quantities than those specified in the table, adhere to the rule of thumb: Double the amount = almost double the time, half the amount = half the time.

Tips on defrosting, heating and cooking with the microwave

Follow these tips for good results when defrosting, heating and cooking with the microwave.

Issue	Tip
You want to prepare a different amount than that indicated in the table.	Increase or reduce the cooking times using the following rule of thumb: <ul style="list-style-type: none"> ■ Double the amount = almost double the cooking time ■ Half the amount = half the cooking time

- Place the cookware in the centre of the lower wire rack so that the microwaves can reach the food from all sides.

Food	Weight in g	Microwave power setting in W	Cooking time in mins
Whole pieces of beef, veal or pork (on the bone or boned)	800	1. 180 2. 90	1. 15 ¹ 2. 10 - 20
Whole pieces of beef, veal or pork (on the bone or boned)	1000	1. 180 2. 90	1. 20 ¹ 2. 15 - 25
Whole pieces of beef, veal or pork (on the bone or boned)	1500	1. 180 2. 90	1. 30 ¹ 2. 20 - 30
Meat in pieces or slices of beef, veal or pork	200	1. 180 2. 90	1. 3 ² 2. 10 - 15
Meat in pieces or slices of beef, veal or pork	500	1. 180 2. 90	1. 5 ² 2. 15 - 20
Meat in pieces or slices of beef, veal or pork	800	1. 180 2. 90	1. 8 ² 2. 15 - 20
Minced meat, mixed ^{3, 4}	200	90	10 ¹
Minced meat, mixed ^{3, 4}	500	1. 180 2. 90	1. 5 ¹ 2. 10-15
Minced meat, mixed ^{3, 4}	800	1. 180 2. 90	1. 8 ¹ 2. 15 - 20
Poultry or poultry portions ⁵	600	1. 180 2. 90	1. 8 2. 10 - 15
Poultry or poultry portions ⁵	1200	1. 180 2. 90	1. 15 2. 25 - 30
Duck	2000	1. 180 2. 90	1. 20 ¹ 2. 30 - 40
Fish fillet, fish steak or fish slices ⁵	400	1. 180 2. 90	1. 5 2. 10-15
Whole fish	300	1. 180 2. 90	1. 3 2. 10 - 15
Whole fish	600	1. 180 2. 90	1. 8 2. 10 - 15
Vegetables, e.g. peas	300	180	10-15
Vegetables, e.g. peas	600	1. 180 2. 90	1. 10 2. 10 - 15 ⁶
Fruit, e.g. raspberries ⁵	300	180	7-10 ⁶
Fruit, e.g. raspberries ⁵	500	1. 180 2. 90	1. 8 ⁶ 2. 5-10
Butter, defrosting ⁷	125	1. 180 2. 90	1. 1 2. 2 - 4
Butter, defrosting ⁷	250	1. 180 2. 90	1. 1 2. 2 - 4
Loaf of bread	500	1. 180 2. 90	1. 6 2. 5-10
Loaf of bread	1000	1. 180 2. 90	1. 12 ⁸ 2. 15 - 25
Cakes, plain, e.g. sponge cake ^{9, 10}	500	90	15 - 20

¹ Turn the food several times.

² Separate any defrosted parts when turning.

³ Freeze the food flat.

⁴ Remove any meat that has already defrosted.

⁵ Separate any defrosted parts.

⁶ Carefully stir the food occasionally.

⁷ Remove all packaging.

⁸ Turn the food occasionally.

⁹ Only defrost cakes without icing, whipped cream, gelatine or custard.

¹⁰ Separate the pieces of cake.

Food	Weight in g	Microwave power setting in W	Cooking time in mins
Cakes, plain, e.g. sponge cake ^{9, 10}	750	1. 180 2. 90	1. 5 2. 10 - 15
Cakes, moist, e.g. fruit flan, cheesecake ⁹	500	1. 180 2. 90	1. 5 2. 10 - 15
Cakes, moist, e.g. fruit flan, cheesecake ⁹	750	1. 180 2. 90	1. 7 2. 10 - 15

¹ Turn the food several times.

² Separate any defrosted parts when turning.

³ Freeze the food flat.

⁴ Remove any meat that has already defrosted.

⁵ Separate any defrosted parts.

⁶ Carefully stir the food occasionally.

⁷ Remove all packaging.

⁸ Turn the food occasionally.

⁹ Only defrost cakes without icing, whipped cream, gelatine or custard.

¹⁰ Separate the pieces of cake.

Heating frozen food in the microwave

Observe the recommended settings when using the microwave to heat frozen food.

Note:

Cooking tips

- Use microwave-safe cookware with a lid. You can also use a plate or microwave film to cover the dish. Take ready meals out of the packaging.
- Distribute the food flat in the cookware. Food which lies flat cooks more quickly than food which is piled high.
- Turn or stir the food two or three times during the defrosting time.
- After defrosting, leave the food to rest for 2–5 minutes.
- The food transfers heat to the cookware. The cookware can become very hot. Use oven gloves.
- The food will retain most of its natural flavor. Use salt and seasonings sparingly.
- Place the cookware in the centre of the lower wire rack so that the microwaves can reach the food from all sides.

Food	Weight in g	Microwave power setting in W	Cooking time in mins
Set menu, plated meal, ready meal with 2–3 components	300–400	600	10–15
Soup	400–500	600	8–10
Stew	500	600	10–15
Stew	1000	600	20–25
Slices or pieces of meat in sauce, e.g. goulash	500	600	15–20
Slices or pieces of meat in sauce, e.g. goulash	1000	600	25–30
Fish, e.g. fillet steaks	400	600	10–15
Fish, e.g. fillet steaks	800	600	18–20
Side dishes, e.g. rice, pasta ¹	250	600	2–5
Side dishes, e.g. rice, pasta ¹	500	600	8–10
Vegetables, e.g. peas, broccoli, carrots ²	300	600	8–10
Vegetables, e.g. peas, broccoli, carrots ²	600	600	15–20
Creamed spinach ³	450	600	11–16

¹ Add a little liquid to the food.

² Pour water into the dish so that it covers the base.

³ Cook the food without any additional water.

Warming up food using the microwave mode

Observe the recommended settings for using the microwave to heat food.

⚠ WARNING – Risk of scalding!

There is a possibility of delayed boiling when a liquid is heated. This means that the liquid reaches boiling temperature without the usual steam bubbles rising to the surface. Even if the container only vibrates a little, the hot liquid may suddenly boil over and spatter.

- ▶ Always place a spoon in the container when heating liquids. This will prevent delayed boiling.

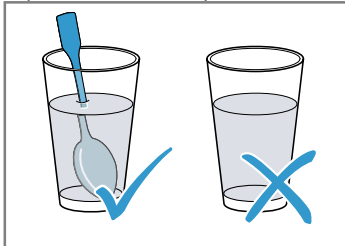

ATTENTION!

Metal touching the wall of the cooking compartment will cause sparks, which may damage the appliance or the inner door pane.

- ▶ Metal (e.g. a spoon in a glass) must be kept at least 2 cm from the cooking compartment walls and the inside of the door.

Note:

Cooking tips

- Use microwave-safe cookware with a lid. You can also use a plate or microwave film to cover the dish. Take ready meals out of the packaging.
- Distribute the food flat in the cookware. Food which lies flat cooks more quickly than food which is piled high.
- Turn or stir the food two or three times during the defrosting time.
- After defrosting, leave the food to rest for 2–5 minutes.
- The food transfers heat to the cookware. The cookware can become very hot. Use oven gloves.
- Baby food:
 - Place bottles without a teat or lid on the wire rack.
 - Stir or shake well after heating.
 - Always check the temperature of the baby food.
- Place the cookware in the centre of the lower wire rack so that the microwaves can reach the food from all sides.

Food	Weight in g	Microwave power setting in W	Cooking time in mins
Set menu, plated meal, ready meal with 2–3 components	350–500	600	5–10
Beverages ¹	150	900	1–2 ^{2, 3}
Beverages ¹	300	900	2–3 ^{2, 3}
Beverages ¹	500	900	3–4 ^{2, 3}
Baby food, e.g. baby bottles ⁴	50	360	Approx. 1 ^{5, 6}
Baby food, e.g. baby bottles ⁴	100	360	1–2 ^{5, 6}
Baby food, e.g. baby bottles ⁴	200	360	2–3 ^{5, 6}
Soup, 1 cup	175	900	2–3
Soup, 2 cups	2 x 175	900	4–5
Soup, 4 cups	4 x 175	900	5–6
Meat in sauce ⁷	500	600	10–15
Stew	400	600	5–10
Stew	800	600	10–15
Vegetables, 1 portion ⁸	150 g	600	2–3
Vegetables, 2 portions ⁸	300 g	600	3–5

¹ Place a spoon in the glass.
² Do not overheat alcoholic drinks.
³ Check the food occasionally.
⁴ Heat up baby food without the teat or lid.
⁵ Always shake the food well after heating.
⁶ Always check the temperature.
⁷ Separate the slices of meat.
⁸ Add a little liquid to the food.

Cooking with the microwave

Note:

Cooking tips

- Use microwave-safe cookware with a lid. You can also use a plate or a microwave cover to cover the dish. Take ready meals out of the packaging.
- Distribute the food flat in the cookware. Food which lies flat cooks more quickly than food which is piled high.
- After heating, leave the food to rest for 2 to 5 minutes.
- The food transfers heat to the cookware. The cookware can become very hot. Use oven gloves.

- The food will retain most of its natural flavor. Use salt and seasonings sparingly.
- Place the cookware in the centre of the lower wire rack so that the microwaves can reach the food from all sides.
- Cut vegetables and potatoes into equal-sized pieces. Add 1 – 2 tbsp water for every 100 g. Stir occasionally.
- Add double the amount of liquid to the rice.

Food	Weight in g	Microwave power setting in W	Cooking time in mins
Whole chicken, fresh, without giblets	1500	600	30 – 35 ¹
Fish fillet, fresh	400	600	5 – 10
Vegetables, fresh ²	250	600	5 – 10 ³
Vegetables, fresh ²	500	600	10 – 15 ³
Potatoes ²	250	600	8 – 10 ³
Potatoes ²	500	600	11 – 14 ³
Potatoes ²	750	600	15 – 22 ³
Rice	125 ⁴	1.600 2.180	1.7 – 9 2.15 – 20
Rice	250 ⁴	1.600 2.180	1.10 – 12 2.20 – 25
Desserts, e.g. blancmange (instant) ⁵	500	600	5 – 9
Fruit, compote	500	600	9 – 12

¹ Turn the food occasionally.

² Cut into pieces of equal size.

³ Carefully stir the food occasionally.

⁴ Add double the amount of liquid.

⁵ Stir 2 to 3 times with a whisk while heating.

Blancmange made from blancmange powder

WARNING – Risk of burns!

Heated food gives off heat. The cookware may become hot.

- ▶ Always use oven gloves to remove cookware or accessories from the cooking compartment.

1. Mix together one packet of blancmange powder with sugar and a little milk in a tall microwave-suitable bowl in accordance with the package instructions so that there are no lumps.

2. Add the rest of the milk and stir again.
3. Place the bowl into the cooking compartment and close the appliance door.
4. Set the appliance according to the recommended settings.
5. Only stir for the first time after 3 minutes. Then stir again every minute until it reaches the required consistency. The cooking time depends on the temperature of the milk and the container that is used.

Microwave popcorn

Recommended settings for cooking with the microwave.

WARNING – Risk of scalding!

When opening the popcorn bag, hot steam may be released.

- ▶ Open the popcorn bag carefully.
- ▶ Never set the full microwave power setting.

Note:

Preparation tips

- Use shallow, heat-resistant glass ovenware. Do not use porcelain or heavily curved plates.
- Always place the glass ovenware on the wire rack.
- Adjust the cooking time to the quantity.
- To prevent the popcorn from burning, after 1 minute 30 seconds, briefly take the popcorn bag out of the oven and shake it. Take care as the bag will be hot!

Food	Weight in g	Accessories	Microwave power setting in W	Cooking time in mins
Microwave popcorn	100	Cookware Pan support	600	3–5

Tips on defrosting, heating and cooking with the microwave next time

Follow these tips for good results when defrosting, heating and cooking with the microwave.

Issue	Tip
Your food is too dry.	<ul style="list-style-type: none"> Reduce the cooking time or select a lower microwave power setting. Cover the food and add more liquid.
The time has elapsed but the food is not defrosted, hot or cooked.	Increase the cooking time. Large quantities and food which is piled high require longer times.
The time has elapsed but your food is not yet done on the inside, but is already overdone on the outside.	<ul style="list-style-type: none"> Stir occasionally. Reduce the microwave power setting and increase the cooking time.
After defrosting, the poultry or meat is defrosted on the outside but not defrosted in the middle.	<ul style="list-style-type: none"> Reduce the microwave power setting. Turn large pieces of frozen food several times.

17.3 Cakes and baked items

Recommended settings for cakes and baked items. The temperature and baking time depend on the consistency and amount of the mixture. This is why ranges are given in the tables. Begin with the lower value and, if necessary, use a higher setting the next time. A lower temperature results in more even browning.

Baking tips

We have compiled a few tips to help you achieve a good baking result.

Cakes in tins

Note:

Cooking tips













- The recommended settings apply to dishes placed into the non-preheated appliance.
- Always place the cake tin in the centre of the wire rack.
- Use heat-resistant, microwave-safe cookware.
- Metal baking tins are not suitable for baking with microwaves.
- Dark-coloured metal baking tins are most suitable.
- The times given apply to food placed in a cold oven.

Food	Accessory/cookware	Type of heating	Temperature in °C	Microwave power setting in watts	Cooking time in mins
Sponge cake, simple	Vienna ring tin/loaf tin	☉	170–180	90	40–50
Sponge cake, delicate (e.g. sand cake) ¹	Vienna ring tin/loaf tin	☉	150–170	-	70–90
Sponge flan base	Flan tin	☉	160–180	-	30–40
Delicate fruit flan, sponge	Springform/ring tin	☉	170–180	90	35–45
Sponge base, 2 eggs	Dark-coloured springform tin	☉	160–170	-	20–25
Sponge base, 6 eggs	Dark-coloured springform tin	☉	170–180	-	35–45

¹ Allow cakes to cool in the oven for approx. 20 minutes.

² Place the dish directly on the turntable.

Issue	Tip
You want your cake to rise evenly.	<ul style="list-style-type: none"> Only grease the base of the springform cake tin. After baking, use a knife to carefully loosen the cake from the baking tin.
You do not want small baked items to stick to each other when baking.	Leave a minimum clearance of 2 cm around each item to be baked. This allows enough space for the baked items to expand and brown on all sides.
Determine whether the cake is ready.	Push a cocktail stick into the highest point on the cake. If no dough sticks to the wood, the cake is ready.
You want to bake using your own recipe.	Use similar items in the baking tables as a guide.
Use bakeware made of silicone, glass, plastic or ceramic.	<ul style="list-style-type: none"> The bakeware must be heat-resistant up to 250 °C. Cakes in this bakeware brown less. When using the microwave, the cooking time is shorter than the time shown in the table.

Food	Accessory/cookware	Type of heating	Temperature in °C	Microwave power setting in watts	Cooking time in mins
Shortcrust pastry base with crust	Dark-coloured springform tin		170–190	-	30–40
Fruit tart or cheesecake with shortcrust pastry base ¹	Dark-coloured springform tin		170–190	180	35–45
Swiss flan ²	Dark-coloured springform tin		190–200	-	45–55
Bundt cake	Bundt cake tin		170–180	-	40–50
Pizza, thin base, light topping ²	Round pizza tray		220–230	-	15–25
Savoury cakes ²	Dark-coloured springform tin		200–220	-	50–60
Nut cake	Dark-coloured springform tin		170–180	90	35–45
Yeast dough with dry topping	Round pizza tray		160–180	-	50–60
Yeast dough with moist topping	Round pizza tray		170–190	-	55–65
Plaited loaf with 500 g flour	Round pizza tray		170–190	-	35–45
Stollen with 500 g flour	Round pizza tray		160–180	-	60–70
Strudel, sweet	Round pizza tray		190–210	180	35–45





¹ Allow cakes to cool in the oven for approx. 20 minutes.
² Place the dish directly on the turntable.

Small baked items

Note:

Cooking tips

- The recommended settings apply to dishes placed into the non-preheated appliance.
- Always place the cake tin in the centre of the wire rack.
- Dark-coloured metal baking tins are most suitable.



Food	Accessories/cookware	Heating function	Temperature in °C	Cooking time in min
Biscuits	Round pizza tray		150–170	25–35
Macarons	Round pizza tray		110–130	35–45
Choux pastry	Round pizza tray		200–220	35–45
Puff pastry	Round pizza tray		190–200	35–45
Leavened cake	Round pizza tray		200–220	25–35

Bread and bread rolls

Note:

Cooking tips

- The recommended settings apply to dishes placed into the non-preheated appliance.
- Always place the cake tin in the centre of the wire rack.
- Dark-coloured metal baking tins are most suitable.

Food	Accessories/cookware	Heating function	Temperature in °C	Cooking time in min
Sourdough bread with 1.2 kg flour	Round pizza tray		210–230	50–60
Flatbread ¹	Round pizza tray		220–230	25–35

¹ Place the dish directly on the turntable.

Food	Accessories/cookware	Heating function	Temperature in °C	Cooking time in min
Bread rolls	Round pizza tray	🌀	210–230	25–35
Rolls made with sweet yeast dough	Round pizza tray	🌀	200–220	15–25

¹ Place the dish directly on the turntable.

Tips for next time you bake

If something goes wrong when baking, you can find some tips here.

Issue	Tip
Your cake collapses.	<ul style="list-style-type: none"> ▪ Note the ingredients and preparation instructions that are given in the recipe. ▪ Use less liquid. Or: ▪ Reduce the baking temperature by 10 °C and increase the baking time.
Your cake is too dry.	Increase the baking temperature by 10 °C and shorten the baking time.
Your cake is generally too light in colour.	<ul style="list-style-type: none"> ▪ Check the shelf position and accessories. ▪ Increase the baking temperature by 10 °C. Or: ▪ Increase the baking time.
Your cake is too light on top and too dark underneath.	Slide the cake in one level higher.
Your cake is too dark on top and too light underneath.	<ul style="list-style-type: none"> ▪ Slide the cake in one level lower. ▪ Reduce the baking temperature and increase the baking time.
Your cake is unevenly browned.	<ul style="list-style-type: none"> ▪ Reduce the baking temperature. ▪ Cut the greaseproof paper to a suitable size. ▪ Place the baking tin in the centre. ▪ As far as possible, shape small baked items to be the same size and thickness.

Issue	Tip
Your cake is cooked on the outside but is not fully baked through on the inside.	<ul style="list-style-type: none"> ▪ Reduce the baking temperature and increase the baking time. ▪ Add less liquid. <p>For cakes with a moist topping:</p> <ul style="list-style-type: none"> ▪ Pre-bake the base. ▪ Sprinkle the baked base with almonds or breadcrumbs. ▪ Place the topping on the base.
The cake will not come out of the tin when turned upside down.	<ul style="list-style-type: none"> ▪ Allow the cake to cool for 5–10 minutes after baking. ▪ Use a knife to carefully loosen the edge of the cake. ▪ Turn the cake tin upside down again and cover it several times with a cold, wet cloth. ▪ Next time you bake, grease the baking tin and sprinkle it with breadcrumbs.
Sparks are generated between the tin and the wire rack.	<ul style="list-style-type: none"> ▪ Check that the tin is clean on the outside. ▪ Change the position of the tin in the cooking compartment. ▪ Continue baking without the microwave and increase the baking time.

17.4 Roasting and grilling

Recommended settings for roasting and grilling
 The temperature and roasting time depend on the type and amount of food being cooked. This is why ranges are given in the tables. Begin with the lower value and, if necessary, use a higher setting the next time.

Roasting in cookware

If you prepare dishes in cookware, you can remove them from the cooking compartment more easily and serve them directly in the cookware. When preparing food in cookware with a lid, the cooking compartment remains cleaner.

General information about roasting in cookware

- Use heat-resistant, microwave-safe cookware.

- Metal roasting dishes are not suitable for roasting with microwaves.
- Place the cookware onto the wire rack.
- Check in advance whether the cookware fits in the cooking compartment.
- Glass cookware is best.
Place hot glass ovenware on a dry mat after cooking. The glass may crack if placed on a cold or wet surface.
- The cookware can become very hot. Use oven gloves to take the cookware out of the oven.
- Follow the manufacturer's instructions for your roasting dishes.

Cookware without lid

Use a deep roasting dish.

Cookware with lid

- Use a suitable lid that seals well.
- When roasting meat, there should be at least 3 cm between the food and the lid as the meat may expand.
- Meat, poultry and fish can also become crispy in a covered roasting dish. Use a roasting dish with a glass lid. If necessary, set a higher temperature.

⚠ WARNING – Risk of scalding!

Very hot steam may escape when the lid is opened after cooking. Steam may not be visible, depending on the temperature.

- ▶ Lift the lid in such a way that the hot steam can escape away from you.
- ▶ Keep children away from the appliance.

Notes

- Lean meat or pot roast
 - Add liquid to the cookware so that it is approx. 1/2 cm deep, e.g. water, wine, vinegar or similar liquid.
The amount of liquid depends on the type of meat, what the cookware is made of and on whether or not a lid is used.
More liquid needs to be added to enamelled or dark metal roasting pan than for glass cookware. Add slightly more liquid for pot roasts.
 - During roasting, the liquid in the roasting dish will evaporate. Carefully add liquid as necessary.
 - Turn pieces of meat halfway through the cooking time.
- Fish
 - When steaming fish, add one to three tablespoons of liquid to the cookware, e.g. lemon juice or vinegar.

Grilling

Grill foods that should be crispy.

Beef

Note:

Cooking tips

- The recommended settings apply to dishes placed into the non-preheated appliance.
- Turn pot-roasted beef after 1/3 and 2/3 of the cooking time. Allow the dish to stand for around a further 10 minutes at the end.
- Turn sirloin and steaks halfway through the cooking time. Allow the dish to stand for around a further 10 minutes at the end.

- Do not grill food with the oven door open.
- Do not preheat.
- Use food to be grilled that is of a similar weight and thickness.
This allows the food to be grilled to brown evenly and remain succulent and juicy.
- Place the food to be grilled directly on the wire rack.
- Use grill tongs to turn the grilled items.
If you pierce the meat with a fork, the juices will run out and it will become dry.
- Do not add salt until after the meat has been grilled.
Salt draws water from the meat.

Note: Dark meat, such as beef, browns more quickly than lighter-coloured meat, such as veal or pork. When grilling light-coloured meat or fish, these often only brown slightly on the surface, although they are cooked and juicy on the inside.

The grill element switches on and off continuously. This is normal. The frequency of this depends on the grill level that is set.





Smoke may be produced when grilling.

Tips for roasting and braising

Follow these tips for good results when roasting and braising.

Issue	Tip
Prevent lean meat from drying out.	<ul style="list-style-type: none"> ■ Coat lean meat with fat or oil as required and cover it with strips of bacon.
Prepare joints with the rind on.	<ul style="list-style-type: none"> ■ Score the rind in a criss-cross pattern. ■ Roast the joint with the rind facing down first.
Keep the cooking compartment as clean as possible.	<ul style="list-style-type: none"> ■ Prepare the food in a covered roasting dish at a higher temperature.
The meat should remain succulent and hot, e.g. roast beef.	<ul style="list-style-type: none"> ■ When the roast is ready, switch off the oven and leave it to rest for 10 minutes in the cooking compartment with the door closed. This helps distribute the meat juices more evenly. The resting time is not included in the indicated cooking time. ■ After preparing it, wrap the food in foil.

- Turn steaks after 2/3 of the cooking time.



Food	Accessory/cookware	Type of heating	Temperature in °C	Microwave power setting in watts	Cooking time in mins
Pot-roasted beef, approx. 1 kg	Cookware with lid		180–200	-	120–143
Fillet of beef, medium, approx. 1 kg	Cookware without lid		180–200	90	30–40
Sirloin, medium, approx. 1 kg	Cookware without lid		210–230	180	30–40
Steak, medium, 3 cm thick	Tall wire rack		3	-	10–25

Veal

Note:

Cooking tips

- The recommended settings apply to dishes placed into the non-preheated appliance.
- Turn joints and knuckle of veal halfway through the cooking time. Allow the dish to stand for around a further 10 minutes at the end.





Food	Accessory/cookware	Type of heating	Temperature in °C	Microwave power setting in watts	Cooking time in mins
Joint of veal, approx. 1 kg	Cookware with lid		180–200	-	110–130
Knuckle of veal, approx. 1.5 kg	Cookware with lid		200–220	-	120–130

Pork

Note:

Cooking tips

- The recommended settings apply to dishes placed into the non-preheated appliance.
- Turn rindless joints halfway through the cooking time. Allow the joint to stand for around a further 10 minutes at the end.
- Place the joint in the cookware rind-side up. Score the rind. Do not turn the joint. Allow the joint to stand for around a further 10 minutes at the end.
- Do not turn fillets of pork or smoked pork. Allow the dish to stand for around a further five minutes at the end.
- Turn neck steaks after 2/3 of the cooking time.



Food	Accessory/cookware	Type of heating	Temperature in °C/grill setting	Microwave power setting in watts	Cooking time in mins
Rindless joint, e.g. pork neck, approx. 750 g	Cookware with lid		220–230	180	40–50
Joint with rind, e.g. shoulder, approx. 1.5 kg → "Baking", Page 000	Cookware without lid		190–210	-	130–150
Fillet of pork, approx. 500 g* → "Baking", Page 000	Cookware with lid		220–230	90	25–30
Joint of pork, lean, approx. 1 kg → "Baking", Page 000	Cookware with lid		210–230	90	60–80
Smoked pork on the bone, approx. 1 kg → "Baking", Page 000	Cookware without lid	-	-	360	45
Neck of pork, 2 cm thick → "Grilling", Page 000			3	-	15–20 10–15

Lamb

Note:

Cooking tips

- The recommended settings apply to dishes placed into the non-preheated appliance.
- Turn the leg of lamb halfway through the cooking time.



Food	Accessory/cookware	Type of heating	Temperature in °C/grill setting	Microwave power setting in watts	Cooking time in mins
Saddle of lamb on the bone, approx. 1 kg	Cookware without lid		210–230	-	40–50
Leg of lamb, boned, medium, approx. 1.5 kg	Cookware with lid		190–210	-	90–95

Other meat dishes

Note:

Cooking tips

- The recommended settings apply to dishes placed into the non-preheated appliance.
- Allow the meatloaf to stand for around a further 10 minutes at the end.
- Turn the sausages after 2/3 of the cooking time.







Food	Accessory/cookware	Type of heating	Temperature in °C/grill setting	Microwave power setting in watts	Cooking time in mins
Meatloaf, approx. 1 kg → "Baking", Page 000	Cookware without lid		180–200	600+180	-
Sausages for grilling, 4 to 6 pcs, approx. 150 g each → "Grilling", Page 000	-		3	-	10–15



Poultry

Note:

Cooking tips

- The recommended settings apply to dishes placed into the non-preheated appliance.
- Arrange whole chickens breast-side down. Turn after 2/3 of the cooking time.
- Place poulard breast-side down. Turn after 30 minutes and set the microwave power setting to 180 watts.
- Place half chickens, chicken portions, duck breast and goose breast skin-side up. Do not turn the dishes.
- Turn goose legs halfway through the cooking time. Pierce the skin.
- Place turkey breast and thighs skin-side down. Turn after 2/3 of the cooking time.

Food	Accessory/cookware	Type of heating	Temperature in °C/grill setting	Microwave power setting in watts	Cooking time in mins
Chicken, whole, approx. 1.2 kg	Cookware with lid		220–230	360	35–45
Poulard, whole, approx. 1.6 kg	Cookware with lid		220–230	360 180	30 20–30
Chicken, halves, 500 g each	Cookware without lid		180–200	360	30–35
Chicken portions, approx. 800 g	Cookware without lid		210–230	360	20–30
Chicken breast with skin and bones, 2 pieces, approx. 350–450 g	Cookware without lid		190–210	180	30–40
Duck breast with skin, 2 pieces, 300–400 g each	Cookware without lid		3	90	20–30
Goose breast, 2 pieces, 500 g each	Cookware without lid		210–230	90	25–30



Food	Accessory/cookware	Type of heating	Temperature in °C/grill setting	Microwave power setting in watts	Cooking time in mins
Goose legs, 4 pieces, approx. 1.5 kg	Cookware without lid		210–230	180	30–40
Turkey breast, approx. 1 kg	Cookware with lid		200–220	-	90–100
Turkey drumsticks, approx. 1.3 kg	Cookware with lid		200–220	180	50–60

Fish

Note:

Cooking tips

- The recommended settings apply to dishes placed into the non-preheated appliance.
- For grilling, place the whole fish, e.g. salmon or trout, onto the middle of the wire rack.
- Grease the wire rack with oil beforehand.

Food	Accessories/cookware	Heating function	Temperature in °C	Cooking time in min
Fish steak, e.g. salmon, 3 cm thick, grilled	Tall wire rack		3	20–25
Fish, whole, 2–3 pcs, 300 g each, grilled	Tall wire rack		3	20–30

Tips for next time you roast

If roasting is not successful the first time, you can find some tips here.

Issue	Tip
Your roast is too dark and the crackling is partly burnt.	<ul style="list-style-type: none"> ■ Select a lower temperature. ■ Reduce the roasting time.
Your roast is too dry.	<ul style="list-style-type: none"> ■ Select a lower temperature. ■ Reduce the roasting time.
The crackling on your roast is too thin.	<ul style="list-style-type: none"> ■ Increase the temperature. Or: ■ Switch on the grill briefly at the end of the roasting time.
Your roasting juices are burnt.	<ul style="list-style-type: none"> ■ Select a smaller item of cookware. ■ When roasting, add more liquid.

Issue	Tip
Your roasting juices are too clear and watery.	<ul style="list-style-type: none"> ■ Use a larger item of cookware so that more liquid evaporates. ■ When roasting, add less liquid.
The meat catches during braising.	<ul style="list-style-type: none"> ■ Check whether the roasting dish and lid fit together and close properly. ■ Reduce the temperature. ■ Add liquid when braising.
Your roast is not well-done enough.	<ul style="list-style-type: none"> ■ Carve the meat into portions. ■ Prepare the juices in the roasting dish. ■ Place the sliced meat in the juices. ■ Place the slices of meat in the microwave to finish cooking.





17.5 Bakes

Note:

Cooking tips

- Use a 4–5 cm deep microwave-safe, heat-resistant dish for bakes and potato gratins.
- Leave bakes and gratins to cook in the oven for a further five minutes after the oven has been switched off.
- Toast the slices of bread first.
- Place the bakes on the lower wire rack.

- The recommended settings apply to dishes placed into the non-preheated appliance.















Food	Accessory/cookware	Type of heating	Temperature in °C	Microwave power setting in watts	Cooking time in mins
Sweet bake, approx. 1.5 kg	Cookware without lid		140–160	360	25–35
Savoury bake, made with cooked ingredients, approx. 1 kg	Cookware without lid		150–170	600	20–25
Lasagne, fresh	Cookware without lid		200–220	360	25–35
Potato gratin made from raw ingredients, approx. 1.1 kg	Cookware without lid		180–200	600	25–30
Toast with topping, 4 slices	Tall wire rack		3	-	8–10

17.6 Frozen convenience products

Note:

Cooking tips

- Follow the manufacturer's instructions on the packaging.
- Do not arrange chips, croquettes or potato röstis on top of each other. Turn these halfway through the cooking time.
- Place the food directly on the turntable.
- The recommended settings apply to dishes placed into the non-preheated appliance

Food	Accessory/cookware	Type of heating	Temperature in °C/grill setting	Microwave power setting in watts	Cooking time in mins
Thin-crust pizza	Turntable		220–230	-	10–15
Deep-pan pizza	Turntable		-	600	3
			220–230	-	13–18
Mini pizza	Turntable		220–230	-	10–15
Pizza baguette	Turntable		-	600	2
			220–230	-	13–18
Chips	Turntable		220–230	-	8–13
Croquettes	Turntable		210–220	-	13–18
Rösti, stuffed potato pockets	Turntable		200–220	-	25–30
Part-cooked rolls or part-cooked baguette	Low wire rack		170–180	-	13–18
Fish fingers	Turntable		210–230	-	10–20
Chicken goujons, nuggets	Turntable		200–220	-	15–20
Strudel	Turntable		210–220	180	20–30
Lasagne, approx. 400 g	Low wire rack		220–230	600	12–17

17.7 Test dishes

These overviews have been produced for test institutes to facilitate appliance testing in accordance with EN 60350-1:2013 or IEC 60350-1:2011 and EN 60705:2012, IEC 60705:2010.

Defrosting with the microwave

Recommended settings for using the microwave to defrost food.

Food	Microwave power setting in W	Cooking time in mins	Note:
Meat	1.180 2.90	1.5 2.10–15	Place the Pyrex dish (22 cm diameter) on the turntable. Remove the defrosted meat after approx. 13 minutes.



Cooking with the microwave

Recommended settings for cooking with the microwave.

Food	Microwave power setting in W	Cooking time in mins	Note:
Egg and milk mixture	1.600 2.180	1.10–13 2.25–30	Place a 24 x 19 cm Pyrex dish on the lower wire rack.
Sponge	600	9–10	Place a Pyrex dish with a diameter of 22 cm on the lower wire rack.
Meatloaf	600	18–23	Place the 28 cm Pyrex dish on the lower wire rack.

Cooking in combination with a microwave



Recommended settings for cooking with the microwave.

Food	Microwave power setting in W	Type of heating	Cooking time in mins	Temperature in °C	Note:
Potato gratin	600		25–30	210–220	Place a Pyrex dish with a diameter of 22 cm on the lower wire rack.
Cakes	180		15–20	180–200	Place a Pyrex dish with a diameter of 22 cm on the lower wire rack.
Cakes	360		35–40	200–220	Turn after 2/3 of the cooking time.

Baking



Recommended settings for baking test dishes.

Note: The recommended settings apply to dishes placed into the non-preheated appliance.

Food	Accessories/cook-ware	Heating function	Temperature in °C	Cooking time in min
Hot water sponge cake	Springform cake tin, diameter 26 cm Low wire rack		160–180	30–40
Double-crust apple pie	Springform cake tin, diameter 20 cm Low wire rack		190–210	50–60

Grilling

Recommended settings for grilling test dishes.

Food	Accessory/cookware	Type of heating	Grill setting	Cooking time in mins
Toasting bread	Tall wire rack		3	4–5
Beef burgers, x 9	Tall wire rack		3	30–35

18 Installation instructions

Observe this information when installing the appliance.



18.1 Scope of delivery

After unpacking all parts, check for any damage in transit and completeness of the delivery.

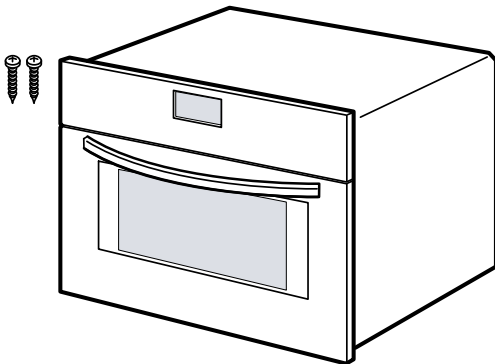

18.2 Safe installation

Follow these safety instructions when installing the appliance.

- The appliance can only be used safely if it is correctly installed according to the safety instructions. The installer is responsible for ensuring that the appliance works perfectly at its installation location.

- Do not use the door handle for the transport or installation.
- Check the appliance for damage after unpacking it. Do not connect the appliance if it has been damaged in transit.
- Before starting up the appliance, remove any packaging material and adhesive film from the cooking compartment and the door.
- Proceed in accordance with the installation sheets for installing accessories.
- Fitted units must be heat-resistant up to 95 °C, and adjacent unit fronts up to 70 °C.
- Do not install the appliance behind a decorative door or the door of a kitchen unit. There is a risk of overheating.
- Cut-out work on the units should be carried out before installing the appliance. Remove any shavings. Otherwise, the correct operation of electrical components may be adversely affected.
- Only a licensed professional may connect appliances without plugs. Damage caused by incorrect connection is not covered under the warranty.

WARNING – Risk of injury!

Parts that are accessible during installation may have sharp edges and may lead to cutting injuries.

- ▶ Wear protective gloves.

⚠ WARNING – Risk of fire!

It is dangerous to use an extended power cord and non-approved adapters.

- ▶ Do not use extension cables or multiple socket strips.
- ▶ Only use adapters and power cords approved by the manufacturer.
- ▶ If the power cord is too short and a longer one is not available, please contact an electrician to have the domestic installation adapted.

ATTENTION!

Carrying the appliance by the door handle could break it. The door handle cannot support the weight of the appliance.

- ▶ Do not carry or hold the appliance by the door handle.

18.3 Electrical connection

In order to safely connect the appliance to the electrical system, follow these instructions.

- The appliance corresponds to protection class I and must only be operated with a protective earth connection.
- The fuse protection must correspond to the power rating specified on the appliance's rating plate and to the local regulations.
- The appliance must be disconnected from the power supply whenever installation work is being carried out.

Electrically connecting the appliance with the protective contact plug

Note: The appliance must only be connected to a protective contact socket that has been correctly installed.

- ▶ Insert the mains plug of the appliance into a nearby socket.
When the appliance is installed, the mains plug of the power cable must be freely accessible. If free access to the mains plug is impossible, an all-pole isolating switch must be integrated into the permanent electrical installation in accordance with the installation regulations.

Electrically connecting an appliance without a protective contact plug

Note: Only licensed specialists may connect the appliance. Damage caused by incorrect connection is not covered under the warranty. An isolating switch must be integrated into the permanent electrical installation according to the installation regulations.

1. Identify the phase and neutral conductors in the socket.
The appliance may be damaged if it is not connected correctly.
2. See the rating plate for the voltage.
3. Connect the wires of the mains power cable according to the colour coding:
 - Green/yellow = Protective conductor ⊕

- Blue = Neutral conductor
- Brown = Phase (external conductor)

18.4 Fitted units

This appliance is only intended to be fully fitted in a kitchen. It is not intended to be used as a tabletop appliance or within a cupboard.

The installation cabinet must not have a back panel behind the appliance. Maintain a clearance of at least 35 mm between the wall and the cabinet base or the rear panel of the cabinet situated above.

The installation cabinet must have a ventilation opening of 50 cm² on the front. To do this, trim the base panel or fit a ventilation grille. Do not cover ventilation slots and air intake openings.

18.5 Installation in a tall unit

Observe the installation dimensions and the safety clearances in a tall unit.

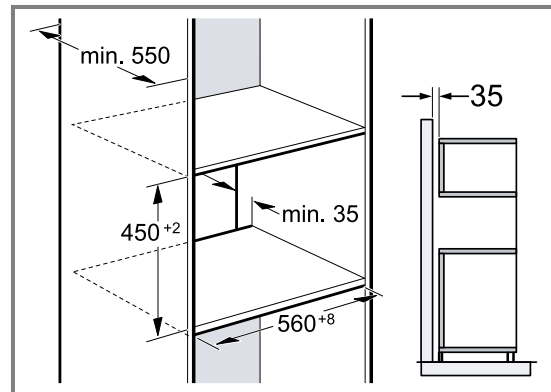

To ventilate the appliance, the intermediate floor must have a ventilation cut-out.

If the tall unit has another back panel in addition to the element back panels, this must be removed.

Only install the appliance up to a height which allows the accessory to be easily removed.

18.6 Installing two appliances on top of each other

Your appliance can also be installed above or below another appliance. Observe the installation dimensions and the installation instructions when installing appliances on top of each other.

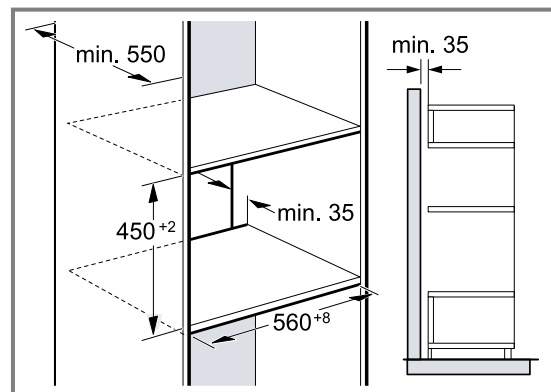

To ventilate the appliances, the intermediate floor must have a ventilation cut-out.

To ensure sufficient ventilation of the two appliances, there must be a ventilation opening of at least 200 cm² in the plinth area. To do this, trim the base panel or fit a ventilation grille. Ensure that air exchange is guaranteed in accordance with the diagram.

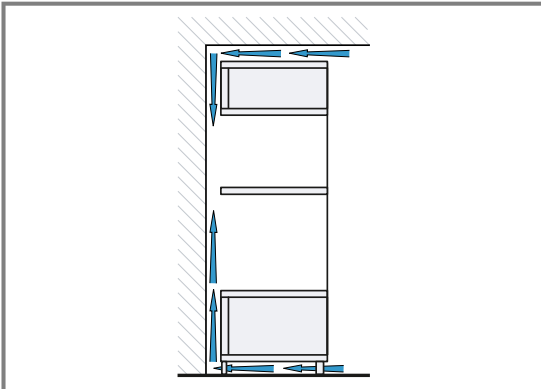

Only install appliances up to a height that allows the accessory to be easily removed.

18.7 Installation below a worktop

Observe the installation dimensions and the safety clearances when installing below a worktop. To ventilate the appliance, the intermediate floor must have a ventilation cut-out.

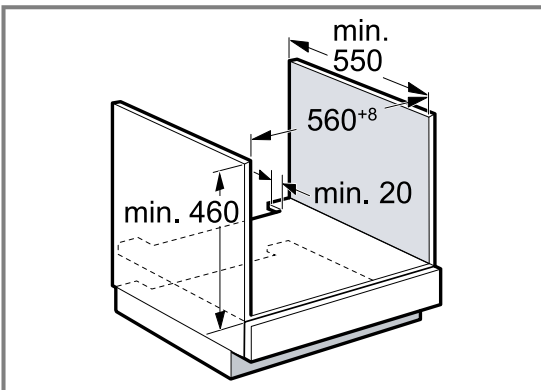

The worktop must be secured to the fitted unit.

18.8 Installing below a hob

If the appliance is installed below a hob, the following minimum dimensions must be adhered to (including substructure, if applicable).

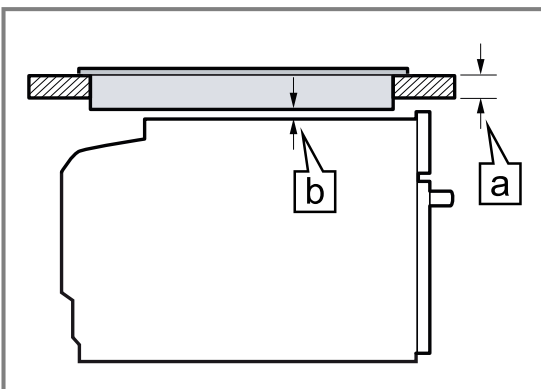

The minimum worktop thickness **b** is based on the required minimum clearance **a**.

Hob type	a raised in mm	a flush in mm	b in mm
Induction hob	45	46	5
Full-surface induction hob	55	56	5
Gas hob	35	46	5 ¹
Electric hob	35	38	2

¹ Observe different national installation instructions for the hob.

Observe the installation instructions for the hob.

18.9 Corner installation

Observe the installation dimensions and the safety clearances when installing in a corner.

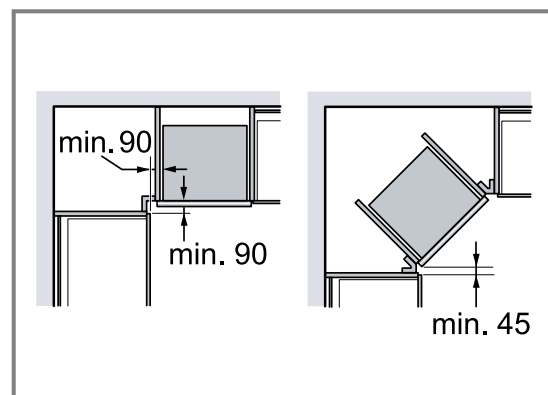

18.10 Installing the appliance

1. Centre the appliance.
2. Screw the appliance onto the unit.

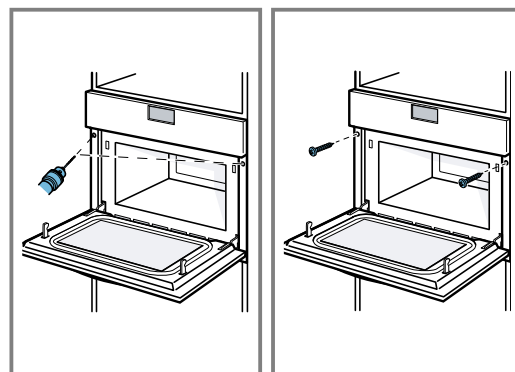

18.11 For handleless kitchens with vertical bar handle strips:

1. Attach a suitable filling piece on both sides in order to cover any sharp edges and to guarantee safe installation.

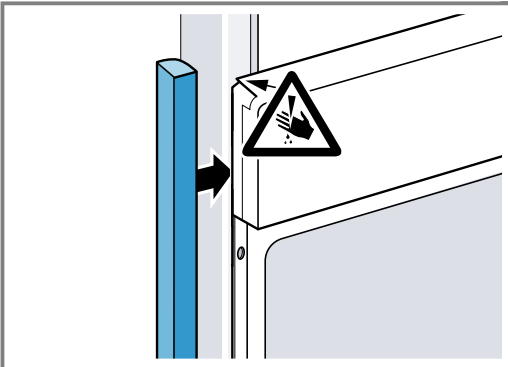

2. Secure the filling piece to the unit.
3. Pre-drill the filling piece and the unit to establish a screw connection.

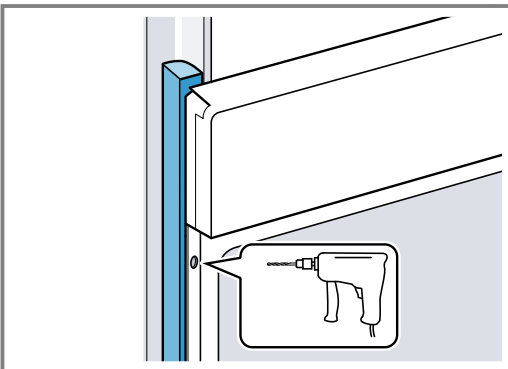

4. Secure the appliance using a suitable screw.

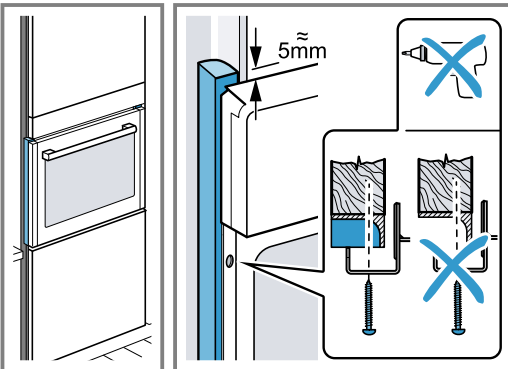

18.12 Removing the appliance

1. Disconnect the appliance from the power supply.
2. Undo the fastening screws.
3. Lift the appliance slightly and pull it out completely.



A sheet of white paper with horizontal ruling lines, typical of a notebook page. The lines are evenly spaced and extend across the width of the page. There is a small black square icon in the top left corner containing a white pencil.



Thank you for buying a Bosch Home Appliance!

Register your new device on MyBosch now and profit directly from:

- **Expert tips & tricks for your appliance**
- **Warranty extension options**
- **Discounts for accessories & spare-parts**
- **Digital manual and all appliance data at hand**
- **Easy access to Bosch Home Appliances Service**

Free and easy registration – also on mobile phones:

www.bosch-home.com/welcome

BOSCH
HOME APPLIANCES
SERVICE

Looking for help? You'll find it here.

Expert advice for your Bosch home appliances, help with problems or a repair from Bosch experts.

Find out everything about the many ways Bosch can support you:

www.bosch-home.com/service

Contact data of all countries are listed in the attached service directory.

BSH Hausgeräte GmbH

Carl-Wery-Straße 34
81739 München, GERMANY
www.bosch-home.com

A Bosch Company



9001610640 (040415)

en

Valid within Great Britain:
Imported to Great Britain by
BSH Home Appliances Ltd.
Grand Union House
Old Wolverton Road
Wolverton, Milton Keynes
MK12 5PT
United Kingdom