



BOSCH



Register your
new device on
MyBosch now and
get free benefits:
**[bosch-home.com/
welcome](https://bosch-home.com/welcome)**

Hob

PXY8..D...

[en] Instruction manual

Hob

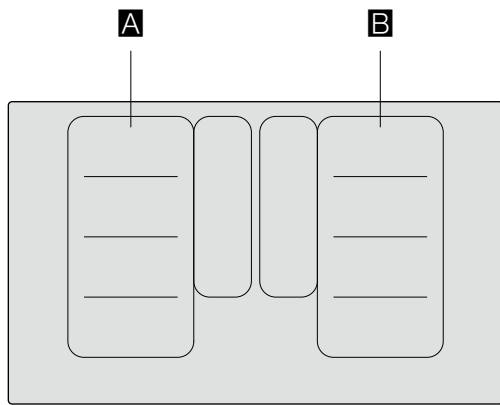

| | | g^* | b^* |
|--------------|--|---------|---------|
| A / B | | 2.200 W | 3.700 W |
| | | 3.300 W | 3.700 W |
| | | 2.600 W | 3.700 W |
| | | 3.300 W | 3.700 W |

*  IEC 60335-2-6

Table of contents

| | | | |
|--|----|---|----|
|  Intended use | 4 |  Keep warm function | 19 |
|  Important safety information | 5 | Activating | 19 |
|  Causes of damage | 6 | Deactivating | 19 |
| Overview | 6 |  Transferring settings | 20 |
|  Environmental protection | 7 | Activation | 20 |
| Energy-saving advice | 7 |  Cooking assist functions | 21 |
| Environmentally-friendly disposal | 7 | Cooking assistant function types | 21 |
|  Induction cooking | 7 | Suitable cookware | 22 |
| Advantages of induction cooking | 7 | Sensors and special accessories | 22 |
| Cookware | 7 | Functions and heat settings | 22 |
|  Getting to know your appliance | 9 | Recommended dishes | 26 |
| The control panel | 9 | Teppan Yaki and Grill for the Flex Zone | 34 |
| The hotplates | 10 |  Wireless temperature sensor | 36 |
| Residual heat indicator | 10 | Preparing and maintaining the wireless temperature sensor | 36 |
|  Operating the appliance | 11 | Connecting the wireless temperature sensor to the control panel | 36 |
| Switching the hob on and off | 11 | Cleaning | 37 |
| Setting a hotplate | 11 | Changing the battery | 37 |
| Chef's recommendations | 12 | Declaration of Conformity | 38 |
|  Flex Zone | 14 |  Childproof lock | 38 |
| Advice on using cookware | 14 | Activating and deactivating the childproof lock | 38 |
| As two independent hotplates | 14 | Childproof lock | 38 |
| As a single hotplate | 14 |  Wipe protection | 39 |
|  Move function | 15 |  Automatic safety cut-out | 39 |
| Activation | 15 |  Basic settings | 40 |
| Deactivating | 15 | To access the basic settings: | 41 |
|  FlexPlus Zone | 16 |  Energy consumption indicator | 42 |
| Notes regarding cookware | 16 |  Cookware check | 42 |
| Activation | 16 |  Power manager | 43 |
| Deactivating | 16 |  Cleaning | 43 |
|  Time-setting options | 17 | Hob | 43 |
| Programming the cooking time | 17 | Hob surround | 43 |
| The kitchen timer | 17 |  Frequently Asked Questions (FAQ) | 44 |
| Stopwatch function | 18 |  Trouble shooting | 46 |
|  PowerBoost function | 18 |  Customer service | 48 |
| Activating | 18 | E number and FD number | 48 |
| Deactivating | 18 |  Test dishes | 49 |
|  ShortBoost function | 19 | | |
| Recommendations for use | 19 | | |
| Activating | 19 | | |
| Deactivating | 19 | | |

Additional information on products, accessories, replacement parts and services can be found at www.bosch-home.com and in the online shop www.bosch-eshop.com

Intended use

Read these instructions carefully. Please keep the instruction and installation manual, as well as the appliance certificate, in a safe place for later use or for subsequent owners.

Check the appliance after removing it from the packaging. If it has suffered any damage in transport, do not connect the appliance, contact the Technical Assistance Service and provide written notification of the damage caused, otherwise you will lose your right to any type of compensation.

Only a licensed professional may connect appliances without plugs. Damage caused by incorrect connection is not covered under warranty.

This appliance must be installed according to the installation instructions included.

This appliance is intended for private domestic use and the household environment only. The appliance must only be used for the preparation of food and beverages. The cooking process must be supervised. A short cooking process must be supervised without interruption. Only use the appliance in enclosed spaces.

This appliance is intended for use up to a maximum height of 4000 metres above sea level.

Do not use covers. These can cause accidents, for example due to overheating, catching fire or materials shattering.

Only use safety devices or child protection grilles approved by ourselves. Unsuitable safety devices or child protection grilles may result in accidents.

This appliance is not intended for operation with an external clock timer or a remote control.

This appliance may be used by children over the age of 8 years old and by persons with reduced physical, sensory or mental capabilities or by persons with a lack of experience or knowledge if they are supervised or are instructed by a person responsible for their safety how to use the appliance safely and have understood the associated hazards.

Children must not play with, on, or around the appliance. Children must not clean the appliance or carry out general maintenance unless they are at least 15 years old and are being supervised.

Keep children below the age of 8 years old at a safe distance from the appliance and power cable.

When using the cooking functions, set the hotplate on which you have placed the saucepan with the temperature sensor.

If you wear an active implantable medical device (e.g. a pacemaker or defibrillator), check with your doctor that it complies with Council Directive 90/385/EEC of 20th June 1990, DIN EN 45502-2-1 and DIN EN 45502-2-2, and that it has been chosen, implanted and programmed in accordance with VDE-AR-E 2750-10. If these conditions are satisfied, and if, in addition, non-metal cooking utensils and cookware with non-metal handles are used, it is safe to use this induction hob as intended.

Important safety information

Warning – Danger of suffocation!

Packaging material is dangerous to children. Never allow children to play with packaging material.

Warning – Risk of fire!

- Hot oil and fat can ignite very quickly. Never leave hot fat or oil unattended. Never use water to put out burning oil or fat. Switch off the hotplate. Extinguish flames carefully using a lid, fire blanket or something similar.
- The hotplates become very hot. Never place combustible items on the hob. Never place objects on the hob.
- The appliance gets hot. Do not keep combustible objects or aerosol cans in drawers directly underneath the hob.
- The hob switches off automatically and can no longer be operated. It may switch on unintentionally at a later point. Switch off the circuit breaker in the fuse box. Contact the after-sales service.
- Do not use hob covers here. They can cause accidents, for example due to overheating, catching fire or materials shattering.

Warning – Risk of burns!

- The hotplates and surrounding area (particularly the hob surround, if fitted) become very hot. Never touch the hot surfaces. Keep children at a safe distance.
- The hotplate heats up but the display does not work. Switch off the circuit breaker in the fuse box. Contact the after-sales service.
- Metal objects on the hob quickly become very hot. Never place metal objects (such as knives, forks, spoons and lids) on the hob.
- After each use, always turn off the hob at the main switch. Do not wait until the hob turns off automatically after the pan is removed.

Warning – Risk of electric shock!

- Incorrect repairs are dangerous. Repairs may only be carried out and damaged power cables replaced by one of our trained after-sales technicians. If the appliance is defective, unplug the appliance from the mains or switch off the circuit breaker in the fuse box. Contact the after-sales service.
- Do not use any high-pressure cleaners or steam cleaners, which can result in an electric shock.
- A defective appliance may cause electric shock. Never switch on a defective appliance. Unplug the appliance from the mains or switch off the circuit breaker in the fuse box. Contact the after-sales service.
- Cracks or fractures in the glass ceramic may cause electric shocks. Switch off the circuit breaker in the fuse box. Contact the after-sales service.

Warning – Hazard due to magnetism!

The wireless temperature sensor is magnetic. The magnetic elements in it may damage electronic implants, e.g. pacemakers or insulin pumps. People fitted with electronic implants should therefore not carry the temperature sensor in their pockets and always keep it at least 10 cm away from their pacemaker or similar medical device.

Warning – Risk of fault!

A fan is located on the underside of this hob. If a drawer is located on the underside of the hob, do not store any small or sharp objects, paper or tea towels in it. These may be sucked in and damage the fan or impair the cooling. There must be a clearance of at least 2 cm between the contents of the drawer and the fan entry point.

⚠ Warning – Risk of injury!

- The wireless cooking sensor is equipped with a battery, which may become damaged if it is exposed to high temperatures. Remove the sensor from the cookware and store it away from any heat sources.
- The temperature sensor may be very hot when removing it from the saucepan. Wear oven gloves or use a tea towel to remove it.
- When cooking in a bain marie, the hob and cooking container could shatter due to overheating. The cooking container in the bain marie must not directly touch the bottom of the water-filled pot. Only use heat-resistant cookware.
- Saucepans may suddenly jump due to liquid between the pan base and the hotplate. Always keep the hotplate and saucepan bases dry.

 Causes of damage

Caution!

- Rough pan bases may scratch the hob.
- Avoid leaving empty pots and pans on the hotplate. Doing so may cause damage.
- Do not place hot pans on the control panel, the indicator area, or the hob frame. Doing so may cause damage.
- Hard or pointed objects dropped on the hob may damage it.
- Aluminium foil and plastic containers will melt if placed on the hotplate while it is hot. The use of laminated sheeting is not recommended on the hob.

Overview

You will find the most frequently caused damage in the following table:

| Damage | Cause | Measure |
|----------------|--|--|
| Stains | Boiled over food. | Remove boiled over food immediately with a glass scraper. |
| | Unsuitable cleaning agent. | Only use cleaning agents that are suitable for this type of hob. |
| Scratches | Salt, sugar and sand. | Do not use the hob as a work surface or storage space. |
| | Cookware with rough bases scratch the hob. | Check the cookware. |
| Discolouration | Unsuitable cleaning agent. | Only use cleaning agents that are suitable for this type of hob. |
| | Pan abrasion. | Lift pots and pans when moving them. |
| Chips | Sugar, food with a high sugar content. | Remove boiled over food immediately with a glass scraper. |

Environmental protection

In this section, you can find information about saving energy and disposing of the appliance.

Energy-saving advice

- Always use the correct lid for each pan. Cooking without a lid uses a lot more energy. Use a glass lid to provide visibility and avoid having to lift the lid.
- Use pans with flat bases. Bases that are not flat use a lot more energy.
- The diameter of the pan base must match the size of the hotplate. Please note: pan manufacturers usually provide the diameter for the top of the pan, which is usually larger than the diameter of the pan base.
- Use a small pan for small amounts of food. A large pan which is not full uses a lot of energy.
- Use little water when cooking. This saves energy and preserves all the vitamins and minerals in vegetables.
- Select the lowest power level to maintain cooking. If the power level is too high, energy is wasted.

Environmentally-friendly disposal

Dispose of packaging in an environmentally-friendly manner.



This appliance is labelled in accordance with European Directive 2012/19/EU concerning used electrical and electronic appliances (waste electrical and electronic equipment - WEEE). The guideline determines the framework for the return and recycling of used appliances as applicable throughout the EU.

The wireless temperature sensor is battery-powered. Dispose of used batteries in an environmentally responsible manner.

Induction cooking

Advantages of induction cooking

Induction cooking is very different from traditional cooking methods, as heat builds up directly in the item of cookware. This offers numerous advantages:

- Saves time when boiling and frying.
- Saves energy.
- Easier to care for and clean. Spilled food does not burn on as quickly.
- Heat control and safety – the hob increases or decreases the heat supply as soon as the user changes the setting. The induction hotplate stops the heat supply as soon as the cookware is removed from the hotplate, without having to switch it off first.

Cookware

Only use ferromagnetic cookware for induction cooking, such as:

- Cookware made from enamelled steel
- Cookware made from cast iron
- Special induction-compatible cookware made from stainless steel.

To check whether your cookware is suitable for induction cooking, refer to the section on → "Cookware check".

To achieve a good cooking result, the ferromagnetic area on the base of the pan should match the size of the hotplate. If a hotplate does not detect an item of cookware, try placing it on another hotplate with a smaller diameter.

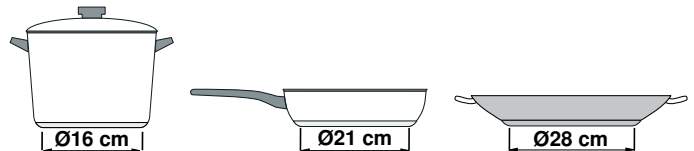

If the only hotplate being used is the flexible cooking zone, larger cookware that is particularly suited to this zone can be used. You can find information on positioning cookware in the section on → "Flex Zone".



Some induction cookware does not have a fully ferromagnetic base:

- If the base of the cookware is only partially ferromagnetic, only the area that is ferromagnetic will heat up. This may mean that heat will not be distributed evenly. The non-ferromagnetic area may not heat up to a sufficient temperature for cooking.

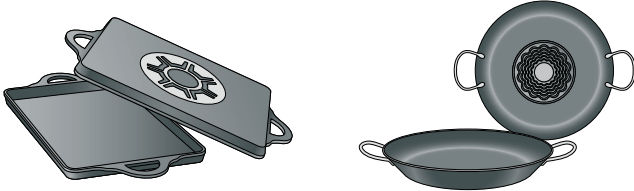

- The ferromagnetic area will also be reduced if the material from which the base of the cookware is made contains aluminium, for example. This may mean that the cookware will not become sufficiently hot or even that it will not be detected.

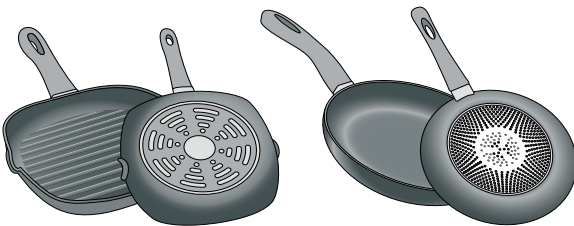

Unsuitable pans

Never use diffuser hobs or pans made from:

- common thin steel
- glass
- earthenware
- copper
- aluminium

Properties of the base of the cookware

The material(s) from which the base of the cookware is made can affect the cooking result. Using pots and pans made from materials that distribute heat evenly through them, such as stainless-steel pans with a three-layer base, saves time and energy.

Use cookware with a flat base; if the base of the cookware is uneven, this may impair the heat supply.

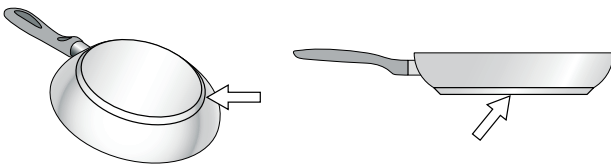

Absence of pan or unsuitable size

If no pan is placed on the selected hotplate, or if it is made of unsuitable material or is not the correct size, the power level displayed on the hotplate indicator will flash. Place a suitable pan on the hotplate to stop the flashing. If this takes more than 90 seconds, the hotplate will switch off automatically.

Empty pans or those with a thin base

Do not heat empty pans, nor use pans with a thin base. The hob is equipped with an internal safety system. However, an empty pan may heat up so quickly that the "automatic switch off" function may not have time to react and the pan may reach very high temperatures. The base of the pan could melt and damage the glass on the hob. In this case, do not touch the pan and switch the hotplate off. If it fails to work after it has cooled down, please contact the Technical Assistance Service.

Pan detection

Each hotplate has a lower limit for pan detection. This depends on the diameter of the ferromagnetic area of the cookware and the material from which its base is made. For this reason, you should always use the hotplate that best matches the diameter of the base of the pan.









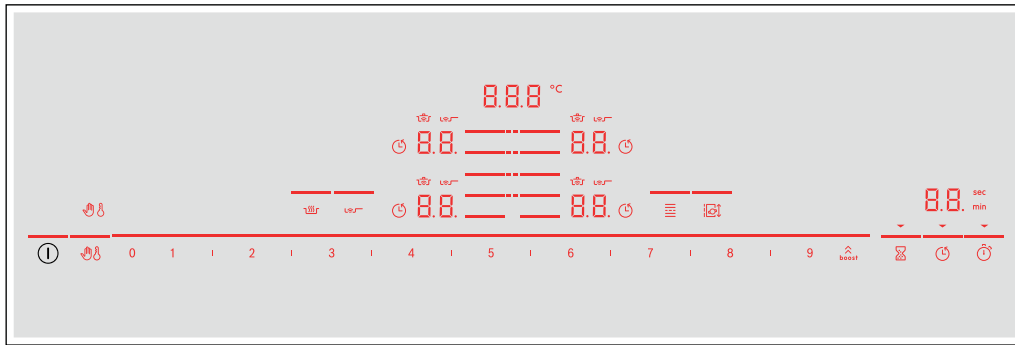



Getting to know your appliance





You can find information on the dimensions and power of the hotplates in → *Page 2*

Note: Depending on the appliance model, individual details and colours may differ.

The control panel



| Controls | |
|---|------------------------------------|
|  | Main switch |
|  | Select a hotplate |
| 0 1 2 3 4 5 6 7 8 9 | Settings range |
|  | PowerBoost and ShortBoost function |
|  | Lock control panel for cleaning |
|  | Childproof lock |
|  | Keep warm function |
|  | Frying sensor |
|  | Flexible cooking zone |
|  | Move function |
|  | Kitchen timer |
|  | Timer function |
|  | Kitchen timer |

| Indicators | |
|---|--|
| 0.0 | Operating status |
| 1.9 | Heat settings |
| H/h | Residual heat |
| 00 | Timer function |
| 000°C | Temperature for cooking functions |
|  | Locking the control panel for cleaning |
|  | Childproof lock |
|  | Setting the cooking time |
| min/sec | Timer displays |
| b. | PowerBoost function |
| Pb. | ShortBoost function |
|  | Cooking functions |
|  | Frying sensor |
| ⋮ | FlexPlus cooking zone |
| t | Transfer settings |
| Lo | Keep-warm function |

Controls



When the hob heats up, the symbols for the controls available at this time light up.

Touching a symbol activates the respective function.

Notes

- The corresponding symbols for the controls light up depending on whether they are available. The displays for the hotplates or the selected functions get brighter.
- Always keep the control panel clean and dry. Moisture can prevent it from working properly.
- Do not place any cookware near the indicators or sensors. The electronics could overheat.

The hotplates

| Hotplate | | |
|--|-----------------------|--|
|  | Simple hotplate | Use cookware that is a suitable size. |
|  | Flexible cooking zone | See section → "Flex Zone" |
|  | FlexPlus cooking zone | The FlexPlus cooking zones always switch on in conjunction with the right- or left-hand flexible cooking zone. See section → "FlexPlus Zone" |

Only use cookware that is suitable for induction cooking; see section → "Induction cooking"

Residual heat indicator

The hob has a residual heat indicator for each hotplate. This indicates that a hotplate is still hot. Do not touch a hotplate while the residual heat indicator is lit up.

The following indicators are shown depending on the amount of residual heat:

- Display **H**: High temperature
- Display **h**: Low temperature

If you remove the cookware from the hotplate during cooking, the residual heat indicator and the selected heat setting will flash alternately.



When the hotplate is switched off, the residual heat indicator will light up. Even after the hob has been switched off, the residual heat indicator will stay lit for as long as the hotplate is still warm.

Operating the appliance

This chapter explains how to set a hotplate. The table shows heat settings and cooking times for various meals.

Switching the hob on and off

The main switch is used to switch the hob on and off.

To switch on: Touch the  symbol. An audible signal sounds. The symbols for the hotplates and the functions available at this time light up. The  symbol lights up next to the hotplates. The hob is ready to use.

To switch off: Touch the  symbol until the indicators go out. The residual heat indicator remains lit until the hotplates have cooled down sufficiently.

Notes

- The hob switches off automatically if all hotplates have been switched off for more than 20 seconds.
- The selected settings are stored for four seconds after the hob has been switched off. If you switch it on again during this time, the hob will operate using the previously stored settings.

Setting a hotplate

Set the required heat setting using the **1** to **9** symbols.

Heat setting **1** = lowest setting.

Heat setting **9** = highest setting.



Every heat setting has an intermediate setting. This is marked in the control panel with the  symbol.

Notes

- To protect the fragile parts of your appliance from overheating and electrical overloading, the hob may temporarily reduce the power.
- In order to prevent the appliance from producing excess noise, the hob may temporarily reduce the power.

Selecting a hotplate and heat setting

The hob must be switched on.

1. Touch the  symbol for the required hotplate. The  display gets brighter.
2. Then select the required heat setting from the settings range.

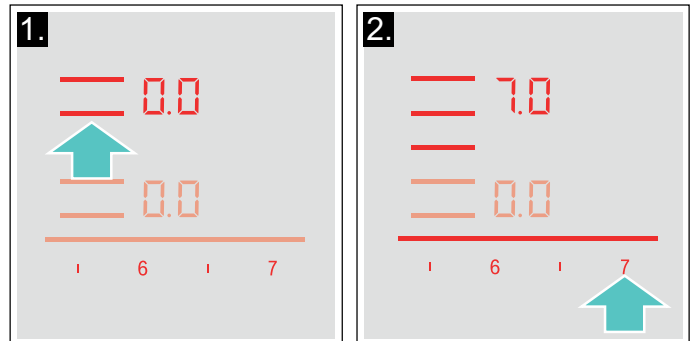

The heat setting is set.

Changing the heat setting

Select the hotplate and then set the required heat setting in the control panel.

Switching off the hotplate

Select the hotplate and set it to  in the settings range. The hotplate switches itself off and the residual heat indicator appears.

Notes

- If no pan has been placed on the hotplate, the selected power level flashes. After a certain time has elapsed, the hotplate switches off.
- If a pan has been placed on the hotplate before switching on the hob, it will be detected within 20 seconds of pressing the main switch and the hotplate will be selected automatically. Once detected, select the power level within the next 20 seconds or the hotplate will switch off. If more than one pan is placed on the hob, only one will be detected when switching it on.

Chef's recommendations

Recommendations

- When heating up puree, cream soups and thick sauces, stir occasionally.
- Set heat setting 8 to 9 for preheating.
- When cooking with the lid on, turn the heat setting down as soon as steam escapes between the lid and the cookware. Steam does not need to escape for a good cooking result.
- After cooking, keep the lid on the cookware until you serve the food.
- To cook with the pressure cooker, observe the manufacturer's instructions.
- Do not cook food for too long, otherwise the nutrients will be lost. The kitchen clock can be used to set the optimum cooking time.
- For a more healthy cooking result, smoking oil should be avoided.
- To brown food, fry small portions in succession.
- Cookware may reach high temperatures while the food is cooking. We recommend that you use oven gloves.
- You can find recommendations for energy-efficient cooking in section → *"Environmental protection"*

Cooking table

The table shows which heat setting is suitable for each type of food. The cooking time may vary depending on the type, weight, thickness and quality of the food.

| | Heat setting | Cooking time (mins) |
|---|--------------|---------------------|
| Melting | | |
| Chocolate coating | 1 - 1.5 | - |
| Butter, honey, gelatine | 1 - 2 | - |
| Heating and keeping warm | | |
| Stew, e.g. lentil stew | 1.5 - 2 | - |
| Milk* | 1.5 - 2.5 | - |
| Heating sausages in water* | 3 - 4 | - |
| Defrosting and heating | | |
| Spinach, frozen | 3 - 4 | 15 - 25 |
| Goulash, frozen | 3 - 4 | 35 - 55 |
| Poaching, simmering | | |
| Potato dumplings* | 4.5 - 5.5 | 20 - 30 |
| Fish* | 4 - 5 | 10 - 15 |
| White sauces, e.g. Béchamel sauce | 1 - 2 | 3 - 6 |
| Whisked sauces, e.g. sauce béarnaise, hollandaise | 3 - 4 | 8 - 12 |

* Without lid

** Turn several times

*** Preheat to heat setting 8 - 8.5

| | Heat setting | Cooking time (mins) |
|--|--------------|---------------------|
| Boiling, steaming, braising | | |
| Rice (with double the volume of water) | 2.5 - 3.5 | 15 - 30 |
| Rice pudding*** | 2 - 3 | 30 - 40 |
| Unpeeled boiled potatoes | 4.5 - 5.5 | 25 - 35 |
| Boiled potatoes | 4.5 - 5.5 | 15 - 30 |
| Pasta, noodles* | 6 - 7 | 6 - 10 |
| Stew | 3.5 - 4.5 | 120 - 180 |
| Soups | 3.5 - 4.5 | 15 - 60 |
| Vegetables | 2.5 - 3.5 | 10 - 20 |
| Vegetables, frozen | 3.5 - 4.5 | 7 - 20 |
| Cooking in a pressure cooker | 4.5 - 5.5 | - |
| Braising | | |
| Roulades | 4 - 5 | 50 - 65 |
| Pot roast | 4 - 5 | 60 - 100 |
| Goulash*** | 3 - 4 | 50 - 60 |
| Roasting/frying with little oil* | | |
| Escalope, plain or breaded | 6 - 7 | 6 - 10 |
| Escalope, frozen | 6 - 7 | 6 - 12 |
| Chop, plain or breaded** | 6 - 7 | 8 - 12 |
| Steak (3 cm thick) | 7 - 8 | 8 - 12 |
| Poultry breast (2 cm thick)** | 5 - 6 | 10 - 20 |
| Poultry breast, frozen** | 5 - 6 | 10 - 30 |
| Rissoles (3 cm thick)** | 4.5 - 5.5 | 20 - 30 |
| Hamburgers (2 cm thick)** | 6 - 7 | 10 - 20 |
| Fish and fish fillet, plain | 5 - 6 | 8 - 20 |
| Fish and fish fillet, breaded | 6 - 7 | 8 - 20 |
| Fish, breaded and frozen, e.g. fish fingers | 6 - 7 | 8 - 15 |
| Scampi, prawns | 7 - 8 | 4 - 10 |
| Sautéing fresh vegetables and mushrooms | 7 - 8 | 10 - 20 |
| Stir-fry, vegetables, meat cut in Asian-style strips | 7 - 8 | 15 - 20 |
| Stir fry, frozen | 6 - 7 | 6 - 10 |
| Pancakes (baked in succession) | 6.5 - 7.5 | - |
| Omelette (cooked in succession) | 3.5 - 4.5 | 3 - 10 |
| Fried eggs | 5 - 6 | 3 - 6 |
| Deep-fat frying* (150-200 g per portion in 1-2 l oil, deep-fat fried in portions) | | |
| Frozen products, e.g. chips, chicken nuggets | 8 - 9 | - |
| Croquettes, frozen | 7 - 8 | - |
| Meat, e.g. chicken portions | 6 - 7 | - |
| Fish, breaded or in beer batter | 6 - 7 | - |
| Vegetables, mushrooms, breaded or battered, tempura | 6 - 7 | - |
| Small baked items, e.g. doughnuts, fruit in batter | 4 - 5 | - |

* Without lid

** Turn several times

*** Preheat to heat setting 8 - 8.5

Flex Zone

You can use each flex zone as a single hotplate or as two independent hotplates, as required.

It consists of four inductors that work independently of each other. If using the flexible cooking zone, only the area that is covered by cookware is activated.

Advice on using cookware

To ensure that the cookware is detected and heat is distributed evenly, correctly centre the cookware:

As a single hotplate

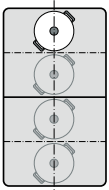

Diameter smaller than or equal to 13 cm
Place the cookware on one of the four positions that can be seen in the illustration.

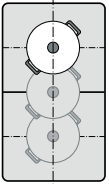

Diameter greater than 13 cm
Place the cookware on one of the three positions that can be seen in the illustration.

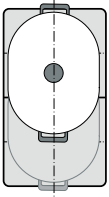

If the cookware takes up more than one hotplate, place it starting on the upper or lower edge of the flexible cooking zone.

As two independent hotplates

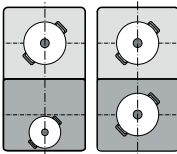

The front and rear hotplates each have two inductors and can be used independently of each other. Select the required heat setting for each of the hotplates. Use only one item of cookware on each hotplate.

Recommendations

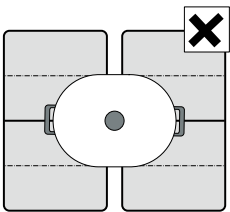

If the hob has more than one flexible cooking zone, place the cookware on top so that it covers only one of the flexible cooking zones.

Otherwise, the hotplates will not be activated as intended and the cooking result will not be satisfactory.

As two independent hotplates

The flexible cooking zone is used like two independent hotplates.

Activating

See section → "Operating the appliance"

As a single hotplate

Using the entire cooking zone by connecting both hotplates.

Connecting the two cooking zones

The cooking zones are automatically connected or separated depending on where the pot or pan is placed.

Connecting them manually:

1. Set the pot or pan down. Select one of the two cooking zones in the Flex Zone and set the power level.
2. Touch the  symbol. The indicator lights up. The power level appears in the display for the cooking zone.

The Flex Zone is activated.

Changing the heat setting

Select one of the two hotplates in the flexible cooking zone and change the heat setting in the settings range.

Adding a new item of cookware

Set down the new item of cookware in a position suitable for its size. The appliance detects when the cookware has been set down correctly, and then splits the cooking zones based on this. Select the required cooking zone and set the power level in the control panel.

Note: If the cookware is moved to the hotplate being used or lifted up, the hotplate begins an automatic search and the heat setting selected previously is retained.

Separating the two cooking zones

The cooking zones are automatically connected or separated depending on where the pot or pan is placed.

To separate the cooking zones manually, select one of the two cooking zones in the Flex Zone and touch the  symbol.

The Flex Zone is deactivated. The two cooking zones will now operate independently of one another.

Notes

- If the hob is switched off, and then switched back on again later, the flexible cooking zone is reset to function as two independent hotplates.
- To change the configuration settings for the flexible cooking zone, refer to section → "Basic settings".

Move function

This function activates the entire flexible cooking zone, which is divided into three cooking areas and which has preset heat settings.

Only use one item of cookware. The size of the cooking area depends on the cookware used and whether it is positioned correctly.

Cooking areas

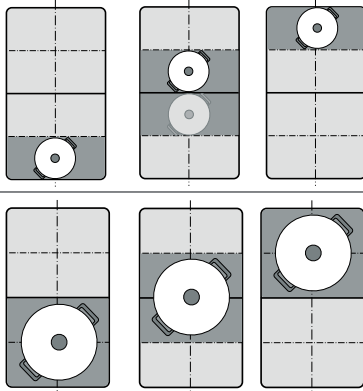

This means that an item of cookware can be moved during the cooking process to another cooking area with another heat setting:

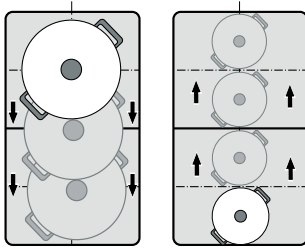

Preset heat settings:

Front area = heat setting **9**

Middle area = heat setting **5**



Rear area = heat setting **1.5**

The preset heat settings can be changed independently of one another. You can find out how to change these in the section on → "Basic settings".

Notes

- If more than one item of cookware is detected on the flexible cooking zone, the function is deactivated.
- If the cookware is moved within the flexible cooking zone or lifted up, the hob automatically starts searching and the heat setting of the area in which the vessel was detected is set.
- You can find information on the size and positioning of the cookware in the section on → "Flex Zone"

Activation

1. Select one of the two hotplates in the flexible cooking zone.
2. Touch the  symbol. The indicator beside the  symbol lights up. The flexible cooking zone is activated as a single hotplate. The heat setting in the area in which the cookware is located lights up in the hotplate display. The function has now been activated.



Changing the heat setting

The heat settings for the individual cooking areas can be changed during the cooking process. Set the cookware down on the cooking area and change the heat setting in the settings range.

Notes

- Only the heat setting in the area in which the cookware is located is changed.
- If the function is deactivated, the heat settings for the three cooking areas are reset to the preset values.

Deactivating

Touch the  symbol. The indicator beside the  symbol goes out.

The function was deactivated.

Note: If one of the cooking areas is set to , the function deactivates after a few seconds.

FlexPlus Zone

The hob has two FlexPlus cooking zones which are located between the two flexible cooking zones and which switch on in conjunction with the right- or left-hand flexible cooking zone. This means that larger cooking vessels can be used and better cooking results can be achieved.

Each FlexPlus cooking zone always switches on in conjunction with the right- or left-hand flexible cooking zone. It is not possible to switch them on independently of one another.

Notes regarding cookware

The cookware should be positioned centrally for good thermal detection and distribution.

The cookware should cover the side hotplate and the FlexPlus cooking zone.

Depending on the size of the cookware, the flexible cooking zone can be activated as two independent hotplates or as one hotplate:

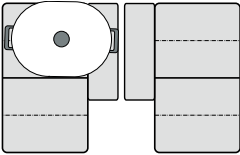
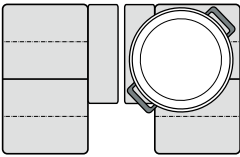
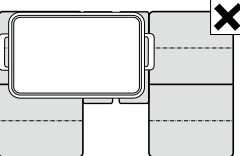
| Setting the pot down | |
|---|--|
|  | Long cooking pot: Flexible cooking zone as two independent cooking zones or as a single cooking zone. |
|  | Large round cooking pot: Flexible cooking zone as a single cooking zone. |
|  | The pot must not cover both FlexPlus cooking zones at the same time. |

Activation

1. Set down the cookware on the hotplate and make sure that it also covers the FlexPlus cooking zone.
2. Select the hotplate and the required heat setting. The hotplate and FlexPlus cooking zone indicators light up.

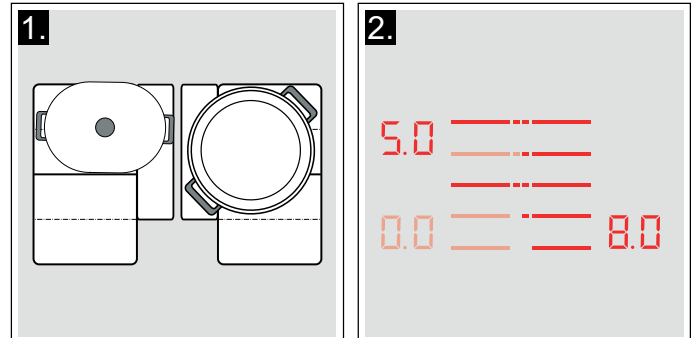

The flexible cooking zone is activated.

Deactivating

Remove the cookware from the hotplate. The displays go out.

This deactivates the FlexPlus cooking zone.

Time-setting options





Your hob has three timer functions:

- Programming the cooking time
- Kitchen timer
- Stopwatch function

Programming the cooking time

The hotplate automatically switches off after the time that is set has elapsed.

Setting procedure:

1. Select the hotplate and the required heat setting.
2. Touch the  symbol. The  symbol and the  indicator light up in the timer display.  lights up in the cooking zone display.

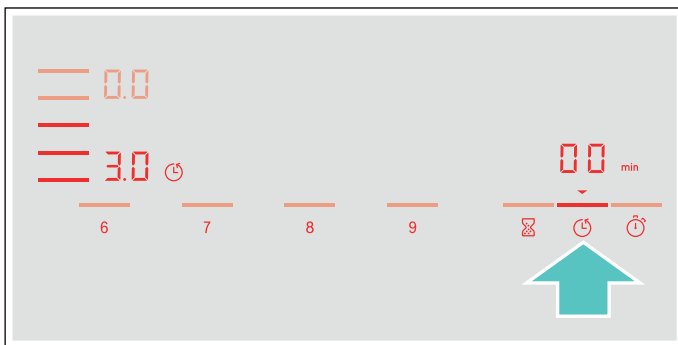

3. Within the next 10 seconds, set the required cooking time in the settings range.

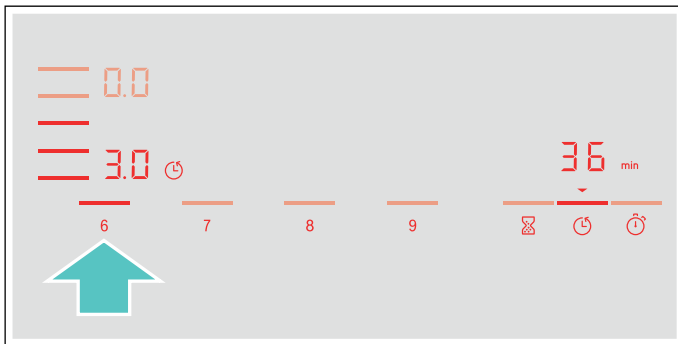

4. Touch the  symbol to confirm the selected setting.

The cooking time begins to elapse.

Notes

- The same cooking time can be set automatically for all hotplates. The set time for each of the hotplates counts down independently. You can find information on automatically programming the cooking time in section → "Basic settings"
- If the flexible cooking zone is selected as the only hotplate, the set time for the entire cooking zone is the same.
- If the Move function is selected for the combined hotplate, the set time for the three hotplates is the same.

Frying sensor

If a cooking time has been programmed for a hotplate and the frying sensor has been activated, the cooking time will not begin to count down until the selected temperature setting has been reached.

Cooking functions

If a cooking time has been programmed for a hotplate and one of the cooking functions has been activated, the set cooking time will not start to count down until the temperature for the selected area has been reached.



Changing or deleting the time



Select the hotplate and then touch the  symbol.

Change the cooking time in the settings range or set  to delete the programmed cooking time.

Touch the  symbol to confirm the selected setting.

When the time has elapsed

The hotplate switches off, the  display flashes and the hotplate switches to the  heat setting. An audible signal sounds.

 and the  indicator flash in the timer display.

When the  symbol is touched, the indicators go out and the acoustic signal ceases.

Notes





- To set a cooking time of under 10 minutes, always touch **0** before you select the required value.
- If a cooking time was programmed for several hotplates, the time information for the selected hotplate is shown in the timer display.
- Select the relevant hotplate to call up the remaining cooking time.
- You can set a cooking time of up to **99** minutes.

The kitchen timer

You can use the kitchen timer to set a time of up to 99 minutes.

This functions independently from the hotplates and from other settings. This function does not automatically switch off a hotplate.

Setting procedure

1. Touch the  symbol. The  symbol and the  indicator light up in the timer display.
2. Select the required time on the control panel and touch the  symbol to confirm.

After a few seconds, the time begins to elapse.



Changing or deleting the time

Touch the  symbol.

Change the cooking time in the settings range or set  to delete the programmed cooking time.

Touch the  symbol to confirm the selected setting.

When the time has elapsed

An audible signal sounds once the time has elapsed.  and the  symbol flash in the timer display.



The indicators go out after touching the  symbol.

Stopwatch function

The stopwatch function displays the time that has elapsed since activation.

This functions independently from the hotplates and from other settings. This function does not automatically switch off a hotplate.

Activating

Touch the  symbol. The  symbol and the  indicator light up in the timer display.

The cooking time begins to elapse.

Deactivating

Touching the  symbol stops the stopwatch function. The timer displays remain lit.

If you touch the  symbol again, the displays go out.

The function is deactivated.

PowerBoost function

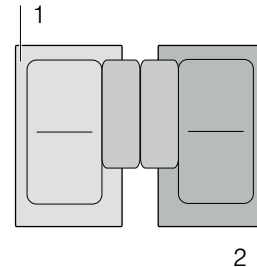

The PowerBoost function enables you to heat up large quantities of water faster than when using heat setting .

This function can always be activated for a hotplate, provided the other hotplate in the same group is not in use (see illustration).





Note: The PowerBoost function can also be activated in the flexible area if the cooking zone is being used as a single hotplate.

Activating

1. Select a hotplate.
2. Touch the  symbol.
The  indicator lights up.
The function is activated.

Deactivating

1. Select a hotplate.
 2. Touch the  symbol.
The  display goes out and the hotplate switches back to heat setting .
- The function is deactivated.

Note: In certain circumstances, the PowerBoost function can switch itself off automatically in order to protect the electronic elements inside the hob.

ShortBoost function

The ShortBoost function enables you to heat cookware faster than when using heat setting 9.

After deactivating the function, select the appropriate heat setting for your food.

This function can always be activated for a hotplate, provided the other hotplate in the same group is not in use (see illustration).

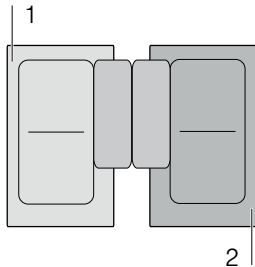



Note: With the flexible cooking zone, the ShortBoost function can be activated even if it is used as the only cooking zone.



Recommendations for use

- Always use cookware that has not been pre-heated.
- Use pots and pans with a flat base. Do not use cookware with a thin base.
- Never leave empty cookware, oil, butter or lard to heat up unattended.
- Do not place a lid on the cookware.
- Place the cookware on the centre of the hotplate. Ensure that the diameter of the base of the cookware corresponds to the size of the hotplate.
- You can find information on the type, size and positioning of the cookware in section → "Induction cooking"

Activating

1. Select a hotplate.
2. Touch the  symbol twice.
The  indicator lights up.
The function is activated.

Deactivating



1. Select a hotplate.
2. Touch the  symbol.
The  display goes out and the hotplate switches back to heat setting 9.
The function is deactivated.

Note: After 30 seconds, this function will automatically switch off.



Keep warm function

This function is suitable for melting chocolate or butter and for keeping food warm.

Activating

1. Select the required heat setting.
2. Within the next 10 seconds, touch the  symbol.
The  indicator lights up.
The function is activated.

Deactivating

1. Select a hotplate.
2. Touch the  symbol.
The  display goes out. The hotplate switches itself off and the residual heat indicator appears.
The function is deactivated.

Transferring settings

This function can be used to transfer the heat setting, the programmed cooking time and the selected cooking function from one hotplate to another.

To transfer the settings, move the cookware from the hotplate which is switched on to another hotplate.

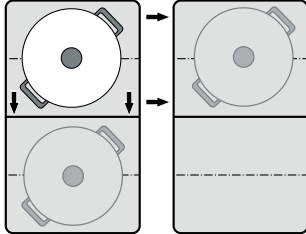

Note: You can find additional information on the positioning of the cookware in the section on → "Flex Zone"

Activation

1. Move the cookware from the hotplate which is switched on to another hotplate.
The heat setting of the original hotplate flashes.
The cookware is detected and the previously selected heat setting and the  symbol flash in the new hotplate display.
2. Select the new hotplate to confirm the settings.
The heat setting of the original hotplate is set to **00**.

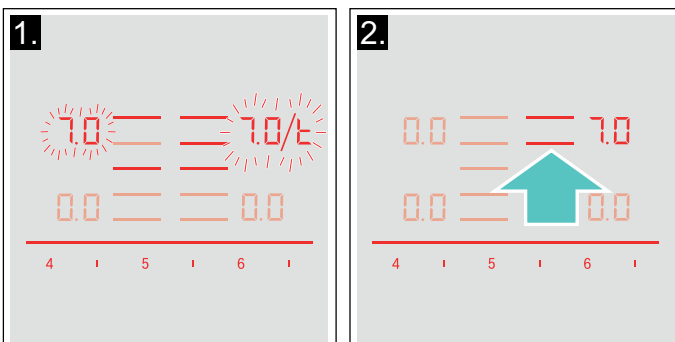

The settings have been transferred to the new hotplate.

Notes

- Move the cookware to a hotplate which is not switched on, which you have not yet preset or on which no other cookware has been placed.
- The PowerBoost or ShortBoost function can then only be moved from left to right or right to left if no hotplate is active.
- If a new item of cookware is set down on another hotplate before the settings have been confirmed, this function is ready for both cooking vessels.
- If several vessels are moved, the function is only ready for the vessel which was last moved.

Cooking assist functions

The cooking assistance functions make cooking easy and always give you excellent results. The recommended temperature settings are suitable for any type of cooking.

They enable you to cook without using excessive heat and promise the perfect cooking and frying results.

Sensors measure the heat of the saucepan or frying pan throughout the cooking process. This ensures that the power is continuously controlled and that the right temperature is maintained.

Food can be added once the selected temperature has been reached. Food will not be overheated and liquids will not boil over.

The hotplates that have a frying sensor are marked with the frying sensor symbol.

The cooking functions are available to all hotplates if a wireless temperature sensor is connected.











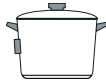

In this section, you will find information on:

- Cooking assistant function types
- Suitable cookware
- Sensors and special accessories
- Functions and heat settings
- Recommended dishes

Cooking assistant function types

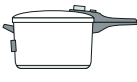
You can use the cooking assistance functions to select the best cooking type for each kind of food.

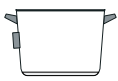
The table shows the various different settings that are available for the cooking assistant functions:

| Cooking assistance functions | Temperature settings | Cookware | Availability | Activate |
|--|----------------------|--|---|---|
| Frying sensor | | | | |
| Roasting/frying with a small amount of oil | 1, 2, 3, 4, 5 |  |  |  |
| Cooking functions | | | | |
| Heating/keeping warm | 1 / 70 °C |  | All hotplates |  |
| Poaching | 2 / 90 °C |  | All hotplates |  |
| Cooking | 3 / 100 °C |  | All hotplates |  |
| Cooking in a pressure cooker | 4 / 120 °C |  | All hotplates |  |
| Frying with a large amount of oil in the saucepan* | 5 / 170 °C |  | All hotplates |  |

*Preheat with the lid on and fry with the lid off.

If the hob does not have a wireless cooking sensor, this can be purchased from specialist retailers, our after-sales service or our official website.

Suitable cookware

Select the cooking zone with the diameter that most closely matches that of the base of the cookware and place the cookware in the centre of this cooking zone.

For the cooking functions, use cookware that is high enough that the required water volume lies above the silicone patch for the wireless sensor.

There are frying pans that are perfect for using with the frying sensor. These can be purchased from specialist retailers, our technical after-sales service or our official website. Quote the relevant reference number:

- HEZ390210 15 cm frying pan.
- HEZ390220 19 cm frying pan.
- HEZ390230 21 cm frying pan.
- HEZ390250 28 cm frying pan. Recommended for the FlexPlus cooking zone only.
- HEZ390512 teppan yaki. Recommended for the flexible cooking zone only.
- HEZ390522 griddle plate. Recommended for the flexible cooking zone only.

These frying pans have a non-stick coating so that you can fry food with a small amount of oil.

Notes

- The frying sensor has been configured specifically for this type and size of frying pan.
- Using a frying pan of a different size or one that is poorly positioned on the flexible cooking zones may result in the frying sensor not being activated. See section → "*Flex Zone*".
- Other types of frying pan may overheat and reach a temperature above or below the selected heat setting. Try the lowest temperature setting to begin with and change it if required.

Any cookware that is suitable for induction cooking can be used with the cooking functions. You can find information on which types of cookware can be used with an induction hob in section → "*Induction cooking*".

The cooking assistance functions table lists which cookware is suitable for which functions.

Sensors and special accessories

The sensors measure the temperature of the pot throughout the entire cooking process. This ensures that the cooking power is controlled with high precision to maintain the correct temperature and achieve optimum cooking results.

Your hob has two different temperature-measuring systems for achieving the best results:

- Temperature sensors that are located inside the hob and monitor the temperature of the base of the cookware. Suitable for the frying sensor.
- A wireless cooking sensor that transmits information about the temperature of the cookware to the control panel. Suitable for the cooking functions.

The cooking sensor is essential for using the cooking functions.

If your hob does not have a wireless cooking sensor, this can be purchased from specialist retailers, our technical after-sales service or our official website by quoting the reference number HEZ39050.

You can find information about the cooking sensor in section → "*Preparing and maintaining the wireless temperature sensor*"

Functions and heat settings

Frying sensor

You can use the frying sensor when pan-frying food with a small amount of oil.

Hotplates with this function are marked with the frying sensor symbol.

Benefits

- The hotplate only heats up when necessary. This saves energy. Oil and fat will not overheat.
- A signal will sound once the empty frying pan has reached the optimum temperature for adding oil and food.

Notes

- Do not put the lid on the pan as this will prevent the controller from working. You can use a splatter guard to prevent the oil from spitting.
- Use oil or fat that is suitable for frying. If using butter, margarine, cold-pressed olive oil or lard, use temperature setting 1 or 2.
- Never leave fat or oil unattended while you are heating it.
- If the hotplate is a higher temperature than the cookware or vice versa, the temperature sensor will not be activated correctly.
- Always use the cooking functions when frying with a large amount of oil in the saucepan. "Frying with a large amount of oil in the saucepan", heat setting 5.

Temperature settings

| Temperature level | Suitable for |
|-------------------|---|
| 1 very low | Preparing and reducing sauces, stewing vegetables and frying food in extra virgin olive oil, butter or margarine. |
| 2 low | Frying food in extra virgin olive oil, butter or margarine, e.g. omelettes. |
| 3 medium - low | Frying fish and thick food such as meatballs and sausages. |
| 4 medium - high | Frying steaks (well done), breaded frozen products, and thin food such as schnitzel, strips of meat and vegetables. |
| 5 high | Frying food at high temperatures, e.g. rare steaks (rare or medium), potato fritters and fried potatoes. |

Setting procedure

Select the appropriate temperature level from the table. Set an empty item of cookware down on the cooking zone.

1. Select the hotplate. Touch the  symbol.  lights up in the hotplate display.

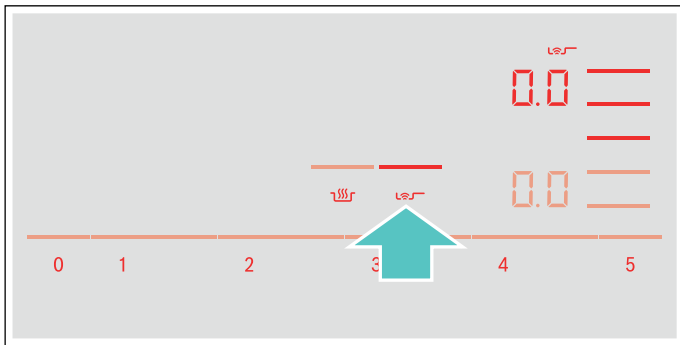

2. Within the next 10 seconds, select the required temperature setting from the settings range.

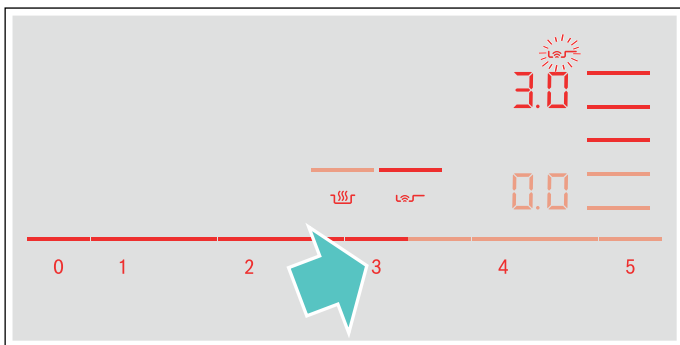

The function has now been activated.

The  temperature symbol flashes until the frying temperature is reached. A signal sounds and the temperature symbol goes out.

3. Once the frying temperature has been reached, add the fat and then the food to the pan.

Note: Turn the food so that it does not burn.

Switching off the frying sensor

Select the hotplate and set it to  in the settings range. The hotplate switches itself off and the residual heat indicator appears.

Cooking functions

You can use these functions to heat, simmer or cook food, or cook it in a pressure cooker or fry it in a saucepan with sufficient oil at a controlled temperature.

These cooking functions are available for all hotplates.

Benefits

- The cooking zone only continues heating for as long as this is necessary to maintain the temperature. This saves energy and prevents oil or fat from overheating.
- The temperature is continuously monitored. This prevents the food from spilling over. In addition, the temperature setting does not need to be changed.
- A signal sounds once the water or oil has reached the optimum temperature for adding the food. The table shows if the food needs to be added right at the start.

Notes

- Use pots and pans with a thick, flat base. Do not use pots and pans with a thin or domed base.
- Fill the pot so that the contents reach high enough to cover the cooking sensor's silicone patch.
- Use the frying sensor when frying with a small amount of oil.
- Position the cookware in such a way that the cooking sensor is pointing towards the outer side of the hob.
- Do not remove the cooking sensor from the pot during cooking.
- Remove the cooking sensor from the pot after cooking. Be careful as the cooking sensor may be very hot.

Temperature ranges and settings

| Cooking functions | Temperature setting | Temperature range | Suitable for |
|---|---------------------|-------------------|---------------------------|
| Heating, keeping warm | 1/70 °C | 60 - 70 °C | E.g. soups, punch |
| Poaching | 2/90 °C | 80 - 90 °C | E.g. rice, milk |
| Cooking | 3/100 °C | 90 - 100 °C | E.g. pasta, vegetables |
| Cooking in a pressure cooker | 4/120 °C | 110 - 120 °C | E.g. chicken, stew. |
| Frying with a large amount of oil in the saucepan | 5/170 °C | 170 - 180 °C | E.g. doughnuts, meatballs |

Tips for cooking with the cooking functions

- Heating/keep-warm function: Frozen products in portions, e.g. spinach. Place the frozen product in the cookware. Pour in the volume of water specified by the manufacturer. Cover the cookware and select the setting 1/70 °C. Stir occasionally.
- Poaching function: This function is suitable for cooking food at low temperatures and for thickening sauces and stews. Select setting 2/90 °C.
- Boiling function: This function allows you to boil water with a lid without it boiling over. You can boil efficiently thanks to the temperature control. Select setting 3/100 °C.
- Cooking in a pressure cooker function: Follow the manufacturer's recommendations. Continue cooking for the recommended time once the signal has sounded. Select setting 4/120 °C.
- Frying with a large amount of oil in the saucepan function: To heat the oil with the lid on. Remove the lid after the signal tone and add the food (insofar as there are no other instructions in the "Recommended dishes" table). Select setting 5/170 °C.

Notes

- Always cook with the lid on. Exception: "Frying with a large amount of oil in the saucepan", temperature setting 5/170 °C.
- If an audible signal does not sound, make sure that the lid is on the pan.
- Never leave oil unattended during heating. Use oil or fat that is suitable for frying. Do not mix different cooking fats together, e.g. oil and lard. Mixtures of different fats may froth up when hot.
- If you are not satisfied with the cooking result, e.g. when cooking potatoes, next time use less water but keep the recommended temperature setting.

Setting the boiling point

The point at which water starts to boil depends on the height of your home above sea level. You can set the boiling point if water is boiling too strongly or not strongly enough. To do this, proceed as follows:

- Select the basic setting **4**; see the section on → "Basic settings"
- The basic setting is 3 as standard. If your home is between 200 and 400 metres above sea level, there is no need to set the boiling point. If not, choose the correct setting from the following table according to your altitude:

| Height | Setting 4 |
|-----------------|------------------|
| 0 - 100 m. | 1 |
| 100 - 200 m. | 2 |
| 200 - 400 m. | 3* |
| 400 - 600 m. | 4 |
| 600 - 800 m. | 5 |
| 800 - 1000 m. | 6 |
| 1000 - 1200 m. | 7 |
| 1200 - 1400 m. | 8 |
| Above 1400 m. | 9 |
| * Basic setting | |

Note: Temperature setting 3/100 °C is sufficient for efficient boiling, even if the water does not boil very strongly. However, the boiling point can be changed. For example, you can set a lower altitude if you want the water to boil more strongly.

Setting procedure

You will need to connect the wireless cooking sensor to the control panel before using the cooking functions for the first time. Refer to the section entitled → "📶 Wireless temperature sensor" to find out how to do this

1. Attach the temperature sensor to the saucepan; see the section on → "Preparing and maintaining the wireless temperature sensor"
2. Place a saucepan filled with sufficient liquid on the required hotplate and always put the lid on.
3. Select the hotplate on which you have placed the saucepan with the temperature sensor.
4. Touch the 📶 symbol on the temperature sensor. The indicator 📶 will light up in the control panel.

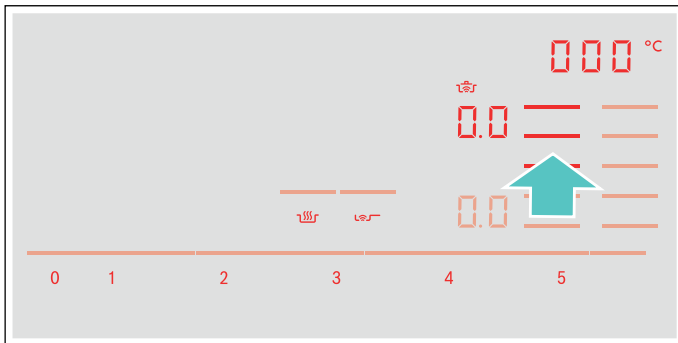

5. Select the right temperature setting from the table.

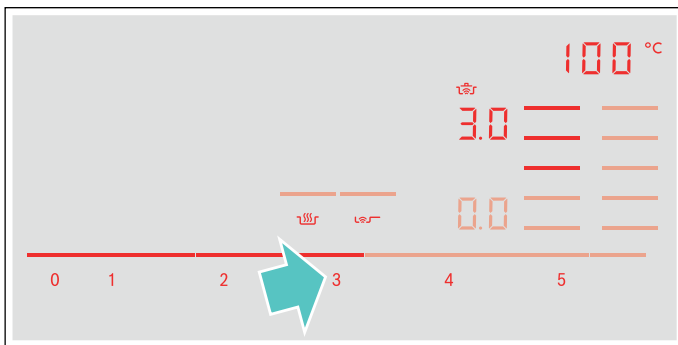

The function has now been activated.

The temperature symbol 📶 will flash until the water or oil has reached the right temperature for adding the food. A signal will sound and the temperature symbol will stop flashing.

6. Once the signal has sounded, take the lid off and add the food. Keep the lid on during cooking.
Note: Do not cover the pan when using the "Frying with a large amount of oil in the saucepan" function.

Switching off cooking functions



Select the hotplate and set it to 0.0 on the control panel. The hotplate will switch off and the residual heat indicator will appear.























Note: To re-activate the cooking functions, wait for approximately 10 seconds.

Recommended dishes

The following table shows a selection of dishes and is arranged by food type. The temperature and the cooking time depend on the amount, the condition and the quality of the food.

Cooking assistance functions:

| | |
|--|------------------------|
|  | Frying sensor for pans |
|  | Cooking sensor |

| Meat | Cooking assistance functions | Temperature level | Total cooking time from signal tone (mins) |
|--|---|-------------------|--|
| Frying with little amount of oil | | | |
| Escalope, plain ¹ |  | 4 | 6 - 10 |
| Escalope, breaded ¹ |  | 4 | 6 - 10 |
| Fillet ² |  | 4 | 6 - 10 |
| Chops ¹ |  | 3 | 10 - 15 |
| Cordon bleu ¹ |  | 4 | 10 - 15 |
| Viennese schnitzel ¹ |  | 4 | 10 - 15 |
| Steak, rare (3 cm thick) ² |  | 5 | 6 - 8 |
| Steak, medium (3 cm thick) ² |  | 5 | 8 - 12 |
| Steak, well done (3 cm thick) ¹ |  | 4 | 8 - 12 |
| Poultry breast (2 cm thick) ¹ |  | 3 | 10 - 20 |
| Meat cut into strips ³ |  | 4 | 7 - 12 |
| Gyros ³ |  | 4 | 7 - 12 |
| Bacon ¹ |  | 2 | 5 - 8 |
| Minced meat ³ |  | 4 | 6 - 10 |
| Hamburgers (1.5 cm thick) ¹ |  | 3 | 6 - 15 |
| Meatballs (2 cm thick) ¹ |  | 3 | 10 - 20 |
| Rissoles ¹ |  | 3 | 10 - 20 |
| Boiled sausages ¹ |  | 3 | 8 - 20 |
| Raw sausages ¹ |  | 3 | 8 - 20 |
| Simmering | | | |
| Sausages ⁴ |  | 2 - 90 °C | 10 - 20 |
| Boiling | | | |
| Meatballs ⁴ |  | 3 - 100 °C | 20 - 30 |
| Chicken ⁴ |  | 3 - 100 °C | 60 - 90 |
| Beef ⁴ |  | 3 - 100 °C | 60 - 90 |

¹ Turn frequently.





² Add the oil and the food after the signal tone.

³ Stir frequently.

⁴ Heat up and cook with the lid on. Add the food after the signal sounds.

⁵ Add the food at the start.

⁶ Heat the oil with the lid on. Fry one portion after the other without the lid.

| Meat | Cooking assistance functions | Temperature level | Total cooking time from signal tone (mins) |
|--|---|-------------------|--|
| Cooking in a pressure cooker | | | |
| Chicken in pressure cooker ⁵ |  | 4 - 120 °C | 15 - 25 |
| Beef in pressure cooker ⁵ |  | 4 - 120 °C | 15 - 25 |
| Deep fry with a large amount of oil | | | |
| Deep frying chicken portions ⁶ |  | 5 - 170 °C | 10 - 15 |
| Deep fry meatballs ⁶ |  | 5 - 170 °C | 10 - 15 |

¹ Turn frequently.









² Add the oil and the food after the signal tone.

³ Stir frequently.

⁴ Heat up and cook with the lid on. Add the food after the signal sounds.

⁵ Add the food at the start.









⁶ Heat the oil with the lid on. Fry one portion after the other without the lid.

| Fish | Cooking assistance functions | Temperature level | Total cooking time from signal tone (mins) |
|--|---|-------------------|--|
| Frying with a little amount of oil | | | |
| Fish fillet, plain ¹ |  | 4 | 10 - 20 |
| Fish fillet, breaded ¹ |  | 3 | 10 - 20 |
| Prawns ¹ |  | 4 | 4 - 8 |
| Scampi ¹ |  | 4 | 4 - 8 |
| Fried whole fish ¹ |  | 3 | 10 - 20 |
| Poaching | | | |
| Stewed fish ² |  | 2 - 90 °C | 15 - 20 |
| Deep fry with a large amount of oil | | | |
| Deep-fat frying fish in beer batter ³ |  | 5 - 170 °C | 10 - 15 |
| Deep-fat frying breaded fish ³ |  | 5 - 170 °C | 10 - 15 |











¹ Turn frequently.

² Heat up and cook with the lid on. Add the food after the signal sounds.















³ Heat the oil with the lid on. Fry one portion after the other without the lid.

| Egg dishes | Cooking assistance functions | Temperature level | Total cooking time from signal tone (mins) |
|---|---|-------------------|--|
| Frying with a little amount of oil | | | |
| Fried eggs in butter ¹ |  | 2 | 2-6 |
| Fried eggs ² |  | 4 | 2-6 |
| Scrambled eggs ³ |  | 2 | 4-9 |
| Omelette ⁴ |  | 2 | 3-6 |
| Crêpes ⁴ |  | 5 | 1,5-2,5 |
| French toast ⁴ |  | 3 | 4-8 |
| Shredded raisin pancake ⁴ |  | 3 | 10-15 |
| Boiling | | | |
| Boiled eggs ⁵ |  | 3-100 °C | 5-10 |

- ¹ Add butter and the food after the signal tone sounds.
- ² Add the oil and food to the frying pan after the signal sounds.
- ³ Stir frequently.
- ⁴ Time indicated per portion. Fry individually.
- ⁵ Add the food at the start.

| Vegetables and pulses | Cooking assistance functions | Temperature level | Total cooking time from signal tone (mins) |
|---|---|-------------------|--|
| Frying with a little amount of oil | | | |
| Garlic ¹ |  | 2 | 2-10 |
| Onions, glazed ¹ |  | 2 | 2-10 |
| Onion rings ¹ |  | 3 | 5-10 |
| Courgettes ² |  | 3 | 4-12 |
| Aubergines ² |  | 3 | 4-12 |
| Peppers ¹ |  | 3 | 4-15 |
| Green asparagus ² |  | 3 | 4-15 |
| Mushrooms ¹ |  | 4 | 10-15 |
| Sautéing vegetables in oil ¹ |  | 1 | 10-20 |
| Glazed vegetables ¹ |  | 3 | 6-10 |

- ¹ Stir frequently.
- ² Turn frequently.
- ³ Heat up and cook with the lid on. Add the food to the frying pan after the signal sounds.
- ⁴ Add the food at the start.
- ⁵ Heat the oil with the lid on. Fry one portion after the other without the lid.

| Vegetables and pulses | Cooking assistance functions | Temperature level | Total cooking time from signal tone (mins) |
|--|---|-------------------|--|
| Boiling | | | |
| Broccoli ³ |  | 3 - 100 °C | 10 - 20 |
| Cauliflower ³ |  | 3 - 100 °C | 10 - 20 |
| Brussels sprouts ³ |  | 3 - 100 °C | 30 - 40 |
| Green beans ³ |  | 3 - 100 °C | 15 - 30 |
| Chickpeas ⁴ |  | 3 - 100 °C | 60 - 90 |
| Peas ³ |  | 3 - 100 °C | 15 - 20 |
| Lentils ⁴ |  | 3 - 100 °C | 45 - 60 |
| Cooking in a pressure cooker | | | |
| Vegetables in a pressure cooker ⁴ |  | 4 - 120 °C | 3 - 6 |
| Chickpeas in a pressure cooker ⁴ |  | 4 - 120 °C | 25 - 35 |
| Beans in a pressure cooker ⁴ |  | 4 - 120 °C | 25 - 35 |
| Lentils in a pressure cooker ⁴ |  | 4 - 120 °C | 10 - 20 |
| Deep-frying with a large amount of oil | | | |
| Deep frying breaded vegetables ⁵ |  | 5 - 170 °C | 4 - 8 |
| Deep frying vegetables in beer batter ⁵ |  | 5 - 170 °C | 4 - 8 |
| Deep frying breaded mushrooms ⁵ |  | 5 - 170 °C | 4 - 8 |
| Deep frying mushrooms in beer batter ⁵ |  | 5 - 170 °C | 4 - 8 |









¹ Stir frequently.

² Turn frequently.

³ Heat up and cook with the lid on. Add the food to the frying pan after the signal sounds.

⁴ Add the food at the start.

⁵ Heat the oil with the lid on. Fry one portion after the other without the lid.

| Potatoes | Cooking assistance functions | Temperature level | Total cooking time from signal tone (mins) |
|--|---|-------------------|--|
| Frying with a little amount of oil | | | |
| Potatoes boiled in their skin ¹ |  | 5 | 6 - 12 |
| Fried potatoes (made from raw potatoes) ¹ |  | 4 | 15 - 25 |
| Potato pancakes ² |  | 5 | 2,5 - 3,5 |
| Swiss rösti ³ |  | 2 | 50 - 55 |
| Glazed potatoes ¹ |  | 3 | 10 - 15 |
| Simmering | | | |
| Potato dumplings ⁴ |  | 2 - 90 °C | 30 - 40 |
| Boiling | | | |
| Boiling potatoes ⁵ |  | 3 - 100 °C | 30 - 45 |
| Cooking in a pressure cooker | | | |
| Potatoes in a pressure cooker ⁵ |  | 4 - 120 °C | 10 - 20 |







¹ Stir frequently.

² Time indicated per portion. Fry individually.

³ Add the oil and food to the frying pan after the signal sounds.

⁴ Heat up and cook with the lid on. Add the food after the signal sounds.





⁵ Add the food at the start.

| Pasta and cereals | Cooking assistance functions | Temperature level | Total cooking time from signal tone (mins) |
|--|---|-------------------|--|
| Simmering | | | |
| Rice ¹ |  | 2 - 90 °C | 25 - 35 |
| Polenta ² |  | 2 - 90 °C | 3 - 8 |
| Semolina pudding ² |  | 2 - 90 °C | 5 - 10 |
| Boiling | | | |
| Pasta ² |  | 3 - 100 °C | 7 - 10 |
| Stuffed pasta ² |  | 3 - 100 °C | 6 - 15 |
| Cooking in a pressure cooker | | | |
| Rice in a pressure cooker ³ |  | 4 - 120 °C | 5 - 8 |

¹ Heat up and cook with the lid on. Add the food after the signal sounds.





² Stir frequently.

³ Add the food at the start.







| Soups | Cooking assistance functions | Temperature level | Total cooking time from signal tone (mins) |
|---|---|-------------------|--|
| Simmering Instant creamy soups ¹ |  | 2 - 90 °C | 10 - 15 |
| Boiling Home-made broths ² |  | 3 - 100 °C | 60 - 90 |
| Instant soups ¹ |  | 3 - 100 °C | 5 - 10 |
| Cooking in a pressure cooker Home-made broths in a pressure cooker ² |  | 4 - 120 °C | 20 - 30 |

¹ Stir frequently.

² Add the food at the start.

| Sauces | Cooking assistance functions | Temperature level | Total cooking time from signal tone (mins) |
|--|---|-------------------|--|
| Frying with a little amount of oil Tomato sauce with vegetables ¹ |  | 1 | 25 - 35 |
| Béchamel sauce ¹ |  | 1 | 10 - 20 |
| Cheese sauce ¹ |  | 1 | 10 - 20 |
| Reducing sauces ¹ |  | 1 | 25 - 35 |
| Sweet sauces ¹ |  | 1 | 15 - 25 |

















¹ Stir frequently.

| Desserts | Cooking assistance functions | Temperature level | Total cooking time from signal tone (mins) |
|---|---|-------------------|--|
| Simmering Rice pudding ¹ |  | 2 - 90 °C | 40 - 50 |
| Porridge oats ¹ |  | 2 - 90 °C | 10 - 15 |
| Chocolate pudding ¹ |  | 2 - 90 °C | 3 - 5 |
| Boiling Compote ² |  | 3 - 100 °C | 15 - 25 |
| Deep frying with a large amount of oil Deep frying Berliners ³ |  | 5 - 170 °C | 5 - 10 |
| Deep frying ring doughnuts ³ |  | 5 - 170 °C | 5 - 10 |
| Deep frying buñuelos ³ |  | 5 - 170 °C | 5 - 10 |

¹ Stir frequently.

² Add the food at the start.

³ Heat the oil with the lid on. Fry one portion after the other without the lid.









| Frozen products | Cooking assistance functions | Temperature level | Total cooking time from signal tone (mins) |
|---|---|-------------------|--|
| Frying with a little amount of oil | | | |
| Escalope ¹ |  | 4 | 15 - 20 |
| Cordon bleu ¹ |  | 4 | 10 - 30 |
| Poultry breast ¹ |  | 4 | 10 - 30 |
| Chicken nuggets ¹ |  | 4 | 10 - 15 |
| Gyros ² |  | 4 | 10 - 15 |
| Kebab ² |  | 4 | 10 - 15 |
| Fish fillet, plain ¹ |  | 3 | 10 - 20 |
| Fish fillet, breaded ¹ |  | 3 | 10 - 20 |
| Fish fingers ¹ |  | 4 | 8 - 12 |
| Fry French fries ² |  | 5 | 4 - 6 |
| Stir-fries ² |  | 3 | 6 - 10 |
| Spring rolls ¹ |  | 4 | 10 - 30 |
| Camembert ¹ |  | 3 | 10 - 15 |
| Keeping warm, heating | | | |
| Vegetable in cream sauce ² |  | 1 - 70 °C | 15 - 20 |
| Boiling | | | |
| Green beans, frozen ³ |  | 3 - 100 °C | 15 - 30 |
| Fry with a large amount of oil | | | |
| Deep-frying French Fries ⁴ |  | 5 - 170 °C | 4 - 8 |

¹ Turn frequently.

² Stir frequently.

³ Heat up and cook with the lid on. Add the food after the signal sounds.

⁴ Heat the oil with the lid on. Fry one portion after the other without the lid.

| Other | Cooking assistance functions | Temperature level | Total cooking time from signal tone (mins) |
|---|---|-------------------|--|
| Frying with a little amount of oil | | | |
| Camembert ¹ |  | 3 | 7 - 10 |
| Croûtons ² |  | 3 | 6 - 10 |
| Dried ready meals ³ |  | 1 | 5 - 10 |
| Toasting almonds ⁴ |  | 4 | 3 - 15 |
| Toasting nuts ⁴ |  | 4 | 3 - 15 |
| Toasting pine nuts ⁴ |  | 4 | 3 - 15 |
| Keeping warm, heating | | | |
| Heating goulash soup ⁵ |  | 1 - 70 °C | 10 - 20 |
| Heating mulled wine ⁵ |  | 1 - 70 °C | 5 - 15 |
| Simmering | | | |
| Heating milk ⁵ |  | 2 - 90 °C | 3 - 10 |

¹ Turn frequently.

² Stir frequently.

³ Add the water after the signal sounds. Add the food as soon as the water boils.

⁴ Add the food after the signal tone sounds.

⁵ Add the food at the start.

Teppan Yaki and Grill for the Flex Zone

The Teppan Yaki and Grill accessories are ideal for the FlexZone and are perfect for using the frying sensor.

Grill







































The Grill adapts to the Flex Zone. You can cook large and small quantities of meat, fish, fresh vegetables and bread with very little oil, healthily and easily. The grooved shape ensures that food absorbs less fat. The ease of operation makes it possible to grill dishes that look and taste like they have been cooked on a traditional grill. Add a little oil to the grill or the surface of the food to facilitate heat transfer.

Teppan Yaki

The Teppan Yaki enables you to cook meat, fish, seafood, vegetables, desserts and bread with very little oil, easily and healthily. The Teppan Yaki adapts perfectly to the Flex Zone. Direct contact with the plate and uniform heat transfer make it possible to retain the consistency, colour and succulence of the food when searing and browning.

The following table shows a selection of dishes and is arranged by food type. The temperature and the cooking time depend on the amount, the condition and the quality of the food.

Note: Set up the Flex Zone as a single cooking zone to ensure the function is activated correctly.

| | Cookware | Temperature level | Total frying time after the signal tone sounds (min) |
|--|---|-------------------|--|
| Meat | | | |
| Escalope, plain ¹ |  /  | 4 | 6 - 10 |
| Fillet ¹ |  /  | 4 | 6 - 10 |
| Chops ¹ |  /  | 3 | 10 - 15 |
| Steak, rare (3 cm thick) ¹ |  /  | 5 | 6 - 8 |
| Steak, medium (3 cm thick) ¹ |  /  | 5 | 8 - 12 |
| Steak, well done (3 cm thick) ¹ |  /  | 4 | 8 - 12 |
| Poultry breast (2 cm thick) ¹ |  /  | 3 | 10 - 20 |
| Bacon ¹ |  /  | 3 | 5 - 8 |
| Hamburgers ¹ |  /  | 3 | 6 - 15 |
| Boiled sausages ¹ |  /  | 4 | 8 - 20 |
| Raw sausages ¹ |  /  | 4 | 8 - 20 |
| Gyros ² |  | 4 | 7 - 12 |
| Minced meat ² |  | 4 | 6 - 10 |
| Fish and seafood | | | |
| Fish fillet, plain ¹ |  /  | 4 | 10 - 20 |
| Scampi ¹ |  /  | 4 | 4 - 8 |
| Prawns ¹ |  /  | 4 | 4 - 8 |
| Frying fish, whole ¹ |  /  | 3 | 15 - 30 |
| Vegetables | | | |
| Courgettes ¹ |  /  | 3 | 4 - 12 |
| Aubergines ¹ |  /  | 3 | 4 - 12 |
| Peppers ¹ |  /  | 3 | 4 - 15 |

¹ Add oil (if necessary) and the food after the signal tone sounds. Turn if necessary.























² Add oil (if necessary) and the food after the signal tone sounds. Stir regularly.

³ Add butter and the food after the signal tone sounds. Turn if necessary.

⁴ Add oil (if necessary) and the food after the signal tone sounds. Total cooking time per portion. Fry individually.

⁵ Add oil (rub into the food) and the food after the signal tone sounds. Turn if necessary.

⁶ Add the food after the signal tone sounds.

| | Cookware | Temperature level | Total frying time after the signal tone sounds (min) |
|--|---|-------------------|--|
| Frying green asparagus ¹ |  /  | 3 | 4 - 15 |
| Mushrooms ² |  /  | 4 | 10 - 15 |
| Garlic ² |  | 2 | 2 - 10 |
| Sweating onions ² |  | 2 | 2 - 10 |
| Glazing vegetables ² |  | 3 | 6 - 10 |
| Potatoes | | | |
| Fried potatoes (made from unpeeled boiled potatoes) ² |  | 5 | 6 - 12 |
| Potato pancakes ⁴ |  | 5 | 2,5 - 3,5 |
| Glazed potatoes ² |  | 3 | 10 - 15 |
| Egg dishes | | | |
| Fried eggs in butter ³ |  | 2 | 2 - 6 |
| Fried eggs in oil ¹ |  | 4 | 2 - 6 |
| Scrambled eggs ² |  | 2 | 4 - 9 |
| Omelettes ⁴ |  | 2 | 3 - 6 |
| Pancakes ⁴ |  | 5 | 1,5 - 2,5 |
| French toast ⁴ |  | 3 | 4 - 8 |
| Shredded raisin pancake ⁴ |  | 3 | 10 - 15 |
| Miscellaneous | | | |
| Toasting ⁵ |  /  | 4 | 4 - 6 |
| Croûtons ² |  | 3 | 6 - 10 |
| Toasting almonds ⁶ |  | 4 | 3 - 15 |
| Toasting nuts ⁶ |  | 4 | 3 - 15 |
| Toasting pine nuts ⁶ |  | 4 | 3 - 15 |

¹ Add oil (if necessary) and the food after the signal tone sounds. Turn if necessary.

² Add oil (if necessary) and the food after the signal tone sounds. Stir regularly.

³ Add butter and the food after the signal tone sounds. Turn if necessary.

⁴ Add oil (if necessary) and the food after the signal tone sounds. Total cooking time per portion. Fry individually.

⁵ Add oil (rub into the food) and the food after the signal tone sounds. Turn if necessary.

⁶ Add the food after the signal tone sounds.

Wireless temperature sensor

You will need to connect the wireless temperature sensor to the control panel before using the cooking functions for the first time.

Preparing and maintaining the wireless temperature sensor

This section provides information on:

- Adhering the silicone patch
- Attaching the wireless cooking sensor
- Cleaning
- Changing the battery

The silicone patch and the cooking sensor can be purchased at a later time from specialist retailers, our technical after-sales service or our official website. To do this, quote the relevant reference number:

| | |
|----------|--|
| 00577921 | Set of 5 silicone patches |
| HEZ39050 | Cooking sensor and set of 5 silicone patches |

Adhering the silicone patch

The silicone patch attaches the temperature sensor to the cookware.

When a pan is used for the first time with the cooking functions, the silicone patch must be adhered directly to the pan. It is important

1. That the adhesive area on the pan is free from grease. Clean the pan, dry it thoroughly and wipe the adhesive area with a spirit.
2. Remove the protective film from the silicone patch. Adhere the silicone patch to the outside of the pan in the correct place using the enclosed template as a guide.

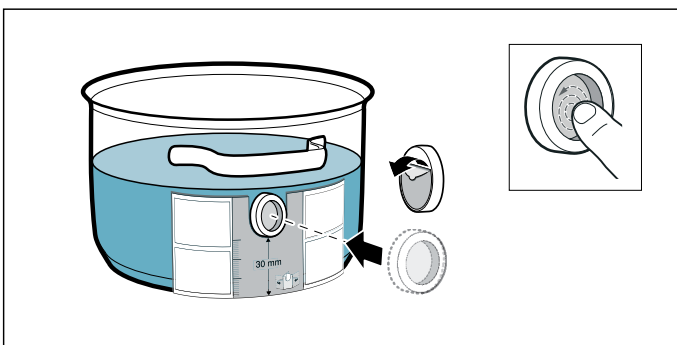

3. Press down all over the surface of the silicone patch, including in the centre.

The adhesive requires one hour to fully harden. Do not use or clean the pan during this time.

Notes

- Do not leave the pan with the silicone patch to soak soapy water for long periods of time.
- If the silicone patch comes off, attach a new one.

Fitting the wireless temperature sensor

Attach the temperature sensor to the silicone patch and align it correctly.

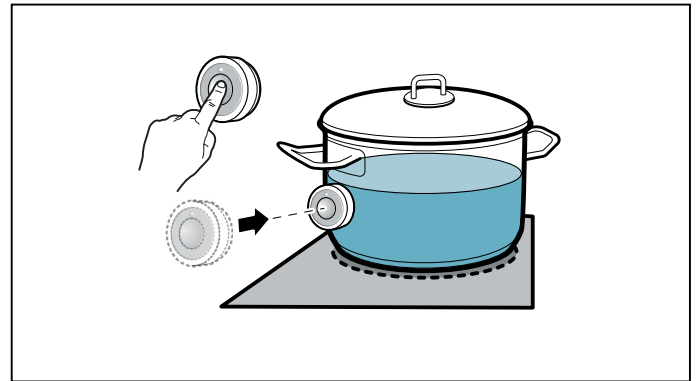

Notes

- Make sure that the silicone patch is completely dry before attaching the temperature sensor.
- Position the cookware in such a way that the temperature sensor is pointing towards the outer side of the hob.
- To prevent overheating, the temperature sensor must not be pointed towards another item of cookware that is hot.
- Remove the temperature sensor from the saucepan after cooking. Store it in a clean, safe place away from sources of heat.
- You can use up to three temperature sensors at the same time.

Connecting the wireless temperature sensor to the control panel

To connect the wireless temperature sensor to the control panel, follow the instructions below:

1. Select the **14** menu; see the section on → "Basic settings"
The hotplate indicator will light up.
2. Select the hotplate and its indicator will light up. A signal will sound. The **14** indicator will light up.
3. Press the **14** symbol on the wireless temperature sensor within 30 seconds.
After a few seconds, the status of the connection between the temperature sensor and the control panel will appear on the hotplate's display.

Status

| | |
|----------|--|
| 0 | Connected correctly |
| 1 | Not connected correctly: Transmission error. |
| 2 | Not connected correctly: Temperature sensor fault. |

- The cooking functions are made available once the temperature sensor has been connected to the control panel correctly.
- If there is a fault with the temperature sensor, the connection may not be established correctly for the following reasons:
 - Bluetooth communication error.
 - You did not press the symbol on the temperature sensor within 30 seconds of selecting a hotplate.
 - The battery in the temperature sensor has run out.

Reset the wireless temperature sensor and follow the connection procedure once again.

- If the temperature sensor and the control panel are not connected correctly due to a transmission error, follow the connection procedure once again. If the display continues to show incorrect connection ! , contact our technical after-sales service.

Resetting the wireless temperature sensor

1. Touch and hold the  symbol for approximately 8-10 seconds. While you are doing this, the temperature sensor's LED indicator will light up three times. When the LED lights up for the third time, it will start to reset the temperature sensor. At this point, you will need to lift your finger off the symbol. Once the LED goes out, this means that the wireless temperature sensor has been reset.
2. Repeat the connection procedure from point 2.

Cleaning

Do not clean the wireless temperature sensor in the dishwasher.

Temperature sensor

Clean the temperature sensor with a damp cloth. Never clean it in the dishwasher. Do not immerse it in water or clean it under running water.

Remove the temperature sensor from the saucepan after cooking. Store it in a clean, safe place (such as in its packaging) away from sources of heat.

Silicone patch

Clean and dry before attaching to the temperature sensor. Dishwasher safe.

Note: Cookware with the silicone patch must not be left to soak for long periods in soapy water.

Temperature sensor window

The sensor window must always be clean and dry. Proceed as follows:

- Remove dirt and oil splatters regularly.
- Use a soft cloth or cotton buds and window cleaner for cleaning.

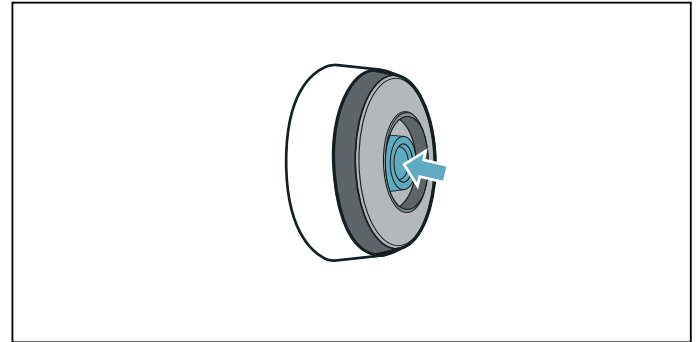

Notes

- Do not use abrasive cleaning agents such as scouring pads, scrubbing brushes or cream cleaners.
- Do not touch the sensor window with your fingers. This may make it dirty or scratch it.

Changing the battery

If the temperature sensor does not light up when the symbol is pressed, the battery is flat.

Changing the battery:

1. Remove the silicone cover from the lower section of the temperature sensor housing and remove both screws using a screwdriver.

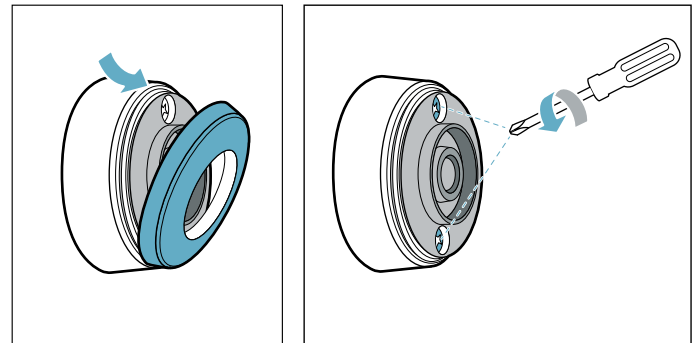

2. Open the closure of the temperature sensor. Remove the battery from the lower section of the housing and insert a new battery (pay attention to the correct orientation of the battery poles).

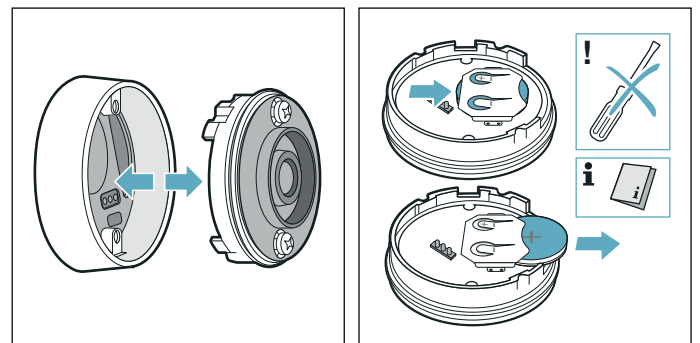

Caution!

Do not use any metal objects to remove the battery. Do not touch the battery connection points.

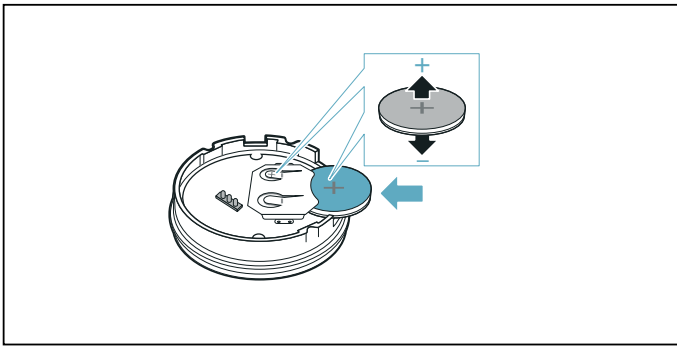

3. Close the closure of the temperature sensor (the notches for the screws on the closure must align with the notches on the lower section of the housing). Tighten the screws with a screwdriver.

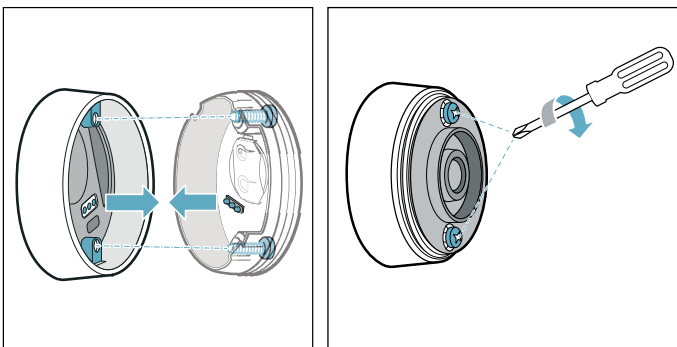

4. Reattach the silicone cover to the lower section of the temperature sensor housing.

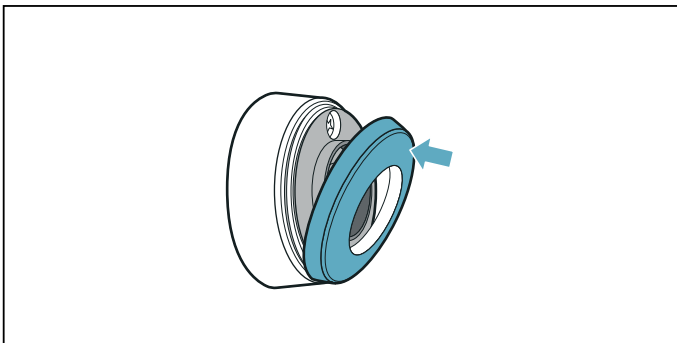

Note: Use only high-quality batteries of the type CR2032 in order to guarantee a long service life.

Declaration of Conformity

Robert Bosch Hausgeräte GmbH hereby declares that the appliance with wireless temperature sensor function meets the basic requirements and other relevant provisions of the Directive 2014/53/EU.

A detailed RED Declaration of Conformity can be found online at www.bosch-home.com/de on the product page for appliance in the additional documents.

The logos and the Bluetooth® brand are registered trademarks and property of Bluetooth SIG, Inc. These trademarks are used by Robert Bosch Hausgeräte GmbH under licence. All other trademarks and brand names are owned by the respective companies.



Childproof lock

You can use the childproof lock to prevent children from switching on the hob.

Activating and deactivating the childproof lock

The hob must be switched off.

To activate:

1. Switch on the hob using the main switch.
2. Touch the  symbol for approx. 4 seconds. The  indicator lights up for 10 seconds. The hob is locked.

To deactivate:

1. Switch on the hob using the main switch.
2. Touch the  symbol for approx. 4 seconds. The lock is released.

Childproof lock

With this function, the childproof lock automatically activates when a hob is switched off.

Switching on and off

You can find out how to switch the automatic childproof lock on in the → "Basic settings" section

Wipe protection

If you wipe over the control panel while the hob is switched on, settings may be altered. To avoid doing this, you can use the hob's "Lock control panel for cleaning" function.

To switch on: Touch the  symbol. An audible signal sounds. The control panel is locked for 35 seconds. You can now wipe over the surface of the control panel without altering any settings.

To deactivate: The control panel will be unlocked once 35 seconds have elapsed. To release the function early, touch the  symbol.

Notes

- An audible signal sounds 30 seconds after activation. This indicates that the function is about to finish.
- The cleaning lock does not lock the main switch. The hob can be switched off at any time.

Automatic safety cut-out

If a hotplate operates for an extended period and no settings are changed, the automatic safety shut-off is activated.

The hotplate stops heating. **FE** and the residual heat indicator **h** or **H** flash alternately in the hotplate display.

When you touch any symbol, the display switches off. The hotplate can now be set again.

The point at which the safety shut-off becomes active depends on which heat setting has been set (after 1 to 10 hours).

Basic settings

The appliance has various basic settings. These basic settings can be altered to suit your individual requirements.

| Indicator/ symbol | Function |
|----------------------|--|
| c 1 | Childproof lock 0 Manual*. 1 Automatic. 2 Function deactivated. |
| c 2 | Signal tones 0 Confirmation and fault signals are switched off. 1 Only the fault signal is switched on. 2 Only the confirmation signal is switched on. 3 All signal tones are switched on.* |
| c 3 | Display energy consumption 0 Deactivated.* 1 Activated. |
| c 4 | Setting to account for height above sea level 1-2 Decrease 3 Basic setting 4-9 Expansion |
| c 5 | Automatically programming the cooking time 00 Switched off.* 0 1-99 Time until automatic switch-off. |
| c 6 | Audible signal duration for the timer function 1 10 seconds.* 2 30 seconds. 3 1 minute. |
| c 7 | Power management function. Limiting the total power of the hob The available settings depend on the maximum power of the hob. 0 Deactivated. Maximum power of the hob. */** 1 1000 W minimum power. 1. 1500 W ... 3 3000 W recommended for 13 A. 3. 3500 W recommended for 16 A. 4 4000 W 4. 4500 W recommended for 20 A. ... 9 or 9. Maximum power of the hob.** |
| c 11 | Changing preset power levels for the Move function -9 Preset power level for the front cooking area. -5 Preset power level for the central cooking area. -1. Preset power level for the rear cooking area. |

| | |
|-------------|--|
| c 12 | Check the cookware and the cooking results |
| 0 | Not suitable |
| 1 | Not perfect |
| 2 | Suitable |
| c 13 | Configuring activation of the flexible cooking zone |
| 0 | As two independent cooking zones.* |
| 1 | As a single cooking zone. |
| c 14 | Connecting the wireless cooking sensor to the hob |
| 0 | Connected correctly |
| 1 | Not connected correctly: Transmission error. |
| 2 | Not connected correctly: Temperature sensor fault. |
| c 0 | Restore to standard settings |
| 0 | Individual settings.* |
| 1 | Restore factory settings. |

*Factory setting

**The hob's maximum power output is shown on the rating plate.

To access the basic settings:

The hob must be off.

1. Switch on the hob.
2. Within ten seconds, touch and hold the  symbol for approximately four seconds.
The first four displays provide product information.
Touch the settings area to view the individual displays.

| Product information | Display screen |
|----------------------------------|----------------|
| After-sales service index (ASSI) | 01 |
| Production number | Fd |
| Production number 1 | 95. |
| Production number 2 | 05 |

3. Touching the  symbol again takes you to the basic settings.
c 1 and **0** light up as a preset in the displays.

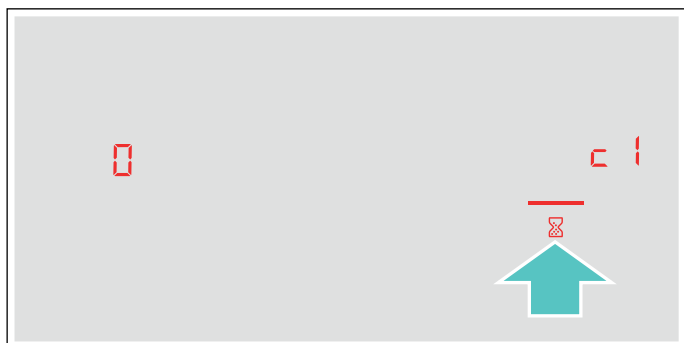

4. Touch the  symbol repeatedly until the required function is displayed.
5. Then select the required setting from the settings area.



6. Touch the  symbol for at least four seconds.

The settings have been saved.

Leaving the basic settings

Turn off the hob with the main switch.

Energy consumption indicator

This function indicates the total amount of energy consumed by this hob the last time it was used for cooking.

Once the hob is switched off, the energy consumption is displayed in kilowatt hours (e.g. **1.08** kWh) for 10 seconds.

The accuracy of the information displayed depends on the voltage quality of the mains power supply, among other factors.

You can find out how to switch this function on in the section on → *"Basic settings"*

Cookware check

This function can be used to check the speed and quality of the cooking process depending on the cookware.

The result is a reference value and depends on the properties of the cookware and the hotplate being used.

1. Correctly position the pot with approximately 200 ml of water, at room temperature, on the most suitable cooking zone for the diameter of the bottom of the pot.
2. Go to the basic settings and select the setting **c 12**.
3. Press the programming area. **—** flashes in the cooking zone displays.

The function has now been activated.

After 10 seconds, the cooking result and the speed of the cooking process appear in the visual displays for the cooking zone.

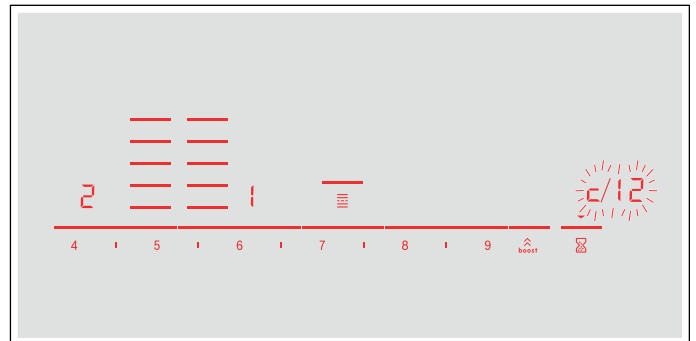

Check the result using the following table:

| Result | |
|----------|--|
| 0 | The cookware is not suitable for the hotplate and will therefore not heat up.* |
| 1 | The cookware is taking longer to heat up than expected and the cooking process is not going as well as it should.* |
| 2 | The cookware is heating up correctly and the cooking process is going well. |

* If there is a smaller hotplate available, test the cookware again on the smaller hotplate.

To reactivate this function, touch the settings range.

Notes

- The flexible cooking zone only counts as a single hotplate; place no more than one item of cookware on it.
- If the diameter of the hotplate used is much smaller than the diameter of the cookware, only the middle of the cookware can be expected to heat up. This may result in the cooking results not being as good as expected or being less than satisfactory.
- You can find information on this function in the section on → *"Basic settings"*.
- You can find information on the type, size and positioning of the cookware in the sections on → *"Induction cooking"* and → *"Flex Zone"*.

Power manager

You can use the power manager to set the total power of the hob.

The hob is preset at the factory. Its maximum performance is specified on the rating plate. You can use the power manager to change the value in accordance with the requirements for the relevant electrical installation.

In order not to exceed this set value, the hob automatically distributes the power available between the cooking zones that are switched on.

As long as the power manager function is activated, the output of a cooking zone may temporarily fall below the nominal value. If a cooking zone is switched on and the power limit is reached, _ appears in the heat setting display for a short time. The appliance automatically regulates and selects the highest possible power level.

For more information about how the total power of the hob is changed, see section → *"Basic settings"*

Cleaning

Suitable maintenance and cleaning products can be purchased from the after-sales service or in our e-Shop.

Hob

Cleaning

Always clean the hob after cooking. This will prevent food deposits from becoming burned on. Only clean the hob after the residual heat indicator has gone out.

Clean the hob with a damp dish cloth and dry it with a cloth or towel to prevent limescale build-up.

Only use cleaning agents that are suitable for this type of hob. Observe the manufacturer's instructions on the product packaging.

Never use:

- Undiluted washing-up liquid
- Cleaning agents designed for dishwashers
- Abrasive cleaners
- Harsh cleaning agents, such as oven spray and limescale remover
- Scouring pads
- High-pressure cleaners or steam jet cleaners

Stubborn dirt is best removed with a glass scraper, available from retailers. Observe the manufacturer's instructions.

You can obtain a suitable glass scraper from customer services or through our online shop.

Using a special sponge for cleaning glass-ceramic hobs achieves a great cleaning result.

Potential marks

| | |
|-------------------------------|---|
| Limescale and water marks | Clean the hob as soon as it has cooled down. You can use a cleaning agent suitable for glass-ceramic hobs.* |
| Sugar, rice starch or plastic | Clean immediately. Use a glass scraper. Caution: Risk of burns.* |

* Then clean with a damp dish cloth and dry with a cloth or towel.

Note: Do not use any cleaning agents while the hob is still hot. This may mark the surface. Make sure that any residue left by cleaning agents is removed.

Hob surround

To prevent damage to the hob surround, observe the following instructions:

- Only use warm soapy water
- Wash new dish cloths thoroughly before use.
- Do not use harsh or abrasive cleaning agents.
- Do not use a glass scraper or sharp objects.

Frequently Asked Questions (FAQ)

Use

Why can't I switch on the hob and why is the childproof lock symbol lit?

The childproof lock is now active.

You can find information about this function in section → "*Childproof lock*"

Why are the indicators flashing and why can I hear a signal tone?

Remove any liquid or remnants of food from the control panel. Remove any objects from the control panel.

You can find instructions on how to deactivate the audible signal in the section on → "*Basic settings*"

Why can the cooking assistance functions not be activated?

The appliance's maximum power consumption is achieved or the power manager function has been activated. Switch off or reduce the power levels of the active hotplates.

You can find further information about this function in section → "*Power manager*"

Noises

Why I can hear noises while I'm cooking?

Noises may be generated while using the hob depending on the base material of the cookware. These noises are a normal part of induction technology. They do not indicate a defect.

Possible noises:

A low humming noise like the one a transformer makes:

Occurs when cooking at a high heat setting. The noise disappears or becomes quieter when the heat setting is reduced.

Low whistling noise:

Occurs when the cookware is empty. This noise disappears when water or food is added to the cookware.

Crackling:

Occurs when using cookware made from different layers of material or when using cookware of different sizes and different materials at the same time. The loudness of the noise can vary depending on the quantity of food being cooked or the cooking method.

High-pitched whistling noises:

Can occur when two hotplates are used at the highest heat setting at the same time. The whistling noises disappear or become quieter when the heat setting is reduced.

Fan noise:

The hob is equipped with a fan that switches on automatically at high temperatures. The fan may continue to run even after you have switched off the hob if the temperature detected is still too high.

Cookware

Which types of cookware can be used with an induction hob?

You can find information on which types of cookware can be used with an induction hob in the section on → *"Induction cooking"*.

Why is the hotplate not heating up and why is the heat setting flashing?

The hotplate on which the cookware is standing is not switched on.
Check that you have switched on the correct hotplate.

The cookware is too small for the hotplate that is switched on or it is not suitable for induction cooking.
Check that the cookware is suitable for induction cooking and that it is placed on the hotplate that best corresponds to its size. You can find information on the type, size and positioning of cookware in the sections on → *"Induction cooking"*, → *"Flex Zone"* and → *"Move function"*.

Why is it taking so long for the cookware to heat up or why is it not heating up sufficiently despite being on a high heat setting?

The cookware is too small for the hotplate that is switched on or it is not suitable for induction cooking.
Check that the cookware is suitable for induction cooking and that it is placed on the hotplate that best corresponds to its size. You can find information on the type, size and positioning of cookware in the sections on → *"Induction cooking"*, → *"Flex Zone"* and → *"Move function"*.

Cleaning

How do I clean the hob?

Using a special glass-ceramic cleaning agent produces the best results. We advise against using harsh or abrasive cleaning agents, dish-water detergent (concentrated) or scouring pads.
You can find more information on cleaning and caring for your hob in the section on → *"Cleaning"*

Trouble shooting

Usually, faults are small matters that are easy to eliminate. Please read the information in the table before calling the after-sales service.

| Indicator/symbol | Possible cause | Remedial action |
|--|--|---|
| None | The power supply has been disconnected. The appliance has not been connected as shown in the circuit diagram. Electronics fault. | Use other electrical appliances to check whether a short circuit has occurred in the power supply. Check that the appliance has been connected as shown in the circuit diagram. If the fault cannot be rectified, inform the technical after-sales service. |
| The indicators are flashing | The control panel is wet or an object is covering it. | Dry the control panel or remove the object. |
| The  indicator is flashing on the hotplate displays | A fault has occurred in the electronics. | To acknowledge the fault, briefly cover the control panel with your hand. |
| <i>F2/E8207</i> | The electronics have overheated and have switched off the corresponding hotplate. | Wait until the electronics have cooled down sufficiently. Then touch any symbol on the hob. |
| <i>F4/E8208</i> | The electronics have overheated and all the hotplates have been switched off. | |
| <i>F5</i> + heat setting and signal tone | There is hot cookware near the control panel. There is a risk that the electronics will overheat. | Remove the cookware. The fault code will go out shortly afterwards. You can resume cooking. |
| <i>F5</i> and signal tone | There is hot cookware near the control panel. To protect the electronics, the hotplate has been switched off. | Remove the cookware. Wait a few seconds. Touch any touch control. When the fault code on the display goes out, you can resume cooking. |
| <i>F1/F6</i> | The hotplate has overheated and has been switched off to protect your work surface. | Wait until the electronics have cooled down sufficiently before switching the hotplate on again. |
| <i>F0</i> | The transfer settings function cannot be activated | Touch any touch control to check the fault code. You can cook as usual without using the transfer settings function. Contact the technical after-sales service. |
| <i>F9</i> | The FlexPlus cooking zone will not activate | Touch any touch control to check the fault code. You can use the other hotplates to cook as usual. Contact the technical after-sales service. |
| <i>F8</i> | The hotplate has been operating continuously for an extended period. | The automatic safety switch-off function has been activated. See the section entitled |
| <i>E8202</i> | The temperature sensor has overheated and the hotplate has been switched off. | Wait until the temperature sensor has cooled down sufficiently before activating the function again. |
| <i>E8203</i> | The temperature sensor has overheated and all the hotplates have been switched off. | If you are not using the temperature sensor, remove it from the cookware and keep it away from the other hotplates and sources of heat. Switch the hotplates back on. |
| <i>E8204</i> | The battery in the temperature sensor has almost run out. | Replace the 3 V CR2032 battery. See the section entitled → "Changing the battery" |
| <i>E8205</i> | The wireless connection to the temperature sensor has been broken. | Switch the function off and then on again. |
| <i>E8206</i> | The temperature sensor is faulty. | Contact the technical after-sales service. |
| The temperature sensor indicator is not lighting up | The temperature sensor is not responding and the indicator is not lighting up. | Replace the 3 V CR2032 battery. See the section entitled → "Changing the battery" If this does not solve the problem, press and hold the symbol on the temperature sensor for 8-10 seconds and then reconnect the temperature sensor to the hob. See the section entitled → "Connecting the wireless temperature sensor to the control panel" If the problem persists, contact the technical after-sales service. |

Do not place hot cookware on the control panel.

| Indicator/symbol | Possible cause | Remedial action |
|---|---|--|
| The indicator on the sensor flashes twice | The battery in the temperature sensor has almost run out. You may be interrupted the next time you cook by the battery running out. | Replace the 3 V CR2032 battery. See the section entitled → <i>"Changing the battery"</i> |
| The indicator on the sensor flashes three times | The wireless connection to the temperature sensor has been broken. | Press and hold the symbol on the temperature sensor for 8-10 seconds and then reconnect the temperature sensor to the hob. See the section entitled → <i>"Connecting the wireless temperature sensor to the control panel"</i> |
| <i>E9000</i> <i>E90 10</i> | The operating voltage is incorrect/outside of the normal operating range. | Contact your electricity supplier. |
| <i>U400</i> | The hob is not connected properly | Disconnect the hob from the power supply. Check that it has been connected as shown in the circuit diagram. |
| <i>dE</i> | Demo mode is activated | Disconnect the hob from the power supply. Wait for 30 seconds before reconnecting it. Touch any touch control in the next 3 minutes. Demo mode has now been deactivated. |

Do not place hot cookware on the control panel.

Notes

- If *E* appears on the display, press and hold the button for the relevant cooking zone in order to read the fault code.
- If the fault code is not listed in the table, disconnect the hob from the mains power supply and wait 30 seconds before reconnecting it. If this code is displayed again, contact the technical after-sales service and specify which fault code has appeared.
- If a fault occurs, the appliance will not switch to standby mode.

Customer service

Our after-sales service is there for you if your appliance needs to be repaired. We will always find an appropriate solution, also in order to avoid after-sales personnel having to make unnecessary visits.

E number and FD number

Please quote the E number (product number) and the FD number (production number) of your appliance when contacting the after-sales service.

The rating plate bearing these numbers can be found:

- On the appliance certificate.
- On the lower section of the hob.

The E-number can also be found on the glass surface of the hob. You can check the customer index (KI) and FD number by going to the basic settings. Look up section → "*Basic settings*" for this.

Please note that a visit from an after-sales service engineer is not free of charge in the event of misuse of the appliance, even during the warranty period.

Please find the contact data of all countries in the enclosed customer service list.

To book an engineer visit and product advice

GB 0344 892 8979

Calls charged at local or mobile rate.

IE 01450 2655

0.03 € per minute at peak. Off peak 0.0088 € per minute.

Rely on the professionalism of the manufacturer. You can therefore be sure that the repair is carried out by trained service technicians who carry original spare parts for your appliances.

Test dishes

This table has been produced for test institutes to facilitate the testing of our appliances.

The data in the table refers to our Schulte-Ufer cookware accessories (4 piece cookware set for the HEZ 390042 induction hob) with the following measurements:

- Saucepan Ø 16 cm, 1.2 l for hotplates of Ø 14.5 cm
- Pot Ø 16 cm, 1.7 l for hotplates of Ø 14.5 cm
- Pot Ø 22 cm, 4.2 l for hotplates of Ø 18 cm
- Frying pan Ø 24 cm, for hotplates of Ø 18 cm

| Test dishes | Cookware | Heat setting | Preheating | | Cooking | | |
|--|-----------------------------|--------------|---|-----|--------------|-----|--|
| | | | Cooking time (min:sec) | Lid | Heat setting | Lid | |
| Melting chocolate | | | | | | | |
| Chocolate coating (e.g. Dr. Oetker brand, dark chocolate 55% cocoa, 150 g) | Saucepan, 16 cm diameter | - | - | - | 1.5 | No | |
| Heating and keeping lentil stew warm | | | | | | | |
| Lentil stew* | | | | | | | |
| Initial temperature 20 °C | | | | | | | |
| Amount: 450 g | Cooking pot, 16 cm diameter | 9 | 1:30 (without stirring) | Yes | 1.5 | Yes | |
| Amount: 800 g | Saucepan, 22 cm diameter | 9 | 2:30 (without stirring) | Yes | 1.5 | Yes | |
| Lentil stew from a tin | | | | | | | |
| E.g lentils with Erasco sausages. | | | | | | | |
| Initial temperature 20 °C | | | | | | | |
| Amount: 500 g | Cooking pot, 16 cm diameter | 9 | Approx. 1:30 (stir after approx. 1 minute) | Yes | 1.5 | Yes | |
| Amount: 1 kg | Saucepan, 22 cm diameter | 9 | Approx. 2:30 (stir after approx. 1 minute) | Yes | 1.5 | Yes | |
| Preparing Béchamel sauce | | | | | | | |
| Temperature of the milk: 7 °C | | | | | | | |
| Ingredients: 40 g butter, 40 g flour, 0.5 l milk (3.5% fat content) and a pinch of salt | | | | | | | |
| 1. Melt the butter, stir in the flour and salt, and heat up the mixture. | Saucepan, 16 cm diameter | 2 | Approx. 6:00 | No | - | - | |
| 2 Add the milk to the roux and bring to the boil, stirring continuously. | | 7 | Approx. 6:30 | No | - | - | |
| 3. Once the Béchamel sauce comes to the boil, leave it on the hotplate for a further two minutes, stirring continuously. | | - | - | - | 2 | No | |

*Recipe in accordance with DIN 44550

**Recipe in accordance with DIN EN 60350-2

| Test dishes | Cookware | Heat setting | Preheating | | Cooking | |
|---|-----------------------------|--------------|--|-----|------------------------------|-----|
| | | | Cooking time (min:sec) | Lid | Heat setting | Lid |
| Cooking rice pudding | | | | | | |
| Rice pudding, cooked with the lid on Temperature of the milk: 7 °C Heat the milk until it starts to rise up. Set the recommended heat setting and add rice, sugar and salt to the milk. The cooking time, including preheating, is approx. 45 minutes. | | | | | | |
| Ingredients: 190 g short-grain rice, 90 g sugar, 750 ml milk (3.5% fat content) and 1 g salt | Cooking pot, 16 cm diameter | 8.5 | Approx. 5:30 | No | 3 (stir after 10 minutes) | Yes |
| Ingredients: 250 g short-grain rice, 120 g sugar, 1 l milk (3.5% fat content) and 1.5 g salt | Saucepan, 22 cm diameter | 8.5 | Approx. 5:30 | No | 3 (stir after 10 minutes) | Yes |
| Rice pudding, cooked without lid Temperature of the milk: 7 °C Add the ingredients to the milk and heat the mixture up while stirring continuously. Once the milk has reached approx. 90 °C, select the recommended heat setting and leave it to simmer on a low heat for approx. 50 minutes. | | | | | | |
| Ingredients: 190 g short-grain rice, 90 g sugar, 750 ml milk (3.5% fat content) and 1 g salt | Cooking pot, 16 cm diameter | 8.5 | Approx. 5:30 | No | 3 | No |
| Ingredients: 250 g short-grain rice, 120 g sugar, 1 l milk (3.5% fat content) and 1.5 g salt | Saucepan, 22 cm diameter | 8.5 | Approx. 5:30 | No | 2.5 | No |
| Cooking rice* | | | | | | |
| Water temperature: 20 °C | | | | | | |
| Ingredients: 125 g long grain rice, 300 g water and a pinch of salt | Cooking pot, 16 cm diameter | 9 | Approx. 2:30 | Yes | 2 | Yes |
| Ingredients: 250 g long grain rice, 600 g water and a pinch of salt | Saucepan, 22 cm diameter | 9 | Approx. 2:30 | Yes | 2.5 | Yes |
| Roasting a pork loin | | | | | | |
| Initial temperature of the loin: 7 °C | | | | | | |
| Amount: 3 pork loins (total weight approx. 300 g, 1 cm thick) and 15 ml sunflower oil | Frying pan, 24 cm diameter | 9 | Approx. 1:30 | No | 7 | No |
| Preparing pancakes** | | | | | | |
| Amount: 55 ml batter for each pancake | Frying pan, 24 cm diameter | 9 | Approx. 1:30 | No | 7 | No |
| Deep-fat frying chips | | | | | | |
| Amount: 2 l sunflower oil, per portion: 200 g frozen chips (e.g. McCain 123 Original fries) | Saucepan, 22 cm diameter | 9 | Until the oil temperature reaches 180 °C | No | 9 | No |

*Recipe in accordance with DIN 44550

**Recipe in accordance with DIN EN 60350-2



Thank you for buying a Bosch Home Appliance!

Register your new device on MyBosch now and profit directly from:

- **Expert tips & tricks for your appliance**
- **Warranty extension options**
- **Discounts for accessories & spare-parts**
- **Digital manual and all appliance data at hand**
- **Easy access to Bosch Home Appliances Service**

Free and easy registration – also on mobile phones:

www.bosch-home.com/welcome



Looking for help? You 'll find it here.

Expert advice for your Bosch home appliances, need help with problems or a repair from Bosch experts.

Find out everything about the many ways Bosch can support you:

www.bosch-home.com/service

Contact data of all countries are listed in the attached service directory.

Robert Bosch Hausgeräte GmbH

Carl-Wery-Straße 34

81739 München

Germany

www.bosch-home.com



9001528969

000420(00)