



BOSCH

QUICK START & SAFETY GUIDE

DISHWASHER
SHX3AR****

TABLE OF CONTENTS

SAFETY INSTRUCTIONS.....	2
GETTING STARTED	4
CYCLES AND OPTIONS.....	6
EVERYDAY TIPS	8
STATEMENT OF LIMITED WARRANTY	10





IMPORTANT SAFETY INSTRUCTIONS

PLEASE READ AND SAVE THESE INSTRUCTIONS

This Quick Start and Safety Guide explains the basics of operating your dishwasher and those safety measures that must be followed.

For complete product information refer to the Use and Care Manual available online at www.bosch-home.com/us/service/get-support/owner-manuals.

Safety Definitions:

⚠ WARNING: This indicates that death or serious injuries may occur as a result of non-observance of this warning.

⚠ CAUTION: This indicates that minor or moderate injuries may occur as a result of non-observance of this warning.

NOTICE: This indicates that damage to the appliance or property may occur as a result of non-compliance with this advisory.

WARNING: TIP OVER HAZARD!

Dishwasher must be installed immediately and secured with mounting brackets to avoid tip over. A child can tip the dishwasher and be seriously injured if the door is opened before it is installed. (see *Installation Guide for instructions*)



WARNING: SAFE OPERATION

- Use this dishwasher only for its intended function, which is the washing of household dishware and kitchenware rated as dishwasher safe.
- **DISHWASHER MUST BE ELECTRONICALLY GROUNDED.** See Installation Guide for instructions.
- The sharp points and edges of knives and other sharp utensils can cause serious injury. Load knives and other sharp utensils with edges down.
- To avoid risk of injury, always use caution when opening the door during or following a wash cycle as hot water or steam may escape. Do not fully open the door until water noises have stopped and steam has subsided.
- Misuse of the dishwasher can result in serious injury or death. Do not use the dishwasher in any way not covered in the Use and Care Manual or for any purpose other than those explained in the following pages.
- Never use harsh chemicals to clean your dishwasher. Some bleach-based products can damage your dishwasher and may present health hazards!
- Use caution when removing parts for cleaning as some debris may be sharp.
- Do not abuse, sit or stand on the door or dish racks of the dishwasher.
- **RISK OF EXPLOSION** - Under certain conditions, hydrogen gas may be produced in a hot water system that has not been used for two weeks or more. Hydrogen gas is explosive. Before using a dishwasher that is connected to a hot water system that has been unused for two weeks or longer, turn on all hot water faucets and let the water flow from each for several minutes. This will release any accumulated hydrogen gas. As the gas is explosive, do not smoke or use an open flame during this time.
- **RISK OF EXPLOSION** - When cleaning your dishwasher with any cleaning agent, remove all cookware, utensils or any foreign material from inside. Some cleaning agents are highly acidic and/or caustic alkaline, which can cause Hydrogen gas to form if aluminum material is also inside the dishwasher tub. Hydrogen gas is explosive. **Refer to the Care and Maintenance section of the dishwasher Use and Care manual for instructions on how to properly clean your dishwasher.**



IMPORTANT SAFETY INSTRUCTIONS

PLEASE READ AND SAVE THESE INSTRUCTIONS

- To avoid floor damage and possible mold growth, do not allow wet areas to remain around or under the dishwasher.

WARNING: CHILD SAFETY

- Keep detergents or rinsing agents out of the reach of children.
- To reduce risk of injury, do not allow children to play in or on the dishwasher.
- Do not allow children to handle or play near knives and sharp utensils.
- When children become old enough to operate the appliance, it is the responsibility of the parents/legal guardians to ensure the children are instructed in safe practices by qualified persons.

CAUTION

- When loading items to be washed:
 - Locate sharp items so they are not likely to damage the door seal.
 - Do not wash plastic items unless they are marked "dishwasher safe" or the equivalent. Otherwise, check the manufacturer's recommendations.
 - Do not operate your dishwasher unless all enclosure panels are in place.
- Do not tamper with or override controls and interlocks.
- Dishes can be very hot immediately after cycle ends. Open the door slightly and allow dishes to cool for a few minutes before unloading.
- This dishwasher is intended for use up to a maximum altitude of 13,000 ft (4,000 meters) above sea level.
- Use only detergents or rinsing agents recommended for use in a dishwasher.

WARNING

- End of Life Disposal - Remove the dishwasher door to the washing compartment when removing an old dishwasher from service or discarding.

NOTICE

- It is highly recommended for the end user to become familiar with the procedure to shut off the incoming water supply and the procedure to shut off the incoming power supply. See the Installation Instructions or contact your installer for more information.

CAUSES OF DAMAGE

- Detergent will destroy the water softening system! Never pour detergent into the salt dispenser.
- To avoid oversudsing or clogging, do not overfill the rinse aid dispenser. Wipe up any spills with a damp cloth.
- Do not allow water to remain in your dishwasher systems through extended periods of freezing temperatures. Freezing temperatures can damage the water fill valve and potentially other components of your dishwasher.
- Never use steam cleaning products to clean your dishwasher. The manufacturer will not be responsible for the possible damages or consequences.
- Do not use harsh chemicals, bleach-based wipes, abrasive cleaners, scouring pads (metal or plastic), or abrasive cloths/paper towels to clean your dishwasher's exterior door panel. These could damage your dishwasher's exterior door panel.
- Do not load the dishwasher with paper products, plastic bags, packing materials or anything other than normal, dishwasher safe dishware and kitchenware.





GETTING STARTED

LOADING TIPS FOR OPTIMAL CLEANING

Lower Rack

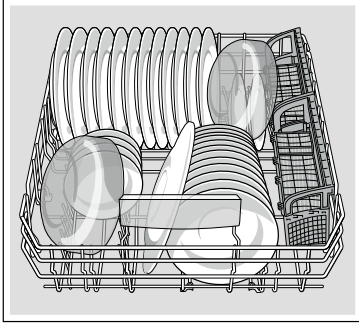

Load plates and bowls in lower rack leaning inward.

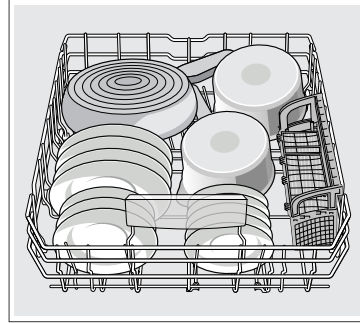

Load pots and pans and other large items upside down.

Upper rack

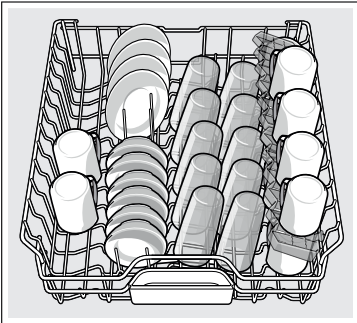

For small plates, glasses and cups. Small cups fit on cup shelf.

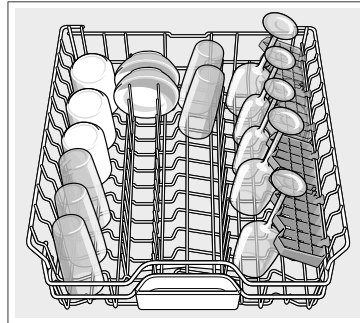

The cup shelf also serves as stemware support.

Cutlery basket

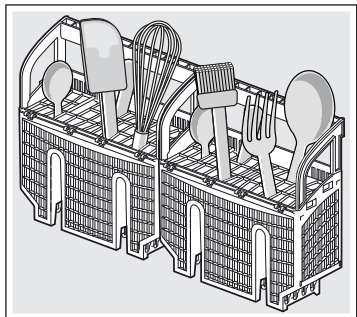

Note: Do not overcrowd dishes, or block water; reduces wash performance.





⚠ WARNING

- Load sharp items (knives, skewers, etc.) pointing down. Failure to do so may result in injury.
- To avoid risk of injury, always use caution when opening the door during or following a wash cycle as hot water or steam may escape. Do not fully open the door until water noises have stopped and steam has subsided.

ADD DETERGENT

Use detergent tabs, fresh powdered detergent or liquid detergent. For the Glass cycle, use 1-1.75 Tbsp. of detergent or use detergent tabs with glassware protection.

Tip: dispenser lid should slide closed easily.

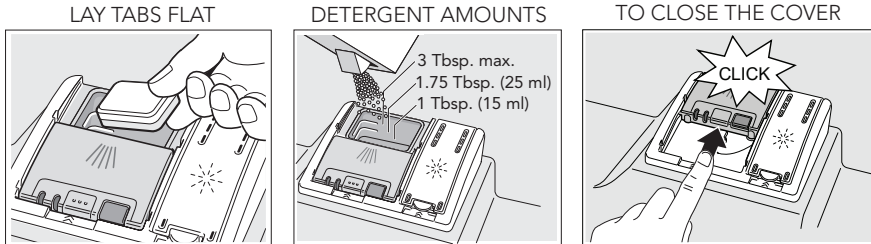

USAGE TIPS FOR BEST RESULTS

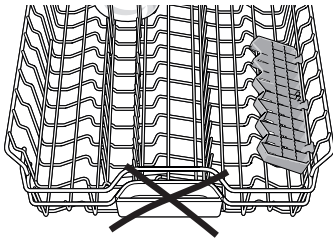

Do not place objects in detergent tray or block it with dishes



Scrape off food, but do not rinse.



Use rinse aid for better drying.

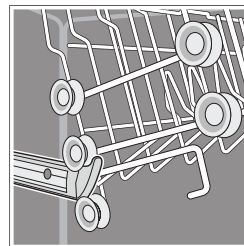

Adjust upper rack height as needed for large items.



CYCLES AND OPTIONS

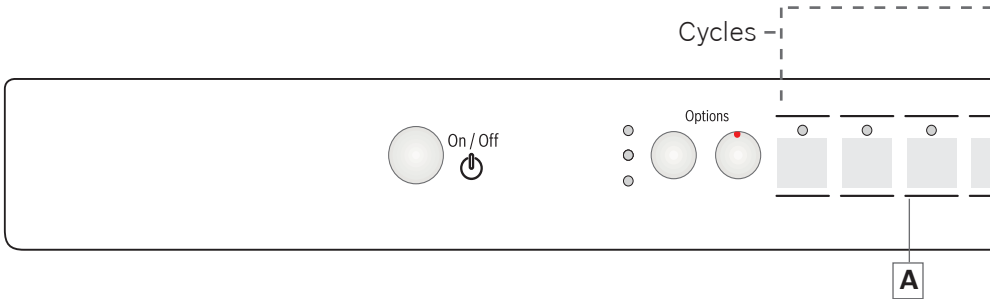

Cycles	level of dirt	what it does	examples of dishes
Heavy	baked-on/ greasy dishes	longer cycle and higher temperature	baked-on lasagna casserole
Auto	not baked-on	adjusts time and intensity automatically by soil sensing	everyday load
Normal	not baked- on	cycle to save energy and water	everyday load
Express	fresh, not dried on	cleans lightly soiled dishes and reduces overall wash time	everyday load
Delicate	lightly soiled	lowers temperature and shortens cycle length to protect deli- cate dishes.	delicate dishes and glasses
Half Load	not baked-on	Cleans small load with less energy, time and water. Use less detergent.	small load of glasses, plates, cups

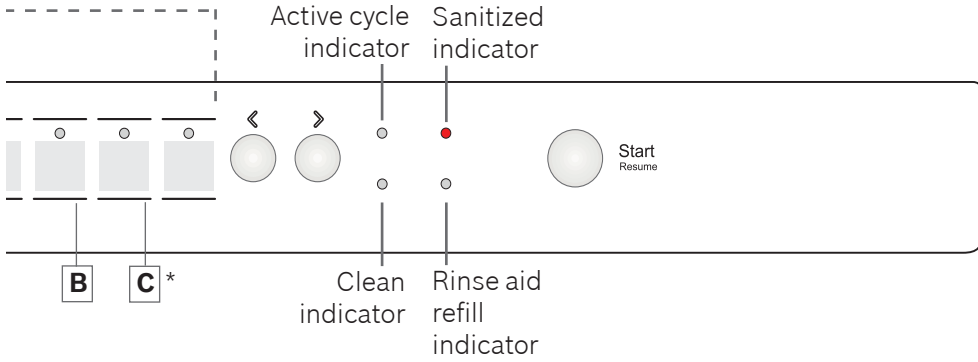

Options	level of dirt	what it does	examples of dishes
Delay	any	allows you to delay the start of the cycle for 3, 6, or 9 hours.	any
Sanitize	any	increases cycle length and temperature for disinfection	cutting boards, bottles

START YOUR DISHWASHER

1. Press the On/Off button.
2. Select a cycle and option if desired.
3. Press Start.

* Use display lights for **A**, **B**, and **C** to change the settings. See next page for directions.





ADD RINSE AID

This dishwasher is designed to be used with rinse aid, which enhances drying results and shine.

- Add rinse aid before first use and when the Add Rinse Aid indicator light on the control panel illuminates.
- Lift tab to open the rinse aid reservoir and add liquid rinse aid into the oval until it is full, avoiding air vent. Wipe up any excess rinse aid that may puddle.

Tip: Remove lid of rinse aid bottle for easier pouring.

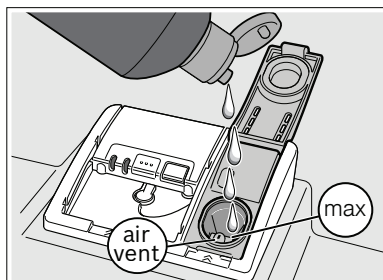

The amount of rinse aid dispensed can be set in 4 levels. Only change the setting if

streaks remain on the dishes (lower the amount), or if dishes are not getting dry enough (increase the amount).

Setting	Factory setting	Description
Rinse Aid Off/Low/Medium/ High	Medium	Dispenses the amount of rinse aid, which affects drying (see above).
Beep at cycle end Off/Low/Medium/ High	Medium	Adjust the volume for the beep at the end of the cycle.
Intensive drying Off/On	Off	Improved drying for glasses and plastic, by increasing the temperature and length.

ADJUSTING THE SETTINGS

First Steps to adjust any setting:

1. Open the door and press the ON/OFF button.
2. Hold down button > and press START button until the clean indicator and the sanitized indicator lights flash.
3. Release buttons, then follow steps below to adjust specific setting.

A. To adjust the rinse aid and beep settings:

1. Keep pressing the button > until the rinse aid refill indicator light flashes for the rinse aid setting. Or to change the beep setting, press until rinse aid refill, clean and sanitized indicators flash. Displays **A** and **B** are lit (= Setting medium, factory setting.)
2. Press the button < until the desired setting is selected. Display **A** = Setting low, Displays **A**, **B** and **C** = Setting High and no displays lit is off.
3. Press START button to save the setting.

B. To turn intensive drying on:

1. Keep pressing button > until the Clean and Sanitized lights flash.
2. Press button < until the display **A** is lit.
3. Press Start button to save the setting.





MAINTENANCE TIPS

Clean surfaces with damp cloth and mild soap.

NOTICE: Do not use abrasives or bleach based cleaners. Do not use stainless steel cleaner on black stainless or anti-finger print surfaces.

Clean the filter 3-12 times a year, depending on usage.

1. Unscrew the Large Object Trap as illustrated and remove the entire filter system.
2. Remove the micro-filter from the fine filter, rinse the filters under running water clean with a soft brush.
3. Reinstall the filter system in reverse sequence, align arrows.

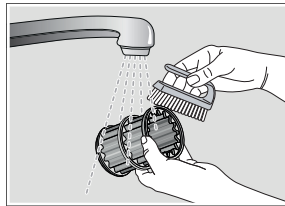
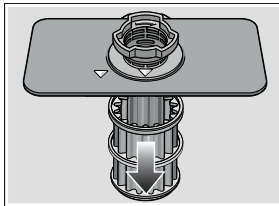
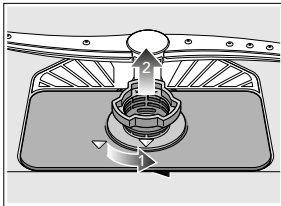

FREQUENTLY ASKED QUESTIONS

Q: Why is food left on dishes?

A: It is possible the dishes do not have adequate clearance between them. Also, be sure nothing is blocking spray arm and that the filter is clean. Select an intensive cleaning cycle.

Q: Why does the cycle run a long time?

A: 1. Sensors in the dishwasher automatically increase the cycle time to ensure a good wash when heavy soil is detected.
2. Incoming water may not be hot enough and dishwasher has to heat it.

Q: Why is E:XX (X can be any number) displayed?

A: This is an error code. For example, E:22 indicates there is water in the sump because the filter is blocked or needs cleaning. See the Use and Care Manual for a list of error codes.

To access the full Use and Care Manual, go to:
www.bosch-home.com/us/service/get-support/owner-manuals.





STATEMENT OF LIMITED PRODUCT WARRANTY

What this Warranty Covers & Who it Applies to:

The limited warranty provided by BSH Home Appliances Corporation (BSH) in this Statement of Limited Product Warranty applies only to the Bosch® dishwasher ("Product") sold to you, the first using purchaser, provided that the Product was purchased:

- For your normal, household (non-commercial) use, and has in fact at all times only been used for normal household purposes;
- New at retail (not a display, "as is", or previously returned model), and not for resale, or commercial use.
- Within the United States or Canada, and has at all times remained within the country of original purchase.

The warranties stated herein apply to the original purchaser of the product warranted herein and to each succeeding owner of the product purchased for ordinary home use during the term of the warranty.

Please make sure to return your registration card; while not necessary to effectuate warranty coverage, it is the best way for BSH to notify you in the unlikely event of a safety notice or product recall.

How Long the Warranty Lasts

BSH warrants that the Product is free from defects in materials and workmanship for a period of three hundred sixty five (365) days from the date of purchase. The foregoing timeline begins to run upon the date of purchase, and shall not be stalled, tolled, extended, or suspended, for any reason whatsoever. This Product is also warranted to be free from *cosmetic* defects in material and workmanship (such as scratches of stainless steel, paint/porcelain blemishes, chip, dents, or other damage to the finish) of the Product, for a period of thirty (30) days from the date of purchase or closing date for new construction. This *cosmetic* warranty excludes slight color variations due to inherent differences in painted and porcelain parts, as well as differences caused by kitchen lighting, product location, or other similar factors. This *cosmetic* warranty specifically excludes any display, floor, "As Is", or "B" stock appliances.

Repair/Replace as Your Exclusive Remedy

During this warranty period, Bosch or one of its authorized service providers will repair your Product without charge to you (subject to certain limitations stated herein) if your Product proves to have been manufactured with a defect in materials or workmanship. If reasonable attempts to repair the Product have been made without success, then Bosch will replace your Product (upgraded models may be available to you, in Bosch's sole discretion, for an additional charge). All removed parts and components shall become the property of Bosch at its sole option. All replaced and/or repaired parts shall assume the identity of the original part for purposes of this warranty and this warranty shall not be extended with respect to such parts. Bosch's sole liability and responsibility hereunder is to repair manufacturer-defective Product only, using a Bosch authorized service provider during normal business hours. For safety and property damage concerns, Bosch highly recommends that you do not attempt to repair the Product yourself, or use an un-authorized servicer; Bosch will have no responsibility or liability for repairs or work performed by a non-authorized servicer. If you choose to have someone other than an authorized service provider work on your Product, THIS WARRANTY WILL AUTOMATICALLY BECOME NULL AND VOID. Authorized service providers are those persons or companies that have been specially trained on Bosch products, and who possess, in Bosch's opinion, a superior reputation for customer service and technical ability (note that they are independent entities and are not agents, partners, affiliates or representatives of Bosch). Notwithstanding the foregoing, Bosch will not incur any liability, or have responsibility, for the Product if it is located in a remote area (more than 100 miles from an authorized service provider) or is reasonably inaccessible, hazardous, threatening, or treacherous locale, surroundings, or environment; in any such event, if you request, Bosch would still pay for labor and parts and ship the parts to the nearest authorized service provider, but you would still be fully liable and responsible for any travel time or other special charges by the service company, assuming they agree to make the service call.





Out of Warranty Product

BSH is under no obligation, at law or otherwise, to provide you with any concessions, including repairs, pro-rates, or Product replacement, once this warranty has expired.

Warranty Exclusions

The warranty coverage described herein excludes all defects or damage that is not the direct fault of Bosch, including without limitation, one or more of the following:

- Use of the Product in anything other than its normal, customary and intended manner (including without limitation, any form of commercial use, use or storage of an indoor product outdoors, use of the Product in conjunction with air or water-going vessels).
- Any party's willful misconduct, negligence, misuse, abuse, accidents, neglect, improper operation, failure to maintain, improper or negligent installation, tampering, failure to follow operating instructions, mishandling, unauthorized service (including self performed "fixing" or exploration of the appliance's internal workings).
- Adjustment, alteration or modification of any kind.
- A failure to comply with any applicable state, local, city, or county electrical, plumbing and/or building codes, regulations, or laws, including failure to install the product in strict conformity with local fire and building codes and regulations.
- Ordinary wear and tear, spills of food, liquid, grease accumulations, or other substances that accumulate on, in, or around the Product.
- Any external, elemental and/or environmental forces and factors, including without limitation, rain, wind, sand, floods, fires, mud slides, freezing temperatures, excessive moisture or extended exposure to humidity, lightning, power surges, structural failures surrounding the appliance, and acts of God.
- Service calls to correct the installation of your refrigerator, to instruct you how to use your refrigerator, to replace house fuses or correct house wiring or plumbing
- Removal and replacement of trim or decorative panels that interfere with servicing the product.
- Labor or parts installed by any non-designated service company during the full warranty period, unless approved by Bosch before service is performed.

In no event shall BSH have any liability or responsibility whatsoever for damage to surrounding property, including cabinetry, floors, ceilings, and other structures or objects around the Product. Also excluded from this warranty are Products on which the serial numbers have been altered, defaced, or removed; service visits to teach you how to use the Product, or visits where there is nothing wrong with the Product; correction of installation problems (you are solely responsible for any structure and setting for the Product, including all electrical, plumbing or other connecting facilities, for proper foundation/flooring, and for any alterations including without limitation cabinetry, walls, floors, shelving, etc.); and resetting of breakers or fuses.

TO THE EXTENT ALLOWED BY LAW, THIS WARRANTY SETS OUT YOUR EXCLUSIVE REMEDIES WITH RESPECT TO PRODUCT, WHETHER THE CLAIM ARISES IN CONTRACT OR TORT (INCLUDING STRICT LIABILITY, OR NEGLIGENCE) OR OTHERWISE. THIS WARRANTY IS IN LIEU OF ALL OTHER WARRANTIES, WHETHER EXPRESS OR IMPLIED.

ANY WARRANTY IMPLIED BY LAW, WHETHER FOR MERCHANTABILITY OR FITNESS FOR A PARTICULAR PURPOSE, OR OTHERWISE, SHALL BE EFFECTIVE ONLY FOR THE PERIOD THAT THIS EXPRESS LIMITED WARRANTY IS EFFECTIVE. IN NO EVENT WILL THE MANUFACTURER BE LIABLE FOR CONSEQUENTIAL, SPECIAL, INCIDENTAL, INDIRECT, "BUSINESS LOSS", AND/OR PUNITIVE DAMAGES, LOSSES, OR EXPENSES, INCLUDING WITHOUT LIMITATION TIME AWAY FROM WORK, HOTELS AND/OR RESTAURANT MEALS, REMODELLING EXPENSES IN EXCESS OF DIRECT DAMAGES WHICH ARE DEFINITELY CAUSED EXCLUSIVELY BY BSH, OR OTHERWISE. SOME STATES DO NOT ALLOW THE EXCLUSION OR LIMITATION OF INCIDENTAL OR CONSEQUENTIAL DAMAGES, AND SOME STATES DO NOT ALLOW LIMITATIONS ON HOW LONG AN IMPLIED WARRANTY LASTS, SO THE ABOVE LIMITATIONS MAY NOT APPLY TO YOU. THIS WARRANTY GIVES YOU SPECIFIC LEGAL RIGHTS, AND YOU MAY ALSO HAVE OTHER RIGHTS WHICH VARY FROM STATE TO STATE.

No attempt to alter, modify or amend this warranty shall be effective unless authorized in writing by an officer of BSH.





How to Obtain Warranty Service

To obtain warranty service for your product, you should contact Bosch Customer Service at 1-800-944-2904.

Proposition 65 Warning:

This product may contain a chemical known to the State of California, which can cause cancer or reproductive harm. Therefore, the packaging of your product may bear the following label as required by California:

STATE OF CALIFORNIA PROPOSITION 65 WARNING:



WARNING

Cancer and Reproductive Harm - www.P65Warnings.ca.gov

1901 MAIN STREET, SUITE 600 IRVINE, CA 92614 // WWW.BOSCH-HOME.COM

@ 2017 BSH HOME APPLIANCES CORPORATION

9001490756 9909 640B EV

