



BUILT-IN OVEN

[en] INSTRUCTION MANUAL

B5ACH7AH0B

Table of contents

| | | | |
|---|-----------|---|-----------|
|  Intended use | 4 |  Sabbath mode | 15 |
| | | Starting Sabbath mode. | 15 |
|  Important safety information | 5 |  Home Connect | 16 |
| General information | 5 | Setting up | 16 |
| Halogen lamp. | 5 | Remote Start. | 16 |
| Cleaning function | 6 | Home Connect settings | 16 |
|  Causes of damage | 6 | Remote diagnostics | 17 |
| General information | 6 | About data protection. | 17 |
|  Environmental protection | 7 | Declaration of Conformity. | 17 |
| Saving energy | 7 |  Cleaning agent | 17 |
| Environmentally-friendly disposal | 7 | Suitable cleaning agents | 17 |
|  Getting to know your appliance | 8 | Keeping the appliance clean | 18 |
| Control panel | 8 |  Cleaning function | 19 |
| Buttons and display | 8 | Self-cleaning | 19 |
| Types of heating and functions | 9 | EasyClean | 20 |
| Temperature. | 9 |  Rails | 21 |
| Cooking compartment | 10 | Detaching and refitting the rails | 21 |
|  Accessories | 10 |  Appliance door | 21 |
| Control accessories | 10 | Removing and fitting the appliance door | 21 |
| Inserting accessories | 10 | Removing and installing the door panels | 23 |
| Optional accessories | 11 |  Trouble shooting | 24 |
|  Before using for the first time | 11 | Rectifying faults yourself. | 24 |
| Initial use | 11 | Maximum operating time | 25 |
| Cleaning the cooking compartment. | 11 | Replacing the bulb in the top of the cooking compartment | 25 |
| Cleaning the accessories. | 12 |  Customer service | 26 |
|  Operating the appliance | 12 | E number and FD number | 26 |
| Switching the appliance on and off | 12 |  Tested for you in our cooking studio | 26 |
| Setting the type of heating and temperature | 12 | General information | 26 |
| Temperature display. | 12 | Baking | 27 |
| Rapid heating. | 12 | Roasting, braising and grilling | 29 |
|  Time-setting options | 13 | Ready meals. | 33 |
| Setting the timer. | 13 | Desserts | 33 |
| Setting the cooking time | 13 | Acrylamide in foodstuffs. | 34 |
| Setting the end time. | 13 | Drying | 34 |
| Setting the time | 14 | Preserving | 35 |
| Checking, changing or deleting settings | 14 | Prove dough. | 36 |
|  Childproof lock | 14 | Keeping warm | 36 |
| Automatic childproof lock | 14 | Test dishes | 36 |
| One-time childproof lock | 14 | | |
|  Basic settings | 14 | | |
| List of basic settings | 14 | | |
| Changing the basic settings. | 15 | | |

Additional information on products, accessories, replacement parts and services can be found at www.neff-international.com and in the online shop www.neff-eshop.com

Intended use

Read these instructions carefully. Only then will you be able to operate your appliance safely and correctly. Retain the instruction manual and installation instructions for future use or for subsequent owners.

This appliance is only intended to be fully fitted in a kitchen. Observe the special installation instructions.

Check the appliance for damage after unpacking it. Do not connect the appliance if it has been damaged in transport.

Only a licensed professional may connect appliances without plugs. Damage caused by incorrect connection is not covered under warranty.

This appliance is intended for domestic use only. The appliance must only be used for the preparation of food and drink. The appliance must be supervised during operation. Only use this appliance indoors.

This appliance is intended for use up to a maximum height of 4000 metres above sea level.

This appliance may be used by children over the age of 8 years old and by persons with reduced physical, sensory or mental capabilities or by persons with a lack of experience or knowledge if they are supervised or are instructed by a person responsible for their safety how to use the appliance safely and have understood the associated hazards.

Children must not play with, on, or around the appliance. Children must not clean the appliance or carry out general maintenance unless they are at least 15 years old and are being supervised.

Keep children below the age of 8 years old at a safe distance from the appliance and power cable.

Always slide accessories into the cooking compartment the right way round.

→ "Accessories" on page 10

Important safety information

General information

Warning – Risk of fire!

- Combustible items stored in the cooking compartment may catch fire. Never store combustible items in the cooking compartment. Never open the appliance door if there is smoke inside. Switch off the appliance and unplug it from the mains or switch off the circuit breaker in the fuse box.
- Loose food remnants, fat and meat juices may catch fire. Before using the appliance, remove the worst of the food remnants from the cooking compartment, heating elements and accessories.
- A draught is created when the appliance door is opened. Greaseproof paper may come into contact with the heating element and catch fire. Do not place greaseproof paper loosely over accessories during preheating. Always weight down the greaseproof paper with a dish or a baking tin. Only cover the surface required with greaseproof paper. Greaseproof paper must not protrude over the accessories.

Warning – Risk of burns!

- The appliance becomes very hot. Never touch the interior surfaces of the cooking compartment or the heating elements. Always allow the appliance to cool down. Keep children at a safe distance.
- Accessories and ovenware become very hot. Always use oven gloves to remove accessories or ovenware from the cooking compartment.
- Alcoholic vapours may catch fire in the hot cooking compartment. Never prepare food containing large quantities of drinks with a high alcohol content. Only use small quantities of drinks with a high alcohol content. Open the appliance door with care.

Warning – Risk of scalding!

- The accessible parts become hot during operation. Never touch the hot parts. Keep children at a safe distance.
- When you open the appliance door, hot steam can escape. Steam may not be visible, depending on its temperature. When opening, do not stand too close to the appliance. Open the appliance door carefully. Keep children away.

- Water in a hot cooking compartment may create hot steam. Never pour water into the cooking compartment when the cooking compartment is hot.

Warning – Risk of injury!

- Scratched glass in the appliance door may develop into a crack. Do not use a glass scraper, sharp or abrasive cleaning aids or detergents.
- The hinges on the appliance door move when opening and closing the door, and you may be trapped. Keep your hands away from the hinges.
- Components inside the appliance door may have sharp edges. Wear protective gloves.

Warning – Risk of electric shock!

- Incorrect repairs are dangerous. Repairs may only be carried out and damaged power cables replaced by one of our trained after-sales technicians. If the appliance is defective, unplug the appliance from the mains or switch off the circuit breaker in the fuse box. Contact the after-sales service.
- The cable insulation on electrical appliances may melt when touching hot parts of the appliance. Never bring electrical appliance cables into contact with hot parts of the appliance.
- Do not use any high-pressure cleaners or steam cleaners, which can result in an electric shock.
- A defective appliance may cause electric shock. Never switch on a defective appliance. Unplug the appliance from the mains or switch off the circuit breaker in the fuse box. Contact the after-sales service.

Warning – Hazard due to magnetism!

Permanent magnets are used in the control panel or in the control elements. They may affect electronic implants, e.g. heart pacemakers or insulin pumps. Wearers of electronic implants must stay at least 10 cm away from the control panel.

Halogen lamp

Warning – Risk of burns!

The bulbs in the cooking compartment become very hot. There is still a risk of burning your skin for some time after they have been switched off. Do not touch the glass cover. Avoid contact with your skin when cleaning.

⚠ Warning – Risk of electric shock!

When replacing the cooking compartment bulb, the bulb socket contacts are live. Before replacing the bulb, unplug the appliance from the mains or switch off the circuit breaker in the fuse box.

Cleaning function

⚠ Warning – Risk of fire!

- Loose food remnants, fat and meat juices may catch fire when the cleaning function is in progress. Before you start the cleaning function, always remove the worst of the food residues and remnants from the cooking compartment. Do not use the cleaning function for cleaning accessories.
- The appliance will become very hot on the outside during the cleaning function. Never hang combustible objects, e.g. tea towels, on the door handle. Do not place anything against the front of the appliance. Keep children away from the appliance.
- If the door seal is damaged, a large amount of heat will be generated around the door. Do not scrub or remove the seal. Never operate the appliance if the seal is damaged or missing.

⚠ Warning – Risk of serious harm to health!

The appliance becomes very hot when the cleaning function is in progress. The non-stick coating on baking trays and tins is destroyed and noxious gases are released. Never clean non-stick baking trays or baking tins using the cleaning function. In general, you must not use the cleaning function for cleaning accessories.

⚠ Warning – Risk of harm to health!

The cleaning function heats up the cooking compartment to a very high temperature so that food remnants left over from roasting, grilling and baking will burn off. This process releases vapours, which can irritate the mucous membranes. While the cleaning function is running, keep the kitchen well ventilated. Do not remain in the room for long periods. Keep children and pets away. Follow the instructions even when using the Delayed start function with a delayed end time.

⚠ Warning – Risk of burns!

- The cooking compartment becomes extremely hot during the cleaning function. Never open the appliance door. Allow the appliance to cool down. Keep children away from the appliance.

- **⚠** The appliance becomes very hot on the outside during the cleaning function. Never touch the appliance door. Allow the appliance to cool down. Keep children at a safe distance.

➤ Causes of damage

General information

Caution!

- Accessories, foil, greaseproof paper or ovenware on the cooking compartment floor: do not place accessories on the cooking compartment floor. Do not cover the cooking compartment floor with any sort of foil or greaseproof paper. Do not place ovenware on the cooking compartment floor if a temperature of over 50 °C has been set. This will cause heat to accumulate. The baking and roasting times will no longer be correct and the enamel will be damaged.
- Aluminium foil: Aluminium foil in the cooking compartment must not come into contact with the door glass. This could cause permanent discolouration of the door glass.
- Water in a hot cooking compartment: do not pour water into the cooking compartment when it is hot. This will cause steam. The temperature change can cause damage to the enamel.
- Moisture in the cooking compartment: Over an extended period of time, moisture in the cooking compartment may lead to corrosion. Allow the cooking compartment to dry after use. Do not keep moist food in the closed cooking compartment for extended periods of time. Do not store food in the cooking compartment.
- Cooling with the appliance door open: Following operation at high temperatures, only allow the cooking compartment to cool down with the door closed. Do not trap anything in the appliance door. Even if the door is only left open a crack, the front of nearby furniture may become damaged over time. Only leave the cooking compartment to dry with the door open if a lot of moisture was produced whilst the oven was operating.
- Fruit juice: when baking particularly juicy fruit pies, do not pack the baking tray too generously. Fruit juice dripping from the baking tray leaves stains that cannot be removed. If possible, use the deeper universal pan.
- Extremely dirty seal: If the seal is very dirty, the appliance door will no longer close properly during operation. The fronts of adjacent units could be damaged. Always keep the seal clean. Never operate the appliance if the seal is damaged or missing.
- Appliance door as a seat, shelf or worktop: Do not sit on the appliance door, or place or hang anything on it. Do not place any cookware or accessories on the appliance door.

- Inserting accessories: depending on the appliance model, accessories can scratch the door panel when closing the appliance door. Always insert the accessories into the cooking compartment as far as they will go.
- Carrying the appliance: do not carry or hold the appliance by the door handle. The door handle cannot support the weight of the appliance and could break.

Environmental protection

Your new appliance is particularly energy-efficient. Here you can find tips on how to save even more energy when using the appliance, and how to dispose of your appliance properly.

Saving energy

- Only preheat the appliance if this is specified in the recipe or in the tables in the operating instructions.
- Leave frozen food to defrost before placing it in the cooking compartment.

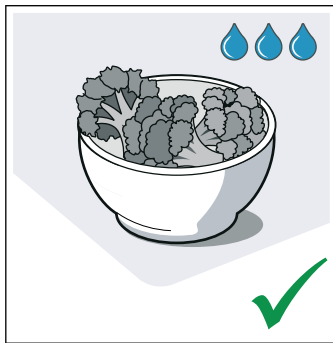
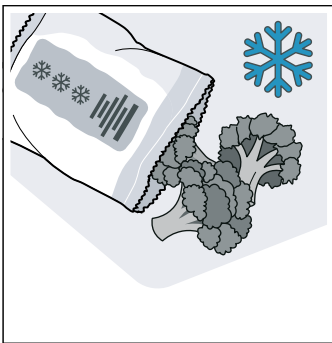

- Use baking tins that are dark-coloured, painted black or have an enamel coating. These absorb the heat particularly well.

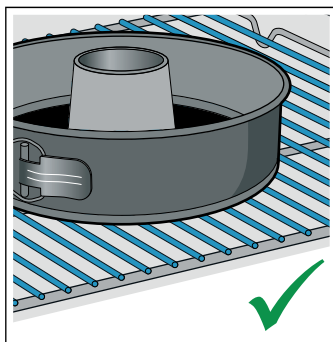
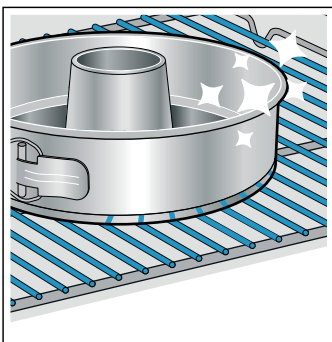

- Remove any unnecessary accessories from the cooking compartment.

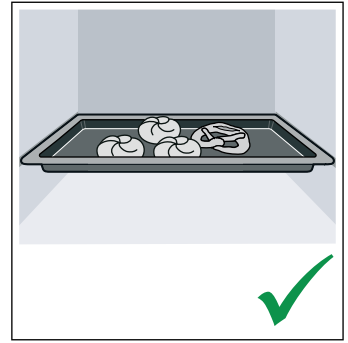
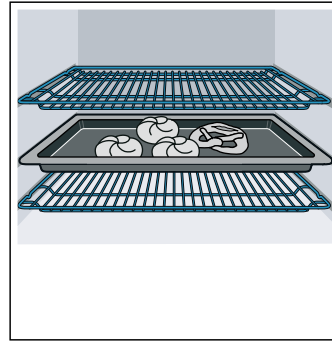

- Open the appliance door as infrequently as possible when the appliance is in use.

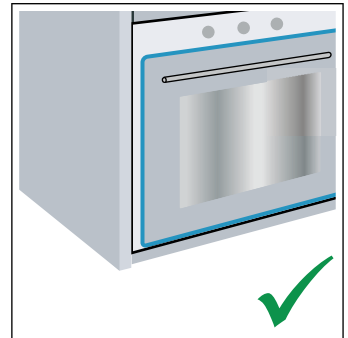
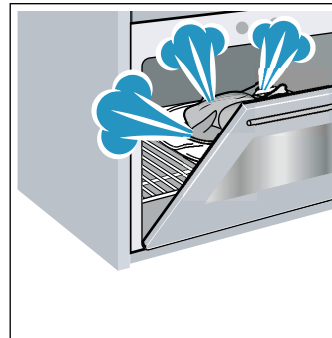

- It is best to bake several cakes one after the other. The cooking compartment stays warm. This reduces the baking time for the second cake. You can place two cake tins next to each other in the cooking compartment.

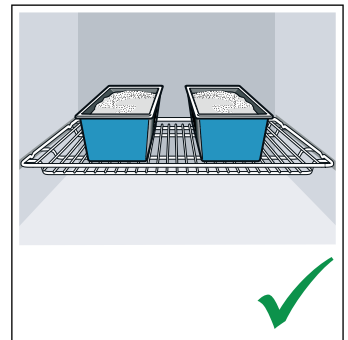
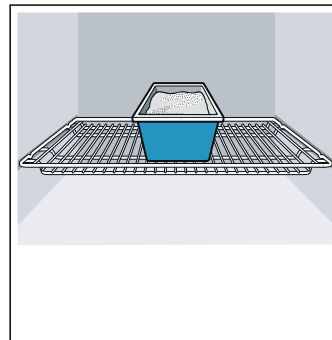

- For longer cooking times, you can switch the appliance off 10 minutes before the end of the cooking time and use the residual heat to finish cooking.

Environmentally-friendly disposal

Dispose of packaging in an environmentally-friendly manner.



This appliance is labelled in accordance with European Directive 2012/19/EU concerning used electrical and electronic appliances (waste electrical and electronic equipment - WEEE). The guideline determines the framework for the return and recycling of used appliances as applicable throughout the EU.

Getting to know your appliance

In this section, we will explain the indicators and controls. You will also find out about the various functions of your appliance.

Note: Depending on the appliance model, individual details and colours may differ.

Control panel

You can set your appliance's various functions on the control panel. Below, you will see an overview of the control panel and the layout of the controls.

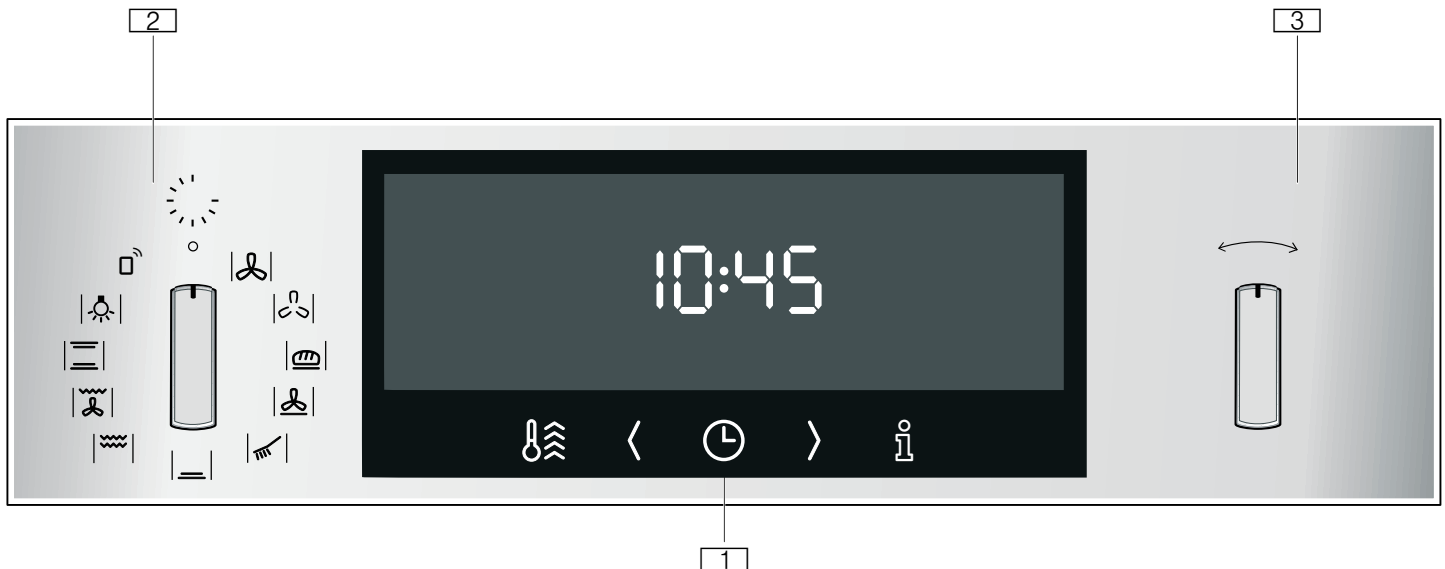

1 Buttons and display

The buttons are touch keys with sensors underneath. Simply touch a symbol to select the function.

The display shows symbols for active functions and the time-setting options.

2 Function selector

Use the function selector to set the heating function or other functions.

You can turn the function selector clockwise or anti-clockwise from the "Off" position.

3 Temperature selector

Use the temperature selector to set the temperature for the heating function or select the setting for other functions.

You can also turn the temperature selector clockwise or anti-clockwise. It does not have an "Off" position.

Buttons and display

You can use the buttons to set various additional functions on your appliance. You will be able to see the values for these on the display.

| Symbol | | Meaning |
|--------|----------------------|--|
| 🕒 | Time-setting options | Tap the symbol repeatedly to select the time ⌚, timer ⌚, duration → and end time → . |
| < | Minus | Reduce setting values. |
| > | Plus | Increase setting values. |
| ℹ️ | Information | Displays current temperature in the cooking compartment. |
| | Basic settings | Basic settings e.g. activate child safety lock. |
| 🔥 | Rapid heating | Starts or cancels rapid heating for the cooking compartment. |

Display









The cooking compartment temperature you set using the temperature selector will be shown on the display.

In addition, you can read the settings for the time-setting options. The value that can be set at the present time or that is elapsing will be shown in large digits on the display. To use the individual time-setting options, touch the 🕒 button several times. If there is a red bar above or below a symbol, this means that the value being shown in large digits on the display refers to the function that this symbol represents.

Types of heating and functions

Use the function selector to set the types of heating and other functions.





To make sure you always use the right type of heating to cook your food, we have explained the differences and applications below.

| Type of heating | Temperature | Use |
|---|-------------------------|--|
|  CircoTherm | 30 - 200 °C | For baking and cooking on one or more levels. The fan distributes the heat from the ring-shaped heating element in the back panel evenly around the cooking compartment. |
|  CircoTherm gentle | 125-200 °C | For gently cooking selected types of food on one level without preheating. The fan distributes the heat from the ring-shaped heating element in the back panel around the cooking compartment. This heating function is used to measure both the energy consumption in air recirculation mode and the energy efficiency class. |
|  Bread baking setting | 180–240 °C | For baking bread, bread rolls and baked goods that require high temperatures. |
|  Pizza setting | 30 - 275 °C | For cooking pizza and dishes that require a lot of heat from underneath. The bottom heating element and the ring-shaped heating element in the back panel heat the cooking compartment. |
|  Bottom heating | 30 - 250 °C | For cooking in a bain marie and for baking food for extra time. Heat is emitted from below. |
|  Grill, large area | 30 - 275 °C | For grilling flat items, such as steaks or sausages, for making toast, and for browning food. The whole area below the grill element becomes hot. |
|  Grill, intensive | from 275 °C: <i>int</i> | |
|  Circo-roasting | 30 - 250 °C | For roasting poultry, whole fish and larger pieces of meat. The grill element and the fan switch on and off alternately. The fan circulates the hot air around the food. |
|  Top/bottom heating | 30 - 275 °C | For traditional baking and roasting on one level. Especially suitable for cakes with moist toppings. Heat is emitted evenly from above and below. This type of heating is used to measure the energy consumption in the conventional mode. |

Note: For each heating function, the appliance specifies a default temperature or level. You can accept this value or change it in the appropriate area.

Other functions

Your new oven has yet more functions; see below for a brief description of these.

| Function | Use |
|---|---|
|  Interior lighting | Switches on the interior lighting; all other functions remain off. Makes it easier to clean the cooking compartment, for example. |
|  Remote start | Start and operate the appliance via the Home Connect app. → "Home Connect" on page 16 |
|  Cleaning functions | EasyClean  removes light soiling in the cooking compartment. → "Cleaning function" on page 19 |
| | Self-cleaning  cleans the cooking compartment virtually by itself. |

Temperature

Use the temperature selector to set the temperature in the cooking compartment. It can also be used to select the grill and cleaning settings, for example.

The settings appear in the display.

Notes

- The temperature can be set in 1-degree increments up to 100 °C, and in 5-degree increments thereafter.

- For temperature settings above 275 °C for the Grill type of heating, the appliance reduces the temperature to approx. 250 °C after approx. 20 minutes.

Cooking compartment

Various functions in the cooking compartment make your appliance easier to use. For example, the cooking compartment is well lit and a cooling fan prevents the appliance from overheating.

Opening the appliance door

If you open the appliance door when the appliance is in operation, the appliance will continue to operate as before.

Interior lighting

With most heating functions and other functions, the interior lighting in the cooking compartment will remain lit while the oven is in operation. When the function selector is turned to bring operation to an end, the lighting will go out.

By turning the function selector to the interior lighting setting, you can switch on the lighting without heating the oven. This makes it easier to clean your appliance, for example.

Cooling fan

The cooling fan switches on and off as required. The hot air escapes above the door.

Caution!

Do not cover the ventilation slots. Otherwise, the appliance may overheat.

So that the cooking compartment cools down more quickly after operation, the cooling fan continues to run for a certain period afterwards.

Accessories

Your appliance is accompanied by a range of accessories. Here, you can find an overview of the accessories included and information on how to use them correctly.

Control accessories

The accessories supplied may differ depending on the appliance model.

| | |
|--|---|
|  | <p>Wire rack For ovenware, cake tins and ovenproof dishes. For roasts, grilled items and frozen meals.</p> |
|  | <p>Universal pan For moist cakes, pastries, frozen meals and large roasts. It can be used to catch dripping fat when you are grilling directly on the wire rack.</p> |

Only use original accessories. They are specially adapted for your appliance.

You can buy accessories from the after-sales service, from specialist retailers or online.

Note: The accessories may deform when they become hot. This does not affect their function. Once they have cooled down again, they regain their original shape.

Inserting accessories

The cooking compartment has four shelf positions. The shelf positions are counted from the bottom up.

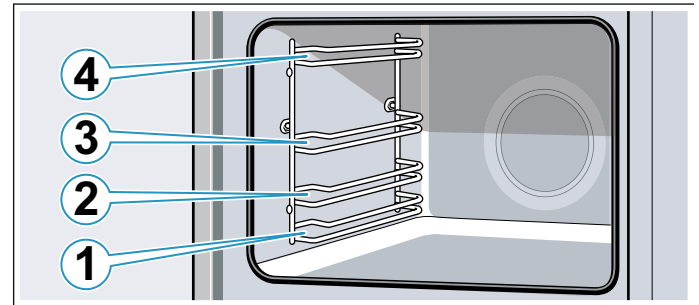

Always insert accessories between the two guide rods for the shelf position.

Accessories can be pulled out approximately halfway without tipping.

Notes

- Make sure that you always insert the accessories into the cooking compartment the right way round.
- Always insert the accessories fully into the cooking compartment so that they do not touch the appliance door.
- Take any accessories that you will not be using out of the cooking compartment.
- The shelves can be taken out of the cooking compartment for cleaning. → Page 21

Locking function

The accessories can be pulled out approximately halfway until they lock in place. The locking function prevents the accessories from tilting when they are pulled out. The accessories must be inserted into the cooking compartment correctly for the tilt protection to work properly.

When inserting the wire rack, ensure that lug **a** is at the rear and is facing downwards. The open side must be facing the appliance door and the outer rail must be facing downwards.

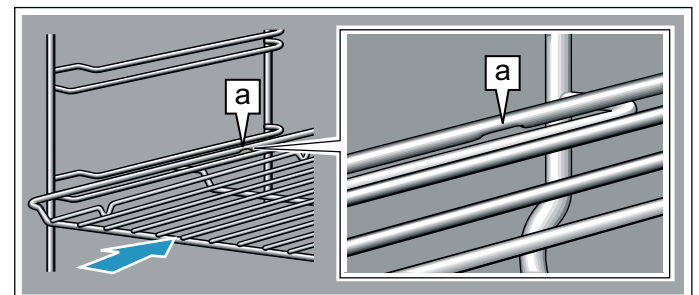

When inserting baking trays, make sure that the recess **a** is at the rear and is facing downwards. The sloping edge of the accessory **b** must be facing towards the appliance door.

Example in the picture: Universal pan

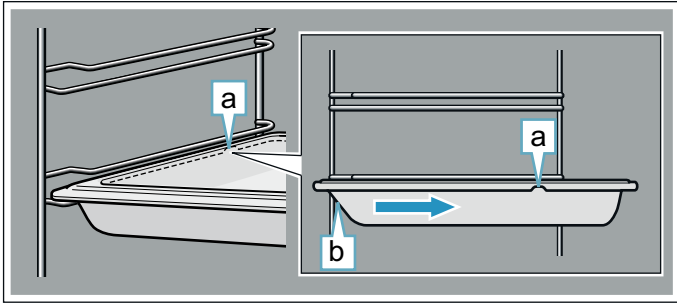

Combining accessories

You can insert the wire rack and the universal pan at the same time to catch drops of liquid.

When inserting the wire rack, ensure that both spacers **a** are at the rear edge. When inserting the universal pan, the wire rack is on top of the upper guide rod of the shelf position.

Example in the picture: Universal pan

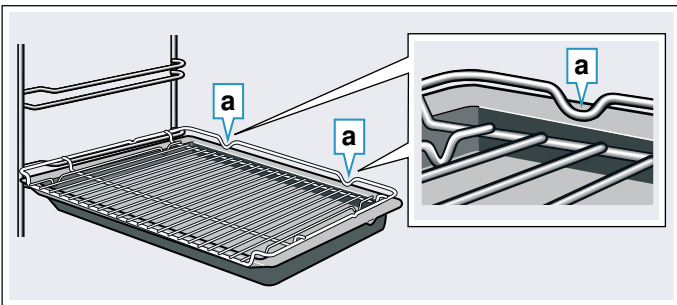

Optional accessories

You can purchase optional accessories from the after-sales service and specialist retailers, or on the Internet. You will find a comprehensive range of products for your appliance in our brochures and on the Internet.

Both availability and whether it is possible to order online differ between countries. Please see your sales documents for more details.

Note: Not all optional accessories are suitable for every appliance. When purchasing, please always quote the exact designation (E no.) of your appliance.

→ "Customer service" on page 26

Accessories

| |
|---------------------------|
| Baking and roasting shelf |
| Baking tray |
| Universal pan |
| Baking tray, non-stick |
| Universal pan, non-stick |
| Extra-deep pan |
| Steaming set for ovens |
| Profi pan |
| Lid for the Profi pan |
| Pizza tray |
| Grill tray |

| |
|---|
| Ceramic brick |
| Glass roasting dish, 5.1 litres |
| Glass pan |
| ComfortFlex rail (1 level)* |
| 3 x fully extendable pull-out rack* |
| *Accessory does not fit in every appliance, quote the E no. when ordering |

Before using for the first time

Before you can use your new appliance, you must make some settings. You must also clean the cooking compartment and accessories.

Initial use

As soon as the appliance is connected to the power supply, **12:00** flashes in the display.

Setting the time

Use the < or > buttons to set the current time.

After a few seconds, the time that has been set is adopted.

Changing the time

1. Press the ⌚ button repeatedly until the ⌚ symbol lights up.
2. Use the < or > button to change the time. After a few seconds, the time that has been set is adopted.

Cleaning the cooking compartment

To eliminate the new-appliance smell, heat up the cooking compartment without anything in it and with the oven door closed.

1. Remove the accessories from the cooking compartment.
2. Remove any leftover packaging, such as polystyrene pellets, from the cooking compartment.
3. Before heating the appliance, wipe the smooth surfaces in the cooking compartment with a soft, damp cloth.
4. Set the specified type of heating and temperature.

Settings

| | |
|-----------------|--|
| Type of heating | CircoTherm  |
| Temperature | Maximum |
| Cooking time | 1 hour |

5. Keep the kitchen ventilated while the appliance is heating.
6. Switch off the appliance once the specified time has elapsed.
7. Wait for the cooking compartment to cool down.

- Clean the smooth surfaces with soapy water and a dish cloth.

Cleaning the accessories

Clean the accessories thoroughly using soapy water and a dish cloth or soft brush.

Operating the appliance

You have already learnt about the controls and how they work. Now we will explain how to apply settings on your appliance.

Switching the appliance on and off

Use the function selector to switch the appliance on or off. Turning the function selector to any position other than the "Off" position switches on the appliance. To switch off the appliance, always turn the function selector to the "Off" position.

Setting the type of heating and temperature

It is very easy to use the function and temperature selector to make settings for your appliance. To find out which type of heating is best for which type of food, refer to the beginning of the instruction manual.

→ "Getting to know your appliance" on page 8

Example in the picture: CircoTherm Hot Air  at 160 °C.

- Use the function selector to set the type of heating.

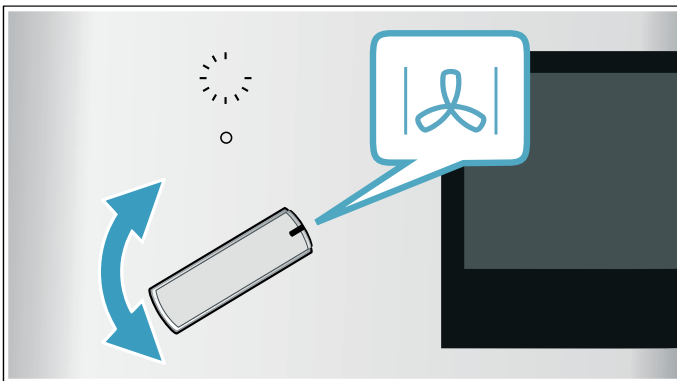

- Use the temperature selector to set the temperature or grill setting.

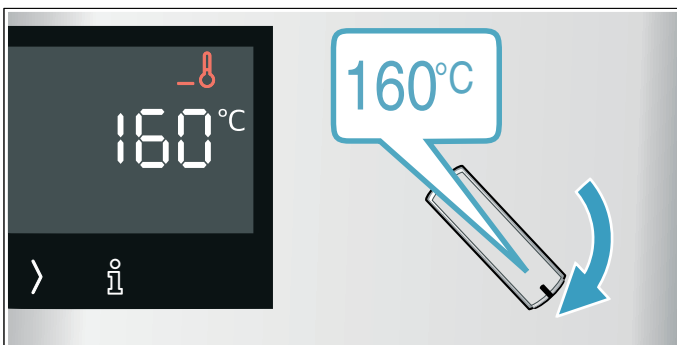

The appliance starts to heat up after a few seconds.

Note: If  flashes in the display, the temperature in the cooking compartment is too high for the selected operating mode. Switch the appliance off, wait until it has cooled down and then switch it back on again.

Once your food is cooked, turn the function selector to the "Off" position to switch the appliance off.

Note: You can set both a cooking time and an end time on the appliance. → "Time-setting options" on page 13

Changing

The heating function and temperature can be changed at any time using the relevant selector.

If you change the heating function, the temperature will be changed to the corresponding default value.

Temperature display

As soon as the appliance heats up, the  symbol appears in the display. The lines are filled from the bottom to the top as the cooking compartment heats up.

When you are preheating the appliance, the optimal time to place your food in the cooking compartment is when the  symbol first goes out.

- Appliance heats up (fig. 1)
- Temperature has been reached (fig. 2)



Residual heat

When the appliance is switched off, the temperature indicator shows the residual heat in the cooking compartment. The lower the temperature drops, the less the indicator is filled.



Notes

- The temperature indicator only shows the increasing temperature for types of heating for which a temperature is set. With cleaning functions, for example, it is filled immediately.
- Due to thermal inertia, the temperature displayed may be slightly different to the actual temperature inside the cooking compartment.

Rapid heating

With Rapid heating, you can shorten the heat-up time.



Suitable heating functions include:

-  CircoTherm hot air
-  Bread-baking setting
-  Top/bottom heating

Only use rapid heating when a temperature of over 100 °C has been selected.

To achieve an even cooking result, do not place your food into the cooking compartment until rapid heating is complete.





- Set the type of heating and temperature.

2. Touch the  button.
The  symbol appears in the display, and the  arrows are filled from the bottom to the top. The oven starts to heat up after a few seconds.

Once rapid heating is complete, an audible signal sounds and the  symbol goes out. Place your food in the cooking compartment.

Time-setting options

Your appliance has different time-setting options.

| Time-setting option | Use |
|---|--|
|  Timer | The timer functions like an egg timer. It runs independently of the appliance when it is heating and of other time-setting options, and does not affect the appliance. |
|  Cooking time | Once the set cooking time has elapsed, the appliance automatically stops heating. |
|  End time | Enter a cooking time and the required end time. The appliance starts up automatically so that it finishes cooking at the required time. |
|  Time | Set the time, e.g. after a power cut, or change it, e.g. from summer time to winter time. |

An audible signal sounds once the cooking time or timer duration has elapsed. You can cancel the audible signal early by pressing the  button.







Note: You can change how long the audible signal sounds for in the basic settings. → *"Basic settings"* on page 14

Note: If you have set a time-setting option, the time interval increases if you set a higher value. Example: You can set a cooking time of up to one hour in one-minute increments; for cooking times over one hour, you can set a cooking time in five-minute increments.

Setting the timer

The timer can be set when the appliance is switched on or off. It has its own audible signal so that you can tell whether it is the timer duration or a cooking time that has elapsed.

Tip: If the set timer duration is the duration for which you want to cook your food, use the cooking time. The appliance then switches off automatically.

1. Press the  button repeatedly until the  symbol is selected.
2. Use the  and  buttons to set the timer duration.
 - Default value for the  button = 5 minutes
 - Default value for the  button = 10 minutes









The setting is applied automatically. The timer duration starts to count down after a few seconds.

Note: When the set time has elapsed, a signal sounds. To end the timer, press the  button.

Setting the cooking time

Once the set cooking time has elapsed, the appliance switches off automatically. The function can only be used in combination with a type of heating.

1. Set the type of heating and temperature.
2. Press the  button repeatedly until the  symbol is selected.
3. Use the  and  buttons to set the cooking time.
 - Default value for the  button = 10 minutes
 - Default value for the  button = 30 minutes
 The setting is applied automatically. The appliance starts heating after a few seconds. The duration counts down in the display.





Once the cooking time has elapsed, an audible signal sounds and the appliance brings the operating mode to an end automatically.

To switch off, turn the function selector back to the "Off" position.

Setting the end time

You can delay the time at which cooking is due to finish. You can, for example, put your food in the cooking compartment in the morning and set the cooking time so that it is ready at lunch time.

Notes

- Ensure that food is not left in the cooking compartment for too long as it may spoil.
 - Do not adjust the end time once the appliance is already in operation. Otherwise the cooking result would no longer be satisfactory.
1. Place the food onto the appropriate accessory in the cooking compartment and close the appliance door.
 2. Set the type of heating and temperature.
 3. Press the  button repeatedly until the  symbol is selected.
 4. Use the  and  buttons to set the cooking time.



5. Press the  button repeatedly until the $\rightarrow I$ symbol is selected.
6. Use the \langle and \rangle buttons to set the end time. The appliance applies the settings after a few seconds. The end time is shown in the display. Once the appliance starts, the time begins counting down.

As soon as the end time has been reached, an audible signal sounds and the appliance ends the operation automatically.

To switch off, turn the function selector back to the "Off" position.

Setting the time

You can only change the time when no other time-setting option is active and the function selector is at the "Off" position.

1. Press the  button repeatedly until the  symbol is selected.
2. Use the \langle or \rangle button to change the time. The appliance applies the time after a few seconds.

Note: You can go to the basic settings to specify whether or not the time should be shown in the display.

Checking, changing or deleting settings

1. Press the  button repeatedly until the appropriate symbol is selected.
2. If required, use the \langle or \rangle button to change the setting. To delete a time-setting option, set **00:00**. The setting is applied automatically.

Childproof lock

Your appliance is equipped with a childproof lock so that children cannot switch it on accidentally or change any settings.

Notes

- You can go to the basic settings to specify whether you want the option to set the childproof lock. \rightarrow "Basic settings" on page 14
- If a hob is connected, it will not be affected by the childproof lock on the oven.

Automatic childproof lock

The control panel is locked so that the appliance cannot be switched on. To switch it on, the automatic childproof lock must be interrupted. After the appliance operation, the control panel is locked automatically.

To set or interrupt the automatic childproof lock, the function selector must be in the "Off" position.



1. Press and hold the  button for approx. four seconds. **c00 0** or **c00 1** appears in the display.
2. Use the temperature selector to change the setting as required.

- **0** = deactivate
- **1** = activate

3. When you have finished, press and hold the  button again for approx. four seconds to confirm the settings.

The basic setting is applied.

Cancelling

1. Press and hold the  button until the  symbol goes out in the display.
2. Set the type of heating and temperature.



As soon as the appliance is switched off, the automatic childproof lock is reactivated.

One-time childproof lock



The control panel is locked so that the appliance cannot be switched on. To switch it on, the one-time childproof lock must be deactivated. After the appliance is switched off, the control panel is no longer locked.

To set, activate or deactivate the one-time childproof lock, the function selector must be at the "Off" position.

Activating

Press and hold the  button until the  symbol appears in the display.

Deactivating

Press and hold the  button until the  symbol goes out in the display.

Basic settings

There are various settings available to you in order to help use your appliance effectively and simply. You can change these settings as required.

List of basic settings

Depending on the features of your appliance, not all basic settings will be available.

| Basic setting | Options |
|--|---|
| c00 Automatic childproof lock | 0 = no* 1 = yes |
| c01 Audible signal duration upon completion of a cooking time or timer duration | 1 = approx. 10 seconds 2 = approx. 30 seconds* 3 = approx. 2 minutes |
| c02 Amount of time until a setting is applied | 1 = approx. 3 seconds* 2 = approx. 6 seconds 3 = approx. 10 seconds |
| c03 Button tone that sounds when a button is touched | 0 = off 1 = on* |
| c04 Brightness of the display illumination | 1 = dark 2 = medium* 3 = bright |

| | | |
|--|---|--|
| c05 | Display time of day | 0 = hide the time 1 = display the time* |
| c06 | Enable childproof lock activation? | 0 = no 1 = yes* 2 = yes, with locked door** |
| c07 | Interior lighting on when appliance in operation? | 0 = no 1 = yes* |
| c08 | Cooling fan run-on time | 1 = short 2 = medium* 3 = long 4 = extra long |
| c09 | Telescopic rails retrofitted?* | 0 = no* (for rails and single pull-out system) 1 = yes (for double and triple pull-out systems) |
| c10 | Sabbath mode available? | 0 = no* 1 = yes |
| c11 | Water hardness** | 0 = softened 1 = soft (up to 1.3 mmol/l) 2 = medium (1.3 - 2.5 mmol/l) 3 = hard (2.5 - 3.8 mmol/l) 4 = very hard* (above 3.8 mmol/l) |
| c12 | Reset all values to factory settings? | 0 = no* 1 = yes |
| * Factory setting (factory settings may vary depending on the appliance model) | | |
| ** Not available for all appliance types. | | |

Note: If your appliance is equipped with the Home Connect function, you will find the Home Connect settings at the end of the basic settings for your appliance. → *Page 16*

The Home Connect settings begin with **HC**.

Changing the basic settings

The function selector must be set to the "Off" position.

1. Press and hold the **1** button for approx. four seconds.
The first basic setting appears in the display, e.g. **c00 0**.
2. Use the temperature selector to change the setting as required.
3. Use the **>** or **<** button to continue going through all the basic settings, and use the temperature selector if you want to change any of these settings.
4. When you have finished, press and hold the **1** button again for approx. four seconds to confirm the settings.

This applies all of the basic settings.

You can change the basic settings again at any time.

Sabbath mode

Sabbath mode lets you set a cooking time of over 70 hours. This enables you to keep dishes in the cooking compartment warm without having to switch the appliance on or off.

Starting Sabbath mode

Before you can use Sabbath mode, you will need to activate it in the basic settings. → *"Basic settings" on page 14*

The appliance heats from the top and the bottom. You can set a temperature between 85 °C and 140 °C. The cooking time can be adjusted to the nearest half hour between 24 and 72 hours.

1. Use the function selector to set bottom heating **—**. **SAb** will appear on the display.
2. Use the temperature selector to set the temperature.
3. Use the **<** and **>** buttons to set the cooking time.

Note: The end time cannot be delayed.

The appliance will start heating after a few seconds. The cooking time will count down on the display.

Once the Sabbath mode cooking time comes to an end, the appliance will stop heating.

To switch off, turn the function selector back to the "Off" position.

Changing and cancelling

The settings cannot be changed once the appliance has started.

If you would like to cancel Sabbath mode, switch the appliance off by turning the function selector to the "Off" position.

Home Connect

This appliance is Wi-Fi-capable and can be remotely controlled using a mobile device.

If the appliance is not connected to the home network, the appliance functions in the same way as an oven with no network connection and can still be operated via the display.

The availability of the Home Connect function depends on the availability of Home Connect services in your country. Home Connect services are not available in every country. You can find more information on this at www.home-connect.com.

Notes

- Ensure that you follow the safety instructions in this instruction manual and that you comply with these even when you are away from home and are operating the appliance via the Home Connect app. You must also follow the instructions in the Home Connect app. → "Important safety information" on page 5
- Operating the appliance directly from the appliance always has priority. During this time, it is not possible to operate the appliance using the Home Connect app.

Setting up

To set up Home Connect for your appliance, you require the following:

- Your appliance that is connected to the power supply and switched on,
- A smartphone or tablet with a current version of the iOS or Android operating system,
- And your appliance within range of your home network's Wi-Fi signal.

1. Download the Home Connect app.



2. Open the Home Connect app and scan the QR code.



3. Follow the instructions in the Home Connect app.

Remote Start

To start and operate your appliance via the Home Connect app, you must activate remote start. If remote start is not activated, you can only view the operating statuses in the Home Connect app and configure your appliance's settings.

Warning – Risk of fire!

Combustible objects that are left in the cooking compartment may catch fire. Never store combustible objects in the cooking compartment.

Manual remote start

You can operate and start your appliance remotely. However, you must activate the remote start before each operation.

Note: If you open the appliance door 15 minutes after remote start activation or the end of operation, remote start is automatically deactivated.

Continuous remote start

You can always operate and start your appliance remotely.









Activating remote start

Turn the function selector to .

Home Connect settings

You can adjust Home Connect to suit your requirements at any time.

Note: You will find the Home Connect settings in your appliance's basic settings. Which settings the display shows will depend on whether Home Connect has been set up and whether the appliance is connected to your home network.







| Setting | | Selection/display |
|--|---------------------------------|---|
| HCO1 | Network connection |  = Not connected* |
| | |  = Connect automatically |
| | |  = Connect manually |
| | |  = Connected* |
| HCO2 | Pairing (connecting to the app) |  = Ready |
| | |  = Connect appliance |
| | |  = Appliance is connected* |
| HCO3 | Wi-Fi |  = Switch off |
| | |  = Switch on |
| If Wi-Fi has been activated, you can use the Home Connect functions. In networked standby mode, the appliance requires max. 2 W. | | |

* Display value (not adjustable)

** Factory setting

*** If a software update is available.

**** If the after-sales service has access.

| Setting | | Selection/display |
|---|--------------------------|---|
| HCO4 | Remote control behaviour |  = Monitoring You can display the operating statuses of your appliance in the Home Connect app.  = Manual remote start** You can operate and start your appliance remotely. However, you must activate the remote start before each operation.  = Continuous remote start You can always operate and start your appliance remotely. |
| HCO5*** | Software update |  = Update available*  = Start an available update |
| HCO6**** | Allow remote diagnostics |  = No**  = Yes |
| * Display value (not adjustable) ** Factory setting *** If a software update is available. **** If the after-sales service has access. | | |

Remote diagnostics

Customer Service can use Remote Diagnostics to access your appliance if you contact them, have your appliance connected to the Home Connect server and if Remote Diagnostics is available in the country in which you are using the appliance.

Note: For further information and details about the availability of Remote Diagnostics in your country, please visit the service/support section of your local website: www.home-connect.com

About data protection

When your appliance is connected for the first time to a WLAN network, which is connected to the Internet, your appliance transmits the following categories of data to the Home Connect server (initial registration):

- Unique appliance identification (consisting of appliance codes as well as the MAC address of the installed WiFi communication module).
- Security certificate of the WiFi communication module (to ensure a secure IT connection).
- The current software and hardware version of your domestic appliance.
- Status of any previous resetting to factory settings.

This initial registration prepares the Home Connect functions for use and is only required when you want to use these Home Connect functions for the first time.

Note: Ensure that the Home Connect functions can be used only in conjunction with the Home Connect app. Information on data protection can be accessed in the Home Connect app.

Declaration of Conformity

Constructa Neff Vertriebs-GmbH hereby declares that the appliance with functionality meets the basic requirements and other relevant provisions of Directive 2014/53/EU.

A detailed RED Declaration of Conformity can be found online at www.neff-international.com among the additional documents on the product page for your appliance.



2.4 GHz band: max. 100 mW
 5 GHz band: max. 100 mW

| | | | | | | | | |
|---|----|----|----|----|----|----|----|----|
| | BE | BG | CZ | DK | DE | EE | IE | EL |
|  | ES | FR | HR | IT | CY | LV | LT | LU |
| | HU | MT | NL | AT | PL | PT | RO | SI |
| | SK | FI | SE | UK | NO | CH | TR | |
| 5 GHz Wi-Fi: for indoor use only | | | | | | | | |



Cleaning agent

With good care and cleaning, your appliance will retain its appearance and remain fully functioning for a long time to come. We will explain here how you should correctly care for and clean your appliance.

Suitable cleaning agents

To ensure that the different surfaces are not damaged by using the wrong cleaning agent, observe the information in the table. Depending on the appliance model, not all of the areas listed may be on/in your appliance.

Caution!

Risk of surface damage

Do not use:

- Harsh or abrasive cleaning agents,
- Cleaning agents with a high alcohol content,
- Hard scouring pads or cleaning sponges,
- High-pressure cleaners or steam cleaners,
- Special cleaners for cleaning the appliance while it is hot.

Wash new sponge cloths thoroughly before use.

Tip: Highly recommended cleaning and care products can be purchased through the after-sales service. Observe the respective manufacturer's instructions.



Warning – Risk of burns!

The appliance becomes very hot. Never touch the interior surfaces of the cooking compartment or the heating elements. Always allow the appliance to cool down. Keep children at a safe distance.

| Area | Cleaning |
|---------------------------|---|
| Appliance exterior | |
| Stainless steel front | <p>Hot soapy water: Clean with a dish cloth and then dry with a soft cloth.</p> <p>Remove flecks of limescale, grease, starch and albumin (e.g. egg white) immediately. Corrosion can form under such flecks.</p> <p>Special stainless steel cleaning products suitable for hot surfaces are available from our after-sales service or from specialist retailers. Apply a very thin layer of the cleaning product with a soft cloth.</p> |
| Plastic | <p>Hot soapy water: Clean with a dish cloth and then dry with a soft cloth.</p> <p>Do not use glass cleaner or a glass scraper.</p> |
| Painted surfaces | <p>Hot soapy water: Clean with a dish cloth and then dry with a soft cloth.</p> |
| Control panel | <p>Hot soapy water: Clean with a dish cloth and then dry with a soft cloth.</p> <p>Do not use glass cleaner or a glass scraper.</p> |
| Door panels | <p>Hot soapy water: Clean with a dish cloth and then dry with a soft cloth.</p> <p>Do not use a glass scraper or a stainless steel scouring pad.</p> |
| Door handle | <p>Hot soapy water: Clean with a dish cloth and then dry with a soft cloth.</p> <p>If descaler comes into contact with the door handle, wipe it off immediately. Otherwise, any stains will not be able to be removed.</p> |
| Appliance interior | |
| Enamelled surfaces | <p>Hot soapy water or a vinegar solution: Clean with a dish cloth and then dry with a soft cloth.</p> <p>Soften baked-on food remnants with a damp cloth and soapy water. Use stainless steel wire wool or oven cleaner to remove stubborn dirt.</p> <p>Caution! Never use oven cleaner in the cooking compartment when it is still warm. This may damage the enamel. Remove all food remnants from the cooking compartment and the appliance door before you next heat up the appliance.</p> <p>Leave the cooking compartment open to dry after cleaning it.</p> <p>It is best to use the cleaning function. → "Cleaning function" on page 19</p> <p>Note: Food residues can cause white deposits to form. These are harmless and do not affect how the appliance works. Remove using lemon juice if required.</p> |

| | |
|---------------------------------------|---|
| Glass cover for the interior lighting | <p>Hot soapy water: Clean with a dish cloth and then dry with a soft cloth.</p> <p>If the cooking compartment is heavily soiled, use oven cleaner.</p> |
| Door cover | <p>made from stainless steel: Use stainless steel cleaner. Follow the manufacturers' instructions. Do not use stainless steel care products.</p> <p>made from plastic: Clean using hot soapy water and a dish cloth. Dry with a soft cloth. Do not use glass cleaner or a glass scraper.</p> <p>Remove the door cover for cleaning.</p> |
| Rails | <p>Hot soapy water: Soak and clean with a dish cloth or brush.</p> |
| Pull-out system | <p>Hot soapy water: Clean with a dish cloth or a brush.</p> <p>Do not remove the lubricant while the pull-out rails are pulled out – it is best to clean them when they are pushed in. Do not clean in the dishwasher.</p> |
| Accessories | <p>Hot soapy water: Soak and clean using a dishcloth or brush.</p> <p>If there are heavy deposits of dirt, use a stainless steel scouring pad.</p> <p>Enamelled accessories are dishwasher-safe.</p> |

Notes

- Slight differences in colour on the front of the appliance are caused by the use of different materials, such as glass, plastic and metal.
- Shadows on the door panels, which look like streaks, are caused by reflections made by the interior lighting.
- Enamel is baked on at very high temperatures. This can cause some slight colour variation. This is normal and does not affect operation. The edges of thin trays cannot be completely enamelled. As a result, these edges can be rough. This does not impair the anti-corrosion protection.

Keeping the appliance clean

Always keep the appliance clean and remove dirt immediately so that stubborn deposits of dirt do not build up.

⚠ Warning – Risk of fire!

Loose food remnants, fat and meat juices may catch fire. Before using the appliance, remove the worst of the food remnants from the cooking compartment, heating elements and accessories.

Tips

- Clean the cooking compartment after each use. This will ensure that dirt cannot be baked on.
- Always remove flecks of limescale, grease, starch and albumin (e.g. egg white) immediately.
- Use the universal pan for baking very moist cakes.
- Use suitable ovenware for roasting, e.g. a roasting dish.

Cleaning function

Your appliance is equipped with a self-cleaning function and EasyClean. You can use the self-cleaning function to clean the cooking compartment. Use the EasyClean cleaning aid for intermediate cleaning of the cooking compartment. Dirt is softened beforehand using EasyClean. It can then be removed more easily.

Self-cleaning

Use "Self-cleaning" mode to clean the cooking compartment.

You can choose from three cleaning cycles.

| Cycle | Cleaning performance | Length of cycle |
|-------|----------------------|-------------------------------|
| 1 | Gentle | Approx. 1 hour and 15 minutes |
| 2 | Medium | Approx. 1 hour and 30 minutes |
| 3 | Intensive | Approx. 2 hours |

The dirtier the cooking compartment and the longer the dirt has been there, the more powerful the cleaning cycle should be. It is sufficient to clean the cooking compartment every two to three months. You can clean it more frequently if necessary. Cleaning requires approx. 2.5-4.8 kilowatt hours.

Notes

- For safety reasons, the appliance door locks automatically once a certain temperature is reached. You will not be able to open it again until the lock symbol  on the display has gone out.
- The interior lighting will not come on while the appliance is being cleaned.

Warning

Risk of burns!

- The cooking compartment becomes extremely hot during the cleaning function. Never open the appliance door. Allow the appliance to cool down. Keep children away from the appliance.
-  The appliance becomes very hot on the outside during the cleaning function. Never touch the appliance door. Allow the appliance to cool down. Keep children at a safe distance.

Warning

Risk of harm to health!

The cleaning function heats up the cooking compartment to a very high temperature so that food remnants left over from roasting, grilling and baking will burn off. This process releases vapours, which can irritate the mucous membranes. While the cleaning function is running, keep the kitchen well ventilated. Do not remain in the room for long periods. Keep children and pets away. Follow the instructions even when using the Delayed start function with a delayed end time.

Before running the cleaning function

The cooking compartment must be empty. Remove any accessories, cookware or shelf rails from the cooking compartment. Please see the relevant section for

information on how to remove the rails. → "Rails" on page 21

Clean the appliance door and along the edges of the cooking compartment in the area around the seal. Do not scrub or remove the seal.

Clean the inner door panel using hot soapy water and a dish cloth. Dry with a soft cloth. If the cooking compartment is heavily soiled, use oven cleaner.

Warning





Risk of fire!

- Loose food remnants, fat and meat juices may catch fire when the cleaning function is in progress. Before you start the cleaning function, always remove the worst of the food residues and remnants from the cooking compartment. Do not use the cleaning function for cleaning accessories.
- The appliance will become very hot on the outside during the cleaning function. Never hang combustible objects, e.g. tea towels, on the door handle. Do not place anything against the front of the appliance. Keep children away from the appliance.
- If the door seal is damaged, a large amount of heat will be generated around the door. Do not scrub or remove the seal. Never operate the appliance if the seal is damaged or missing.

Setting the self-cleaning

Before setting the cleaning function, ensure that you have followed all instructions for preparation.

The duration of each cleaning setting is preset and cannot be changed.

1. Use the function selector to set the cleaning functions . The  symbol and the cleaning functions appear in the display. The first cleaning function is selected.
2. Press the  or  button repeatedly until the  symbol is selected. "PYRO" appears in the display.
3. Use the temperature selector to set the cleaning setting.

Note: Once cleaning starts, the cleaning level can no longer be changed.

The duration appears in the display for each setting. The cleaning function starts after a few seconds. The cooking time counts down on the display.

Ventilate the kitchen when the cleaning function is running.

The appliance door locks shortly after the function starts running. The  symbol appears in the display.

Finishing

As soon as self-cleaning has run through, a signal sounds. The appliance door cannot be opened until the  symbol goes out.

Once the cleaning function has ended

1. Allow the cooking compartment to cool down.
2. Wipe off any ash that has been left behind in the cooking compartment and around the appliance door with a damp cloth.

3. Refit the shelf supports or pull-out rails. → "Rails" on page 21

Note: Very bad soiling may cause white deposits to remain on the enamel surfaces. This is residue from the food and is harmless. It does not affect performance. You can remove these residues using lemon juice if required.

EasyClean



The EasyClean cleaning aid makes it easier to clean the cooking compartment. Dirt is softened beforehand by vaporizing soapy water. It can then be removed more easily.





Warning – Risk of scalding!

Water in a hot cooking compartment may create hot steam. Never pour water into the cooking compartment when the cooking compartment is hot.

Setting the EasyClean cleaning aid

Notes

- The EasyClean  cleaning aid can only be started once the cooking compartment is cold (room temperature) and the appliance door is closed.
- Do not open the appliance door while it is running. Doing this will interrupt the EasyClean  cleaning aid.

1. Remove any accessories from the cooking compartment.
2. Mix 0.4 litres water (not distilled water) with a drop of washing-up liquid and pour into the middle of the cooking compartment floor.
3. Use the function selector to set the cleaning functions .
The  symbol and the cleaning functions will appear on the display. The first cleaning function is highlighted.
4. Press the  or  button repeatedly until the  symbol is highlighted.
"EASY" will appear on the display.
5. Turn the temperature selector.
"On" will appear on the display.

The cleaning aid will start after a few seconds. The duration will count down on the display.

Note: The interior lighting remains off while the cleaning aid is running.

If  flashes on the display when the function is switched on, this indicates that the cooking compartment has not completely cooled down. Switch off the appliance. Wait until the cooking compartment has cooled down and switch the cleaning aid back on.

Once the cleaning aid has run through to the end, an audible signal will sound.

Subsequent cleaning

The remaining water in the cooking compartment must be removed promptly. Do not leave the remaining water in the cooking compartment for a long time (e.g. overnight). The appliance must not be operated when the cooking compartment is still wet or damp.

1. Open the appliance door and remove the remaining water with an absorbent sponge cloth.
2. Clean the smooth surfaces in the cooking compartment with a dish cloth or a soft brush. Stubborn residues can be removed using a stainless steel scouring pad.
3. Remove limescale with a cloth soaked in vinegar. Then wipe with clean water and rub dry with a soft cloth (including under the door seal).
4. To switch off, turn the function selector to the zero setting.
5. Depending on the appliance type, open or lower the appliance door to the stop position (approx. 30°) and leave it open for approx. one hour to allow the enamel surfaces in the cooking compartment to dry thoroughly. Alternatively, you can also run the rapid drying function for the cooking compartment.

Running the rapid drying function for the cooking compartment

1. Once the cleaning aid has been run through, depending on the appliance type, open or lower the appliance door to the stop position (approx. 30°).
2. Start CircoTherm hot air at 50 °C.
3. After five minutes, switch off the appliance and close the appliance door.

Removing heavy deposits of dirt

You have several options for removing particularly stubborn deposits of dirt.

- Leave the soapy water to work for some time before starting the cleaning aid.
- Rub soapy water onto the dirt on the smooth surfaces before starting the cleaning aid.
- Repeat the cleaning aid after the cooking compartment has cooled down.

Rails

With good care and cleaning, your appliance will retain its appearance and remain fully functional for a long time to come. This will tell you how to remove the shelves and clean them.

Detaching and refitting the rails

Warning – Risk of burns!

The rails become very hot. Never touch the hot rails. Always allow the appliance to cool down. Keep children away from the appliance.

Detaching the rails

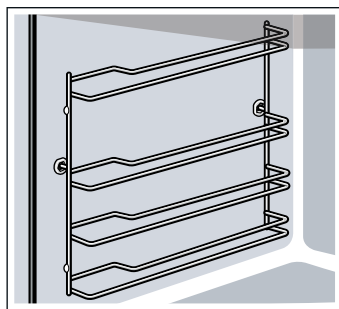

1. Lift the rail slightly at the front **a** and detach it **b** (fig. **1**).
2. Then pull the whole rail to the front and remove it (fig. **2**).

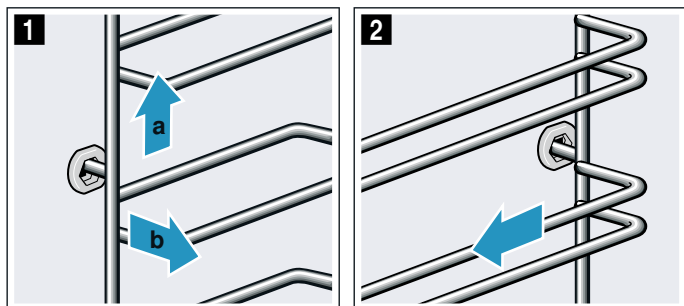

Clean the rails with cleaning agent and a sponge. For stubborn dirt deposits, use a brush.

Attaching the rails

The rails only fit on the right or the left side. For both rails, ensure that the curved rods are at the front.

1. First, insert the rail in the middle of the rear socket **a**, until the rail rests against the cooking compartment wall, and push it back **b** (figure **1**).

2. Then insert the rail into the front socket **c**, until the rail also rests against the cooking compartment wall here, and press it downwards **d** (figure **2**).

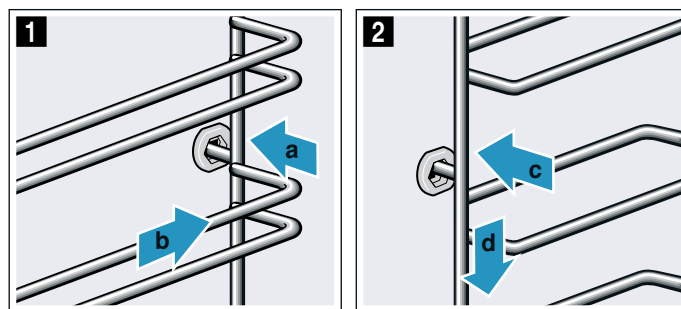

Appliance door

With good care and cleaning, your appliance will retain its appearance and remain fully functional for a long time to come. This will tell you how to remove the appliance door and clean it.

Removing and fitting the appliance door

To clean the door panels, you can detach the appliance door.

Warning – Risk of injury!

The hinges of the appliance door may snap shut with great force. Always fully turn the two locks for fitting and removing the appliance door.

Warning – Risk of injury!

If the appliance door has been removed without turning both locking levers to their limit stops, the hinge may snap shut. Do not reach into the hinge. Call the after-sales service.

Detaching the appliance door

1. Open the left- and right-hand door locks (fig. **1**). To do this, hold the screwdriver horizontally and use it to push the door lock (black component) on each side of the door all the way up (fig. **2**).

Tip: Use a torch to light up the gap so that you can see the door locks.

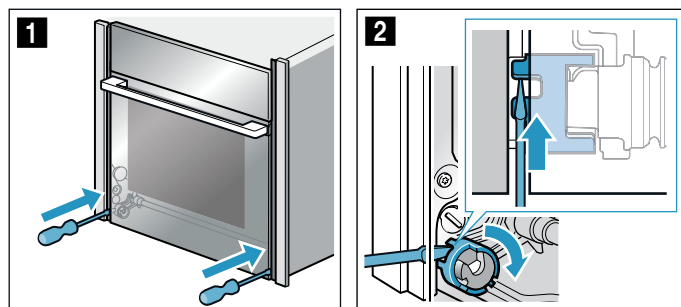

Door lock closed (fig. 3)
 Door lock open (fig. 4)

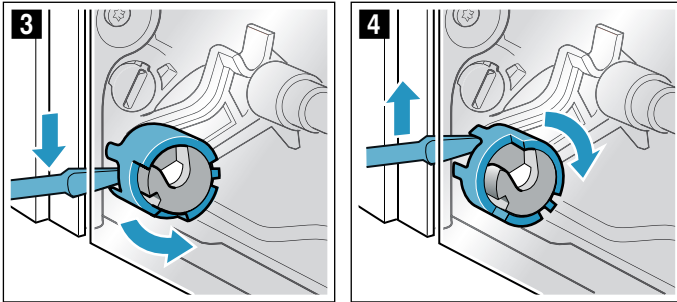

2. Open the appliance door approx. 45° (fig. 5).

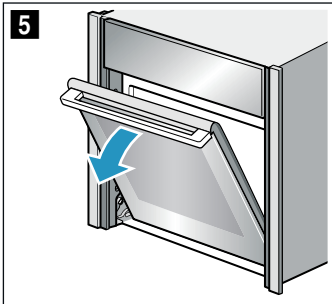

3. Using a coin, turn both the left- and right-hand locks on the inside of the appliance at the bottom as far as they will go.
 Left-hand lock: Clockwise
 Right-hand lock: Anti-clockwise
 The arrows will now be pointing to one another and the lock will click into place (fig. 6).

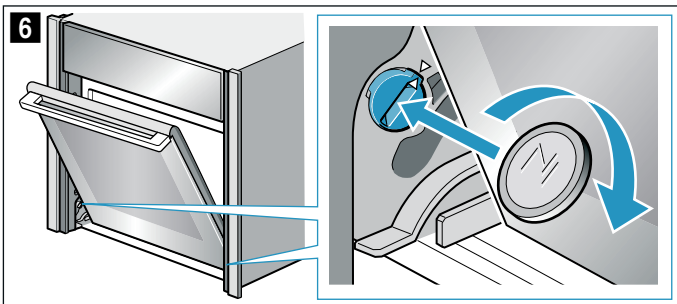

Left-hand lock secured (fig. 7)
 Right-hand lock released (fig. 8)

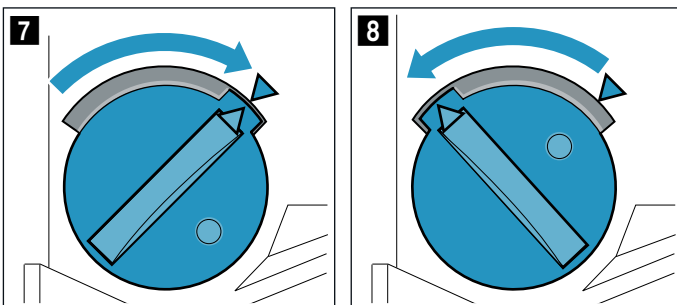

4. Move the appliance door back and forth until you hear a quiet click (fig. 9).
 The appliance door is now in the lock position. You will only be able to move it slightly.

Caution!

Risk of damaging the door hinges. Do not force the appliance door open or closed when it is in the lock position.
 If you have forced the appliance door open or closed when it was in the lock position, please contact our after-sales service.

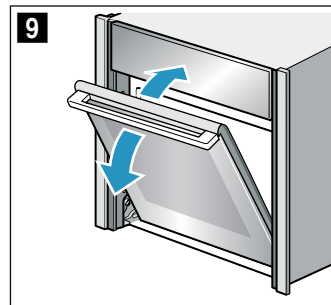

Warning

Risk of injury!

The door handle may break off. Do not carry the appliance door by the door handle. To carry or remove the appliance door, take hold of it with both hands, one on the left and one on the right.

5. Take hold of the appliance door with both hands, one on the left and one on the right, and rotate the door handle upwards slightly **a** until you are able to pull up the appliance door and remove it **b** (fig. 10).

Warning

Risk of injury!

Do not drop the appliance door.
 The appliance door weighs 7 - 10 kg – handle it with care.

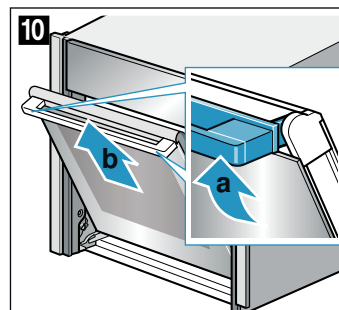

6. Set the appliance door down on a flat, soft, clean surface.

Refitting the appliance door

1. Slide the appliance door over the left- and right-hand guide rollers simultaneously (fig. 1 and 2).
 Ensure that the appliance door is not wedged at an angle and that it is properly fitted in place.

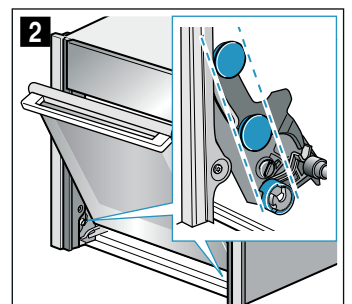
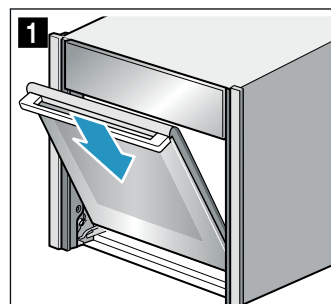

- Rotate the door handle upwards slightly **a** (fig. **3**). The appliance door will slide the short distance remaining to the bottom **b** (fig. **3**).
- Use a coin to release the locks on both sides of the appliance door (fig. **4**).

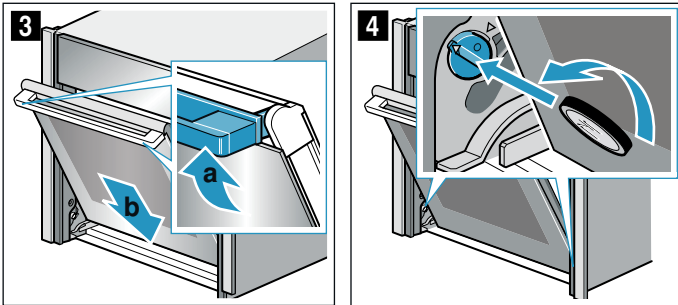

Left-hand lock: Anti-clockwise
Right-hand lock: Clockwise

- Open the appliance door slightly until you hear a quiet click. Close the appliance door.

Warning

Risk of injury if the door locks are not closed!

The appliance door may become detached. You may be injured and the appliance door damaged. After refitting the door, always close the left- and right-hand door locks.

- Close the left- and right-hand door locks (fig. **5**). To do this, hold the screwdriver horizontally and use it to push the door lock on each side of the door all the way down (fig. **6**).

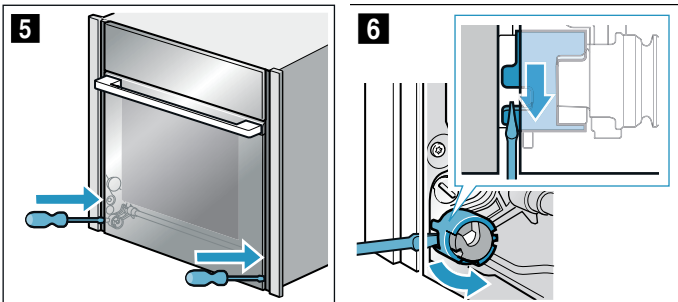

Removing and installing the door panels

For cleaning, you can remove the glass panels from the appliance door.

To do this, the appliance door must be removed beforehand (see section "Removing and fitting the appliance door").

Warning – Risk of injury!

The appliance must not be used again until the door panels and appliance door have been correctly fitted.

Warning – Risk of injury!

Components inside the appliance door may have sharp edges. Wear protective gloves.

Removal

Note: Lay the glass panels you have removed on an even surface that is soft and clean.

- Remove the appliance door.
- Lay the appliance door with the front side facing down on an even surface that is soft and clean.
- Push on the left- and right-hand side on the outside of the appliance door until the inner glass is released on both sides (Fig. **1**).
- Carefully lift the inner glass and remove it in the direction of the arrow (Fig. **2**).

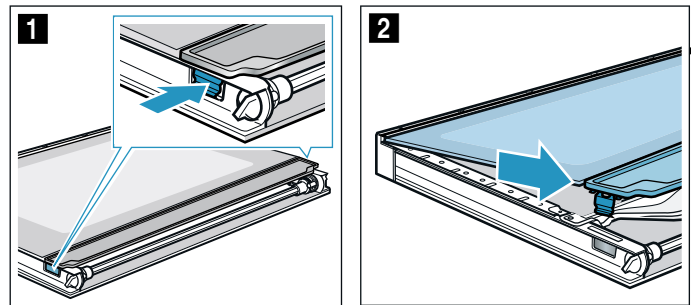

- Push down on the intermediate panel around **a**, carefully lift the holder **b** until it can be pulled out (Fig. **3**).

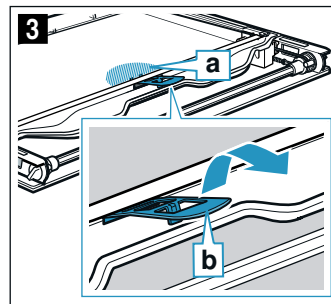

- Lift the first and second intermediate panels from below (Fig. **4**) and remove them in the direction of the arrow (Fig. **5**).

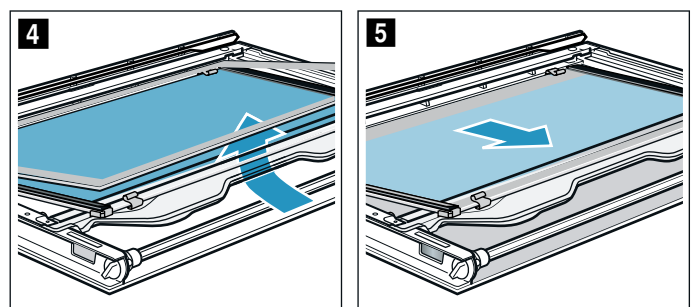

- Remove the spacers (Fig. **6**) and seals (Fig. **7**) for cleaning if needed.

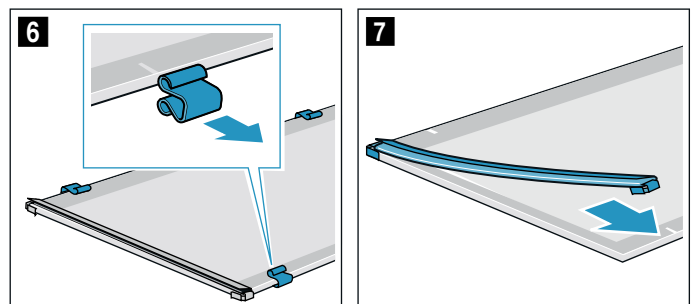

- Clean the door panels on both sides with glass cleaner and a soft cloth.

⚠ Warning
Risk of injury!

Scratched glass in the appliance door may develop into a crack. Do not use glass scrapers, or sharp or abrasive cleaning aids or detergents.

- Dry the door panels and refit them.

Fitting

Note: When fitting the door panels, make sure that they are in the original order.

- Insert the intermediate panel so that the **a** arrow on the right-hand side is pointing upwards (Fig. **1**).

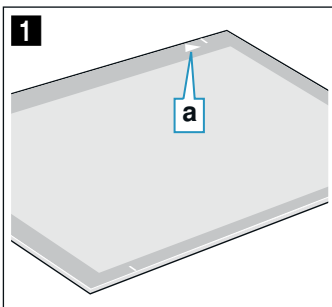

- Check the fit of the four spacers and two seals on the intermediate panel:
 - Position the spacers so that each of the lines runs through the centre (Fig. **2**).
 - Attach the seals at the corners (Fig. **3**).

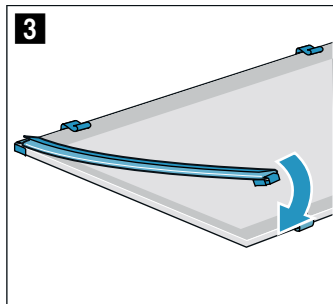
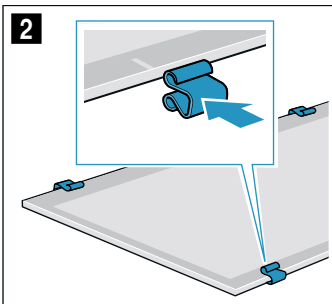

- Insert the intermediate panel with the seals and spacers. The arrow on the intermediate panel must line up with the arrow on the frame (Fig. **4**).
- Insert the second intermediate panel without the seals and spacers and push it in the direction of the arrow until it is fitted in the frame. The arrow on the intermediate panel must line up with the arrow on the frame (Fig. **5**).

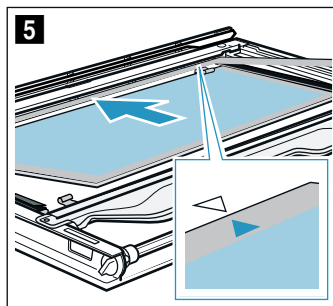
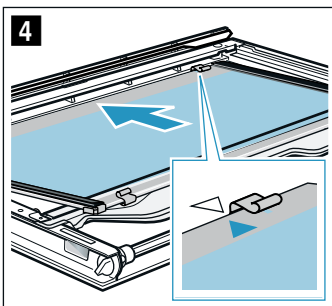

- Push down on the intermediate panel around **b**, slide the holder **c** in at an angle and push down until it clicks into place (Fig. **6**).
The holder has been inserted (Fig. **7**).

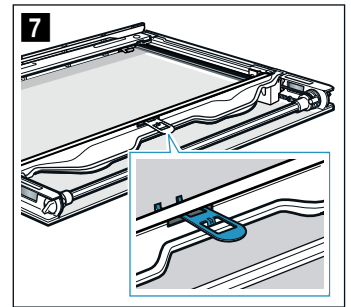
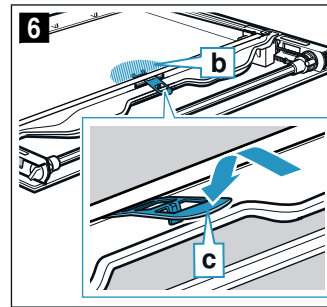

- Insert the inner glass into the mounting rail **d** at an angle towards the back (Fig. **8**).
- Push the inner glass downwards until it clicks into place (Fig. **9**).

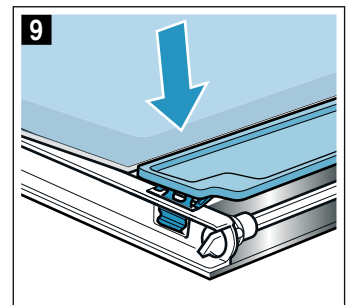
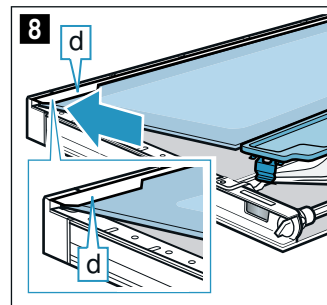

? Trouble shooting











If a fault occurs, there is often a simple explanation. Before calling the after-sales service, please refer to the fault table and attempt to correct the fault yourself.

Rectifying faults yourself

You can often easily rectify technical faults with the appliance yourself.

If a dish does not turn out exactly as you wanted, you can find useful cooking tips and instructions at the end of this instruction manual. → "Tested for you in our cooking studio" on page 26

| Fault | Possible cause | Notes/remedy |
|--|---|---|
| The appliance is not working. | Defective circuit breaker. | Check the circuit breaker in the fuse box. |
| | Power failure | Check whether the kitchen light or other kitchen appliances are working. |
| The time is flashing on the display. | Power failure. | Reset the time. |
| After switching on an operating mode, h flashes in the display. | The appliance has not cooled down sufficiently. | Switch off the appliance, allow it to cool down and switch the operating mode on again. |

| | | |
|--|--|---|
| No settings can be made on the appliance. The symbol  lights up in the display. | The child-proof lock is activated. | Press and hold the  button until the  symbol goes out in the display. Settings can be made on the appliance. The childproof lock can be deactivated in the basic settings. → "Basic settings" on page 14 |
| The appliance door cannot be opened. The symbol  lights up in the display. | The appliance door is locked with the child-proof lock. | Press and hold the  button until the  symbol goes out in the display. Settings can be made on the appliance. The childproof lock with door lock can be switched off in the basic settings. → "Basic settings" on page 14 |
| The appliance door cannot be opened. The symbol  lights up in the display. | The appliance door is locked due to the cleaning function. | Wait until the cooking compartment has cooled and the  symbol goes out. |
| The appliance is not heating. "DEMO" is shown on the display. | Demo mode is activated. | Briefly disconnect the appliance from the mains (switch off the circuit breaker in the fuse box) and then deactivate demo mode within approx. 5 minutes by changing the basic setting  to  . → "Basic settings" on page 14 |
| Home Connect does not work correctly. | | Go to www.home-connect.com |

⚠ Warning – Risk of injury!

Incorrect repairs are dangerous. Do not attempt to repair the appliance yourself. Repairs must only be carried out by one of our trained after-sales engineers. If the appliance is defective, call the after-sales service.

⚠ Warning – Risk of electric shock!

Incorrect repairs are dangerous. Repairs may only be carried out and damaged power cables replaced by one of our trained after-sales technicians. If the appliance is defective, unplug the appliance from the mains or switch off the circuit breaker in the fuse box. Contact the after-sales service.

Error messages on the display

If an error message with "E" appears on the display, e.g. *E05-32*, touch the  button. This will reset the error message. Reset the time, if necessary.

If the fault was a one-off, you can continue to use your appliance as normal. If the error message appears again, call our after-sales service and quote the exact error message and the E no. of your appliance.
→ "Customer service" on page 26

Maximum operating time

If you do not change the settings on your appliance for several hours, the appliance will stop heating automatically. This prevents unintentional continuous operation.

When the maximum operating time is reached depends on the various different settings that have been configured on the appliance.

Maximum operating time reached

FB appears on the display.

Turn the function selector to the "Off" position. You can configure new settings if required.

Tip: To prevent the appliance from switching off when you do not want it to, e.g. with an extremely long cooking time, you should always set a cooking time. The appliance will heat up until the set cooking time has elapsed.

Replacing the bulb in the top of the cooking compartment

If the cooking compartment light bulb fails, it must be replaced. Heat-resistant, 40 watt, 230 V halogen bulbs are available from the after-sales service or specialist retailers.

When handling the halogen bulb, use a dry cloth. This will increase the service life of the bulb. Only use these bulbs.

⚠ Warning – Risk of electric shock!

When replacing the cooking compartment bulb, the bulb socket contacts are live. Before replacing the bulb, unplug the appliance from the mains or switch off the circuit breaker in the fuse box.

⚠ Warning – Risk of burns!

The appliance becomes very hot. Never touch the interior surfaces of the cooking compartment or the heating elements. Always allow the appliance to cool down. Keep children at a safe distance.

1. Place a tea towel in the cold cooking compartment to prevent damage.
2. Turn the glass cover anti-clockwise to remove it (figure 1).
3. Pull out the bulb – do not turn it (figure 2).
Insert the new bulb, making sure that the pins are in the correct position. Push the bulb in firmly.

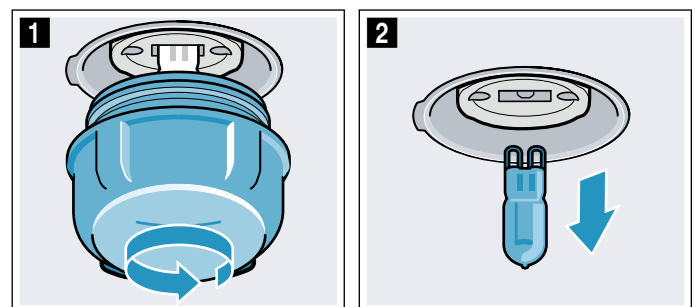

4. Screw the glass cover back on.
Depending on the appliance model, the glass cover may have a sealing ring. If the glass cover has a sealing ring, put it back in place before screwing the cover back on.
5. Remove the tea towel and switch on the circuit breaker.

Customer service

Our after-sales service is there for you if your appliance needs to be repaired. We will always find an appropriate solution, also in order to avoid after-sales personnel having to make unnecessary visits.

E number and FD number

When calling us, please give the full product number (E no.) and the production number (FD no.) so that we can provide you with the correct advice. The rating plate bearing these numbers can be found on the base of the appliance when you open the appliance door.

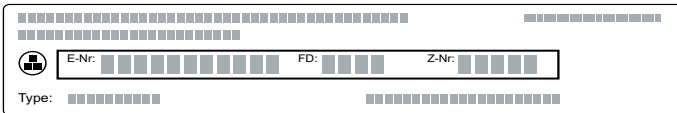

To save time, you can make a note of the number of your appliance and the telephone number of the after-sales service in the space below, should it be required.

| E no. | FD no. |
|-------|--------|
| | |

After-sales service

Please note that a visit from an after-sales service engineer is not free of charge in the event that the appliance has been misused, even during the warranty period.

Please find the contact data of all countries in the enclosed customer service list.

To book an engineer visit and product advice

- GB** 0344 892 8989
Calls charged at local or mobile rate.
- IE** 01450 2655
0.03 € per minute at peak. Off peak 0.0088 € per minute.

Rely on the professionalism of the manufacturer. You can therefore be sure that the repair is carried out by trained service technicians who carry original spare parts for your appliances.

Tested for you in our cooking studio

Here, you can find a selection of dishes and the ideal settings for them. We will show you which type of heating and temperature are best suited to your dish. You will get information on suitable cooking accessories and the height at which they should be placed in the oven. You will also get tips about cookware and preparation methods.

Note: A lot of steam can build up in the cooking compartment when cooking food. Your appliance is very energy-efficient and radiates very little heat to its surroundings during operation. Due to the high difference in temperature between the appliance interior and the external parts of the appliance, condensation may build up on the door, control panel or adjacent kitchen cabinet panels. This is a normal physical phenomenon. Condensation can be reduced by preheating the oven or opening the door carefully.

Caution!

Never pour water into the hot cooking compartment or place cookware containing water onto the bottom of the cooking compartment. The change in temperature can cause damage to the enamel.

General information

Recommended setting values

The table lists the optimal heating type for various types of food. The temperature and cooking time are dependent on the quantity of food and the recipe. Settings ranges are indicated for this reason. Try using the lower values to start with. A lower temperature will result in more even browning. You can use a higher setting next time if necessary.

Note: Cooking times cannot be reduced by using higher temperatures. The food would only be cooked on the outside, but would not be fully baked in the middle.

The setting values apply to food that is placed into a cold cooking compartment. By doing so, you can make energy savings of up to 20 per cent. If you preheat the oven, you can reduce the indicated baking times by several minutes.

Preheating is necessary for selected food, and this is indicated in the table. Do not place your food or accessories into the cooking compartment until it has finished preheating.

If you wish to follow one of your own recipes when baking, you should use the setting values listed for similar food in the table as reference. Additional information can be found in the baking tips listed after the settings tables.

Remove unused accessories from the cooking compartment. This will ensure that you achieve the best possible cooking results and energy savings of up to 20 per cent.

Accessories

Only use original accessories supplied with your appliance. These have been tailored to the cooking compartment and the operating modes of your appliance.

Ensure that you always use suitable accessories and that they are placed in the oven the right way around. → "Accessories" on page 10

Greaseproof paper

Only use greaseproof paper that is suitable for the selected temperature. Always cut greaseproof paper to size.

CircoTherm gentle heating function

CircoTherm gentle is an intelligent heating function that allows you to gently cook meat, fish and baked items. The appliance optimally controls the supply of energy to the cooking compartment. The food is cooked in phases using residual heat. This means that it remains more succulent and browns less. Depending on the method of preparation and the type of food, it is possible to save energy. If you open the appliance door before the food has finished cooking or if you preheat the appliance, you may not be able to achieve this result.

Only use genuine accessories for your appliance. These have been tailored to the cooking compartment and the heating functions of your appliance. Remove any accessories that are not being used from the cooking compartment.

Place the food into the empty cooking compartment before the oven is heated up. Always keep the appliance door closed when cooking. Only cook on one level when using this function.

The CircoTherm gentle heating function is used to measure both the energy consumption in air recirculation mode and the energy efficiency class.



Baking

Here, you can find recommended settings for many dishes.

In addition, refer to the information in the section on proving dough.

Baking

Baking on one level

| Food | Dish | Shelf position | Type of heating | Temperature in °C | Time in minutes |
|----------------------|----------------|----------------|--|-------------------|-----------------|
| Victoria sponge cake | 2x Ø20cm tins | 2 |  | 150-170* | 15-25 |
| Light fruit cake | High Ø20cm tin | 2 |  | 140-160 | 70-100 |
| Rich fruit cake | High Ø23cm tin | 2 |  | 140-150 | 180-210 |

* Preheat; do not use rapid heat-up function

** Preheat for 5 mins; do not use rapid heat-up function

*** Preheat with Hotair 180 °C

**** Preheat for 20 mins

Baking on one level

When baking on one level, use the following shelf positions:

- Tall baked goods or tin on wire rack: Level 2
- Flat baked goods or goods in a baking tray: Level 3

Baking on two or more levels

Use CircoTherm. Items that are placed in the oven on baking trays or in baking tins/dishes at the same time will not necessarily be ready at the same time.

Baking on two levels:

- Universal pan: Level 3
Baking tray: Level 1
- Baking tins/dishes on the wire rack
First wire rack: Level 3
Second wire rack: Level 1

Baking on 3 levels:

- Baking tray: Level 4
Universal pan: Level 3
Baking tray: Level 1

You can cut energy use by up to 45% by preparing items at the same time. Position baking tins/dishes either next to one another or offset on different shelves so that they are not directly one above the other in the cooking compartment.

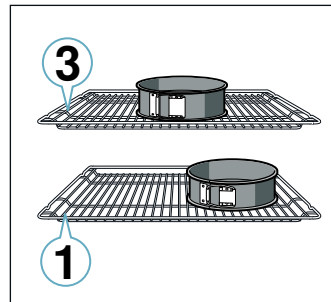



















Baking tins

For optimal cooking results, we recommend using dark-coloured metal baking tins.

Tinplate baking tins, ceramic dishes and glass dishes extend baking time and mean that the baked item will not brown evenly.

If you are using silicone moulds, follow the manufacturer's instructions and recipes. Silicone moulds are often smaller than normal baking tins. Quantity and recipe specifications may vary.

| Food | Dish | Shelf position | Type of heating | Temperature in °C | Time in minutes |
|-------------------------------|------------------------------|----------------|---|-------------------|-----------------|
| Fruit crumble | Flat glass dish | 3 |  | 160-180* | 30-40 |
| Sponge Cake (fatless), 3 eggs | Springform cake tin Ø26cm | 2 |  | 160-170 | 30-35 |
| Swiss roll | Swiss roll tin | 3 |  | 180-190* | 10-15 |
| Fruit Pie | Plate Ø20cm or pie tin | 2 |  | 160-170 | 60-70 |
| Quiche | Quiche tin (dark coated) | 3 |  | 180-200 | 40-55 |
| (White) Bread | Loaf tin (1x900g or 2x 450g) | 2 |  | 190-210* | 25-40 |
| Scones | Baking sheet on wire rack | 3 |  | 190-200* | 10-15 |
| Biscuits | Baking sheet on wire rack | 3 |  | 140-160* | 10-20 |
| Small Cakes | 12-cup-tin | 3 |  | 150** | 25-35 |
| Puff pastry slices | Baking tray | 3 |  | 170-190* | 25-35 |
| Jam tarts | 12-cup-tin | 3 |  | 170-190* | 15-25 |
| Meringue | Baking sheet on wire rack | 3 |  | 80-90* | 120-150 |
| Pavlova | Baking sheet on wire rack | 3 |  | 100-110*** | 150-180 |
| Choux pastry | Baking tray | 3 |  | 190-210 | 35-50 |
| Meat Pie | Pie dish | 2 |  | 180-200 | 40-50 |
| Yorkshire pudding | 12-cup-tin | 3 |  | 200-220**** | 15-25 |
| Jacket potatoes | Baking tray | 3 |  | 150-170 | 75-90 |
| Pizza, homemade | Baking tray | 3 |  | 210-230 | 20-30 |
| Pizza, homemade, thin base | Pizza tray | 2 |  | 250-270 | 8-13 |













* Preheat; do not use rapid heat-up function

** Preheat for 5 mins; do not use rapid heat-up function

*** Preheat with Hotair 180 °C

**** Preheat for 20 mins

Baking on two or more levels

| Food | Dish | Shelf position | Type of heating | Temperature in °C | Time in minutes |
|--------------------------------|---------------------------------|----------------|---|-------------------|-----------------|
| Victoria sponge cake, 2 levels | 4x Ø20cm tins | 3+1 |  | 150-160* | 20-30 |
| Scones, 2 levels | 2 baking sheets on 2 wire racks | 3+1 |  | 160-180* | 10-20 |
| Biscuits, 2 levels | 2 baking sheets on 2 wire racks | 3+1 |  | 140-160* | 15-25 |
| Biscuits, 3 levels | 3 baking sheets on 3 wire racks | 4+3+1 |  | 140-160* | 15-25 |
| Small Cakes, 2 levels | 2x 12-cup-tins | 3+1 |  | 150** | 20-30 |
| Puff pastry slices, 2 levels | Universal pan + baking tray | 3+1 |  | 170-190* | 25-45 |
| Puff pastry slices, 3 levels | Baking trays + universal pan | 4+3+1 |  | 170-190* | 25-45 |
| Jam tarts, 2 levels | 2x 12-cup-tins | 3+1 |  | 170-190* | 15-25 |
| Meringue, 2 levels | 2 baking sheets on 2 wire racks | 3+1 |  | 90-100* | 100-130 |
| Jacket potatoes, 2 levels | Universal pan + baking tray | 3+1 |  | 150-170* | 75-90 |
| (White) Bread, 2 levels | 4x loaf tins | 3+1 |  | 170-190* | 30-40 |
| Pizza, homemade, 2 levels | Universal pan + baking tray | 3+1 |  | 180-200 | 35-45 |

* Preheat

** Preheat for 5 mins; do not use rapid heat-up function

Baking tips

You want to find out whether the baked item is completely cooked in the middle.

Push a cocktail stick into the highest point on the baked item. If the cocktail stick comes out clean with no dough residue, the baked item is ready.

The baked item collapses.

Next time, use less liquid. Alternatively, set the temperature 10 °C lower and extend the baking time. Adhere to the specified ingredients and preparation instructions in the recipe.

| | |
|---|---|
| The baked item has risen in the middle but is lower around the edge. | Only grease the base of the springform cake tin. After baking, loosen the baked item carefully with a knife. |
| The fruit juice overflows. | Next time, use the universal pan. |
| Small baked items stick to one another during baking. | There should be a gap of approx. 2 cm around each item. This gives enough space for the baked items to expand well and brown on all sides. |
| The baked item is too dry. | Set the temperature 10 °C higher and shorten the baking time. |
| The baked item is too light in colour overall. | If the shelf position and the accessories are correct, then you should increase the temperature if necessary or extend the baking time. |
| The baked item is too light on top, and too dark underneath. | Bake the cake one level higher in the oven the next time. |
| The baked item is too dark on top, and too light underneath. | Bake the cake one level lower in the oven the next time. Select a lower temperature and extend the baking time. |
| The baked item is too dark in a tin or loaf tin. | Place the baking tray in the middle of the accessory, not directly against the back wall. |
| The baked item is too dark in colour overall. | Select a lower temperature next time and extend the baking time if necessary. |
| The baked item is unevenly browned. | Select a slightly lower temperature. Protruding greaseproof paper can affect the air circulation. Always cut greaseproof paper to size. Ensure that the baking tin does not stand directly in front of the openings in the cooking compartment back wall. When baking small items, you should use similar sizes and thicknesses wherever possible. |
| You were baking on several levels. The items on the top baking tray are darker than those on the lower baking tray. | Always select hot air when baking on several levels. Baked items that are placed into the oven on trays or in baking tins at the same time will not necessarily be ready at the same time. |
| The baked item looks good, but is not cooked properly in the middle. | Use a lower temperature and bake slightly longer; if necessary, add slightly less liquid. For baked items with a moist topping, bake the base first. Sprinkle it with almonds or breadcrumbs and then place the topping on top. |
| The baked item cannot be turned out of the dish when it is turned upside down. | Allow the baked item to cool down for 5 to 10 minutes after baking. If it still sticks, carefully loosen it around the edges again using a knife. Turn the baked item upside down again and cover it several times with a cold, wet cloth. Next time, grease the baking tin and sprinkle with breadcrumbs. |

Roasting, braising and grilling

Here, you will find information on roasting, braising and grilling poultry, meat and fish. The settings tables list the optimal settings for a wide range of dishes.

Poultry

When cooking duck or goose, pierce the skin on the underside of the wings. This allows the fat to run out.

If using duck breast, score the skin. Do not turn duck breasts.

Add some liquid to the poultry in the dish. Cover the base of the ovenware with approx. 1-2 cm of liquid.

When you turn poultry, ensure that the breast side or the skin side is underneath at first.

Poultry will turn out particularly crispy and brown if you baste it towards the end of the roasting time with butter, salted water or orange juice.

Meat

Baste lean meat with fat as required or cover it with strips of bacon. Score the rind crosswise. If you turn the joint when cooking it, ensure that the rind is underneath to begin with.

When the joint is ready, turn off the oven and allow it to rest for a further 10 minutes in the cooking compartment, keeping the door closed. This helps

distribute the meat juices more evenly. Wrap the joint in aluminium foil if necessary. The recommended resting time is not included in the indicated cooking time.

Fish

Whole fish does not need to be turned. Place the whole fish into the cooking compartment in its swimming position, with the dorsal fin at the top. Placing half a potato or a small oven-proof container in the stomach cavity of the fish will keep it upright.

You can tell when the fish is cooked because the dorsal fin can be removed easily.

Roasting and braising on the wire rack

On the wire rack, poultry and meat will become very crispy on all sides. Roasting on the wire rack works particularly well for large poultry or for multiple pieces at the same time.

Add up to 1/2 litre of water to the universal pan, depending on the size and type of meat. Any dripping fat and meat juices will be caught. You can make a sauce from these juices. This will also result in less smoke being produced and keep the cooking compartment cleaner.

Slide the universal pan into the oven at the indicated shelf position with the wire rack on top. Ensure that the wire rack is correctly positioned on the universal pan.

Roasting and braising in cookware

⚠ Warning – Risk of injury from shattering glass!
Place hot glass cookware on a dry mat after cooking. The glass may crack if placed on a cold or wet surface.

⚠ Warning – Risk of scalding!
Very hot steam may escape when opening the lid after cooking. Lift the lid at the rear, so that the hot steam can escape away from you.

It is more convenient to roast and braise meat in cookware. You can take the joint out of the cooking compartment more easily in the cookware, and prepare the sauce in the cookware itself.

Only use cookware that is suitable for use in an oven. Check whether the cookware fits in the cooking compartment.

It is best to use glass cookware. Place hot glass cookware onto a dry mat after cooking. The glass may crack if placed on a cold or wet surface.

When roasting poultry and other meat, add a little liquid.

The liquid in the cookware evaporates as the meat roasts. Carefully pour in more liquid if required.

Shiny roasting dishes made from stainless steel or aluminium reflect heat like a mirror and are therefore not particularly suitable. The meat cooks more slowly and does not brown so well. Use a higher temperature and/or a longer cooking time.

Follow the manufacturer's instructions for your roasting dishes.

Roasting in uncovered cookware

It is best to use a deep roasting dish for roasting poultry and meat. Place the dish onto the wire rack. If you do not have any suitable cookware, use the universal pan.

Braising in covered cookware

Cooking with covered cookware keeps the cooking compartment considerably cleaner. Ensure that the lid fits well and closes properly. Place the cookware onto the wire rack.

The distance between the meat and the lid should be at least 3 cm, as the meat may expand.

Very hot steam may escape when the lid is opened after cooking. Lift the lid at the rear, so that the hot steam can escape away from you.

To braise the meat, sear it first as required. Add water, wine, vinegar or a similar liquid to the braising liquid. Cover the bottom of the cookware with at least 2 cm of liquid.

The liquid in the cookware evaporates as the meat roasts. Carefully pour in more liquid if required.

Grilling flat items

Flat pieces of poultry, meat and fish, such as steaks, drumsticks and burgers, can be cooked effectively

using the "Grill" heating function. It is also excellent for toasting bread.

Grilling

Keep the appliance door closed when using the grill. Never grill with the appliance door open.

Place the food to be grilled on the wire rack. In addition, slide the universal pan in at least one shelf position lower, with the slanted edge facing the appliance door. Any dripping fat will be caught.

When grilling, try wherever possible to use pieces of food which are of a similar thickness and weight. This will allow them to brown evenly and remain succulent and juicy. Place the food to be grilled directly onto the wire rack.

Use tongs to turn the pieces of food you are grilling. If you pierce the meat with a fork, the juices will run out and it will become dry.

Do not add salt to the meat until it has been grilled. Salt draws water from the meat.

Notes

- The grill element switches itself continuously on and off; this is normal. The set temperature determines how frequently this occurs.
- Smoke may be produced when grilling.

Meat thermometer

Depending on your appliance's features, you may have a meat thermometer. You can cook accurately using a meat thermometer. Read important notes on using the meat thermometer in the corresponding chapter. There, you can find notes on inserting the meat thermometer, the possible heating types and additional information.

Recommended setting values

The table lists values for poultry, meat and fish, with default values for the weight.

The setting values are based on the assumption that unstuffed, chilled, ready-to-roast poultry, meat or fish is placed into a cold cooking compartment.

If you wish to cook heavier poultry, meat or fish, always use the lower temperature. If cooking more than one item, use the weight of the heaviest item as a basis for determining the cooking time. The individual pieces should be approximately the same size.

As a general rule: The larger the poultry, meat or fish, the lower the cooking temperature and the longer the cooking time.

Turn the poultry, meat or fish after approx. 1/2 to 2/3 of the time listed.

Cover the bottom of the glass cookware with approx. 1/2 cm of liquid.

The quantity of liquid depends on the type of meat, the material the cookware is made from and on whether or not a lid is used. If you are cooking meat in an enamelled or dark-coloured metal roasting dish, it will need a little more liquid than if cooked in glass cookware.

Calculating the cooking time (e.g. 20+35):



























To calculate the cooking time, assume 20 minutes per 500 g of meat plus an extra 35 minutes. For 1.5 kg, the cooking time would therefore be 95 minutes.

Cooking time range (e.g. 10-15):

Your food will be ready within the specified range of time (in minutes).

Roasting, braising and grilling

Roasting and Braising

| Food | Dish | Shelf position | Type of heating | Temperature in °C | Time in minutes |
|---|---------------------------------------|----------------|--|-----------------------------------|---|
| Slow roast joint (beef) | Cookware, uncovered | 2 |  | 140 | 50+50 |
| Beef top side / top rump | Cookware, uncovered | 2 |  | 170 | 40+30 |
| Lamb leg (bone-in) | Cookware, uncovered | 2 |  | 160-170 | 25+15 |
| Lamb shoulder (bone-in) | Cookware, uncovered | 2 |  | 160-170 | 15+25 |
| Lamb shoulder (boned and rolled) | Cookware, uncovered | 2 |  | 170-180 | 18+30 |
| Rack of lamb** | Cookware, uncovered | 2 |  | 170-190* | 15+20 |
| Pork, roast joint | Cookware, uncovered | 2 |  | 180-190 | 30+35 |
| Pork, loin joint | Cookware, uncovered | 2 |   | 160 | 35+30 |
| Pork, belly | Cookware, uncovered | 2 |   | 170-180*** 250 | 30+30 3-5 |
| Pork, gammon joint | Cookware, uncovered | 2 |  | 160-170*** | 30+30 |
| Chicken, whole | Wire rack***** | 2 |  | 170-180 | 25+15 |
| Chicken portion, bone-in, 200-250 g each | Cookware, uncovered | 2 |  | 200-220 | 40-50 |
| Duck, 2-3 kg | Cookware, uncovered | 2 |  | 180-190 | 25+20 |
| Turkey, crown | Wire rack | 2 |  | 140-150**** | 20+25 |
| Turkey, thighs | Cookware, uncovered | 2 |  | 180-190 | 40+25 |
| Turkey, whole, 4-8 kg | Wire rack | 1 |  | 150-160***** | 12+12 |
| Fish, braised, whole 300 g, e.g. trout | Cookware, covered | 2 |  | 170-190 | 25-35 |
| Fish, braised, whole 1,5 kg, e.g. salmon | Cookware, covered | 2 |  | 180-200 | 55-65 |
| Fish fillet, plain, braised, 400 g | Cookware, covered | 2 |  | 170-190 | 30-40 |
| Meat loaf | Cookware, uncovered | 2 |  | 170-180 | 20+40 |
| Diced meat (beef, pork, lamb), 500 g meat | Cookware, covered | 2 |  | 140 | 120-140 |
| Diced chicken (boned), 500 g meat | Cookware, covered | 2 |  | 140 | 100-120 |
| Braising steak | Cookware, covered | 2 |  | 140 | 100-120 |
| Complete meal with beef | Wire rack + wire rack + universal pan | 4+1 |  | 160, then 200 (yorkshire pudding) | beef: (20+15) + 20 for yorkshire pudding |
| Complete meal with chicken | Wire rack + wire rack + universal pan | 4+1 |  | 180, then 200 (yorkshire pudding) | chicken: (25+25) + 20 for yorkshire pudding |

* Preheat

** Without fat layer (best end neck), do not turn

*** Do not turn

**** Bone side down, do not turn

***** Turn after app. 1 hour

***** Slide in the universal pan underneath the wire rack

Grilling

| Food | Dish | Shelf position | Type of heating | Grill setting | Time in minutes |
|----------------------------------|--------------|----------------|-----------------|---------------|------------------------------|
| Beef steak, height 2-3cm, medium | Wire rack | 3 | | Int/ | 1. side 11-13 2. side 4-6 |
| Beef burger, height 1-2cm | Wire rack | 4 | | Int/* | 1. side 8-9 2. side 4-5 |
| Lamb chops, height 1-2cm | Wire rack | 3 | | Int/** | 1. side 5-6 2. side 5-6 |
| Bacon rashers | Wire rack*** | 3 | | Int/** | 1. side 4-5 2. side 3-4 |
| Sausages, thickness 2-4cm | Wire rack | 3 | | Int/* | 10-15**** |
| Fish fillets/chops | Wire rack | 4 | | Int/* | 12-16 |
| Grilling white bread | Wire rack | 4 | | Int/** | 0-1 |

* Preheat for 3 mins
 ** Preheat for 5 mins; do not use rapid heat-up function
 *** Slide the universal pan in underneath at shelf position 2
 **** Turn over several times

| Food | Dish | Shelf position | Type of heating | Temperature in °C | Time in minutes |
|--|---------------------|----------------|-----------------|-------------------|-----------------|
| Beef, top side / top rump | Cookware, uncovered | 2 | | 160 | 40+35 |
| Lamb, leg (bone-in) | Cookware, uncovered | 2 | | 160-170 | 25+15 |
| Lamb, shoulder (bone-in) | Cookware, uncovered | 2 | | 170-180 | 15+15 |
| Lamb, shoulder (boned and rolled) | Cookware, uncovered | 2 | | 160-170 | 20+15 |
| Rack of lamb** | Cookware, uncovered | 2 | | 170-190* | 15+25 |
| Pork, roast joint | Cookware, uncovered | 2 | | 180-200 | 30+40 |
| Pork, loin joint | Cookware, uncovered | 3 | | 160-170*** | 35+35 |
| Pork, belly | Cookware, uncovered | 2 | | 160-170*** | 30+30 |
| Pork, gammon joint | Cookware, uncovered | 2 | | 170-180*** | 25+20 |
| Chicken drumstick, 150 g each | Cookware, uncovered | 3 | | 210-230 | 30-40 |
| Chicken portion, bone-in, 200-250 g each | Cookware, uncovered | 3 | | 200-220 | 35-45 |
| Chicken, whole | Wire rack**** | 2 | | 170-180 | 25+20 |
| Duck, 2-3 kg | Cookware, uncovered | 2 | | 190-200 | 20+20 |
| Turkey, thighs | Cookware, uncovered | 2 | | 160-170 | 35+30 |
| Trout, whole, 300 g each | Wire rack | 2 | | 160-180 | 20-30 |

* Preheat
 ** Without fat layer (best end neck), do not turn
 *** Do not turn
 **** Slide in the universal pan underneath the wire rack

Ready meals

Here, you will find the ideal settings for preparing chilled and frozen meals.















Notes

- The cooking result greatly depends on the quality of the food. Pre-browning and irregularities are sometimes already present on the raw product.
- Do not use frozen products that are covered with a thick layer of ice. Remove any ice on the food.
- Distribute foods that are in the form of separate pieces, such as bread rolls and potato products, so that they are spread out flat and evenly on the accessory. Leave a little space between the individual pieces.
- Follow the manufacturer's instructions on the packaging.

Shelf positions

Use the shelf positions indicated.

Baking

| Food | Dish | Shelf position | Type of heating | Temperature in °C | Time in minutes |
|-------------------------------------|-----------------------------|----------------|--|-------------------|-----------------|
| Pizza, chilled | Wire rack | 3 |  | 190-210 | 15-20 |
| Pizza, frozen, thin base | Wire rack | 3 |  | 210-230 | 15-20 |
| Pizza, frozen, thin base, 2 levels | Universal pan + wire rack | 3+1 |  | 190-210 | 20-25 |
| Pizza, frozen, thick base | Wire rack | 3 |  | 180-200 | 20-25 |
| Pizza, frozen, thick base, 2 levels | Universal pan + wire rack | 3+1 |  | 190-210 | 20-30 |
| Oven chips, Croquettes, frozen | Universal pan | 3 |  | 190-210 | 25-35 |
| Oven chips, frozen, 2 levels | Universal pan + baking tray | 3+1 |  | 190-210 | 30-40 |
| Hash browns, frozen | Universal pan | 2 |  | 210-230 | 30-40 |
| Fish fingers, frozen | Universal pan | 3 |  | 200-220 | 20-25 |
| Chicken nuggets, frozen | Universal pan | 3 |  | 190-210 | 20-25 |
| Lasagna, chilled, 500g | Ovenproof dish on wire rack | 2 |  | 180-200 | 30-40 |
| Lasagna, chilled, 1,5kg | Ovenproof dish on wire rack | 2 |  | 190-210 | 35-45 |
| Lasagna, frozen, 500g | Ovenproof dish on wire rack | 2 |  | 180-200 | 45-55 |
| Lasagna, frozen, 1,5kg | Ovenproof dish on wire rack | 2 |  | 170-190 | 75-85 |

Desserts

You can make your own soufflés and yogurt using your appliance.

Soufflés

You can also prepare soufflés in a water bath in the universal pan. To do so, slide the universal pan in at level 2.

Yogurt

Remove accessories and shelves from the cooking compartment. The cooking compartment must be empty.

1. Heat 1 litre of milk (3.5 % fat) to 90 °C on the hob and then cool down to 40 °C.
It is sufficient to heat UHT milk to 40 °C.
2. Stir in 150 g (chilled) yogurt.

Baking on one level

When baking on one level, use the following shelf positions:

- Tall baked items: Position 2
- Flat baked items: Position 3

Baking on two levels

Use CircoTherm hot air. Items that are placed in the oven on baking trays or in baking tins/dishes at the same time will not necessarily be ready at the same time.

- Universal pan: Position 3
Baking tray: Position 1

Recommended setting values

The table lists the optimal heating function for various types of food. The temperature and cooking time depend on the amount and consistency of the dough/mixture. Settings ranges are specified for this reason. Try using the lower values to start with. A lower temperature will result in more even browning. You can use a higher setting next time if necessary.

3. Pour into cups or small jars and cover with cling film.
4. Place the cups or jars onto the cooking compartment floor and set as indicated in the table.
5. After preparation, leave the yogurt to cool in the refrigerator.

| Dish | Accessories/cookware | Shelf position | Type of heating | Temperature in °C | Cooking time in mins |
|------------------------------|----------------------|---------------------------|-----------------|-------------------|----------------------|
| Yoghurt | Individual moulds | Cooking compartment floor | = | 40-45 | 8-9h |
| Soufflé in individual moulds | Individual moulds | 2 | == | 160-180 | 35-45 |

Acrylamide in foodstuffs

Acrylamide is mainly produced in grain and potato products prepared at high temperatures, such as potato

crisps, chips, sliced bread, bread rolls, bread or fine baked goods (biscuits, gingerbread, spiced biscuit).

Tips for keeping acrylamide to a minimum

| | |
|------------|---|
| General | <ul style="list-style-type: none"> ■ Keep cooking times as short as possible. ■ Cook food until it is golden brown, but not too dark. ■ Large, thick pieces of food contain less acrylamide. |
| Baking | With top/bottom heating at max. 200 °C. With hot air at max. 180 °C. |
| Biscuits | With top/bottom heating at max. 190 °C. With hot air at max. 170 °C. Egg or egg yolk reduces the production of acrylamide. |
| Oven chips | Spread out a single layer evenly on the baking tray. Cook approx. 400-600 g at once on a baking tray so that the chips do not dry out and become crunchy. |

Drying

You can achieve outstanding drying results with CircoTherm. With this type of preserving, flavours are concentrated as a result of the dehydration.

Only use unblemished, fresh fruit, vegetables and herbs and wash them thoroughly. Line the wire rack with greaseproof paper or parchment paper. Drain the excess water from the fruit and then dry it.

If necessary, cut it into equal chunks or thin slices. Place unpeeled fruit onto the dish with the sliced surfaces facing upwards. Ensure that neither fruit nor mushrooms overlap on the wire rack.

Grate vegetables and then blanch them. Drain the blanched vegetables thoroughly and spread them evenly on the wire rack.

Dry herbs on the stem. Position the herbs evenly and slightly heaped on the wire rack.

Use the following shelf positions for drying:

- 1 wire rack: Level 3
- 2 wire racks: Levels 3 + 1

Turn very juicy fruit and vegetables several times. After drying, remove the dried fruit and vegetables from the paper immediately.

In the table, you will find settings for drying various foodstuffs. The temperature and drying time are dependent on the type, moisture, ripeness and thickness of the food to be dried. The longer you leave the food to be dried, the better it will be preserved. The thinner the slices are, the quicker the drying process will be and the more flavour the dried food will retain. Settings ranges are indicated for this reason.

If you wish to dry food that is not listed in the table, you should use similar foodstuffs in the table as a reference.

| Fruit, vegetables and herbs | Accessories | Heating function | Temperature in °C | Cooking time in hours |
|--|----------------|------------------|-------------------|-----------------------|
| Pomes (apple rings, 3 mm thick, 200 g per wire rack) | 1-2 wire racks | | 80 | 4-8 |
| Root vegetables (carrots), grated, blanched | 1-2 wire racks | | 80 | 4-7 |
| Sliced mushrooms | 1-2 wire racks | | 80 | 5-8 |
| Herbs, prepared | 1-2 wire racks | | 60 | 2-5 |

Preserving

You can preserve fruit and vegetables using your appliance.

Warning – Risk of injury!

If the food is preserved incorrectly, the preserving jars may burst. Follow the instructions for preserving.

Jars

Only use clean and undamaged preserving jars. Only use heat-resistant, clean and undamaged rubber rings. Check clips and clamps in advance.

For each preserving process, only use preserving jars that are the same size and contain the same food. In the cooking compartment, you can preserve the contents of a maximum of six ½, 1 or 1½-litre preserving jars at the same time. Do not use jars that are larger or taller than this. The lids could rupture.

Preserving jars must not touch one another in the cooking compartment during the preserving process.

Preparing fruit and vegetables

Only use fruit and vegetables that are in good condition. Wash them thoroughly.

Peel, core and chop fruit and vegetables appropriate to their type and fill the preserving jars with them up to approx. 2 cm below the rim.

Fruit: Fill the preserving jars with the fruit along with a hot, skimmed sugar solution (approx. 400 ml for a 1-litre jar). For one litre of water:

- Approx. 250 g sugar for sweet fruit
- Approx. 500 g sugar for sour fruit

Vegetables: Fill the jars with the vegetables along with hot, boiled water.

Wipe the rims of the jars, as they must be clean. Place a damp rubber ring and a lid on each jar. Seal the jars with the clips. Place the jars into the universal pan so that they do not touch each other. Pour 500 ml hot water (approx. 80 °C) into the universal pan. Use the settings indicated in the table.





Ending the preserving process

Fruit: After a short while, small bubbles will form at short intervals. Switch off the appliance once all preserving jars are bubbling. Remove the jars from the cooking compartment after the indicated residual heating time.

Vegetables: After a short while, small bubbles will form at short intervals. As soon as all preserving jars are bubbling, reduce the temperature to 120 °C and allow the jars to continue to bubble in the closed cooking compartment as indicated in the table. After this time has elapsed, switch off the appliance and make use of the residual heat for several minutes as indicated in the table.

After preserving, remove the jars from the cooking compartment and place them onto a clean cloth. Do not place these hot jars onto a cold or damp surface, as they may crack. Cover the preserving jars to protect them from draughts. Only remove the clamps once the jars are cold.

The indicated times in the settings table are average values for preserving fruit and vegetables. They may be influenced by room temperature, the number of jars, quantity, heat and quality of the jar contents. The specifications are based on 1-litre round jars. Before you switch off the appliance or change the cooking mode, check whether the contents of the jars are bubbling as they should. The bubbling process starts after approx. 30-60 minutes.

| Meal | Accessory/cookware | Shelf position | Type of heating | Step | Temperature in °C | Cooking time in mins |
|-------------------------------------|-------------------------|----------------|---|------|-------------------|----------------------------------|
| Vegetables, e.g. carrots | 1-litre preserving jars | 1 |  | 1. | 160-170 | Before it starts bubbling: 30-40 |
| | | | | 2. | 120 | Once it starts bubbling: 30-40 |
| | | | | 3. | - | Residual heat: 30 |
| Vegetables, e.g. cucumbers | 1-litre preserving jars | 1 |  | 1. | 160-170 | Before it starts bubbling: 30-40 |
| | | | | 2. | - | Residual heat: 30 |
| Stone fruit, e.g. cherries, damsons | 1-litre preserving jars | 1 |  | 1. | 160-170 | Before it starts bubbling: 30-40 |
| | | | | 2. | - | Residual heat: 35 |
| Pomes, e.g. apples, strawberries | 1-litre preserving jars | 1 |  | 1. | 160-170 | Before it starts bubbling: 30-40 |
| | | | | 2. | - | Residual heat: 25 |

Prove dough

Your yeast dough will prove considerably more quickly using this heating function than at room temperature and will not dry out. Do not start the appliance if the cooking compartment is not completely cool.

Always allow yeast dough to prove twice. Use the settings indicated in the settings tables for the first and second proving stages (dough fermentation stage and final fermentation stage).

Dough fermentation

Place the dough into a heat-resistant bowl and place this onto the wire rack. Use the settings indicated in the table.

Do not open the appliance door while the dough is proving, otherwise moisture will escape. Do not cover the dough.

| Dish | Accessories/cookware | Shelf position | Type of heating | Step | Temperature in °C | Cooking time in mins |
|-----------------------------|-------------------------|----------------|-----------------|------|-------------------|----------------------|
| Yeast dough, light | Bowl | 2 | ≡ | 1. | 35-40 | 25-30 |
| | Baking tray | 2 | ≡ | 2. | 35-40 | 10-20 |
| Yeast dough, heavy and rich | Bowl | 2 | ≡ | 1. | 35-40 | 60-75 |
| | Heat-resistant cookware | 2 | ≡ | 2. | 35-40 | 45-60 |

Keeping warm

You can keep cooked dishes warm using the top/bottom heating type at 70 °C. This will avoid condensation developing, and means you will not have to wipe out the cooking compartment.

Do not keep cooked dishes warm for longer than two hours. Be aware that some dishes may continue cooking whilst being kept warm. Cover the dishes if necessary.

Test dishes

These tables have been produced for test institutes to facilitate appliance testing.

As per EN 60350-1.

Baking

Items that are placed in the oven on baking trays or in baking tins/dishes at the same time will not necessarily be ready at the same time.

Shelf positions for baking on two levels:

- Universal pan: Position 3
Baking tray: Position 1
- Baking tins/dishes on the wire rack
First wire rack: Position 3
Second wire rack: Position 1

Shelf positions for baking on three levels:

- Baking tray: Position 4
- Universal pan: Position 3
- Baking tray: Position 1

Baking with two springform tins:

- On one level (figure 1)
- On two levels (figure 2)

Condensation builds up during the proving process, which steams up the door panel. Wipe out the cooking compartment after dough proving. Remove any limescale with a little vinegar and wipe with clean water.

Final fermentation

Place your dough into the oven at the shelf position indicated in the table.

If you want to preheat the oven, the final fermentation stage takes place outside the appliance in a warm place.

The temperature and proving time are dependent on the type and quantity of the ingredients. For this reason, the values indicated in the settings table are intended as a guide only.

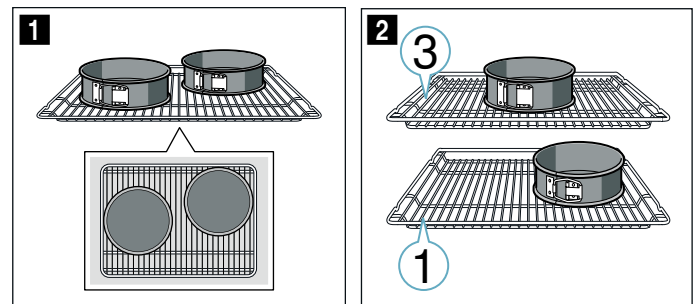

Notes

- The setting values apply to dishes placed into a cold cooking compartment.
- Please note the information in the tables about preheating. The setting values are valid without rapid heating-up.
- For baking, use the lower of the indicated temperatures first.

Grilling

Also slide in the universal pan. The liquid will be caught and the cooking compartment stays cleaner.

Baking

| Food | Dish | Shelf position | Type of heating | Temperature in °C / Grill setting | Time in minutes |
|-------------------------------------|------------------------------|----------------|-----------------|-----------------------------------|-----------------|
| Shortbread | Baking tray | 3 | ≡ | 140 - 150** | 25 - 35 |
| Shortbread | Baking tray | 3 | ⌘ | 140 - 150** | 20 - 30 |
| Shortbread, 2 levels | Universal pan + Baking tray | 3+1 | ⌘ | 140 - 150** | 25 - 35 |
| Shortbread, 3 levels | Baking trays + Universal pan | 4+3+1 | ⌘ | 130 - 140** | 35 - 55 |
| Small Cakes | Baking tray | 3 | ≡ | 150** | 25 - 35 |
| Small Cakes | Baking tray | 3 | ⌘ | 140** | 25 - 35 |
| Small Cakes, 2 levels | Universal pan + Baking tray | 3+1 | ⌘ | 140** | 30 - 40 |
| Small Cakes, 3 levels | Baking trays + Universal pan | 4+3+1 | ⌘ | 140** | 30 - 40 |
| Fatless sponge cake | 26 cm springform cake tin | 2 | ≡ | 160 - 170* | 25 - 35 |
| Fatless sponge cake | 26 cm springform cake tin | 2 | ⌘ | 160 - 170 | 30 - 35 |
| Fatless sponge cake, 2 levels | 26 cm springform cake tin | 3+1 | ⌘ | 150 - 160* | 35 - 50 |
| Double-crust ed apple pie | 2 x 20 cm black cake tins | 2 | ⌘ | 160 - 180 | 65 - 85 |
| Double-crust ed apple pie | 2 x 20 cm black cake tins | 1 | ≡ | 190 - 210 | 60 - 70 |
| Double-crust ed apple pie, 2 levels | 2 x 20 cm black cake tins | 3+1 | ⌘ | 160 - 180 | 70 - 90 |
| Grilling white bread | Wire rack | 4 | ⋈ | int/⋈ | 5 - 6 |
| Beef burger, 12 pieces | Wire rack | 4 | ⋈ | int/⋈ | 25 - 30*** |

* Preheat; do not use rapid heat-up function.

** Preheat 5 mins; do not use rapid heat-up function.

*** Turn after 2/3 of total time; slide in the universal pan underneath the wire rack.



REGISTER YOUR PRODUCT
ONLINE NEFF-HOME.COM



Constructa NEFF Vertriebs-GmbH |
Carl-Wery-Straße 34 | 81739 Munich | Germany

9001462317
000225
en