



**BOSCH**



**Register** your  
new device on  
MyBosch now and  
get free benefits:  
**[bosch-home.com/  
welcome](https://bosch-home.com/welcome)**

# Built-in oven

**CSG656B.7B**



**[en]** Instruction manual

Built-in oven



# Table of contents

|   |           |   |           |
|---|-----------|---|-----------|
|  <b>Intended use</b> . . . . .                      | <b>4</b>  | Defrosting . . . . .  | 18        |
|  <b>Important safety information</b> . . . . .      | <b>5</b>  | Filling the water tank . . . . .  | 19        |
| General information . . . . .   | 5         | After every steam operation . . . . .   | 20        |
| Steam . . . . .   | 5         |  <b>Time-setting options</b> . . . . . | <b>21</b> |
| Cleaning function . . . . .   | 6         | Setting the cooking time . . . . .  | 21        |
|  <b>Causes of damage</b> . . . . .                  | <b>6</b>  | Setting the end time . . . . .  | 21        |
| General information . . . . .   | 6         | Setting the timer . . . . .   | 22        |
| Steam . . . . .   | 6         |  <b>Childproof lock</b> . . . . .      | <b>22</b> |
|  <b>Environmental protection</b> . . . . .          | <b>7</b>  | Activating and deactivating . . . . .   | 22        |
| Saving energy . . . . .   | 7         |  <b>Basic settings</b> . . . . .       | <b>23</b> |
| Environmentally-friendly disposal . . . . .   | 7         | Changing the basic settings . . . . .   | 23        |
|  <b>Getting to know your appliance</b> . . . . .    | <b>8</b>  | List of basic settings . . . . .  | 23        |
| Control panel . . . . .   | 8         | Power cut . . . . .   | 23        |
| Controls . . . . .  | 8         | Changing the time . . . . .   | 23        |
| Display . . . . .   | 9         |  <b>Sabbath mode</b> . . . . .         | <b>24</b> |
| Operating modes . . . . .   | 9         | Starting Sabbath mode . . . . .   | 24        |
| Types of heating . . . . .  | 10        |  <b>Home Connect</b> . . . . .         | <b>24</b> |
| Steam . . . . .   | 11        | Setting up . . . . .  | 24        |
| Further information . . . . .   | 11        | Remote Start . . . . .  | 24        |
| Cooking compartment functions . . . . .   | 11        | Home Connect settings . . . . .   | 25        |
| Water tank . . . . .  | 11        | Remote diagnostics . . . . .  | 25        |
|  <b>Accessories</b> . . . . .                     | <b>12</b> | About data protection . . . . .   | 25        |
| Accessories included . . . . .  | 12        | Declaration of Conformity . . . . .   | 25        |
| Inserting accessories . . . . .   | 12        |  <b>Cleaning agent</b> . . . . .     | <b>26</b> |
| Optional accessories . . . . .  | 13        | Suitable cleaning agents . . . . .  | 26        |
|  <b>Before using for the first time</b> . . . . . | <b>14</b> | Surfaces in the cooking compartment . . . . .   | 27        |
| Before using for the first time . . . . .   | 14        | Keeping the appliance clean . . . . .   | 27        |
| Initial use . . . . .   | 14        |  <b>Cleaning function</b> . . . . .  | <b>27</b> |
| Calibrating the appliance and cleaning the cooking compartment . . . . .  | 14        | EcoClean . . . . .  | 27        |
| Cleaning the accessories . . . . .  | 15        | Descaling . . . . .   | 28        |
|  <b>Operating the appliance</b> . . . . .         | <b>15</b> |  <b>Rails</b> . . . . .              | <b>29</b> |
| Switching the appliance on and off . . . . .  | 15        | Detaching and refitting the rails . . . . .   | 29        |
| Starting the operation . . . . .  | 15        |  <b>Appliance door</b> . . . . .     | <b>30</b> |
| Selecting an operating mode . . . . .   | 16        | Detaching and refitting the appliance door . . . . .  | 30        |
| Setting the type of heating and temperature . . . . .   | 16        | Fitting and removing the glass panels . . . . .   | 31        |
| Rapid heating . . . . .   | 16        |  <b>Trouble shooting</b> . . . . .   | <b>33</b> |
|  <b>Steam</b> . . . . .                           | <b>17</b> | Rectifying faults yourself . . . . .  | 33        |
| Noise . . . . .   | 17        | Maximum operating time . . . . .  | 34        |
| Steaming . . . . .  | 17        | Cooking compartment bulbs . . . . .   | 34        |
| Steam baking – Steam-assisted cooking . . . . .   | 17        |  <b>Customer service</b> . . . . .   | <b>35</b> |
| Reheating . . . . .   | 18        | E number and FD number . . . . .  | 35        |
| Dough proving setting . . . . .   | 18        |   |           |

|  |           |
|--|-----------|
|  <b>Dishes</b> .....                               | <b>35</b> |
| Information on the settings .....  | 35        |
| Selecting a dish .....   | 36        |
| Applying settings for dishes .....   | 36        |
|  <b>Tested for you in our cooking studio</b> ..... | <b>37</b> |
| Silicone moulds .....  | 37        |
| Baking .....   | 37        |
| Roasting and braising .....  | 40        |
| Grilling .....   | 43        |
| Convenience products .....   | 46        |
| Steaming .....   | 48        |
| Yogurt .....   | 50        |
| Eco heating functions .....  | 50        |
| Acrylamide in foodstuffs .....   | 52        |
| Slow cook .....  | 52        |
| Drying .....   | 53        |
| Preserving and juicing .....   | 54        |
| Sterilising bottles and hygiene .....  | 55        |
| Allowing the dough to prove at dough proving setting. .  | 55        |
| Defrosting .....   | 56        |
| Reheating .....  | 57        |
| Keeping warm .....   | 58        |
| Test dishes .....  | 58        |

Additional information on products, accessories, replacement parts and services can be found at [www.bosch-home.com](http://www.bosch-home.com) and in the online shop [www.bosch-eshop.com](http://www.bosch-eshop.com)

## Intended use

Read these instructions carefully. Only then will you be able to operate your appliance safely and correctly. Retain the instruction manual and installation instructions for future use or for subsequent owners.

This appliance is only intended to be fully fitted in a kitchen. Observe the special installation instructions.

Check the appliance for damage after unpacking it. Do not connect the appliance if it has been damaged in transport.

Only a licensed professional may connect appliances without plugs. Damage caused by incorrect connection is not covered under warranty.

This appliance is intended for domestic use only. The appliance must only be used for the preparation of food and drink. The appliance must be supervised during operation. Only use this appliance indoors.

This appliance is intended for use up to a maximum height of 2000 metres above sea level.

This appliance may be used by children over the age of 8 years old and by persons with reduced physical, sensory or mental capabilities or by persons with a lack of experience or knowledge if they are supervised or are instructed by a person responsible for their safety how to use the appliance safely and have understood the associated hazards.

Children must not play with, on, or around the appliance. Children must not clean the appliance or carry out general maintenance unless they are at least 15 years old and are being supervised.

Keep children below the age of 8 years old at a safe distance from the appliance and power cable.

Always slide accessories into the cooking compartment the right way round.

→ "Accessories" on page 12

## Important safety information

### General information

#### Warning – Risk of fire!

- Combustible items stored in the cooking compartment may catch fire. Never store combustible items in the cooking compartment. Never open the appliance door if there is smoke inside. Switch off the appliance and unplug it from the mains or switch off the circuit breaker in the fuse box.
- Loose food remnants, fat and meat juices may catch fire. Before using the appliance, remove the worst of the food remnants from the cooking compartment, heating elements and accessories.
- A draught is created when the appliance door is opened. Greaseproof paper may come into contact with the heating element and catch fire. Do not place greaseproof paper loosely over accessories during preheating. Always weight down the greaseproof paper with a dish or a baking tin. Only cover the surface required with greaseproof paper. Greaseproof paper must not protrude over the accessories.

#### Warning – Risk of burns!

- The appliance becomes very hot. Never touch the interior surfaces of the cooking compartment or the heating elements. Always allow the appliance to cool down. Keep children at a safe distance.
- Accessories and ovenware become very hot. Always use oven gloves to remove accessories or ovenware from the cooking compartment.
- Alcoholic vapours may catch fire in the hot cooking compartment. Never prepare food containing large quantities of drinks with a high alcohol content. Only use small quantities of drinks with a high alcohol content. Open the appliance door with care.

#### Warning – Risk of scalding!

- The accessible parts become hot during operation. Never touch the hot parts. Keep children at a safe distance.
- When you open the appliance door, hot steam can escape. Steam may not be visible, depending on its temperature. When opening, do not stand too close to the appliance. Open the appliance door carefully. Keep children away.

- Water in a hot cooking compartment may create hot steam. Never pour water into the cooking compartment when the cooking compartment is hot.

#### Warning – Risk of injury!

- Scratched glass in the appliance door may develop into a crack. Do not use a glass scraper, sharp or abrasive cleaning aids or detergents.
- The hinges on the appliance door move when opening and closing the door, and you may be trapped. Keep your hands away from the hinges.
- Components inside the appliance door may have sharp edges. Wear protective gloves.

#### Warning – Risk of electric shock!

- Incorrect repairs are dangerous. Repairs may only be carried out and damaged power cables replaced by one of our trained after-sales technicians. If the appliance is defective, unplug the appliance from the mains or switch off the circuit breaker in the fuse box. Contact the after-sales service.
- The cable insulation on electrical appliances may melt when touching hot parts of the appliance. Never bring electrical appliance cables into contact with hot parts of the appliance.
- Do not use any high-pressure cleaners or steam cleaners, which can result in an electric shock.
- A defective appliance may cause electric shock. Never switch on a defective appliance. Unplug the appliance from the mains or switch off the circuit breaker in the fuse box. Contact the after-sales service.

#### Warning – Hazard due to magnetism!

Permanent magnets are used in the control panel or in the control elements. They may affect electronic implants, e.g. heart pacemakers or insulin pumps. Wearers of electronic implants must stay at least 10 cm away from the control panel.

### Steam

#### Warning – Risk of scalding!

- The water in the water tank may become very hot if you continue to operate the appliance. Empty the water tank after every operation with steam.

- Hot steam is generated in the cooking compartment. Do not reach into the cooking compartment during any operation with steam.
- Hot liquid may spill over the sides of the accessory when it is removed from the cooking compartment. Remove hot accessories with care and always wear oven gloves.

**⚠ Warning – Risk of injury and risk of fire!**  
Flammable liquids can catch fire in the cooking compartment when it is hot (explosion). Do not fill the water tank with any flammable fluids (e.g. alcoholic drinks). Only fill the water tank with water or with the descaling solution that is recommended by us.

## Cleaning function

**⚠ Warning – Risk of burns!**  
⚠ The appliance becomes very hot on the outside during the cleaning function. Never touch the appliance door. Allow the appliance to cool down. Keep children at a safe distance.

## Causes of damage

### General information

#### Caution!

- Accessories, foil, greaseproof paper or ovenware on the cooking compartment floor: do not place accessories on the cooking compartment floor. Do not cover the cooking compartment floor with any sort of foil or greaseproof paper. Do not place ovenware on the cooking compartment floor if a temperature of over 50 °C has been set. This will cause heat to accumulate. The baking and roasting times will no longer be correct and the enamel will be damaged.
- Aluminium foil: Aluminium foil in the cooking compartment must not come into contact with the door glass. This could cause permanent discolouration of the door glass.
- Water in a hot cooking compartment: do not pour water into the cooking compartment when it is hot. This will cause steam. The temperature change can cause damage to the enamel.
- Moisture in the cooking compartment: Over an extended period of time, moisture in the cooking compartment may lead to corrosion. Allow the cooking compartment to dry after use. Do not keep moist food in the closed cooking compartment for extended periods of time. Do not store food in the cooking compartment.

- Cooling with the appliance door open: Following operation at high temperatures, only allow the cooking compartment to cool down with the door closed. Do not trap anything in the appliance door. Even if the door is only left open a crack, the front of nearby furniture may become damaged over time. Only leave the cooking compartment to dry with the door open if a lot of moisture was produced whilst the oven was operating.
- Fruit juice: when baking particularly juicy fruit pies, do not pack the baking tray too generously. Fruit juice dripping from the baking tray leaves stains that cannot be removed. If possible, use the deeper universal pan.
- Extremely dirty seal: If the seal is very dirty, the appliance door will no longer close properly during operation. The fronts of adjacent units could be damaged. Always keep the seal clean. Never operate the appliance if the seal is damaged or missing.
- Appliance door as a seat, shelf or worktop: Do not sit on the appliance door, or place or hang anything on it. Do not place any cookware or accessories on the appliance door.
- Inserting accessories: depending on the appliance model, accessories can scratch the door panel when closing the appliance door. Always insert the accessories into the cooking compartment as far as they will go.
- Carrying the appliance: do not carry or hold the appliance by the door handle. The door handle cannot support the weight of the appliance and could break.

## Steam

### Caution!

- Baking tins: Ovenware must be heat and steam resistant. Silicone baking tins are not suitable for combined operation with steam.
- Ovenware with areas of rust: Do not use any ovenware which displays areas of rust. Even the smallest spots of rust can lead to corrosion in the cooking compartment.
- Dripping liquids: When steaming with a perforated cooking container, always insert the baking tray, the universal pan or the solid cooking container underneath. Dripping liquid is caught.
- Hot water in the water tank: Hot water may damage the steam system. Only fill the water tank with cold water.
- Enamel damage: Do not start any operations when there is water on the cooking compartment floor. Before operation, wipe away the water from the cooking compartment floor.
- Descaling solution: Do not allow any descaling solution to come into contact with the control panel or other surfaces on the appliance. This damages the surfaces. If this does happen, remove the descaling solution immediately with water.
- Cleaning the water tank: Do not clean the water tank in the dishwasher. Otherwise, the water tank will be damaged. Clean the water tank with a soft cloth and standard washing-up liquid.



## Environmental protection

Your new appliance is particularly energy-efficient. Here you can find tips on how to save even more energy when using the appliance, and how to dispose of your appliance properly.

### Saving energy

- Only preheat the appliance if this is specified in the recipe or in the tables in the operating instructions.
- Leave frozen food to defrost before placing it in the cooking compartment.

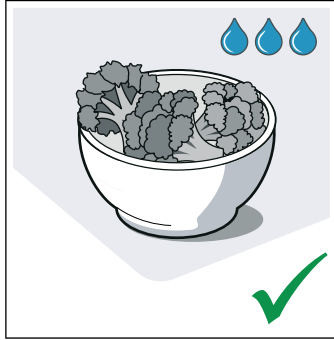
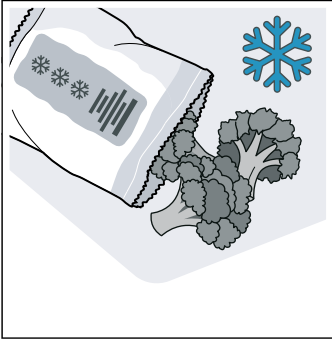

- Use baking tins that are dark-coloured, painted black or have an enamel coating. These absorb the heat particularly well.

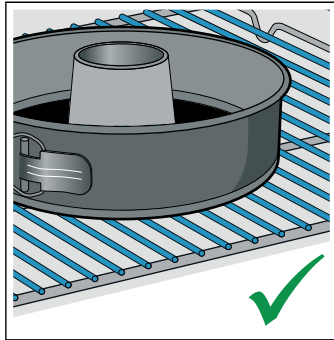
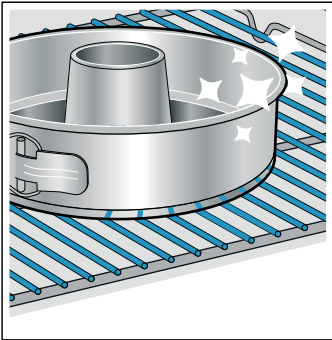

- Remove any unnecessary accessories from the cooking compartment.

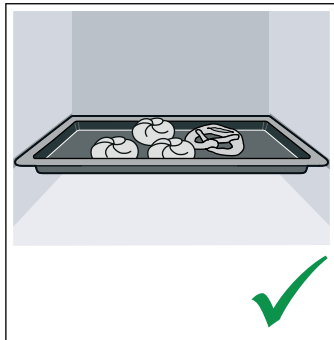
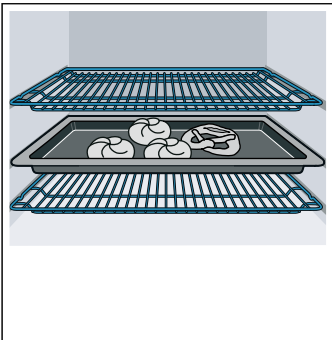

- Open the appliance door as infrequently as possible when the appliance is in use.

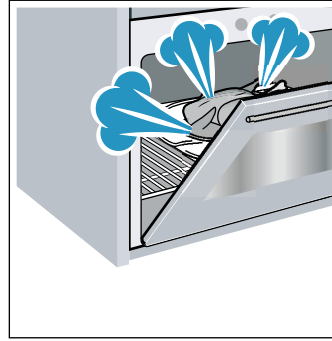

- It is best to bake several cakes one after the other. The cooking compartment stays warm. This reduces the baking time for the second cake. You can place two cake tins next to each other in the cooking compartment.

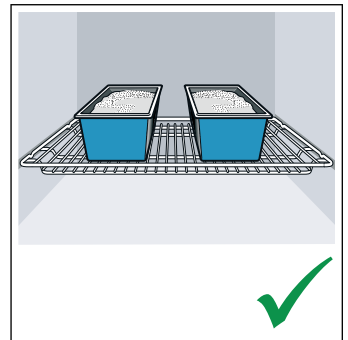
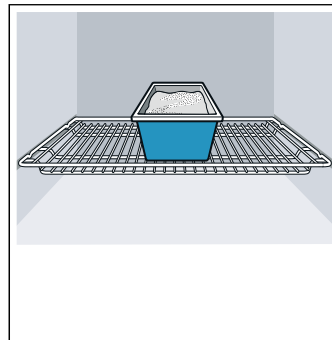

- For longer cooking times, you can switch the appliance off 10 minutes before the end of the cooking time and use the residual heat to finish cooking.

### Environmentally-friendly disposal

Dispose of packaging in an environmentally-friendly manner.



This appliance is labelled in accordance with European Directive 2012/19/EU concerning used electrical and electronic appliances (waste electrical and electronic equipment - WEEE). The guideline determines the framework for the return and recycling of used appliances as applicable throughout the EU.

## Getting to know your appliance

In this section, we will explain the indicators and controls. You will also find out about the various functions of your appliance.

**Note:** Depending on the appliance model, individual details and colours may differ.

### Control panel

In the control panel, you can use the various buttons, touch fields, touch-screen displays and the rotary selector to set the different appliance functions. The current settings are shown on the display.

The overview shows the control panel when the appliance is switched on with the menu display.

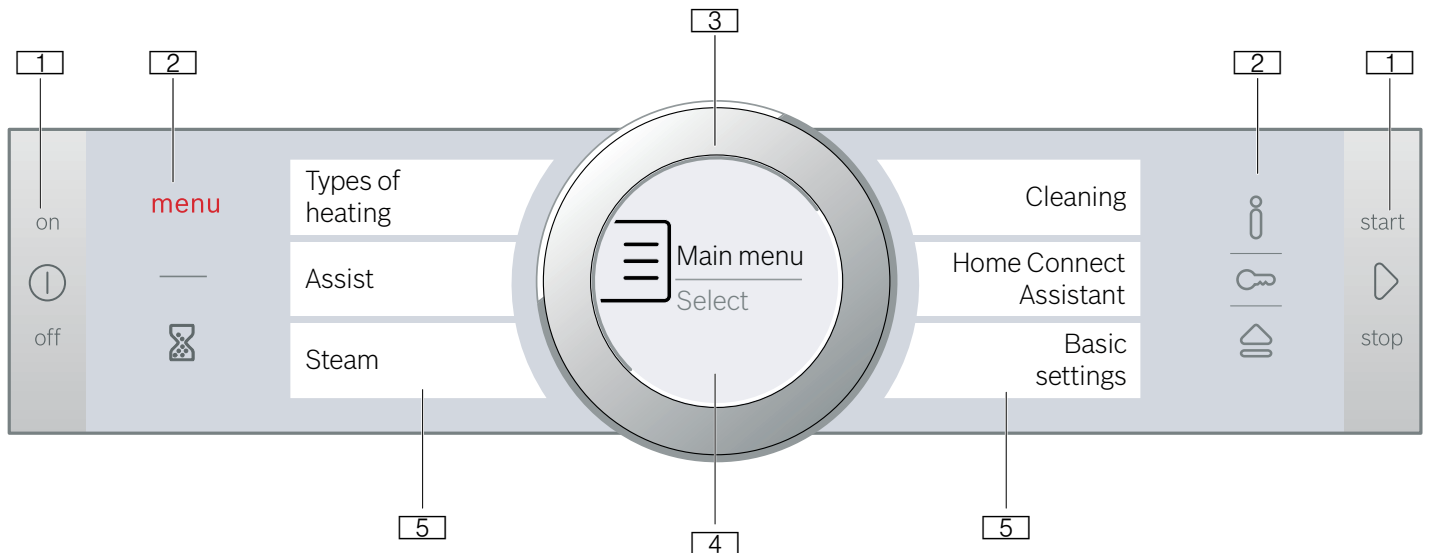

#### 1 Buttons

The buttons on the left- and right-hand side of the control panel have a pressure point. Press these buttons to activate them.

For appliances that do not have a stainless steel front, these two button touch fields do not have a pressure point.

#### 2 Touch fields

There are sensors under the touch fields. Simply touch the respective symbol to select the function.

#### 3 Rotary selector

The rotary selector is fitted so that you can turn it indefinitely to the left or right. Press it lightly and move it in the direction required using your finger.

#### 4 Display

You can see the current adjustment values, options or notes in the display.

#### 5 Touch-screen displays

You can see the current selection options in the touch-screen displays. You can select these here directly by touching the appropriate text field. The text fields change depending on the selection.

| Symbol              | Meaning         |  |
|---------------------|-----------------|--|
| <b>Buttons</b>      |                 |  |
| ⓘ                   | on/off          | Switching the appliance on and off   |
| ▶                   | Start/Stop      | Starting, pausing or cancelling (hold down for approx. 3 secs) an operation    |
| <b>Touch fields</b> |                 |  |
| <b>Menu</b>         | Menu            | Opens the "Operating modes" menu   |
| ⌚                   | Timer           | Selects the timer  |
| i                   | Information     | Displays information   |
| 🔑                   | Childproof lock | Activating and deactivating (hold down for approx. 4 secs) the childproof lock |
| 🏠                   | Open cover      | Filling or emptying the water tank   |

### Rotary selector

You can use the rotary selector to change the setting values shown on the display.

You can also use the rotary selector to scroll through the selection lists on the touch-screen displays.

In most selection lists, you have to turn the rotary selector in the opposite direction once you reach the beginning or the end of the list.

### Controls

The individual controls are adapted for the various functions of your appliance. You can set your appliance simply and directly.

### Buttons and touch fields

Here you can find a short explanation of the various buttons and touch fields.



## Display

The display is structured so that the information can be read at a glance in any situation.

The value that you can currently set is highlighted and displayed in white text. The value in the background is displayed in grey.

|             |  |
|-------------|--|
| Highlighted | The highlighted value can be changed directly without first being selected.<br>After starting an operation, either the temperature or the level is always highlighted. At the same time, the white line is the heating line and gradually turns red. |
| Enlarged    | Whilst you are changing the highlighted value using the rotary selector, only this value is enlarged on the display.   |

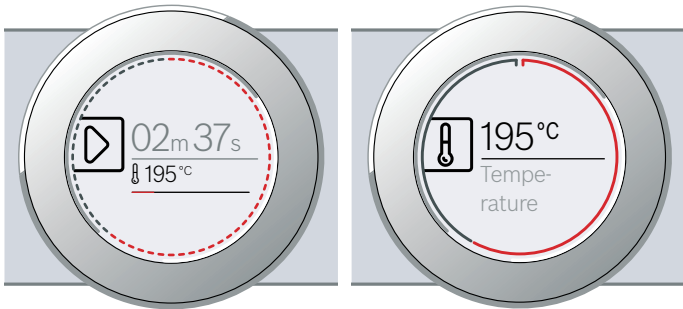

### Display ring

The display ring can be found around the outside of the display.

If you change a value, the display ring shows you where you are in the selection list. Depending on the settings area and length of the selection list, the display ring may be continuous or divided into segments.

During operation, the display ring turns red at second-long intervals. After every full minute, the segments turn red again from the beginning. As the cooking time counts down, one segment disappears every second.

### Temperature display

After the operation has started, the current cooking compartment temperature is displayed graphically on the display.

|                         |  |
|-------------------------|--|
| Heating line            | The white line under the temperature turns red from left to right as the cooking compartment heats up. When you are preheating the appliance, the optimal time to place the food in the cooking compartment is when the line has completely turned red.<br>For set levels, e.g. the grill setting, the heating line turns red immediately. |
| Residual heat indicator | When the appliance is switched off, the display ring shows the residual heat in the cooking compartment. As the residual heat cools down, the display ring becomes darker and disappears completely at some point.   |

**Note:** Due to thermal inertia, the temperature displayed may be slightly different to the actual temperature inside the oven.

## Touch-screen displays

The touch-screen displays are both a display medium and control element at the same time. They show the options that you can select for a function and the current setting. To select a function, simply touch the text field directly.

The function currently selected is identified by a red vertical bar next to it. Its corresponding value is highlighted in white on the display.

The small red arrow next to the text field shows the functions to which you can scroll forwards or backwards.



## Operating modes

Your appliance has various operating modes which make your appliance easier to use.

You can find more precise descriptions of these in the corresponding sections.

You can open the "Operating modes" menu by pressing the **menu** field.













| Operating mode  | Use   |
|---|---|
| Heating types<br>→ "Operating the appliance" on page 15 | There are various finely tuned heating types for the optimal preparation of your food.          |
| Assist<br>→ "Dishes" on page 35                         | For many dishes, there are pre-programmed setting values.                                       |
| Steam<br>→ "Steam" on page 17                           | There are various finely tuned steam types of heating for the optimal preparation of your food. |
| Cleaning<br>→ "Cleaning function" on page 27            | There are several cleaning functions available: EcoClean, Descaling and Drying.                 |
| Home Connect Assistant<br>→ "Home Connect" on page 24   | This function allows you to connect your oven with a mobile device.                             |
| Basic settings<br>→ "Basic settings" on page 23         | You can change your appliance's basic settings to suit your needs.                              |

## Types of heating

To make sure that you always use the right type of heating to cook your food, we have explained the differences and applications below.

The symbols for each type of heating help you to remember them.

For temperature settings above 275 °C and grill setting 3, the appliance reduces the temperature to approx. 275 °C or grill setting 1 after approx. 40 minutes.

| Type of heating   | Temperature  | Use   |
|---|--|---|
|  4D hot air *           | 30-250 °C  | For baking and roasting on one or more levels.<br>The fan distributes the heat from the ring heating element in the back panel evenly around the cooking compartment.   |
|  Top/bottom heating *   | 30-250 °C  | For traditional baking and roasting on one level. Especially suitable for cakes with moist toppings.<br>Heat is emitted evenly from the top and bottom.   |
|  Hot air eco            | 30-250 °C  | For gently cooking selected types of food on one level without preheating.<br>The fan distributes the heat from the ring-shaped heating element in the back panel around the cooking compartment.<br>This heating function is most effective between 125 and 250 °C.<br>This heating function is used to measure both the energy consumption in air recirculation mode and the energy efficiency class. |
|  Top/bottom heating eco | 30-250 °C  | For gently cooking selected types of food.<br>Heat is emitted from above and below.<br>This heating function is most effective between 150 and 250 °C.<br>This heating function is used to measure the energy consumption in the conventional mode.   |
|  Hot air grilling *   | 30-250 °C  | For roasting poultry, whole fish and larger pieces of meat.<br>The grill element and the fan switch on and off alternately. The fan circulates the hot air around the food.   |
|  Grill, large area    | Grill settings:<br>1 = low<br>2 = medium<br>3 = high | For grilling flat items for grilling, such as steaks and sausages, for making toast, and for cooking au gratin.<br>The whole area below the grill element becomes hot.  |
|  Grill, small area    | Grill settings:<br>1 = low<br>2 = medium<br>3 = high | For grilling small amounts of steaks or sausages, for making toast, and for cooking au gratin.<br>The centre area under the grill heating element becomes hot.  |
|  Pizza setting        | 30-250 °C  | For preparing pizza and dishes which require a lot of heat from underneath.<br>The bottom heating element and the ring heating element in the back panel heat up.   |
|  Slow cooking         | 70-120 °C  | For gentle and slow cooking of seared, tender pieces of meat in ovenware without a lid.<br>The heat is emitted evenly from the top and bottom at low temperatures.  |
|  Bottom heating       | 30-250 °C  | For cooking in a bain marie and for the final baking stage.<br>The heat is emitted from below.  |
|  Keeping warm *       | 60-100 °C  | For keeping cooked food warm.   |
|  Preheat ovenware     | 30-70 °C   | For preheating ovenware.  |





\* Possible to use steam for this type of heating (operation only possible when the water tank is full)

## Default values

For each heating type, the appliance specifies a default temperature or level. You can accept this value or change it in the appropriate area.

## Steam

To enable you to find the correct steam type of heating for your dish, we have explained the differences and scopes of application here.

| Type of heating  | Temperature | Use   |
|--|-------------|---|
|  Steaming      | 30-100 °C   | For vegetables, fish, side dishes, for juicing fruit and for blanching  |
|  Reheating     | 80-180 °C   | For plated meals and baked items<br>Cooked food is gently reheated. The steam ensures that the food does not dry out.                           |
|  Dough proving | 30-50 °C    | For yeast dough and sourdough<br>Dough will rise considerably more quickly than at room temperature. The surface of the dough does not dry out. |
|  Defrosting    | 30-60 °C    | For vegetables, meat, fish and fruit<br>The moisture gently transfers the heat to the food. The food does not dry out or lose its shape.        |

## Further information

In most cases, the appliance provides notes and further information on the action just carried out.

Touch the **i** field. The note is shown in the display for a few seconds. Use the rotary selector to scroll to the end of longer notes.

Some notes are displayed automatically, for example as confirmation, or to provide an instruction or warning.

## Cooking compartment functions

The functions in the cooking compartment make your appliance easier to use. This, for example, enables the cooking compartment to be well lit and a cooling fan to prevent the appliance from overheating.

### Opening the appliance door

If you open the appliance door during an on-going operation, the operation is paused. The operation continues to run when you close the door.

### Interior lighting

When you open the appliance door, the interior lighting switches on. If the door remains open for longer than around 15 minutes, the lighting switches off again.

For most operating modes, the interior lighting switches on as soon as the operation is started. When the operation has finished, the lighting switches off.

**Note:** You can set the interior lighting not to come on during the operation in the basic settings. → "Basic settings" on page 23

### Cooling fan

The cooling fan switches on and off as required. The hot air escapes above the door.

### Caution!

Do not cover the ventilation slots. Otherwise, the appliance may overheat.



So that the cooking compartment cools down more quickly after the operation, the cooling fan continues to run for a certain period afterwards.

**Note:** You can change how long the cooling fan continues to run in the basic settings. → "Basic settings" on page 23

## Water tank

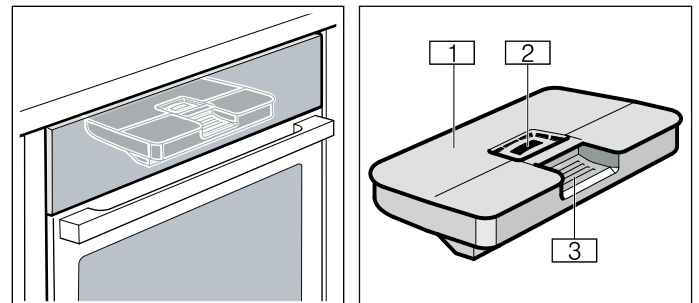
The appliance is fitted with a water tank. The water tank is behind the panel. For operations with steam, fill the water tank with water. → "Steam" on page 17





-  Tank cover
-  Filling opening
-  Handle for removing and inserting the water tank

## Accessories

Your appliance is accompanied by a range of accessories. Here, you can find an overview of the accessories included and information on how to use them correctly.

### Accessories included

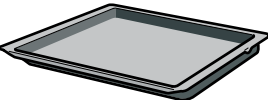
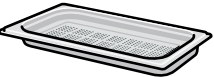
Your appliance is equipped with the following accessories:

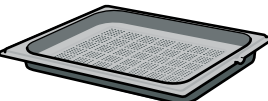
|   |  |
|---|--|
|    | <p><b>Wire rack</b><br/>For ovenware, cake tins and ovenproof dishes.<br/>For roasts, grilled items and frozen meals.</p>  |
|    | <p><b>Universal pan</b><br/>For moist cakes, other baked items, frozen meals and large roasts.<br/>It can be used to catch dripping fat when you are grilling directly on the wire rack. During operation with steam, it can also be used to catch drops of water.</p> |
|   | <p><b>Steam container, perforated, size S</b><br/>For steaming vegetables, juicing berries and defrosting.</p>   |
|  | <p><b>Steam container, unperforated, size S</b><br/>For cooking rice, pulses and cereals.</p>  |
|  | <p><b>Steam container, perforated, size XL</b><br/>For steaming large quantities.</p>  |

Only use genuine accessories. They are specially adapted for your appliance.

You can buy accessories from the after-sales service, from specialist retailers or online.

**Note:** The accessories may become deformed when they become hot. This does not affect their function. Once they cool down again, they regain their original shape.

**Note:** You can use the steam container with all heating modes involving steam without any restrictions. If you set other heating modes at high temperatures, take the steam container out of the cooking compartment. High temperatures can cause permanent deformations and discolouration of the steam container.

### Inserting accessories

The cooking compartment has three shelf positions. The shelf positions are counted from the bottom up.

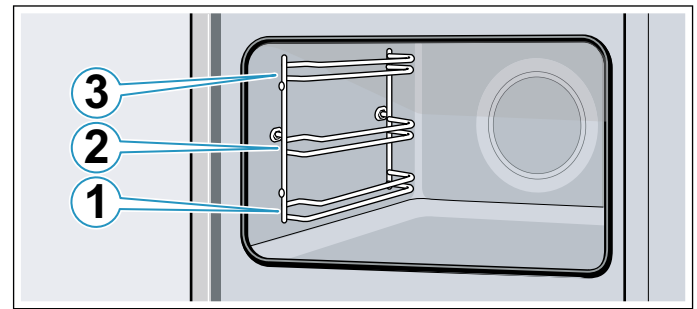

Always insert the accessory between the two guide rods for a shelf position.

The accessories can be pulled out approximately halfway without tipping.

#### Notes

- Ensure that you always insert the accessories into the cooking compartment the right way round.
- Always insert the accessories fully into the cooking compartment so that they do not touch the appliance door.

#### Locking function

The accessories can be pulled out approximately halfway until they lock in place. The locking function prevents the accessories from tilting when they are pulled out. The accessories must be inserted into the cooking compartment correctly for the tilt protection to work properly.

When inserting the wire rack, ensure that lug **a** is at the rear and is facing downwards. The open side must be facing the appliance door and the outer rail must be facing downwards.

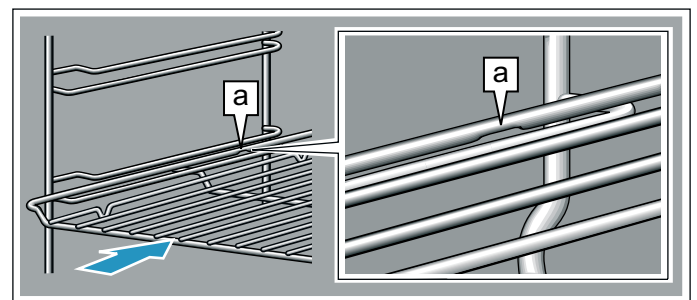

When inserting baking trays, make sure that the recess **a** is at the rear and is facing downwards. The sloping edge of the accessory **b** must be facing towards the appliance door.

Example in the picture: Universal pan

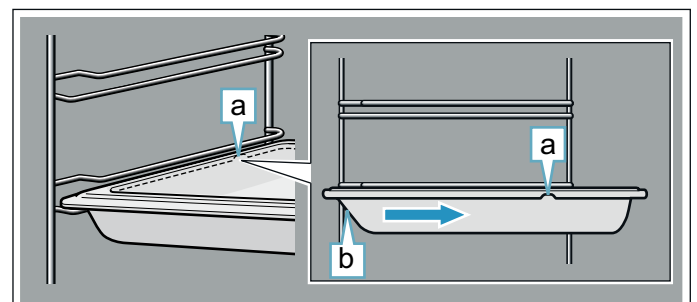

## Combining accessories

You can insert the wire rack and the universal pan at the same time to catch drops of liquid.

When inserting the wire rack, ensure that both spacers **a** are at the rear edge. When inserting the universal pan, the wire rack is on top of the upper guide rod of the shelf position.

Example in the picture: Universal pan

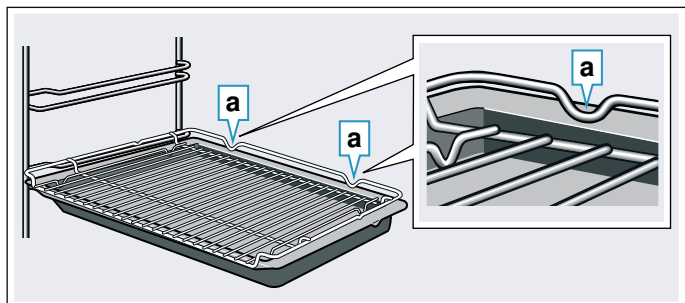

Small steam containers may only be placed in the cooking compartment with the wire rack.

## Optional accessories

You can buy optional accessories from the after-sales service, from specialist retailers or online. \*You will find a comprehensive range of products for your appliance in our brochures and online.

Both availability and whether it is possible to order online differ between countries. Please see your sales brochures for more details.

**Note:** Not all optional accessories are suitable for every appliance. When purchasing, please always quote the exact identification number (E-no.) of your appliance.

→ "Customer service" on page 35

### Special accessories

#### Wire rack

For ovenware, cake tins and ovenproof dishes, and for roasts and grilled food.

#### Universal pan

For moist cakes, pastries, frozen meals and large roasts.

It can be used to catch dripping fat when you are grilling directly on the wire rack.

#### Baking tray

For tray bakes and small baked products.

#### Wire insert

For meat, poultry and fish.

For inserting into the universal pan to catch dripping fat and meat juices.

#### Universal pan, non-stick

For moist cakes, pastries, frozen meals and large roasts.

Pastries and roasts can be removed more easily from the universal pan.

#### Baking tray, non-stick

For tray bakes and small baked products.

The pastries can be removed more easily from the baking tray.

#### Profi pan

For preparing large quantities.

#### Lid for the Profi pan

The lid turns the Profi pan into a Profi roasting dish.

#### Pizza tray

For pizzas and large round cakes.

#### Grill tray

Use for grilling in place of the wire rack or as a splatter guard. Only use in the universal pan.

#### Bread-baking stone

For home-made bread, bread rolls and pizzas that require a crispy base.

The baking stone must be preheated to the recommended temperature.

#### Glass roasting dish (5.1 litres)

For stews and bakes.

Particularly suitable for the "Meals" operating mode.

#### Glass tray

For large roasts, moist cakes and bakes.

#### Steam container, perforated, size XL

For steaming large quantities.

#### Steam container, perforated, size S

For steaming vegetables, juicing berries and defrosting.

#### Steam container, solid, size S

For cooking rice, pulses and cereals.

#### Porcelain cooking container, solid, size S

For steaming and serving meat, fish and vegetables.

#### Porcelain cooking container, solid, size L

For steaming and serving meat, fish and vegetables.

#### Pull-out system, 1 level

The pull-out rails at level 1 allow you to pull the accessories out further without them tipping.

#### Decorative trims

For concealing the lower shelf of the unit and the base of the appliance.





## Before using for the first time

Before you can use your new appliance, you must make some settings. You must also clean the cooking compartment and accessories.

### Before using for the first time

Before using the appliance for the first time, ask your water supplier about the hardness of your tap water.

To ensure that the appliance can reliably remind you to descale it when required, you must set your water hardness range correctly.

#### Caution!

- The appliance may become damaged due to the use of unsuitable liquids.  
Do not use distilled water, highly chlorinated tap water (>40 mg/l) or other liquids.  
Only use cold, fresh tap water, softened water or non-carbonated mineral water.
- Malfunctions may occur when using filtered or demineralised water.  
The appliance may request that you top up the water tank even though it may be full, or operation with steam is cancelled after approx. two minutes.  
If required, mix filtered or demineralised water with the bottled non-carbonated mineral water with a ratio of one to one.

#### Notes

- If your water is very hard, we recommend that you use softened water.
- If you only use softened water, you can set the water hardness range to "softened".
- If you use mineral water, set the water hardness range to "4 very hard".
- If you use mineral water, you must only use non-carbonated mineral water.

| Water hardness range | Setting      |
|----------------------|--------------|
| 0                    | 00 softened  |
| 1 (up to 1.3 mmol/l) | 01 soft      |
| 2 (1.3 - 2.5 mmol/l) | 02 medium    |
| 3 (2.5 - 3.8 mmol/l) | 03 hard      |
| 4 (above 3.8 mmol/l) | 04 very hard |

### Initial use

After connecting the appliance to the power or following a power cut, the settings for initial use are shown on the display. It may take a few seconds for the instruction to appear.

**Note:** You can change these settings at any time in the basic settings. → *"Basic settings"* on page 23

### With HomeConnect

You can apply the initial settings on the appliance or with Home Connect on your mobile device.

1. Touch the "With Home Connect" text field.
2. Follow the instructions in the "Home Connect" section. → *"Home Connect"* on page 24

### On the appliance

Apply the following initial settings on the appliance:

#### Setting the language

The language is the first setting displayed. "German" is the preset language.

1. Turn the rotary selector to set the required language.
2. Touch the next text field to confirm.  
The next setting appears.

#### Setting the clock

The clock starts at "12:00".

1. Touch the "Clock" text field.
2. Set the clock using the rotary selector.
3. Touch the next text field to confirm.  
The next setting appears.

#### Setting the water hardness

The default water hardness setting is "very hard".

1. Use the rotary selector to set the water hardness.
2. Touch the "Complete the settings" text field to confirm.

A note appears in the display confirming that the initial use has been completed.

Switch the appliance off using the  On/Off button if you do not need to use it.

### Calibrating the appliance and cleaning the cooking compartment

The boiling point of water depends on the air pressure. During calibration, the appliance self-adjusts to the pressure ratio at the installation location. This will happen automatically the first time steam-assisted cooking is used. This produces a lot of steam.

#### Preparing the appliance for calibration

1. Remove the accessories from the cooking compartment.
2. Remove any leftover packaging, such as polystyrene pellets, from the cooking compartment.
3. Before calibrating the appliance, wipe the smooth surfaces in the cooking compartment with a soft, damp cloth.

### Calibrating the appliance and cleaning the cooking compartment

#### Notes

- Calibration cannot be started until the cooking compartment is cold (room temperature).
- Do not open the appliance door while calibration is in progress, as this will abort the calibration process.

1. Press the on/off button  to switch on the appliance.
2. Fill the water tank. → *"Filling the water tank"* on page 19



3. Set the specified type of heating, temperature and duration for the calibration, then start the appliance. → "Steaming" on page 17

| Settings        |   |
|-----------------|---|
| Type of heating | Steam  |
| Temperature     | 100 °C  |
| Cooking time    | 30 minutes  |

4. Heat up the appliance following calibration.

**Caution!**  
**Enamel damage**

Do not use the appliance if there is water on the cooking compartment floor. Before using the appliance, wipe away the water from the cooking compartment floor.

5. Dry the cooking compartment floor.  
6. Set the specified type of heating and temperature for heating, then start the appliance. → "Operating the appliance" on page 15

| Heating up      |  |
|-----------------|--|
| Type of heating | 4D hot air  |
| Temperature     | Maximum  |
| Cooking time    | 30 minutes   |

7. Keep the kitchen ventilated while the appliance is heating.  
8. Stop the appliance once the specified time has elapsed. Press the on/off button  to switch off the appliance.  
9. Wait for the cooking compartment to cool down.  
10. Clean the smooth surfaces with soapy water and a dish cloth.  
11. Empty the water tank and dry the cooking compartment. → "After every steam operation" on page 20

**Notes**

- When relocating the appliance, restore its factory settings once it is installed so that it can adapt to its new location. Repeat the procedures for initial start-up and calibration.
- The appliance retains the calibration settings, even in the event of a power cut or disconnection from the mains. Calibration does not need to be repeated.

**Cleaning the accessories**

Clean the accessories thoroughly using soapy water and a dish cloth or soft brush.

## Operating the appliance

You have already learnt about the controls and how they work. Now we will explain how to set your appliance. You will learn about what happens when you switch the appliance on and off, and how to select the operating mode.

### Switching the appliance on and off

Before you are able to set the appliance, you must switch it on.

**Note:** The childproof lock and the timer can also be set when the appliance is switched off. Certain displays and notes, such as those relating to the residual heat in the cooking compartment, remain visible on the display after the appliance has been switched off.

Switch off your appliance when you do not need to use it. If no settings are applied for a long time, the appliance switches itself off automatically.

#### Switching on the appliance

Press the  On/Off button to switch on the appliance. The Bosch logo appears on the display, followed by the selection list for the types of heating.

**Note:** In the basic settings, you can specify which operating mode should appear after the appliance is switched on. → "Basic settings" on page 23

#### Switching off the appliance

Press the  On/Off button to switch off the appliance. Any functions that may be running are cancelled. The time, or if applicable, the residual heat indicator, appears on the display.

**Note:** You can set whether or not the time should be displayed when the appliance is switched off in the basic settings. → "Basic settings" on page 23

### Starting the operation

You must press the  Start/Stop button to start each operation.

After starting the appliance, the time display is shown on the display along with the settings. The display ring and the heating line also appear.

#### Pausing the operation

You can also interrupt and then continue an operation using the  Start/Stop button.

If you press and hold the  Start/Stop button for approx. 3 seconds, the operation is cancelled and all settings are reset.

**Note:** The fan may continue to run after an operation has been paused or cancelled.

## Selecting an operating mode

Once the appliance is switched on, the default operating mode is displayed.

If you would like to select a different operating mode, you can do so using the menu. You can find detailed descriptions of the individual operating modes in the corresponding sections.

The following always applies:

1. Touch the appropriate text field. The function is highlighted.
2. Turn the rotary selector to change the highlighted selection.
3. If necessary, apply other settings. To do this, touch the appropriate text field and change the value using the rotary selector.
4. Press the ▷ Start/Stop button to start. The appliance starts the operation.

## Setting the type of heating and temperature

If the "Types of heating" operating mode has not been selected, touch the "Types of heating" text field in the menu. The selection list for the types of heating appears on the touch-screen displays.

Example in the picture: Hot air eco  at 195 °C.

1. Touch the text field with the required type of heating. If necessary, scroll through the selection list using the rotary selector.

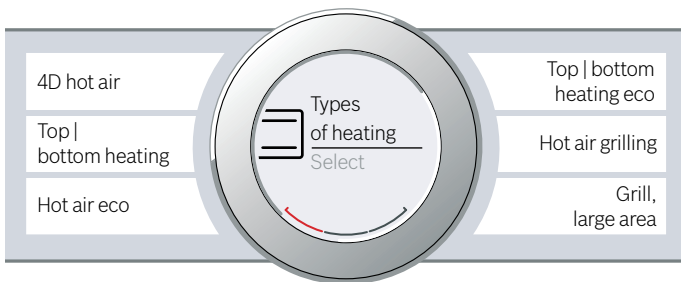

The temperature is highlighted white.

2. Set the temperature using the rotary selector.

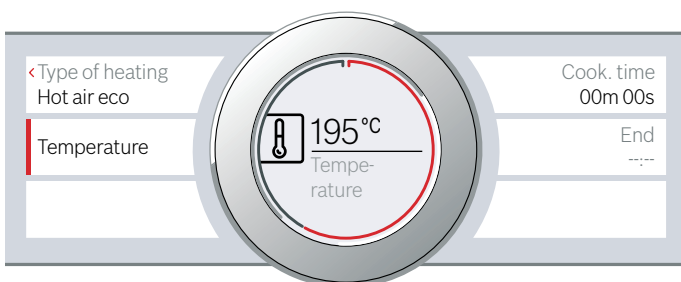

3. Press the ▷ Start/Stop button to start. The time on the display shows how long the operation has already been running.

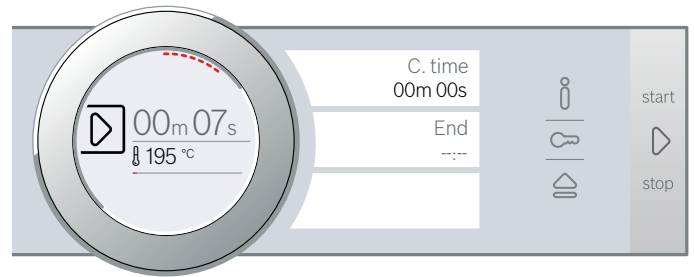

The appliance begins to heat up.

When your dish is ready, switch off the appliance using the ⏻ On/Off button.

**Note:** You can also set the cooking time and an end time for the operation on the appliance. → "Time-setting options" on page 21

## Changing

After starting the appliance, the temperature is highlighted. When you move the rotary selector, the temperature is changed and applied immediately.



To change the type of heating, first use the ▷ Start/Stop button to interrupt the operation and then touch the "Type of heating" text field. The selection list is displayed. Touch the required type of heating. The corresponding default temperature appears on the display.

**Note:** When you change the type of heating, the other settings are also reset.

## Rapid heating

With Rapid heating, you can shorten the heat-up time for some heating types.

The heating types suitable for Rapid heating are:

-  4D hot air
-  Top/bottom heating

To achieve an even cooking result, do not place your food or accessories into the cooking compartment until "Rapid heating" is complete.

## Applying settings

Ensure you have selected a suitable type of heating and set a temperature of at least 100 °C. Otherwise, rapid heating cannot be activated.

1. Set the type of heating and temperature.
2. Touch the "Rapid heating" text field. "On" is displayed in the text field. A confirmation message appears on the display.

When rapid heating comes to an end, an audible signal sounds and a message appears on the display. "Off" is displayed in the text field. Place your dish in the cooking compartment.

**Note:** The "Cooking time" time-setting option starts at the same time as rapid heating. Therefore, only set a cooking time when rapid heating has come to an end.

### Cancelling

To cancel the rapid heating, touch the "Rapid heating" text field again. "Off" is displayed in the text field.

## Steam

Food can be cooked particularly gently using steam. With some heating modes, you can prepare food with steam assistance. In addition, the Dough proving, Defrost and Reheat heating modes are available.

### Warning – Risk of scalding!

When you open the appliance door, hot steam can escape. Steam may not be visible, depending on its temperature. When opening, do not stand too close to the appliance. Open the appliance door carefully. Keep children away.

### Noise

#### Pump

You will hear a humming noise while the pump is in operation and after switching it off. This noise is caused by the pump function test. It is a normal operating noise.

#### Control panel

You will hear a humming or clicking noise when opening the control panel. These noises are caused by the control panel being pushed out. They are normal operating noises.

### Steaming

During steaming, hot steam surrounds the food and therefore prevents loss of nutrients from the food. The shape, colour and typical aroma of the dishes are retained as a result of this preparation method.

**Note:** If the water tank runs dry during steaming, operation is interrupted. Fill the water tank.

### Starting

1. Fill the water tank.  
**Note:** Only switch on steaming once the cooking compartment has cooled down completely (to room temperature).
2. Touch the **Menu** field.  
The list of operating modes is displayed.
3. Touch the "Steaming" text field.
4. Touch the "Steaming" text field.  
The temperature is in focus.
5. Turn the rotary selector to set the temperature.
6. Touch the "Duration" text field and set the duration.  
**Note:** A duration is always required for the steam types of heating.

7. Press the  Start/Stop button to start.  
The appliance begins to heat up.

Once the cooking time has elapsed, an audible signal sounds. The appliance stops heating up. The duration 00 m 00 s is shown on the display.

When your dish is ready, use the  On/Off button to switch off the appliance.

### Changing

You can change the settings as usual.

To change the temperature or the duration, touch the corresponding text field and change using the rotary selector. The change is adopted immediately.

To change the type of heating, interrupt the operation beforehand using the  Start/Stop button.

### Menu cooking

With steam, you can cook a whole menu at once, without the different flavours mixing. → "Tested for you in our cooking studio" on page 37

### Steam baking – Steam-assisted cooking

When you cook with steam assistance, steam is introduced into the cooking compartment at various intervals and with varying degrees of intensity. This gives you a better cooking result.

Your food

- Becomes crispy on the outside
- Develops a shiny surface
- Is succulent and tender on the inside
- Only undergoes a minimum reduction in volume

You set the type of heating and steam intensity combination that you want. Use the information in the tables to select a suitable type of heating and steam intensity, or select a programme.





### Steam intensity

Different intensity levels are available when adding steam:

| Intensity | Setting |
|-----------|---------|
| Low       | 01      |
| Medium    | 02      |
| High      | 03      |

### Suitable types of heating

You can switch on steam assistance for these types of heating:

- 4D hot air 
- Top/bottom heating 
- Hot air grilling 
- Keeping warm 

### Starting

1. Fill the water tank.
2. Set the type of heating and temperature.
3. Touch the "Added steam" text field.  
In the display, the steam level is displayed in white and in focus.

- Turn the rotary selector to set the steam level.
- Press the  Start/Stop button to start. The appliance begins to heat up.

**Note:** If the water tank runs dry during an operation with steam assistance, a message appears on the display prompting you to fill up the water tank. The operation continues without adding steam.

### Changing and cancelling

To change the steam level, touch the "Steam level" text field. The steam level is highlighted, and can be changed using the rotary selector. The change is adopted immediately.

If you want to cancel steam assistance, reset the "Added steam" to "0".

**Note:** The operation continues without adding steam.

### Reheating

With the "Reheating 

" type of heating, you can gently reheat food that has already been cooked or crisp up day-old baked goods. Steam is switched on automatically.

**Note:** If the water tank runs dry during the operation with the Reheating setting, the operation is interrupted. Fill the water tank.

### Starting

- Fill the water tank.
- Touch the **Menu** field. The options for selecting an operating mode are displayed.
- Touch the "Steaming" text field.
- Touch the "Reheating" text field. The temperature is in focus.
- Set the temperature using the rotary selector.
- Touch the "Duration" text field and set the duration. **Note:** A duration is always required for the steam types of heating.
- Press the  Start/Stop button to start. The appliance begins to heat up.

Once the duration has elapsed, an audible signal sounds. The appliance stops heating. The duration 00 m 00 s is shown in the display.

When your dish is ready, switch off the appliance using the  On/Off button.

### Changing

You can change the settings as usual.

To change the temperature or the duration, touch the corresponding text field and change using the rotary selector. The change is adopted immediately.

To change the type of heating, interrupt the operation beforehand using the  Start/Stop button.

### Dough proving setting

Dough will prove considerably more quickly using the "Dough proving 

" type of heating than at room temperature and does not dry out.

Use the information in the tables to select the appropriate setting. → "Tested for you in our cooking studio" on page 37

**Note:** If the water tank runs dry during the operation with the Dough proving setting, the operation is interrupted. Fill the water tank.

### Starting

- Fill the water tank. **Note:** Only switch on the Dough proving setting once the cooking compartment has completely cooled down (to room temperature).
- Touch the **Menu** field.
- Touch the "Steaming" text field.
- Touch the "Dough proving" text field. The temperature is in focus.
- Set the temperature using the rotary selector.
- Touch the "Duration" text field and set the duration. **Note:** A duration is always required for the steam types of heating.
- Press the  Start/Stop button to start. The appliance begins to heat up.

Once the duration has elapsed, an audible signal sounds. The appliance stops heating. The duration 00 m 00 s is shown in the display.

When your dish is ready, switch off the appliance using the  On/Off button.

### Changing

You can change the settings as usual.

To change the temperature or the duration, touch the corresponding text field and change using the rotary selector. The change is adopted immediately.

To change the type of heating, interrupt the operation beforehand using the  Start/Stop button.

### Defrosting

Use the "Defrosting 

" type of heating to defrost frozen products.

**Note:** If the water tank runs dry during the operation with the Defrosting setting, the operation is interrupted. Fill the water tank.

### Starting

- Fill the water tank.
- Touch the **Menu** field.
- Touch the "Steaming" text field.
- Touch the "Defrosting" text field. The temperature is in focus.
- Set the temperature using the rotary selector.
- Touch the "Duration" text field and set the duration. **Note:** A duration is always required for the steam types of heating.
- Press the  Start/Stop button to start. The appliance begins to heat up.

Once the duration has elapsed, an audible signal sounds. The appliance stops heating. The duration 00 m 00 s is shown in the display.

When your dish is ready, switch off the appliance using the  On/Off button.

### Changing

You can change the settings as usual.

To change the temperature or the duration, touch the corresponding text field and change using the rotary selector. The change is adopted immediately.

To change the type of heating, interrupt the operation beforehand using the  Start/Stop button.

### Filling the water tank

The water tank is located behind the control panel. Before starting an operation with steam, open the control panel and fill the water tank with water.

Make sure that you have set the water hardness range correctly. → "Basic settings" on page 23

#### Warning – Risk of injury and risk of fire!

Only fill the water tank with water or with the descaling solution that is recommended by us. Do not pour any flammable liquids (e.g. alcoholic drinks) into the water tank. Due to hot surfaces, vapours from flammable liquids may catch fire in the cooking compartment (explosion). The appliance door may spring open. Hot steam and jets of flame may escape.

#### Warning – Risk of burns!

The water tank may heat up while the appliance is in operation. Wait until the water tank has cooled down after the previous appliance operation. Remove the water tank from the water tank recess.

#### Caution!

The appliance may become damaged due to the use of unsuitable liquids.

Do not use distilled water, highly chlorinated tap water (> 40 mg/l) or other liquids.

Only use cold, fresh tap water, softened water or uncarbonated mineral water.

#### Caution!

Malfunctions may occur when using filtered or demineralised water.

The appliance may request that you top up the water tank even though it may be full, or operation with steam is cancelled after approx. two minutes.

If required, mix filtered or demineralised water with the bottled non-carbonated mineral water with a ratio of one to one.

#### Notes

- If your water is very hard, we recommend that you use softened water.
- If you use only softened water, you can set your appliance to the "softened" water hardness range.
- If you use mineral water, set the water hardness range to "4 very hard".
- If you use mineral water, you must only use non-carbonated mineral water.

1. Touch the  field.

The control panel is pushed forwards automatically.

2. Pull the control panel forwards with both hands and then push it upwards until it locks into place (Fig. **1**).

3. Lift the water tank and remove it from the water tank recess (Fig. **2**).

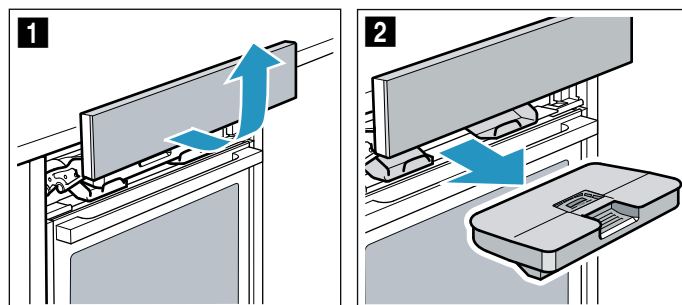

4. Press down on the cover along the seal to prevent water from leaking out of the water tank.

5. Fill the water tank with cold water up to the "max." mark (Fig. **3**).

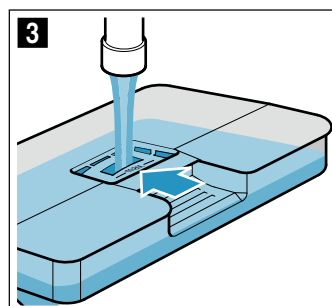

6. Insert the filled water tank (Fig. **4**). Ensure that the water tank locks into place behind both holders **a** (Fig. **5**).

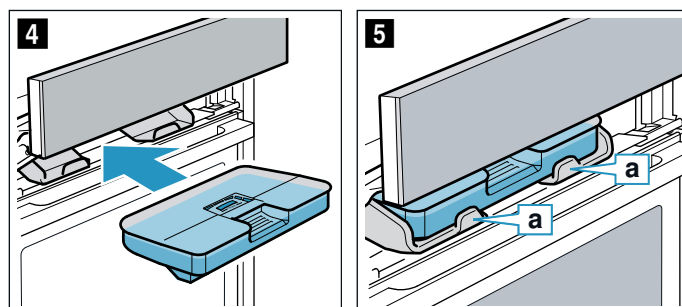

7. Slowly slide the control panel downwards and then push it towards the rear until it is closed completely. The water tank has been filled. You can start using operating modes with steam.

### Refilling the water tank

#### Notes

- Steam-assisted operations continue without adding steam.
- If the water tank runs dry during the operation with the Steaming, Reheating, Dough proving or Defrosting settings, the operation is interrupted. Fill the water tank.

1. Open the control panel.

2. Remove and refill the water tank.

3. Insert the filled water tank and close the control panel.



## After every steam operation

### **⚠ Warning – Risk of scalding!**

When you open the appliance door, hot steam can escape. Steam may not be visible, depending on its temperature. When opening, do not stand too close to the appliance. Open the appliance door carefully. Keep children away.

### **⚠ Warning – Risk of burns!**

The appliance becomes hot during operation. Allow the appliance to cool down before cleaning.

### **Caution!**

Enamel damage: Do not start any operations when there is water on the cooking compartment floor. Before operation, wipe away the water from the cooking compartment floor.

The remaining water is pumped back into the water tank after every operation with steam. Then empty and dry the water tank. Moisture remains in the cooking compartment. To dry the cooking compartment, you can either use the "Drying" operating mode or dry the cooking compartment by hand.

### **Notes**

- Once the appliance has been switched off, the  field remains lit for a little longer to remind you to empty the water tank.
- Remove limescale marks with a cloth soaked in vinegar, then wipe with clean water and dry with a soft cloth.

## Emptying the water tank

### **Caution!**

- Do not dry the water tank in the hot cooking compartment. This will damage the water tank.
- Do not clean the water tank in the dishwasher. This will damage the water tank.

1. Open the control panel.
2. Remove water tank.
3. Carefully remove the lid of the water tank.
4. Empty the water tank, clean it with detergent and then rinse it thoroughly with clean water.
5. Dry all parts with a soft cloth.
6. Rub the seal on the lid until dry.
7. Leave to dry with the lid open.
8. Place the lid on the water tank and push it down.
9. Insert the water tank and close the control panel.

## Cleaning the drip trough

1. Allow the appliance to cool down.
2. Open the appliance door.

3. Soak up the water in the drip trough **a** with a sponge cloth and wipe it carefully (figure **1**).

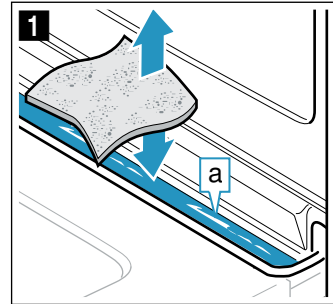

The drip trough **a** is located below the cooking compartment (figure **2**).

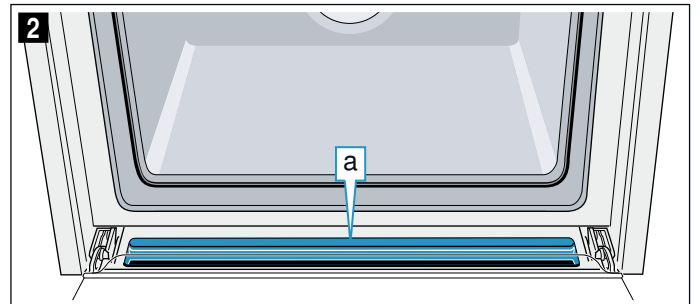



## Starting drying

To dry the cooking compartment, it is heated up so that the moisture in the cooking compartment evaporates. You will then need to open the appliance door to allow the steam to escape from the cooking compartment.

### **Caution!**

Enamel damage: Do not start any operations when there is water on the cooking compartment floor. Before operation, wipe away the water from the cooking compartment floor.

1. Leave the appliance to cool down.
2. Remove the worst dirt from the cooking compartment immediately and wipe away moisture from the cooking compartment floor.
3. If necessary, press the  On/Off button to switch on the appliance.
4. Touch the **Menu** field. The options for selecting an operating mode are displayed.
5. Touch the "Cleaning" text field.
6. Touch the "Drying" text field. The duration is displayed. It cannot be changed.
7. Press the  Start/Stop button to start. The drying function starts and ends automatically after 10 minutes.
8. Open the appliance door and leave it open for 1 to 2 minutes so that the moisture in the cooking compartment can escape.



## Drying the cooking compartment by hand

1. Allow the appliance to cool down.
2. Remove any food remnants from the walls of the cooking compartment.
3. Dry the cooking compartment with a sponge.
4. Leave the appliance door open for 1 hour so that the cooking compartment dries completely.



## Time-setting options

Your appliance has different time-setting options.

| Time-setting option  | Use  |
|--|--|
|  Cooking time | After the set cooking time has elapsed, the appliance ends the operation automatically.  |
|  End          | Enter a cooking time and the required end time. The appliance starts automatically so that the operation ends at the required time.  |
|  Timer        | The timer functions like an egg timer. It runs independently of the operation and the other time-setting options. After the set time has elapsed, the appliance does not switch on or off automatically. |

You can call up the cooking time and the end time after setting an operation using the touch-screen displays. The timer has a separate field  and can be adjusted at any time.

An audible signal sounds after a cooking time or timed period has elapsed. You can cancel the audible signal early by touching a field or touch-screen display.

**Note:** You can change how long the audible signal sounds for in the basic settings. → *"Basic settings"* on page 23

### Setting the cooking time

You can set the cooking time for your dish on the appliance. This means that the cooking time is not unintentionally exceeded and you do not need to interrupt other work in order to end the operation.

#### Applying settings

Depending on which direction you turn the rotary selector first, the cooking time starts at a particular default value: Left = 10 minutes, right = 30 minutes.

The cooking time can be set in one-minute increments up to one hour, and then in five-minute increments.

The maximum setting is 23 hours and 59 minutes.

Example in the picture: It is 10:00, cooking time of 45 minutes.

1. Set the operating mode, and temperature or level.
2. Before starting the operation, touch the "Cooking time" text field.  
The cooking time is highlighted white in the display.
3. Turn the rotary selector to set the cooking time.  
The end time is calculated automatically.



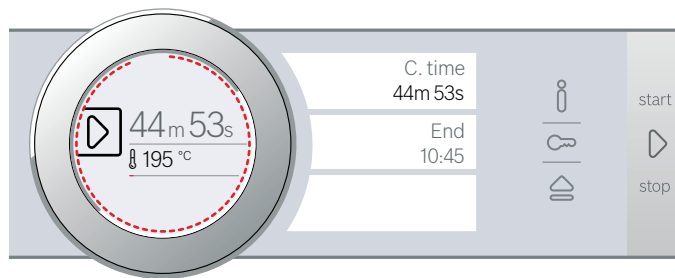

4. Press the  Start/Stop button to start.  
The cooking time counts down.



The appliance begins to heat up.

Once the cooking time has elapsed, an audible signal sounds. The appliance stops heating. The cooking time 00 m 00 s is shown on the display.

You can reset the cooking time using the "Cooking time" text field or you can press the  Start/Stop button to continue the operation without a cooking time.

When your dish is ready, switch the appliance off using the  On/Off button.

### Changing and cancelling

To change the cooking time, touch the "Cooking time" text field. The cooking time is highlighted, and can be changed using the rotary selector. The change is adopted immediately.

If you want to cancel the cooking time, reset the cooking time to zero. After the change has been adopted, operating continues without a cooking time.

### Setting the end time

You can delay the time that the cooking time ends. You can, for example, put your dish in the cooking compartment in the morning and set the cooking time so that it is ready at lunch time.

#### Notes

- Ensure that food is not left in the cooking compartment for too long as it may spoil.
- Do not adjust the end time once the operation has started. The cooking result would no longer be satisfactory.

#### Applying settings

The end of the cooking time can be delayed by a maximum of 23 hours and 59 minutes.

Example in the picture: It is 10:00, the set cooking time is 45 minutes and the dish should be ready at 12:00.

1. Set the operating mode, and temperature or level.
2. Set the cooking time.
3. Before starting the operation, touch the "End" text field.

The projected end time is highlighted white in the display.

4. Set a later end time using the rotary selector.

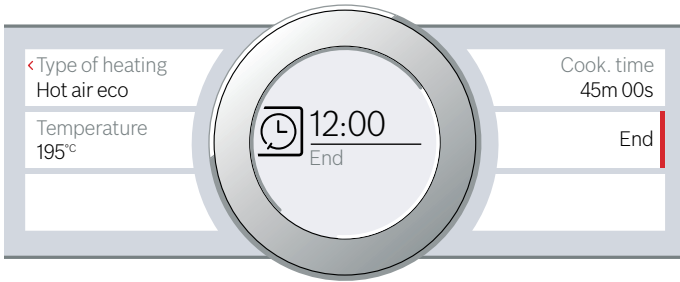

5. Press the ▷ Start/Stop button to start. The time at which the appliance will start is shown in the display.

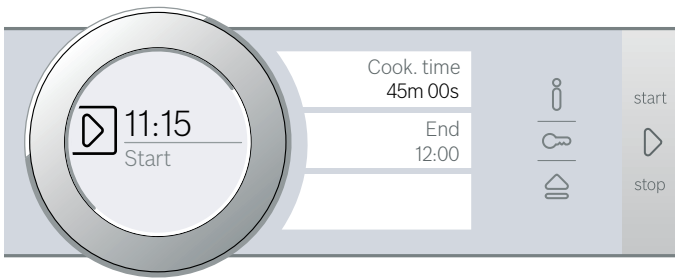

The appliance is in standby mode. When the appliance starts, the cooking time counts down on the display.

Once the cooking time has elapsed, an audible signal sounds. The appliance stops heating. The cooking time 00 m 00 s is shown on the display.

You can reset the cooking time using the "Cooking time" text field or you can press the ▷ Start/Stop button to continue the operation without a cooking time.

When your dish is ready, switch the appliance off using the Ⓛ On/Off button.

### Changing and cancelling

After starting the appliance, the end time can no longer be changed.

If you want to cancel the cooking time and end time, interrupt the operation by pressing the ▷ Start/Stop button. You can continue the operation without a cooking time or end time.

### Setting the timer

The timer runs alongside other settings. You can set it at any time, even if the appliance is switched off. It has its own audible signal so that you can tell whether it is the timer or a cooking time which has elapsed.

### Adjusting settings

The timer duration always starts at zero minutes.

The higher the value, the greater the time steps when setting the timer.

The maximum setting is 24 hours.

1. Touch the ⌘ field.  
The symbol lights up red. On the display, the timer duration is shown in white and in focus.
2. Set the timer duration using the rotary selector.
3. Press the ⌘ field to start.

**Note:** After a few seconds, the timer also starts automatically.

The timer duration counts down.

The timer remains visible on the display if the appliance is switched off. When an operation is running, the settings for this operation are shown in the foreground. When you touch the ⌘ field, the timer duration is displayed for a few seconds.

When the timer duration comes to an end, an audible signal sounds and a note appears on the display. The symbol is no longer lit up.

**Tip:** If the set timer duration relates to the appliance operation, use the cooking time. The time is visible in the foreground and the appliance switches off automatically.

### Changing and cancelling

To change the timer duration, touch the ⌘ field. The timer duration is displayed in white and in focus, and can be changed by using the rotary selector.

If you want to cancel the timer, reset the timer duration to zero. Once the change has been applied, the symbol is no longer lit up.

## Childproof lock

Your appliance is equipped with a childproof lock so that children cannot switch it on accidentally or change any settings.

The control panel is locked and no settings can be made. The appliance can only be switched off using the Ⓛ On/Off button.

### Activating and deactivating

You can activate and deactivate the childproof lock when the appliance is switched on or off.

In each case, press the ∞ field for approx. 4 seconds.

A confirmation note appears on the display.

The ∞ field lights up red when the appliance is switched on. The ∞ field does not light up when the appliance is switched off.

## Basic settings

There are various settings available to you in order to help use your appliance effectively and simply. You can change these settings as required.

### Changing the basic settings

The appliance must be switched on.

1. Touch the **menu** field.  
The options for selecting an operating mode are displayed.
2. Touch the "Basic settings" text field.  
The settings appear on the touch-screen displays.
3. Touch the text field with the required setting.  
The red bar next to the text field identifies the setting that is currently selected.  
Its corresponding value is shown on the display.
4. Turn the rotary selector to change the value as required.
5. Touch the text field for the next setting.  
Its value is shown on the display and can be changed using the rotary selector.
6. Work through the settings and use the rotary selector to make changes as required.  
To scroll through the settings, touch the "Further settings" text field.
7. Touch the **Menu** field to confirm.  
A query is displayed asking whether the changes should be saved.
8. Touch the "Save" text field.  
A message is shown on the display to confirm that the settings have been saved.

### Cancelling

If you do not want to save the settings, touch the **Menu** field and then touch the "Do not save" text field. A message is shown on the display to confirm that the settings have not been saved. Switch off the appliance using the  On/Off button if you do not need to use it.

### List of basic settings

Depending on the features of your appliance, not all basic settings are accessible.

| Setting          | Options   |
|------------------|---|
| Language         | Additional languages are possible.  |
| Clock            | Clock in 24-hour format   |
| Water hardness   | 00 (softened)<br>01 (soft)<br>02 (medium)<br>03 (hard)<br>04 (very hard)* |
| Home Connect     | Switching WiFi on and off<br>→ "Home Connect" on page 24                  |
| Factory settings | Restore<br>Do not restore*  |

|                              |  |
|------------------------------|--|
| Audible signal               | Short cooking time (30 sec.)<br>Medium cooking time (1 min.)*<br>Long cooking time (5 min.)  |
| Volume                       | Levels 01 - 05   |
| Button tone                  | Switched on<br>Switched off* (tone remains for  On/Off) |
| Display brightness           | 5 levels   |
| Clock display                | Off<br>Digital<br>Analogue   |
| Lighting                     | Off during operation<br>On during operation*   |
| Operation after switching on | Main menu<br>Types of heating*<br>Steam<br>Assist  |
| Night-time darkening         | Switched off*<br>Switched on   |
| Brand logo                   | Display*<br>Do not display   |
| Fan run-on time              | Recommended*<br>Minimum  |
| Pull-out system              | Not retrofitted* (for rails and single pull-out system)<br>Retrofitted (for double and triple pull-out systems)                            |
| Sabbath mode                 | Switched on<br>Switched off*   |

\* Factory setting (factory settings may vary depending on the appliance model)

**Note:** Changes to the language, button tone and display brightness settings take effect immediately. All other changes take effect after the settings have been changed.

### Power cut

The changes you make to the settings are saved even after a power cut.

You only have to reset the settings for the initial use following a long-term power cut. The appliance can bridge a short-term power cut.

### Changing the time

If you want to change the time, for example from summer to winter time, you must change the basic setting.

The appliance must be switched on.

1. Touch the **Menu** field.  
The options for selecting an operating mode are displayed.
2. Touch the "Basic settings" text field.  
The settings appear on the touch-screen displays.

3. Touch the "Clock" text field.  
The time appears on the display.
4. Turn the rotary selector to change the time.
5. Touch the **Menu** field to confirm.  
A query is displayed asking whether the changes should be saved.
6. Touch the "Save" text field.  
A message is shown on the display to confirm that the settings have been saved.

## Sabbath mode

With the Sabbath mode, a cooking time of up to 74 hours can be set. You can keep the food in the cooking compartment warm without having to switch the oven on or off.

### Starting Sabbath mode

Before you are able to use the Sabbath mode, you must activate it in the basic settings. → *"Basic settings" on page 23*

When the basic setting has been changed accordingly, Sabbath mode is listed with the types of heating as the last type of heating.

The appliance heats up with top/bottom heating. You can set a temperature between 85 °C and 140 °C.

The "Types of heating" operating mode must be selected. The selection list for the types of heating appears on the touch-screen displays.

1. Touch the "Sabbath mode" text field.  
The default temperature is highlighted white in the display.
2. Set the required temperature using the rotary selector.
3. Before starting the operation, touch the "Cooking time" text field.  
The default cooking time is highlighted white in the display.
4. Set the required cooking time using the rotary selector.  
**Note:** The end time is calculated automatically but cannot be changed.
5. Press the  Start/Stop button to start.  
The cooking time counts down on the display.  
The appliance begins to heat up.

When the cooking time for Sabbath mode has ended, an audible signal sounds. The appliance stops heating. The cooking time 00 m 00 s is shown on the display.

Press the  On/Off button to switch off the appliance.

**Note:** The operation is not interrupted if you open the appliance door.

### Changing and cancelling

After starting the appliance, the settings can no longer be changed.

If you would like to cancel Sabbath mode, switch the appliance off using the  On/Off button. You can no

longer pause the operation using the  Start/Stop button.

## Home Connect

This appliance is Wi-Fi-capable and can be remotely controlled using a mobile device.

If the appliance is not connected to the home network, the appliance functions in the same way as an oven with no network connection and can still be operated via the display.

The availability of the Home Connect function depends on the availability of Home Connect services in your country. Home Connect services are not available in every country. You can find more information on this at [www.home-connect.com](http://www.home-connect.com).

### Notes

- Ensure that you follow the safety instructions in this instruction manual and that you comply with these even when you are away from home and are operating the appliance via the Home Connect app. You must also follow the instructions in the Home Connect app. → *"Important safety information" on page 5*
- Operating the appliance directly from the appliance always has priority. During this time, it is not possible to operate the appliance using the Home Connect app.

### Setting up

To set up Home Connect for your appliance, you require the following:

- Your appliance, which must be connected to the mains and switched on,
- A smartphone or tablet with the latest version of the iOS or Android operating system,
- The Home Connect app,
- The supplied Home Connect installation instructions,
- And your appliance within range of the Wi-Fi signal for your home network

The app guides you through the entire process. Follow the instructions in the app.

### Remote Start

To start and operate your appliance via the Home Connect app, you will need to activate remote start. If remote start is not activated, you will only be able to view the operating statuses in the Home Connect app and configure your appliance's settings.

**Note:** Some of the operating modes can only be started on the oven.

Remote start is automatically deactivated:

- if you open the oven door 15 minutes after remote start has been activated.
- if you open the oven door 15 minutes after the operation has finished.

When you start the oven using the controls on the appliance itself, remote start is activated automatically. You can now make changes or start a new programme from your mobile device.

### Activating remote start

1. Touch the **Menu** field.
2. Touch the "Remote Start" text field.  
 will appear on the display

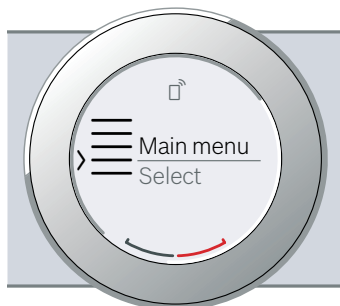

## Home Connect settings

You can adjust Home Connect to suit your requirements at any time.

**Note:** You will find the Home Connect settings in your appliance's basic settings. Which settings the display shows will depend on whether Home Connect has been set up and whether the appliance is connected to your home network.

| Basic setting   | Possible settings  | Explanation   |
|---|--|---|
| WiFi  | Switching on/off   | You can switch the wireless module on and off. If WiFi is activated, you can use the Home Connect function. The appliance requires max. 2 W in networked standby.   |
| Network   | Connecting to the network/<br>disconnecting from the network | Switch the network connection on or off as required (e.g. for holiday). Network information is retained after the appliance is switched off. After switching on the appliance, wait for a few seconds while it reconnects to the network. |
| Connect to app  |  | Start the connection process between the app and the appliance.   |
| Remote control  | on/off   | Use the Home Connect app to access the appliance's functions. When it is deactivated, only the operating statuses are displayed in the app.   |
| Appliance information  |  | The display shows the network and appliance information.  |

## Remote diagnostics

Customer Service can use Remote Diagnostics to access your appliance if you contact them, have your appliance connected to the Home Connect server and if Remote Diagnostics is available in the country in which you are using the appliance.

**Note:** For further information and details about the availability of Remote Diagnostics in your country, please visit the service/support section of your local website: [www.home-connect.com](http://www.home-connect.com)

## About data protection

When your appliance is connected for the first time to a WLAN network, which is connected to the Internet, your appliance transmits the following categories of data to the Home Connect server (initial registration):

- Unique appliance identification (consisting of appliance codes as well as the MAC address of the installed WiFi communication module).
- Security certificate of the WiFi communication module (to ensure a secure IT connection).
- The current software and hardware version of your domestic appliance.
- Status of any previous resetting to factory settings.

This initial registration prepares the Home Connect functions for use and is only required when you want to use these Home Connect functions for the first time.

**Note:** Ensure that the Home Connect functions can be used only in conjunction with the Home Connect app. Information on data protection can be accessed in the Home Connect app.

## Declaration of Conformity

Robert Bosch Hausgeräte GmbH hereby declares that the appliance which features Home Connect is in accordance with the basic requirements and the other relevant provisions of the directive 2014/53/EU.

A detailed RED Declaration of Conformity can be found online at [www.bosch-home.com/de](http://www.bosch-home.com/de) on the product page for appliance in the additional documents.



2.4 GHz band: max. 100 mW  
5 GHz band: max. 100 mW

|   |    |    |    |    |    |    |    |    |
|---|----|----|----|----|----|----|----|----|
|   | BE | BG | CZ | DK | DE | EE | IE | EL |
|  | ES | FR | HR | IT | CY | LV | LT | LU |
|   | HU | MT | NL | AT | PL | PT | RO | SI |
|   | SK | FI | SE | UK | NO | CH | TR |    |

5 GHz Wi-Fi: for indoor use only



## Cleaning agent

With good care and cleaning, your appliance will retain its appearance and remain fully functioning for a long time to come. We will explain here how you should correctly care for and clean your appliance.

### Suitable cleaning agents

To ensure that the different surfaces are not damaged by using the wrong cleaning agent, observe the information in the table. Depending on the appliance model, not all of the areas listed may be on/in your appliance.

#### Caution!

#### Risk of surface damage

Do not use:

- Harsh or abrasive cleaning agents,
- Cleaning agents with a high alcohol content,
- Hard scouring pads or cleaning sponges,
- High-pressure cleaners or steam cleaners,
- Special cleaners for cleaning the appliance while it is hot.

Wash new sponge cloths thoroughly before use.

**Tip:** Highly recommended cleaning and care products can be purchased through the after-sales service. Observe the respective manufacturer's instructions.

#### Warning – Risk of burns!

The appliance becomes very hot. Never touch the interior surfaces of the cooking compartment or the heating elements. Always allow the appliance to cool down. Keep children at a safe distance.

| Area                      | Cleaning   |
|---------------------------|--|
| <b>Appliance exterior</b> |  |
| Stainless steel front     | Hot soapy water:<br>Clean with a dish cloth and then dry with a soft cloth.<br><br>Remove flecks of limescale, grease, starch and albumin (e.g. egg white) immediately. Corrosion can form under such flecks.<br><br>Special stainless steel cleaning products suitable for hot surfaces are available from our after-sales service or from specialist retailers. Apply a very thin layer of the cleaning product with a soft cloth. |
| Plastic                   | Hot soapy water:<br>Clean with a dish cloth and then dry with a soft cloth.<br><br>Do not use glass cleaner or a glass scraper.  |
| Painted surfaces          | Hot soapy water:<br>Clean with a dish cloth and then dry with a soft cloth.  |
| Control panel             | Hot soapy water:<br>Clean with a dish cloth and dry with a soft cloth.<br><br>Do not use glass cleaner or a glass scraper.<br><br>If descaler comes into contact with the control panel, wipe it off immediately. If you leave it, it may stain the control panel.   |

|             |  |
|-------------|--|
| Door panels | Hot soapy water:<br>Clean with a dish cloth and then dry with a soft cloth.<br><br>Do not use a glass scraper or a stainless steel scouring pad.   |
| Door handle | Hot soapy water:<br>Clean with a dish cloth and then dry with a soft cloth.<br><br>If descaler comes into contact with the door handle, wipe it off immediately. Otherwise, any stains will not be able to be removed. |

#### Appliance interior

|  |  |
|--|--|
| Enamel surfaces and self-cleaning surfaces | Observe the instructions for the surfaces of the cooking compartment that follow the table.  |
| Glass cover for the interior lighting      | Hot soapy water:<br>Clean with a dish cloth and then dry with a soft cloth.<br><br>If the cooking compartment is heavily soiled, use oven cleaner.   |
| Door seal<br>Do not remove.                | Hot soapy water:<br>Clean with a dish cloth.<br><br>Do not scour.  |
| Door cover                                 | made from stainless steel:<br>Use stainless steel cleaner. Follow the manufacturers' instructions. Do not use stainless steel care products.<br><br>made from plastic:<br>Clean using hot soapy water and a dish cloth. Dry with a soft cloth. Do not use glass cleaner or a glass scraper.<br><br>Remove the door cover for cleaning. |
| Rails                                      | Hot soapy water:<br>Soak and clean with a dish cloth or brush.   |
| Pull-out system                            | Hot soapy water:<br>Clean with a dish cloth or a brush.<br><br>Do not remove the lubricant while the pull-out rails are pulled out – it is best to clean them when they are pushed in. Do not clean in the dishwasher.   |
| Accessories                                | Hot soapy water:<br>Soak and clean with a dish cloth or brush.<br><br>Clean dirt on stainless steel roasting dishes caused by starchy foods (e.g. rice) using a vinegar solution.  |
| Water tank                                 | Hot soapy water:<br>Clean with a dish cloth and rinse thoroughly to remove residual detergent.<br><br>Then dry with a soft cloth. Leave the water tank to dry with the lid open. Rub the seal on the lid until dry.<br><br>Do not clean in the dishwasher.   |

#### Notes

- Slight differences in colour on the front of the appliance are caused by the use of different materials, such as glass, plastic and metal.
- Shadows on the door panels, which look like streaks, are caused by reflections made by the interior lighting.



- Enamel is baked on at very high temperatures. This can cause some slight colour variation. This is normal and does not affect operation. The edges of thin trays cannot be completely enamelled. As a result, these edges can be rough. This does not impair the anti-corrosion protection.

## Surfaces in the cooking compartment

The back wall, ceiling and side parts in the cooking compartment are self-cleaning. You can tell this from the rough surface.

The cooking compartment floor is enamelled and has smooth surfaces.

### Cleaning enamel surfaces

Clean the smooth enamel surfaces with a dish cloth and hot soapy water or a vinegar solution. Then dry them with a soft cloth.

Soften baked-on food remnants with a damp cloth and soapy water. Use stainless steel wire wool or oven cleaner to remove stubborn dirt.

### Caution!

Never use oven cleaner in the cooking compartment when it is still warm. This may damage the enamel. Remove all food remnants from the cooking compartment and the appliance door before you next heat up the appliance.

Leave the cooking compartment open to dry after cleaning it.

**Note:** Food residues can cause white deposits to form. These are harmless and do not affect how the appliance works. You can remove these residues using lemon juice if required.

### Cleaning self-cleaning surfaces

The self-cleaning surfaces are coated with a porous, matte ceramic layer. This coating absorbs and dispels splashes from baking and roasting while the appliance is in operation.

If the self-cleaning surfaces no longer clean themselves sufficiently and dark stains appear, they can be cleaned using the cleaning function. To do this, refer to the information in the relevant section. → *"Cleaning function" on page 27*

### Caution!

Do not use oven cleaner on self-cleaning surfaces. This will damage the surfaces. If oven cleaner does get onto these surfaces, dab it off immediately using water and a sponge cloth. Do not rub the surface and do not use abrasive cleaning aids.

## Keeping the appliance clean

Always keep the appliance clean and remove dirt immediately so that stubborn deposits of dirt do not build up.

### Warning – Risk of fire!

Loose food remnants, fat and meat juices may catch fire. Before using the appliance, remove the worst of the

food remnants from the cooking compartment, heating elements and accessories.

### Tips

- Clean the cooking compartment after each use. This will ensure that dirt cannot be baked on.
- Always remove flecks of limescale, grease, starch and albumin (e.g. egg white) immediately.
- Use the universal pan for baking very moist cakes.
- Use suitable ovenware for roasting, e.g. a roasting dish.



## Cleaning function

Your appliance has the "EcoClean" and "Descaling" operating modes. The self-cleaning surfaces in the cooking compartment are cleaned with the "EcoClean" cleaning function. You can use the "Descaling" operating mode to remove limescale from the evaporator.

### EcoClean

The self-cleaning surfaces in the cooking compartment are cleaned when the operating mode is set to "Cleaning function".

The self-cleaning surfaces (back panel, ceiling panel and side panels) are coated with a porous, matt ceramic material. This coating absorbs and breaks down splashes from baking, roasting and grilling while the oven is in operation. If the surfaces no longer clean themselves adequately and dark patches appear, the surfaces can be cleaned by the cleaning function.

**Note:** The appliance records the number of times it is used. The appliance indicates when it has reached a point in time after which cleaning is recommended. The recommendation is displayed until the cleaning function has finished.

If you do not act on this recommendation, the self-cleaning surfaces may become damaged.

If your appliance is already prematurely very dirty or if you notice dark patches on the back panel, do not wait until your appliance recommends cleaning to do so. This is because the more often the appliance is cleaned, the longer the self-cleaning surfaces will retain their cleaning capability. You can clean your appliance at any time as required using the cleaning function.

### Before running the cleaning function

Remove shelves, rails, accessories and ovenware from the cooking compartment.

### Cleaning the cooking compartment floor and the inside of the appliance door

Remove the worst dirt from the cooking compartment floor, the inside of the appliance door and the interior lighting. Otherwise, patches will appear that can no longer be removed.

### Caution!

Do not use oven cleaner on the self-cleaning surfaces. This will damage the surfaces. If oven cleaner does get

onto these surfaces, dab it off immediately using water and a sponge cloth. Do not rub the surface and do not use abrasive cleaning aids.

### **Warning – Risk of burns!**

 The appliance becomes very hot on the outside during the cleaning function. Never touch the appliance door. Allow the appliance to cool down. Keep children at a safe distance.

### Setting the cleaning function

Before setting the cleaning function, ensure that you have followed all instructions for preparation.

The duration for the cleaning function is preset to 1 hour. It cannot be changed.

1. Touch the **Menu** field.  
The list of operating modes are displayed.
2. Touch the "Cleaning" text field.
3. Touch the "EcoClean" text field.
4. Press the  Start/Stop button to start.  
The time counts down on the display. The heating line does not appear for the cleaning function.  
The cleaning function starts.

Ventilate the kitchen when the cleaning function is running.



When the cleaning function has ended, an audible signal sounds. The duration 00 m 00 s is shown on the display. Press the  On/Off button to switch off the appliance.

### Setting a later end time

You can set a later end time. Before starting the appliance, touch the "End" text field and set a later end time using the rotary selector.

The appliance switches to standby after it is started. The end time can no longer be changed.

### Cancel

If you would like to cancel the cleaning function, switch the appliance off using the  On/Off button. You can no longer pause the operation using the  Start/Stop button.

**Note:** The operating hour counter is not reset. The instruction for the cleaning function is still shown on the display.

### Once the cleaning function has finished

Once the cooking compartment has cooled down, wipe down the cooking compartment with a damp cloth if necessary.

**Note:** During operation and while the cleaning function is active, reddish patches may form on the surfaces. This is not rust, but residue from food. These spots are not harmful and do not impair the cleaning ability of the self-cleaning surfaces.

## Descaling

To ensure that your appliance continues to operate correctly, it must be descaled regularly.

Descaling comprises a number of different steps. For hygiene reasons, the descaling programme must be run through completely before the appliance is ready for operation again. In total, the descaling programme runs for approx. 70–95 minutes.

- Descal (approx. 55–70 minutes), then empty and refill the water tank
- First rinsing cycle (approx. 9–12 minutes), then empty and refill the water tank
- Second rinsing cycle (approx. 9–12 minutes), then empty and dry the water tank

If descaling is interrupted (e.g. due to a power failure or because the appliance is switched off), you will be prompted to rinse the appliance twice when you switch it back on. The appliance cannot be used until the second rinsing cycle has finished.



The frequency with which the appliance must be descaled depends on the hardness of the water used. When only another five or fewer steam-assisted operations are possible, the appliance reminds you to descale it with a message on the display. The number of remaining operations is displayed after the appliance is switched on. You can therefore prepare for the descaling in good time.

### Starting

#### Caution!

- Risk of damage to the appliance: Only use liquid descalers recommended by us for the descaling programme. The time the product needs to work during descaling depends on the type of descaler used. Other descalers may damage the appliance. Descaler order no. 311 680
- Descaling solution: Do not allow any descaling solution or descaler to come into contact with the control panel or other surfaces on the appliance. This damages the surfaces. If this does happen, remove the descaling solution immediately with water.

If you have used a steam-assisted operation immediately before descaling, you must first switch the appliance off so that the residual water is pumped out of the evaporator system.

1. Mix 400 ml water with 200 ml liquid descaler to make a descaling solution.
2. Use the  On/Off button to start.
3. Remove the water tank and fill it with descaling solution.
4. Once the water tank has been filled with descaling solution, push it back in again fully.
5. Close the control panel.
6. Touch the **Menu** field.  
The list of operating modes is displayed.
7. Touch the "Cleaning" text field.
8. Touch the "Descaling" text field.  
The duration of the descaling programme is displayed. It cannot be changed.
9. Press the Start/Stop button  to start.  
The appliance is now descaled. The time counts down in the display.  
Once the cooking time has elapsed, an audible signal sounds.

### First rinsing cycle

1. Open the control panel.
2. Remove the water tank, rinse thoroughly, fill with water and reinsert.
3. Close the control panel.
4. Press the ▷ Start/Stop button to start. The appliance rinses. Once the duration has elapsed, an audible signal sounds.

### Second rinsing cycle

1. Open the control panel.
2. Remove the water tank, rinse thoroughly, fill with water and reinsert.
3. Close the control panel.
4. Press the ▷ Start/Stop button to start. The appliance rinses. Once the duration has elapsed, an audible signal sounds.

### Rinsing

1. Open the control panel.
2. Empty and dry the water tank.
3. Press the ⏻ On/Off button to switch off the appliance. Descaling is complete and the appliance is ready for use again.

## Rails

With good care and cleaning, your appliance will retain its appearance and remain fully functional for a long time to come. This will tell you how to remove the shelves and clean them.

### Detaching and refitting the rails

#### ⚠ Warning – Risk of burns!

The rails become very hot. Never touch the hot rails. Always allow the appliance to cool down. Keep children away from the appliance.

#### Detaching the rails

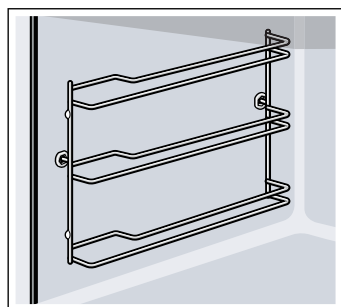

1. Lift the rail slightly at the front **a** and detach it **b** (figure **1**).
2. Then pull the whole rail towards you and take it out (figure **2**).

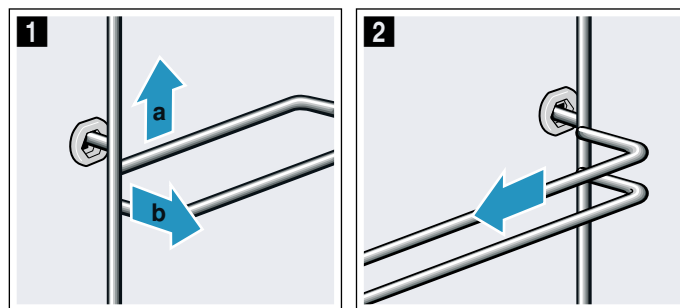

Clean the rails with cleaning agent and a sponge. For stubborn deposits of dirt, use a brush.

#### Attaching the rails

The rails only fit on the right or the left side. For both rails, ensure that the curved rods are at the front.

1. First, insert the rail in the middle of the rear socket **a**, until the rail rests against the cooking compartment wall, and push it back **b** (figure **1**).
2. Then insert the rail into the front socket **c**, until the rail also rests against the cooking compartment wall here, and press it downwards **d** (figure **2**).

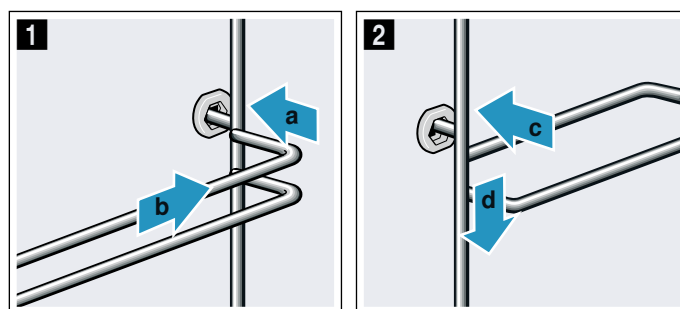

## Appliance door

With good care and cleaning, your appliance will retain its appearance and remain fully functional for a long time to come. This will tell you how to clean the appliance door.

### Detaching and refitting the appliance door

For cleaning purposes or to remove the door panels, you can detach the appliance door.

The appliance door hinges each have a locking lever. When the locking levers are closed (fig. 1), the appliance door is secured in place. It cannot be detached.

When the locking levers are open in order to detach the appliance door (fig. 2), the hinges are locked. They cannot snap shut.

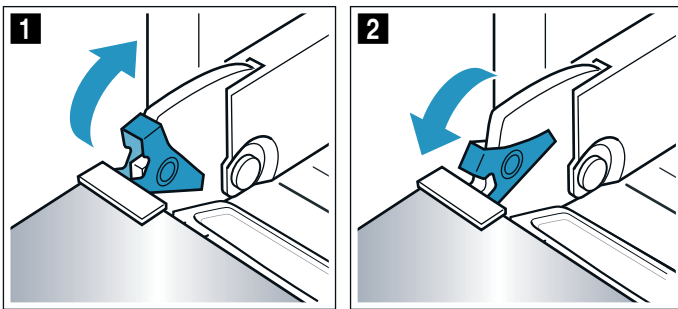

#### **Warning** Risk of injury!

- If the hinges are not locked, they can snap shut with great force. Ensure that the locking levers are always fully closed or, when detaching the appliance door, fully open.
- The hinges on the appliance door move when opening and closing the door, and you may be trapped. Keep your hands away from the hinges.

### Detaching the appliance door

1. Open the appliance door fully.
2. Open the two locking levers on the left and right (fig. 1).
3. Close the appliance door fully **a**. Take hold of the appliance door with both hands, one on the left and one on the right **b**, and pull it up and out (fig. 2).

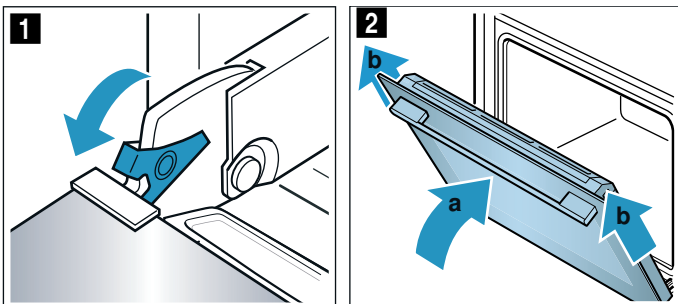

### Refitting the appliance door

Follow the instructions in the reverse order to refit the appliance door.

1. Press down on the seal **a** along the drip trough (fig. 1); otherwise, the seal **a** may become detached during cleaning.

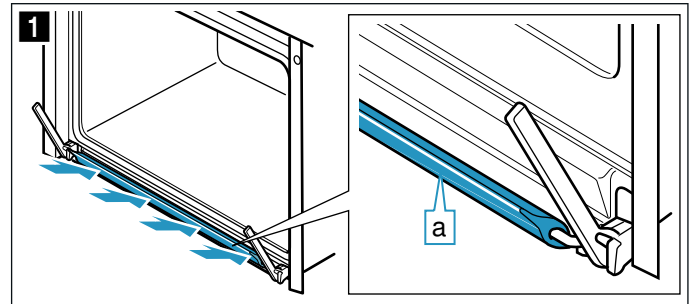

2. When fitting the appliance door, ensure that both hinges are inserted straight into the opening (fig. 2). Slide the appliance door down as far as it will go.
3. Open the appliance door fully. Close the two locking levers (fig. 3).

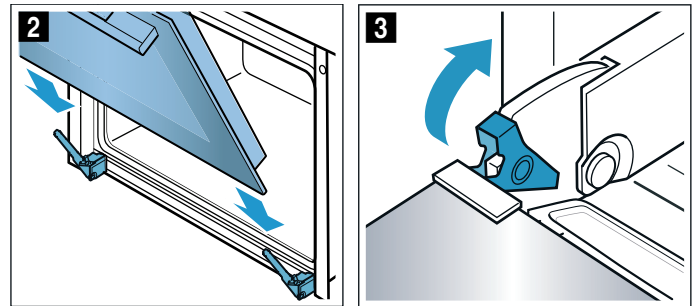

4. Close the cooking compartment door.

## Fitting and removing the glass panels

To facilitate cleaning, you can remove the glass panels from the appliance door. If required, for example if the appliance is installed higher up, you can remove the entire door and lay it on a flat surface.

### Locking the appliance door

1. Open the appliance door fully.
2. Open the two locking levers on the left and right (fig. 1).
3. Close the appliance door as far as it goes (fig. 2).

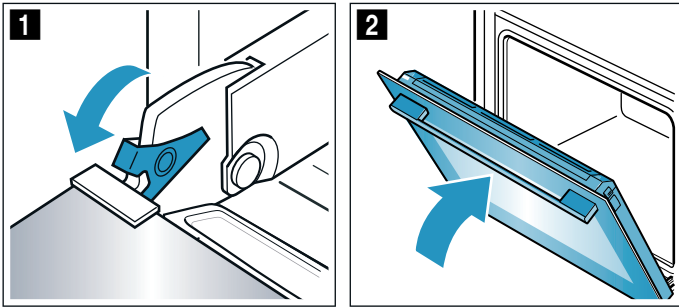

### Removing panels

1. Press on the left- and right-hand sides of the cover (fig. 1).
2. Remove the cover (fig. 2).

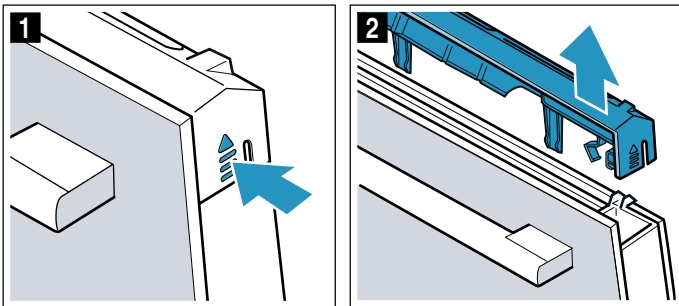

3. Lift out the inner panel (fig. 3) and set it down carefully on a flat surface.

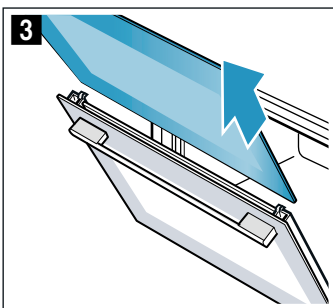

4. Take off the seal on both sides and remove it (fig. 4).

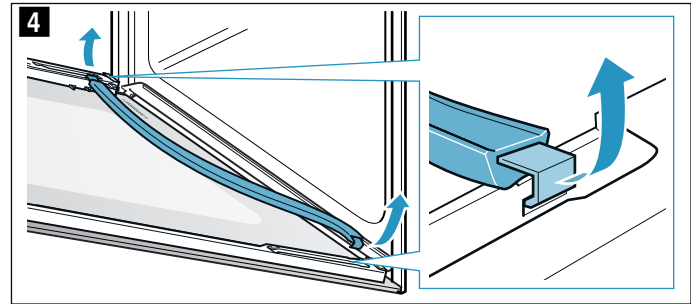

5. Lift out the intermediate glass panel (fig. 5) and set it down carefully on a flat surface.

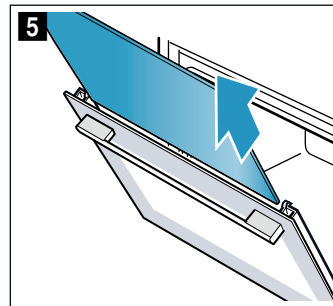

6. If necessary, you can remove the condensate trough for cleaning. To do this, open the appliance door fully (fig. 6).

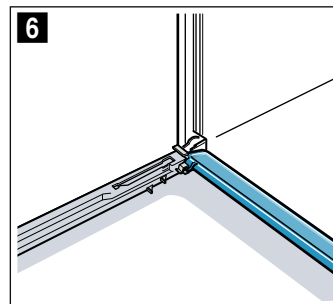

7. Tilt the condensate trough up and remove it (fig. 7).

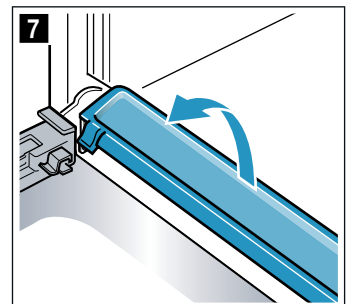

Clean the panels with glass cleaner and a soft cloth. Wipe the condensate trough with a cloth and some hot soapy water.

### **Warning** Risk of injury!

- Scratched glass in the appliance door may develop into a crack. Do not use a glass scraper, sharp or abrasive cleaning aids or detergents.
- The hinges on the appliance door move when opening and closing the door, and you may be trapped. Keep your hands away from the hinges.
- Components inside the appliance door may have sharp edges. Wear protective gloves.



### Fitting panels

1. Open the appliance door fully and refit the condensate trough. To do this, insert the trough from above and rotate it at the bottom (fig. 1).

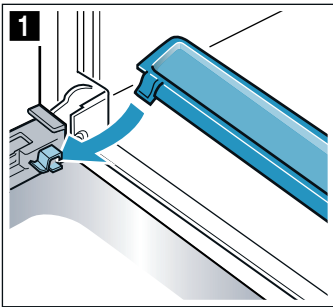

2. Slide the intermediate glass panel back in and make sure that it is sitting correctly at the bottom in the retainer (fig. 2).

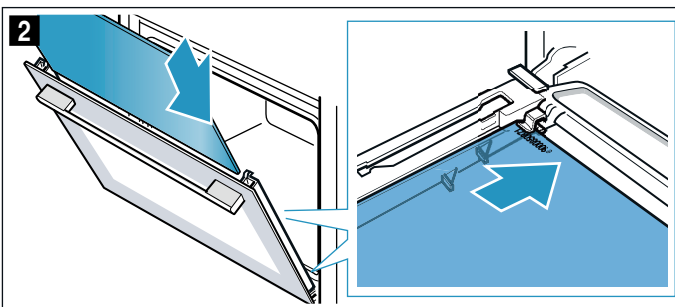

3. Press down on the top of the intermediate glass panel (fig. 3).

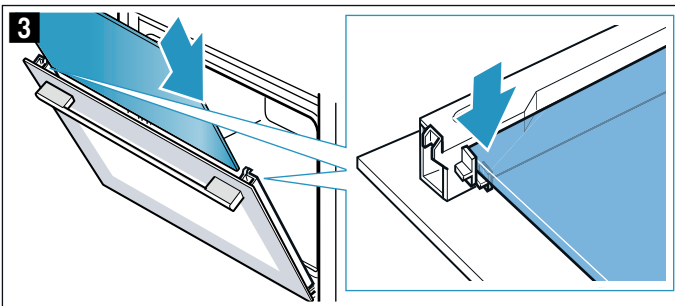

4. Refit the seal on the left and right (fig. 4)

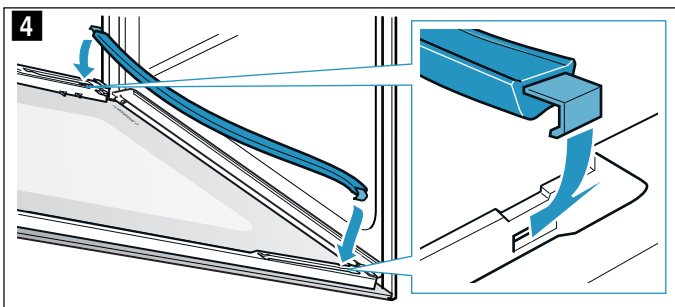

5. Push in the inner glass panel. Before sliding the panel in, make sure that the glossy side of the panel is on the outside and the cut-outs on the left and right are at the top. The panel must be sitting correctly at the bottom in the retainer (fig. 5).

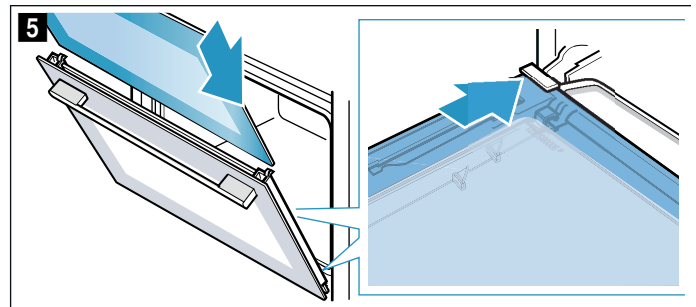

6. Push the inner panel in at the top (fig. 6).

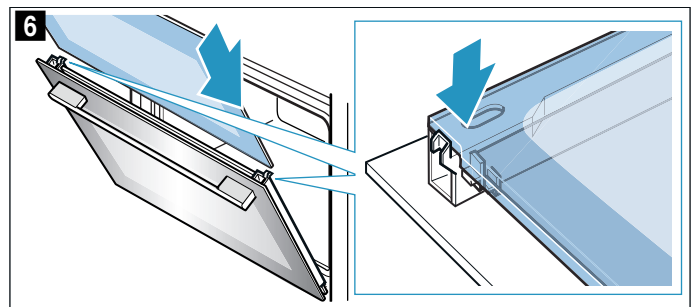

7. Put the cover back in place and press on it until you hear it click into place (fig. 7).
8. Open the appliance door again fully.
9. Close the two locking levers on the left and right (fig. 8)

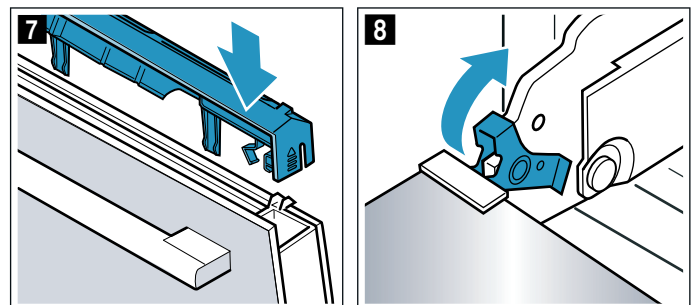

10. Close the appliance door.

### Caution!

Do not use the cooking compartment again until the panels have been correctly fitted.



## Trouble shooting

If a fault occurs, there is often a simple explanation. Before calling the after-sales service, please refer to the fault table and attempt to correct the fault yourself.

### Rectifying faults yourself

You can often easily rectify technical faults on the appliance yourself.

If a dish does not turn out exactly as you wanted, you can find many tips and instructions for preparation at the end of the operating manual. → "Tested for you in our cooking studio" on page 37

| Fault  | Possible cause  | Notes/remedy   |
|--|---|--|
| The appliance does not work.   | Faulty fuse.  | Check the circuit breaker in the fuse box.   |
|  | Power cut   | Check whether the kitchen light or other kitchen appliances are working.   |
| "Sprache Deutsch" appears on the display.  | Power cut   | Reset the language and the time.   |
| The time does not appear when the appliance is switched off.   | Basic setting is changed.   | Change the basic setting for the clock display.  |
| The appliance does not heat up; the  symbol lights up on the display. | Demo mode is activated in the basic settings.   | Briefly disconnect the appliance from the mains (switch off the circuit breaker in the fuse box) and then deactivate demo mode in the basic settings within 3 minutes.   |
| The appliance will not start and "Cooking compartment too hot" appears on the display  | The cooking compartment is too hot for the selected dish or type of heating                     | Allow the cooking compartment to cool down and start again   |
| The rotary selector has fallen out of the support in the control panel.  | The rotary selector has been accidentally disengaged.   | The rotary selector can be removed. Simply place the rotary selector back in its support in the control panel and push it in so that it engages and can be turned as usual.  |
| The rotary selector can no longer be turned easily.  | There is dirt under the rotary selector.  | The rotary selector can be removed. To disengage the rotary selector, simply remove it from the support. Alternatively, press on the outer edge of the rotary selector so that it tips and can be picked up easily.<br>Carefully clean the rotary selector and its support on the appliance using a cloth and soapy water. Dry with a soft cloth. Do not use any sharp or abrasive materials. Do not soak or clean in the dishwasher.<br>Do not remove the rotary selector too often so that the support remains stable. |
| Home Connect does not work correctly.  |   | Go to <a href="http://www.home-connect.com">www.home-connect.com</a>   |
| Operations with steam or descaling do not start or do not continue   | Water tank empty  | Refill water tank  |
|  | The panel is open   | Close the panel  |
|  | Descaling locks operations with steam   | Carry out descaling  |
|  | Faulty sensor   | Call the after-sales service   |
| The appliance prompts you to rinse   | The power supply was interrupted or the appliance was switched off during the descaling process | Once the appliance is switched on again, rinse it twice  |
| The appliance prompts you to descale without the counter appearing beforehand  | The set water hardness range is too low   | Carry out descaling<br>Check the set water hardness range and adjust it, if necessary  |
| Buttons flash  | Normal occurrence caused by condensation behind the control panel                               | As soon as the condensation has evaporated, the buttons no longer flash  |
| Cooked dishes turn out too moist or too dry when cooking with steam-assisted applications  | The wrong steam intensity was selected  | Select a higher or lower steam intensity   |

|  |  |   |
|--|--|---|
| The "Fill water tank" message appears even though the water tank is full | The panel is open  | Close the panel   |
|  | The water tank is not clicked into place   | Click the water tank into place<br>→ "Steam" on page 17   |
|  | Faulty sensor  | Call the after-sales service  |
|  | The water tank has fallen off. Due to the impact, components inside the water tank have come loose, and the tank is leaking. | Order a new water tank  |
| The panel for removing the tank does not open                            | The plug is not plugged into the mains   | Connect the appliance to the electricity supply   |
|  | Power cut  | Check whether other kitchen appliances are working  |
|  | The circuit breaker is faulty  | Check in the fuse box to make sure that the fuse for the appliance is in working order  |
|  | ☒ field sensor faulty  | Call the after-sales service<br>If required, empty the water tank: Open the appliance door, take hold of the lower part of the panel on the left and right with your fingers and pull out the panel |
| When you cook with steam, a lot of steam is produced                     | The appliance is being automatically calibrated  | Normal procedure  |
| When cooking with steam, a lot of steam is produced repeatedly           | The appliance is unable to calibrate itself automatically if cooking times are too short                                     | Reset the appliance to the factory settings and repeat the calibration process  |
| There is a "pop" noise during cooking                                    | Cold/warm effect with frozen food, caused by the steam   | Not possible  |

**⚠ Warning – Risk of injury!**

Incorrect repairs are dangerous. Do not attempt to repair the appliance yourself. Repairs must only be carried out by one of our trained after-sales engineers. If the appliance is defective, call the after-sales service.

**⚠ Warning – Risk of electric shock!**

Incorrect repairs are dangerous. Repairs may only be carried out and damaged power cables replaced by one of our trained after-sales technicians. If the appliance is defective, unplug the appliance from the mains or switch off the circuit breaker in the fuse box. Contact the after-sales service.

**Error messages on the display**

When an error message appears on the display with "D" or "E", e.g. D0111 or E0111, switch the appliance off and on again using the Ⓞ On/Off button.

If it was a one-off error, the display goes out. If the error message appears again, call the after-sales service and quote the exact error message.

**Maximum operating time**

If you do not change the settings on your appliance for several hours, the appliance stops heating up automatically. This prevents unwanted continuous operation.

The respective settings for the operating mode govern when the maximum operating time is reached.

**Maximum operating time reached**

A note appears on the display confirming that the maximum operating time has been reached.

To continue operation, touch any field or turn the rotary selector.

Switch the appliance off using the Ⓞ On/Off button if you do not need to use it.

**Tip:** Set a cooking time so that the appliance does not switch off when you do not want it to, e.g. with an extremely long preparation time. The appliance heats up until the set cooking time has elapsed.

**Cooking compartment bulbs**

To light the interior of your cooking compartment, your appliance has one or more long-life LED bulbs.

However, if ever an LED bulb or the bulb's glass cover is defective, call the after-sales service. The lamp cover must not be removed.

## Customer service

Our after-sales service is there for you if your appliance needs to be repaired. We will always find an appropriate solution, also in order to avoid after-sales personnel having to make unnecessary visits.

### E number and FD number

When calling us, please quote the full product number (E no.) and the production number (FD no.) so that we can provide you with the correct advice. The rating plate bearing these numbers can be found when you open the appliance door.

On some appliances with a steam-assisted cooking function, you will find the rating plate behind the control panel.

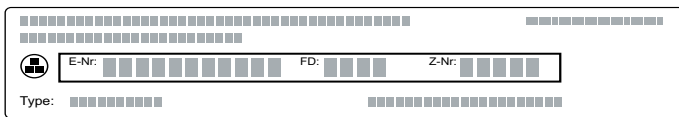

To save time, you can make a note of the numbers for your appliance and the telephone number of the after-sales service in the space below in case you need them.

|  |  |               |  |
|--|--|---------------|--|
| <b>E no.</b>   |  | <b>FD no.</b> |  |
| <b>After-sales service</b>  |  |               |  |

Please note that a visit from an after-sales service engineer is not free of charge in the event that the appliance has been misused, even during the warranty period.

Please find the contact data of all countries in the enclosed customer service list.

### To book an engineer visit and product advice

**GB** 0344 892 8979  
Calls charged at local or mobile rate.

**IE** 01450 2655  
0.03 € per minute at peak. Off peak 0.0088 € per minute.

Rely on the professionalism of the manufacturer. You can therefore be sure that the repair is carried out by trained service technicians who carry original spare parts for your appliances.

## Dishes

You can use the "Dishes" operating mode to prepare a wide variety of food. The appliance chooses the optimal setting for you.

To achieve good results, the cooking compartment must not be too hot for the type of food you have selected. If it is, a message will appear on the display. Allow the cooking compartment to cool down and start again.

### Information on the settings

- The cooking result depends on the quality of the food and the size and type of cookware. For an optimal cooking result, use food that is in good condition and chilled meat only. For frozen food, use food straight out of the freezer only.
- For some food, a temperature, heating mode and cooking time is suggested. The temperature and the cooking time can be changed according to your requirements.
- For other dishes, you will be asked to enter the weight. Always enter the total weight unless the appliance asks for something different. The appliance will then apply the time and temperature settings for you. It is not possible to set weights outside of the intended weight range.
- When roasting dishes for which the appliance will apply the temperature selection for you, temperatures of up to 300 °C can be saved. Therefore, make sure that you use cookware that is sufficiently heat resistant.
- Information is provided, e.g. on cookware, shelf position or the addition of liquid when cooking meat. Some food requires turning or stirring, etc., during cooking. This is shown in the display shortly after operation starts. An audible signal will remind you at the right time.
- Information on the right kind of cookware to use and tips and tricks for the preparation can be found at the end of the instruction manual. → "Tested for you in our cooking studio" on page 37

### Steam

For some food, the steam function is automatically activated. General information on the steam function can be found in the relevant section. → "Steam" on page 17

The cooking time is displayed after operation starts. It does not start counting down until the set temperature has been reached.

### Warning – Risk of scalding!

When you open the appliance door, hot steam can escape. Steam may not be visible, depending on its temperature. When opening, do not stand too close to the appliance. Open the appliance door carefully. Keep children away.

## Selecting a dish

The dishes are arranged in a uniform structure:

- Category
- Food
- Dish

The following table lists the categories with the corresponding food. One or more dishes are listed beside each food.

| Categories                 | Food                         |
|----------------------------|------------------------------|
| Cake                       | Cakes in tins                |
|                            | Cakes on baking trays        |
|                            | Small baked items            |
|                            | Biscuits                     |
| Bread, bread rolls         | Bread                        |
|                            | Bread rolls                  |
| Pizza, savoury cakes       | Pizza                        |
|                            | Savoury cakes, quiches       |
| Bakes, soufflés            | Lasagne, fresh               |
|                            | Soufflé in individual moulds |
|                            | Fruit crumble                |
|                            | Yorkshire pudding            |
| Frozen products            | Pizza                        |
|                            | Bread rolls                  |
|                            | Bakes                        |
|                            | Potato products              |
|                            | Poultry, fish                |
|                            | Vegetables                   |
| Poultry                    | Chicken                      |
|                            | Duck, goose                  |
|                            | Turkey                       |
| Meat                       | Pork                         |
|                            | Beef                         |
|                            | Lamb                         |
|                            | Meat dishes                  |
| Fish                       | Fish, whole                  |
|                            | Fish fillets                 |
|                            | Fish steaks                  |
|                            | Fish dishes                  |
|                            | Seafood                      |
| Side dishes, vegetables    | Vegetables                   |
|                            | Potatoes                     |
|                            | Rice                         |
|                            | Cereals                      |
|                            | Pulses                       |
|                            | Pasta, dumplings             |
|                            | Eggs                         |
| Dessert, compote           | Dessert, compote             |
| Preserve, juice, sterilise | Sterilising bottles          |

| Categories       | Food              |
|------------------|-------------------|
| Reheat, crisp up | Vegetables        |
|                  | Menu              |
|                  | Baked goods       |
|                  | Side dishes       |
| Defrosting food  | Fruit, vegetables |

## Applying settings for dishes

You will be guided through the entire setting process for your chosen food.

Use the rotary selector to scroll through the individual levels.

1. Touch the **Menu** field.  
The list of operating modes is displayed.
2. Touch the "Assist" text field.  
The categories are displayed.
3. Touch the required category.  
The foods in this category are displayed.
4. Touch the required food.  
The individual dishes are displayed.
5. Touch the required dish.  
The settings for this dish appear on the display. For many dishes, you can change the settings to suit your needs.  
**Tip:** For some dishes, you must set the weight instead. The "Tip" text field provides you with information about accessories and shelf height.
6. Press the  $\triangleright$  Start/Stop button to start.  
The cooking time counts down in the display.  
The appliance begins to heat up.

Once the cooking time has elapsed, an audible signal sounds. The appliance stops heating up.

When your dish is ready, use the  $\odot$  On/Off button to switch off the appliance.

## Continue cooking

After the cooking time has ended, you can leave some dishes to continue cooking if you are not satisfied with the cooking result.

A query appears on the display, which asks if you want to continue cooking. If you want to continue cooking, touch the "Extend cooking time" text field. A cooking time is suggested, which can be changed. Press the  $\triangleright$  Start/Stop button to start.

**Note:** You can extend the cooking time as often as required.

If you are satisfied with the cooking result, touch the "Finish" text field.

Press the  $\odot$  On/Off button to switch off the appliance.

## Setting a later end time

You can set a later end time for some dishes. Before starting the appliance, touch the "End" text field and set a later end time using the rotary selector.

The appliance switches to standby after it is started. The end time can no longer be changed.

## Changing and cancelling

After starting the appliance, the settings can no longer be changed.

If you would like to cancel the operation, switch the appliance off using the **⏻** On/Off button. You can no longer pause the operation using the **▶** Start/Stop button.

## Tested for you in our cooking studio

Here, you can find a selection of dishes and the ideal settings for them. We will show you which type of heating and temperature are best suited to your dish. You will get information on suitable cooking accessories and the height at which they should be placed in the oven. You will also get tips about cookware and preparation methods.

**Note:** A lot of steam can build up in the cooking compartment when cooking food. Your appliance is very energy-efficient and radiates very little heat to its surroundings during operation. Due to the high difference in temperature between the appliance interior and the external parts of the appliance, condensation may build up on the door, control panel or adjacent kitchen cabinet panels. This is a normal physical phenomenon. Condensation can be reduced by preheating the oven or opening the door carefully. When steaming or during operation with steam assistance, it is desirable that there is a significant build-up of steam in the cooking compartment. Wipe the cooking compartment clean after cooking, once it has cooled off.

## Silicone moulds

For the best cooking results, we recommend dark-coloured metal baking tins/dishes.

Nevertheless, if you wish to use silicone moulds, follow the manufacturer's instructions and recipes. Silicone moulds are often smaller than normal baking tins. Quantity and recipe specifications may vary.

Silicone moulds are unsuitable for steam-assisted cooking and steaming.

## Baking

Here, you can find recommended settings for many dishes.

Also refer to the notes in the section on allowing dough to rise.

Only use original accessories supplied with your appliance. These have been tailored to the cooking compartment and the operating modes of your appliance.

## Steam-assisted baking

Certain types of baked item (e.g. yeast-risen pastries) get a more crispy crust and a more glossy surface if baked with the steam assist mode. The baked item does not dry out as much.

Steam-assisted baking is only possible on one level.

Some food turns out better if it is baked in several stages. These dishes are indicated in the table.

## Shelf positions

Use the indicated shelf positions.

### Baking on one level

When baking on one level, use the following shelf position:

- Level 1

### Baking on two levels

Use 4D hot air. Baked items that are placed into the oven on trays or in baking tins/dishes at the same time will not necessarily be ready at the same time.

- Universal pan: Level 3  
Baking tray: Level 1
- Baking tins/dishes on the wire rack  
First wire rack: Level 3  
Second wire rack: Level 1

By preparing several dishes at the same time, you can make energy savings of up to 45 per cent. Position baking tins/dishes next to one another or offset and vertically stacked in the cooking compartment.

## Accessories

Ensure that you always use suitable accessories and that they are placed in the oven the right way around.

### Wire rack

Insert the wire rack with the open side facing the appliance door and the curved lip pointing downwards. Always place ovenware, tins and dishes on the wire rack.

### Universal pan or baking tray

Slide the universal pan or the baking tray in carefully as far as the limit stop with the bevelled edge facing the appliance door.

When baking moist cakes or pastries with many toppings, use the universal pan so that any excess liquid does not overflow and make the cooking compartment dirty.

### Baking tins

Dark- coloured metal baking tins are most suitable.

Tinplate baking tins, ceramic dishes and glass dishes extend baking time and mean that the baked item will not brown evenly.

The baking tins must be resistant to heat and steam for use in steam-assisted baking.

### Greaseproof paper

Only use greaseproof paper that is suitable for the selected temperature. Always cut greaseproof paper to size.

## Recommended setting values

The table lists the optimal heating type for various baked items. The temperature and baking time depend



on the amount and consistency of the dough/mixture. For this reason, the table specifies setting ranges. Try using the lower values to start with. A lower temperature will result in more even browning. You can use a higher setting next time if necessary.

**Note:** Baking times cannot be reduced by using higher temperatures. Cakes or small baked items would only be cooked on the outside, and would not be fully baked in the middle.



The setting values apply to food that is placed into a cold cooking compartment; by doing this, you can make energy savings of up to 20 per cent. If you preheat the oven, you can reduce the indicated baking times by several minutes.

Preheating is necessary for selected food, and this is indicated in the table. Do not place your food or accessories into the cooking compartment until it has finished preheating.

If you wish to follow one of your own recipes when baking, you should use the setting values listed for similar baked items in the table as reference. Additional information can be found in the baking tips listed after the settings table.



























Remove unused accessories from the cooking compartment. This will ensure that you achieve the best possible cooking results and energy savings of up to 20 per cent.

Types of heating used:











-  4D hot air
-  Pizza setting
-  Steaming

The levels of steam intensity are indicated as numbers in the table:

- 1 = Low
- 2 = Medium
- 3 = High

| Dish                          | Accessories/cookware            | Shelf position | Type of heating  | Temperature in °C | Steam intensity | Cooking time in mins. |
|-------------------------------|---------------------------------|----------------|--|-------------------|-----------------|-----------------------|
| <b>One level baking</b>       |                                 |                |  |                   |                 |                       |
| Victoria sponge cake          | 2x Ø20 cm tins                  | 1              |    | 160-170*          | -               | 20-30                 |
| Victoria sponge cake          | 2x Ø20 cm tins                  | 1              |    | 150-160           | 1               | 25-35                 |
| Light fruit cake              | high Ø20cm tin                  | 1              |   | 140-160           | -               | 70-90                 |
| Light fruit cake              | high Ø20 cm tin                 | 1              |  | 140-150           | 1               | 90-100                |
| Rich Fruit Cake               | high Ø23cm tin                  | 1              |  | 130-150           | -               | 150-180               |
| Fruit crumble                 | flat glass dish                 | 2              |  | 150-170*          | -               | 30-45                 |
| Sponge Cake (fatless), 3 eggs | springform cake tin, Ø26 cm     | 1              |  | 160-170*          | -               | 25-35                 |
| Sponge Cake (fatless), 3 eggs | springform cake tin, Ø26 cm     | 1              |  | 150-160           | 1               | 10                    |
|                               |                                 |                |  |                   | -               | 25-35                 |
| Sponge flan, 6 eggs           | springform cake tin, Ø28 cm     | 1              |  | 150-170*          | -               | 30-50                 |
| Sponge flan, 6 eggs           | springform cake tin, Ø28 cm     | 1              |  | 150-160           | 1               | 10                    |
|                               |                                 |                |  |                   | -               | 30-35                 |
| Swiss Roll                    | swiss roll tin                  | 2              |  | 180-190*          | -               | 10-18                 |
| Swiss Roll                    | swiss roll tin                  | 2              |  | 180-190*          | 1               | 10-15                 |
| Fruit Pie                     | plate Ø20cm or pie tin          | 1              |  | 180-190           | -               | 45-50                 |
| Quiche                        | quiche tin (dark coated)        | 1              |  | 190-210           | -               | 30-45                 |
| (White) Bread                 | loaf tin (1x 900 g or 2x 450 g) | 1              |  | 190-210*          | -               | 20-30                 |
| (White) Bread                 | loaf tin (1x 900 g or 2x 450 g) | 1              |  | 210-220           | 3               | 10-15                 |
|                               |                                 |                |  | 180-190           | -               | 25-35                 |
| Scones                        | baking tray                     | 1              |  | 180-200*          | -               | 10-14                 |
| Biscuits                      | baking tray                     | 2              |  | 140-160*          | -               | 10-25                 |
| Small cakes                   | 12-cup-tin                      | 1              |  | 140-160*          | -               | 20-35                 |
| Puff pastry slices            | baking tray                     | 2              |  | 170-190*          | -               | 20-45                 |
| Puff pastry slices            | baking tray                     | 1              |  | 210-220*          | 1               | 15-25                 |
| Jam tarts                     | 12-cup-tin                      | 2              |  | 160-180*          | -               | 15-30                 |
| Meringue                      | baking tray                     | 2              |  | 90-100*           | -               | 100-130               |
| Pavlova                       | baking tray                     | 2              |  | 90-100*           | -               | 120-180               |
| Soufflé                       | 1,2 L-soufflé dish              | 1              |  | 160-170*          | -               | 40-50                 |
| Soufflé                       | 1,2 L-soufflé dish              | 1              |  | 170-180           | 2               | 35-45                 |

\* Preheat

| Dish                       | Accessories/cookware | Shelf position | Type of heating   | Temperature in °C | Steam intensity | Cooking time in mins. |
|----------------------------|----------------------|----------------|---|-------------------|-----------------|-----------------------|
| Soufflé                    | individual moulds    | 1              |  | 100               | -               | 40-45                 |
| Choux pastry               | baking tray          | 1              |  | 190-210*          | -               | 30-40                 |
| Choux pastry               | baking tray          | 1              |  | 200-220*          | 1               | 25-35                 |
| Meat Pie                   | rectangular pie tin  | 1              |  | 180-190           | -               | 40-50                 |
| Meat Pie                   | rectangular pie tin  | 1              |  | 170-180           | 2               | 40-50                 |
| Yorkshire Pudding          | 12-cup-tin           | 1              |  | 200-220*          | -               | 15-25                 |
| Jacket potatoes            | baking tray          | 2              |  | 150-170           | -               | 75-90                 |
| Jacket potatoes            | baking tray          | 2              |  | 180-190           | 1               | 40-50                 |
| Pizza, homemade            | baking tray          | 1              |  | 200-220           | -               | 20-30                 |
| Pizza, homemade            | baking tray          | 1              |  | 220-230           | -               | 25-30                 |
| Pizza, homemade, thin base | pizza tray           | 1              |  | 210-230           | -               | 20-30                 |

### Multishelf baking

|                                |                             |     |   |          |   |         |
|--------------------------------|-----------------------------|-----|---|----------|---|---------|
| Victoria sponge cake, 2 levels | 4x Ø20 cm tins              | 3+1 |    | 160-170* | - | 20-35   |
| Scones, 2 levels               | 2 baking trays              | 3+1 |    | 180-200* | - | 12-16   |
| Biscuits, 2 levels             | 2 baking trays              | 3+1 |    | 140-160* | - | 15-30   |
| Small cakes, 2 levels          | 2x 12-cup-tins              | 3+1 |    | 140-160* | - | 22-32   |
| Puff pastry slices, 2 levels   | 2 baking trays              | 3+1 |    | 170-190* | - | 20-45   |
| Jam tarts, 2 levels            | 2x 12-cup-tins              | 3+1 |    | 160-180* | - | 20-35   |
| Meringues, 2 levels            | 2 baking trays              | 3+1 |   | 90-100*  | - | 100-130 |
| Jacket potatoes, 2 levels      | universal pan + baking tray | 3+1 |  | 150-170* | - | 75-90   |
| Pizza, homemade, 2 levels      | universal pan + baking tray | 3+1 |  | 180-200  | - | 35-45   |

\* Preheat

### Tips on baking

|   |   |
|---|---|
| You want to find out whether the cake is completely cooked in the middle. | Push a cocktail stick into the highest point on the cake. If the cocktail stick comes out clean with no dough residue, the cake is ready.   |
| The cake collapses.   | Next time, use less liquid. Alternatively, set the temperature to be 10 °C lower and extend the baking time. Adhere to the specified ingredients and preparation instructions in the recipe.  |
| The cake has risen in the middle but is lower around the edge.            | Only grease the base of the springform cake tin. After baking, loosen the cake carefully with a knife.  |
| The fruit juice overflows.  | Next time, use the universal pan.   |
| Small baked items stick to one another during baking.                     | There should be a gap of approx. 2 cm around each item. This gives enough space for the baked items to expand well and brown on all sides.  |
| The cake is too dry.  | Set the temperature 10 °C higher and shorten the baking time.   |
| The cake is generally too light in colour.                                | If the shelf position and the cookware are correct, then you should increase the temperature if necessary or extend the baking time.  |
| The cake is too light on top, and too dark underneath.                    | Bake the cake one level higher in the oven the next time.   |
| The cake is too dark on top, and too light underneath.                    | Bake the cake one level lower in the oven the next time. Select a lower temperature and extend the baking time.   |
| Cakes baked in a tray or tin are too brown at the back.                   | Place the baking tray in the middle of the accessories, not directly against the back wall.   |
| The whole cake is too dark.   | Select a lower temperature next time and extend the baking time if necessary.   |
| The cake is unevenly browned.   | Select a slightly lower temperature.<br>Protruding greaseproof paper can affect the air circulation. Always cut greaseproof paper to size.<br>Ensure that the baking tin does not stand directly in front of the openings in the cooking compartment back wall.<br>When baking small items, you should use similar sizes and thicknesses wherever possible. |

|   |   |
|---|---|
| You were baking on several levels. The items on the top baking tray are darker than those on the lower baking tray. | Always select 4D hot air when baking on several levels. Baked items that are placed into the oven on trays or in baking tins/dishes at the same time will not necessarily be ready at the same time.  |
| The cake looks good, but is not cooked properly in the middle.  | Use a lower temperature and bake slightly longer; if necessary, add slightly less liquid. For cakes with a moist topping, bake the base first. Sprinkle it with almonds or breadcrumbs and then place the topping on top.   |
| The cake cannot be turned out of the dish when it is turned upside down.  | Allow the cake to cool down for 5 to 10 minutes after baking. If it still sticks, carefully loosen the cake around the edges again using a knife. Turn the cake tin upside down again and cover it several times with a cold, wet cloth. Next time, grease the baking tin/dish and sprinkle with breadcrumbs. |

## Roasting and braising

Here, you can find information on roasting and braising poultry and meat. You can find the ideal settings for many dishes in the settings tables.

### Poultry

For duck or goose, pierce the skin on the underside of the wings. This allows the fat to run out.

If using duck breast, score the skin. Do not turn duck breasts.

When you turn poultry, ensure that the breast side or the skin side is underneath at first.

Poultry will turn out particularly crispy and brown if you baste it towards the end of the roasting time with butter, salted water or orange juice.

### Meat

Baste lean meat with fat as required or cover it with strips of bacon.

Score the rind crosswise. If you turn the joint when cooking, ensure that the rind is underneath at first.

When the joint is ready, turn off the oven and allow it to rest for another 10 minutes in the cooking compartment. This allows the meat juices to be better distributed. Wrap the joint in aluminium foil if necessary. The recommended resting time is not included in the cooking time indicated.

### Roasting on the wire rack

On the wire rack, poultry and meat will become very crispy on all sides. Roasting on the wire rack is well suited for larger poultry or for multiple pieces at the same time.

Depending on the size and type of the meat, add up to ½ litres of water to the universal pan. Any dripping fat and meat juices will be caught. You can prepare a sauce using these meat juices. In addition, less smoke is generated, and the cooking compartment stays cleaner.

Slide the universal pan into the oven at the indicated shelf position with the wire rack attached. Ensure that the wire rack is correctly positioned on the universal pan. → "Accessories" on page 12

### Roasting and braising in cookware

It is more convenient to roast and braise meat in cookware. You can take the joint out of the cooking compartment more easily in the cookware, and prepare the sauce in the cookware itself.

Only use cookware which is suitable for use in an oven. Check whether the cookware fits in the cooking compartment.

Glass cookware is most suitable. Place hot glass cookware onto a dry mat after cooking. If the surface is damp or cold, the glass may crack.

Add in a little liquid for roasting if the meat is lean. A covering of approx. ½ cm depth should be applied to the base of any glass cookware.

The amount of liquid is dependent on the type of meat, the cookware material and also on whether or not a lid is used. If preparing meat in an enamelled or dark metal roasting dish, it will need a little more liquid than if cooked in glass cookware.

The steam evaporates in the cookware when roasting. Carefully pour in more liquid if required.

Shiny roasting dishes made from stainless steel or aluminium reflect heat like a mirror and are therefore not particularly suitable. The meat cooks more slowly and will not brown so much. Use a higher temperature and/or a longer cooking time.

Observe the manufacturer's instructions for your roasting cookware.

### Roasting in uncovered cookware

It is best to use a deep roasting tin/dish for roasting poultry and meat. Place the tin/dish onto the wire rack. If you do not have any suitable cookware, use the universal pan.

### Braising in covered cookware

When preparing food with covered cookware, the cooking compartment remains considerably cleaner. Ensure that the lid fits well and closes properly. Place the cookware onto the wire rack.

The distance between the meat and the lid must be at least 3 cm. The meat may rise.

Very hot steam may escape when opening the lid after cooking. Lift the lid at the rear, so that the hot steam can escape away from you.

If necessary, braise the meat first by searing it. Add water, wine, vinegar or a similar liquid to the braising liquid. A covering at least 2 cm deep should be applied to the base of the cookware.

The steam evaporates in the cookware when roasting. Carefully pour in more liquid if required.

### Steam- assisted roasting and braising

Certain dishes become crispier if cooked using steam, and do not dry out as much.

Use uncovered cookware. Cookware must be heat- and steam-resistant.

The joints do not have to be turned.

Use steam-assisted cooking if it is indicated in the settings table. Some dishes turn out best if they are cooked in several stages. These are indicated in the table.

### Steaming

By contrast to the steam assistance function, the steaming function cooks the meat particularly gently, but it does not become crispy on the outside. It remains very succulent. As an alternative, you can also fry pieces of meat quickly before steaming; the cooking time will be reduced.

Larger pieces require a longer heating-up time and a longer cooking time. If you are using several pieces which are the same weight, the heating-up time is increased, and not the cooking time.

Pieces of meat do not need to be turned.

Use the perforated steam container (size XL) and slide the universal pan in underneath. You can also use a glass tray and place this onto the wire rack.

### Recommended setting values

In the table, you can find the ideal heating type for poultry and meat. Temperature and cooking time depend on the quantity, composition and temperature of the food. Different settings ranges are indicated for this reason. Try using the lower values at first. You can increase the temperature next time if necessary.

The setting values are based on the assumption that unstuffed, chilled, ready-to-roast poultry and meat are placed into a cold cooking compartment. By doing so, you can make energy savings of up to 20 per cent. If

you preheat the oven, the indicated cooking times will be reduced by several minutes.

In the table, you can find specifications for poultry and meat with default values for the weight. If you wish to prepare heavier poultry or meat, use the lower temperature in every case. If roasting several joints, use the weight of the heaviest piece as a basis for determining the cooking time. The individual pieces should be approximately equal in size.

A general rule: the larger the poultry or piece of meat is, the lower the cooking temperature and the longer the cooking time.

Turn the poultry and meat after approx. 1/2 to 2/3 of the indicated time.

Remove unused accessories from the cooking compartment. This will achieve the best possible cooking results and energy savings of up to 20 per cent.

Cooking time calculation (e. g. 20+35): Please calculate the cooking time with 20 minutes per 500 g meat + 35 minutes additional time. For 1,5 kg the calculated cooking time would be 95 minutes.











Cooking time range (e. g. 10-15): The food is done within the stated minutes.

Type of heating used:

-  4D hot air

The levels of steam intensity are indicated as numbers in the table:

- 1 = Low
- 2 = Medium
- 3 = High

| Dish                        | Accessories/cookware | Shelf position | Type of heating   | Temperature in °C | Steam intensity | Time in min. |
|-----------------------------|----------------------|----------------|---|-------------------|-----------------|--------------|
| <b>Beef</b>                 |                      |                |   |                   |                 |              |
| Slow roasting joint         | wire rack            | 1              |  | 140-150           | -               | 35+40        |
| Slow roasting joint, 1.5 kg | wire rack            | 1              |  | 130-140           | 1               | 70-80        |
|                             |                      |                |   |                   | -               | 40-50        |
| Top side / Top rump         | wire rack            | 1              |  | 160-170           | -               | 30+25        |
| Top side / Top rump         | wire rack            | 1              |  | 170-180           | 1               | 100-120      |
| <b>Lamb</b>                 |                      |                |   |                   |                 |              |
| Leg (bone-in)               | wire rack            | 1              |  | 160-170           | -               | 25+25        |
| Leg (bone-in), 1.5 kg       | wire rack            | 1              |  | 180-190           | 1               | 80-90        |
| Shoulder (bone-in)          | wire rack            | 1              |  | 160-170           | -               | 25+20        |
| Shoulder (boned and rolled) | wire rack            | 1              |  | 170-180           | -               | 25+25        |
| Rack of lamb***             | wire rack            | 1              |  | 180-190*          | -               | 15+25        |
| Rack of lamb, each 700 g    | wire rack            | 1              |  | 200               | -               | 20           |
|                             |                      |                |   | 170-180           | 1               | 25-30        |

\* Preheat  
 \*\* skin side down  
 \*\*\* without fat layer (best and neck), do not turn  
 \*\*\*\* bone side down, do not turn

| Dish                                      | Accessories/cookware  | Shelf position | Type of heating | Temperature in °C                 | Steam intensity | Time in min.   |
|---|-----------------------|----------------|-----------------|-----------------------------------|-----------------|--|
| <b>Pork</b>                               |                       |                |                 |                                   |                 |  |
| Roasting joint                            | wire rack             | 1              |                 | 180-190                           | -               | 30+35  |
| Roasting joint, 1.5 kg                    | wire rack             | 1              |                 | 120                               | 3               | 30   |
|   |                       |                |                 | 190-200                           | -               | 30   |
|   |                       |                |                 | 160-170                           | 1               | 80-100   |
| Loin joint                                | wire rack             | 1              |                 | 180-190                           | -               | 35+35  |
| Loin joint, 1 kg                          | wire rack             | 1              |                 | 180-190                           | -               | 25-30  |
|   |                       |                |                 | 170-180                           | 1               | 70-80  |
| Belly                                     | wire rack             | 1              |                 | 170-180                           | -               | 30+25  |
| Gammon joint                              | wire rack             | 1              |                 | 160-170                           | -               | 30+30  |
| Gammon joint, 1.5 kg                      | wire rack             | 1              |                 | 170-180                           | 2               | 100-120  |
| <b>Poultry</b>                            |                       |                |                 |                                   |                 |  |
| Chicken, whole                            | wire rack             | 1              |                 | 170-180                           | -               | 25+15  |
| Chicken, whole, 1.5 kg                    | wire rack             | 1              |                 | 180-190                           | 2               | 65-75  |
| Chicken, portion, 200-250 g each**        | wire rack             | 1              |                 | 190-200                           | -               | 35-45  |
| Chicken, portion, 200-250 g each**        | wire rack             | 2              |                 | 200-210                           | 2               | 35-45  |
| Duck                                      | wire rack             | 1              |                 | 180-190                           | -               | 25+20  |
| Duck, 2-3 kg                              | wire rack             | 1              |                 | 160-170                           | 2               | 70-90  |
|   |                       |                |                 | 170-180                           | -               | 30-40  |
| Turkey, crown****                         | wire rack             | 1              |                 | 150-160                           | -               | 20+15  |
| Turkey, crown, 3 kg                       | cookware, uncovered   | 1              |                 | 140-150                           | 2               | 100-140  |
| Turkey, thighs                            | wire rack             | 1              |                 | 170-180                           | -               | 25+30  |
| Turkey, whole, 4-8 kg                     | wire rack             | 1              |                 | 150-160                           | -               | 12+12  |
| Turkey, whole, 7 kg                       | universal pan         | 1              |                 | 140-150                           | 2               | 120-150  |
|   |                       |                |                 | 170-180                           | -               | 30-40  |
| <b>Meat dishes</b>                        |                       |                |                 |                                   |                 |  |
| Meat loaf                                 | cookware, uncovered   | 1              |                 | 170-180                           | -               | 20+35  |
| Meat loaf, 1 kg                           | cookware, uncovered   | 1              |                 | 190-200                           | 1               | 70-80  |
| <b>Casserole</b>                          |                       |                |                 |                                   |                 |  |
| Diced meat (beef, pork, lamb), 500 g meat | cookware, covered     | 1              |                 | 140*                              | -               | 100-120  |
| Braising steak                            | cookware, covered     | 1              |                 | 140                               | -               | 65+60  |
| Chicken pieces (boned), 500 g meat        | cookware, covered     | 1              |                 | 140*                              | -               | 90-100   |
| <b>Complete meal</b>                      |                       |                |                 |                                   |                 |  |
| With beef                                 | wire rack + wire rack | 3+1            |                 | 160, then 200 (Yorkshire Pudding) | -               | calculation for meat (see table above) + 15-25 for Yorkshire Pudding |



\* Preheat

\*\* skin side down

\*\*\* without fat layer (best and neck), do not turn

\*\*\*\* bone side down, do not turn



| Dish         | Accessories/cookware  | Shelf position | Type of heating   | Temperature in °C | Steam intensity                                  | Time in min.                              |
|--------------|-----------------------|----------------|---|-------------------|--|---|
| With chicken | wire rack + wire rack | 3+1            |  | 180               | -  | calculation for chicken (see table above) |
| With chicken | wire rack + wire rack | 3+1            |  | 180               | low (steam 0 when Yorkshire Pudding is inserted) | 65-75                                     |

\* Preheat  
 \*\* skin side down  
 \*\*\* without fat layer (best and neck), do not turn  
 \*\*\*\* bone side down, do not turn

### Tips on roasting and braising

|   |  |
|---|--|
| The cooking compartment becomes very dirty.   | Prepare your food in an enclosed roasting dish with higher temperature or use the grill tray. You will achieve the best roasting results if you use the grill tray. The grill tray can be bought later as a special accessory. |
| The roast is too dark and the crackling is burned in places, and/or the roast is too dry. | Check the shelf position and temperature. Select a lower temperature the next time and reduce the roasting time if necessary.  |
| The crackling is too thin.  | Increase the temperature or switch on the grill briefly at the end of the roasting time.   |
| The roast looks good but the juices are burnt.  | Next time, use a smaller roasting dish and add more liquid if necessary.   |
| The roast looks good but the juices are too clear and watery.                             | Next time, use a larger roasting dish and add less liquid if necessary.  |
| The meat gets burned during braising.   | The roasting dish and lid must fit together well and close properly.<br>Reduce the temperature and add more liquid when braising if necessary.   |

### Grilling

Here, you can find information on grilling poultry, meat and fish, as well as toast. You can find the ideal settings for certain dishes in the settings tables.

#### Grilling with circulated air

Circulated air grilling is very well suited to the preparation of whole poultry, fish, and also meat, e.g. roast pork with crackling.

#### Poultry

For duck or goose, pierce the skin on the underside of the wings. This allows the fat to run out.

If using duck breast, score the skin. Do not turn duck breasts.

When you turn poultry, ensure that the breast side or the skin side is underneath at first.

Poultry will turn out particularly crispy and brown if you baste it towards the end of the roasting time with butter, salted water or orange juice.

#### Meat

Baste lean meat with fat as required or cover it with strips of bacon.

Score the rind crosswise. If you turn the joint when cooking, ensure that the rind is underneath at first.

When the joint is ready, turn off the oven and allow it to rest for another 10 minutes in the cooking

compartment. This allows the meat juices to be better distributed. Wrap the joint in aluminium foil if necessary. The recommended resting time is not included in the cooking time indicated.

#### Fish

Fish cooked whole does not have to be turned. Place the whole fish into the cooking compartment in swimming position with the dorsal fin facing upwards. Placing half a potato or a small oven-proof container in the stomach cavity of the fish will provide stability.

You can tell when the fish is cooked because the dorsal fin can be removed easily.

#### Roasting on the wire rack

On the wire rack, poultry and meat will become very crispy on all sides. Roasting on the wire rack is well suited for larger poultry or for multiple pieces at the same time.

Depending on the size and type of the meat, add up to ½ litres of water to the universal pan. Any dripping fat and meat juices will be caught. You can prepare a sauce using these meat juices. In addition, less smoke is generated, and the cooking compartment stays cleaner.

Slide the universal pan into the oven at the indicated shelf position with the wire rack attached. Ensure that the wire rack is correctly positioned on the universal pan. → "Accessories" on page 12

## Roasting in cookware

It is more convenient to roast and braise meat in cookware. You can take the joint out of the cooking compartment more easily in the cookware, and prepare the sauce in the cookware itself.

Only use cookware which is suitable for use in an oven. Check whether the cookware fits in the cooking compartment.

Glass cookware is most suitable. Place hot glass cookware onto a dry mat after cooking. If the surface is damp or cold, the glass may crack.

Add in a little liquid if the meat is lean. A covering of approx. ½ cm depth should be applied to the base of any glass cookware.

The quantity of liquid is dependent on the type of meat, the cookware material and also on whether or not a lid is used. If preparing poultry, meat or fish in an enamelled or dark metal roasting dish, it will need a little more liquid than if cooked in glass cookware.

The steam evaporates in the cookware when roasting. Carefully pour in more liquid if required.

Shiny roasting dishes made from stainless steel or aluminium reflect heat like a mirror and are therefore not particularly suitable. The meat cooks more slowly and will not brown so much. Use a higher temperature and/or a longer cooking time.

Observe the manufacturer's instructions for your roasting cookware.

### Uncovered cookware

Use a deep roasting tin/dish for roasting meat. Place the tin/dish onto the wire rack. If you do not have any suitable cookware, use the universal pan.

### Covered cookware

When cooking with covered cookware, the cooking compartment remains considerably cleaner. Ensure that the lid fits well and closes properly. Place the cookware onto the wire rack.

The distance between the meat and the lid must be at least 3 cm. The meat may rise.

Very hot steam may escape when opening the lid after cooking. Lift the lid at the rear, so that the hot steam can escape away from you.

If necessary, braise the meat first by searing it. Add water, wine, vinegar or a similar liquid to the braising liquid. A covering approx. 1-2 cm deep should be applied to the base of the cookware.

The steam evaporates in the cookware when roasting. Carefully pour in more liquid if required.

Meat can also become crispy in a covered roasting dish. To do so, use a roasting dish with a glass lid and set a higher temperature.

## Steam- assisted roasting

Certain foodstuffs will become crispier during steam-assisted cooking. Their surface becomes glossier and they dry out less.

Use uncovered cookware. Cookware must be heat- and steam-resistant.

Use steam-assisted cooking if it is indicated in the settings table. Some dishes turn out best if they are

cooked in several stages. These are indicated in the table.

## Grilling flat pieces

Flat pieces of poultry, meat and fish, such as steaks, drumsticks and burgers, can be prepared well using the "Grill" heating type. Excellent results are also achieved when grilling toast.

## Grilling

Keep the appliance door closed when using the grill. Never grill with the appliance door open.

Place the food to be grilled on the wire rack. In addition, slide the universal pan in at least one shelf position lower, with the slanted edge facing the appliance door. Any dripping fat will be caught.

When grilling, try wherever possible to use pieces of food which are of a similar thickness and weight. This will allow them to brown evenly and remain succulent and juicy. Place the food to be grilled directly onto the wire rack.

Use tongs to turn the pieces of food you are grilling. If you pierce the meat with a fork, the juices will run out and it will become dry.

Do not add salt until after the meat has been grilled. Salt draws water from the meat.

## Notes

- The grill element switches itself continuously on and off; this is normal. The grill setting determines how frequently this occurs.
- Smoke may be produced when grilling.

## Recommended setting values

In the table, you can find the ideal heating type for your poultry, meat and fish, in addition to toast. Temperature and cooking time depend on the quantity, composition and temperature of the food. Settings ranges are indicated for this reason. Try using the lower values at first. You can use a higher setting next time if necessary.

The setting values are based on the assumption that unstuffed, chilled, ready-to-roast poultry, meat and fish are placed into a cold cooking compartment.

In the table, you can find specifications for poultry, meat and fish with default values for the weight. If you wish to prepare heavier poultry, meat or fish, use the lower temperature in every case. If roasting several joints, use the weight of the heaviest piece as a basis for determining the cooking time. The individual pieces should be approximately equal in size.

A general rule: the larger the poultry, meat or fish is, the lower the cooking temperature and the longer the cooking time.

Turn the poultry, meat and fish after approx. ½ to ⅔ of the indicated time.

Remove unused accessories from the cooking compartment. This will achieve the best possible cooking results and energy savings of up to 20 per cent.

Cooking time calculation (e. g. 20+35):  
Please calculate the cooking time with 20 minutes per

500 g meat + 35 minutes additional time. For 1,5 kg the calculated cooking time would be 95 minutes.





















Cooking time range (e. g. 10-15):  
The food is done within the stated minutes.

Types of heating used:

-  Circulated air grilling
-  Grill, large area

The levels of steam intensity are indicated as numbers in the table:

- 1 = Low
- 2 = Medium
- 3 = High

| Dish                          | Accessories | Shelf position | Type of heating   | Temperature in C / Grill setting | Steam intensity | Time in min.   |
|-------------------------------|-------------|----------------|---|----------------------------------|-----------------|----------------|
| <b>Beef</b>                   |             |                |   |                                  |                 |                |
| Steaks, height 2-3 cm         | wire rack   | 2              |    | 3                                | -               | 1st side 8-10  |
|                               |             |                |   |                                  |                 | 2nd side 5-7   |
| Burger, height 1-2 cm         | wire rack   | 2              |    | 3*                               | -               | 1st side 6-8   |
|                               |             |                |   |                                  |                 | 2nd side 4-6   |
| Top side / Top rump           | wire rack   | 2              |    | 150-160                          | -               | 30+30          |
| <b>Lamb</b>                   |             |                |   |                                  |                 |                |
| Steaks, height 2-3 cm         | wire rack   | 2              |    | 3*                               | -               | 1st side 8-10  |
|                               |             |                |   |                                  |                 | 2nd side 4-6   |
| Chops, height 2-3 cm          | wire rack   | 2              |    | 3                                | -               | 1st side 6-8   |
|                               |             |                |   |                                  |                 | 2nd side 6-8   |
| Leg (bone-in)                 | wire rack   | 1              |    | 170-180                          | -               | 25+30          |
| Leg (bone-in), 1.5 kg         | wire rack   | 1              |   | 170-180                          | 1               | 80-90          |
| Shoulder (bone-in)            | wire rack   | 1              |  | 170-190                          | -               | 25+15          |
| Shoulder (boned and rolled)   | wire rack   | 1              |  | 170-180                          | -               | 20+15          |
| Rack of lamb                  | wire rack   | 1              |  | 190-200                          | -               | 15+25          |
| <b>Pork</b>                   |             |                |   |                                  |                 |                |
| Steaks, height 2 cm           | wire rack   | 3              |  | 2                                | -               | 1st side 12-14 |
|                               |             |                |   |                                  |                 | 2nd side 6-8   |
| Chops, height 2-3 cm          | wire rack   | 2              |  | 3*                               | -               | 1st side 10-12 |
|                               |             |                |   |                                  |                 | 2nd side 9-10  |
| Burger, height 1-2 cm         | wire rack   | 2              |  | 3*                               | -               | 1st side 6-8   |
|                               |             |                |   |                                  |                 | 2nd side 4-6   |
| Bacon rashers                 | wire rack   | 2              |  | 3***                             | -               | 1st side 4-5   |
|                               |             |                |   |                                  |                 | 2nd side 3-4   |
| Sausages, thickness 2-4 cm    | wire rack   | 2              |  | 3****                            | -               | 10-15          |
| Roasting joint                | wire rack   | 1              |  | 180-200                          | -               | 30-40          |
| Loin joint                    | wire rack   | 1              |  | 170-180                          | -               | 35+35          |
| Belly                         | wire rack   | 1              |  | 200-220                          | -               | 30+25          |
| Belly, 1 kg                   | wire rack   | 1              |  | 170-180                          | 1               | 50-60          |
|                               |             |                |   | 190-200                          | -               | 25-35          |
| Gammon joint                  | wire rack   | 2              |  | 180-200                          | -               | 30+25          |
| <b>Poultry</b>                |             |                |   |                                  |                 |                |
| Chicken drumstick, 150 g each | wire rack   | 2              |  | 210-230                          | -               | 20-30          |















\* Preheat

\*\* Preheat 3 minutes

\*\*\* Preheat 5 minutes

\*\*\*\* Preheat 3 minutes, turn over several times

\*\*\*\*\* Skin side down

| Dish                                 | Accessories | Shelf position | Type of heating   | Temperature in C / Grill setting | Steam intensity | Time in min.                     |
|--------------------------------------|-------------|----------------|---|----------------------------------|-----------------|----------------------------------|
| Chicken drumstick, 150 g each        | wire rack   | 2              |    | 210-220                          | 2               | 30-40                            |
| Chicken breast, boned, 150 g each    | wire rack   | 2              |    | 3**                              | -               | 1st side 10-15<br>2nd side 10-15 |
| Chicken breast, boned, 150 g each    | wire rack   | 2              |    | 200-210                          | 2               | 20-30                            |
| Chicken, whole                       | wire rack   | 1              |    | 200-220                          | -               | 25+15                            |
| Chicken, whole, 1.5 kg               | wire rack   | 1              |    | 180-190                          | 2               | 65-75                            |
| Chicken, portion, 200-250 g each**** | wire rack   | 2              |    | 200-220                          | -               | 30-45                            |
| Chicken, portion, 200-250 g each**** | wire rack   | 2              |    | 200-210                          | 2               | 35-45                            |
| Duck, 2-3 kg                         | wire rack   | 1              |    | 190-200                          | -               | 20+20                            |
| Duck, 2-3 kg                         | wire rack   | 1              |    | 150-160                          | 2               | 100-120                          |
| Turkey thighs                        | wire rack   | 1              |    | 180-190                          | -               | 25+30                            |
| Turkey, whole, 4-8 kg                | wire rack   | 1              |    | 140-160                          | -               | 12+12                            |
| <b>Fish</b>                          |             |                |   |                                  |                 |                                  |
| Trout, whole, 300 g each             | wire rack   | 1              |    | 170-190                          | -               | 20-30                            |
| Fillets, each 150 g                  | wire rack   | 2              |    | 1**                              | -               | 1st side 5-10<br>2nd side 5-10   |
| <b>Toast</b>                         |             |                |   |                                  |                 |                                  |
| Grilling white bread                 | wire rack   | 3              |  | 3                                | -               | 2-6                              |

\* Preheat

\*\* Preheat 3 minutes

\*\*\* Preheat 5 minutes

\*\*\*\* Preheat 3 minutes, turn over several times

\*\*\*\*\* Skin side down

## Convenience products

Here, you can find the ideal settings for preparing chilled and frozen food.

Only use original accessories supplied with your appliance. These have been tailored to the cooking compartment and the operating modes of your appliance.

### Tips

- The cooking result greatly depends on the quality of the food. Pre-browning and unevenness may already be present on the packaged product.
- Do not use frozen products that are heavily frosted. Remove any ice on the food.
- Distribute foods which are in pieces, such as bread rolls and potato products, so that they are spread flat and evenly on the accessories. Leave a little space between the individual pieces.
- Observe the instructions on the packaging.

### Steam-assisted baking

Certain types of baked item (e.g. yeast-risen pastries) get a more crispy crust and a more glossy surface if baked with the steam assist mode. The baked item does not dry out as much.

Steam-assisted baking is only possible on one level.

## Shelf positions

Use the indicated shelf positions.

### Baking on one level

When baking on one level, use the following shelf position:

- Level 1

### Baking on two levels

Use 4D hot air. Baked items that are placed into the oven on trays or in baking tins/dishes at the same time will not necessarily be ready at the same time.

- Universal pan: Level 3  
Baking tray: Level 1

## Accessories

Ensure that you always use suitable accessories and that they are placed in the oven the right way around.

### Wire rack

Insert the wire rack with the open side facing the appliance door and the curved lip pointing downwards. Always place ovenware, tins and dishes on the wire rack.

### Universal pan or baking tray

Slide the universal pan or the baking tray in carefully as

far as the limit stop with the bevelled edge facing the appliance door.

### Greaseproof paper

Only use greaseproof paper that is suitable for the selected temperature. Always cut greaseproof paper to size.

### Recommended setting values

In the table, you can find the ideal heating type for various dishes. Temperature and cooking time depend on the quantity and composition of the product. Setting ranges are indicated for this reason. Try using the lower values at first. A lower temperature results in more even browning. You can use a higher setting next time if necessary.

**Note:** Cooking times cannot be reduced by using higher temperatures. The dish would only be cooked on the outside, but would not be fully cooked in the middle.



The setting values apply to dishes placed into a cold cooking compartment. By doing so, you can make

energy savings of up to 20 per cent. If you preheat the oven, the indicated cooking times will be reduced by several minutes.

Preheating is necessary for selected dishes, and this is indicated in the table.





















Remove unused accessories from the cooking compartment. This will achieve the best possible cooking results and energy savings of up to 20 per cent.

Types of heating used:

-  4D hot air
-  Top/bottom heating
-  Pizza setting

The levels of steam intensity are indicated as numbers in the table:

- 1 = Low
- 2 = Medium
- 3 = High

| Dish                                 | Accessories/cookware            | Shelf position | Type of heating   | Temperature in °C | Steam intensity | Cooking time in mins. |
|--------------------------------------|---------------------------------|----------------|---|-------------------|-----------------|-----------------------|
| <b>Pizza, chilled</b>                |                                 |                |   |                   |                 |                       |
| Pizza, chilled                       | wire rack                       | 1              |    | 210-230           | -               | 10-20                 |
| <b>Pizza, frozen</b>                 |                                 |                |   |                   |                 |                       |
| Pizza, thin base                     | wire rack                       | 1              |  | 210-230           | -               | 10-20                 |
| Pizza, thin base, 2 levels           | 2 wire racks                    | 3+1            |  | 200-220           | -               | 15-25                 |
| Pizza, thick base                    | wire rack                       | 1              |  | 190-210           | -               | 20-30                 |
| Pizza, thick base, 2 levels          | 2 wire racks                    | 3+1            |  | 160-180           | -               | 25-35                 |
| Pizza baguette                       | wire rack                       | 1              |  | 200-220           | -               | 20-30                 |
| <b>Potatoe products, frozen</b>      |                                 |                |   |                   |                 |                       |
| Oven chips*                          | baking tray                     | 1              |  | 190-210           | -               | 20-30                 |
| Oven chips, 2 levels*                | universal pan + baking tray     | 3+1            |  | 200-220           | -               | 30-40                 |
| Croquettes                           | baking tray                     | 1              |  | 200-220           | -               | 15-25                 |
| Hash browns*                         | universal pan                   | 2              |  | 200-220           | -               | 20-30                 |
| Potatoe wedges                       | baking tray                     | 1              |  | 200-220           | -               | 20-30                 |
| <b>Baked goods, frozen, prebaked</b> |                                 |                |   |                   |                 |                       |
| Rolls, baguettes                     | universal pan                   | 2              |  | 200-220           | -               | 15-25                 |
| Rolls, baguettes                     | universal pan                   | 2              |  | 180-200           | 1               | 15-25                 |
| Rolls, baguettes, 2 levels           | grid + universal pan            | 3+1            |  | 160-180           | -               | 15-25                 |
| <b>Fried food, frozen</b>            |                                 |                |   |                   |                 |                       |
| Fish fingers*                        | baking tray                     | 1              |  | 220-240           | -               | 10-20                 |
| Chicken nuggets                      | universal pan                   | 2              |  | 200-220           | -               | 10-20                 |
| <b>Food, chilled</b>                 |                                 |                |   |                   |                 |                       |
| Lasagna, 500 g                       | ovenproof dish on wire rack     | 1              |  | 180-200           | -               | 30-40                 |
| Lasagna, 500 g                       | ovenproof dish on wire rack     | 1              |  | 180-190           | 2               | 30-40                 |
| Lasagna, 1,5 kg                      | ovenproof dish on universal pan | 1              |  | 180-200           | -               | 35-45                 |
| Lasagna, 1,5 kg                      | ovenproof dish on wire rack     | 1              |  | 160-170           | 2               | 35-45                 |

\* Turn during cooking



| Dish                | Accessories/cookware            | Shelf position | Type of heating | Temperature in °C | Steam intensity | Cooking time in mins. |
|---------------------|---------------------------------|----------------|-----------------|-------------------|-----------------|-----------------------|
| <b>Food, frozen</b> |                                 |                |                 |                   |                 |                       |
| Lasagna, 500 g      | ovenproof dish on universal pan | 1              |                 | 190-210           | -               | 30-40                 |
| Lasagna, 500 g      | ovenproof dish on wire rack     | 1              |                 | 180-190           | 2               | 40-50                 |
| Lasagna, 1,5 kg     | ovenproof dish on universal pan | 1              |                 | 160-180           | -               | 60-80                 |
| Lasagna, 1,5 kg     | ovenproof dish on wire rack     | 1              |                 | 160-170           | 2               | 45-55                 |

\* Turn during cooking

## Steaming

Only use original accessories. When steaming in the perforated steam container (size XL), always slide the universal pan in underneath as well. Dripping liquid is caught.

### Steaming on one level

Use the shelf positions indicated in the settings tables.

### Steaming on two levels

Steaming on two levels is very well suited to simultaneously cooking broccoli and potatoes, for example. In cases where the cooking times are different, insert the foodstuff with the shorter cooking time later.

- Wire rack and attached steam container (size S), perforated and/or unperforated: Level 3
- Perforated steam container (size XL): Level 2

### Cookware

If you use cookware, place it onto the wire rack or the perforated steam container, size XL.

Ovenware must be heat and steam resistant. Cooking times are increased when using cookware with thick edges.

Food which would normally be prepared in a water bath should always be covered with foil.

### Cooking time and quantity

Cooking times when steaming are dependent on the size of the pieces, but not dependent on the total quantity. If a larger total quantity is used, the heating-up time is increased and not the cooking time.

Larger pieces require a longer heating-up time and a longer cooking time. If you are using several pieces which are the same weight, the heating-up time is increased, and not the cooking time.

Observe the unit sizes indicated in the settings table. The cooking time is reduced for smaller pieces and increased for larger ones. Cooking time is also influenced by the quality and ripeness of the food. This means that the setting values indicated are purely guidelines.

Always distribute the food evenly in the cookware. It will not cook evenly if the layers are of different depths. When layering delicate foods in the cooking container, do not pile them too high. It is better to use two containers.

### Rice and cereals

Add water or liquid in the proportion indicated. E.g. "1:1.5" means adding 150 ml liquid per 100 g rice.

## Menu cooking

With your appliance you can cook a whole menu at once without the different flavours or aromas mixing with each other.

Place the food with the longest cooking time in the appliance first and add the rest at the appropriate time. This means that all the food will be ready at the same time.

The overall cooking time is extended with menu cooking, as a little steam escapes each time the appliance door is opened and has to be reheated.

Observe the information in the relevant paragraphs of this section:

- The heating-up time varies depending on the size and weight of the food
- The cooking time does not depend on the quantity
- Use cookware that is steam-resistant
- Cover soufflé with foil
- Always insert the universal pan at level 1

### Shelf positions for accessories

Always insert accessories in the following order:

- Level 3: Wire rack with steam container, size S
- Level 2: Steam container, size XL
- Level 1: Universal pan

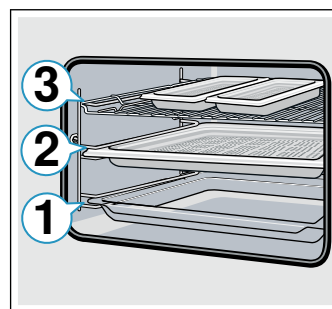

## Making rice pudding

1. Weigh the rice and add 2.5 times as much milk.
2. Fill a bowl with the rice and milk so that the mixture is max. 2.5 cm deep.  
You can also use the universal pan for large quantities.
3. Use the settings indicated in the table.
4. Stir after cooking.  
The remaining milk is quickly absorbed.

## Compote

Weigh the fruit and add approx. 1/3 as much water. Add sugar and spices to taste. Use the settings indicated in the table.

**Crème caramel and soufflé**

Place the small dishes directly into the perforated steam container (size XL). A water bath is not required. Use the settings indicated in the table.

Food which would normally be prepared in a water bath should always be covered with foil.





























**Dampfnudeln (steamed bread rolls)**

Prepare the yeast dough according to your recipe without cooking. Place the shaped balls into a greased, perforated steam container (size XL), and allow them to prove. Use the settings indicated in the table.

**Recommended setting values**

Type of heating used:

-  Steaming

| Dish                          | Accessories/cookware        | Shelf position | Type of heating   | Temperature in °C | Cooking time in mins. |
|-------------------------------|-----------------------------|----------------|---|-------------------|-----------------------|
| <b>Poultry</b>                |                             |                |   |                   |                       |
| Chicken breast, 150 g each    | steam container             | 2              |    | 100               | 15-25                 |
| <b>Pork</b>                   |                             |                |   |                   |                       |
| Pork fillet, 400 g            | steam container             | 2              |    | 100               | 18-20                 |
| <b>Fish</b>                   |                             |                |   |                   |                       |
| Fish, whole 300 g, e.g. trout | steam container, perforated | 2              |    | 80-90             | 15-25                 |
| Fish, whole 1,5 kg, e.g. cod  | steam container, perforated | 2              |    | 80-90             | 35-50                 |
| Fish fillet, 200 g            | steam container, perforated | 2              |    | 80-100            | 10-16                 |
| <b>Fish, frozen</b>           |                             |                |   |                   |                       |
| Fish, whole 300 g, e.g. trout | steam container, perforated | 2              |    | 80-100            | 20-25                 |
| <b>Fish dishes</b>            |                             |                |   |                   |                       |
| Fish terrine                  | bain marie                  | 2              |  | 70-80             | 45-80                 |
| <b>Potatoes</b>               |                             |                |   |                   |                       |
| Unpeeled boiled potatoes      | steam container, perforated | 2              |  | 100               | 35-45                 |
| Boiled potatoes, quartered    | steam container, perforated | 2              |  | 100               | 20-25                 |
| <b>Vegetables, fresh</b>      |                             |                |   |                   |                       |
| Artichokes, whole             | steam container, perforated | 2              |  | 100               | 30-35                 |
| Cauliflower, whole            | steam container, perforated | 2              |  | 100               | 25-35                 |
| Broccoli, florets             | steam container, perforated | 2              |  | 100               | 6-9                   |
| Green beans                   | steam container, perforated | 2              |  | 100               | 18-25                 |
| Carrots, slices               | steam container, perforated | 2              |  | 100               | 10-20                 |
| Cabbage turnip, slices        | steam container, perforated | 2              |  | 100               | 17-20                 |
| Leek, slices                  | steam container, perforated | 2              |  | 100               | 6-9                   |
| Sweetcorn, whole              | steam container, perforated | 2              |  | 100               | 30-40                 |
| Beetroot, whole               | steam container, perforated | 2              |  | 100               | 43-50                 |
| White asparagus, whole        | steam container, perforated | 2              |  | 100               | 7-15                  |
| Spinach                       | steam container, perforated | 2              |  | 100               | 2-3                   |
| Courgette, slices             | steam container, perforated | 2              |  | 100               | 3-4                   |
| <b>Vegetables, frozen</b>     |                             |                |   |                   |                       |
| Cauliflower                   | steam container, perforated | 2              |  | 100               | 15-25                 |
| Green beans                   | steam container, perforated | 2              |  | 100               | 5-8                   |
| Broccoli                      | steam container, perforated | 2              |  | 100               | 6-10                  |
| Peas                          | steam container, perforated | 2              |  | 100               | 6-10                  |
| Carrots                       | steam container, perforated | 2              |  | 100               | 3-10                  |
| Brussel sprouts               | steam container, perforated | 2              |  | 100               | 4-6                   |
| Mixed vegetables, 1 kg        | steam container, perforated | 2              |  | 100               | 5-10                  |

| Dish                     | Accessories/cookware                 | Shelf position | Type of heating | Temperature in °C | Cooking time in mins. |
|--------------------------|--------------------------------------|----------------|-----------------|-------------------|-----------------------|
| <b>Rice</b>              |                                      |                |                 |                   |                       |
| Basmati rice, 1:1,5      | cookware, flat                       | 1              |                 | 100               | 10-15                 |
| Long-grain rice, 1:1,5   | cookware, flat                       | 1              |                 | 100               | 20-30                 |
| Brown rice, 1:1,5        | cookware, flat                       | 1              |                 | 100               | 30-40                 |
| Parboiled rice, 1:1,5    | cookware, flat                       | 1              |                 | 100               | 15-20                 |
| Risotto, 1:2             | cookware, flat                       | 1              |                 | 100               | 25-35                 |
| <b>Cereals</b>           |                                      |                |                 |                   |                       |
| Couscous, 1:1            | cookware, flat                       | 1              |                 | 100               | 6-10                  |
| Millet, whole, 1:1,25    | cookware, flat                       | 1              |                 | 100               | 25-35                 |
| Polenta, 1:5             | cookware, flat                       | 1              |                 | 100               | 20-45                 |
| <b>Egg</b>               |                                      |                |                 |                   |                       |
| Hard-boiled eggs         | steam container, perforated          | 2              |                 | 100               | 9-11                  |
| Soft-boiled eggs         | steam container, perforated          | 2              |                 | 100               | 6-8                   |
| <b>Dessert</b>           |                                      |                |                 |                   |                       |
| Crème Brulée             | individual moulds                    | 1              |                 | 85                | 20-30                 |
| Crème caramel            | individual moulds                    | 1              |                 | 85                | 25-35                 |
| Soufflé                  | individual moulds                    | 1              |                 | 100               | 40-45                 |
| Yeast dumplings          | universal pan                        | 1              |                 | 100               | 25-30                 |
| Rice pudding, 1:2,5      | universal pan                        | 1              |                 | 100               | 25-35                 |
| Fruit compote, 1/3 water | universal pan                        | 1              |                 | 100               | 10-20                 |
| <b>Complete meal</b>     |                                      |                |                 |                   |                       |
| Frozen salmon fillet     | steam container, solid, size S       | 3              |                 | 100               | 20                    |
| Broccoli, florets        | steam container, perforated, size XL | 2              |                 | 100               | 9                     |
| Potatoes boiled          | steam container, perforated, size S  | 3              |                 | 100               | 25                    |

## Yogurt

You can make your own yogurt using your appliance.

### Making yoghurt

Remove accessories and shelf supports from the cooking compartment. The cooking compartment must be empty. Do not open the appliance door while the appliance is in operation.

1. Heat 1 litre of milk (3.5% fat) to 90 °C on the hob and then leave it to cool down to 40 °C.

It is sufficient to heat UHT milk to 40 °C.

2. Stir in 150 g (chilled) yoghurt.
3. Pour into cups or small jars and cover with cling film.
4. Place the cups or jars onto the cooking compartment floor and use the settings indicated in the table.
5. After making the yoghurt, leave it to cool in the refrigerator.

Type of heating used:

- Dough proving

| Dish    | Cookware          | Shelf position            | Type of heating | Temperature in °C | Cooking time in hours |
|---------|-------------------|---------------------------|-----------------|-------------------|-----------------------|
| Yoghurt | individual moulds | cooking compartment floor |                 | 35-40             | 5-6                   |

## Eco heating functions

Hot air eco and Top/bottom heating eco are intelligent heating functions that allow you to gently cook meat, fish and baked items. The appliance optimally controls the supply of energy to the cooking compartment. The food is cooked in phases using residual heat. This means that it remains more succulent and browns less. Depending on the method of preparation and the type

of food, it is possible to save energy. If you open the appliance door before the food has finished cooking or if you preheat the appliance, you may not be able to achieve this result.

Only use genuine accessories for your appliance. These have been tailored to the cooking compartment and the operating modes of your appliance. Remove

any accessories that are not being used from the cooking compartment.

Place the food into the empty cooking compartment before the oven is heated up. For Hot air eco, select a temperature of between 125 and 275 °C, and for Top/bottom heating eco, select a temperature of between 150 and 250 °C. Always keep the appliance door closed when cooking. Only cook on one level when using this function.

The Hot air eco heating function is used to measure both the energy consumption in air recirculation mode and the energy efficiency class. The Top/bottom heating eco heating function is used to measure the energy consumption in the conventional mode.

### Accessories

Ensure that you always use suitable accessories and that they are placed in the oven the right way around.

#### Wire rack

Insert the wire rack with the open side facing the appliance door and the curved lip pointing downwards. Always place ovenware, tins and dishes on the wire rack.

#### Universal pan or baking tray

Slide the universal pan or the baking tray in carefully as far as the limit stop with the bevelled edge facing the appliance door.

#### Baking tins and cookware

Dark- coloured metal baking tins are most suitable.

These allow you to make energy savings of up to 35 per cent.

Cookware made from stainless steel or aluminium reflects heat like a mirror. Non-reflective cookware made from enamel, heat-resistant glass or coated, die-cast aluminium is more suitable.

Tinplate baking tins, ceramic dishes or glass dishes prolong baking time, and the cake will not brown so evenly.

#### Greaseproof paper



Only use greaseproof paper that is suitable for the selected temperature. Always cut greaseproof paper to size.



















### Recommended setting values



Here, you can find specifications for various dishes. The temperature and baking time are dependent on the quantity and composition of the dough. Different settings ranges are indicated for this reason. Try using the lower values at first. A lower temperature results in more even browning. If necessary, use a higher setting the next time.

**Note:** Baking times can not be reduced by using higher temperatures. Cakes or baked items would only be cooked on the outside, but would not be cooked completely in the middle.

Types of heating used:

-  Hotair Eco
-  Top/bottom heating Eco

| Dish                                      | Accessories/cookware            | Shelf position | Type of heating   | Temperature in °C | Cooking time in mins. |
|---|---------------------------------|----------------|---|-------------------|-----------------------|
| <b>Baking</b>                             |                                 |                |   |                   |                       |
| Victoria sponge cake                      | 2x Ø20 cm tins                  | 1              |  | 170-180           | 25-35                 |
| Light fruit cake                          | high Ø20 cm tin                 | 1              |  | 150-170           | 70-90                 |
| Rich Fruit Cake                           | high Ø23 cm tin                 | 1              |  | 140-160           | 120-180               |
| Fruit crumble                             | flat glass dish                 | 1              |  | 160-180           | 40-60                 |
| Sponge cake (fatless), 3 eggs             | springform cake tin, Ø26 cm     | 1              |  | 160-170           | 25-35                 |
| Swiss Roll                                | swiss roll tin                  | 1              |  | 180-200           | 10-20                 |
| Fruit Pie                                 | plate Ø20 cm or pie tin         | 1              |  | 170-190           | 60-75                 |
| Quiche                                    | quiche tin (dark coated)        | 1              |  | 190-210           | 35-45                 |
| (White) Bread                             | loaf tin (1x 900 g or 2x 450 g) | 1              |  | 190-200           | 45-55                 |
| Scones                                    | baking tray                     | 1              |  | 190-210           | 15-20                 |
| Biscuits                                  | baking tray                     | 2              |  | 140-160           | 15-30                 |
| Jam tarts                                 | 12-cup-tin                      | 1              |  | 170-190           | 15-30                 |
| Soufflé                                   | 1,2 L-soufflé dish              | 1              |  | 160-170           | 40-50                 |
| Meat Pie                                  | rectangular pie tin             | 1              |  | 190-210           | 40-55                 |
| Jacket potatoes                           | baking tray                     | 2              |  | 150-170           | 60-90                 |
| <b>Meat</b>                               |                                 |                |   |                   |                       |
| Beef, slow roast joint                    | wire rack                       | 1              |  | 140+150           | 35+40                 |
| <b>Casserole</b>                          |                                 |                |   |                   |                       |
| Diced meat (beef, pork, lamb), 500 g meat | cookware, covered               | 1              |  | 140               | 100-120               |
| Braising steak                            | cookware, covered               | 1              |  | 140               | 65+60                 |

| Dish                                     | Accessories/cookware | Shelf position | Type of heating   | Temperature in °C | Cooking time in mins. |
|--|----------------------|----------------|---|-------------------|-----------------------|
| <b>Fish</b>                              |                      |                |   |                   |                       |
| Fish, braised, whole 300 g, e.g. trout   | cookware, covered    | 1              |  | 190-210           | 25-35                 |
| Fish, braised, whole 1,5 kg, e.g. salmon | cookware, covered    | 1              |  | 190-210           | 45-55                 |
| Fish fillet, plain, braised, 100 g       | cookware, covered    | 1              |  | 190-210           | 15-35                 |

## Acrylamide in foodstuffs

Acrylamide is mainly produced in grain and potato products prepared at high temperatures, such as potato

crisps, chips, sliced bread, bread rolls, bread or fine baked goods (biscuits, gingerbread, spiced biscuit).

### Tips for keeping acrylamide to a minimum

|            |   |
|------------|---|
| General    | <ul style="list-style-type: none"> <li>■ Keep cooking times as short as possible.</li> <li>■ Cook food until it is golden brown, but not too dark.</li> <li>■ Large, thick pieces of food contain less acrylamide.</li> </ul> |
| Baking     | With top/bottom heating at max. 200 °C.<br>With hot air at max. 180 °C.   |
| Biscuits   | With top/bottom heating at max. 190 °C.<br>With hot air at max. 170 °C.<br>Egg or egg yolk reduces the production of acrylamide.  |
| Oven chips | Spread out a single layer evenly on the baking tray. Cook at least 400 g at once on a baking tray so that the chips do not dry out.   |

## Slow cook

Slow cooking is a technique for cooking food over a long period at low temperatures. For this reason, it is also called "low-temperature cooking".

Slow cooking is ideal for all prime cuts (e.g. tender portions of beef, veal, pork, lamb or poultry) which are to be cooked "à point". The meat will remain succulent and tender.

The benefit of this cooking method is that it allows lots of scope for menu planning because slow-cooked meat is easy to keep warm. You do not have to turn the meat when cooking. Keep the appliance door closed in order to maintain an even cooking climate.

Only use fresh, clean and hygienic meat without bones. Carefully remove sinews and fat from around the edge. Fat develops a strong, distinct flavour during slow cooking. You can also use seasoned or marinated meat. Do not use defrosted meat.

Meat can be carved immediately following slow cooking. No standing time is required. Due to the special cooking method, the meat looks pink, but is not raw or undercooked.

**Note:** Delayed-start operation with an end time is not possible for the slow cooking heating type.

### Cookware

Use flat cookware, e.g. a glass/porcelain serving dish. Place the cookware into the cooking compartment to preheat it.

Always place the uncovered cookware onto the wire rack at level 1.

You can find additional information in the tips on slow cooking attached to the settings table.

Your appliance features the heating type "Slow cook". Only start operation when the cooking compartment has fully cooled down. Allow the cooking compartment to warm up for around 10 minutes with the cookware inside.

Sear the meat on the hotplate at a very high heat and for a sufficiently long time on all sides, even on the ends. Place into the preheated cookware right away. Place the cookware containing the meat into the cooking compartment once again and cook slowly.















### Recommended setting values

The slow cooking temperature and cooking time are dependent on the size, thickness and quality of the meat. Different settings ranges are indicated for this reason.



Type of heating used:

-  Slow cooking

| Dish   | Cookware            | Shelf position | Heating function  | Searing time in mins | Temperature in °C | Cooking time in mins |
|--|---------------------|----------------|---|----------------------|-------------------|----------------------|
| <b>Poultry</b>                               |                     |                |   |                      |                   |                      |
| Duck breast, medium rare, 300 g each         | Cookware, uncovered | 1              |    | 6-8                  | 95*               | 45-60                |
| Chicken breast fillet, 200 g each, well done | Cookware, uncovered | 1              |    | 4                    | 120*              | 45-60                |
| Turkey breast, boned, 1 kg, well done        | Cookware, uncovered | 1              |    | 6-8                  | 120*              | 100-130              |
| <b>Pork</b>                                  |                     |                |   |                      |                   |                      |
| Pork tenderloin steak, 5-6 cm thick, 1.5 kg  | Cookware, uncovered | 1              |    | 6-8                  | 85*               | 130-180              |
| Fillet of pork, whole                        | Cookware, uncovered | 1              |    | 4-6                  | 85*               | 45-70                |
| <b>Beef</b>                                  |                     |                |   |                      |                   |                      |
| Joint of beef (rump), 6-7 cm thick, 1.5 kg   | Cookware, uncovered | 1              |    | 6-8                  | 100*              | 150-190              |
| Fillet of beef, 1 kg                         | Cookware, uncovered | 1              |    | 4-6                  | 85*               | 90-120               |
| Sirloin, 5-6 cm thick                        | Cookware, uncovered | 1              |    | 6-8                  | 85*               | 120-180              |
| Beef medallions/rump steak, 4 cm thick       | Cookware, uncovered | 1              |    | 4                    | 85*               | 40-60                |
| <b>Veal</b>                                  |                     |                |   |                      |                   |                      |
| Joint of veal, 4-5 cm thick, 1.5 kg          | Cookware, uncovered | 1              |  | 6-8                  | 85*               | 100-130              |
| Joint of veal, 7-10 cm thick, 1.5 kg         | Cookware, uncovered | 1              |  | 6-8                  | 85*               | 150-210              |
| Fillet of veal, whole, 800 g                 | Cookware, uncovered | 1              |  | 4-6                  | 85*               | 70-120               |
| Veal medallions, 4 cm thick                  | Cookware, uncovered | 1              |  | 4                    | 80*               | 40-60                |
| <b>Lamb</b>                                  |                     |                |   |                      |                   |                      |
| Saddle of lamb, boneless, 200 g each         | Cookware, uncovered | 1              |  | 4                    | 85*               | 30-45                |
| Leg of lamb, boned, medium, 1 kg, tied       | Cookware, uncovered | 1              |  | 6-8                  | 95*               | 120-180              |

\* Preheat

### Tips for slow cooking

|  |   |
|--|---|
| Slow-cooking duck breast.  | Place the cold duck breast into a pan and fry the skin side first. After slow cooking, grill for 3 to 5 minutes until crispy. |
| The slow-cooked meat is not as hot as conventionally roasted meat. | So that the roasted meat does not cool so quickly, warm the plates and serve the sauces very hot.                             |

### Drying

With 4D hot air, you can dry foods with outstanding results. With this type of preserving, flavourings are concentrated by the dehydration.

Only use unblemished fruit, vegetables and herbs and wash them thoroughly. Line the wire rack with greaseproof paper or parchment paper. Drain the excess water from the fruit and dry it.

If necessary, cut it into equal chunks or thin slices. Place unpeeled fruit onto the dish with the sliced surfaces facing upwards. Ensure that neither fruit nor mushrooms overlap on the wire rack.

Grate vegetables and then blanch them. Allow the blanched vegetables to drain off and distribute them evenly on the wire rack.

Dry herbs on the stem. Position the herbs evenly and slightly heaped on the wire rack.

Use the following shelf positions when drying:

- 1 wire rack: Level 2
- 2 wire racks: Level 3+1

Turn very juicy fruit and vegetables several times. After drying, remove the dried products from the paper immediately.

### Recommended setting values





In the table, you can find settings for drying various foodstuffs. The temperature and cooking time are dependent on the type, moisture, ripeness and thickness of the food to be dried. The longer you leave the food to be dried, the better it will be preserved. The thinner the slices are, the quicker the drying process

will be and the more aromatic the dried food will remain. Setting ranges are indicated for this reason.

If you wish to dry additional foodstuffs, you should use similar foodstuffs in the table as a reference.

Type of heating used:

-  4D hot air

| Dish   | Accessories    | Shelf position | Type of heating   | Temperature in °C | Cooking time in hours |
|--|----------------|----------------|---|-------------------|-----------------------|
| Pomes (apple rings, 3 mm thick, 200 g per wire rack) | Wire rack      | 2              |  | 80                | 4-7                   |
| Stone fruit (plums)                                  | Wire rack      | 2              |  | 80                | 8-10                  |
| Root vegetables (carrots), grated, blanched          | Wire rack      | 2              |  | 80                | 4-7                   |
| Sliced mushrooms                                     | Wire rack      | 2              |  | 60                | 6-8                   |
| Herbs, washed  | 1-2 wire racks | -              |  | 60                | 2-6                   |

### Preserving and juicing

Your appliance is also suitable for preserving and juicing.

#### Preserving

You can preserve fruit and vegetables using your appliance.

#### Warning – Risk of injury!

If the food is preserved incorrectly, the preserving jars may burst. Follow the instructions for preserving.

#### Jars

Use only clean and undamaged preserving jars. Only use heat-resistant, clean and undamaged rubber rings. Check clips and clamps in advance.

**Tip:** You can use the disinfecting function to clean the jars.

For each preserving process, only use preserving jars that are the same size and contain the same food. In the cooking compartment, you can preserve the contents of a maximum of six ½, 1 or 1½-litre preserving jars at the same time. Do not use jars that are larger or taller than this. The lids could rupture.

Preserving jars must not touch one another in the cooking compartment during the preserving process.

#### Preparing fruit and vegetables

Only use fruit and vegetables that are in good condition. Wash them thoroughly.

Peel, core and chop fruit and vegetables appropriate to their type and fill the preserving jars with them up to approx. 2 cm below the rim.

**Fruit:** Fill the preserving jars with the fruit along with a hot, skimmed sugar solution (approx. 400 ml for a 1-litre jar). For one litre of water:

- Approx. 250 g sugar for sweet fruit
- Approx. 500 g sugar for sour fruit

**Vegetables:** Fill the jars with the vegetables along with hot, boiled water.

Wipe the rims of the jars, as they must be clean. Place a damp rubber ring and a lid on each jar. Seal the jars with clamps. Place the jars into the perforated steam container (size XL) so that they do not touch each other. Use the settings indicated in the table.

#### Ending the preserving process

After the specified cooking time, open the appliance door. Do not remove the preserving jars from the cooking compartment until they have completely cooled down.

Wipe the cooking compartment clean afterwards.

#### Juicing

Before juicing, place the berries in a bowl and sprinkle with sugar. Leave to stand for at least one hour to draw out the juice.

Then fill the perforated steam container (size XL) with the berries and insert into the oven at level 2. Slide the universal pan in underneath to collect any juice. Use the settings indicated in the table.

After cooking, wrap the berries in a cloth and squeeze out the remaining juice.





Wipe the cooking compartment clean afterwards.

#### Recommended setting values

The times indicated in the settings table are guideline values for preserving fruit and vegetables and for juicing fruit. They may be influenced by room temperature, number of jars, quantity, heat and the quality of the jar contents. The specifications are based on 1-litre round jars.

Type of heating used:

-  Steaming

| Dish                                | Accessories/cookware                         | Shelf position | Type of heating   | Temperature in °C | Cooking time in mins. |
|-------------------------------------|--|----------------|---|-------------------|-----------------------|
| <b>Preserving</b>                   |  |                |   |                   |                       |
| Vegetables, e.g. carrots            | 1-litre preserving jars + XL steam container | 1              |  | 100               | 30-120                |
| Stone fruit, e.g. cherries, damsons | 1-litre preserving jars + XL steam container | 1              |  | 100               | 25-30                 |
| Pomes, e.g. apples, strawberries    | 1-litre preserving jars + XL steam container | 1              |  | 100               | 25-30                 |
| <b>Juicing</b>                      |  |                |   |                   |                       |
| Raspberries                         | Steam container                              | 2              |  | 100               | 30-45                 |
| Redcurrants                         | Steam container                              | 2              |  | 100               | 40-50                 |

## Sterilising bottles and hygiene

Using your appliance, you can very easily sterilise cookware and baby feeding bottles. The process corresponds to normal sterilisation by boiling.

### Sterilising bottles

Always clean the bottles with a bottle brush immediately after use. Then clean them in the dishwasher.

Place the bottles into the steam container, size XL, so that they do not touch each other. Start the programme "Sterilising". After sterilising, wipe the appliance down inside. Dry the bottles with a clean cloth after sterilising.

### Hygiene

Your appliance is also suitable for preparing jam jars or preserving jars and their corresponding lids.

Post-treatment of jam is also possible. This improves the storage life of the jam.



### Recommended setting values

Only use clean, intact jars and lids. They should ideally be cleaned in the dishwasher in advance. Cookware must be heat- and steam-resistant.

The recommended times are dependent on the jars used.

Type of heating used:

-  Steaming

| Dish   | Accessory          | Shelf position | Type of heating   | Temperature in °C | Cooking time in mins. |
|--|--------------------|----------------|---|-------------------|-----------------------|
| <b>Hygiene</b>   |                    |                |   |                   |                       |
| Preparing jam jars or preserving jars                          | XL steam container | 1              |  | 100               | 10-15                 |
| Post-treating jam jars   | XL steam container | 1              |  | 100               | 15-20                 |
| Sterilising clean cookware*                                    | XL steam container | 1              |  | 100               | 15-20                 |
| * This process corresponds to normal sterilisation by boiling. |                    |                |   |                   |                       |

## Allowing the dough to prove at dough proving setting

Yeast dough will prove considerably more quickly using the "Dough proving" heating type than at room temperature and does not dry out. Only start operation when the cooking compartment has fully cooled down.

Always allow yeast dough to prove twice. Observe the specifications in the settings tables for the 1st and 2nd proving processes (dough fermentation and final fermentation).

### Dough fermentation

Position the dough bowl on the wire rack for the dough fermentation. Use the settings indicated in the table.

Do not open the appliance door during the proving process, as moisture will escape. Do not cover the dough.

### Final fermentation

Place your baked item into the oven at the shelf position indicated in the table.











Wipe moisture from the cooking compartment before baking.

### Recommended setting values

The temperature and proving time are dependent on the type and quantity of the ingredients. The values in the table are therefore only meant to be average values.

Type of heating used:

-  Dough proving

| Dish                        | Accessories/cookware | Shelf position | Type of heating  | Step               | Temperature in °C | Cooking time in mins. |
|-----------------------------|----------------------|----------------|--|--------------------|-------------------|-----------------------|
| <b>Yeast dough, sweet</b>   |                      |                |  |                    |                   |                       |
| E.g. small baked items      | Bowl                 | 1              |    | Dough fermentation | 35-40             | 30-45                 |
|                             | Universal pan        | 1              |    | Final fermentation | 35-40             | 10-20                 |
| Rich dough, e.g. panettone  | Bowl                 | 1              |    | Dough fermentation | 35-40             | 20-40                 |
|                             | Tin on wire rack     | 1              |    | Final fermentation | 35-40             | 10-20                 |
| <b>Yeast dough, savoury</b> |                      |                |  |                    |                   |                       |
| E.g. pizza                  | Bowl                 | 1              |    | Dough fermentation | 40-45             | 40-90                 |
|                             | Universal pan        | 1              |    | Final fermentation | 40-45             | 30-60                 |
| <b>Bread dough</b>          |                      |                |  |                    |                   |                       |
| White bread                 | Bowl                 | 1              |    | Dough fermentation | 35-40             | 30-40                 |
|                             | Universal pan        | 1              |    | Final fermentation | 35-40             | 15-25                 |
| Multigrain bread            | Bowl                 | 1              |  | Dough fermentation | 35-40             | 25-40                 |
|                             | Universal pan        | 1              |  | Final fermentation | 35-40             | 10-20                 |
| Bread rolls                 | Bowl                 | 1              |  | Dough fermentation | 35-40             | 30-40                 |
|                             | Universal pan        | 1              |  | Final fermentation | 35-40             | 15-25                 |

## Defrosting

The steam function "Defrost" is suitable for defrosting frozen fruit and vegetables. Use heating type 4D hot air to defrost baked items. Poultry, meat and fish should ideally be defrosted in the refrigerator.

Remove frozen food from any packaging when defrosting it.

Place frozen fruit and vegetables into the perforated steam container (size XL) and slide the universal pan in underneath. This means that the food does not remain in the meltwater and that any dripping liquid will be caught. Use the universal pan or cookware on the wire rack for frozen food where liquid should remain in the dish, e.g. frozen creamed spinach.

Place the baked item onto the wire rack.

### Recommended setting values





The times in the table are average values. They are dependent on the quality, freezing temperature (-18 °C) and composition of the food. Time ranges are indicated. Set the shortest time first and then increase the time if necessary.

**Tip:** Items which were frozen flat or portioned defrost faster than those frozen in a block.

Types of heating used:

-  4D hot air
-  Defrosting

| Dish                      | Accessories | Shelf position | Type of heating   | Temperature in °C | Cooking time in mins. |
|---------------------------|-------------|----------------|---|-------------------|-----------------------|
| <b>Bread, bread rolls</b> |             |                |   |                   |                       |
| General                   | Baking tray | 1              |  | 50                | 40-70                 |

| Dish                     | Accessories     | Shelf position | Type of heating   | Temperature in °C | Cooking time in mins. |
|--------------------------|-----------------|----------------|---|-------------------|-----------------------|
| <b>Cake</b>              |                 |                |   |                   |                       |
| Cake, moist              | Baking tray     | 1              |  | 50                | 70-90                 |
| Cake, dry                | Baking tray     | 1              |  | 60                | 60-75                 |
| <b>Fruit, vegetables</b> |                 |                |   |                   |                       |
| Berries                  | Steam container | 2              |  | 30-40             | 10-15                 |
| Vegetables               | Steam container | 2              |  | 40-50             | 15-50                 |

## Reheating

Using heating type "Reheating", food is reheated gently using steam. It tastes and looks as though it has been freshly prepared. Even baked items from the day before can be re-crisped.

Use containers which are as flat, wide and heat-resistant as possible. Cold containers prolong the reheating process.

Where possible, only reheat dishes of the same size and type at the same time. If this is not possible, the time required for the component with the longest reheating time should be used as a basis.

Do not cover food while it is being reheated.

Place the food in the cookware onto the wire rack or place it directly onto the wire rack at level 1.

Do not open the appliance door during operation, as a lot of steam will escape.

## Recommended setting values











In the table, you can find the ideal settings for various dishes. The times specified are only average values. They are dependent on the cookware used, the quality, temperature and consistency of the food. Time ranges are indicated. Set the shortest time first and then extend the time if necessary.

The values in the table apply to dishes placed into a cold cooking compartment. Preheating is necessary for selected dishes, and this is indicated in the table.

Remove unused accessories from the cooking compartment. This will allow you to achieve ideal cooking results and save energy.

Type of heating used:

-  Reheating

| Dish   | Accessories/cookware | Shelf position | Type of heating   | Temperature in °C | Cooking time in mins. |
|--|----------------------|----------------|---|-------------------|-----------------------|
| <b>Vegetables, chilled</b>                         |                      |                |   |                   |                       |
| 1 kg   | Cookware, uncovered  | 1              |  | 120-130           | 15-25                 |
| 250 g  | Cookware, uncovered  | 1              |  | 120-130           | 5-15                  |
| <b>Dishes, chilled</b>                             |                      |                |   |                   |                       |
| Plated meal, 1 portion                             | Cookware, uncovered  | 1              |  | 120-130           | 15-25                 |
| Soup, stew, 400 ml                                 | Cookware, uncovered  | 1              |  | 120-130           | 10-25                 |
| Side dishes, e.g. pasta, dumplings, potatoes, rice | Cookware, uncovered  | 1              |  | 120-130           | 8-25                  |
| Bakes, e.g. lasagne, potato gratin                 | Cookware, uncovered  | 1              |  | 120-140           | 10-25                 |
| Pizza, cooked                                      | Wire rack            | 1              |  | 170-180*          | 5-15                  |
| <b>Baked goods</b>                                 |                      |                |   |                   |                       |
| Bread rolls, baguette, baked                       | Wire rack            | 1              |  | 150-160*          | 10-20                 |
| Pastries (vol-au-vents)                            | Wire rack            | 1              |  | 180*              | 4-10                  |
| <b>Baked goods, frozen</b>                         |                      |                |   |                   |                       |
| Pizza, cooked                                      | Wire rack            | 1              |  | 170-180*          | 5-15                  |
| Bread rolls, baguette, baked                       | Wire rack            | 1              |  | 160-170*          | 10-20                 |

\* Preheat



## Keeping warm

You can keep cooked dishes warm using the "Keeping warm" heating type. You can use the various moisture levels to prevent the cooked dishes from drying out.

Do not cover the food.

Do not keep cooked dishes warm for longer than two hours. Be aware that some dishes may continue cooking whilst being kept warm. Do not cover the food.

The various steam levels are suitable for keeping the following foods warm:

- Level 1: Roasted joints and pan-fried foods
- Level 2: Bakes and side dishes
- Level 3: Stews and soups

## Test dishes

These tables have been produced for test institutes to facilitate appliance testing.

As per EN 60350-1.

## Baking

Baked items that are placed into the oven on trays or in baking tins/dishes at the same time will not necessarily be ready at the same time.

Shelf positions for baking on two levels:

- Universal pan: Level 3

Baking tray: Level 1

### Apple pie



Apple pie on one level: place dark-coloured springform cake tins diagonally next to each other.

Cakes in tins: place in springform cake tins: bake on one level with top/bottom heating. Place the springform cake tin onto the universal pan instead of onto the wire rack.

### Notes











- The setting values apply to dishes placed into a cold cooking compartment.
- Please note the information in the tables about preheating. The setting values are valid without rapid heating-up.
- For baking, use the lower of the indicated temperatures first.

Types of heating used:

-  4D hot air
-  Top/bottom heating
-  Pizza setting

The levels of steam intensity are indicated as numbers in the table:

- 1 = Low
- 2 = Medium
- 3 = High

| Dish                  | Accessories/cookware                 | Shelf position | Type of heating   | Temperature in °C | Steam intensity | Cooking time in mins. |
|-----------------------|--------------------------------------|----------------|---|-------------------|-----------------|-----------------------|
| <b>Baking</b>         |                                      |                |   |                   |                 |                       |
| Shortbread            | Baking tray                          | 1              |  | 150-160*          | -               | 25-40                 |
| Shortbread            | Baking tray                          | 1              |  | 140-150*          | -               | 25-35                 |
| Shortbread, 2 levels  | Universal pan + baking tray          | 3+1            |  | 140-150*          | -               | 30-40                 |
| Small cakes           | Baking tray                          | 1              |  | 160*              | -               | 25-35                 |
| Small cakes           | Baking tray                          | 1              |  | 150*              | -               | 25-35                 |
| Small cakes, 2 levels | Universal pan + baking tray          | 3+1            |  | 150*              | -               | 25-35                 |
| Fatless sponge cake   | Springform cake tin, diameter 26 cm  | 1              |  | 160-170**         | -               | 25-35                 |
| Fatless sponge cake   | Springform cake tin, diameter 26 cm  | 1              |  | 160-170**         | -               | 25-35                 |
| Fatless sponge cake   | Springform cake tin, diameter 26 cm  | 1              |  | 150-160           | 1               | 10                    |
|                       |                                      |                |   |                   | -               | 20-30                 |
| Apple pie             | 2 x black plate tins, diameter 20 cm | 1              |  | 180-200           | -               | 60-70                 |
| Apple pie             | 2 x black plate tins, diameter 20 cm | 1              |  | 170-180           | -               | 60-80                 |

\* Preheat for 5 mins, do not use quick heat function

\*\* Preheat, do not use quick heat function

### Steam

Slide the universal pan in under the perforated steam container (size XL) if indicated in the table. Any dripping liquid is caught.

Shelf positions for steaming on one level (use a maximum of 2.5 kg):



- Perforated steam container (size XL): Level 2

Shelf positions for steaming on two levels (use a maximum of 1.8 kg per level):

- Perforated steam container (size XL): Level 3
- Perforated steam container (size XL): Level 2

Type of heating used:

-  Steaming

| Dish                                      | Accessories                            | Shelf position | Type of heating   | Temperature in °C | Cooking time in mins. |
|---|--|----------------|---|-------------------|-----------------------|
| <b>Steam</b>                              |  |                |   |                   |                       |
| Peas, frozen, two containers, 1.8 kg each | XL steam container x 2 + universal pan | 3+2+1          |  | 100               | **                    |
| Broccoli, fresh, 300 g                    | XL steam container                     | 2              |  | 100*              | 6-7***                |
| Broccoli, fresh, one container            | XL steam container                     | 2              |  | 100*              | 6-7***                |

\* Preheat

\*\* Test is over when 85°C is reached at the coldest spot (see IEC 60350-1)



\*\*\* A comparable degree of cooking between reference sample and main sample is achieved if the reference sample is cooked for 5 minutes (produced as described in IEC 60350-1).

### Grilling

Also slide in the universal pan. The liquid will be caught and the cooking compartment stays cleaner.

Type of heating used:

-  Grill, large area

| Dish               | Accessories | Shelf position | Type of heating   | Grill setting | Cooking time in mins. |
|--------------------|-------------|----------------|---|---------------|-----------------------|
| <b>Grilling</b>    |             |                |   |               |                       |
| Browning toast     | Wire rack   | 3              |  | 3             | 2-6                   |
| Beefburgers, x 12* | Wire rack   | 2              |  | 3             | 20-30                 |

\* Turn after 2/3 of the total time



## Thank you for buying a Bosch Home Appliance!

Register your new device on MyBosch now and profit directly from:

- **Expert tips & tricks for your appliance**
- **Warranty extension options**
- **Discounts for accessories & spare-parts**
- **Digital manual and all appliance data at hand**
- **Easy access to Bosch Home Appliances Service**

Free and easy registration – also on mobile phones:

**[www.bosch-home.com/welcome](http://www.bosch-home.com/welcome)**



## Looking for help? You 'll find it here.

Expert advice for your Bosch home appliances, need help with problems or a repair from Bosch experts.

Find out everything about the many ways Bosch can support you:

**[www.bosch-home.com/service](http://www.bosch-home.com/service)**

**Contact data of all countries are listed in the attached service directory.**

Valid within Great Britain:

Imported to Great Britain by

BSH Home Appliances Ltd.  
Grand Union House  
Old Wolverton Road  
Wolverton, Milton Keynes  
MK12 5PT  
United Kingdom

**Robert Bosch Hausgeräte GmbH**

Carl-Wery-Straße 34

81739 München

Germany

**[www.bosch-home.com](http://www.bosch-home.com)**



9001431857

000325