



BOSCH



Register your
new device on
MyBosch now and
get free benefits:
**[bosch-home.com/
welcome](https://bosch-home.com/welcome)**













Built-in oven



HBF011BR0Z

[en] Instruction manual

Built-in oven

Table of contents

	Intended use	4
	Important safety information	4
	General information	4
	Halogen lamp	5
	Causes of damage	6
	General information	6
	Installation and connection	6
	Electrical connection	6
	Measures to be noted during transport	7
	Environmental protection	7
	Saving energy	7
	Environmentally-friendly disposal	8
	Getting to know your appliance	8
	Control panel	8
	Timer	9
	Types of heating and functions	9
	Temperature	10
	Cooking compartment	10
	Accessories	11
	Accessories included	11
	Inserting accessories	11
	Optional accessories	11
	Before using for the first time	12
	Cleaning the cooking compartment and accessories	12
	Operating the appliance	13
	Switching the appliance on and off	13
	Setting the type of heating and temperature	13
	Rapid heating	13
	Cleaning	14
	Suitable cleaning agents	14
	Keeping the appliance clean	15
	Rails	15
	Detaching and refitting the rails	15
	Appliance door	16
	Detaching and attaching the oven door	16
	Removing and installing the door panels	17
	Trouble shooting	18
	Rectifying faults yourself	18
	Replacing the bulb in the top of the cooking compartment	18

	Customer service	19
	E number and FD number	19
	Tested for you in our cooking studio	19
	General information	19
	Cakes and pastries	20
	Bakes and gratins	24
	Poultry, meat and fish	24
	Vegetables and side dishes	27
	Yoghurt	27
	Acrylamide in foodstuffs	27
	Drying	28
	Prove dough	28
	Defrosting	29
	Test dishes	29

Additional information on products, accessories, replacement parts and services can be found at **www.bosch-home.com** and in the online shop **www.bosch-eshop.com**

Intended use

Read these instructions carefully. Only then will you be able to operate your appliance safely and correctly. Retain the instruction manual and installation instructions for future use or for subsequent owners.

The images shown in these instructions are for guidance only.

This appliance is only intended to be fully fitted in a kitchen. Observe the special installation instructions.

Check the appliance for damage after unpacking it. Do not connect the appliance if it has been damaged in transport.

Only a licensed professional may connect appliances without plugs. Damage caused by incorrect connection is not covered under warranty.

This appliance is intended for domestic use only. The appliance must only be used for the preparation of food and drink. The appliance must be supervised during operation. Only use this appliance indoors.

This appliance is intended for use up to a maximum height of 4000 metres above sea level.

This appliance may be used by children over the age of 8 years old and by persons with reduced physical, sensory or mental capabilities or by persons with a lack of experience or knowledge if they are supervised or are instructed by a person responsible for their safety how to use the appliance safely and have understood the associated hazards.

Children must not play with, on, or around the appliance. Children must not clean the appliance or carry out general maintenance unless they are at least 15 years old and are being supervised.

Keep children below the age of 8 years old at a safe distance from the appliance and power cable.

Always slide accessories into the cooking compartment the right way round.

→ "Accessories" on page 11

Important safety information

General information

Warning – Risk of fire!

- Combustible items stored in the cooking compartment may catch fire. Never store combustible items in the cooking compartment. Never open the appliance door if there is smoke inside. Switch off the appliance and unplug it from the mains or switch off the circuit breaker in the fuse box.
- Loose food remnants, fat and meat juices may catch fire. Before using the appliance, remove the worst of the food remnants from the cooking compartment, heating elements and accessories.
- A draught is created when the appliance door is opened. Greaseproof paper may come into contact with the heating element and catch fire. Do not place greaseproof paper loosely over accessories during preheating. Always weight down the greaseproof paper with a dish or a baking tin. Only cover the surface required with greaseproof paper. Greaseproof paper must not protrude over the accessories.

Warning – Risk of burns!

- The appliance becomes very hot. Never touch the interior surfaces of the cooking compartment or the heating elements. Always allow the appliance to cool down. Keep children at a safe distance.
- Accessories and ovenware become very hot. Always use oven gloves to remove accessories or ovenware from the cooking compartment.
- Alcoholic vapours may catch fire in the hot cooking compartment. Never prepare food containing large quantities of drinks with a high alcohol content. Only use small quantities of drinks with a high alcohol content. Open the appliance door with care.

⚠ Warning – Risk of scalding!

- The accessible parts become hot during operation. Never touch the hot parts. Keep children at a safe distance.
- When you open the appliance door, hot steam can escape. Steam may not be visible, depending on its temperature. When opening, do not stand too close to the appliance. Open the appliance door carefully. Keep children away.
- Water in a hot cooking compartment may create hot steam. Never pour water into the cooking compartment when the cooking compartment is hot.

⚠ Warning – Risk of injury!

- Scratched glass in the appliance door may develop into a crack. Do not use a glass scraper, sharp or abrasive cleaning aids or detergents.
- The hinges on the appliance door move when opening and closing the door, and you may be trapped. Keep your hands away from the hinges.
- If you leave the appliance door open, people may bump into it, resulting in injury. The appliance door must be kept closed both while the appliance is in operation and when it has finished.

⚠ Warning – Risk of electric shock!

- Incorrect repairs are dangerous. Repairs may only be carried out and damaged power cables replaced by one of our trained after-sales technicians. If the appliance is defective, unplug the appliance from the mains or switch off the circuit breaker in the fuse box. Contact the after-sales service.
- The cable insulation on electrical appliances may melt when touching hot parts of the appliance. Never bring electrical appliance cables into contact with hot parts of the appliance.
- Do not use any high-pressure cleaners or steam cleaners, which can result in an electric shock.
- A defective appliance may cause electric shock. Never switch on a defective appliance. Unplug the appliance from the mains or switch off the circuit breaker in the fuse box. Contact the after-sales service.

Halogen lamp**⚠ Warning – Risk of burns!**

The bulbs in the cooking compartment become very hot. There is still a risk of burning your skin for some time after they have been switched off. Do not touch the glass cover. Avoid contact with your skin when cleaning.

⚠ Warning – Risk of electric shock!

When replacing the cooking compartment bulb, the bulb socket contacts are live. Before replacing the bulb, unplug the appliance from the mains or switch off the circuit breaker in the fuse box.

Causes of damage

General information

Caution!

- Accessories, foil, greaseproof paper or ovenware on the cooking compartment floor: do not place accessories on the cooking compartment floor. Do not cover the cooking compartment floor with any sort of foil or greaseproof paper. Do not place ovenware on the cooking compartment floor if a temperature of over 50 °C has been set. This will cause heat to accumulate. The baking and roasting times will no longer be correct and the enamel will be damaged.
- Aluminium foil: Aluminium foil in the cooking compartment must not come into contact with the door glass. This could cause permanent discolouration of the door glass.
- Water in a hot cooking compartment: do not pour water into the cooking compartment when it is hot. This will cause steam. The temperature change can cause damage to the enamel.
- Moisture in the cooking compartment: Over an extended period of time, moisture in the cooking compartment may lead to corrosion. Allow the cooking compartment to dry after use. Do not keep moist food in the closed cooking compartment for extended periods of time. Do not store food in the cooking compartment.
- Cooling with the appliance door open: Following operation at high temperatures, only allow the cooking compartment to cool down with the door closed. Do not trap anything in the appliance door. Even if the door is only left open a crack, the front of nearby furniture may become damaged over time. Only leave the cooking compartment to dry with the door open if a lot of moisture was produced whilst the oven was operating.
- Fruit juice: when baking particularly juicy fruit pies, do not pack the baking tray too generously. Fruit juice dripping from the baking tray leaves stains that cannot be removed. If possible, use the deeper universal pan.
- Extremely dirty seal: If the seal is very dirty, the appliance door will no longer close properly during operation. The fronts of adjacent units could be damaged. Always keep the seal clean. Never operate the appliance if the seal is damaged or missing. → "Cleaning" on page 14
- Appliance door as a seat, shelf or worktop: Do not sit on the appliance door, or place or hang anything on it. Do not place any cookware or accessories on the appliance door.
- Inserting accessories: depending on the appliance model, accessories can scratch the door panel when closing the appliance door. Always insert the accessories into the cooking compartment as far as they will go.
- Carrying the appliance: do not carry or hold the appliance by the door handle. The door handle cannot support the weight of the appliance and could break.

Installation and connection

This appliance is only intended to be fully fitted in a kitchen. Observe the special installation instructions.

Do not install the appliance behind a decorative door or the door of a kitchen unit, as this may cause the appliance to overheat.

Electrical connection

Only licensed specialists may connect the appliance. It is important that you comply with the requirements of your electricity supplier.

Any damage arising from the appliance being connected incorrectly will invalidate the warranty.

Caution!

If the supply cord is damaged, it must be replaced by the manufacturer, its service agent or similarly qualified persons in order to avoid a hazard.

- The appliance must be disconnected from the power supply whenever installation work is being carried out.
- The appliance fulfils the requirements of protection class I and may only be connected to an earthed socket.
- The mains power cable must be at least type H05 V V-F 3G, 1.5 mm².

Warning – Danger of death!

There is a risk of electric shock if you touch live components.

- Always make sure your hands are dry when you touch or hold the mains plug.
- Only pull out the mains cable by taking hold of the plug and removing the plug; never pull it out by the mains cable itself, as this could damage it.
- Never unplug the mains plug when the appliance is in operation.

Please note the following information and ensure that:

Notes

- The mains plug fits the socket.
- The cable cross section is adequate.
- The earthing system is properly installed.
- The mains cable is only replaced by a qualified electrician (if this is necessary). Spare mains cables can be ordered from our after-sales service.
- No power strips/multi-way connectors or extension cables are used.
- If using a residual current device, only use one that bears the mark . The presence of this mark is the only way to be sure that it fulfils all the applicable regulations.
- The mains plug can be accessed at all times.
- The mains cable is not kinked, crushed, modified or severed.
- The mains cable does not come into contact with heat sources.

Measures to be noted during transport

Secure all mobile parts in and on the appliance using an adhesive tape that can be removed without leaving any traces. Push all accessories (e.g. baking tray) into the corresponding slots with cardboard at the edges, in order to avoid damaging the appliance. Place cardboard or similar between the front and rear side to prevent knocks against the inside of the glass door. Secure the door and, if available, the top cover to the appliance sides using adhesive tape.

Keep the original appliance packaging. Only transport the appliance in the original packaging. Observe the transport arrows on the packaging.

If the original packaging is no longer available

pack the appliance in protective packaging to guarantee sufficient protection against any transport damage.

Transport the appliance in an upright position. Do not hold the appliance by the door handle or the connections on the rear, as these could be damaged. Do not place any heavy objects on the appliance.

Environmental protection

Your new appliance is particularly energy-efficient. Here you can find tips on how to save even more energy when using the appliance, and how to dispose of your appliance properly.

Saving energy

- Only preheat the appliance if this is specified in the recipe or in the tables in the operating instructions.
- Leave frozen food to defrost before placing it in the cooking compartment.

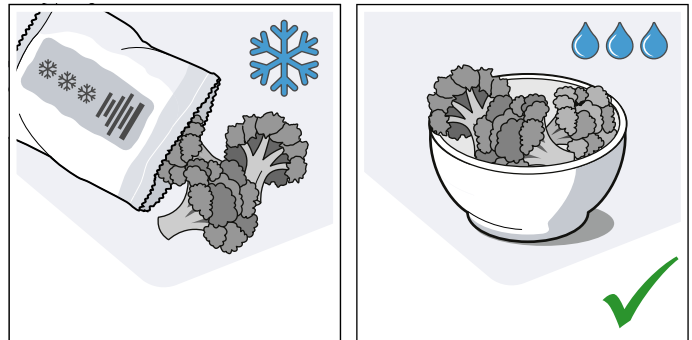

- Use baking tins that are dark-coloured, painted black or have an enamel coating. These absorb the heat particularly well.

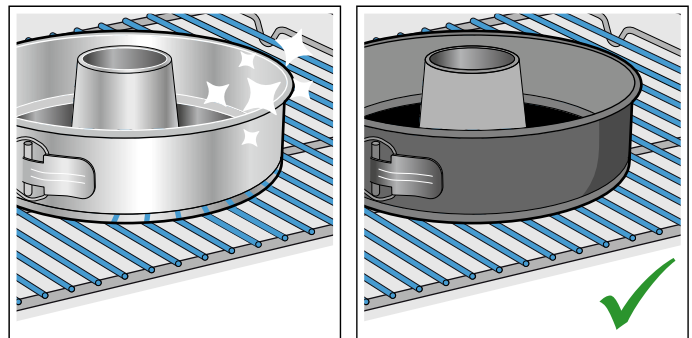

- Remove any unnecessary accessories from the cooking compartment.

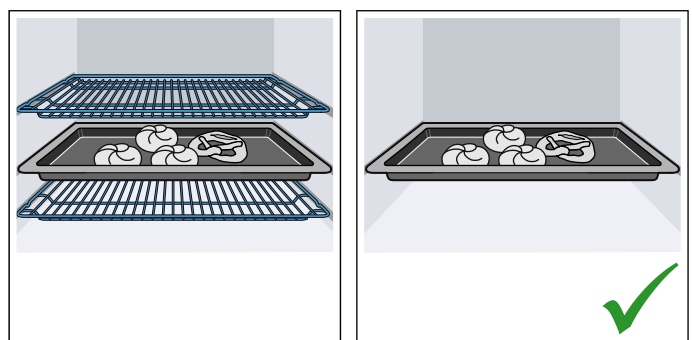

Getting to know your appliance

- Open the appliance door as infrequently as possible when the appliance is in use.

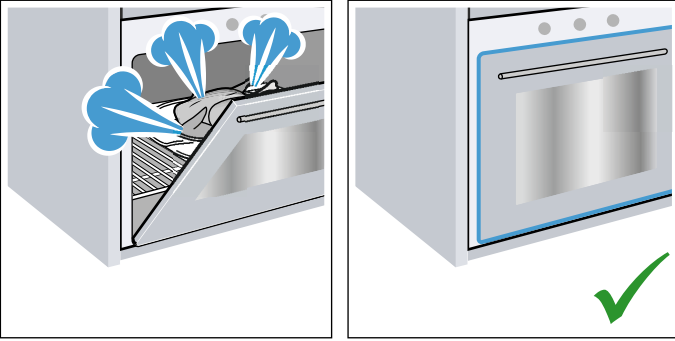

- It is best to bake several cakes one after the other. The cooking compartment stays warm. This reduces the baking time for the second cake. You can place two cake tins next to each other in the cooking compartment.

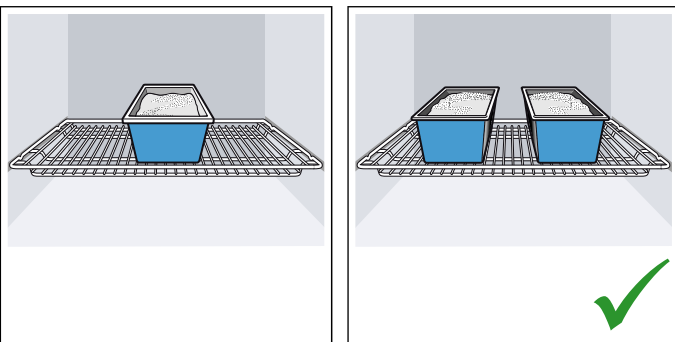

- For longer cooking times, you can switch the appliance off 10 minutes before the end of the cooking time and use the residual heat to finish cooking.

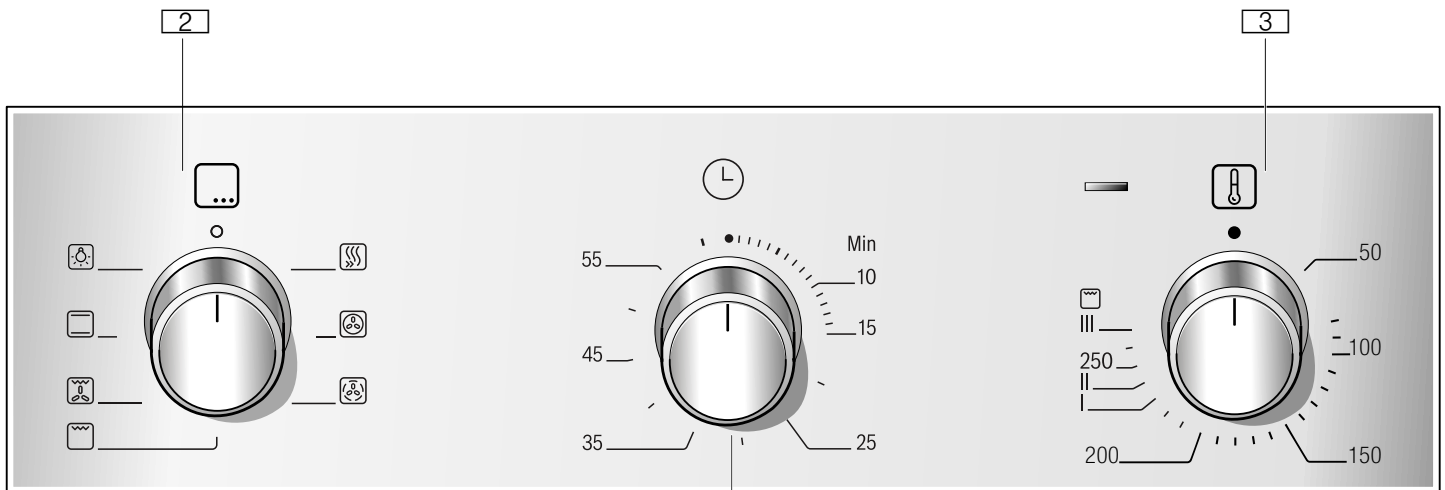

- 1 Timer**
You can set a time of up to 60 minutes on the oven timer.
The timer has no effect on how the oven works. Its only function is that of a kitchen timer.

- 2 Function selector**
Use the function selector to set the heating function or other functions.
You can turn the function selector clockwise or anti-clockwise from the "Off" position.

Environmentally-friendly disposal

Dispose of packaging in an environmentally-friendly manner.



This appliance is labelled in accordance with European Directive 2012/19/EU concerning used electrical and electronic appliances (waste electrical and electronic equipment - WEEE). The guideline determines the framework for the return and recycling of used appliances as applicable throughout the EU.

Getting to know your appliance

In this section, we will explain the indicators and controls. You will also find out about the various functions of your appliance.

Note: Depending on the appliance model, individual details and colours may differ.

Control panel

You can set your appliance's various functions on the control panel. Below, you will see an overview of the control panel and the layout of the controls.

3 Temperature selector

Use the temperature selector to set the temperature for the heating function or select the setting for other functions.

You can only turn the temperature selector clockwise from the "Off" position, until it offers resistance. Do not turn the selector beyond this point.



Note: On some appliances, the control knobs can be pushed in. To push the control knob in and engage it or to release it again, turn it to the "Off" position.

Timer

Using the timer, you can set a time of up to 60 minutes. The timer runs independently of the oven. It can be used like a kitchen timer.

Types of heating and functions

Use the function selector to set the types of heating and other functions.

Setting	Function
•	Zero position Setting off
	End of the set cooking time Signal when the set time has elapsed
 - 60	Minute display Time display, in minutes.





Setting procedure

Set the timer for the desired cooking time.

The time has elapsed



When the time has elapsed, a signal sounds. The switch turns to the OFF position • automatically.

To make sure you always use the right type of heating to cook your food, we have explained the differences and applications below.

Type of heating	Use
 3D hot air	For baking and roasting on one or more levels. The fan distributes the heat from the ring heating element in the back panel evenly around the cooking compartment.
 Gentle hot air	For gently cooking selected types of food on one level without preheating. The fan distributes the heat from the ring-shaped heating element in the back panel around the cooking compartment. This heating function is used to measure both the energy consumption in air recirculation mode and the energy efficiency class.
 Grill, large area	For grilling flat items, such as steaks or sausages, for making toast, and for browning food. The whole area below the grill element becomes hot.
 Circulated air grilling	For roasting poultry, whole fish and larger pieces of meat. The grill element and the fan switch on and off alternately. The fan circulates the hot air around the food.
 Top/bottom heating	For traditional baking and roasting on one level. Especially suitable for cakes with moist toppings. Heat is emitted evenly from above and below. This heating function is used to measure the energy consumption in the conventional mode.

Other functions



Your new oven has yet more functions; see below for a brief description of these.

Function	Use
 Rapid heating	Preheats the cooking compartment rapidly without accessories.
 Interior lighting	Switches on the interior lighting; all other functions remain off. Makes it easier to clean the cooking compartment, for example.

Temperature

Use the temperature selector to set the temperature in the cooking compartment. You can also use it to select the settings for other functions.

When cooking at very high temperatures, the appliance lowers the temperature slightly after an extended period.

Position		Meaning
●	"Off" position	The appliance is not heating.
50-275	Temperature range	The temperature that can be set in the cooking compartment in °C.
1, 2, 3 or I, II, III	Grill settings	The configurable settings for the grill, large area  and small area  (depending on the appliance model). Setting 1 = low Setting 2 = medium Setting 3 = high

Temperature display

When the appliance is heating, the indicator lamp above the temperature selector is lit. It goes out during pauses in the heating.

When you are preheating the appliance, the optimal time to place your food in the cooking compartment is when the indicator lamp first goes out.

Note: Due to thermal inertia, the temperature displayed may be slightly different to the actual temperature inside the oven.

Cooking compartment

Various functions in the cooking compartment make your appliance easier to use. For example, the cooking compartment is well lit and a cooling fan prevents the appliance from overheating.

Opening the appliance door

If you open the appliance door when the appliance is in operation, the appliance will continue to operate as before.

Interior lighting

With most heating functions and other functions, the interior lighting in the cooking compartment will remain lit while the oven is in operation. When the function selector is turned to bring operation to an end, the lighting will go out.

By turning the function selector to the interior lighting setting, you can switch on the lighting without heating the oven. This makes it easier to clean your appliance, for example.

Cooling fan

The cooling fan switches on and off as required. The hot air escapes above the door.

Caution!

Do not cover the ventilation slots. Otherwise, the appliance may overheat.

So that the cooking compartment cools down more quickly after operation, the cooling fan continues to run for a certain period afterwards.

Accessories

Your appliance is accompanied by a range of accessories. Here, you can find an overview of the accessories included and information on how to use them correctly.

Accessories included

Your appliance is equipped with the following accessories:

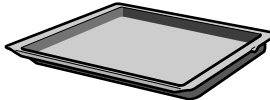
	<p>Wire rack For ovenware, cake tins and ovenproof dishes. For roasts, grilled items and frozen meals.</p>
	<p>Universal pan For moist cakes, pastries, frozen meals and large roasts. It can be used to catch dripping fat when you are grilling directly on the wire rack.</p>

Only use genuine accessories. They are specially adapted for your appliance.

You can buy accessories from the after-sales service, from specialist retailers or online.

Note: The accessories may become deformed when they become hot. This does not affect their function. Once they cool down again, they regain their original shape.

Inserting accessories

The cooking compartment has five shelf positions. The shelf positions are counted from the bottom up.

In some appliances, the highest shelf position is marked on the cooking compartment by the grill symbol.

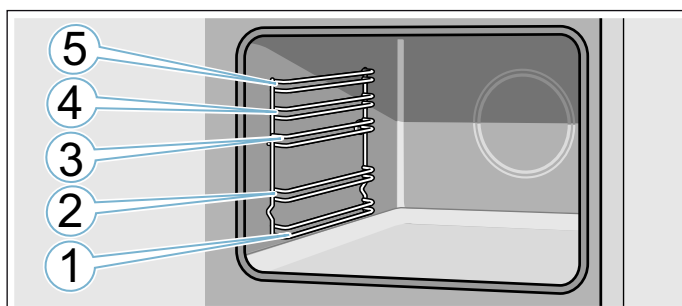

Always insert accessories between the two guide rods for the shelf position.

Accessories can be pulled out approximately halfway without tipping.

When sliding accessories into the cooking compartment, ensure that the kink in the side rail is at the back. Only then will they lock in place.

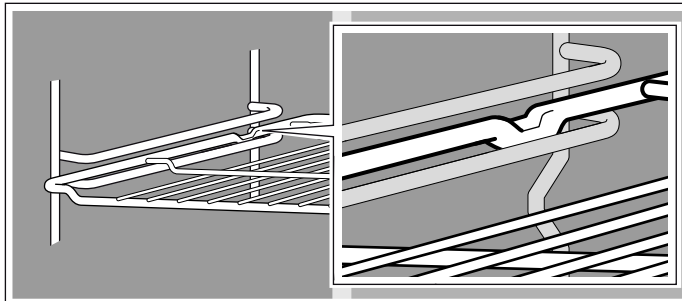

Notes

- Hold the baking tray securely at the sides with both hands and slide it into the shelf supports, keeping it parallel. Do not move the baking tray from side to side as you slide it in, otherwise it will not go in easily and the enamelled surfaces may be damaged.
- Make sure that you always insert the accessories into the cooking compartment the right way round.
- Always insert the accessories fully into the cooking compartment so that they do not touch the appliance door.
- Take any accessories that you will not be using out of the cooking compartment.

Optional accessories

You can buy optional accessories from our after-sales service, from specialist retailers or online. You will find a comprehensive range of products for your appliance in our brochures and online.

Their availability and whether it is possible to order them online varies from country to country. See your sales brochures for more details.

Note: Not all optional accessories are suitable for every appliance. When purchasing, always quote the exact product number (E no.) of your appliance.

→ "Customer service" on page 19

Optional accessories

Wire rack

For cookware, cake tins and ovenproof dishes, and for roasts and grilled food.

Baking tray

For tray bakes and small baked items.

Universal pan

For moist cakes, baked items, frozen food and large roasts.

It can be used to catch dripping fat when you are grilling directly on the wire rack.

Wire insert

For meat, poultry and fish.

For inserting into the universal pan to catch dripping fat and meat juices.

Professional pan

For preparing large quantities of food. Also ideal for moussaka, for example.

Lid for the professional pan

The lid turns the professional pan into a professional roasting dish.

Pizza tray

For pizzas and large round cakes.

Grill tray

Use for grilling in place of the wire rack or as a splatter guard. Use in the universal pan only.

Baking stone

For home-made bread, bread rolls and pizzas that you wish to have a crispy base.

The baking stone must be preheated to the recommended temperature.

Glass roasting dish

For stews and bakes.

Glass pan

For bakes, vegetable dishes and baked items.

Pull-out system, one level

Fitting pull-out rails at position 2 will allow you to pull accessories out further without them tipping.

Pull-out system, two levels

Fitting pull-out rails at positions 2 and 3 will allow you to pull accessories out further without them tipping.

Pull-out system, three levels

Fitting pull-out rails at positions 1, 2 and 3 will allow you to pull accessories out further without them tipping.

Before using for the first time

Before you can use your new appliance, you must make some settings. You must also clean the cooking compartment and accessories.

Cleaning the cooking compartment and accessories

Before using the appliance to prepare food for the first time, you must clean the cooking compartment and accessories.

Cleaning the cooking compartment

To eliminate the new-appliance smell, heat up the cooking compartment when it is empty and with the oven door closed.

Make sure that there is no leftover packaging, such as polystyrene pellets, in the cooking compartment and remove the adhesive tape that is in or on the appliance. Before heating the appliance, wipe the smooth surfaces in the cooking compartment with a soft, damp cloth. Keep the kitchen ventilated while the appliance is heating.

Apply the settings indicated below. You can find out how to set the heating function and the temperature in the next section. → "Operating the appliance" on page 13

Settings	
Heating function	3D Hotair 
Temperature	maximum
Time	1 hour

Switch off the appliance after the time indicated.

Once the cooking compartment has cooled down, clean the smooth surfaces with soapy water and a dish cloth.

Cleaning the accessories

Clean the accessories thoroughly using soapy water and a dish cloth or soft brush.

Operating the appliance

You have already learnt about the controls and how they work. Now we will explain how to apply settings on your appliance.

Switching the appliance on and off

Use the function selector to switch the appliance on or off. Turning the function selector to any position other than the "Off" position switches on the appliance. To switch off the appliance, always turn the function selector to the "Off" position.

Setting the type of heating and temperature

It is very easy to apply the settings you require to your appliance using the function and temperature selector. To find out which heating function is best for which type of food, refer to the beginning of the instruction manual.

Example in the picture: Top/bottom heating  at 190 °C.

1. Use the function selector to set the heating function.

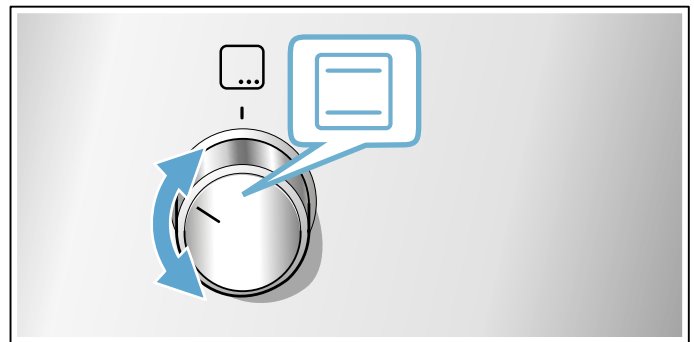

2. Use the temperature selector to set the temperature or grill setting.

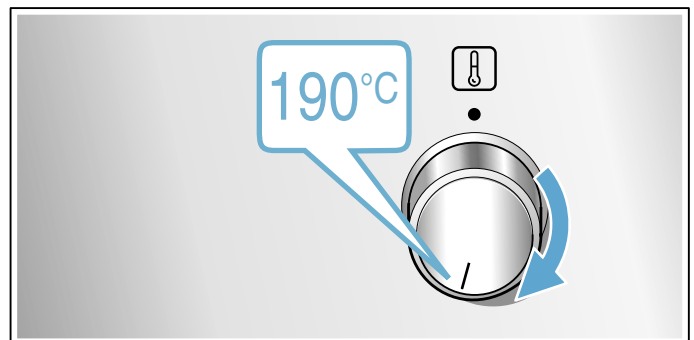

The appliance starts to heat up after a few seconds.

Once the food is cooked, turn the function selector to the "Off" position to switch the appliance off.

Changing

The heating function and temperature can be changed at any time using the relevant selector.

Rapid heating

With Rapid heating, you can shorten the heat-up time.

Then, for best results, use:

-  3D hot air

Only use Rapid heating when a temperature of over 100 °C has been selected.

To achieve an even cooking result, do not place your food into the cooking compartment until Rapid heating is complete.

1. Set the function selector to .
2. Use the temperature selector to set the temperature. The oven will start heating after a few seconds.

When the rapid heating process ends, the heat-up indicator goes out. Place your food in the cooking compartment.

Cleaning

With good care and cleaning, your appliance will retain its appearance and remain fully functioning for a long time to come. We will explain here how you should correctly care for and clean your appliance.

Suitable cleaning agents

To ensure that the different surfaces are not damaged by using the wrong cleaning agent, observe the information in the table. Depending on the appliance model, not all of the areas listed may be on/in your appliance.

Caution!

Risk of surface damage

Do not use:

- Harsh or abrasive cleaning agents,
- Cleaning agents with a high alcohol content,
- Hard scouring pads or cleaning sponges,
- High-pressure cleaners or steam cleaners,
- Special cleaners for cleaning the appliance while it is hot.

Wash new sponge cloths thoroughly before use.

Tip: Highly recommended cleaning and care products can be purchased through the after-sales service. Observe the respective manufacturer's instructions.

Warning – Risk of burns!

The appliance becomes very hot. Never touch the interior surfaces of the cooking compartment or the heating elements. Always allow the appliance to cool down. Keep children at a safe distance.

Area	Cleaning
Appliance exterior	
Stainless steel front	Hot soapy water: Clean with a dish cloth and then dry with a soft cloth. Remove flecks of limescale, grease, starch and albumin (e.g. egg white) immediately. Corrosion can form under such flecks. Special stainless steel cleaning products suitable for hot surfaces are available from our after-sales service or from specialist retailers. Apply a very thin layer of the cleaning product with a soft cloth.
Plastic	Hot soapy water: Clean with a dish cloth and then dry with a soft cloth. Do not use glass cleaner or a glass scraper.
Painted surfaces	Hot soapy water: Clean with a dish cloth and then dry with a soft cloth.
Control panel	Hot soapy water: Clean with a dish cloth and then dry with a soft cloth. Do not use glass cleaner or a glass scraper.

Door panels	Hot soapy water: Clean with a dish cloth and then dry with a soft cloth. Do not use a glass scraper or a stainless steel scouring pad.
Door handle	Hot soapy water: Clean with a dish cloth and then dry with a soft cloth. If descaler comes into contact with the door handle, wipe it off immediately. Otherwise, any stains will not be able to be removed.

Appliance interior

Enamelled surfaces	Hot soapy water or a vinegar solution: Clean with a dish cloth and then dry with a soft cloth. Soften baked-on food remnants with a damp cloth and soapy water. Use stainless steel wire wool or oven cleaner to remove stubborn dirt. Caution! Never use oven cleaner in the cooking compartment when it is still warm. This may damage the enamel. Remove all food remnants from the cooking compartment and the appliance door before you next heat up the appliance. Leave the cooking compartment open to dry after cleaning it. Note: Food residues can cause white deposits to form. These are harmless and do not affect how the appliance works. Remove using lemon juice if required.
Glass cover for the interior lighting	Hot soapy water: Clean with a dish cloth and then dry with a soft cloth. If the cooking compartment is heavily soiled, use oven cleaner.
Door seal Do not remove.	Hot soapy water: Clean with a dish cloth. Do not scour.
Door cover	made from stainless steel: Use stainless steel cleaner. Follow the manufacturers' instructions. Do not use stainless steel care products. made from plastic: Clean using hot soapy water and a dish cloth. Dry with a soft cloth. Do not use glass cleaner or a glass scraper. Remove the door cover for cleaning.
Rails	Hot soapy water: Soak and clean with a dish cloth or brush.
Pull-out system	Hot soapy water: Clean with a dish cloth or a brush. Do not remove the lubricant while the pull-out rails are pulled out – it is best to clean them when they are pushed in. Do not clean in the dishwasher.
Accessories	Hot soapy water: Soak and clean with a dish cloth or brush. If there are heavy deposits of dirt, use a stainless steel scouring pad.

Notes

- Slight differences in colour on the front of the appliance are caused by the use of different materials, such as glass, plastic and metal.
- Shadows on the door panels, which look like streaks, are caused by reflections made by the interior lighting.
- Enamel is baked on at very high temperatures. This can cause some slight colour variation. This is normal and does not affect operation. The edges of thin trays cannot be completely enamelled. As a result, these edges can be rough. This does not impair the anti-corrosion protection.

Keeping the appliance clean

Always keep the appliance clean and remove dirt immediately so that stubborn deposits of dirt do not build up.

Warning – Risk of fire!

Loose food remnants, fat and meat juices may catch fire. Before using the appliance, remove the worst of the food remnants from the cooking compartment, heating elements and accessories.

Tips

- Clean the cooking compartment after each use. This will ensure that dirt cannot be baked on.
- Always remove flecks of limescale, grease, starch and albumin (e.g. egg white) immediately.
- Use the universal pan for baking very moist cakes.
- Use suitable ovenware for roasting, e.g. a roasting dish.

Rails

With good care and cleaning, your appliance will retain its appearance and remain fully functional for a long time to come. This will tell you how to remove the shelves and clean them.

Detaching and refitting the rails

The rails can be removed for cleaning. The oven must have cooled down.

Detaching the rails

1. Lift up the front of the rail
2. and unhook it (figure A).
3. Then pull the whole rail forward
4. and remove it (Fig. B).

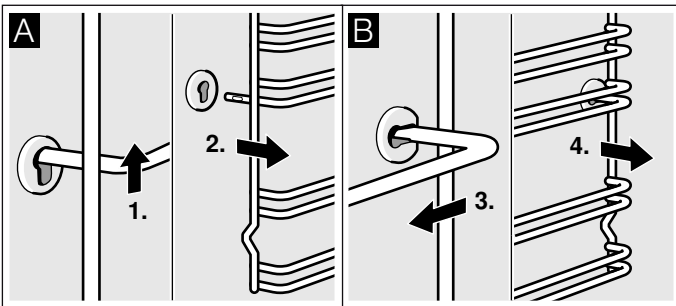

Clean the rails with cleaning agent and a sponge. For stubborn deposits of dirt, use a brush.

Refitting the rails

1. First insert the rail into the rear socket, press it to the back slightly (figure A),
2. and then hook it into the front socket (figure B).

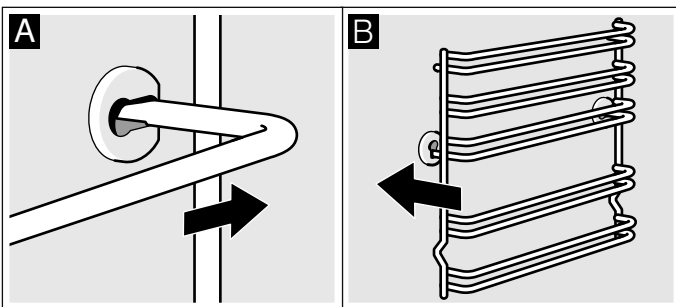

The rails fit both the left and right sides. Ensure that, as shown in figure B, levels 1 and 2 are below and levels 3, 4 and 5 are above.

Appliance door

With good care and cleaning, your appliance will retain its appearance and remain fully functional for a long time to come. This will tell you how to remove the appliance door and clean it.

Detaching and attaching the oven door

For cleaning purposes and to remove the door panels, you can detach the oven door.

The oven door hinges each have a locking lever. When the locking levers are closed (figure A), the oven door is secured in place. It cannot be detached. When the locking levers are open in order to detach the oven door (Fig. B), the hinges are locked. They cannot snap shut.

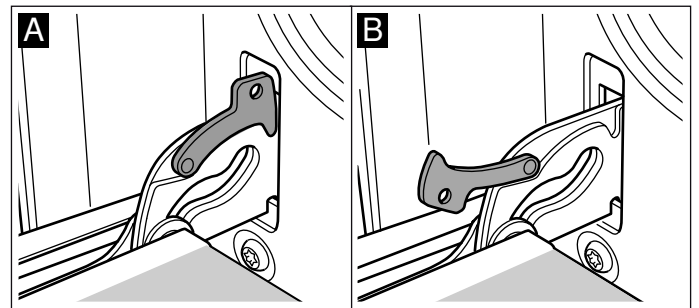

Warning – Risk of injury!

Whenever the hinges are not locked, they snap shut with great force. Ensure that the locking levers are always fully closed or, when detaching the oven door, fully open.

Detaching the door

1. Open the oven door fully.
2. Fold up the two locking levers on the left and right (figure A).
3. Close the oven door as far as the limit stop. With both hands, grip the door on the left and right-hand sides. Close the door a little further and pull it out (figure B).

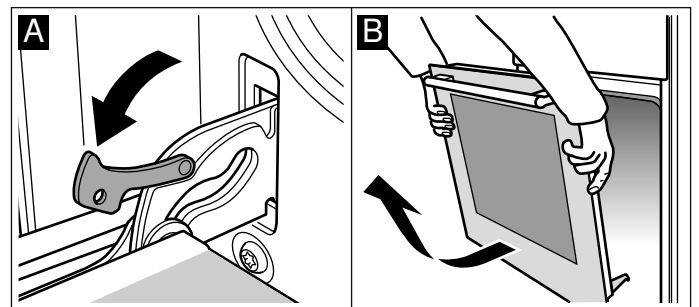

Attaching the door

Reattach the oven door in the reverse sequence to removal.

1. When attaching the oven door, ensure that both hinges are inserted straight into the opening (figure A).
2. The notch on the hinge must engage on both sides (figure B).

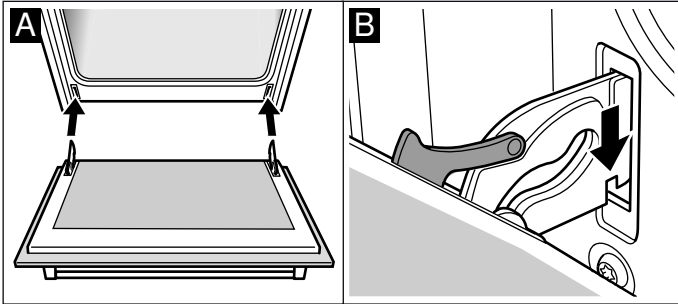

3. Fold back both locking levers (figure C). Close the oven door.

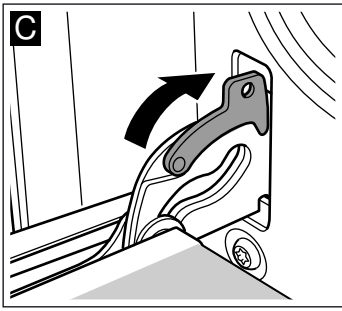

⚠ Warning – Risk of injury!

If the oven door falls out accidentally or a hinge snaps shut, do not reach into the hinge. Call the after-sales service.

Removing and installing the door panels

To facilitate cleaning, you can remove the glass panels from the oven door.

Removal

1. Detach the oven door and lay it on a cloth with the handle facing down.
2. Pull off the cover at the top of the oven door. Press in the tabs on the left and right using your fingers (fig. A).
3. Lift the top panel up and pull it out (fig. B).

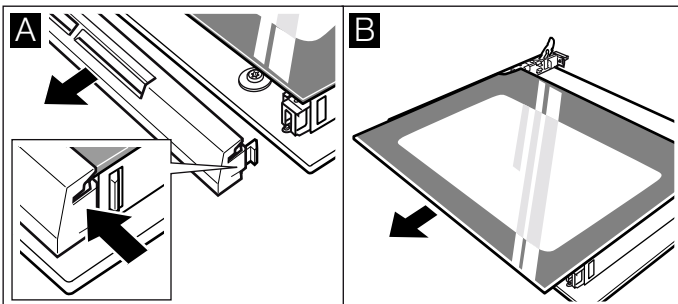

4. Lift the panel up and pull it out (fig. C).

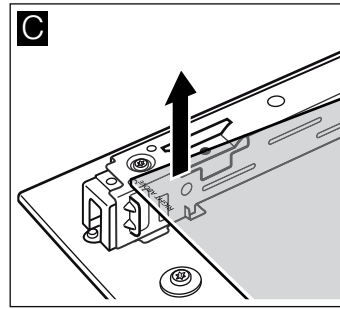

Clean the panels with glass cleaner and a soft cloth.

⚠ Warning – Risk of injury!

Scratched glass in the appliance door may develop into a crack. Do not use a glass scraper, sharp or abrasive cleaning aids or detergents.

Installation

During installation, make sure that the lettering "top right" is upside down at the bottom left.

1. Insert the panel at an angle towards the back (fig. A).
2. Insert the top panel at an angle towards the back into the brackets. The smooth surface must face outwards. (fig. B).

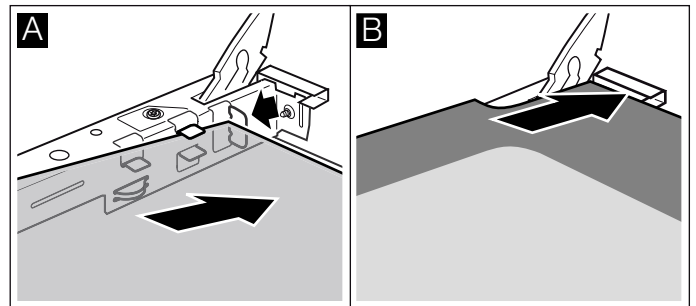

3. Put the cover back in place and press on it.
4. Attach the oven door.

Do not use the oven again until the panels have been correctly installed.

Trouble shooting

If a fault occurs, there is often a simple explanation. Before calling the after-sales service, please refer to the fault table and attempt to correct the fault yourself.

Rectifying faults yourself

You can often easily rectify technical faults with the appliance yourself.

If a dish does not turn out exactly as you wanted, you can find useful cooking tips and instructions at the end of this instruction manual. → "Tested for you in our cooking studio" on page 19

Fault	Possible cause	Notes/remedy
The appliance is not working.	Defective circuit breaker.	Check the circuit breaker in the fuse box.
	Power failure	Check whether the kitchen light or other kitchen appliances are working.

Warning – Risk of injury!

Incorrect repairs are dangerous. Do not attempt to repair the appliance yourself. Repairs must only be carried out by one of our trained after-sales engineers. If the appliance is defective, call the after-sales service.

Warning – Risk of electric shock!

Incorrect repairs are dangerous. Repairs may only be carried out and damaged power cables replaced by one of our trained after-sales technicians. If the appliance is defective, unplug the appliance from the mains or switch off the circuit breaker in the fuse box. Contact the after-sales service.

Replacing the bulb in the top of the cooking compartment

If the cooking compartment light bulb fails, it must be replaced. Heat-resistant, 25 watt, 230 V halogen bulbs are available from the after-sales service or specialist retailers.

When handling the halogen bulb, use a dry cloth. This will increase the service life of the bulb. Only use these bulbs.

Warning – Risk of electric shock!

When replacing the cooking compartment bulb, the bulb socket contacts are live. Before replacing the bulb, unplug the appliance from the mains or switch off the circuit breaker in the fuse box.

Warning – Risk of burns!

The appliance becomes very hot. Never touch the interior surfaces of the cooking compartment or the heating elements. Always allow the appliance to cool down. Keep children at a safe distance.

1. Place a tea towel in the cold cooking compartment to prevent damage.
2. Turn the glass cover anti-clockwise to remove it (figure **1**).
3. Pull out the bulb – do not turn it (figure **2**). Insert the new bulb, making sure that the pins are in the correct position. Push the bulb in firmly.

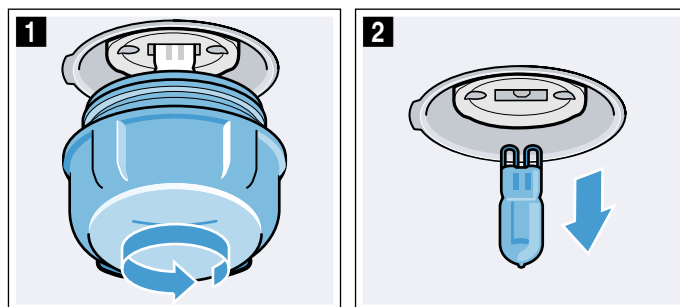

4. Screw the glass cover back on. Depending on the appliance model, the glass cover may have a sealing ring. If the glass cover has a sealing ring, put it back in place before screwing the cover back on.
5. Remove the tea towel and switch on the circuit breaker.

Customer service

Our after-sales service is there for you if your appliance needs to be repaired. We will always find an appropriate solution, also in order to avoid after-sales personnel having to make unnecessary visits.

E number and FD number

When calling us, please give the product number (E no.) and the production number (FD no.) so that we can provide you with the correct advice. The rating plate containing these numbers is found on the side of the oven door. To save time, you can make a note of the number of your appliance and the telephone number of the after-sales service in the space below, should it be required.

E no.		FD no.	
After-sales service 			

Please note that there will be a fee for a visit by a service technician in the event of a malfunction, even during the warranty period.

Please find the contact data of all countries in the enclosed customer service list.

To book an engineer visit and product advice

GB 0344 892 8979
Calls charged at local or mobile rate.

IE 01450 2655
0.03 € per minute at peak. Off peak 0.0088 € per minute.

Rely on the professionalism of the manufacturer. You can therefore be sure that the repair is carried out by trained service technicians who carry original spare parts for your appliances.

This product contains light sources from energy efficiency class G.

Tested for you in our cooking studio

Here, you can find a selection of dishes and the ideal settings for them. We will show you which type of heating and temperature are best suited to your dish. You will get information on suitable cooking accessories and the height at which they should be placed in the oven. You will also get tips about cookware and preparation methods.

Note: A lot of steam can build up in the cooking compartment when cooking food. Your appliance is very energy-efficient and radiates very little heat to its surroundings during operation. Due to the significant differences in temperature between the appliance interior and the external parts of the appliance, condensation may build up on the door, the control panel or the front panels of adjacent kitchen cabinets. This is a normal physical phenomenon. Condensation can be reduced by preheating the oven or opening the door carefully.

General information

Recommended setting values

The table lists the optimal heating function for various types of food. The temperature and cooking time depend on the amount of food and the recipe. For this reason, the table specifies setting ranges. Try using the lower value to start with. A lower temperature will result in more even browning. You can increase the temperature next time if necessary.

Note: Cooking times cannot be reduced by using higher temperatures. The food would only be cooked on the outside, but would not be fully cooked in the middle.

The setting values apply to food placed in the cooking compartment while the cooking compartment is still cold. This will save energy. If you preheat the oven, you can reduce the indicated baking times by several minutes.

Preheating is necessary for selected types of food – this is indicated in the table. Do not place your food and accessory into the cooking compartment until it has finished preheating.

If you wish to follow one of your own recipes, you should use the settings listed in the table for similar food as reference. Additional information can be found in the baking tips listed after the settings tables.

Remove any accessories that are not being used from the cooking compartment. This will allow you to achieve optimal cooking results while saving energy.

Gentle hot air heating function

Gentle hot air is an intelligent heating function that allows you to gently cook meat, fish and baked items. The appliance optimally controls the supply of energy to the cooking compartment. The food is cooked in phases using residual heat. This means that it remains more succulent and browns less. Depending on the method of preparation and the type of food, it is possible to save energy. If you open the appliance door before the food has finished cooking or if you preheat the appliance, you may not be able to achieve this result.

Only use genuine accessories for your appliance. These have been tailored to the cooking compartment and the heating functions of your appliance. Remove any accessories that are not being used from the cooking compartment.

Place the food into the empty cooking compartment before the oven is heated up. Select a temperature of between 120 °C and 230 °C. Always keep the appliance door closed when cooking. Only cook on one level when using this function.

The Gentle hot air heating function is used to measure both the energy consumption in air recirculation mode and the energy efficiency class.

Baking on one level

When baking on one level, use the following shelf positions:

- Position 2 – tall baked items and tins/dishes on the wire rack
- Position 3 – shallow baked items and baking trays

Baking on two or more levels

Use the hot air heating function. Items that are placed in the oven on baking trays or in baking tins/dishes at the same time will not necessarily be ready at the same time.

Baking on two levels:

- Universal pan, position 3
Baking tray, position 1
- Baking tins/dishes on the wire rack
First wire rack, position 3
Second wire rack, position 1

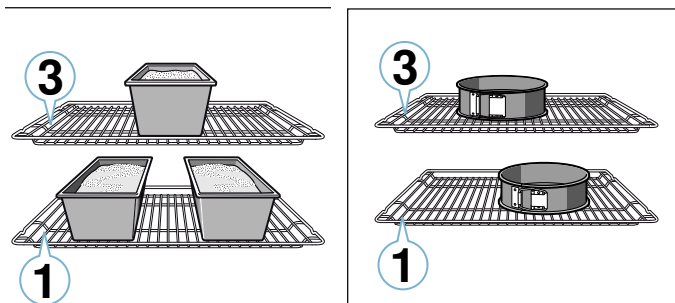

Baking on three levels:

- Baking tray, position 5
Universal pan, position 3
Baking tray, position 1

You can cut energy use by cooking different items at the same time. Position baking tins/dishes either next to one another or offset on different shelves so that they

are not directly one above the other in the cooking compartment.

Accessories

Only use original accessories supplied with your appliance. These have been tailored to the cooking compartment and the operating modes of your appliance.

Ensure that you always use suitable accessories and that they are placed in the oven the right way around.
→ "Accessories" on page 11

Greaseproof paper

Only use greaseproof paper that is suitable for the selected temperature. Always cut greaseproof paper to size.

Cakes and pastries

Your appliance offers you a range of heating types for the preparation of cakes and small baked items. You can find the ideal settings for many dishes in the settings tables.

Also refer to the notes in the section on allowing dough to rise.

Baking tins

For optimal cooking results, we recommend using dark-coloured metal baking tins.

Tinplate baking tins, ceramic dishes and glass dishes extend baking time and mean that the baked item will not brown evenly.

If you are using silicone moulds, follow the manufacturer's instructions and recipes. Silicone moulds are often smaller than normal baking tins. Quantity and recipe specifications may vary.

Frozen products

Do not use frozen products that are heavily frosted. Remove any ice on the food.

Some frozen products may be unevenly pre-baked. Uneven browning may remain even after baking.

Bread and rolls

Caution!

Never pour water into the hot cooking compartment or place cookware containing water onto the bottom of the cooking compartment. The change in temperature can cause damage to the enamel.

Some food turns out better if it is baked in several stages. These dishes are indicated in the table.

The setting values for bread dough apply to both dough placed on a baking tray and dough placed in a loaf tin.

Cakes in tins

Dish	Accessories/cookware	Shelf position	Heating function	Temperature in °C	Cooking time in mins
Sponge cake, simple	Vienna ring tin/loaf tin	2		160-180	50-60
Sponge cake, simple, 2 levels	Vienna ring tin/loaf tin	3+1		140-160	60-80
Sponge cake, delicate	Vienna ring tin/loaf tin	2		150-170	60-80
Sponge flan base	Flan tin	3		160-180	30-40
Fruit tart or cheesecake with shortcrust pastry base	26 cm springform cake tin	2		160-180	70-90
Tart	Tart dish or tin	1		200-240	25-50
Yeast cake	28 cm springform cake tin	2		150-160	25-35
Bundt cake	Bundt cake tin	2		150-170	60-80
3-egg fatless sponge cake	26 cm springform cake tin	2		160-170	30-40
6-egg fatless sponge cake	28 cm springform cake tin	2		160-170	35-45

Cakes on trays



Dish	Accessories/cookware	Shelf position	Heating function	Temperature in °C	Cooking time in min
Sponge cake with topping	Universal pan	3		160-180	20-45
Small yeast cakes, 2 levels	Universal pan + baking tray	3+1		140-160	30-55
Shortcrust tart with dry topping	Universal pan	2		170-190	25-35
Shortcrust tart with dry topping, 2 levels	Universal pan + baking tray	3+1		160-170	35-45
Shortcrust tart with moist topping	Universal pan	2		160-180	60-90
Yeast cake with dry topping	Universal pan	3		170-180	25-35
Yeast cake with dry topping, 2 levels	Universal pan + baking tray	3+1		150-170	20-30
Yeast cake with moist topping	Universal pan	3		160-180	30-50
Yeast cake with moist topping, 2 levels	Universal pan + baking tray	3+1		150-170	40-65
Plaited ring/loaf	Universal pan	2		160-170	35-40
Swiss roll	Universal pan	2		170-190*	15-20
Strudel, sweet	Universal pan	2		190-210	55-65
Strudel, frozen	Universal pan	3		200-220	35-40

* Preheat for 10 minutes











Small baked items

Dish	Accessories/cookware	Shelf position	Heating function	Temperature in °C	Cooking time in mins
Muffins	Muffin tray	2		170-190	20-40
Muffins, 2 levels	Muffin trays	3+1		160-170	30-40
Small yeast cakes	Universal pan	3		150-170	25-35
Small yeast cakes, 2 levels	Universal pan + baking tray	3+1		150-170	25-40
Puff pastry	Universal pan	3		180-200	20-30
Puff pastry, 2 levels	Universal pan + baking tray	3+1		180-200	25-35
Puff pastry, 3 levels	Baking trays + universal pan	5+3+1		170-190	30-45

Tested for you in our cooking studio









Dish	Accessories/cookware	Shelf position	Heating function	Temperature in °C	Cooking time in mins
Choux pastry	Universal pan	3		190-210	35-50
Choux pastry, 2 levels	Universal pan + baking tray	3+1		190-210	35-45

Biscuits

Dish	Accessories/cookware	Shelf position	Heating function	Temperature in °C	Cooking time in mins
Viennese whirls	Universal pan	3		140-150*	30-40
Viennese whirls, 2 levels	Universal pan + baking tray	3+1		140-150*	30-45
Viennese whirls, 3 levels	Baking trays + universal pan	5+3+1		130-140*	40-55
Biscuits	Universal pan	3		140-160	20-30
Biscuits, 2 levels	Universal pan + baking tray	3+1		130-150	25-35
Biscuits, 3 levels	Baking trays + universal pan	5+3+1		130-150	30-40
Meringue	Universal pan	3		80-100	100-150
Meringue, 2 levels	Universal pan + baking tray	3+1		90-100*	100-150
Macaroons	Universal pan	2		100-120	30-40
Macaroons, 2 levels	Universal pan + baking tray	3+1		100-120	35-45
Macaroons, 3 levels	Baking trays + universal pan	5+3+1		100-120	40-50







* Preheat

Bread and rolls

Dish	Accessories/cookware	Shelf position	Heating function	Step	Temperature in °C	Cooking time in mins
Bread, 750 g (in a loaf tin or free-form)	Universal pan or loaf tin	2		-	180-200	50-60
Bread, 1000 g (in a loaf tin or free-form)	Universal pan or loaf tin	2		-	200-220	35-50
Bread, 1500 g (in a loaf tin or free-form)	Universal pan or loaf tin	2		-	180-200	60-70
Flatbread	Universal pan	3		-	240-250	25-30
Bread rolls, sweet, fresh	Universal pan	3		-	170-180*	20-30
Bread rolls, sweet, fresh, 2 levels	Universal pan + baking tray	3+1		-	160-180*	15-25
Bread rolls, fresh	Universal pan	3		-	200-220	20-30
Toast with topping, 4 slices	Wire rack	3		-	200-220	15-20
Toast with topping, 12 slices	Wire rack	3		-	220-240	15-25

* Preheat

Pizza, quiche and savoury cakes

Dish	Accessories/cookware	Shelf position	Heating function	Temperature in °C	Cooking time in min
Pizza, fresh	Universal pan	2		190-210	20-30
Pizza, fresh, 2 levels	Universal pan + baking tray	3+1		160-180	35-45
Pizza, fresh, thin-crust	Universal pan	2		250-270*	20-30
Pizza, chilled	Universal pan	3		190-210*	10-15
Pizza, frozen, thin-crust, x 1	Wire rack	2		190-210	15-25
Pizza, frozen, thin-crust, x 2	Universal pan + wire rack	3+1		190-210	20-25

* Preheat

Dish	Accessories/cookware	Shelf position	Heating function	Temperature in °C	Cooking time in min
Pizza, frozen, deep-pan, x 1	Wire rack	2		200-210	20-30
Pizza, frozen, deep-pan, x 2	Universal pan + wire rack	3+1		170-190	20-30
Mini pizzas	Universal pan	3		190-210	10-20
Savoury cakes in a tin	28 cm springform cake tin	3		170-190	50-60
Quiche	Tart dish or tin	1		210-230	40-50
Tart	Ovenproof dish	2		170-190	55-65
Empanadas	Universal pan	3		180-190	35-45
Börek	Universal pan	2		190-210	35-45

* Preheat

Baking tips





You want to find out whether the baked item is completely cooked in the middle.	Push a cocktail stick into the highest point on the baked item. If the cocktail stick comes out clean with no dough residue, the baked item is ready.
The baked item collapses.	Next time, use less liquid. Alternatively, set the temperature 10 °C lower and extend the baking time. Adhere to the specified ingredients and preparation instructions in the recipe.
The baked item has risen in the middle but is lower around the edge.	Only grease the base of the springform cake tin. After baking, loosen the baked item carefully with a knife.
The fruit juice overflows.	Next time, use the universal pan.
Small baked items stick to one another during baking.	There should be a gap of approx. 2 cm around each item. This gives enough space for the baked items to expand well and brown on all sides.
The baked item is too dry.	Set the temperature 10 °C higher and shorten the baking time.
The baked item is too light in colour overall.	If the shelf position and the accessories are correct, then you should increase the temperature if necessary or extend the baking time.
The baked item is too light on top, and too dark underneath.	Bake the cake one level higher in the oven the next time.
The baked item is too dark on top, and too light underneath.	Bake the cake one level lower in the oven the next time. Select a lower temperature and extend the baking time.
The baked item is too dark in a tin or loaf tin.	Place the baking tray in the middle of the accessory, not directly against the back wall.
The baked item is too dark in colour overall.	Select a lower temperature next time and extend the baking time if necessary.
The baked item is unevenly browned.	Select a slightly lower temperature. Protruding greaseproof paper can affect the air circulation. Always cut greaseproof paper to size. Ensure that the baking tin does not stand directly in front of the openings in the cooking compartment back wall. When baking small items, you should use similar sizes and thicknesses wherever possible.
You were baking on several levels. The items on the top baking tray are darker than those on the lower baking tray.	Always select hot air when baking on several levels. Baked items that are placed into the oven on trays or in baking tins at the same time will not necessarily be ready at the same time.
The baked item looks good, but is not cooked properly in the middle.	Use a lower temperature and bake slightly longer; if necessary, add slightly less liquid. For baked items with a moist topping, bake the base first. Sprinkle it with almonds or breadcrumbs and then place the topping on top.
The baked item cannot be turned out of the dish when it is turned upside down.	Allow the baked item to cool down for 5 to 10 minutes after baking. If it still sticks, carefully loosen it around the edges again using a knife. Turn the baked item upside down again and cover it several times with a cold, wet cloth. Next time, grease the baking tin and sprinkle with breadcrumbs.

Bakes and gratins

Your appliance offers a range of heating functions for cooking bakes. The settings tables list the optimal settings for a wide range of dishes.

How well cooked a bake is will depend on the size of the cookware and the shelf position of the bake.

Use wide, shallow cookware for bakes and gratins. Food takes longer to cook in deep, narrow cookware and it browns more on top.

Dish	Accessories/cookware	Shelf position	Heating function	Temperature in °C	Cooking time in mins
Bake, savoury, cooked ingredients	Ovenproof dish	2		200-220	30-60
Bake, sweet	Ovenproof dish	2		180-200	50-60
Potato gratin, raw ingredients, 4 cm deep	Ovenproof dish	2		150-170	60-80
Potato gratin, raw ingredients, 4 cm deep, 2 levels	Ovenproof dish	3+1		150-160	70-80

Poultry, meat and fish

Your appliance offers you a range of heating types for preparing poultry, meat and fish. You can find the ideal settings for certain dishes in the settings tables.

Roasting on the wire rack

Roasting on the wire rack works particularly well for large poultry or for multiple pieces at the same time.

Place the food to be grilled directly onto the wire rack. If you are grilling a single piece, place it in the centre of the wire rack for best results.

The universal pan should also be inserted at position 1. This will catch the meat juices that drip down and keeps the cooking compartment clean.

Add up to ½ litre of water to the universal pan, depending on the size and type of joint. This will catch the liquid that drips down. You can make a sauce from these juices. This will also result in less smoke being produced and keep the cooking compartment clean.

Roasting in cookware

Warning – Risk of injury caused by shattering glass!

Place hot glass cookware on a dry mat after cooking. If the surface is damp or cold, the glass may crack.

Warning – Risk of scalding!

Very hot steam may escape when opening the lid after cooking. Lift the lid at the rear, so that the hot steam can escape away from you.

Only use cookware which is suitable for use in an oven. Glass cookware is best. Check whether the cookware fits in the cooking compartment.

Shiny roasting dishes made from stainless steel or aluminium reflect heat like a mirror and are therefore not particularly suitable. The poultry, meat and fish cooks slower and does not brown so well. Use a higher temperature and/or a longer cooking time.

Observe the manufacturer's instructions for your roasting cookware.

Always use the shelf positions indicated.

You can cook food on one level in baking tins/dishes or in the universal pan.

- Baking tins/dishes on the wire rack: Position 2
- Universal pan, position 3

You can cut energy use by cooking different items at the same time. Position baking tins/dishes next to one another in the cooking compartment.

Uncovered cookware

To cook poultry, meat and fish, it is best to use a deep roasting tin. Place the tin onto the wire rack. If you do not have any suitable cookware, use the universal pan.

Covered cookware

When cooking with covered cookware, the cooking compartment remains considerably cleaner. Ensure that the lid fits well and closes properly. Place the cookware onto the wire rack.

Poultry, meat and fish can also become crispy in a covered roasting dish. Simply use a roasting dish with a glass lid and set a higher temperature.

Grilling

Keep the appliance door closed when using the grill. Never grill with the appliance door open.

Place the food to be grilled on the wire rack. In addition, slide the universal pan in at least one shelf position lower, with the slanted edge facing the appliance door. Any dripping fat will be caught.

When grilling, try wherever possible to use pieces of food which are of a similar thickness and weight. This will allow them to brown evenly and remain succulent and juicy. Place the food to be grilled directly onto the wire rack.

Use tongs to turn the pieces of food you are grilling. If you pierce the meat with a fork, the juices will run out and it will become dry.

Do not add salt to the meat until it has been grilled. Salt draws water from the meat.

Notes

- The grill element switches itself on and off repeatedly; this is normal. The grill setting determines how frequently this occurs.
- Smoke may be produced when grilling.
- When you are using the grill, do not insert the baking tray or universal pan into the cooking compartment any higher than shelf position 3. The high temperatures at the top of the cooking compartment can warp accessories, which may damage the cooking compartment when removed.

Meat thermometer

Depending on your appliance's features, you may have a meat thermometer. You can cook accurately using a meat thermometer. Read important notes on using the meat thermometer in the corresponding chapter. There, you can find notes on inserting the meat thermometer, the possible heating types and additional information.

Recommended setting values

The setting values are based on the assumption that unstuffed, chilled, ready-to-roast poultry, meat or fish is placed into a cold cooking compartment.

In the table, you can find specifications for poultry, meat and fish with default values for the weight. If you wish to prepare heavier poultry, meat or fish, always use the lower temperature. If roasting several joints, use the weight of the heaviest piece as a basis for determining the cooking time. The individual pieces should be approximately equal in size.

The larger the poultry, meat or fish is, the lower the cooking temperature and the longer the cooking time.

Turn the poultry, meat and fish after approx. $\frac{1}{2}$ to $\frac{2}{3}$ of the indicated time.

Poultry

When cooking duck or goose, pierce the skin on the underside of the wings. This allows the fat to run out.

If using duck breast, score the skin. Do not turn duck breasts.

Add some liquid to the poultry in the dish. Cover the base of the ovenware with approx. 1-2 cm of liquid.











When you turn poultry, ensure that the breast side or the skin side is underneath at first.

Poultry will turn out particularly crispy and brown if you baste it towards the end of the roasting time with butter, salted water or orange juice.

Meat

Baste lean meat with fat as required or cover it with strips of bacon.

Poultry

Dish	Accessories/cookware	Shelf position	Heating function	Temperature in °C	Cooking time in mins
Chicken, 1.3 kg	Wire rack	2		200-220	60-70
Small chicken portions, 250 g each	Wire rack	3		220-230	30-35
Chicken goujons, nuggets, frozen	Universal pan	3		190-210	20-25
Duck, 2 kg	Wire rack	2		190-210	100-110
Duck breast, medium, 300 g each	Wire rack	3		240-260	30-40
Goose, 3 kg	Wire rack	2		170-190	120-140
Goose legs, 350 g each	Wire rack	3		220-240	40-50
Small turkey, 2.5 kg	Wire rack	2		180-200	80-100
Turkey breast, boned, 1 kg	Cookware, covered	2		240-260	80-100
Turkey thigh, bone in, 1 kg	Wire rack	2		180-200	90-100

When roasting, add a little liquid if the meat is lean. A covering of approx. $\frac{1}{2}$ cm depth should be applied to the base of any glass cookware.

Score the rind crosswise. If you turn the joint when cooking, ensure that the rind is underneath at first.

When the joint is ready, turn off the oven and allow it to rest for another 10 minutes in the cooking compartment. This allows the meat juices to be better distributed. Wrap the joint in aluminium foil if necessary. The recommended resting time is not included in the cooking time indicated.

It is more convenient to roast and braise meat in cookware. You can take the joint out of the cooking compartment more easily in the cookware, and prepare the sauce in the cookware itself.

The quantity of liquid is dependent on the type of meat, the cookware material and also on whether or not a lid is used. If preparing meat in an enamelled or dark metal roasting dish, it will need a little more liquid than if cooked in glass cookware.

The steam evaporates in the cookware when roasting. Carefully pour in more liquid if required.

The distance between the meat and the lid should be at least 3 cm. The meat may rise.

If necessary, braise the meat first by searing it. Add water, wine, vinegar or a similar liquid to the braising liquid. A covering approx. 1-2 cm deep should be applied to the base of the cookware.

Fish

Fish cooked whole does not have to be turned. Place the whole fish into the cooking compartment in swimming position with the dorsal fin facing upwards. Placing half a potato or a small oven-proof container in the stomach cavity of the fish will provide stability.

You can tell when the fish is cooked because the dorsal fin can be removed easily.

When stewing, add two to three tablespoons of liquid and a little lemon juice or vinegar into the cookware.

Meat

Dish	Accessories/cookware	Shelf position	Heating function	Step	Temperature in °C	Cooking time in mins
Leg of lamb, boned, medium, 1.5 kg	Cookware, uncovered	2		-	170-190	70-80*
Saddle of lamb on the bone, medium, 1.5 kg	Wire rack	2		-	180-190	45-55*/**

* Do not turn

** Slide the universal pan in at shelf position 1

Fish

Fish	Weight	Accessories and cookware	Position	Heating function	Temperature in °C, grill setting	Cooking time in minutes
Fish, whole	Approx. 300 g each	Wire rack	2		2	20-25
	1.0 kg	Wire rack	2		180-200	45-50
	1.5 kg	Wire rack	2		170-190	50-60
Fish steak, 3 cm thick		Wire rack	3		2	20-25





Tips on roasting and braising

The cooking compartment becomes very dirty.	Prepare your food in an enclosed roasting dish with higher temperature or use the grill tray. You will achieve the best roasting results if you use the grill tray. The grill tray can be bought later as a special accessory.
The roast is too dark and the crackling is burned in places, and/or the roast is too dry.	Check the shelf position and temperature. Select a lower temperature the next time and reduce the roasting time if necessary.
The crackling is too thin.	Increase the temperature or switch on the grill briefly at the end of the roasting time.
The roast looks good but the juices are burnt.	Next time, use a smaller roasting dish and add more liquid if necessary.
The roast looks good but the juices are too clear and watery.	Next time, use a larger roasting dish and add less liquid if necessary.
The meat gets burned during braising.	The roasting dish and lid must fit together well and close properly. Reduce the temperature and add more liquid when braising if necessary.

Vegetables and side dishes

Adhere to the specifications in the table.

Here, you can find information for preparing grilled vegetables, potatoes and frozen potato products.

Dish	Accessories/cookware	Shelf position	Heating function	Temperature in °C	Cooking time in mins
Grilled vegetables	Universal pan	5		3	10-20
Baked potatoes, halved	Universal pan	3		160-180	45-60
Potato products, frozen, e.g. chips, croquettes, potato pockets, rösti	Universal pan	3		200-220	25-35
Chips, 2 levels	Universal pan + baking tray	3+1		190-210	30-40

Yoghurt

You can use your appliance to make your own yoghurt.

Remove accessories and shelf supports from the cooking compartment. The cooking compartment must be empty.

1. Heat 1 litre of milk (3.5% fat) to 90 °C on the hob and then leave it to cool down to 40 °C.

2. Stir in 30 g (approx. 1 tbsp) (chilled) yoghurt.
3. Pour into cups or small jars with lids and cover.
4. Place the cups or jars onto the cooking compartment floor and use the settings indicated in the table.
5. After making the yoghurt, leave it to cool in the refrigerator.

Dish	Accessories/cookware	Shelf position	Heating function	Temperature in °C	Cooking time
Yoghurt	Cup/jar	Cooking compartment floor		-	4-5h

Acrylamide in foodstuffs

Acrylamide is mainly produced in grain and potato products prepared at high temperatures, such as potato

crisps, chips, sliced bread, bread rolls, bread or fine baked goods (biscuits, gingerbread, spiced biscuit).

Tips for keeping acrylamide to a minimum

General	<ul style="list-style-type: none"> ■ Keep cooking times as short as possible. ■ Cook food until it is golden brown, but not too dark. ■ Large, thick pieces of food contain less acrylamide.
Baking	<p>With top/bottom heating at max. 200 °C.</p> <p>With hot air at max. 180 °C.</p>
Biscuits	<p>With top/bottom heating at max. 190 °C.</p> <p>With hot air at max. 170 °C.</p> <p>Egg or egg yolk reduces the production of acrylamide.</p>
Oven chips	<p>Spread out a single layer evenly on the baking tray. Cook approx. 400-600 g at once on a baking tray so that the chips do not dry out and become crunchy.</p>

Drying

You can achieve outstanding drying results with hot air. With this type of preserving, flavours are concentrated as a result of the dehydration.

Only use unblemished, fresh fruit, vegetables and herbs and wash them thoroughly. Line the wire rack with greaseproof paper or parchment paper. Drain the excess water from the fruit and then dry the fruit thoroughly.

If necessary, cut it into pieces of equal size or slice it thinly. Place unpeeled fruit onto the dish with the sliced surfaces facing upwards. Ensure that neither fruit nor mushrooms overlap on the wire rack.

Grate vegetables and then blanch them. Drain the excess water from the blanched vegetables and spread them evenly on the wire rack.

Dry herbs on the stem. Spread the herbs out evenly and slightly heaped on the wire rack.

Fruit, vegetables and herbs	Accessories	Heating function	Temperature in °C	Cooking time in hours
Pomes (apple rings, 3 mm thick, 200 g per wire rack)	1-2 wire racks		80	4-8
Root vegetables (carrots), grated, blanched	1-2 wire racks		80	4-7
Sliced mushrooms	1-2 wire racks		80	5-8
Herbs, washed	1-2 wire racks		60	2-5

Prove dough

Your yeast dough will prove considerably more quickly using this heating function than at room temperature and will not dry out. Do not start the appliance if the cooking compartment is not completely cool.

Always allow yeast dough to prove twice. Use the settings indicated in the settings tables for the first and second proving stages (dough fermentation stage and final fermentation stage).

Dough fermentation

Place the dough into a heat-resistant bowl and place this onto the wire rack. Use the settings indicated in the table.

Do not open the appliance door while the dough is proving, otherwise moisture will escape. Do not cover the dough.

Dish	Accessories/cookware	Shelf position	Heating function	Step	Temperature in °C	Cooking time in mins
Yeast dough, light	Bowl	2		1.	-*	25-30
	Universal pan or loaf tin	2		2.	-*	10-20
Yeast dough, heavy and rich	Bowl	2		1.	-*	60-75
	Universal pan or loaf tin	2		2.	-*	45-60

* Heat up up to 50 °C with

Use the following shelf positions for drying:

- 1 wire rack: Position 3
- 2 wire racks: Positions 3 + 1

Turn very juicy fruit and vegetables several times. After drying, remove the dried food from the paper immediately.

In the table, you will find settings for drying various foodstuffs. The temperature and drying time are dependent on the type, moisture, ripeness and thickness of the food. The longer you leave the food to be dried, the better it will be preserved. The more thinly you slice the food, the more quickly it will dry and the more flavour it will retain. For this reason, the table specifies setting ranges.

If you wish to dry food that is not listed in the table, you should use the settings listed in the table for similar food as reference.

Condensation builds up during the proving process, which steams up the door panel. Wipe out the cooking compartment after dough proving. Remove any limescale with a little vinegar and wipe with clean water.

Final fermentation

Place your dough into the oven at the shelf position indicated in the table.

If you want to preheat the oven, the final fermentation stage takes place outside the appliance in a warm place.

The temperature and proving time are dependent on the type and quantity of the ingredients. For this reason, the values indicated in the settings table are intended as a guide only.

Defrosting

For defrosting frozen fruit, vegetables and baked items. Poultry, meat and fish should ideally be defrosted in the refrigerator. Not suitable for cream cakes or cream gateaux.

Use the following shelf positions when defrosting:

- 1 wire rack: Position 2
- 2 wire racks: Positions 3 + 1

Tip: Food that has been frozen flat or in portions defrosts more quickly than food items frozen in a block.

Remove frozen food from its packaging and place it onto the wire rack in suitable cookware.

Redistribute the food or turn it once or twice as it defrosts. Large pieces of food should be turned several times. As the food defrosts, break up any clumps and remove items that have already defrosted from the appliance.

To allow the temperature to equalise, leave the defrosted food to rest for another 10 to 30 minutes in the appliance after switching it off.

Frozen food	Accessories	Position	Heating function	Temperature
For example cream gateaux, buttercream cakes, gateaux with chocolate or sugar icing, fruit, chicken, sausage and meat, bread and bread rolls, cakes and other baked items	Wire rack	2		The temperature selector must remain in the "Off" position

Test dishes

These tables have been produced for test institutes to facilitate appliance testing.

As per EN 60350-1.

Baking

Items that are placed in the oven on baking trays or in baking tins/dishes at the same time will not necessarily be ready at the same time.

Shelf positions for baking on two levels:

- Universal pan, position 3
Baking tray, position 1
- Baking tins/dishes on the wire rack
First wire rack, position 3
Second wire rack, position 1

Shelf positions for baking on three levels:

- Baking tray, position 5
- Universal pan, position 3
- Baking tray: Position 1

Baking with two springform tins:

- On one level (figure **1**)
- On two levels (figure **2**)

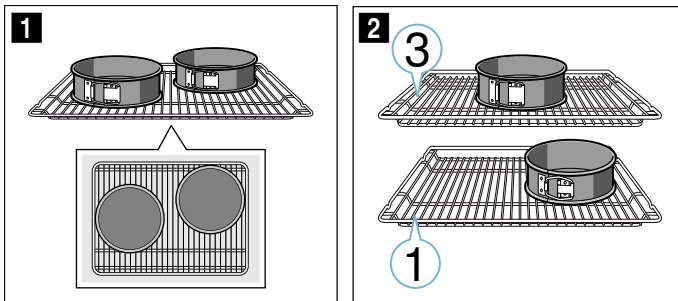

Notes

- The setting values apply to dishes placed into a cold cooking compartment.
- Please note the information in the tables about preheating. The setting values are valid without rapid heating-up.
- For baking, use the lower of the indicated temperatures first.

Tested for you in our cooking studio

Grilling

Also slide in the universal pan. The liquid will be caught and the cooking compartment stays cleaner.

Baking

Dish	Accessories/cookware	Shelf position	Heating function	Temperature in °C	Cooking time in mins
Viennese whirls	Universal pan	3		140-150*	25-35
Viennese whirls, 2 levels	Universal pan + baking tray	3+1		140-150*	30-45
Viennese whirls, 3 levels	Baking trays + universal pan	5+3+1		130-140*	35-50
Small cakes	Universal pan	3		160-170*	20-35
Small cakes, 2 levels	Universal pan + baking tray	3+1		140-160*	30-40
Small cakes, 3 levels	Baking trays + universal pan	5+3+1		130-150*	35-55
Hot water sponge cake	26 cm springform cake tin	2		160-170*	30-40
Hot water sponge cake, 2 levels	26 cm springform cake tin	3+1		150-160*	35-50
Double-crustd apple pie	2 x 20 cm black cake tins	2		170-190	80-100
Double-crustd apple pie, 2 levels	2 x 20 cm black cake tins	3+1		170-190	70-90

* Preheat; do not use rapid heat-up function

Grilling

Dish	Accessories	Shelf position	Heating function	Temperature in °C	Cooking time in mins
Toasting bread Preheat for 10 min	Wire rack	5		3	0,2-1,5

* Turn after 2/3 of the total time



Thank you for buying a Bosch Home Appliance!

Register your new device on MyBosch now and profit directly from:

- **Expert tips & tricks for your appliance**
- **Warranty extension options**
- **Discounts for accessories & spare-parts**
- **Digital manual and all appliance data at hand**
- **Easy access to Bosch Home Appliances Service**

Free and easy registration – also on mobile phones:

www.bosch-home.com/welcome



Looking for help? You 'll find it here.

Expert advice for your Bosch home appliances, need help with problems or a repair from Bosch experts.

Find out everything about the many ways Bosch can support you:

www.bosch-home.com/service

Contact data of all countries are listed in the attached service directory.

Robert Bosch Hausgeräte GmbH

Carl-Wery-Straße 34

81739 München

Germany

www.bosch-home.com



9001428647

030508(C)