



BOSCH

Register your
new device on
MyBosch now and
get free benefits:
**[bosch-home.com/
welcome](https://www.bosch-home.com/welcome)**



Washing machine

WAT28791HK

en Instruction Manual and Installation Instructions

Your new washing machine

You have chosen a Bosch washing machine.

Please take a few minutes to read and become familiar with the advantages of your washing machine.

To meet the high quality demands required by Bosch, every washing machine that leaves our factory is carefully checked to ensure that it functions correctly and is in perfect condition.

For more information on our products, accessories, replacement parts and services, see our website www.bosch-home.com or contact our after-sales service centres.

If the operating and installation instructions describe different models, any differences will be pointed out at the relevant points in the text.



Read these operating and installation instructions before switching on the washing machine.

Display rules

Warning!

This combination of symbol and signal word indicates a possibly dangerous situation. Not heeding the warning can cause death or injuries.

Caution!

This signal word indicates a possibly dangerous situation. Not heeding the caution can cause property and/or environmental damage.

Note/tip

Information about the optimum use of the appliance/any other useful information.

1. 2. 3. / a) b) c)

The steps are represented by numbers or letters.

■ / -

Lists are represented by a small box or a dash.

Contents

	Intended use	4
--	-------------------------------	---

	Safety instructions	5
--	--------------------------------------	---

Children/people/pets	5
Installation	6
Operation	8
Cleaning/Maintenance	10

	Environmental protection	11
--	---	----

Packaging/used appliance	11
Tips on economical use	11

	Positioning and connecting	12
--	---	----

Included with the appliance	12
Safety instructions	13
Installation surface	13
Installation on a base or a wooden joist floor	13
Installation on a platform with drawer	13
Installing the appliance in a kitchenette	14
Removing the transport locks	14
Hose and cable lengths	14
Water inlet	15
Water outlet	16
Levelling	16
Electrical connection	17
Before using the appliance for the first time	17
Transportation	18

	Familiarising yourself with your appliance	19
--	---	----

Washing machine	19
Controls	20

	Laundry	22
--	--------------------------	----

Prepare the laundry	22
Sorting laundry	22

	Detergent	23
--	----------------------------	----

Correct selection of detergent	23
Saving energy and detergent	23

	Overview of programmes	24
---	---	----

Programmes on the programme selector	24
ActiveOxygen Refresh 	27
Starching	28
Dyeing/bleaching	28
Soaking	28

	Programme default settings	29
---	---	----









Temperature	29
Spin speed	29
Ready in time	29
Memory programme	29

	Additional programme settings 30
---	---

ActiveOxygen	30
SpeedPerfect	30
EcoPerfect	30
Easy-Iron	30
Water&Rinse+	30
Prewash	30
Rinse hold	30

	Operating the appliance	31
---	--	----

Preparing the washing machine	31
Switching on the appliance/selecting a programme	31
Change the programme default settings	31
Select additional programme settings	31
Placing laundry into the drum	32
Measure and add detergent and care products	32
Start the programme	33
Childlock/operation lock	33
Adding laundry	34
Changing the programme	34
Cancel the programme	34
Programme end during rinse hold	34
Programme end	34
Removing laundry/switching off the appliance	35

	Appliance settings	36
	Activating the setting mode	36
	Changing the signal volume	36
	Changing the brightness of the touch display	36
	Select/deselect the memory function for drum care	36
	Exiting setting mode	36
	Sensors	37
	Automatic load sensing	37
	Unbalanced load detection system	37
	VoltCheck	37
	Cleaning and maintenance	37
	Machine housing/control panel	38
	Drum	38
	Descaling	38
	The drain pump is blocked, emergency draining	38
	The drain hose at the siphon is blocked	39
	Filter in the water supply blocked	39
	Faults and what to do about them.	40
	Emergency release	40
	Information on the display panel	40
	Faults and what to do about them.	42
	After-sales service	44
	Consumption rates	45
	Energy and water consumption, programme duration and residual moisture for the main washing programmes	45
	Efficiency test programmes for cotton fabrics	45
	Technical data	46
	Aqua-Stop warranty	46

Intended use

- This appliance is intended for private domestic use only.
- Do not install or operate this appliance anywhere that is liable to experience frost and/or outdoor conditions. There is a risk that the appliance will be damaged if residual water in it freezes. If hoses freeze up, they may crack/burst.
- This appliance must only be used for washing domestic laundry, consisting of machine-washable items and hand-washable woollens (see label on item). Using the appliance for any other purpose is outside of the scope of its intended application and is forbidden.
- This appliance is suitable for operation with mains water and commercially available detergents and care products (must be suitable for use in washing machines).
- This appliance is intended for use up to a maximum height of 4000 metres above sea level.

Before you switch on the appliance:

Check that there is no visible damage to the appliance. Do not operate the appliance if it is damaged. Should you have any problems, please contact your specialist dealer or our customer service.

Read and follow the operating and installation instructions and all other information provided with this appliance.

Retain the documents for subsequent use or for subsequent owners.

Safety instructions

The following safety information and warnings are provided to protect you from injury and to prevent material damage to your surroundings.

It is nevertheless important to take the necessary precautions and to proceed with care when installing, maintaining, cleaning and operating the appliance.

Children/people/pets

Warning **Risk of death!**

Children and other people who are unable to assess the risks involved when using the appliance may injure themselves or may find themselves in life-threatening situations. Therefore please note:

- The appliance may be used by children over the age of 8 years and by persons with reduced physical, sensory or mental capacity or by persons with a lack of experience or knowledge as long as they are supervised or have received instruction on how to use the appliance safely and they have understood the potential risks of using the appliance.
- Children must not play with this appliance.

- Do not allow children to clean or maintain this appliance unsupervised.
- Keep children under 3 years and pets away from this appliance.
- Do not leave the appliance unattended when children or other people who are unable to assess the risks are in the vicinity.

Warning **Risk of death!**

Children may lock themselves inside appliances and find themselves in a life-threatening situation.

- Do not position the appliance behind a door, as this may obstruct the appliance door or prevent it from opening completely.
- Once an appliance has reached the end of its life, pull the mains plug from the socket **before** severing the mains cable, and then destroy the lock on the appliance door.

Warning **Risk of suffocation!**

If allowed to play with the packaging/plastic film or packing components, children may become caught in these or pull them over their heads and suffocate.

Keep packaging, plastic film and packing components away from children.

⚠ Warning
Risk of poisoning!

Detergents and care products may result in poisoning if consumed.

If accidentally swallowed, seek medical advice. Keep detergents and care products out of the reach of children.

⚠ Warning
Risk of burns!

When washing at high temperatures, the glass in the appliance door becomes hot. Stop children from touching the appliance door when it is hot.

⚠ Warning
Eye/skin irritation!

Contact with detergents or care products may cause eye/skin irritation.

Rinse eyes/skin thoroughly if they/it come(s) into contact with detergents or care products. Keep detergents and care products out of the reach of children.

Installation

⚠ Warning
**Risk of electric shock/fire/
material damage/damage to
the appliance!**

If the appliance is not installed properly, this may lead to a

dangerous situation. Ensure the following:

- The mains voltage on your power socket must match the rated voltage specified on the appliance (identification plate). The connected loads and the required fuse protection are specified on the identification plate.
- The mains plug and the protective contact socket must match and the earthing system must be correctly installed.
- The installation must have an adequate cross section.
- The mains plug must be freely accessible at all times. If this is not possible, in order to comply with the relevant safety regulations, a switch (all pole disconnection) must be built into the permanent installation in accordance with electrical installation regulations.
- If using a residual current circuit breaker, only use one that bears the following mark: . The presence of this mark is the only way to be sure that it fulfils all the applicable regulations.

⚠ Warning**Risk of electric shock/fire/
material damage/damage to
the appliance!**

If the appliance's mains cable is altered or damaged, this may result in electric shock, short circuiting or fire due to overheating.

The mains cable must not be kinked, crushed or altered, and must not come into contact with any heat sources.

⚠ Warning**Risk of fire/material damage/
damage to the appliance!**

The use of extension cords or power strips may result in fire due to overheating or short circuiting.

Connect the appliance directly to an earthed socket that has been correctly installed. Do not use extension cords, power strips or multi-way couplers.

⚠ Warning**Risk of injury/material
damage/damage to the
appliance!**

- The appliance may vibrate or move when in operation, potentially resulting in injury or material damage.
Place the appliance on a clean, even, solid surface and, using a spirit level to guide you, level it with the screw-in feet.

- If you take hold of any of the appliance's protruding parts (e.g. the appliance door) in order to lift or move it, these parts may break off and cause injury.
Do not take hold of any of the appliance's protruding parts in order to move the appliance.

⚠ Warning**Risk of injury!**

- The appliance is very heavy. Lifting it may result in injury. Do not lift the appliance on your own.
- The appliance has sharp edges on which you could cut your hands.
Do not take hold of the appliance by its sharp edges. Wear protective gloves to lift it.
- If the hoses and mains cables are not correctly routed, they may constitute a tripping hazard, which may result in injury.
Route hoses and cables such that they do not constitute a tripping hazard.

Caution!

Material damage/damage to the appliance

- If the water pressure is too high or too low, the appliance may not be able to operate properly, and it may also result in material damage or damage to the appliance.
Make sure that the water pressure in the water supply facility is at least 100 kPa (1 bar), and does not exceed 1000 kPa (10 bar).
- If the water hoses are altered or damaged, this may result in material damage or damage to the appliance. The water hoses must not be kinked, crushed, altered or severed.
- The use of hoses supplied by other brands to connect to the water supply may result in material damage or damage to the appliance. Use the hoses supplied with the appliance or genuine spare part hoses only.

- The appliance is secured for transportation by transport locking devices. If the transport locking devices are not removed before the appliance is operated, this may result in damage to the appliance.
It is important to completely remove all transport locking devices before using the appliance for the first time. Make sure that you retain these transport locking devices separately. It is important to refit the transport locking devices if the appliance is to be transported, in order to prevent the appliance from being damaged in transit.

Operation

Warning **Risk of explosions/fire!**

Laundry that has been pretreated with cleaning agents that contain solvents, e.g. stain remover/cleaning solvent, may cause an explosion in the drum. Rinse the laundry thoroughly with water before washing it in the machine.

Warning **Risk of poisoning!**

Poisonous fumes may be given off by cleaning agents that contain solvents, e.g. cleaning solvent.

Do not use cleaning agents that contain solvents.

⚠ Warning
Risk of injury!

- If you support your weight/sit on the appliance door when it is open, the appliance may tip over, which may result in injury.
Do not support your weight on the appliance door when it is open.
- If you climb onto the appliance, the worktop may break, which may result in injury.
Do not climb onto the appliance.
- If you reach into the drum while it is still rotating, you risk injuring your hands.
Wait until the drum has stopped rotating.

⚠ Warning
Risk of scalding!

When washing at high temperatures, there is a risk of scalding if you come into contact with hot detergent solution (e.g. when draining hot detergent solution into a washbasin).
Do not reach into the hot detergent solution.

⚠ Warning
Irritation of the respiratory tract/eyes!

This appliance runs programmes that use active

oxygen. Active oxygen can irritate the mucosa and cause eyes to water.
Do not open the door using the emergency release if a programme is running with active oxygen. Wait until the door has been released.

⚠ Warning
Eye/skin irritation!

Detergent and care products may spray out if the detergent drawer is opened while the appliance is in operation.
Rinse eyes/skin thoroughly if they/it come(s) into contact with detergents or care products. If accidentally swallowed, seek medical advice.

Caution!
Material damage/damage to the appliance

- If the amount of laundry in the appliance exceeds its maximum load capacity, it may not be able to operate properly, or this may result in material damage or damage to the appliance.
Do not exceed the maximum load capacity of dry laundry. Make sure you comply with the maximum load capacities specified for each of the programs. → Page 24

- If you pour the wrong quantity of detergent or cleaning agent into the appliance, this may result in material damage or damage to the appliance. Use detergents/care products/cleaning agents and softeners in accordance with the manufacturers' instructions.

Cleaning/Maintenance

Warning **Risk of death!**

The appliance is powered by electricity. There is a risk of electric shock if you come into contact with live components. Therefore please note:

- Switch off the appliance. Disconnect the appliance from the power supply (pull out the plug).
- Never take hold of the mains plug with wet hands.
- When removing the mains plug from the socket, always take hold of the plug itself and never the mains cable, otherwise this may damage the mains cable.
- Do not make any technical modifications to the appliance or its features.

- Repairs and any other work on the appliance must only be conducted by our customer service or by an electrician. The same applies for replacing the mains cable (when necessary).
- Spare mains cables can be ordered from our customer service.

Warning **Risk of poisoning!**

Poisonous fumes may be given off by cleaning agents that contain solvents, e.g. cleaning solvent.

Do not use cleaning agents that contain solvents.

Warning **Risk of electric shock/material damage/damage to the appliance!**

If moisture penetrates the appliance, this may cause it to short circuit.

Do not use a pressure washer, steam cleaner, hose or spray gun to clean your appliance.

Warning **Risk of injury/material damage/damage to the appliance!**

The use of spare parts and accessories supplied by other brands is dangerous and may result in injury, material damage or damage to the appliance.

For safety reasons, use genuine spare parts and accessories only.

Caution!

Material damage/damage to the appliance

Cleaning agents and agents for pretreating laundry (e.g. stain removers, prewash sprays, etc.) may cause damage if they come into contact with the surfaces of the appliance. Therefore please note:

- Do not allow these agents to come into contact with the surfaces of the appliance.
- Clean the appliance with nothing but water and a soft, damp cloth.
- Remove any detergent, spray or other residues immediately.



Environmental protection

Packaging/used appliance



Dispose of packaging in an environmentally-responsible manner.

This appliance is labelled in accordance with European Directive 2012/19/EU concerning used electrical and electronic appliances (waste electrical and electronic equipment - WEEE).

The guideline determines the framework for the return and recycling of used appliances as applicable throughout the EU.

Tips on economical use

- Always utilise the maximum amount of washing for the particular programme.
Overview of programmes → Supplementary sheet for the operating and installation instructions.
- Wash normally soiled laundry without prewash.
- For light and normal soiling in laundry, you can save energy and detergent. → *Page 23*
- The selectable temperatures apply to the care labels on the textiles. The temperatures in the machine may deviate from this so that you get the optimum mix of energy-saving and washing results.

■ **Information on energy and water consumption:**

The displays provide information about the relative level of energy and water consumption in the selected programmes.

The more display segments are visible, the higher the respective consumption.

This enables you to compare the consumption levels of the different programmes when choosing your programme settings and decide on an energy- and water-saving programme setting.

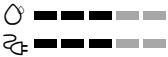

- Energy consumption
- Water consumption

■ **Energy-saving mode:** The touch display lighting goes out after a few minutes, the button flashes. Touch the touch display to activate the lighting. Energy-saving mode is not activated if a programme is running.

■ **Automatic switch off** (only before the programme starts or after the programme ends) If the appliance is not operated for a prolonged period, it automatically switches off to save energy. Press the main switch again to switch on the appliance.

■ If the washing will be dried in a dryer, select the spin speed according to the dryer manufacturer's instructions.

Positioning and connecting

Included with the appliance

Note: Check the machine for transport damage. Never use a damaged machine. If you have a complaint, please contact the retailer from whom you purchased the appliance, or our after-sales service.

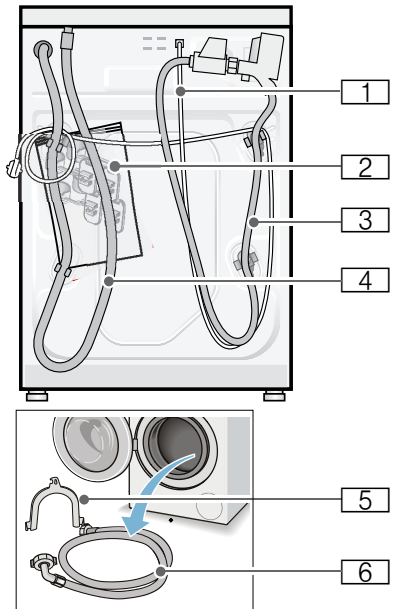

- 1 Mains cable
- 2 Bag:
 - Installation and operating instructions
 - After-sales service location directory*
 - Warranty*
 - Cover caps for openings left after removing the transport locks
 - Wrench*
- 3 Water supply hose on Aqua-Stop models
- 4 Water drain hose
- 5 Elbow for securing the water drain hose*

- 6** Water supply hose on standard/Aqua-Secure models

*depending on the model

In addition, a hose clamp (24 - 40 mm diameter, available from specialist dealers) is required to connect the water drain hose to a siphon.

Useful tools

- Spirit level for levelling
- Wrench with:
 - WAF 13 for loosening the transport locks, and
 - WAF 17 for aligning the appliance feet

Safety instructions

Warning **Risk of injury!**

- The washing machine is very heavy. Be careful when lifting/transporting the washing machine.
- When the washing machine is lifted by its protruding parts (e.g. the washing machine door), the components may break off and cause injuries.
Do not lift the washing machine by protruding parts.
- If the hose and mains cables are not routed properly, there is a risk of tripping and injury.
Lay hoses and cables in such a way that there is no risk of tripping.

Caution!

Damage to the appliance

Frozen hoses may rip/burst. Do not install the washing machine in areas exposed to frost or outdoors.

Caution!

Water damage

The connection points for the water supply hose and water drain hose are under high water pressure. To prevent

leaks and water damage, you must follow the instructions in this section.

Notes

- In addition to the safety information listed here, the local water and electricity supplier may have special requirements.
- If in doubt, have the appliance connected by a specialist.

Installation surface

Note: The washing machine be stable so that it does not move around.

- The installation surface must be firm and level.
- Soft floors/floor coverings are not suitable.

Installation on a base or a wooden joist floor

Caution!

Damage to the appliance

The washing machine may "wander" and tip/topple from the base when spinning.

The feet of the appliance must be secured with holding brackets. Order no. WMZ 2200, WX 9756, Z 7080X0

Note: On wooden joist floors, install the washing machine:

- In a corner, if possible,
- On a water-resistant wooden board (min. 30 mm thick) which is screwed tightly to the floor.

Installation on a platform with drawer

Platform order no.: WMZ 20490, WZ 20490, WZ 20510, WZ 20520

Installing the appliance in a kitchenette

Warning **Danger of death!**

There is a risk of electric shock if you touch live components.
Do not remove the appliance covering plate.

Notes

- Recess width of 60 cm required.
- Only install the washing machine underneath a continuous worktop that is securely connected to adjacent cabinets.

Removing the transport locks

Caution! **Damage to the appliance**

- The machine is secured for transportation using transport locks. If the transport locks are not removed, the drum, for example, may become damaged when the machine is operated. Before using the appliance for the first time, make sure that you completely remove all four transport locks. Keep the locks in a safe place.
- To prevent transport damage from occurring if the appliance is moved at a later date, you must refit the transport locks before transporting the appliance.

Note: Keep the screws and sleeves in a safe place.

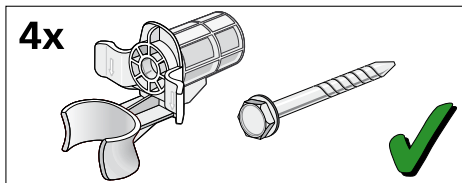

1. Take the hoses out of the holders.

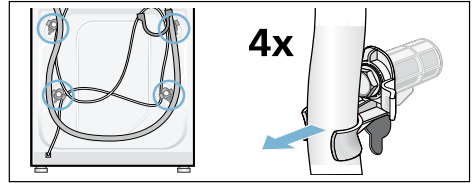

2. Unscrew and remove all four transport brace screws. Remove the sleeves. To do this, remove the mains cable from the holders.

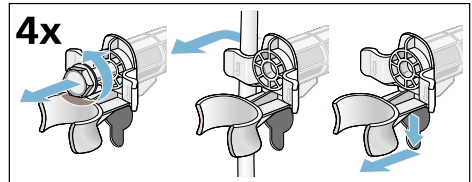

3. Fit the covers. Lock the covers firmly in place by applying pressure to the snap-in hooks.

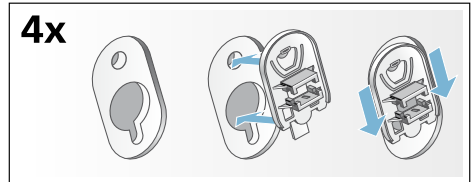

Hose and cable lengths

- Left-hand connection

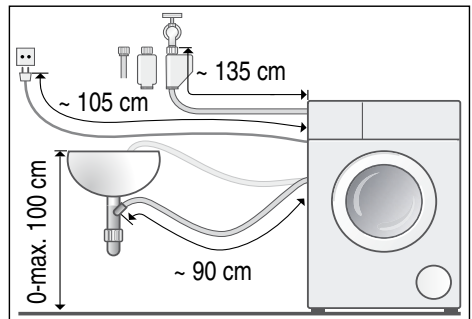

- Right-hand connection

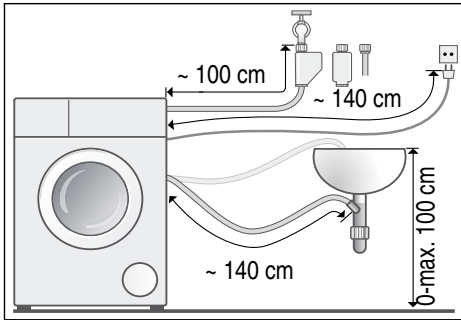

Tip: The following are available from specialist dealers/the after-sales service:

- An extension for Aqua-Stop or cold water supply hose (approx. 2.50 m); order no. WMZ2380, WZ10130, CZ11350, Z7070X0
- A longer supply hose (approx. 2.20 m) for standard model

Water inlet

Warning **Danger of death!**

There is a risk of electric shock if you touch live components. Do not immerse the Aqua-Stop safety valve in water (it contains an electric valve).

Observe the following when connecting the machine:

Notes

- Only operate the washing machine using cold mains water.
- Do not connect the machine to the mixer tap of an unpressurised hot-water boiler.
- Do not use a used supply hose. Only use the supply hose supplied or one that was purchased from an authorised specialist retailer.
- Do not bend, squash, modify or cut through the water supply hose (otherwise its strength is no longer guaranteed).

- Only tighten the screw connections by hand. If the screw connections are tightened too much with a tool (pliers), the thread may be damaged.

Optimum water pressure in the supply network

At least 100 kPa (1 bar)

Maximum 1000 kPa (10 bar)

When the tap is open, the water flow is at least 8 l/min.

If the water pressure is higher than this, a pressure-reducing valve must be installed.

Connection

Connect the water supply hose to the water tap ($\frac{3}{4}$ " = 26.4 mm) and to the appliance (not necessary for Aqua-Stop models as this is permanently installed):

- Model: **Standard**

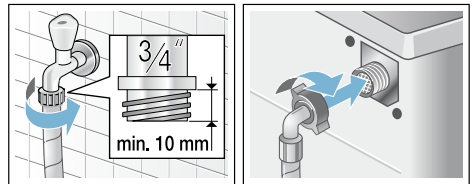

- Model: **Aqua-Secure**

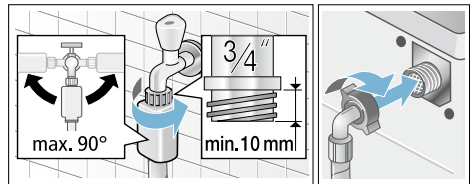

- Model: **Aqua-Stop**

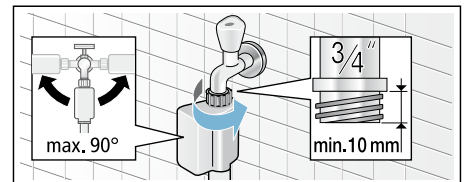

en Positioning and connecting

Note: Open the water tap carefully, checking the leak tightness of the connection points. The screw connection is under mains water pressure.

Water outlet



Warning

Risk of scalding!

When washing at high temperatures, there is a risk of scalding if you come into contact with hot detergent solution (e.g. when draining hot detergent solution into a washbasin). Do not reach into the hot detergent solution.

Caution!

Water damage

When water is being pumped away, the outlet hose is under water pressure and may slip out of the wash basin or connection point.

Secure the outlet hose so that it cannot slip out.

Caution!

Damage to the appliance/fabrics

If the end of the outlet hose is immersed in the drained water, water may be sucked back into the appliance and may damage the appliance/fabrics. Make sure that:

- The plug does not block drainage from the wash basin.
- The end of the drain hose is not immersed in the drained water.
- The water drains away quickly enough.

Note: Do not kink the water drain hose or stretch it lengthways.

Connection

■ Drainage into a siphon

The connection point must be secured using a hose clamp with a

diameter of 24–40 mm (available from specialist dealers).

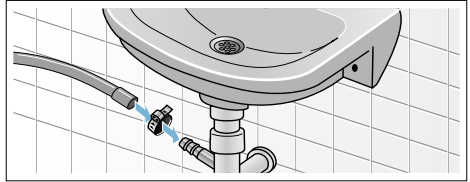

■ Drainage into a wash basin

Secure the outlet hose so that it cannot slip out.

Elbow available from after-sales service:

Individual part number 00655300

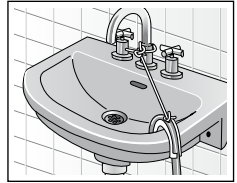
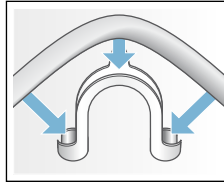

- Drainage into a plastic pipe with rubber sleeve or into a gully

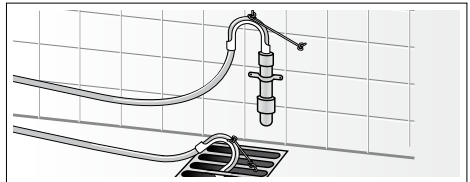

Levelling

Level the appliance using a spirit level.

Incorrect levelling may result in intense noise, vibrations and "wandering".

1. Loosen the lock nuts using a wrench, by turning it in a clockwise direction.
2. Check the alignment of the washing machine with a spirit level, and adjust it if necessary. Change the height by turning the appliance feet. All four appliance feet must stand firmly on the ground.

3. Tighten the lock nut against the housing.
In doing so, hold the foot tight and do not adjust its height.
The lock nuts on all four appliance feet must be screwed tightly against the housing.



Electrical connection

⚠ Warning **Danger of death!**

There is a risk of electric shock if you touch live components.

- Never touch or hold the mains plug with wet hands.
- Only pull out the mains cable by the plug and never by the cable, as this could damage it.
- Never unplug the mains plug during operation.

Observe the following information and ensure that:

Notes

- The mains voltage and voltage indicated on the washing machine (rating plate) are the same. The connected load and fuse required are specified on the rating plate.
- The washing machine is only connected to an alternating current via a properly installed earthed socket.
- The mains plug fits the socket.
- The cable cross-section is adequate.
- The earthing system is properly installed.

- The mains cable is only replaced by a qualified electrician (if this is necessary). Replacement mains cables are available from the after-sales service.
- No multiple plugs/couplings or extension cables are used.
- If an earth-leakage circuit breaker is used, only a type which displays this symbol is used: . Only this symbol guarantees compliance with the currently applicable regulations.
- The mains plug must be freely accessible at all times. If this is not possible, in order to comply with the relevant safety regulations, a switch (2-pole switch-off) must be built into the permanent installation in accordance with electrical installation regulations.
- The mains cable is not bent, squashed, modified, cut through, or in contact with heat sources.

Before using the appliance for the first time

The washing machine was thoroughly tested before leaving the factory. To remove any water that may be left over from the test, run the first wash cycle **without** any laundry.

Notes

- The washing machine **must be correctly installed and connected**. From → *Page 12*
- Never use a machine if it is damaged. Inform the after-sales service.

Preparatory work:

1. Check the machine.
2. Remove the protective film from the control panel.
3. Plug in the mains plug.
4. Turn on the tap.

Running the programme without laundry:

1. Switch on the appliance.
2. Close the door (do not load any laundry).
3. Set the **Drum Clean 90 °C** programme.
4. Open the detergent drawer.
5. Pour approximately 1 litre of water into compartment **II**.
6. Pour standard washing powder into compartment **II**.

Note: To prevent foaming, only use half the amount of detergent recommended by the detergent manufacturer. Do not use detergents intended for woollens or delicates.

7. Close the detergent drawer.
8. Press the  button.
9. Switch off the appliance at the end of the programme.

Your washing machine is now ready to use.

Transportation

e.g. when moving home

Preparatory work:

1. Turn off the water tap.
2. Reduce the water pressure in the supply hose.
Maintenance – filter in the water supply → *Page 39*
3. Drain the remaining detergent solution.
Maintenance – detergent solution pump blocked
4. Disconnect the washing machine from the mains.
5. Remove the hoses.

Installing the transport locks:

1. Remove the covers and keep them in a safe place.
Use a screwdriver if necessary.

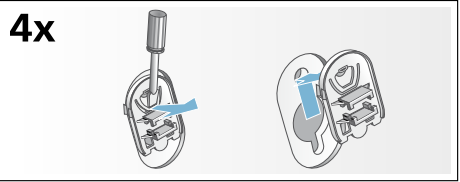

2. Insert all four sleeves.
Clip the mains cable securely in the holders. Insert and tighten the screws.

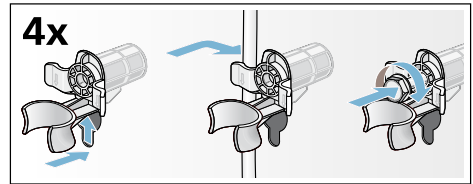

Before switching on the appliance again:

Notes

- The transport braces **must** be removed.
- To prevent unused detergent from flowing straight into the drain during the next wash: Pour approx. 1 litre of water into compartment **II** and start the **Drain** program.

Familiarising yourself with your appliance

Washing machine

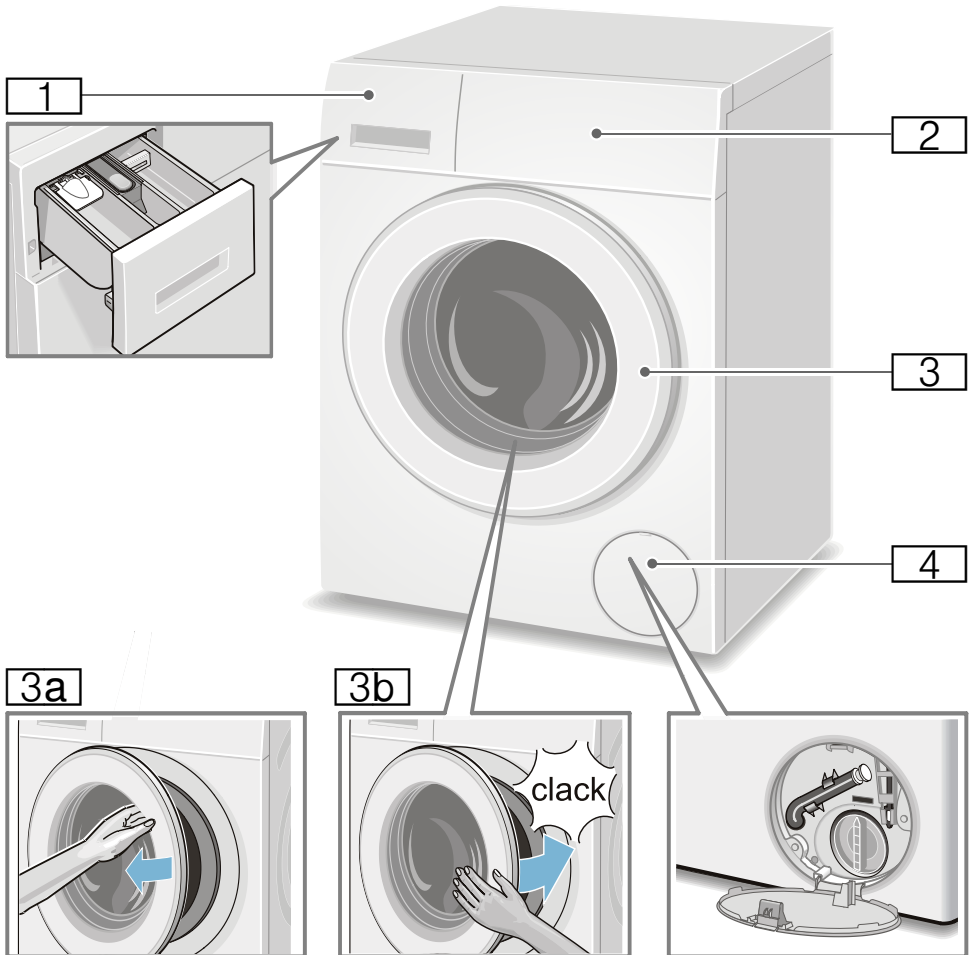

1 Detergent drawer → *Page 32*

4 Service flap

2 Controls

3 Washing machine door with handle

3a Opening the washing machine door

3b Closing the washing machine door

Controls

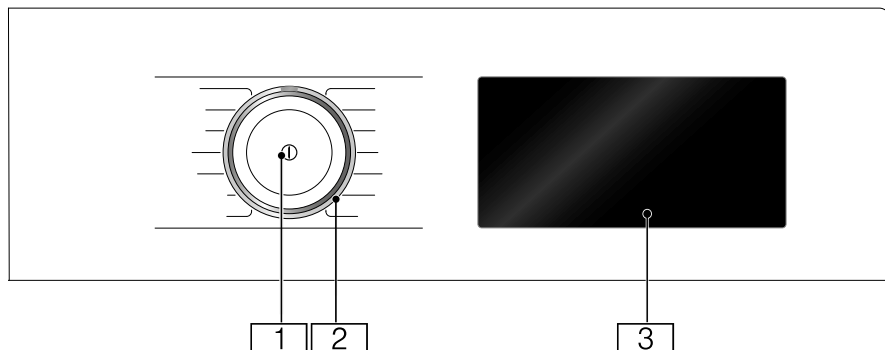

1 Main switch

You can use the ① button to switch the appliance on and off.

2 Programme selector

You can turn the programme selector in both directions (clockwise and anti-clockwise).

3 Touch display

This shows you the programme information and selection options for settings, and you can select the settings by touching the framed or underlined areas.

Content of the touch display

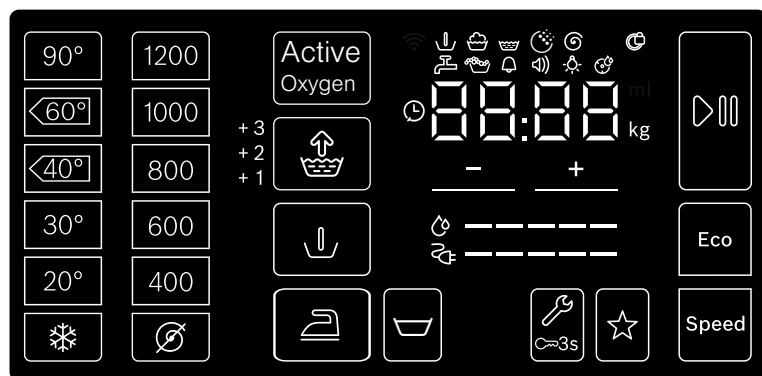

Indicators and buttons on the control panel	Display for settings	Setting
90°, 60°, 40°, 30°, 20°, ❄️		Temperature in °C; ❄️ = cold
1400*, 1200, 800, 600, 400, 🌀		Spin speed; 🌀 = no spin
ActiveOxygen		ActiveOxygen (Active oxygen treatment)
* Maximum spin speed depends on the appliance		

Indicators and buttons on the control panel	Display for settings	Setting
		SpeedPerfect
		EcoPerfect
	+1, +2, +3, off	Water&Rinse+; + additional rinse cycles
		Easy-Iron
		Prewash
		Rinse Stop = no final spin
	3s	Childlock/control panel lock
		Memory programme
		Start/pause
		Appliance settings: Information signal, operating signal, brightness of the touch display, memory function for drum care
		Change the settings Note: Where there are multi-level settings, pressing and holding , will scroll through all the settings automatically until the end. Touching it again will allow you to change the settings again.
* Maximum spin speed depends on the appliance		

Other indicators	Information on
	Energy consumption
	Water consumption
	Programme status: Prewash Wash Rinse Active oxygen phase Spin
	Door locked
	Tap off/water pressure too low
	Foam detected
	Programme duration, e.g. 1:51; Ready in, e.g. 8.5 h; recommended load, e.g. 9.0 kg; programme status, e.g. End



Laundry

Prepare the laundry

Caution!

Damage to the appliance/fabrics

Foreign objects (e.g. coins, paperclips, needles, nails) may damage the laundry or components in the washing machine.

You should therefore note the following tips when preparing your laundry:

- Empty any pockets.

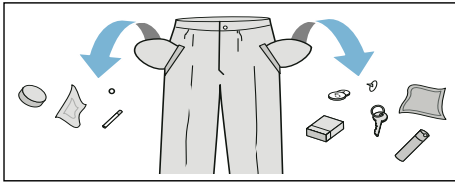

- Look out for metal items (paperclips, etc.) and remove them.
- Wash delicates in a laundry bag (tights, underwired bras, etc.).
- Close any zips; button up any cover buttons.
- Brush sand out of pockets and collars.
- Remove curtain fittings or place curtains in a laundry bag.

Sorting laundry

Sort your laundry according to the care instructions and manufacturer's information on the care labels, depending on:

- Type of fabric/fibre
- Colour

Note: Laundry may discolour. Wash white and coloured items separately. Wash new coloured items separately the first time you wash them.

- Soiling
Wash laundry with the same level of soiling together.

Some examples of soiling levels can be found on → Page 23

- **Light:** Do not prewash, select the **SpeedPerfect** setting if necessary
- **Normal**
- **Heavy:** Load less laundry, select a programme with prewash
- **Stains:** Remove/pretreat stains while they are fresh. Firstly, dab with soapy water; do not rub. Then wash the items of laundry with the appropriate programme. Stubborn or dried-in stains can sometimes only be removed by washing several times.

- Symbols on the care labels

Note: The numbers in the symbols indicate the maximum washing temperature that may be used.

- Suitable for normal washing process; e.g. Cottons programme
- A gentle washing process is required; e.g. Easy-Care programme
- An especially gentle washing process is required; e.g. Delicate/Silk programme
- Suitable for washing by hand; e.g. Woollens programme
- Do not machine wash.

Detergent

Correct selection of detergent

The care label is crucial for selecting the correct detergent, temperature and treatment of the laundry. → See also www.sartex.ch

If you visit www.cleanright.eu, you will find further information on detergents, care products and cleaning agents for domestic use.

- **Standard detergent with optical brighteners**
Suitable for boil-washable white laundry made from linen or cotton
Programme: Cottons/
cold - max. 90 °C
- **Detergent for colours without bleach or optical brighteners**
Suitable for coloured laundry made from linen or cotton
Programme: Cottons/
cold - max. 60 °C
- **Detergent for colours/delicates without optical brighteners**
Suitable for coloured laundry made from easy-care fibres, synthetic fibres
Programme: Easy-Care/
cold - max. 60 °C
- **Detergent for delicates**
Suitable for delicate, fine fabrics, silk or viscose
Programme: Delicate/Silk/
cold - max. 40 °C
- **Detergent for woollens**
Suitable for wool
Wool programme/
cold - max. 40 °C

Saving energy and detergent





























For light and normal soiling, you can save energy (lower washing temperature) and detergent.































Saving	Soiling/note
 <p>Reduced temperature and detergent quantity as per the recommended dosage</p>	<p>Light No visible dirt or stains. Clothing has taken on some body odour, e.g.:</p> <ul style="list-style-type: none"> ■ Light summer/sports clothing (worn for a few hours) ■ T-shirts, shirts, blouses (worn for up to one day) ■ Guest bed linen and hand towels (used for one day)
	<p>Normal Visible dirt or a few light stains, e.g.:</p> <ul style="list-style-type: none"> ■ T-shirts, shirts, blouses (sweat soaked, worn a few times) ■ Towels, bedding (used for up to one week)
	<p>Heavy Dirt and/or stains clearly visible, e.g. tea towels, baby items, work clothing</p>
<p>Temperature as per the care label and detergent quantity as per the recommended dosage for heavy soiling</p>	























Note: When measuring the amount of all detergents/additives/care products and cleaning agents, please always check the manufacturer's instructions and information. → Page 32



















Overview of programmes

Programmes on the programme selector

Programme/type of laundry/information	Settings
<p>Programme name</p> <p>Brief explanation of the programme and the fabrics for which it is suitable.</p>	<p>Max. load</p> <p>Temperature that can be selected  = cold)</p> <p>Spin speed that can be selected**;  = no spin cycle, draining only</p> <p>Additional programme settings that can be selected</p>
<p>Cottons </p> <p>Hard-wearing items and heat-resistant items made of cotton or linen</p> <p>Note: The Speed setting is suitable as a short programme for lightly soiled laundry.</p>	<p>max. 9.0 kg / 5.0* kg</p> <p> - 90 °C</p> <p>400 - 1400** rpm</p> <p>Eco, Speed, , , , , ActiveOxygen****</p>
<p>Cottons Eco </p> <p>Hard-wearing items and heat-resistant items made of cotton or linen;</p> <p>energy-optimised washing that works by reducing the temperature while achieving a comparable washing result to the programme Cottons.</p> <p>Note: The washing temperature is lower than the selected temperature. If you want to achieve a higher water temperature, use the Cottons programme with a higher temperature as required.</p>	<p>max. 9.0 kg</p> <p> - 90 °C</p> <p>400 - 1400** rpm</p> <p>, , , , ActiveOxygen****</p>
<p>Easy Care (Synthetics) </p> <p>Items made of synthetic or blended fabrics</p>	<p>max. 4.0 kg</p> <p> - 60 °C</p> <p> - 1200 rpm</p> <p>Eco, Speed, , , , , ActiveOxygen****</p>
<p>Mix </p> <p>Mixed load of cottons and synthetic fabrics</p>	<p>max. 4.0 kg</p> <p> - 40 °C</p> <p> - 1400** rpm</p> <p>Eco, Speed, , , , , ActiveOxygen</p>
<p>* Reduced load for the Speed setting</p> <p>** Max. spin speed depends on the model</p> <p>*** Programme depends on the model</p> <p>**** Can be selected for washing temperatures of up to 40 °C</p>	

Programme/type of laundry/information	Settings
<p>Delicates / Silk </p> <p>For delicate, washable items, e.g. made of silk, satin, synthetic or blended fabrics (e.g. silk blouses, silk scarves)</p> <p>Note: Use a detergent that is suitable for machine-washing delicate fabrics or silk.</p>	<p>max. 2.0 kg</p> <p> - 40 °C</p> <p> - 800 rpm</p> <p>Eco, Speed, , , , , ActiveOxygen</p>
<p>Wool </p> <p>Hand- or machine-washable items that are made of wool or contain wool;</p> <p>particularly gentle wash programme to prevent laundry from shrinking, with longer pauses in the programme (during which the items rest in the water)</p> <p>Notes</p> <ul style="list-style-type: none"> ■ Wool is of animal origin, e.g. angora, alpaca, llama, sheep. ■ Use a detergent that is suitable for machine-washing wool. 	<p>max. 2.0 kg</p> <p> - 40 °C</p> <p> - 800 rpm</p> <p></p>
<p>Rinse / Spin / Drain  /  / </p> <p>Combined extra programme for rinsing and spinning the laundry, and draining the rinsing water</p> <p>Note: The  setting is activated at the factory for this programme.</p> <p>If you only want to spin the laundry: Deactivate the  setting and, if required, adjust the spin speed.</p> <p>If you only want to drain water: Deactivate the  setting and select the  setting.</p>	<p>-</p> <p>-</p> <p> - 1400** rpm</p> <p>, , </p>
<p>Super Quick (Rapid) 15'/30'  /  ()</p> <p>Extra-short programme of approx. 15/30 minutes, suitable for small items of lightly soiled laundry</p> <p>Note: The Super Quick (Rapid) 15' programme is run for the Speed setting.</p>	<p>max. 2.0 kg / 3.5 kg</p> <p> - 40 °C</p> <p> - 1200 rpm</p> <p>Speed,</p>
<p>*** Nightwash</p> <p>Especially quiet programme for washing during the night; suitable for items made from cotton, linen, and synthetic and blended fabrics</p> <p>Notes</p> <ul style="list-style-type: none"> ■ End signal deactivated, ■ Reduced final spin speed set by default and shorter washing time 	<p>Max. 4.0 kg</p> <p> - 40 °C</p> <p>max. 1200 rpm</p> <p>Eco, Speed, , , ActiveOxygen</p>
<p>* Reduced load for the Speed setting</p> <p>** Max. spin speed depends on the model</p> <p>*** Programme depends on the model</p> <p>**** Can be selected for washing temperatures of up to 40 °C</p>	

Programme/type of laundry/information	Settings
<p>Drum Clean </p> <p>The cleaning programme, combined with an active oxygen phase followed by a washing programme, thoroughly cleans and cares for the drum and outer tub, and eliminates odours.</p> <p>Run the programme, e.g.:</p> <ul style="list-style-type: none"> ■ before using the appliance for the first time, ■ if you regularly wash at low temperatures (40 °C or lower) or ■ if there are odours due to a long absence. <p>Notes</p> <ul style="list-style-type: none"> ■ The Drum Clean indicator lamp flashes when you use have not used a programme at 60 °C or higher for a long time. ■ Run the programme without laundry. ■ Use washing powder or a detergent containing bleach. To prevent foaming, only use half the amount of detergent recommended by the detergent manufacturer. Do not use detergent designed for woollens or delicates. 	<p>0 kg</p> <p>90 °C</p> <p>1200 rpm</p> <p>ActiveOxygen</p>
<p>Allergy Plus (Hygiene) </p> <p>Hard-wearing items made of cotton or linen</p> <p>Note: Particularly suitable for strict hygiene requirements or particularly sensitive skin thanks to the extended wash cycle at a defined temperature, higher water level and extended rinse cycle.</p>	<p>max. 6.5 kg</p> <p> - 60 °C</p> <p> - 1400** rpm</p> <p>Eco, Speed, , , , , ActiveOxygen****</p>
<p>*** Jeans / Dark wash </p> <p>Dark-coloured items made from cotton or easy-care fabric; turn items inside-out before washing.</p>	<p>max. 3.5 kg</p> <p> - 40 °C</p> <p> - 1200 rpm</p> <p>Eco, Speed, , , , , ActiveOxygen****</p>
<p>*** Sportswear </p> <p>Sportswear and leisurewear made from microfibre fabrics</p> <p>Notes</p> <ul style="list-style-type: none"> ■ Laundry must not be treated with fabric softener. ■ Before washing, clean the detergent drawer thoroughly (all compartments) to remove fabric-softener residue. 	<p>max. 2.0 kg</p> <p> - 40 °C</p> <p> - 800 rpm</p> <p>Eco, Speed, , , , , ActiveOxygen</p>
<p>* Reduced load for the Speed setting</p> <p>** Max. spin speed depends on the model</p> <p>*** Programme depends on the model</p> <p>**** Can be selected for washing temperatures of up to 40 °C</p>	

Programme/type of laundry/information	Settings
<p>*** Duvet </p> <p>Machine-washable items stuffed with synthetic fibres, such as pillows, quilts and bedspreads; also suitable for items stuffed with down</p> <p>Note: Wash large items separately. Use a detergent designed for delicates and follow the instructions on the item's care label. Use detergent sparingly.</p>	<p>max. 2.5 kg (Down max. 2.0 kg)</p> <p> - 60 °C</p> <p> - 1200 rpm</p> <p>Eco, Speed, , , ActiveOxygen****</p>
<p>*** Lingerie </p> <p>For delicate, washable underwear, e.g. made of velvet, lace, Lycra, silk or satin.</p>	<p>max. 1.0 kg</p> <p> - 40 °C</p> <p> - 600 rpm</p> <p>Eco, Speed, , , ActiveOxygen</p>
<p>Shirt / Business (Shirts) </p> <p>Non-iron shirts/blouses made of cotton, linen, or synthetic or blended fabric</p> <p>Notes</p> <ul style="list-style-type: none"> Shirts/blouses are only given a short spin with the  setting. Hang them up to dry while still dripping wet —> Self-smoothing effect Use the Delicates / Silk  programme to wash shirts/blouses made of silk or delicate fabrics. 	<p>max. 2.0 kg</p> <p> - 60 °C</p> <p> - 800 rpm</p> <p>Eco, Speed, , , , ActiveOxygen****</p>
<p>ActiveOxygen Refresh </p> <p>Mixed load of cottons, synthetic fabrics, silk, satin, wool; programme suitable for removing odours, e.g. the smell of cigarettes and kitchen odours</p> <p>Notes</p> <ul style="list-style-type: none"> Observe max. load. Not a washing programme/not suitable for removing stains and sweat. Load dry laundry only. Before loading the laundry, wipe the drum dry if necessary, turning it as you do so to remove all water. 	<p>max. 1.0 kg</p> <p>-</p> <p>-</p> <p>-</p>
<p>* Reduced load for the Speed setting ** Max. spin speed depends on the model *** Programme depends on the model **** Can be selected for washing temperatures of up to 40 °C</p>	

ActiveOxygen Refresh

ActiveOxygen Refresh  is an innovative programme that is designed

to refresh laundry and remove odours (e.g. the smell of cigarettes and kitchen odours). Sweaty fabrics must be washed.

In this programme, your laundry is treated with active oxygen and water mist; detergent is not added.



Active oxygen is a special type of oxygen which effectively reduces odours.

The programme is suitable for all types of material and fabric, even for those which should only be professionally cleaned.

Once the programme has started, the drum inside the appliance lights up and the mist that is created can be seen.

Once the programme has finished, take the laundry out of the drum and shake it out briefly.

Notes

- Leave the door and detergent drawer open slightly when the appliance is not in use. → *Page 37*
- The active oxygen treatment is less effective if the drum is dirty. Run the **Drum Clean**  programme regularly.
- It is not possible to add laundry once the programme has started.
- If you cancel the programme or switch to a different one, the door will remain locked until there is no longer any active oxygen in the drum. This may take up to 25 minutes. The two symbols  and  will flash during this time. The door will then unlock automatically.

Starching

Note: Laundry should not be treated with fabric softener.



Liquid starch can be used to stiffen fabrics particularly in the Rinse and Cottons programmes. Measure starch into compartment  in accordance with the manufacturer's instructions (clean first if necessary).

Dyeing/bleaching

Dye should only be used in normal household quantities. Salt may damage stainless steel. Always follow the dye manufacturer's instructions.

Do **not** use the washing machine to bleach clothes.

Soaking

1. Switch on the appliance.
2. Select the **Cottons 20 °C** program.
3. Pour soaking agent/detergent into compartment **II** in accordance with the manufacturer's instructions.
4. Press the  button.
5. After approx. 10 minutes, press the  button to pause the program.
6. Leave the laundry to soak for as long as required, then either press the  button again to continue the program or change the program.

Notes

- Load laundry of the same colour.
- No additional detergent is required; the soaking solution is used for washing.

P+ Programme default settings

The programme default settings are displayed and can be changed in the touch display after the programme is selected.

You can find an overview of all possible program settings on the supplementary sheet for the installation and operating instructions.

Temperature

Depending on what stage the programme is in, you can change the set temperature before and during the programme.

The maximum temperature that can be set depends on the programme that has been selected.

Spin speed

Depending on what stage the programme is in, you can change the spin speed (in rpm; revolutions per minute) before and during the programme.

Setting : No spin; the water is only drained. The laundry stays wet inside the drum, e.g. for items that should not be spun.

The maximum speed that can be set depends on the model and the programme that has been selected.

Ready in time

After selecting a programme, the programme duration is displayed, e.g. **1:51** (in h:min (hours:minutes)).



Before the programme starts, you can move the time at which the programme

should be finished backwards, in increments of 30 minutes and up to a maximum of 24 h (h=hour).

After the programme starts, the selected time, e.g. **8.5 h** is displayed and counted down until the washing programme starts. The duration of the programme is then displayed.

Note: The programme duration is automatically adjusted when the programme is running. Changes to the programme default settings or programme settings, foam detection function, unbalanced load detection, the load or soiling may also change the programme duration.

After the programme starts, and while the selected time is counting down, you can change this as follows:

1. Touch the control panel .
2. Touch **+** or **-** to change the time.
3. And touch  again.

After starting the programme, while the programme is running, you can add or remove laundry if necessary.

→ Page 34

Memory programme



You can save a selected programme with your favourite settings here.

To store:

1. Switch on the appliance.
2. Select a programme.
3. Change the settings and/or select additional settings.
4. Press and hold ☆ on the control panel for approx. three seconds.

The programme is saved if all of the settings flash briefly.

To use the saved programme, touch ☆ briefly after you switch on the appliance.

To change the saved programme, press and hold ☆ again for approx. three seconds after selecting the new settings.

P+ Additional programme settings

You can find an overview of all of the additional settings that can be selected depending on the programme on the printed supplement to the installation and operating instructions.

ActiveOxygen

The laundry is additionally treated with active oxygen before the wash cycle and before the final rinse cycle in order to thoroughly remove germs and bacteria.

SpeedPerfect

Speed

Washing in a shorter time while achieving a washing result that is consistent with, but uses more energy than, the selected programme, without the SpeedPerfect setting.

Note: Do not exceed the maximum load.

EcoPerfect

Eco

Energy-optimised washing by reducing the temperature while achieving a washing result that is consistent with the selected programme, without the EcoPerfect setting.

Easy-Iron



Reduces creasing thanks to a special spin sequence followed by fluffing and reduced spin speed.

Note: The washing's residual moisture is increased.

Water&Rinse+



Adjustment values:

+1	+ 1 rinse
+2	+ 2 rinses
+3	+ 3 rinses
off	Setting deselected

Higher water level and additional rinse cycles depending on the programme, longer programme duration for particularly sensitive skin and/or for areas with very soft water.

The number of rinse cycles that the appliance actually runs depends on the number that is set as a basic setting for the program in question.

Prewash



For heavily soiled laundry.

Note: Pour detergent into compartments **I** and **II**.

Rinse hold



If final spinning is not selected, the laundry will remain in the water after the final rinse.

You can select "Rinse Stop" to prevent creasing if the laundry will not be taken out of the washing machine immediately after the programme has ended.

To continue/end the programme
→ Page 34



Operating the appliance

Preparing the washing machine

Note: The washing machine **must be correctly installed** and **connected**.

From → *Page 12*

1. Connect the mains plug.
2. Turn on the water tap.
3. Open the door.
4. Check that the drum is completely drained. Drain if necessary.

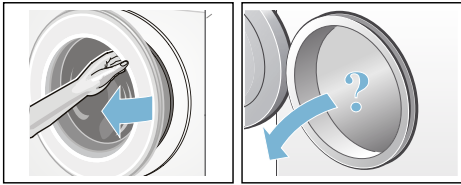

Switching on the appliance/ selecting a programme

Press the **Ⓛ** button. The appliance is switched on.

The **Cottons** programme set at the factory is then always displayed.

The current settings and programme information light up at full brightness and the display **▷00** flashes.

The settings that can be selected light up at half brightness.

Notes

- Temporary flashing of the display **Ⓛ** informs you to run the programme **Drum Clean** or any other programme soon at a washing temperature of at least 60 °C.
- If the **∞ 3s** display flashes, the childproof lock is active. You must deactivate this first before you can change settings or start the programme. → *Page 33*

In appliances with a **drum light**:

The drum is lit after switching on the appliance, after opening and closing the door and after starting a programme. The light switches off automatically.

You can:

- Use this programme and load laundry. → *Page 32*
- Or select another programme. You can find an overview of all programmes on the printed supplement for the installation and operating instructions.
- Or change the programme default settings. → *Page 31*
- And/or select additional programme settings. → *Page 31*

Change the programme default settings

To change the current settings, touch the button you require on the control panel and the relevant indicator will switch to full brightness.

You can change Finished in-time by touching **+** or **-**.

Programme default settings
→ *Page 29*

Select additional programme settings

By selecting additional settings, you can better adapt the washing process to your items of laundry.

To do this, touch the required control panel; the relevant display switches to full brightness.

Additional programme settings
→ *Page 30*

Placing laundry into the drum

Warning **Danger of death!**

Items of laundry pretreated with cleaning agents that contain solvents, e.g. stain remover/cleaning solvent, may cause an explosion after being loaded into the washing machine. Hand-rinse items of laundry thoroughly beforehand.

Notes

- Mix items of laundry of varying sizes. Laundry items of different sizes distribute themselves better during the spin cycle. Individual items of laundry may lead to imbalances.
 - Observe the specified maximum load. Overfilling has a negative impact on the washing result and promotes creasing.
1. Place presorted items of laundry unfolded in the washing drum.
 2. Make sure that no items of laundry are trapped between the washing machine door and the rubber seal, and close the door.

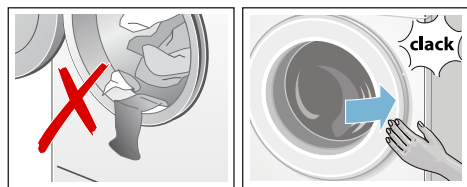

Measure and add detergent and care products

Caution!

Damage to the appliance

Cleaning agents and agents for pretreating laundry (e.g. stain removers, prewash sprays, etc.) may cause damage if they come into contact with the surfaces of the washing machine. Do not allow these agents to come into contact with the surfaces of the washing

machine. If necessary, immediately wipe away spray residue and other residues/droplets with a damp cloth.

Dosing

Dose the detergents and care products according to:

- Water hardness (ask your water supply company)
- The manufacturer's instructions on the packaging
- The amount of laundry
- Soiling → Page 23

Filling

Warning **Eye/skin irritation!**

Detergent and care products may spray out if the detergent drawer is opened while the machine is in operation. Open the drawer carefully. Rinse eyes/skin thoroughly if they come into contact with detergents or care products. If swallowed accidentally, seek medical advice.

Note: Dilute viscous fabric softener and fabric conditioner with water to prevent blockages.

Pour the detergent and care products into the appropriate compartments:

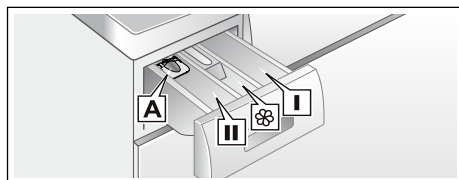

Measuring aid **A** for liquid detergent

Dispenser **II** Detergent for the main wash, water softener, bleach, stain remover

Dispenser 	Softener, starch, do not exceed max.
Dispenser I	Detergent for prewash

1. Pull out the detergent drawer as far as possible.
2. Add detergent and/or care products.
3. Close the detergent drawer.

Measuring aid* for liquid detergent

Position the measuring aid for dosing the correct amount of liquid detergent:

1. Pull out the detergent drawer. Press down the insert and fully remove the drawer.
2. Slide the measuring aid forwards, fold it down and click it into place.
3. Reinsert the drawer.

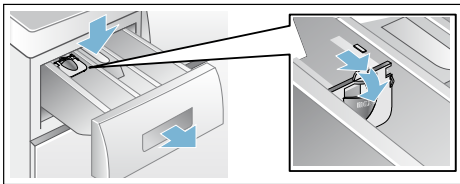

Note: Do not use the measuring aid for gel detergents and washing powder, or for programs with prewash or when the Ready in time is selected.

Start the programme

Touch the control panel .

The programme starts and the  display lights up permanently.

The door is locked and the corresponding display  lights up.

During the programme, the current programme information is displayed:

- Finished in-time or, after the washing programme has started, the programme duration
- And the displays for the programme's progress light up.
→ Page 20

Information on the following programme steps and settings, which can be changed during the programme sequence, light up at half brightness.

Note: Foam detection

If the  display also lights up, the washing machine has detected too much foam during the washing programme and automatically activated additional rinse cycles to remove the foam.

Add less detergent to the next washing cycle with the same load.

If you want to lock the programme to prevent it from being inadvertently adjusted, you can select the childproof lock as follows.

Childlock/operation lock

 3s

You can lock the washing machine to prevent the functions you have set from being changed inadvertently in the control panel.

To **activate**/deactivate the **childproof lock**, touch and hold the control panel  3s for approx. three seconds. The display switches to full brightness.

If you turn the programme selector or touch the control panel while the childproof lock is active, the  3s indicator flashes briefly and a signal sounds. The programme runs through to the end unchanged.

Notes

- The childproof lock can be activated regardless of the appliance's status.
- The childproof lock remains active, even once the washing machine has been switched off.
- If the appliance is switched off while the programme is running and the childproof lock has been activated, the programme will resume when the appliance is switched back on.

Adding laundry

After starting the programme, you can add or remove laundry if necessary.

To do this, touch the control panel .

The indicator flashes. The machine is paused and checks whether it is possible to add laundry.

If the display  goes out, it is possible to add laundry. The door is then unlocked and can be opened.



To continue the programme, touch  again. The programme continues automatically.

Notes



- Do not leave the door open for too long when adding laundry as water from the laundry may leak out.
- For safety reasons, the door remains locked when the water level or temperature is high, or while the drum is turning, and it is not possible to add laundry during this time. Follow the information on the display panel.
- It is not possible to add laundry during the ActiveOxygen Refresh  programme or when the ActiveOxygen setting has been selected.
- The load display is not active during reloading.

Changing the programme

If you have started the wrong programme by mistake, you can change the programme as follows:



1. Touch the control panel .
2. Select another programme.
3. And touch  again. The new program starts from the beginning.

Note: When cancelling programmes that use active oxygen, the door will remain locked for up to 25 minutes until there is no longer any active oxygen in the drum.



Switch the appliance on again if necessary. The  and  symbols will flash. If the symbols are off, the door can be opened.

Cancel the programme



For programs at high temperature:

1. Touch the control panel .
2. To cool the laundry: Select **Rinse**.
3. And touch  again.

For programmes at low temperatures:

1. Touch .
2. Select **Spin** or **Drain**.
3. And touch  again.





Note: When cancelling programmes that use active oxygen, the door will remain locked for up to 25 minutes until there is no longer any active oxygen in the drum.

Switch the appliance on again if necessary. The  and  symbols will flash. If the symbols are off, the door can be opened.

Programme end during rinse hold

The  indicator flashes in the display panel, and the preset spin speed and remaining programme length are displayed for the selected programme.

Continue the programme by:

- Touching  on the control panel or
- Changing the spin speed and then touching  or
- Selecting the Easy-Iron  setting and then touching  or
- Turning the programme selector to **Drain** and then touching .

Programme end

End lights up in the display panel and the  and  displays are off.

Note: If the  display flashes, this informs you to run the **Drum Clean** programme or any other programme at a washing temperature of at least 60 °C.

Removing laundry/switching off the appliance

1. Open the loading door and remove the laundry.
2. Switch off the appliance.
3. Turn off the tap.

Note: Not required for AquaStop models.

Notes

- Do not leave any items of laundry in the drum. They may shrink in the next wash or discolour another item.
- Remove any foreign objects from the drum and the rubber seal – risk of rusting.
- Wipe the rubber gasket dry.

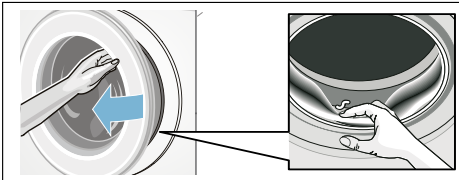

- Leave the washing machine door and detergent drawer open so that any residual water can dry away.
- Always wait for the end of the programme, otherwise the appliance may still be locked. Then switch on the appliance and wait for it to unlock.



Appliance settings

You can change the following settings in the control and display panel:

- The volume of the information signal (e.g. at the end of the programme),
- The volume of the operating signals,
- The brightness of the operating and display field,
- Select/deselect the memory function for drum care. → *Page 24*

You will need to activate the setting mode in order to change these settings.

Activating the setting mode

1. Switch on the appliance. The settings for the current programme are displayed.
2. Touch the control panel . The setting mode is activated and the displays for the information signals  and the preset volume light up.

You can now change the settings:



Changing the signal volume

To do this, touch $+$ or $-$ on the control panel until the required adjustment value for the volume of the **information signals** appears:

Adjustment values:

- 0 off
- 1 quiet
- 2 Medium
- 3 loud
- 4 very loud



Exit setting mode or:

Touch  again. The display for the **operating signals**  and the preset volume light up.

Touch $+$ or $-$ to change the adjustment value (as above).

Exit setting mode or:

Changing the brightness of the touch display

Touch  again. The display for the touch display's brightness  and the preset brightness light up.



Change the adjustment value by touching $+$ or $-$:

Adjustment values:

- 1 Not very bright
- 2 Normal level of brightness
- 3 Bright
- 4 Very bright

Exit setting mode or:

Select/deselect the memory function for drum care

Touch  again. The display for the memory function for cleaning the drum  lights up.

Touch $+$ or $-$ to select (on) or deselect (off) the memory function.

Exiting setting mode

To exit and save the settings:

- Wait for approx. 15 minutes or
- Touch  one last time or
- Switch off the appliance. The selected settings will take effect the next time the washing machine is switched on.

Sensors

Automatic load sensing

The automatic load sensing function adapts the water consumption ideally to each programme depending on the type of fabric and the load.

Unbalanced load detection system

The automatic unbalanced load detection system detects imbalances and ensures even distribution of the laundry by repeatedly starting and stopping drum spinning.

If the laundry is extremely unevenly distributed, the speed is reduced or the spin cycle is not performed for safety reasons.

Note: Place large and small items of laundry evenly in the drum. → *Page 42*

VoltCheck

depending on the model

The colon in the Finished in-time display:

- **Flashes** , if the voltage is currently too low.
- **Pulses** , if insufficient voltage was detected during the programme.



Note: Insufficient voltage may lead to programme extensions and/or a non-satisfactory spin result, for example.

Cleaning and maintenance

Warning **Danger of death!**

There is a risk of electric shock if you touch live components. Switch off the appliance and pull out the mains plug.

Warning **Risk of poisoning!**

Toxic vapours can be produced by cleaning agents that contain solvents, e.g. cleaning solvent. Do not use cleaning agents that contain solvents.

Caution! **Damage to the appliance**

Cleaning agents that contain solvents, e.g. cleaning solvent, can damage surfaces and components in the machine. Do not use cleaning agents that contain solvents.

Prevent detergent residue from building up and odours from forming by following these instructions:

Notes

- Ensure the room in which the washing machine is set up is well ventilated.
- Leave the door and detergent dispenser tray open slightly when the washing machine is not in use.
- Occasionally run a wash using the **Cottons 60 °C** programme and powder detergent.

Machine housing/control panel

- Wipe the housing and the control panel with a soft, damp cloth.
- Remove the detergent residue immediately.
- Do not clean with a water jet.

Drum

Use chlorine-free cleaning agents, do not use steel wool.

If there are odours in the washing machine, or to clean the drum, run the **Drum Clean 90 °C** programme without laundry. Add washing powder.

Descaling

Descaling should not be necessary if the detergent is measured out correctly. However, if it is required, follow the manufacturer's instructions for the descaling agent. Suitable descalers can be obtained via our website or from customer services. → *Page 44*

The drain pump is blocked, emergency draining

Warning **Risk of scalding!**

When you wash at high temperatures, the water gets very hot. If you come into contact with the hot water, you may be scalded.

Allow the detergent solution to cool down.

1. Turn off the water tap so that no more water can flow in and has to be drained via the drain pump.
2. Switch off the appliance. Pull out the mains plug.
3. Open and remove the service flap.

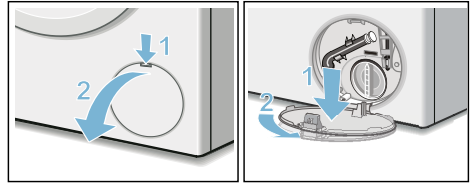

4. Take the auxiliary drain hose out of the holder. Remove the locking cap and drain off the water into a suitable container. Replace the locking cap and place the drain hose back in the holder.

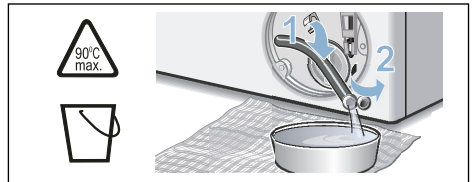

5. Carefully unscrew the pump cover; remaining water may leak out. Clean the interior, pump cover thread and pump housing. The impeller in the drain pump must be able to rotate. Refit and screw on the pump cover. The handle must be in a vertical position.

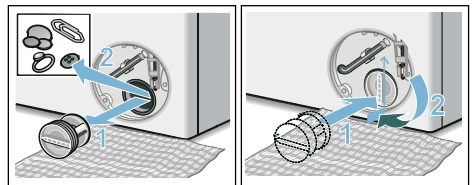

6. Put the service flap back on, engage and close it.

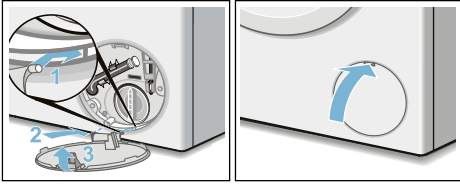

Note: To prevent unused detergent from flowing straight into the drain during the next wash: Pour 1 litre of water into the left-hand compartment and start the programme **Drain**.

The drain hose at the siphon is blocked

1. Switch off the appliance. Pull out the mains plug.
2. Loosen the hose clamp. Carefully remove the drain hose; residual water may leak out.
3. Clean the drain hose and siphon connecting piece.

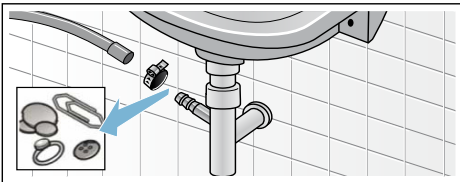

4. Re-attach the drain hose and secure the connection point using the hose clamp.

Filter in the water supply blocked

1. Release water pressure in the supply hose:
 - a) Turn off the tap.
 - b) Select any programme (except Rinse/Spin/Drain).
 - c) Start the programme and leave it to run for approx. 40 seconds.

- d) Switch off the appliance.
- e) Pull out the mains plug.
2. Clean the filters:
 - a) Disconnect the hose from the tap.
Clean the filter with a small brush.

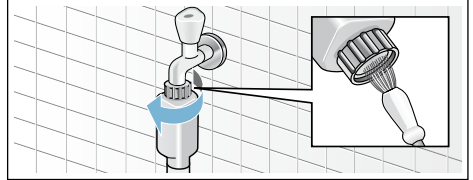

- b) For standard and Aqua-Secure models, clean the filter on the rear of the appliance:
Disconnect the hose from the rear of the appliance.
Use pliers to remove the filter and then clean it.

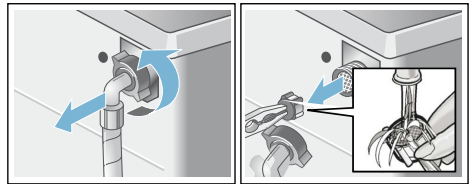

- c) Connect the hose and check for leaks.

en Faults and what to do about them.

Faults and what to do about them.

Emergency release

E.g. in the event of a power cut

The programme continues when the power supply is restored.

However, if the laundry has to be removed, the washing machine door can be opened as follows:

Warning **Risk of scalding!**

When you are washing at high temperatures, there is a risk of scalding if you come into contact with hot detergent solution and laundry. If possible, leave it to cool down first.

Warning **Risk of injury!**

Reaching into the drum while it is still turning may cause hand injuries. Do not reach into the drum when it is turning. Wait until the drum has stopped turning.

Warning **Irritation of the respiratory tract!**

Any active oxygen that is emitted may irritate the mucosa and cause eyes to water.

Do not open the door using the emergency release if a programme is running with active oxygen. Wait until there is no active oxygen in the drum.



Caution! **Water damage**



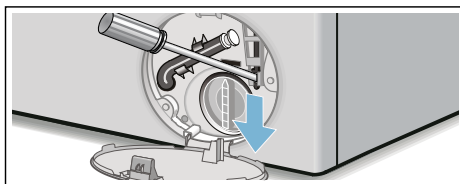









Any escaping water may cause water damage. Do not open the washing machine door if water can be seen through the glass.

1. Switch off the appliance. Pull out the mains plug.
2. Drain the water. → *Page 38*
3. Use a tool to pull the emergency release downwards and then release. The washing machine door can then be opened.













Information on the display panel

Indicator	Cause/remedy
 off	The door is unlocked at the end of the programme or when paused, laundry can be added/removed
 is lit up	<ul style="list-style-type: none">■ During the programme. Door locked.■ Paused: Temperature too high. Wait until the temperature drops.■ Paused: Spin speed too high. Wait until the drum comes to a halt.■ Paused: Water level too high. It is not possible to add laundry. Touch  to continue the programme.

Indicator	Cause/remedy
 flashes	<ul style="list-style-type: none"> ■ Slowly: The door cannot currently be locked or unlocked. Waiting time required. ■ Quickly: Close the door because water can flow out from the laundry.
 and the ActiveOxygen Refresh  indicator light flash	The door cannot be opened due to programme-related technical reasons. When the lights go off, the door can be opened.
 off	At the end of the programme, while the door is open
 is lit up	After the programme has started
 is flashing	Before the programme starts, paused
 is lit up	Water pressure too low, may increase the length of the programme.
 is flashing	No water supply: <ul style="list-style-type: none"> ■ Turn the tap on fully, ■ The supply hose is kinked/trapped, ■ Clean the filter if necessary. → <i>Page 39</i>
 3s is lit up	The childproof lock is activated – deactivate it. → <i>Page 33</i>
 3s is flashing	The childproof lock is activated – the programme selector has been turned or the control panel touched.
 is flashing	Run the Drum Clean 90 °C programme or a 60 °C programme to clean and care for the drum and the outer tub. Notes <ul style="list-style-type: none"> ■ Run the programme without laundry. ■ Use standard washing powder or a detergent that contains bleach. To prevent foaming, only use half the amount of detergent recommended by the detergent manufacturer. Do not use detergents intended for woollens or delicates. ■ Switching the information signal on/off
 is lit up	Too much foam has been detected and additional rinse cycles have been activated. Add less detergent to the next wash cycle with the same load.
E:60 alternating with -2b and End	At the end of the programme. Not an appliance fault – the unbalanced load detection system has interrupted the spin cycle because the laundry is unevenly distributed. Distribute small and large items of laundry evenly in the drum. Spin the laundry again if necessary.
E:35 alternating with -10	There is water in the base trough; the appliance is leaking. Turn off the tap. Call the after-sales service. → <i>Page 44</i>
E:36 alternating with -10	<ul style="list-style-type: none"> ■ The drain pump is blocked. Clean the drain pump. → <i>Page 38</i> ■ The drain hose/drain pipe is blocked. Clean the drain hose at the siphon. → <i>Page 39</i>
Other indicators	Switch off the appliance, wait for five seconds and then switch it on again. If the indicator appears again, call the after-sales service. → <i>Page 44</i>

Faults and what to do about them.

Faults	Cause/remedy
Water is leaking from the machine.	<ul style="list-style-type: none"> ■ Attach the drain hose correctly or replace it. ■ Tighten the threaded joint on the supply hose.
Water not flowing in. Detergent is not being dispensed.	<ul style="list-style-type: none"> ■ Will the programme start? ■ Is the tap turned on? ■ Could the filter be clogged? Clean the filter. → <i>Page 39</i> ■ Is the supply hose kinked or trapped?
The door will not open.	<ul style="list-style-type: none"> ■ The safety function is active. Do you want to stop the programme? → <i>Page 34</i> ■ Have you selected  (Rinse Stop = no final spin)? → <i>Page 34</i> ■ Can the door only be opened by the emergency release? → <i>Page 40</i> ■ When switching from a programme that uses active oxygen to one that does not, the door will remain locked for up to 25 minutes until there is no longer any active oxygen in the drum.
The programme does not start.	<ul style="list-style-type: none"> ■ Have you started the programme or selected Finished in-time? ■ Is the door closed? ■ Is the childproof lock activated? Deactivate. → <i>Page 33</i>
The drum briefly jerks or judders after the programme has started.	Not a fault – the internal motor test may cause the drum to jerk or judder briefly when the wash programme starts.
The water is not draining.	<ul style="list-style-type: none"> ■ Have you selected  (Rinse Stop = no final spin)? → <i>Page 34</i> ■ Clean the drain pump. → <i>Page 38</i> ■ Clean the drain pipe and/or the drain hose.
Water is not visible in the drum.	Not a fault – the water is below the visible area.
The spin result is not satisfactory. Laundry wet/too damp.	<ul style="list-style-type: none"> ■ Not a fault – the unbalanced load detection system has interrupted the spin cycle because the laundry is unevenly distributed. Distribute small and large items of laundry evenly in the drum. ■ Is Easy-Iron selected? → <i>Page 30</i> ■ Is the selected speed too low?
The appliance restarts the spin cycle several times.	Not a fault – the unbalanced load detection system is adjusting an imbalance.
The programme is taking longer than usual.	<ul style="list-style-type: none"> ■ Not a fault – the unbalanced load detection system is adjusting an imbalance by repeatedly redistributing the laundry. ■ Not a fault – the foam detection system is active – a rinse cycle has been activated.
The length of the programme changes during the wash cycle.	Not a fault – the programme sequence is optimised for the specific washing process. This may change the length of the programme shown on the display panel.
Water remaining in the care product compartment  .	<ul style="list-style-type: none"> ■ Not a fault – the effectiveness of the care product is not affected. ■ Clean the insert if necessary.

Faults	Cause/remedy
Odours in the washing machine.	Run the Drum Clean or Cottons 90 °C programme without laundry. Add standard washing powder or a detergent that contains bleach. Note: To prevent foaming, only use half the amount of detergent recommended by the detergent manufacturer. Do not use detergents intended for woollens or delicates.
The  indicator has lit up in the touch display. Foam may also be leaking from the detergent drawer.	Have you used too much detergent? Mix one tablespoon of fabric softener with half a litre of water and pour it into compartment II (not suitable for outdoor clothing, sportswear or items made with down). Use less detergent for the next wash cycle.
Loud noises, vibrations and machine "wandering" during the spin cycle.	<ul style="list-style-type: none"> ■ Is the appliance level? Level the appliance. → <i>Page 16</i> ■ Are the appliance's feet secured? Secure the appliance's feet. → <i>Page 16</i> ■ Have the transport braces been removed? Remove the transport braces. → <i>Page 14</i>
The touch display does not work while the appliance is running.	<ul style="list-style-type: none"> ■ Has there been a power failure? ■ Have the fuses blown/has the circuit breaker tripped? Switch on the circuit breaker/replace the fuses. ■ If the fault occurs repeatedly, call the after-sales service.
There are noises after the programme starts ActiveOxygen Refresh  .	Not a fault – the appliance is filled with water to create mist; operating noises from the fan and pump can be heard when it is doing this.
Water stains on dry laundry after the ActiveOxygen Refresh  programme.	<ul style="list-style-type: none"> ■ Was residual water removed before laundry was added? ■ Level the appliance. The active oxygen treatment can only work properly if the appliance is levelled correctly. → <i>Page 16</i>
Noises can be heard after the ActiveOxygen Refresh  programme.	Active oxygen leaves a specific odour on the laundry following treatment. Shake out the laundry briefly.
Odour has not been removed satisfactorily after the ActiveOxygen Refresh  programme.	<ul style="list-style-type: none"> ■ The active oxygen treatment is less effective if the drum is dirty. Run the Drum Clean programme before using the appliance for the first time, and regularly thereafter. ■ Have you loaded too much laundry? Do not exceed the maximum load. ■ Leave the door and detergent drawer open so that any residual water can evaporate. → <i>Page 37</i>
There is detergent residue on the laundry.	<ul style="list-style-type: none"> ■ Some phosphate-free detergents contain water-insoluble residue. ■ Select Rinse or brush the laundry after washing.
When the appliance is paused,  flashes and  lights up.	<ul style="list-style-type: none"> ■ The water level is too high. It is not possible to add laundry. Close the door immediately if necessary. ■ Touch  to continue the programme.

Faults	Cause/remedy
▶▶ flashes when the appliance is paused and Ⓢ is off.	The door is unlocked. It is possible to add laundry.
If you cannot rectify a fault yourself (after switching the machine off and then on again) or a repair is required: <ul style="list-style-type: none">■ Switch off the appliance and pull the mains plug out of the socket.■ Turn off the tap and call the after-sales service.	



After-sales service

If you cannot rectify a fault yourself, contact customer services. → Cover page

We will always find an appropriate solution in order to avoid unnecessary visits by engineers.

Please give customer services the product number (E no.) and the production number (FD) of the appliance.

E-Nr. _____	FD _____
-------------	----------

E no. Product number
FD Production number

You can find this information
*depending on the model:

On the inside of the door*/in the opened service flap* and on the rear of the appliance.

Trust the expertise of the manufacturer.

Contact us for assistance. By doing so, you will ensure that the repairs are carried out by trained service personnel using genuine spare parts.



Consumption rates

Energy and water consumption, programme duration and residual moisture for the main washing programmes

(approximate values)

Programme	Load	Energy consumption*	Water consumption*	Programme duration*
cotton 20 °C	9 kg	0,25 kWh	90 l	2 ¾ h
cotton 40 °C	9 kg	1,10 kWh	90 l	3 h
cotton 60 °C	9 kg	1,16 kWh	90 l	2 ¾ h
Cottons 90 °C	9 kg	2,14 kWh	100 l	2 ¾ h
Easy-Care 40 °C	4 kg	0,71 kWh	64 l	2 h
Mix 40 °C	4 kg	0,60 kWh	45 l	1 ¼ h
delicates / silk 30 °C	2 kg	0,19 kWh	37 l	¾ h
wool 30 °C	2 kg	0,19 kWh	41 l	¾ h
ActiveOxygen Refresh ☼	1 kg	0,02 kWh	0 l	¾ h

Programme	Approximate information on the residual moisture**		
	WAT28... Max. 1400 rpm	WAT24... Max. 1200 rpm	WAT20... Max. 1000 rpm
Cottons	48 %	53 %	62 %
Easy Care (Synthetics)	40 %	40 %	40 %
Delicates / Silk	30 %	30 %	30 %
Wool	45 %	45 %	45 %



* Observed values may deviate from the indicated values due to influence of water pressure, hardness and inlet temperature, ambient temperature, type, amount and soiling of laundry, detergent used, fluctuations in power supply and selected additional functions.

** Information on residual moisture based on programme-dependent spin-speed limit and maximum loads.

Efficiency test programmes for cotton fabrics

The following programmes (standard programmes, indicated by ) are suitable for cleaning normally soiled cotton fabrics and are the most efficient with respect to combined energy and water consumption.

Standard programmes for cottons in accordance with Regulation (EU) no. 1015/2010

Programme + temperature	Load	Approximate programme duration
Cottons Eco + 	9 kg	4 ¾ h
Cottons Eco + 	4,5 kg	4 ½ h
Cottons Eco + 	4,5 kg	4 ½ h

Programme setting at maximum speed for testing and energy labelling in accordance with Directive 2010/30/EU with cold water (15 °C).

The stated programme temperature is based on the temperature indicated on the care label in the laundry items. The actual washing temperature may differ from the stated programme temperature for energy-saving reasons; the washing performance corresponds to the selected temperature.



Technical data

Dimensions:

850 x 600 x 590 mm

(height x width x depth)

Weight:

70 - 85 kg (depending on model)

Mains connection:

Mains voltage 220 - 240 V, 50 Hz

Nominal current 10 A

Nominal power 1900 – 2300 W

Water pressure:

100 - 1000 kPa (1 - 10 bar)

Power consumption when switched off:

0,12 W

Power consumption when left on:

0,43 W



Aqua-Stop warranty

Only for appliances with Aqua-Stop

In addition to warranty claims against the vendor based on the purchase agreement and to our appliance warranty, we will provide compensation under the following conditions:

1. If water damage is caused due to a fault in our Aqua-Stop system, we will compensate domestic customers for the damage caused.
2. The liability guarantee is valid for the service life of the appliance.
3. It is a prerequisite of all warranty claims that the appliance with Aqua-Stop must have been installed and connected correctly in accordance with our instructions; this also includes a correctly fitted Aqua-Stop extension (genuine accessories). Our warranty does not cover defective feed lines or fittings leading to the Aqua-Stop connection at the tap.
4. Appliances with Aqua-Stop do not need to be supervised during operation, nor secured afterwards by turning off the tap. The tap only needs to be turned off if you are away from home for a long period, e.g. for several weeks' holiday.



Thank you for buying a Bosch Home Appliance!

Register your new device on MyBosch now and profit directly from:

- **Expert tips & tricks for your appliance**
- **Warranty extension options**
- **Discounts for accessories & spare-parts**
- **Digital manual and all appliance data at hand**
- **Easy access to Bosch Home Appliances Service**

Free and easy registration – also on mobile phones:

www.bosch-home.com/welcome

BOSCH
HOME APPLIANCES
SERVICE

Looking for help? You'll find it here.

Expert advice for your Bosch home appliances, need help with problems or a repair from Bosch experts.

Find out everything about the many ways Bosch can support you:

www.bosch-home.com/service

Contact data of all countries are listed in the attached service directory.

Robert Bosch Hausgeräte GmbH

Carl-Wery-Straße 34

81739 München, GERMANY

www.bosch-home.com



9001423927 (9905)

en