

Filtro supresor de interferencias

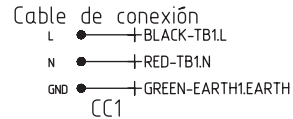

Portador puesta a tierra

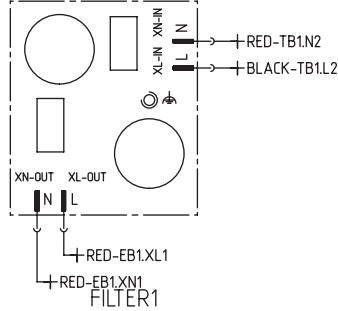

Bloque de terminales

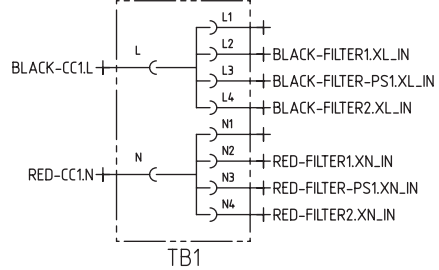

Filtro supresor de interferencias

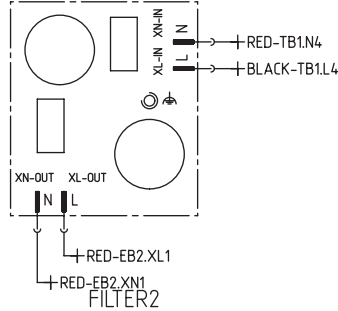

Unidad de alimentación

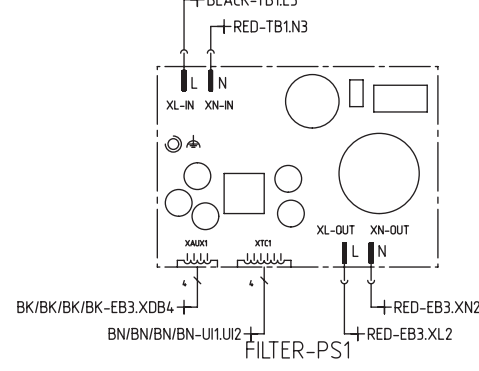

Ventilador

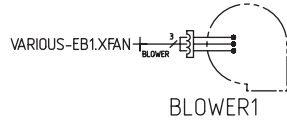

Sensor de temperatura

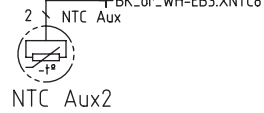

Bobina de inducción

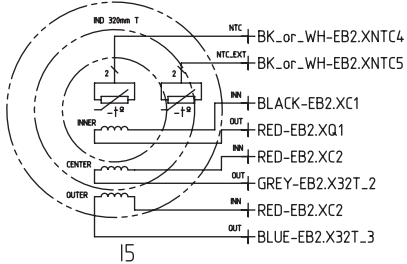

Unidad electrónica de potencia

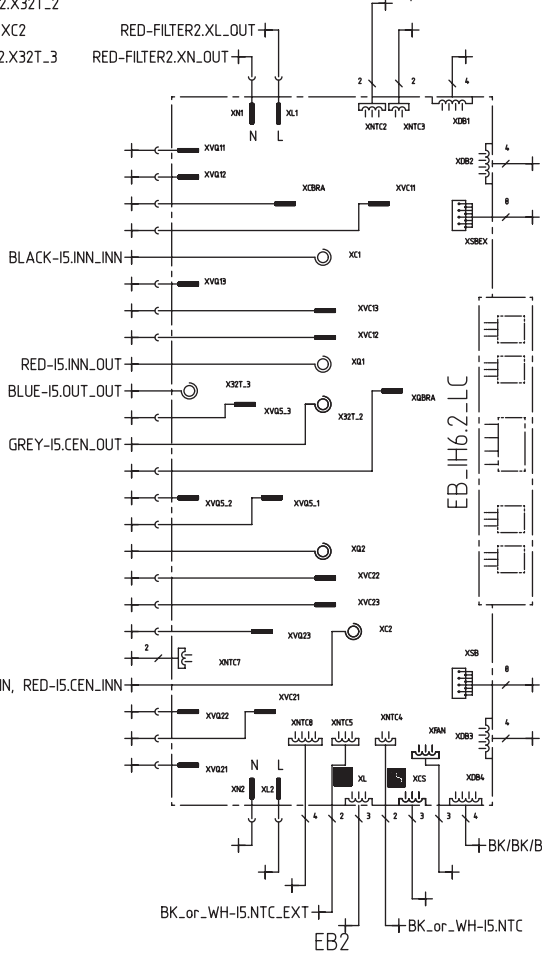

Unidad electrónica de potencia

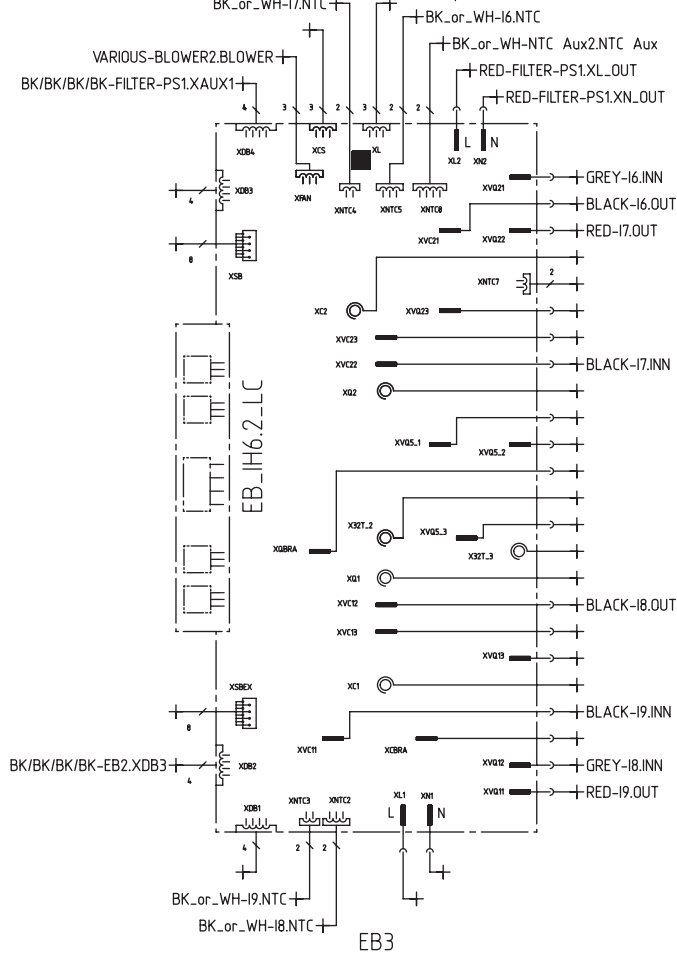

Unidad electrónica de potencia

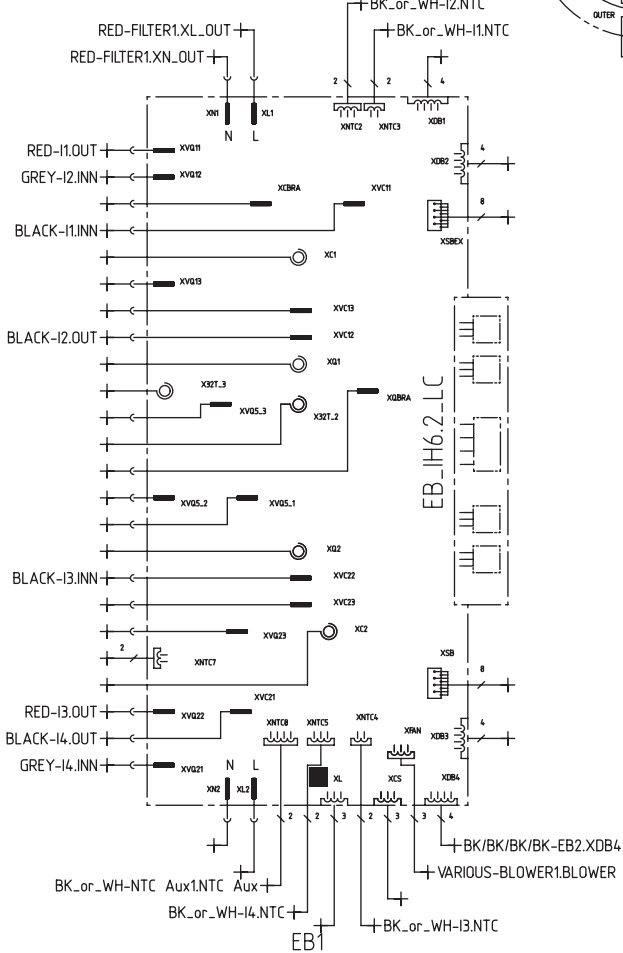

Bobina de inducción

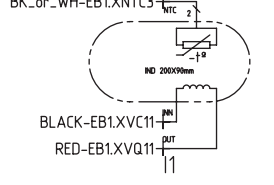

Bobina de inducción

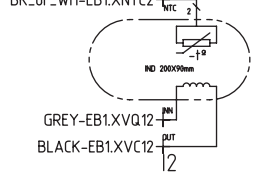

Bobina de inducción

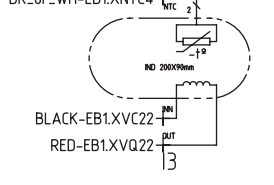

Bobina de inducción

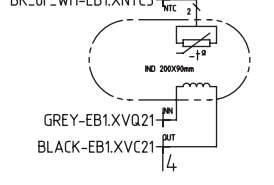

Bobina de inducción

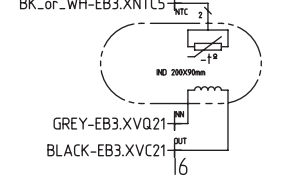

Bobina de inducción

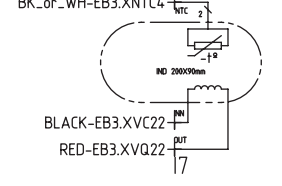

Bobina de inducción

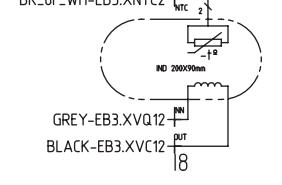

Bobina de inducción

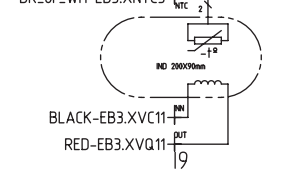

Sensor de temperatura

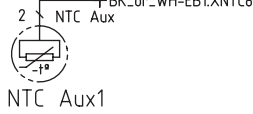

Placa electrónica de mando

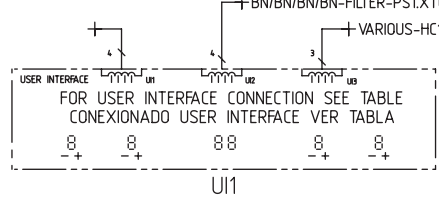

Módulo de comunicación

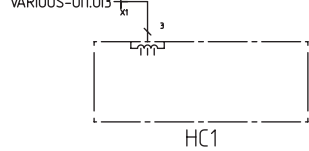

COLOURS IEC 60757		
Blue / Azul	BU	Orange / Naranja
Brown / Marrón	BN	Pink / Rosa
Black / Negro	BK	Turquoise / Turquesa
White / Blanco	WH	Grey / Gris
Red / Rojo	RD	Violet / Violeta
Green / Verde	GN	Gold / Oro
Yellow / Amarillo	YE	Silver / Plata
Green-Yellow / Verde-Amarillo	GN YE	

USER INTERFACE CONNECTION PORTS / PUERTOS DE CONEXIÓN DEL USER INTERFACE			
PORT NAME / NOMBRE PUERTO	UI1	UI2	UI3
YL238	-	X32	X10