



**BOSCH**



**Register** your  
new device on  
MyBosch now and  
get free benefits:  
**[bosch-home.com/  
welcome](https://bosch-home.com/welcome)**

# Washing machine

**WAT...**

**en** Instruction Manual and Installation Instructions

## Your new washing machine

You have chosen a Bosch washing machine.

Please take a few minutes to read and become familiar with the advantages of your washing machine.

To meet the high quality demands required by Bosch, every washing machine that leaves our factory is carefully checked to ensure that it functions correctly and is in perfect condition.

For more information on our products, accessories, replacement parts and services, see our website [www.bosch-home.com](http://www.bosch-home.com) or contact our after-sales service centres.

If the operating and installation instructions describe different models, any differences will be pointed out at the relevant points in the text.



Read these operating and installation instructions before switching on the washing machine.

### Display rules

#### **⚠ Warning!**

This combination of symbol and signal word indicates a possibly dangerous situation. Not heeding the warning can cause death or injuries.

#### **Caution!**

This signal word indicates a possibly dangerous situation. Not heeding the caution can cause property and/or environmental damage.

#### **Note/tip**

Information about the optimum use of the appliance/any other useful information.

#### **1. 2. 3. / a) b) c)**

The steps are represented by numbers or letters.

■ / -

Lists are represented by a small box or a dash.

# Contents

 <b>Intended use</b> . . . . .	4	 <b>Detergent</b> . . . . .	24
 <b>Safety instructions</b> . . . . .	5	Correct selection of detergent . . . . .	24
Children/people/pets . . . . .	5	Saving energy and detergent . . . . .	25
Installation . . . . .	6	 <b>Programme default settings</b> . . . . .	25
Operation . . . . .	8	Temperature . . . . .	25
Cleaning/Maintenance . . . . .	10	Spin speed . . . . .	25
 <b>Environmental protection</b> . . . . .	11	Finished in-time . . . . .	26
Packaging/used appliance . . . . .	11	 <b>Additional programme settings</b>	27
Tips on economical use . . . . .	11	Water&Rinse Plus . . . . .	27
 <b>Positioning and connecting</b> . . . . .	12	Easy-Iron . . . . .	27
Included with the appliance . . . . .	12	Prewash . . . . .	27
Safety instructions . . . . .	13	Soaking . . . . .	27
Installation surface . . . . .	13	Speed//SpeedPerfect . . . . .	28
Installation on a base or a wooden joist floor . . . . .	13	i-DOS . . . . .	28
Installation on a platform with drawer . . . . .	14	 <b>Operating the appliance</b> . . . . .	28
Installing the appliance in a kitchenette . . . . .	14	Preparing the washing machine . . . . .	28
Removing the transport locks . . . . .	14	Select programme/switch on the appliance . . . . .	28
Hose and cable lengths . . . . .	15	Change the programme default settings . . . . .	29
Water inlet . . . . .	15	Select additional programme settings	29
Water outlet . . . . .	16	Placing laundry into the drum . . . . .	29
Levelling . . . . .	17	Measure and add detergent and care products . . . . .	29
Electrical connection . . . . .	17	Start the programme . . . . .	29
Before washing for the first time . . . . .	18	Child lock//Child Lock . . . . .	30
Transportation . . . . .	18	Adding laundry . . . . .	30
 <b>Familiarising yourself with your appliance</b> . . . . .	20	Changing the programme . . . . .	30
Washing machine . . . . .	20	Changing the programme . . . . .	30
Control panel . . . . .	21	Programme end during rinse hold . . . . .	31
Display panel . . . . .	21	Programme end . . . . .	31
 <b>Laundry</b> . . . . .	23	Removing laundry/switching off the appliance . . . . .	31
Prepare the laundry . . . . .	23	 <b>Intelligent dosing system</b> . . . . .	31
Sorting laundry . . . . .	23	Familiarising yourself with i-DOS . . . . .	31
Starching . . . . .	24	i-DOS Detergent drawer . . . . .	32
Dyeing/bleaching . . . . .	24	Before setting up i-DOS . . . . .	32
		Automatic dosing . . . . .	32
		i-DOS Setting the dosage . . . . .	32
		Filling the dispensers . . . . .	33

Manual dosing . . . . . 34  
 Emptying the i-DOS detergent drawer,  
 cleaning the i-DOS detergent drawer  
 and its housing, cleaning the i-DOS  
 pump unit . . . . . 35

 **Sensors . . . . . 37**

Automatic load sensing . . . . . 37  
 Unbalanced load detection system . 37  
 VoltCheck . . . . . 37

 **Appliance settings . . . . . 37**

 **Cleaning and maintenance . . . 38**

Machine housing/control panel . . . . 38  
 Drum . . . . . 39  
 Descaling. . . . . 39  
 The drain pump is blocked, emergency  
 draining . . . . . 39  
 The drain hose at the siphon is blocked  
 . . . . . 40  
 Filter in the water supply blocked . . 40

 **Faults and what to do about them.  
 . . . . . 41**

Emergency release . . . . . 41  
 Information on the display panel . . . 41  
 Faults and what to do about them. . 42

 **After-sales service . . . . . 45**

 **Technical data . . . . . 46**

 **Aqua-Stop warranty . . . . . 46**

---

 **Intended use**

- This appliance is intended for private domestic use only.
- Do not install or operate this appliance anywhere that is liable to experience frost and/or outdoor conditions. There is a risk that the appliance will be damaged if residual water in it freezes. If hoses freeze up, they may crack/burst.
- This appliance must only be used for washing domestic laundry, consisting of machine-washable items and hand-washable woollens (see label on item). Using the appliance for any other purpose is outside of the scope of its intended application and is forbidden.
- This appliance is suitable for operation with mains water and commercially available detergents and care products (must be suitable for use in washing machines).
- This appliance is intended for use up to a maximum height of 4000 metres above sea level.

**Before you switch on the appliance:**

Check that there is no visible damage to the appliance. Do not operate the appliance if it is damaged. Should you have any problems, please contact your specialist dealer or our customer service.

Read and follow the operating and installation instructions and all other information provided with this appliance.

Retain the documents for subsequent use or for subsequent owners.

## Safety instructions

The following safety information and warnings are provided to protect you from injury and to prevent material damage to your surroundings.

It is nevertheless important to take the necessary precautions and to proceed with care when installing, maintaining, cleaning and operating the appliance.

### Children/people/pets

#### **Warning** **Risk of death!**

Children and other people who are unable to assess the risks involved when using the appliance may injure themselves or may find themselves in life-threatening situations. Therefore please note:

- The appliance may be used by children over the age of 8 years and by persons with reduced physical, sensory or mental capacity or by persons with a lack of experience or knowledge as long as they are supervised or have received instruction on how to use the appliance safely and they have understood the potential risks of using the appliance.
- Children must not play with this appliance.

- Do not allow children to clean or maintain this appliance unsupervised.
- Keep children under 3 years and pets away from this appliance.
- Do not leave the appliance unattended when children or other people who are unable to assess the risks are in the vicinity.

#### **Warning** **Risk of death!**

Children may lock themselves inside appliances and find themselves in a life-threatening situation.

- Do not position the appliance behind a door, as this may obstruct the appliance door or prevent it from opening completely.
- Once an appliance has reached the end of its life, pull the mains plug from the socket **before** severing the mains cable, and then destroy the lock on the appliance door.

#### **Warning** **Risk of suffocation!**

If allowed to play with the packaging/plastic film or packing components, children may become caught in these or pull them over their heads and suffocate.

Keep packaging, plastic film and packing components away from children.

**⚠ Warning**  
**Risk of poisoning!**

Detergents and care products may result in poisoning if consumed.

If accidentally swallowed, seek medical advice. Keep detergents and care products out of the reach of children.

**⚠ Warning**  
**Risk of burns!**

When washing at high temperatures, the glass in the appliance door becomes hot. Stop children from touching the appliance door when it is hot.

**⚠ Warning**  
**Eye/skin irritation!**

Contact with detergents or care products may cause eye/skin irritation.

Rinse eyes/skin thoroughly if they/it come(s) into contact with detergents or care products. Keep detergents and care products out of the reach of children.

## Installation

**⚠ Warning**  
**Risk of electric shock/fire/  
material damage/damage to  
the appliance!**

If the appliance is not installed properly, this may lead to a

dangerous situation. Ensure the following:

- The mains voltage on your power socket must match the rated voltage specified on the appliance (identification plate). The connected loads and the required fuse protection are specified on the identification plate.
- The mains plug and the protective contact socket must match and the earthing system must be correctly installed.
- The installation must have an adequate cross section.
- The mains plug must be freely accessible at all times. If this is not possible, in order to comply with the relevant safety regulations, a switch (all pole disconnection) must be built into the permanent installation in accordance with electrical installation regulations.
- If using a residual current circuit breaker, only use one that bears the following mark: . The presence of this mark is the only way to be sure that it fulfils all the applicable regulations.

**⚠ Warning****Risk of electric shock/fire/  
material damage/damage to  
the appliance!**

If the appliance's mains cable is altered or damaged, this may result in electric shock, short circuiting or fire due to overheating.

The mains cable must not be kinked, crushed or altered, and must not come into contact with any heat sources.

**⚠ Warning****Risk of fire/material damage/  
damage to the appliance!**

The use of extension cords or power strips may result in fire due to overheating or short circuiting.

Connect the appliance directly to an earthed socket that has been correctly installed. Do not use extension cords, power strips or multi-way couplers.

**⚠ Warning****Risk of injury/material  
damage/damage to the  
appliance!**

- The appliance may vibrate or move when in operation, potentially resulting in injury or material damage.

Place the appliance on a clean, even, solid surface and, using a spirit level to guide you, level it with the screw-in feet.

- If you take hold of any of the appliance's protruding parts (e.g. the appliance door) in order to lift or move it, these parts may break off and cause injury.

Do not take hold of any of the appliance's protruding parts in order to move the appliance.

**⚠ Warning****Risk of injury!**

- The appliance is very heavy. Lifting it may result in injury. Do not lift the appliance on your own.
- The appliance has sharp edges on which you could cut your hands. Do not take hold of the appliance by its sharp edges. Wear protective gloves to lift it.
- If the hoses and mains cables are not correctly routed, they may constitute a tripping hazard, which may result in injury. Route hoses and cables such that they do not constitute a tripping hazard.

## Caution!

### Material damage/damage to the appliance

- If the water pressure is too high or too low, the appliance may not be able to operate properly, and it may also result in material damage or damage to the appliance.  
Make sure that the water pressure in the water supply facility is at least 100 kPa (1 bar), and does not exceed 1000 kPa (10 bar).
- If the water hoses are altered or damaged, this may result in material damage or damage to the appliance. The water hoses must not be kinked, crushed, altered or severed.
- The use of hoses supplied by other brands to connect to the water supply may result in material damage or damage to the appliance. Use the hoses supplied with the appliance or genuine spare part hoses only.

- The appliance is secured for transportation by transport locking devices. If the transport locking devices are not removed before the appliance is operated, this may result in damage to the appliance.  
It is important to completely remove all transport locking devices before using the appliance for the first time. Make sure that you retain these transport locking devices separately. It is important to refit the transport locking devices if the appliance is to be transported, in order to prevent the appliance from being damaged in transit.

## Operation

### **Warning** **Risk of explosions/fire!**

Laundry that has been pretreated with cleaning agents that contain solvents, e.g. stain remover/cleaning solvent, may cause an explosion in the drum. Rinse the laundry thoroughly with water before washing it in the machine.

### **Warning** **Risk of poisoning!**

Poisonous fumes may be given off by cleaning agents that contain solvents, e.g. cleaning solvent.



Do not use cleaning agents that contain solvents.

**⚠ Warning**  
**Risk of injury!**

- If you support your weight/sit on the appliance door when it is open, the appliance may tip over, which may result in injury.  
Do not support your weight on the appliance door when it is open.
- If you climb onto the appliance, the worktop may break, which may result in injury.  
Do not climb onto the appliance.
- If you reach into the drum while it is still rotating, you risk injuring your hands.  
Wait until the drum has stopped rotating.

**⚠ Warning**  
**Risk of scalding!**

When washing at high temperatures, there is a risk of scalding if you come into contact with hot detergent solution (e.g. when draining hot detergent solution into a washbasin).  
Do not reach into the hot detergent solution.

**⚠ Warning**  
**Eye/skin irritation!**

Detergent and care products may spray out if the detergent

drawer is opened while the appliance is in operation. Rinse eyes/skin thoroughly if they/it come(s) into contact with detergents or care products. If accidentally swallowed, seek medical advice.

**Caution!**  
**Material damage/damage to the appliance**

- If the amount of laundry in the appliance exceeds its maximum load capacity, it may not be able to operate properly, or this may result in material damage or damage to the appliance.  
Do not exceed the maximum load capacity of dry laundry. Make sure you comply with the maximum load capacities specified for each of the programs → Supplementary sheet for the operating and installation instructions.
- If you pour the wrong quantity of detergent or cleaning agent into the appliance, this may result in material damage or damage to the appliance.  
Use detergents/care products/cleaning agents and softeners in accordance with the manufacturers' instructions.

## Cleaning/Maintenance

### **Warning**

#### **Risk of death!**

The appliance is powered by electricity. There is a risk of electric shock if you come into contact with live components. Therefore please note:

- Switch off the appliance. Disconnect the appliance from the power supply (pull out the plug).
- Never take hold of the mains plug with wet hands.
- When removing the mains plug from the socket, always take hold of the plug itself and never the mains cable, otherwise this may damage the mains cable.
- Do not make any technical modifications to the appliance or its features.
- Repairs and any other work on the appliance must only be conducted by our customer service or by an electrician. The same applies for replacing the mains cable (when necessary).
- Spare mains cables can be ordered from our customer service.

### **Warning**

#### **Risk of poisoning!**

Poisonous fumes may be given off by cleaning agents that contain solvents, e.g. cleaning solvent.

Do not use cleaning agents that contain solvents.

### **Warning**

#### **Risk of electric shock/material damage/damage to the appliance!**

If moisture penetrates the appliance, this may cause it to short circuit.

Do not use a pressure washer, steam cleaner, hose or spray gun to clean your appliance.

### **Warning**

#### **Risk of injury/material damage/damage to the appliance!**

The use of spare parts and accessories supplied by other brands is dangerous and may result in injury, material damage or damage to the appliance.

For safety reasons, use genuine spare parts and accessories only.

**Caution!****Material damage/damage to the appliance**

Cleaning agents and agents for pretreating laundry (e.g. stain removers, prewash sprays, etc.) may cause damage if they come into contact with the surfaces of the appliance. Therefore please note:

- Do not allow these agents to come into contact with the surfaces of the appliance.
- Clean the appliance with nothing but water and a soft, damp cloth.
- Remove any detergent, spray or other residues immediately.



---

## Environmental protection

**Packaging/used appliance**

Dispose of packaging in an environmentally-responsible manner.

This appliance is labelled in accordance with European Directive 2012/19/EU concerning used electrical and electronic appliances (waste electrical and electronic equipment - WEEE).

The guideline determines the framework for the return and recycling of used appliances as applicable throughout the EU.

**Tips on economical use**

- Always utilise the maximum amount of washing for the particular programme.  
Overview of programmes → Supplementary sheet for the operating and installation instructions.
- Wash normally soiled laundry without prewash.
- For light and normal soiling in laundry, you can save energy and detergent. → *Page 25*
- The selectable temperatures apply to the care labels on the textiles. The temperatures in the machine may deviate from this so that you get the optimum mix of energy-saving and washing results.
- **Energy consumption information:**  
→ *Page 21*  
This indicator tells you what the relative energy consumption is for the selected programs. The more indicator lights light up, the higher the consumption.

This enables you to compare the consumption levels of the different programs when choosing your program settings and to decide on an energy-saving program setting if you wish.

- **Energy-saving mode:** The display panel lighting goes out after a few minutes and the  button flashes. Press any button to activate the light. Energy-saving mode is not activated if a program is running.
- If the washing will be dried in a dryer, select the spin speed according to the dryer manufacturer's instructions.



## Positioning and connecting

### Included with the appliance

**Note:** Check that the machine has not been damaged in transit. Never use a damaged machine. If you have any problems, contact the dealer from whom you purchased the appliance or our after-sales service. → *Page 45*

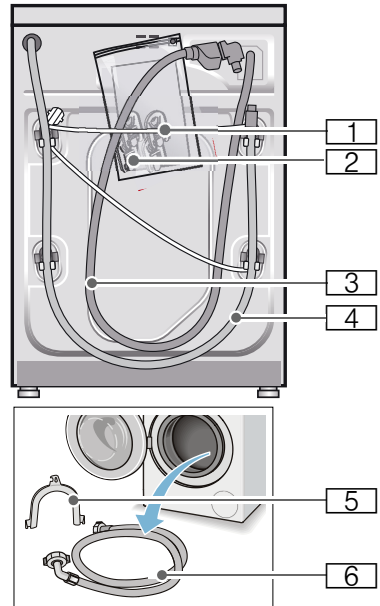

 Mains cable

 Bag:

- Installation and operating instructions
- After-sales service location directory\*
- Warranty\*
- Cover caps for fitting over openings once the transit securing devices have been removed

- 3 Water supply hose on aquaStop models
- 4 Water drain hose
- 5 Elbow for securing the water drain hose\*
- 6 Cold water supply hose on standard/AquaSecure models

\* Depending on the model

**In addition**, a hose clamp (24 - 40 mm diameter, available from specialist retailers) is required to connect the water drain hose to a siphon.

### Useful tools

- Spirit level for making sure the appliance is level
- Spanners, size:
  - WAF13 for removing the transit securing devices and
  - WAF17 for making the appliance's feet level

## Safety instructions

### **Warning**

#### **Risk of injury!**

- The washing machine is very heavy. Be careful when lifting/transporting the washing machine.
- When the washing machine is lifted by its protruding parts (e.g. the washing machine door), the components may break off and cause injuries. Do not lift the washing machine by protruding parts.
- If the hose and mains cables are not routed properly, there is a risk of tripping and injury. Lay hoses and cables in such a way that there is no risk of tripping.

### **Caution!**

#### **Damage to the appliance**

Frozen hoses may rip/burst. Do not install the washing machine in areas exposed to frost or outdoors.

### **Caution!**

#### **Water damage**

The connection points for the water supply hose and water drain hose are under high water pressure. To prevent leaks and water damage, you must follow the instructions in this section.

### **Notes**

- In addition to the safety information listed here, the local water and electricity supplier may have special requirements.
- If in doubt, have the appliance connected by a specialist.

## Installation surface

**Note:** The washing machine be stable so that it does not move around.

- The installation surface must be firm and level.
- Soft floors/floor coverings are not suitable.

## Installation on a base or a wooden joist floor

### **Caution!**

#### **Damage to the appliance**

The washing machine may "wander" and tip/topple from the base when spinning.

The feet of the appliance must be secured with holding brackets. Order no. WMZ 2200, WX 9756, Z 7080X0

**Note:** On wooden joist floors, install the washing machine:

- In a corner, if possible,
- On a water-resistant wooden board (min. 30 mm thick) which is screwed tightly to the floor.

## Installation on a platform with drawer

Platform order no.: WMZ 20490, WZ 20490, WZ 20510, WZ 20520

## Installing the appliance in a kitchenette

### **Warning** **Danger of death!**

There is a risk of electric shock if you touch live components. Do not remove the appliance covering plate.

### Notes

- Recess width of 60 cm required.
- Only install the washing machine underneath a continuous worktop that is securely connected to adjacent cabinets.

## Removing the transport locks

### **Caution!** **Damage to the appliance**

- The machine is secured for transportation using transport locks. If the transport locks are not removed, the drum, for example, may become damaged when the machine is operated. Before using the appliance for the first time, make sure that you completely remove all four transport locks. Keep the locks in a safe place.
- To prevent transport damage from occurring if the appliance is moved at a later date, you must refit the transport locks before transporting the appliance.

**Note:** Keep the screws and sleeves in a safe place.

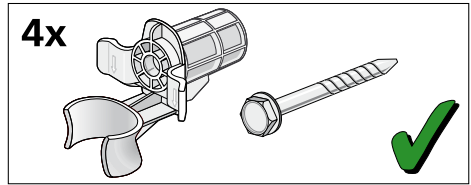

1. Take the hoses out of the holders.

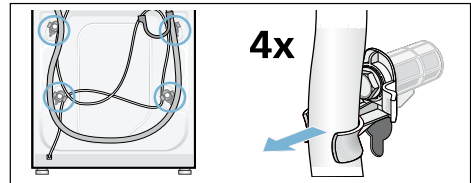

2. Unscrew and remove all four transport brace screws. Remove the sleeves. To do this, remove the mains cable from the holders.

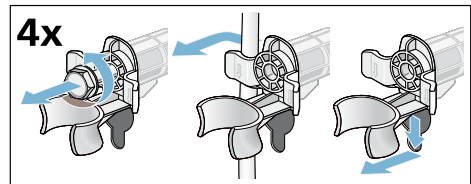

3. Fit the covers. Lock the covers firmly in place by applying pressure to the snap-in hooks.

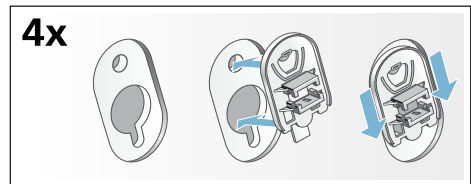

## Hose and cable lengths

### ■ Left-hand connection

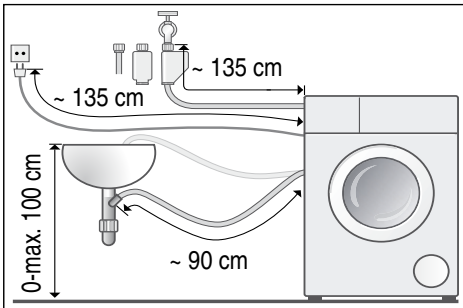

### ■ Right-hand connection

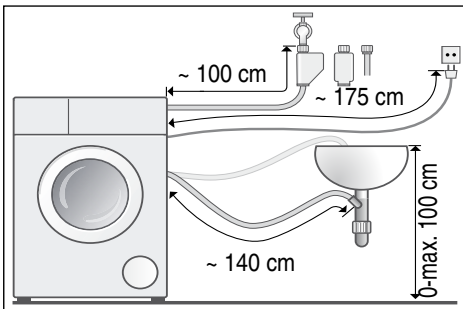

**Tip:** The following are available from specialist dealers/the after-sales service:

- An extension for Aqua-Stop or cold water supply hose (approx. 2.50 m); order no. WMZ2380, WZ10130, CZ11350, Z7070X0
- A longer supply hose (approx. 2.20 m) for standard model

## Water inlet

### **⚠ Warning** **Danger of death!**

There is a risk of electric shock if you touch live components.  
Do not immerse the Aqua-Stop safety valve in water (it contains an electric valve).

## Notes

- Only operate the washing machine using cold mains water.
- Do not connect the machine to the mixer tap of an unpressurised hot-water boiler.
- Do not use a used supply hose. Only use the supply hose supplied or one that was purchased from an authorised specialist retailer.
- Do not kink or squash the water supply hose.
- Do not alter (shorten, cut through) the water supply hose (otherwise its strength is no longer guaranteed).
- Only tighten the screw connections by hand. If the screw connections are tightened too much with a tool (pliers), the thread may become damaged.
- When connecting to a 21 mm = 1/2" tap, first fit an adapter\* with a sealing washer from 21 mm = 1/2" to 26.4 mm = 3/4".  
\*supplied depending on the model

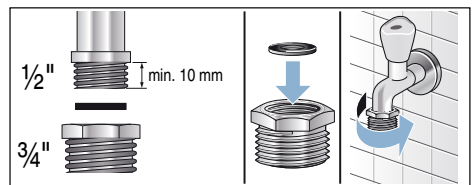

## Optimum water pressure in the supply network

**At least** 100 kPa (1 bar)

**Maximum** 1000 kPa (10 bar)

When the tap is open, the water flow rate is at least 8 l/min.

If the water pressure is higher than this, a pressure-reducing valve must be installed.

## Connection

Connect the water supply hose to the tap (26.4 mm = 3/4") and to the

## en Positioning and connecting

appliance (not necessary for Aqua-Stop models as this is permanently installed):

### ■ Model: **Standard**

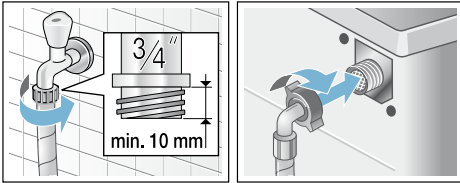

### ■ Model: **Aqua-Secure**

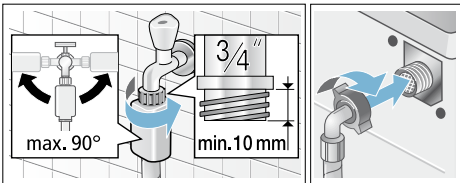

### ■ Model: **Aqua-Stop**

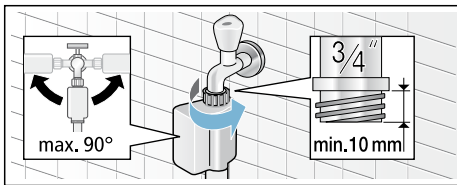

**Note:** Turn on the tap carefully, checking the leak tightness of the connection points. The screw connection is under mains water pressure.

## Water outlet

### **Caution!** **Water damage**

If the drain hose slips out of the wash basin or the connection point during draining due to high water pressure, any escaping water may cause water damage.

Secure the drain hose so that it cannot slip out.

**Note:** Do not kink the water drain hose or put strain on it lengthways.

You can lay the water drain hose as follows:

### ■ **Outlet in a sink**

#### **⚠ Warning** **Risk of scalding!**

When you are washing at high temperatures, there is a risk of scalding if you come into contact with hot detergent solution e.g. if hot detergent solution is being drained into a wash basin.

Do not reach into the hot detergent solution.

#### **Caution!**

#### **Damage to the appliance/fabrics**

If the end of the drain hose is immersed in the drained water, water may be sucked back into the appliance and may damage the appliance/fabrics.

Make sure that:

- The plug does not block drainage from the sink.
- The end of the drain hose is not immersed in the drained water.
- The water drains away quickly enough.

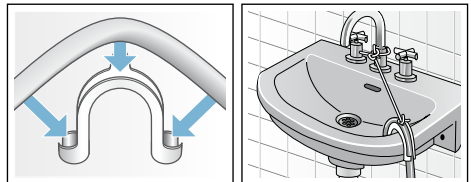

### ■ **Drainage into a siphon**

The connection point must be secured using a hose clamp with a diameter of 24-40 mm (available from specialist dealers).

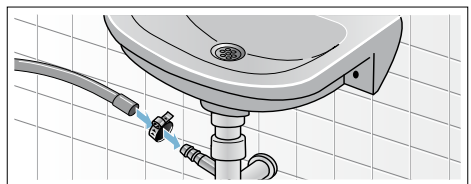



- **Outlet into a plastic pipe with rubber bushing or into a drainage pit**

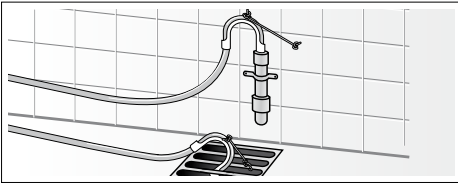

## Levelling

Level the appliance using a spirit level. Incorrect levelling may result in intense noise, vibrations and "wandering".

1. Loosen the lock nuts using a wrench, by turning it in a clockwise direction.
2. Check the alignment of the washing machine with a spirit level, and adjust it if necessary. Change the height by turning the appliance feet. All four appliance feet must stand firmly on the ground.
3. Tighten the lock nut against the housing.  
In doing so, hold the foot tight and do not adjust its height. The lock nuts on all four appliance feet must be screwed tightly against the housing.

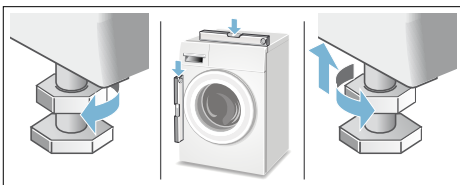

## Electrical connection

### **⚠ Warning** **Danger of death!**

There is a risk of electric shock if you touch live components.

- Never touch or hold the mains plug with wet hands.
- Only pull out the mains cable by the plug and never by the cable, as this could damage it.
- Never unplug the mains plug during operation.

Observe the following information and ensure that:

### Notes

- The mains voltage and voltage indicated on the washing machine (rating plate) are the same. The connected load and fuse required are specified on the rating plate.
- The washing machine is only connected to an alternating current via a properly installed earthed socket.
- The mains plug fits the socket.
- The cable cross-section is adequate.
- The earthing system is properly installed.
- The mains cable is only replaced by a qualified electrician (if this is necessary). Replacement mains cables are available from the after-sales service.
- No multiple plugs/couplings or extension cables are used.
- If an earth-leakage circuit breaker is used, only a type which displays this symbol is used: . Only this symbol guarantees compliance with the currently applicable regulations.
- The mains plug must be freely accessible at all times. If this is not possible, in order to comply with the relevant safety regulations, a switch (2-pole switch-off) must be built into the permanent installation in accordance with electrical installation regulations.
- The mains cable is not bent, squashed, modified, cut through, or in contact with heat sources.



## Before washing for the first time

The appliance has been thoroughly tested before leaving the factory. To remove any water that may be left over from testing, run the first wash cycle **without** any laundry.

### Notes

- The appliance **must be correctly installed** and **connected**. See → *Page 12* onwards
- Never use the appliance if it is damaged. Notify your after-sales service.

### Preparatory work:

1. Check the appliance.
2. Fill the  and  dispensers. → *Page 33*
3. Remove the protective film from the control panel.
4. Plug in the mains plug.
5. Turn on the tap.

### Run the program without laundry:

1. Switch on the appliance.
2. Close the door (do not load any laundry).
3. Depending on the model, set the **Drum Clean 90 °C** or **Cottons// Cotton 90 °C** program.
4. Open the detergent drawer.
5. Pour approx. 1 litre of water into the manual dosing compartment.
6. Pour all-purpose detergent into the manual dosing compartment.

**Note:** To prevent foaming, only use half the amount of detergent recommended by the detergent manufacturer. Do not use detergents intended for woollens or delicates.

7. Close the detergent drawer.
8. Press the  button.
9. Switch off the appliance once the program has finished.

**Your appliance is now ready to use.**

## Transportation

E.g. when moving house

### Preparatory work:

1. Turn off the tap.
2. Release the water pressure in the supply hose: → *"Filter in the water supply blocked" on page 40*
3. Disconnect the washing machine from the mains power supply.
4. Drain the remaining water: → *"The drain pump is blocked, emergency draining" on page 39*
5. Detach the hoses.
6. Empty the dispensers. → *Page 35*

### Caution!

#### **Risk of damage to the appliance caused by detergent/fabric softener leaking from the dispensers**

Leaking detergent/fabric softener can prevent the appliance from working correctly, e.g. due to damage to the electronics. Empty the dispensers before transporting the appliance.

**Installing the transport locks:**

1. Remove the covers and keep them in a safe place.  
Use a screwdriver if necessary.

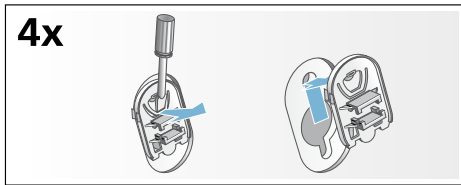

2. Insert all four sleeves.  
Clip the mains cable securely in the holders. Insert and tighten the screws.

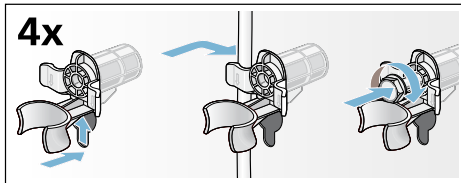
**Before switching on the appliance again:****Notes**

- The transit securing devices **must** be removed. → *Page 14*
- To prevent unused detergent from flowing straight into the drain during the next wash, pour approx. 1 litre of water into the manual dosing compartment, select the **Drain** program and start this program.

## Familiarising yourself with your appliance

### Washing machine

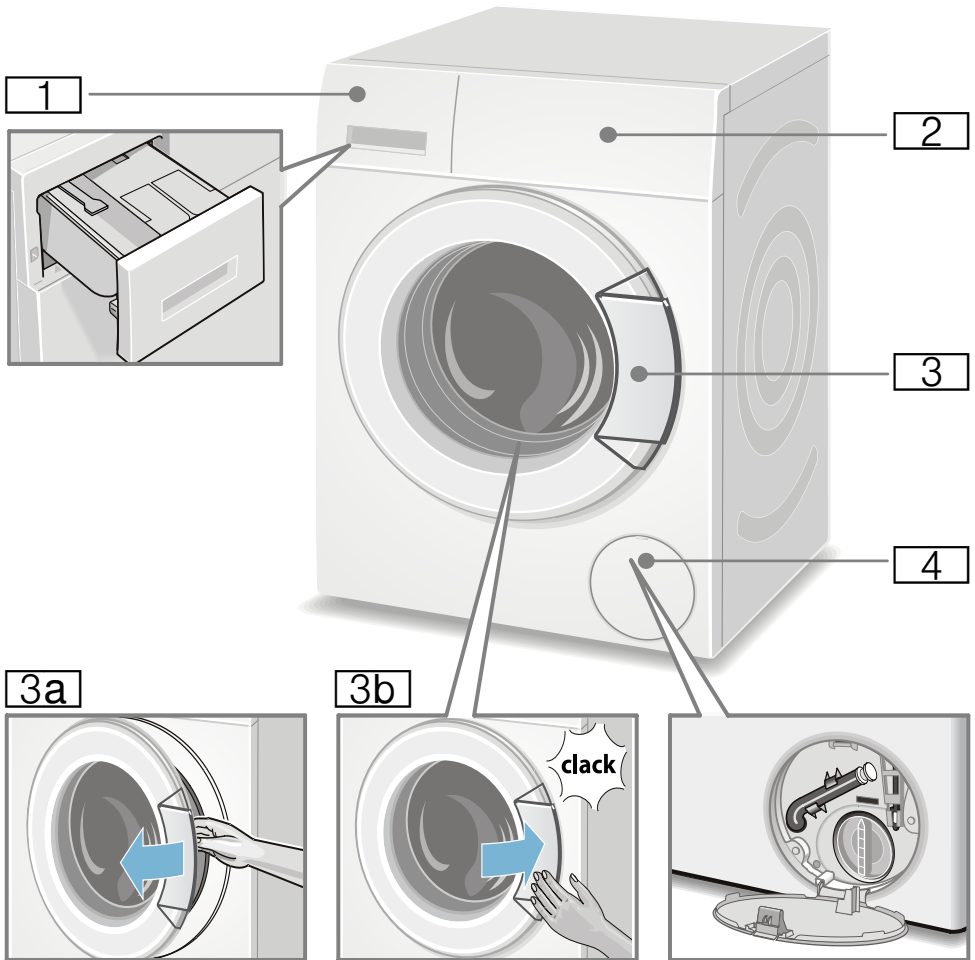

**1** Detergent drawer → *Page 29*

**2** Controls

**3** Washing machine door with handle

**3a** Opening the washing machine door

**3b** Closing the washing machine door

**4** Service flap

## Control panel

Control panel depends on the model

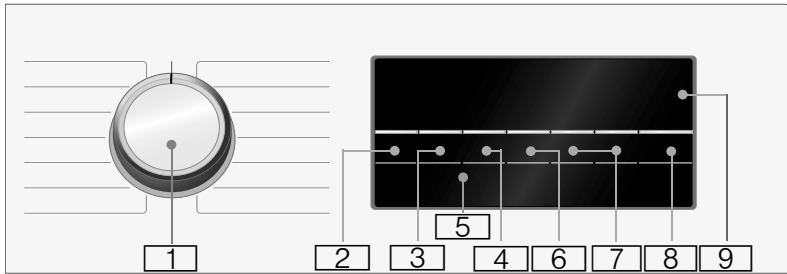

**1 Programme selector:**  
For selecting a programme and switching the washing machine on and off via the **Off** position (Off); You can find an overview of all programmes on the printed supplement for the installation and operating instructions.

**2** Change the **Temperature**.  
→ *Page 25*

**3** Change the **Spin speed**.  
→ *Page 25*

**4** Change the **Finished in-time**.  
→ *Page 26*

**5 Child lock//Child Lock** 3 sec.  
Activate/deactivate to prevent the functions that have been set from being changed inadvertently;  
→ *Page 30*

To do this, press and hold the **Spin speed** and **Finished in-time** buttons at the same time for approx. **3 seconds**.

**6 i-DOS** → *Page 31*  
Automatically dispenses fabric softener () or liquid detergent ()

**7 Select additional programme settings:** → *Page 27*

- Water&Rinse Plus \*
- Easy-Iron \*
- Prewash \*
- Soaking \*
- Speed//SpeedPerfect

**8** **button for:**

- Starting a programme,
- Pausing a programme, e.g. to add more laundry → *Page 30*,
- Cancelling a programme  
→ *Page 30*

**9 Display panel** for settings and information → *Page 21*

\* Depending on the model

## Display panel

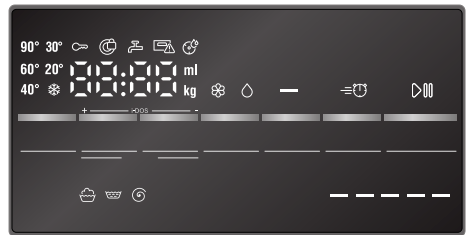

**Note:** You will find settings and information for the selected programme in the table.

\* - 90 °C

**Temperature** in °C;  
\* = cold

## en Familiarising yourself with your appliance







----, 0 - 1400\*  **Spin speed** in rpm,  
 0 = no spin cycle;  
 water simply  
 pumped out  
 → *Page 25*,  
 ---- = Rinse Hold  
 → *Page 25*







e.g. 2:30 **Finished in-time**  
 Select the length of  
 the programme in  
 h:min  
 (hours:minutes) after  
 selecting the  
 programme,

1 - 24 **End time pre-  
 selection** in hours;  
 programme to finish  
 after ... hours

9 kg\* **Recommended load**  
 e.g. 36\* ml **Basic dosage**  
 = = = = = **Energy  
 consumption  
 indicator**  
 The more indicator  
 lamps light up, the  
 higher the relative  
 energy  
 consumption.

\* Depending on the selected programme, settings and model

Other information on the display panel	
<b>Programme progress:</b>	
	Wash
	Rinse
	Spin
End	Programme end
---- 	Programme end with Rinse Hold selected
<b>Door:</b>	
 lit	The washing machine door will not open.
 flashing	After the programme has started: The door is not closed properly.

Other information on the display panel	
<b>Tap:</b>	
 lit	Tap not turned on, no water pressure
 flashing	Water pressure too low (may increase the length of the programme)
<b>Childproof lock: → Page 30</b>	
 lit	Childproof lock activated
 flashing	Childproof lock activated and programme selector adjusted
<b>Detergent drawer:</b>	
 lit	Detergent drawer open
<b>Drum Care:</b>	
 lit	Drum Care reminder function
<b>Error code:</b>	
E: --	→ <i>Page 41</i>
<b>Signal setting:</b>	
0 - 4	

## Laundry

### Prepare the laundry

#### Caution!

#### Damage to the appliance/fabrics

Foreign objects (e.g. coins, paperclips, needles, nails) may damage the laundry or components in the washing machine.

You should therefore note the following tips when preparing your laundry:

- Empty any pockets.

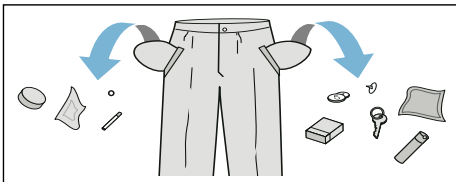

- Look out for metal items (paperclips, etc.) and remove them.
- Wash delicates in a laundry bag (tights, underwired bras, etc.).
- Close any zips; button up any cover buttons.
- Brush sand out of pockets and collars.
- Remove curtain fittings or place curtains in a laundry bag.

### Sorting laundry

Sort your laundry according to the care instructions and manufacturer's information on the care labels, depending on:







- Type of fabric/fibre
- Colour
  - Note:** Laundry can discolour or not be cleaned correctly. Wash white and coloured items separately. Wash new coloured items separately the first time you wash them.
- Soiling
  - Wash laundry with the same level of soiling together.

Some examples of soiling levels can be found on → Page 25.

- **Light:** Do not prewash, select the **Speed//SpeedPerfect** setting if necessary
- **Normal**
- **Heavy:** Load less laundry, select a program with prewash
- **Stains:** Remove/pretreat stains while they are fresh. Firstly, dab with soapy water; do not rub. Then wash the items of laundry with the appropriate program. Stubborn or dried-in stains can sometimes only be removed by washing several times.

- Symbols on the care labels

**Note:** The numbers in the symbols indicate the maximum washing temperature that may be used.

-  Suitable for normal washing process; e.g. Cottons program
-  A gentle washing process is required; e.g. Easy-Care program
-  An especially gentle washing process is required; e.g. Delicate/Silk program
-  Suitable for washing by hand; e.g.  Wool program
-  Do not machine wash.

## Starching

**Note:** Laundry should not be treated with fabric softener.

1. Switch on the appliance.
2. Select the **Rinse** program.
3. Pour liquid starch into the manual dosing compartment in accordance with the manufacturer's instructions. If necessary, clean this compartment beforehand.
4. Touch the  button.

## Dyeing/bleaching

Dye should only be used in normal household quantities. Salt may damage stainless steel. Always follow the dye manufacturer's instructions.

Do **not** use the washing machine to bleach clothes.

---

## Detergent

### Correct selection of detergent

The care label is crucial for selecting the correct detergent, temperature and treatment of the laundry. → See also [www.sartex.ch](http://www.sartex.ch)

If you visit [www.cleanright.eu](http://www.cleanright.eu), you will find further information on detergents, care products and cleaning agents for domestic use.

- **Standard detergent with optical brighteners**  
Suitable for boil-washable white laundry made from linen or cotton  
Programme: Cottons/  
cold - max. 90 °C
- **Detergent for colours without bleach or optical brighteners**  
Suitable for coloured laundry made from linen or cotton  
Programme: Cottons/  
cold - max. 60 °C
- **Detergent for colours/delicates without optical brighteners**  
Suitable for coloured laundry made from easy-care fibres, synthetic fibres  
Programme: Easy-Care/  
cold - max. 60 °C
- **Detergent for delicates**  
Suitable for delicate, fine fabrics, silk or viscose  
Programme: Delicate/Silk/  
cold - max. 40 °C
- **Detergent for woollens**  
Suitable for wool  
Wool programme/  
cold - max. 40 °C



## Saving energy and detergent

For light and normal soiling, you can save energy (lower washing temperature) and detergent.

Saving	Soiling/note
 <p>Reduced temperature and detergent quantity as per the recommended dosage</p> <p>Temperature as per the care label and detergent quantity as per the recommended dosage for heavy soiling</p>	<p><b>Light</b> No visible dirt or stains. Clothing has taken on some body odour, e.g.:</p> <ul style="list-style-type: none"> <li>■ Light summer/sports clothing (worn for a few hours)</li> <li>■ T-shirts, shirts, blouses (worn for up to one day)</li> <li>■ Guest bed linen and hand towels (used for one day)</li> </ul>
	<p><b>Normal</b> Visible dirt or a few light stains, e.g.:</p> <ul style="list-style-type: none"> <li>■ T-shirts, shirts, blouses (sweat soaked, worn a few times)</li> <li>■ Towels, bedding (used for up to one week)</li> </ul>
	<p><b>Heavy</b> Dirt and/or stains clearly visible, e.g. tea towels, baby items, work clothing</p>

**Note:** When measuring the amount of all detergents/additives/care products and cleaning agents, please always check the manufacturer's instructions and information. → Page 29

## P+ Programme default settings

The default program settings are displayed on the display panel once the program has been selected.

You can change the default settings.

To do this, repeatedly press the corresponding button until the required setting value is displayed on the display panel.

**Note:** Pressing and holding the button will allow you to automatically scroll through all the setting values to the last value. Pressing it again will allow you to change the setting values again.

You can find an overview of all possible program settings on the supplementary sheet for the installation and operating instructions.

### Temperature

(⌂, Temp. °C)

Depending on what stage the programme is in, you can change the set temperature before and during the programme.

The maximum temperature that can be set depends on the programme that has been selected.

### Spin speed

(⊙, Spin Speed//Reduce Spin)

Depending on how far through the program the appliance is, you can change the spin speed (in rpm – revolutions per minute) before and during the program.

**Setting 0:** No final spin; the water is simply pumped out. The laundry stays wet inside the drum, e.g. for items that are not to be spun.

--- **setting:** Rinse Stop = no final spin; the laundry stays in the water after the final rinse.

You can select "Rinse Stop" to prevent creasing if the laundry will not be taken out of the washing machine immediately after the program has ended.

To resume/end the program

→ *Page 31*

The maximum speed that can be set depends on the model and the program that has been selected.

## Finished in-time

(⊙, Finished in//Ready in)

**Before starting the program**, you can preselect the program end time ("Ready in" time) in hourly increments (h = hour), up to a maximum of 24 hours.

To do this:

1. Select a program.  
The program duration will be displayed for the selected program, e.g. **2:30** (hours:minutes).
2. Press the **Finished in-time** button repeatedly until the required number of hours is displayed.
3. Press the  button.  
The program will now start.  
The selected number of hours (e.g. **8 h**) is shown on the display panel and counts down until the wash program starts. The duration of the program will then be displayed.

**Note:** The program duration is automatically adjusted when the program is running.

Certain factors can affect the program duration, e.g.:

- Program settings,
- Detergent dosage (additional rinse cycles may be required due to foaming),
- Load size/type of fabrics (water absorption differs),
- Imbalances (e.g. due to fitted sheets) are eliminated by rotating the drum briefly several times,
- Fluctuations in power supply,
- Water pressure (inflow rate).

**Once the program has been started**, you can change the preselected number of hours as follows:

1. Press the  button.
2. Use the **Finished in-time** button to change the number of hours.
3. Press the  button.

**Once the program has been started**, you can add more laundry or remove laundry as required. → *Page 30*

## **P+** Additional programme settings

You can find an overview of all the possible additional settings on the printed supplement for the installation and operating instructions.

The settings vary depending on the model.

### Water&Rinse Plus



Button depends on the model

Higher water level and additional rinse cycle for particularly sensitive skin and/or for areas with very soft water.

### Easy-Iron

Button depends on the model

Reduces creasing by means of a special spin sequence followed by fluffing and reduced spin speed.

**Note:** The laundry retains an elevated level of residual moisture.

### Prewash



Button depends on the model

For heavily soiled laundry.

#### Notes

- If automatic dosing (i-DOS) is selected, detergent will be dispensed automatically for the prewash and main wash cycles.

- If manual dosing is selected, you will need to allocate detergent for the prewash and main wash cycles. Add detergent for the prewash to the drum. Pour washing powder for the main wash into the manual dosing compartment.

### Soaking

Button depends on the model

Before the main wash cycle starts, the laundry remains in the water for longer to remove heavy soiling.

To be used for particularly stubborn soiling.

Use i-DOS to dispense the detergent or pour it into the manual dosing compartment in accordance with the manufacturer's instructions.

#### Notes

- Load laundry of the same colour together.
- If your washing machine does not have this option, you can soak your laundry as follows:
  1. Select i-DOS or pour the detergent into the manual dosing compartment in accordance with the manufacturer's instructions.
  2. Select the **Cottons//Cotton 30 °C** program and press the ▷00 button.
  3. Press the ▷00 button after approx. 10 minutes. The laundry will soak in the water.
  4. Leave the laundry to soak for as long as required, then either press the ▷00 button again to resume the program or change the program.

**Note:** No additional detergent is required as the water used for soaking will be reused for washing.

## Speed//SpeedPerfect



Washing in a shorter time while achieving a washing result that is consistent with, but uses more energy than, the selected programme, without the Speed//SpeedPerfect setting.

**Note:** Do not exceed the maximum load.

## i-DOS

i-DOS /

Your appliance has an intelligent dosing system for liquid detergent ( ) and fabric softener ( ).

The optimum quantities of liquid detergent and fabric softener are dispensed automatically.

You can press i-DOS / to activate or deactivate automatic dosing and set the basic dosages.

→ "Intelligent dosing system" on page 31



## Operating the appliance

### Preparing the washing machine

**Note:** The washing machine **must be correctly installed** and **connected**.

From → Page 12

1. Connect the mains plug.
2. Turn on the water tap.
3. Open the door.
4. Check that the drum is completely drained. Drain if necessary.

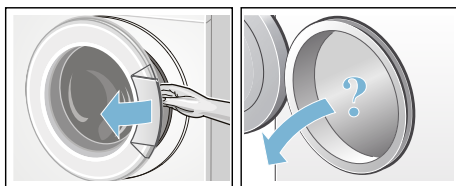

### Select programme/switch on the appliance

**Note:** If you have activated the childproof lock, you must first deactivate it, before you can set a program.

Use the program selector to select the required program. Can be rotated in either direction.

The appliance is switched on.

The **program default settings** for the selected program appear in the display panel:

- Temperature\*,
- The maximum load and the duration of the program (alternately)
- Energy consumption\*.

\*depending on the model

## Change the programme default settings

You can use or change the default settings for this wash cycle.

To do this, repeatedly press the corresponding button until the required setting is displayed.

The settings are activated without needing to be confirmed.

The settings are not retained after the washing machine is switched off.

Default program settings → *Page 25*

## Select additional programme settings

By selecting additional settings, you can better adapt the washing process to the items of laundry you are washing.

The settings can be selected or deselected depending on how far the program has progressed.

The button indicator lights will be lit if a setting has been activated.

The settings are not retained after the washing machine is switched off.

Additional program settings  
→ *Page 27*

## Placing laundry into the drum

### **Warning** **Danger of death!**

Items of laundry pretreated with cleaning agents that contain solvents, e.g. stain remover/cleaning solvent, may cause an explosion after being loaded into the washing machine. Hand-rinse these items of laundry thoroughly beforehand.

## Notes

- Mix items of laundry of varying sizes. Laundry items of different sizes distribute themselves better during the spin cycle. Individual laundry items may cause an unbalanced load.
  - Observe the maximum specified load. Overfilling adversely affects the washing result and promotes creasing.
1. Unfold presorted laundry items and place them in the drum.
  2. Make sure that no items of laundry are trapped between the door and the rubber seal, and close the door.

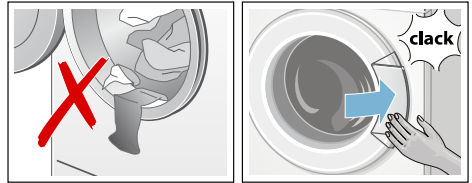

## Measure and add detergent and care products

In most programmes, your appliance can dose your detergent and fabric softener automatically. Automatic dosing is activated at the factory for all the designated programmes and it can be adjusted to suit your requirements.

→ *"Automatic dosing" on page 32*

For programmes in which automatic dosing is not possible or not desired (in which case, intelligent dosing is deactivated), you can add suitable detergent to the compartment in the detergent drawer for manual dosing.

→ *"Manual dosing" on page 34*

## Start the programme

Press the  button. The indicator lamp will light up and the programme will start.

The display panel shows the "Ready in" time while the programme is running, and the programme length plus the programme progress symbols once the wash cycle has started.

Display panel → *Page 21*

If you want to lock the programme to prevent the settings from being changed inadvertently, you can select the childproof lock as follows.

## Child lock//Child Lock

☞ 3 sec.

You can lock the washing machine to prevent the functions you have set from being changed inadvertently. To do this, activate the childproof lock once the programme has started.

To **activate/deactivate**, press and hold the **Spin speed** and **Finished in-time** buttons at the same time for approx. 3 seconds. The ☞ symbol will appear on the display panel.

- ☞ lit up: The childproof lock is active.
- ☞ flashing: The childproof lock is active and the programme selector has been adjusted. To deactivate the childproof lock, reset the programme selector to the initial programme. The symbol will light up again.

**Note:** Do not turn the program selector beyond the "off" position, otherwise the programme will stop.

**Note:** The childproof lock remains active after the appliance is switched off. You must deactivate the childproof lock whenever you want to start a new programme.

## Adding laundry

Once the programme has been started, you can add more laundry or remove laundry as required.

Press the ▷||| button to do this.

The ▷||| button indicator light will flash and the machine will check whether it is possible to add more laundry.

If

- the ☞ symbol goes out on the display panel, it is possible to add more laundry.
- the ☞ symbol lights up on the display panel, it is not possible to add more laundry.

**To resume the programme, press the ▷||| button.** The programme will resume automatically.

## Notes

- Do not leave the door open for too long when adding more laundry as water from the laundry may leak out.
- For safety reasons, the door remains locked when the water level or temperature is high, or while the drum is turning, and it is not possible to add more laundry during this time.

## Changing the programme

1. Press the ▷||| button.
2. Select a different program.
3. Press the ▷||| button. This starts the new program from the beginning.

## Cancel the programme

For programs at high temperature:

1. Press the ▷||| button.
2. To cool down laundry: Select **Rinse**.
3. Press the ▷||| button.

For programs at low temperature:

1. Press the ▷||| button.
2. Select **Spin/Drain//Drain/Spin**.
3. Press the ▷||| button.

## Programme end during rinse hold

----Ⓞ appears in the display panel and the indicator lamp of the ▷ button flashes.

Continue the program by:

- Pressing the ▷ button or
- Selecting a spin speed or setting the program selector to **Spin/Drain//Drain/Spin** and then pressing the ▷ button.

## Programme end

**End** appears on the display panel and the ▷ button indicator light is off.

## Removing laundry/switching off the appliance

1. Open the door and remove the laundry.
2. Turn the program selector to **Off** (Off). The appliance is switched off.
3. Turn off the tap.

**Note:** Not required for Aqua-Stop models.

### Notes

- Do not leave any items of laundry in the drum. They may shrink in the next wash or discolour another item.
- Remove any foreign objects from the drum and the rubber seal – risk of rusting.
- Wipe the rubber seal dry.

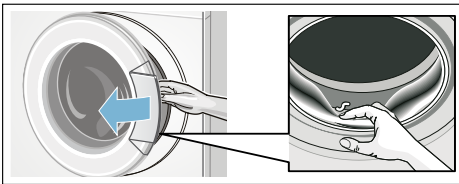

- Leave the door and detergent drawer open so that any residual water can evaporate.

- Always wait until the program ends, as the appliance could still be locked. Then switch the appliance on and wait for it to unlock.
- If the display panel goes off at the end of a program, the energy-saving mode is active. Press any button to activate the panel.

i-DOS

## Intelligent dosing system

### Familiarising yourself with i-DOS

#### i-DOS Intelligent dosing system

Your appliance has an intelligent dosing system for liquid detergent and fabric softener.

The optimum quantities of liquid detergent and fabric softener are dispensed automatically depending on the programme and settings.

Automatic dosing is activated at the factory for all the designated programmes and it can be adjusted to suit your requirements. The settings are saved when the appliance is switched off.

For programmes in which automatic dosing is not possible, you can add suitable detergent to the compartment in the detergent drawer for manual dosing.

## i-DOS Detergent drawer

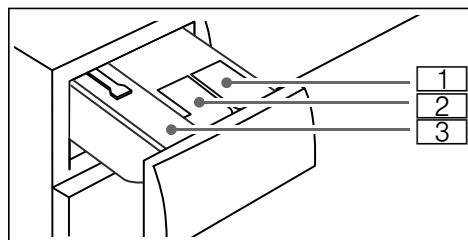

- 1 ◊ dispenser for liquid detergent
- 2 ☒ dispenser for fabric softener
- 3 Manual dosing compartment

### Before setting up i-DOS

Follow the manufacturer's instructions when choosing your detergent and care product. We recommend using easy-pour, all-purpose, universal and colour liquid detergents for all machine-washable, coloured items made of cotton or synthetic fabrics.

#### Notes

- Only use easy-pour liquid products that the manufacturer recommends adding to the detergent drawer.
- When cleaning the i-DOS detergent drawer, empty the dispenser completely and clean it. → Page 35
- Do not mix detergent and fabric softener.
- Do not use products containing solvents, caustic agents or volatile substances (e.g. bleach).
- Do not use products that have expired or are highly congealed.

### Automatic dosing

Automatic dosing can be activated or deactivated for each of the designated wash programmes separately.

Automatic dosing can also be activated or deactivated once the programme has

started, although this depends on which stage the programme is in.

To activate/deactivate automatic dosing, press i-DOS  briefly. The setting is saved until the next time it is changed.

**Tip:** In addition to automatic dosing, you can also add further laundry care products such as stain remover, starch, softener or bleach to the manual dosing compartment. To prevent overdosing or foam build-up, do not add more detergent to the manual dosing compartment.

#### Notes

- To protect your laundry, automatic dosing can only be used with certain programmes.
- **Programs with prewash\*:** If automatic dosing is selected, detergent will be dispensed automatically for the prewash and main wash cycles.

### i-DOS Setting the dosage

The basic dosage is the recommended dosage for a typical load of household laundry weighing 4.5 kg. The quantity of detergent and care product actually dispensed is calculated using the basic dosage and the amount of laundry, which is detected automatically.

The basic dosages for liquid detergent and fabric softener are set at the factory. You can individually adjust the basic dosages for each dispenser.

#### Check whether the preset basic dosages follow the manufacturer's recommendations in terms of:

- A 4.5 kg load
- For liquid detergent – the **normal** degree of soiling and the relevant water hardness
- For fabric softener – the **medium** softness



\* Depending on the model



Refer to the packaging label on your liquid detergent/fabric softener or ask the manufacturer directly for this information.

If necessary, adjust the basic dosages to the recommended load for the liquid detergent/care product you are using, the water hardness and/or the degree of soiling.

### Adjusting the basic dosage



1. Press and hold i-DOS  for approx. three seconds.  
The basic dosage setting is displayed for one of the dispensers.
2. Change the setting using: **Spin speed/Ready in-time**
3. Briefly press i-DOS .  
The basic dosage setting is displayed for the second dispenser.
4. Change the setting using: **Spin speed/Ready in-time**
5. Press and hold i-DOS  for approx. three seconds, briefly press any other selectable button or wait approx. 10 seconds to exit setting mode.

### Notes

- The changes are applied to all programmes in which dosing is possible.
- The changes are saved until the next time they are changed and are retained even after the appliance has been switched off.

### Filling the dispensers

#### Notes

- See the instructions in chapter → *"Before setting up i-DOS"* on page 32
- If  or  flashes, fill the relevant dispenser. → Page 32

#### Fill the dispensers as follows:

1. Pull out the detergent drawer.

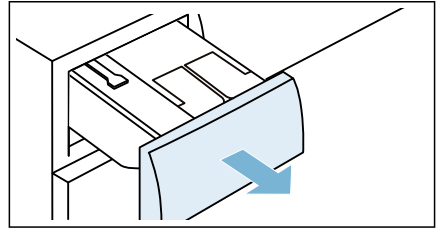

2. Open the dispenser lids.

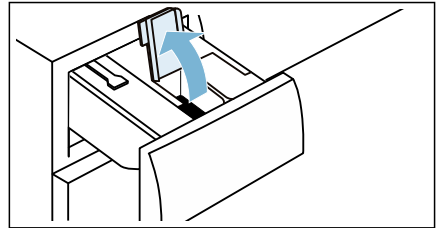

3. Pour liquid detergent and fabric softener into the relevant dispensers.

#### Notes

- Do not fill the dispensers above the **max.** marking.
- See the instructions in chapter → *"i-DOS Setting the dosage"* on page 32

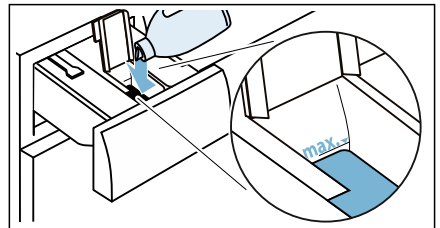

4. Close the dispenser lids.  
**Note:** To prevent the detergent drying out or drying up, do not leave the dispenser lids open for a long period of time.
5. Push in the detergent drawer.

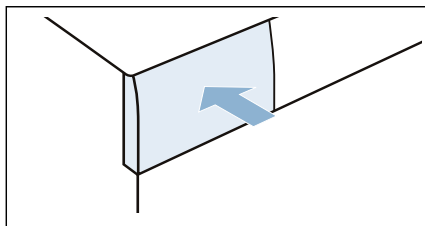

**Note:** When refilling the dispensers, always use the same type of liquid detergent or fabric softener. Do not mix different types of liquid detergent or fabric softener, as this can form lumps that may block the i-DOS pump unit.

If you switch to a different liquid detergent or fabric softener (type, manufacturer, etc.), empty the relevant dispenser completely and clean it beforehand. → *Page 35*

## Manual dosing

For programmes in which automatic dosing is not possible or desirable, or in which it has been deactivated, you will need to add detergent to the manual dosing compartment.

The detergent and/or care product in this compartment is dispensed when the wash cycle starts. Do not add fabric softener or any other products that should not be used until later in the wash cycle (e.g. during rinsing).

### **Note: Programmes with prewash\*:**

When automatic dosing is deactivated, place the detergent for the prewash in the drum. Pour washing powder for the main wash into the manual dosing compartment.

## Dosing and adding detergent

**Note:** Find out the optimum dosage for detergent and care product.

\* Depending on the model

1. Pull out the detergent drawer.

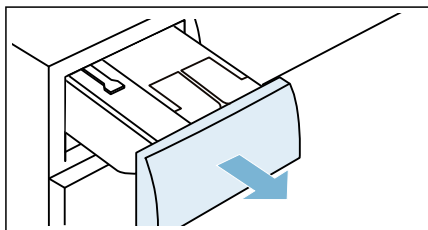

2. Pour laundry detergent and/or care product into the manual dosing compartment.

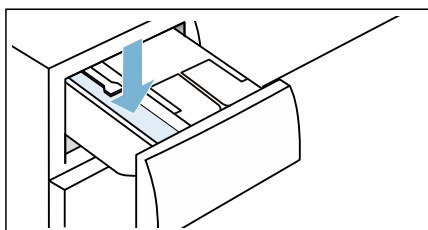

3. Push in the detergent drawer.

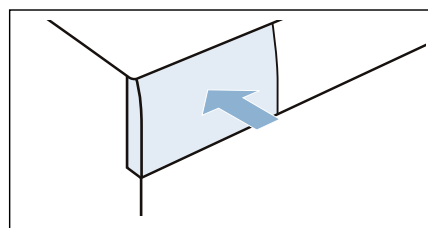

## Emptying the i-DOS detergent drawer, cleaning the i-DOS detergent drawer and its housing, cleaning the i-DOS pump unit

1. Switch off the appliance.
2. Pull out the detergent drawer.

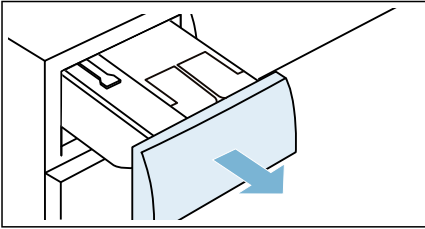

3. Press down the insert and remove the drawer completely.

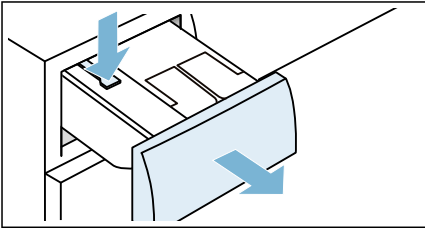

4. Press the pump unit insert and remove it.

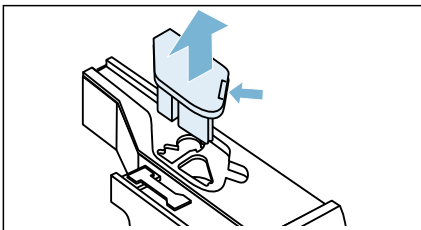

5. Unclip the rear detergent drawer lid and remove it.

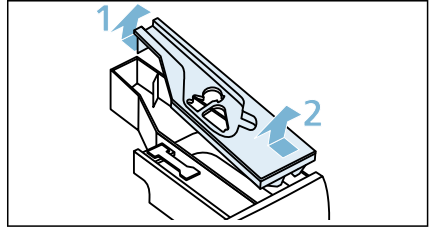

6. Empty the detergent drawer.

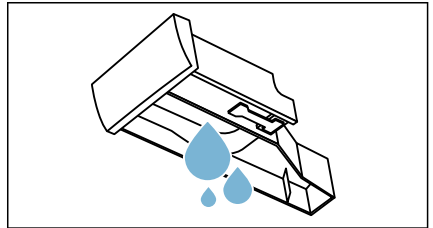

7. Clean the pump unit with a damp cloth.

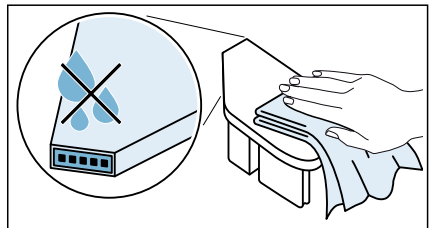

**Caution!**

The pump unit contains electrical components. These may be damaged if they come into contact with water.

- Do not clean the pump unit in the dishwasher and do not immerse it in water.
  - Protect the rear plug against water, detergent and fabric softener residue.
8. Clean the drawer, inside surface and lids with a soft, damp cloth or a hand shower.

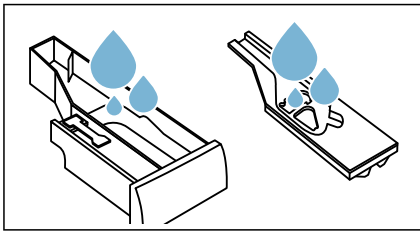

9. Dry the drawer, lids and pump unit and put them back together.

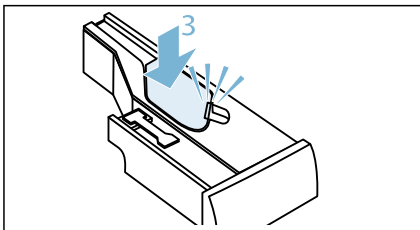
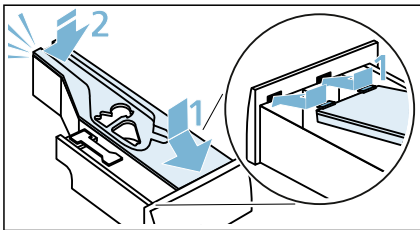

10. Clean the inside of the detergent drawer housing.



11. Push in the detergent drawer.

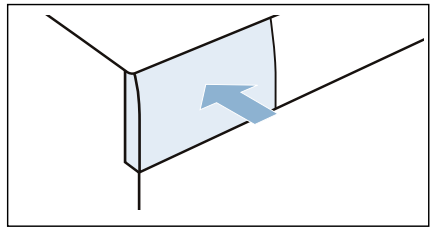

## Sensors

### Automatic load sensing

The automatic load sensing function adapts the water consumption ideally to each programme depending on the type of fabric and the load.

### Unbalanced load detection system

The automatic unbalanced load detection system detects imbalances and ensures even distribution of the laundry by repeatedly starting and stopping drum spinning.

If the laundry is extremely unevenly distributed, the speed is reduced or the spin cycle is not performed for safety reasons.

**Note:** Place large and small items of laundry evenly in the drum. → *Page 42*

### VoltCheck

depending on the model

The automatic voltage control system detects an unauthorised voltage under-usage. The colon on the Ready in display is flashing. → *Page 21*

Once the supply voltage is stable again, the colon of the Ready in display lights up (Normal mode).

The detected voltage under-usage is indicated in the further program sequence by all three points lighting up in the display.



**Note:** Voltage under-usages can for example result in program extensions and/or a non-satisfactory spin result.

## Appliance settings

You can change the following settings:

- The volume of the notification signals (e.g. at the end of the programme),
- The volume of the operating signals,
- Selecting/deselecting the Drum Care reminder function,

You will need to activate setting mode before you can change these settings.

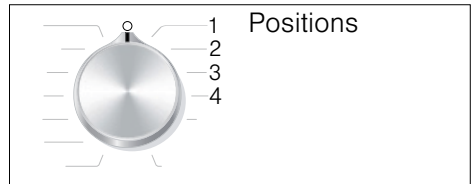

### Activating setting mode

1. Select the **Cottons//Cotton** programme in position 1. The washing machine is switched on.
2. Press the  button and, at the same time, turn the programme selector clockwise to position 2. Release the button.

Setting mode is activated and the default volume for the notification signals (e.g. at the end of the programme) appears in the display panel.

### Changing the volume

Use the **Finished in-time** button to change the following at the corresponding programme selector positions:

- 2: The volume of the notification signals and/or
- 3: The volume of the button signals.

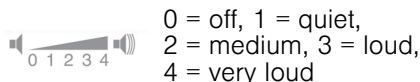

### Drum Care reminder function

Use the **Finished in-time** button to activate and deactivate the following at the corresponding programme selector position:

- 4: The Drum Care reminder function  
ON = activated  
OFF = deactivated

### Exiting setting mode

You can now exit setting mode by turning the programme selector to the **Off** (Off) position. The settings are saved.



## Cleaning and maintenance

### Warning

#### **Danger of death!**

There is a risk of electric shock if you touch live components. Switch off the appliance and pull out the mains plug.

### Warning

#### **Risk of poisoning!**

Toxic vapours can be produced by cleaning agents that contain solvents, e.g. cleaning solvent. Do not use cleaning agents that contain solvents.

### **Caution!**

#### **Damage to the appliance**

Cleaning agents that contain solvents, e.g. cleaning solvent, can damage surfaces and components in the machine.

Do not use cleaning agents that contain solvents.

#### **Prevent detergent residue from building up and odours from forming by following these instructions:**

### Notes

- Ensure the room in which the washing machine is set up is well ventilated.
- Leave the door and detergent dispenser tray open slightly when the washing machine is not in use.
- Occasionally run a wash using the **Cottons//Cotton 60 °C** programme and powder detergent.

### **Machine housing/control panel**

- Wipe the housing and the control panel with a soft, damp cloth.

- Remove the detergent residue immediately.
- Do not clean with a water jet.

## Drum

Use chlorine-free cleaning agents, do not use steel wool.

If there are odours in the washing machine, or to clean the drum, run the **Drum Clean 90 °C** programme without laundry. Add washing powder.

## Descaling

Descaling should not be necessary if the detergent is measured out correctly. However, if it is required, follow the manufacturer's instructions for the descaling agent. Suitable descalers can be obtained via our website or from customer services. → *Page 45*

## The drain pump is blocked, emergency draining

### **Warning** **Risk of scalding!**

When you wash at high temperatures, the water gets very hot. If you come into contact with the hot water, you may be scalded.

Allow the water to cool down.

1. Turn off the tap so that no more water can flow in and it has to be drained via the drain pump.
2. Switch off the appliance. Pull out the mains plug.
3. Open and remove the service flap.

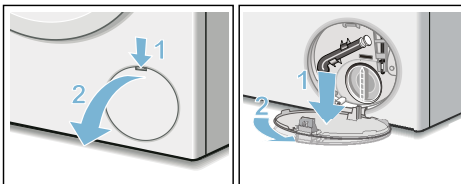

4. Take the drain hose out of the holder.  
Remove the sealing cap and drain the water into a suitable container. Replace the sealing cap and place the drain hose back in its holder.

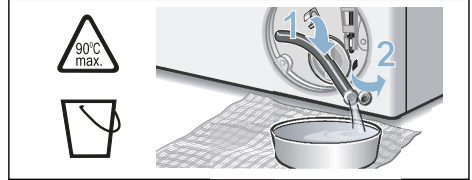

5. Carefully unscrew the pump cover, as residual water may leak out. Clean the inside and the thread on the pump cover and pump housing. The impeller in the drain pump must be able to rotate. Refit the pump cover and screw it on tightly. The handle must be positioned vertically.

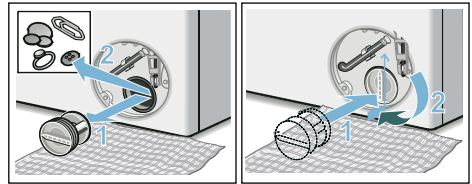

6. Reinsert the bottom of the service flap into the slot, clip it into place and close the flap.

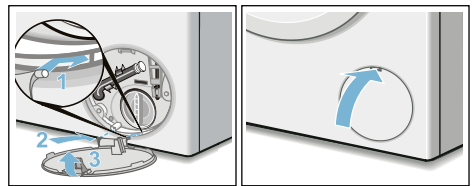

**Note:** To prevent unused detergent from flowing straight into the drain during the next wash, pour 1 litre of water into the manual dosing compartment and start the **Drain** program.

## The drain hose at the siphon is blocked

1. Switch off the appliance. Pull out the mains plug.
2. Loosen the hose clamp. Carefully remove the drain hose; residual water may leak out.
3. Clean the drain hose and siphon connecting piece.

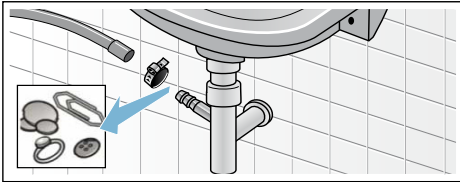

4. Re-attach the drain hose and secure the connection point using the hose clamp.

## Filter in the water supply blocked

1. Release water pressure in the supply hose:
  - a) Turn off the tap.
  - b) Select the Cottons programme.
  - c) Start the programme and leave it to run for approx. 70 seconds.
  - d) Switch off the appliance.
  - e) Pull out the mains plug.
2. Clean the filters:
  - a) Disconnect the hose from the water tap.  
Clean the filter with a small brush.

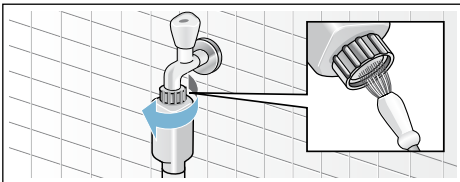

- b) For standard and Aqua-Secure models, clean the filter on the rear of the appliance:  
Remove the hose from the rear of the appliance.  
Use pliers to remove the filter and then clean it.

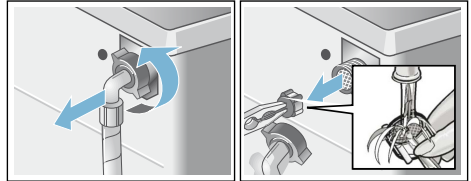

- c) Connect the hose and check for leaks.



## **Faults and what to do about them.**

### **Emergency release**

e.g. in the event of a power cut

The programme will continue running when the power supply has been restored.

However, if the laundry has to be removed, the washing machine door can be opened as follows:

#### **Warning**

##### **Risk of scalding!**

When you are washing at high temperatures, there is a risk of scalding if you come into contact with detergent solution and laundry.

If possible, leave it to cool down.

#### **Warning**

##### **Risk of injury!**

You may injure your hands if you reach into the drum while it is turning.

Do not reach into the drum when it is turning.

Wait until the drum has stopped turning.

#### **Caution!** **Water damage**





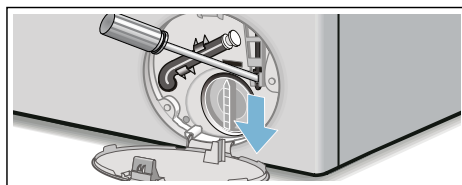

Any escaping water may cause water damage.

Do not open the washing machine door if water can be seen through the glass.



1. Switch off the appliance. Disconnect the mains plug.
2. Drain the detergent solution.
3. Pull the emergency release downwards with a tool and release. The washing machine door can then be opened.



## **Information on the display panel**







Display	Cause/Remedy
 is lit	<ul style="list-style-type: none"> <li>■ The temperature is too high. Wait for the temperature to drop.</li> <li>■ The water level is too high. It is not possible to add more laundry. Close the door immediately if open. Press the  button to resume the programme.</li> </ul>
 is flashing	<ul style="list-style-type: none"> <li>■ Laundry may be trapped. Open and close the door again and press the  button.</li> <li>■ If necessary, push the door closed or remove the trapped laundry and then push it closed again.</li> <li>■ If necessary, switch the appliance off and then on again; set a programme and apply the settings you require; start the programme.</li> </ul>
 is lit	<ul style="list-style-type: none"> <li>■ Turn on the cold water tap fully.</li> <li>■ The supply hose is kinked/trapped. Correct the position of the hose.</li> <li>■ The water pressure is too low. Clean the filter. → <i>Page 40</i></li> </ul>
	The childproof lock is activated – deactivate it.

## en Faults and what to do about them.

Display	Cause/Remedy
 is lit	Only for programmes with automatic dosing activated: <ul style="list-style-type: none"> <li>■ The detergent drawer has not been pushed in fully. Push the detergent drawer in fully.</li> <li>■ The pump unit is not inserted. Insert the pump unit into the drawer lid.</li> </ul>
○ or  is flashing	There is not enough detergent/softener in the ○ or  dispenser. Add more detergent/softener into the relevant dispenser. → Page 33
E:10 alternating with -00, -10 or -20	The pump unit of the automatic dosing system is blocked. Switch off the appliance. Clean the pump unit. → Page 35 If this indicator/symbol/code appears again, call our after-sales service.
: in the "Ready in" time is flashing	The mains voltage is too low.
. in the "Ready in" time is flashing	Undervoltage during the wash programme. The duration of the programme will be extended. → Page 37
E:18	<ul style="list-style-type: none"> <li>■ The drain pump is blocked. Clean the drain pump.</li> <li>■ The drain hose/drain pipe is blocked. Clean the drainage hose on the siphon. → Page 40</li> </ul>
E:23	There is water in the base trough; the appliance is leaking. Turn off the tap. Call the after-sales service.
E:32 alternating with <b>End</b>	flashing when the programme finishes. Not a fault – the unbalanced load detection system has interrupted the spin cycle because the laundry is unevenly distributed. Distribute small and large items of laundry evenly in the drum. Run the spin cycle again, if necessary.
Other indicators	Switch off the appliance, wait for 5 seconds and then switch it back on. If this indicator appears again, call our after-sales service. → Page 45



## Faults and what to do about them.

Faults	Cause/Remedy
Water is leaking from the appliance.	<ul style="list-style-type: none"> <li>■ Attach the drain hose correctly or replace it.</li> <li>■ Tighten the threaded joint on the supply hose.</li> </ul>
The machine is not filling with water. The pause function cannot be activated.	For some programmes (e.g. Cottons//Cotton), there is a specific load detection step once the programme is started. This takes approx. one minute. The appliance adjusts the amount of water depending on the size of the load. Water is then supplied to the drum. The pause function can then be activated.
The machine is not filling with water. Detergent is not being dispensed.	<ul style="list-style-type: none"> <li>■ Have you pressed the  button?</li> <li>■ Is the tap turned on?</li> <li>■ Could the filter be clogged? Clean the filter. → Page 40</li> <li>■ Is the supply hose kinked or trapped?</li> </ul>

Faults	Cause/Remedy
The door cannot be opened.	<ul style="list-style-type: none"> <li>■ The safety function is active. <b>Note:</b> For safety reasons, the door remains locked when the water level or temperature is high (see → <i>"Cancel the programme" on page 30</i>) or while the drum is rotating.</li> <li>■ Is the  childproof lock activated? Deactivate it. → <i>Page 30</i></li> <li>■ Is ---- selected (Rinse Stop = no final spin)? → <i>Page 31</i></li> <li>■ Can the door only be opened by the emergency release? → <i>Page 41</i></li> </ul>
The programme does not start.	<ul style="list-style-type: none"> <li>■ Have you pressed the  button?</li> <li>■ Is <b>Finished in-time</b> selected?</li> <li>■ Is the door closed?</li> <li>■ Is the  childproof lock activated? Deactivate it. → <i>Page 30</i></li> </ul>
Nothing happens when you press  .	<p> continuously lights up. The detergent drawer has not been pushed in completely. Push the detergent drawer in fully.</p>
Nothing happens when you press i-DOS  .	<ul style="list-style-type: none"> <li>■ Is automatic dosing an option for the programme? Overview of programmes → Printed supplement for the operating and installation instructions</li> <li>■ Is the pump unit blocked? Switch off the appliance. Clean the pump unit. → <i>"Emptying the i-DOS detergent drawer, cleaning the i-DOS detergent drawer and its housing, cleaning the i-DOS pump unit" on page 35</i></li> </ul>
The wrong detergent/fabric softener has been poured into the dispenser(s).	<p>Empty the dispenser(s), clean it/them and pour in the correct product. → <i>"Emptying the i-DOS detergent drawer, cleaning the i-DOS detergent drawer and its housing, cleaning the i-DOS pump unit" on page 35</i> → <i>"Filling the dispensers" on page 33</i></p>
Detergent/fabric softener has congealed in the dispensers.	<p>Empty the dispenser(s), clean it/them and pour in the correct product. → <i>"Emptying the i-DOS detergent drawer, cleaning the i-DOS detergent drawer and its housing, cleaning the i-DOS pump unit" on page 35</i> → <i>"Filling the dispensers" on page 33</i></p>
Foam is leaking from the detergent drawer.	<ul style="list-style-type: none"> <li>■ Automatic dosing: i-DOS Check the dosage settings and, if required, reduce the basic dosage. → <i>"i-DOS Setting the dosage" on page 32</i> If required, use a different liquid detergent/fabric softener.</li> <li>■ Manual dosing: Have you used too much detergent? Use less detergent in the next wash cycle.</li> <li>■ Immediate action: Mix one tablespoon of fabric softener with 1/2 litre of water and pour it into the manual dosing compartment (not suitable for outdoor clothing, sportswear or items stuffed with down).</li> </ul>
Repeated, intensive foaming.	<ul style="list-style-type: none"> <li>■ Automatic dosing: i-DOS Check the dosage settings and, if required, reduce the basic dosage. → <i>"i-DOS Setting the dosage" on page 32</i> If required, use a different liquid detergent/fabric softener.</li> <li>■ Manual dosing: Have you used too much detergent? Add less detergent the next time you run a wash cycle with the same load.</li> </ul>
Detergent/fabric softener drips off the seal and collects on the door or in the seal fold.	<p>There is too much detergent/fabric softener in the dispensers. Do not fill the dispensers above the <b>max.</b> mark.</p>

## en Faults and what to do about them.

Faults	Cause/Remedy
Washing results not satisfactory.	<ul style="list-style-type: none"> <li>■ i-DOS Check the dosage settings and, if required, increase the basic dosage. → <i>"i-DOS Setting the dosage" on page 32</i></li> <li>■ Use a different liquid detergent.</li> </ul>
Brief whirring sound twice after the appliance is switched on.	Not a fault – when the appliance is switched on, this whirring sound occurs briefly due to internal testing of the automatic dosing system.
Whirring sound after the programme starts and during the last rinse cycle.	Not a fault – when automatic dosing is activated, a whirring sound occurs after water enters the drum during detergent dosing and in the last rinse cycle during fabric softener dosing. The sound is caused by the i-DOS pump unit and is a normal operating noise.
The drum briefly jerks or judders after the programme has started.	Not a fault – the internal motor test may cause the drum to jerk or judder briefly when the wash programme starts.
The water is not draining.	<ul style="list-style-type: none"> <li>■ Is ---- selected (Rinse Stop = no final spin)? → <i>Page 31</i></li> <li>■ Clean the drain pump.</li> <li>■ Clean the drain pipe and/or the drain hose.</li> </ul>
Water is not visible in the drum.	Not a fault – the water is below the visible area.
The spin result is not satisfactory. Laundry is wet/too damp.	<ul style="list-style-type: none"> <li>■ Not a fault – the unbalanced load detection system has interrupted the spin cycle because the laundry is unevenly distributed. Distribute small and large items of laundry evenly in the drum.</li> <li>■ Is Anti-crease (depending on the model) selected?</li> <li>■ Is the selected speed too low?</li> </ul>
Drum starts rotating briefly several times.	Not a fault – the unbalanced load detection system is eliminating an imbalance.
The programme is taking longer than usual.	<ul style="list-style-type: none"> <li>■ Not a fault – the unbalanced load detection system is eliminating an imbalance by repeatedly redistributing the laundry.</li> <li>■ Not a fault – the foam detection system is active; this adds an additional rinse cycle.</li> </ul>
The duration of the programme changes during the wash cycle.	Not a fault – the programme sequence is optimised for the specific washing process. This may change the programme duration shown on the display panel.
Odours in the washing machine.	<p>Depending on the model, run the <b>Drum Clean 90 °C</b> or <b>Cottons//Cotton 90 °C</b> programme without laundry.</p> <p>Add all-purpose washing powder or a detergent that contains a bleaching agent.</p> <p><b>Note:</b> To prevent foaming, only use half the amount of detergent recommended by the detergent manufacturer. Do not use detergents intended for woollens or delicates.</p>
Loud noises, vibrations and machine “wandering” during the spin cycle.	<ul style="list-style-type: none"> <li>■ Is the appliance aligned? Make the appliance level. → <i>Page 17</i></li> <li>■ Are the appliance's feet secured? Secure the appliance's feet. → <i>Page 17</i></li> <li>■ Have the transit securing devices been removed? Remove the transportation protection devices. → <i>Page 14</i></li> </ul>

Faults	Cause/Remedy
The display panel/indicator lights do not work while the appliance is running.	<ul style="list-style-type: none"> <li>■ Power failure?</li> <li>■ Have the fuses blown/has the circuit breaker tripped? Switch on/replace the fuses.</li> <li>■ If the fault occurs repeatedly, call our after-sales service.</li> </ul>
There is detergent residue on the laundry.	<ul style="list-style-type: none"> <li>■ Some phosphate-free detergents contain water-insoluble residue.</li> <li>■ Select <b>Rinse</b> or brush the laundry after washing.</li> </ul>
The  symbol is lit on the display panel when the programme is paused.	<ul style="list-style-type: none"> <li>■ The water level is too high. Washing cannot be reloaded. Close the door immediately, if necessary.</li> <li>■ Press the  button to resume the programme.</li> </ul>
The  symbol on the display panel is off when the programme is paused.	The door is unlocked. It is possible to add laundry.
If you cannot rectify a fault yourself (after switching the machine off and then on again) or a repair is required:	
<ul style="list-style-type: none"> <li>■ Switch off the appliance and pull the mains plug out of the socket.</li> <li>■ Turn off the tap and call the after-sales service.</li> </ul>	



## After-sales service

If you cannot rectify a fault yourself, contact customer services. → Cover page

We will always find an appropriate solution in order to avoid unnecessary visits by engineers.

Please give customer services the product number (E no.) and the production number (FD) of the appliance.

E-Nr. \_\_\_\_\_ FD \_\_\_\_\_

E no.            Product number  
FD              Production number

You can find this information  
\*depending on the model:

On the inside of the door\*/in the opened service flap\* and on the rear of the appliance.

### **Trust the expertise of the manufacturer.**

Contact us for assistance. By doing so, you will ensure that the repairs are carried out by trained service personnel using genuine spare parts.



## Technical data

### Dimensions:

85 x 60 x 55 cm

(Height x width x depth)

### Weight:

66 - 73 kg\*

### Mains connection:

Nominal voltage: 220-240 V / 50 Hz

Nominal current: 10 A / 13 A\*

Nominal power: 1900 - 2300 W

### Water pressure:

100 - 1000 kPa (1-10 bar)

### Power consumption when appliance is switched off:

0.10 W

### Power consumption when appliance is left on:

0.50 W

\* Depending on the model



## Aqua-Stop warranty

### Only for appliances with Aqua-Stop

In addition to warranty claims against the vendor based on the purchase agreement and to our appliance warranty, we will provide compensation under the following conditions:

1. If water damage is caused due to a fault in our Aqua-Stop system, we will compensate domestic customers for the damage caused.
2. The liability guarantee is valid for the service life of the appliance.
3. It is a prerequisite of all warranty claims that the appliance with Aqua-Stop must have been installed and connected correctly in accordance with our instructions; this also includes a correctly fitted Aqua-Stop extension (genuine accessories).  
Our warranty does not cover defective feed lines or fittings leading to the Aqua-Stop connection at the tap.
4. Appliances with Aqua-Stop do not need to be supervised during operation, nor secured afterwards by turning off the tap.  
The tap only needs to be turned off if you are away from home for a long period, e.g. for several weeks' holiday.





## Thank you for buying a Bosch Home Appliance!

Register your new device on MyBosch now and profit directly from:

- **Expert tips & tricks for your appliance**
- **Warranty extension options**
- **Discounts for accessories & spare-parts**
- **Digital manual and all appliance data at hand**
- **Easy access to Bosch Home Appliances Service**

Free and easy registration – also on mobile phones:

[www.bosch-home.com/welcome](http://www.bosch-home.com/welcome)



## Looking for help? You'll find it here.

Expert advice for your Bosch home appliances, need help with problems or a repair from Bosch experts.

Find out everything about the many ways Bosch can support you:

[www.bosch-home.com/service](http://www.bosch-home.com/service)

**Contact data of all countries are listed in the attached service directory.**

### **Robert Bosch Hausgeräte GmbH**

Carl-Wery-Straße 34

81739 München, GERMANY

[www.bosch-home.com](http://www.bosch-home.com)



**9001380366** (9901)

en