



BOSCH



Register your
new device on
MyBosch now and
get free benefits:
**[bosch-home.com/
welcome](https://bosch-home.com/welcome)**

Washing machine

WAU28460TH

en Instruction Manual and Installation Instructions

Your new washing machine

You have chosen a Bosch washing machine.

Please take a few minutes to read and become familiar with the advantages of your washing machine.

To meet the high quality demands required by Bosch, every washing machine that leaves our factory is carefully checked to ensure that it functions correctly and is in perfect condition.

For more information on our products, accessories, replacement parts and services, see our website www.bosch-home.com or contact our after-sales service centres.

If the operating and installation instructions describe different models, any differences will be pointed out at the relevant points in the text.



Read these operating and installation instructions before switching on the washing machine.

Display rules

Warning!

This combination of symbol and signal word indicates a possibly dangerous situation. Not heeding the warning can cause death or injuries.

Caution!

This signal word indicates a possibly dangerous situation. Not heeding the caution can cause property and/or environmental damage.

Note/tip

Information about the optimum use of the appliance/any other useful information.

1. 2. 3. / a) b) c)

The steps are represented by numbers or letters.

■ / -

Lists are represented by a small box or a dash.

Contents

	Intended use	4
--	-------------------------------	---

	Safety instructions	5
--	--------------------------------------	---

Children/people/pets	5
Installation	6
Operation	8
Cleaning/Maintenance	10

	Environmental protection	11
--	---	----

Packaging/used appliance	11
Tips on economical use	11

	Positioning and connecting	12
--	---	----

Standard accessories	12
Safety instructions	13
Installation surface	13
Installation on a base or a wooden joist floor	13
Installation on a platform with drawer	13
Installing the appliance in a kitchenette	13
Removing the transport locks	14
Removing the support struts	14
Hose and cable lengths	15
Water inlet	15
Water outlet	16
Levelling	17
Electrical connection	18
Before washing for the first time	18
Transportation	19

	Getting to know the appliance	20
--	--	----

Appliance	20
Control panel	21
Display panel	22

	Laundry	23
--	--------------------------	----

Prepare the laundry	23
Sorting laundry	23
Starching	24
Dyeing/bleaching	24

	Detergent	24
---	----------------------------	----

Correct selection of detergent	24
Saving energy and detergent	25

	Overview of programmes	26
---	---	----

	Programme default settings	30
---	---	----

Temperature	30
Spin Speed	30
Finish in time	30

	Additional programme settings	31
---	--	----

Speed/Eco	31
Rinse Plus	32
Soak	32

	Operating the appliance	32
---	--	----

Preparing the washing machine	32
Select programme/switch on the appliance	32
Change the programme default settings	33
Select additional programme settings	33
Placing laundry into the drum	33
Measure and add detergent and care products	34
Starting the programme	34
Childproof lock	35
Adding/removing laundry	35
Changing the programme	35
Cancel the programme	36
Programme end during rinse hold	36
Programme end	36
Removing laundry/switching off the appliance	36

	Setting the signal	37
---	-------------------------------------	----

	Sensors	37
---	--------------------------	----

Unbalanced load detection system	37
--	----

	Cleaning and maintenance	38
---	---	----

Machine housing/control panel	38
---	----

Drum	38
Descaling.	38
Detergent drawer and housing	38
Detergent solution pump blocked . .	39
The drain hose at the siphon is blocked	40
Filter in the water supply is blocked	40

 **Faults and what to do about them** 41

Emergency release	41
Information on the display panel . . .	42
Faults and what to do about them . .	43

 **After-sales service** 45

 **Consumption values table** 46

 **Technical data** 47

 **Intended use**

- This appliance is intended for private domestic use only.
- Do not install or operate this appliance anywhere that is liable to experience frost and/or outdoor conditions. There is a risk that the appliance will be damaged if residual water in it freezes. If hoses freeze up, they may crack/burst.
- This appliance must only be used for washing domestic laundry, consisting of machine-washable items and hand-washable woollens (see label on item). Using the appliance for any other purpose is outside of the scope of its intended application and is forbidden.
- This appliance is suitable for operation with mains water and commercially available detergents and care products (must be suitable for use in washing machines).
- This appliance is intended for use up to a maximum height of 4000 metres above sea level.

Before you switch on the appliance:

Check that there is no visible damage to the appliance. Do not operate the appliance if it is damaged. Should you have any problems, please contact your specialist dealer or our customer service.

Read and follow the operating and installation instructions and all other information provided with this appliance.

Retain the documents for subsequent use or for subsequent owners.

Safety instructions

The following safety information and warnings are provided to protect you from injury and to prevent material damage to your surroundings.

It is nevertheless important to take the necessary precautions and to proceed with care when installing, maintaining, cleaning and operating the appliance.

Children/people/pets

Warning **Risk of death!**

Children and other people who are unable to assess the risks involved when using the appliance may injure themselves or may find themselves in life-threatening situations. Therefore please note:

- The appliance may be used by children over the age of 8 years and by persons with reduced physical, sensory or mental capacity or by persons with a lack of experience or knowledge as long as they are supervised or have received instruction on how to use the appliance safely and they have understood the potential risks of using the appliance.
- Children must not play with this appliance.

- Do not allow children to clean or maintain this appliance unsupervised.
- Keep children under 3 years and pets away from this appliance.
- Do not leave the appliance unattended when children or other people who are unable to assess the risks are in the vicinity.

Warning **Risk of death!**

Children may lock themselves inside appliances and find themselves in a life-threatening situation.

- Do not position the appliance behind a door, as this may obstruct the appliance door or prevent it from opening completely.
- Once an appliance has reached the end of its life, pull the mains plug from the socket **before** severing the mains cable, and then destroy the lock on the appliance door.

Warning **Risk of suffocation!**

If allowed to play with the packaging/plastic film or packing components, children may become caught in these or pull them over their heads and suffocate.

Keep packaging, plastic film and packing components away from children.

⚠ Warning

Risk of poisoning!

Detergents and care products may result in poisoning if consumed.

If accidentally swallowed, seek medical advice. Keep detergents and care products out of the reach of children.

⚠ Warning

Risk of burns!

When washing at high temperatures, the glass in the appliance door becomes hot. Stop children from touching the appliance door when it is hot.

⚠ Warning

Eye/skin irritation!

Contact with detergents or care products may cause eye/skin irritation.

Rinse eyes/skin thoroughly if they/it come(s) into contact with detergents or care products. Keep detergents and care products out of the reach of children.

Installation

⚠ Warning

**Risk of electric shock/fire/
material damage/damage to
the appliance!**

If the appliance is not installed properly, this may lead to a dangerous situation. Ensure the following:

- The mains voltage on your power socket must match the rated voltage specified on the appliance (identification plate). The connected loads and the required fuse protection are specified on the identification plate.
- The mains plug and the protective contact socket must match and the earthing system must be correctly installed.
- The installation must have an adequate cross section.
- The mains plug must be freely accessible at all times. If this is not possible, in order to comply with the relevant safety regulations, a switch (all pole disconnection) must be built into the permanent installation in accordance with electrical installation regulations.
- If using a residual current circuit breaker, only use one that bears the following mark: . The presence of this mark is the only way to be sure that it fulfils all the applicable regulations.

⚠ Warning**Risk of electric shock/fire/
material damage/damage to
the appliance!**

If the appliance's mains cable is altered or damaged, this may result in electric shock, short circuiting or fire due to overheating.

The mains cable must not be kinked, crushed or altered, and must not come into contact with any heat sources.

⚠ Warning**Risk of fire/material damage/
damage to the appliance!**

The use of extension cords or power strips may result in fire due to overheating or short circuiting.

Connect the appliance directly to an earthed socket that has been correctly installed. Do not use extension cords, power strips or multi-way couplers.

⚠ Warning**Risk of injury/material
damage/damage to the
appliance!**

- The appliance may vibrate or move when in operation, potentially resulting in injury or material damage.

Place the appliance on a clean, even, solid surface and, using a spirit level to guide you, level it with the screw-in feet.

- If you take hold of any of the appliance's protruding parts (e.g. the appliance door) in order to lift or move it, these parts may break off and cause injury.

Do not take hold of any of the appliance's protruding parts in order to move the appliance.

⚠ Warning**Risk of injury!**

- The appliance is very heavy. Lifting it may result in injury. Do not lift the appliance on your own.
- The appliance has sharp edges on which you could cut your hands. Do not take hold of the appliance by its sharp edges. Wear protective gloves to lift it.
- If the hoses and mains cables are not correctly routed, they may constitute a tripping hazard, which may result in injury. Route hoses and cables such that they do not constitute a tripping hazard.

Caution!

Material damage/damage to the appliance

- If the water pressure is too high or too low, the appliance may not be able to operate properly, and it may also result in material damage or damage to the appliance.
Make sure that the water pressure in the water supply facility is at least 100 kPa (1 bar), and does not exceed 1000 kPa (10 bar).
- If the water hoses are altered or damaged, this may result in material damage or damage to the appliance. The water hoses must not be kinked, crushed, altered or severed.
- The use of hoses supplied by other brands to connect to the water supply may result in material damage or damage to the appliance. Use the hoses supplied with the appliance or genuine spare part hoses only.

- The appliance is secured for transportation by transport locking devices. If the transport locking devices are not removed before the appliance is operated, this may result in damage to the appliance.
It is important to completely remove all transport locking devices before using the appliance for the first time. Make sure that you retain these transport locking devices separately. It is important to refit the transport locking devices if the appliance is to be transported, in order to prevent the appliance from being damaged in transit.

Operation

Warning **Risk of explosions/fire!**

Laundry that has been pretreated with cleaning agents that contain solvents, e.g. stain remover/cleaning solvent, may cause an explosion in the drum. Rinse the laundry thoroughly with water before washing it in the machine.

Warning **Risk of poisoning!**

Poisonous fumes may be given off by cleaning agents that contain solvents, e.g. cleaning solvent.
Do not use cleaning agents that contain solvents.

 Warning
Risk of injury!

- If you support your weight/sit on the appliance door when it is open, the appliance may tip over, which may result in injury.
Do not support your weight on the appliance door when it is open.
- If you climb onto the appliance, the worktop may break, which may result in injury.
Do not climb onto the appliance.
- If you reach into the drum while it is still rotating, you risk injuring your hands.
Wait until the drum has stopped rotating.

 Warning
Risk of scalding!

When washing at high temperatures, there is a risk of scalding if you come into contact with hot detergent solution (e.g. when draining hot detergent solution into a washbasin).
Do not reach into the hot detergent solution.

 Warning
Eye/skin irritation!

Detergent and care products may spray out if the detergent drawer is opened while the appliance is in operation. Rinse eyes/skin thoroughly if they/it come(s) into contact with detergents or care products. If accidentally swallowed, seek medical advice.

Caution!
Material damage/damage to the appliance

- If the amount of laundry in the appliance exceeds its maximum load capacity, it may not be able to operate properly, or this may result in material damage or damage to the appliance.
Do not exceed the maximum load capacity of dry laundry. Make sure you comply with the maximum load capacities specified for each of the programs.
- If you pour the wrong quantity of detergent or cleaning agent into the appliance, this may result in material damage or damage to the appliance.
Use detergents/care products/cleaning agents and softeners in accordance with the manufacturers' instructions.

Cleaning/Maintenance

Warning

Risk of death!

The appliance is powered by electricity. There is a risk of electric shock if you come into contact with live components. Therefore please note:

- Switch off the appliance. Disconnect the appliance from the power supply (pull out the plug).
- Never take hold of the mains plug with wet hands.
- When removing the mains plug from the socket, always take hold of the plug itself and never the mains cable, otherwise this may damage the mains cable.
- Do not make any technical modifications to the appliance or its features.
- Repairs and any other work on the appliance must only be conducted by our customer service or by an electrician. The same applies for replacing the mains cable (when necessary).
- Spare mains cables can be ordered from our customer service.

Warning

Risk of poisoning!

Poisonous fumes may be given off by cleaning agents that contain solvents, e.g. cleaning solvent.

Do not use cleaning agents that contain solvents.

Warning

Risk of electric shock/material damage/damage to the appliance!

If moisture penetrates the appliance, this may cause it to short circuit.

Do not use a pressure washer, steam cleaner, hose or spray gun to clean your appliance.

Warning

Risk of injury/material damage/damage to the appliance!

The use of spare parts and accessories supplied by other brands is dangerous and may result in injury, material damage or damage to the appliance.

For safety reasons, use genuine spare parts and accessories only.

Caution!

Material damage/damage to the appliance

Cleaning agents and agents for pretreating laundry (e.g. stain removers, prewash sprays, etc.) may cause damage if they come into contact with the surfaces of the appliance. Therefore please note:

- Do not allow these agents to come into contact with the surfaces of the appliance.
- Clean the appliance with nothing but water and a soft, damp cloth.
- Remove any detergent, spray or other residues immediately.



Environmental protection

Packaging/used appliance



Dispose of packaging in an environmentally-responsible manner.

The following Do's and Don'ts provide a framework for the return and recycling of used products when available in your area.

Do's

- Hand over the old/discarded electronic equipment only to authorized collection centers for disposal
- Consult the authorized service center as to whether the Electronic Equipment can be repaired or not, before discarding
- Consult the retailer about appliance take back schemes

Don'ts

- Don't dump the discarded Electronic Equipment in the open or in any land fill site, as this will result in contamination of the soil and the ground water
- Don't dispose of the discarded Electronic Equipment in household bins or Municipal bins
- The product is not meant for re-sale to any unauthorized agencies/scrap dealers
- Don't keep any replaced spare part(s) from the product in an exposed area

Tips on economical use

- Always fill the appliance with the maximum amount of laundry for each programme.
- Wash normally soiled laundry without a prewash.
- Save energy and detergent when washing lightly and normally soiled laundry.
→ *"Detergent" on page 24*
- The selectable temperatures apply to the care labels on the textiles. The temperatures in the machine may deviate from this so that you get the optimum mix of energy-saving and washing results.
- **Information about the energy consumption*:**
The display provides information about the relative energy consumption in the selected program.
The more indicator lights light up, the higher the program's consumption.
This enables you to compare the consumption levels of the different programs when choosing your program settings and to decide on an energy- and water-saving program setting for the selected program.
- **Low power mode:** If the appliance is not operated for a prolonged period (approx. 5 minutes), the display panel lighting goes out before the programme starts and after the programme has ended,  flashes. Select any button to activate the display backlighting.
Low power mode is not be activated when the programme is running.
- If the laundry is subsequently dried in a tumble dryer, select the spin speed according to the tumble dryer manufacturer's instructions.

* depending on the model



Positioning and connecting

Standard accessories

Note: Check the appliance for transport damage. Never use a damaged appliance. If you have any complaints, contact the dealer from whom you purchased the appliance or our Customer Service.

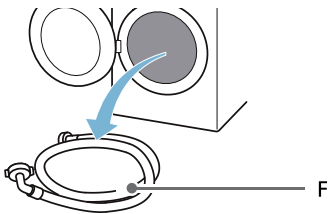
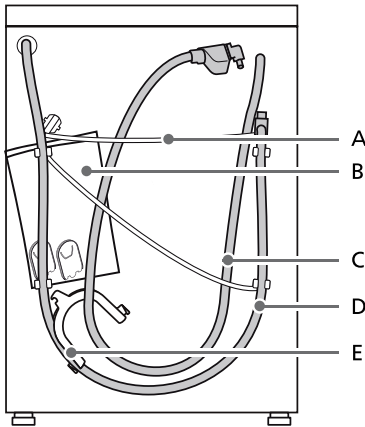

- A Mains lead
- B Bag
 - Installation and operating instructions
 - Customer Service location directory*
 - Warranty*
 - Supplementary sheet for the installation and operating instructions*
 - Cover caps for openings after the transport braces have been removed
 - Home Connect Installation Guides*
- C Water inlet hose on aquaStop models
- D Water outlet hose
- E Elbow for securing the water outlet hose*
- F Cold water inlet hose on Standard/Aqua-Secure models
- * Depending on the model

In addition, a hose clamp (24 - 40 mm diameter, available from specialist retailers) is required to connect the water outlet hose to a siphon.

Useful tool

- Spirit level for aligning
- Wrench with:
 - WAF13 for loosening the transport braces and
 - WAF17 for aligning the appliance feet → *Page 17*

Safety instructions

Warning

Risk of injury!

- The washing machine is very heavy. Be careful when lifting/transporting the washing machine.
- When the washing machine is lifted by its protruding parts (e.g. the washing machine door), the components may break off and cause injuries. Do not lift the washing machine by protruding parts.
- If the hose and mains cables are not routed properly, there is a risk of tripping and injury. Lay hoses and cables in such a way that there is no risk of tripping.

Caution!

Damage to the appliance

Frozen hoses may rip/burst. Do not install the washing machine in areas exposed to frost or outdoors.

Caution!

Water damage

The connection points for the water supply hose and water drain hose are under high water pressure. To prevent leaks and water damage, you must follow the instructions in this section.

Notes

- In addition to the safety information listed here, the local water and electricity supplier may have special requirements.
- If in doubt, have the appliance connected by a specialist.

Installation surface

Note: The washing machine must be aligned in a stable manner so that it does not move around.

- The installation surface must be firm and level.
- Soft floors/floor coverings are not suitable.

Installation on a base or a wooden joist floor

Caution!

Damage to the appliance

The appliance may "wander" and tip/topple from the base when spinning. The feet of the appliance must be secured with holding brackets. Order no. WMZ 2200, WX 975600, CZ 110600, Z 7080X0.

Note: On wooden joist floors, install the appliance:

- In a corner, if possible,
- On a water-resistant wooden board (min. 30 mm thick) which is screwed tightly to the floor.

Installation on a platform with drawer*

Platform order no.: WMZ 20490, WZ 20490, WZ 20510, WZ 20520.

Installing the appliance in a kitchenette

Warning

Risk of death!

There is a risk of electric shock if you touch live components. Do not remove the appliance covering plate.

Notes

- Recess width of 60 cm required.
- Only install the washing machine underneath a continuous worktop that is securely connected to adjacent cabinets.

* Depending on the model

Removing the transport locks

Caution!

Damage to the appliance

- The machine is secured for transportation using transport locks. If the transport locks are not removed, the machine may become damaged when it is operated. Before using the appliance for the first time, make sure that you completely remove all four transport locks. Keep the locks in a safe place.
- To prevent transport damage from occurring if the appliance is moved at a later date, you must refit the transport locks before transporting the appliance.

Note: Keep the screws and sleeves in a safe place.

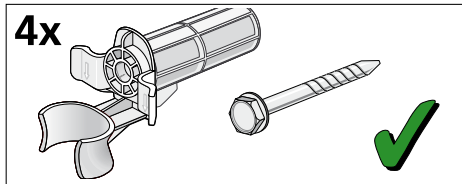

1. Take the hoses out of the holders.

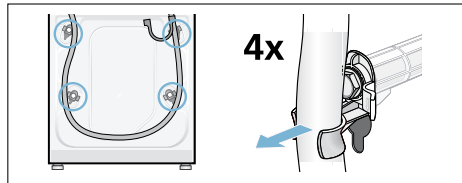

2. Unscrew and remove all four transport brace screws. Remove the sleeves. To do this, remove the mains cable from the holders.

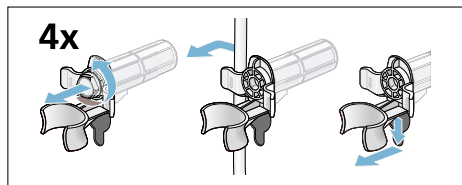

3. Fit the covers. Lock the covers firmly in place by applying pressure to the snap-in hooks.

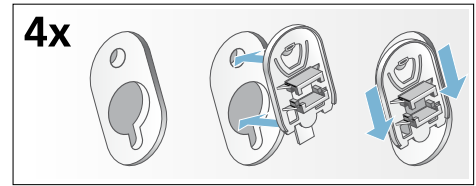

Removing the support struts

1. Unscrew and remove all screws in the vertical transport struts.

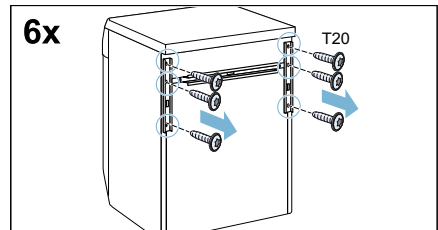

2. Remove the transport struts.

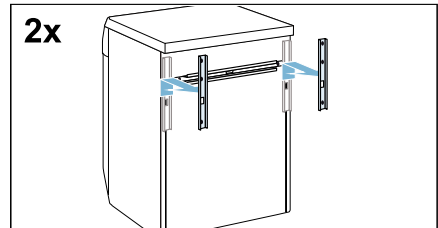

3. Undo and remove the screws on the horizontal transport strut.

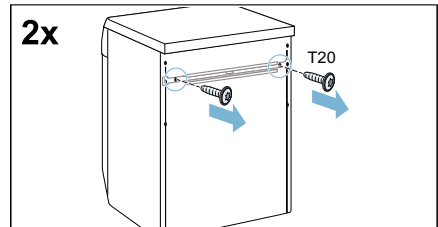

4. Remove the transport strut.

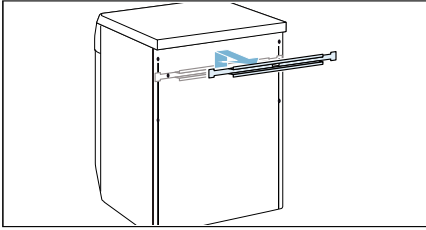

Hose and cable lengths

■ Left-hand connection

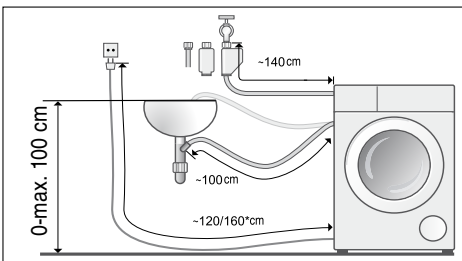

■ Right-hand connection

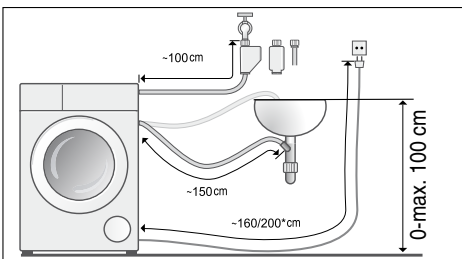

*depending on the model

Tip: If the supply hose is too short for your connection, you can order an extension from the after-sales service.

Water inlet

⚠ Warning **Risk of death!**

There is a risk of electric shock if you touch live components.

Observe the following when connecting the machine:

Notes

- Only operate the washing machine using cold mains water.
- Do not connect the machine to the mixer tap of an unpressurised hot-water boiler.
- Do not use a used supply hose. Only use the supply hose supplied with the machine or one that was purchased from an authorised retailer.
- Do not bend, squash, modify or cut through the water supply hose (otherwise its strength is no longer guaranteed).
- Only tighten the screw connections by hand. If the screw connections are tightened too much with a tool (pliers), the thread may be damaged.

Optimum water pressure in the supply network

At least 0.1 MPa (1 bar)

Maximum 1 MPa (10 bar)

When the tap is open, the water flow is at least 8 l/min.

If the water pressure is higher than this, a pressure-reducing valve must be installed.

Connection

1. Connect the water supply hose to the water tap ($\frac{3}{4}$ " = 26.4 mm) and to the appliance:

- Model: **Standard**

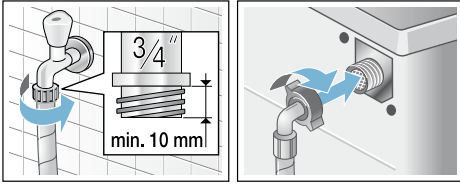

- Model: **Aqua-Secure**

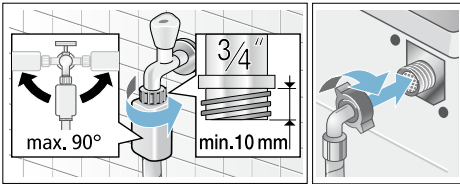

- Model: **Aqua-Stop**

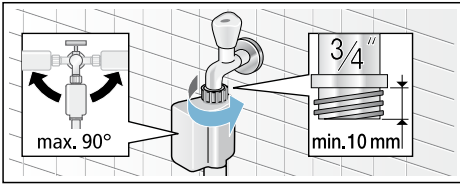

Tip: Connect also an external water filter (depending on the model) between water supply hose and tap. The filter filters dirt particles out of the water. Water filter must be cleaned regularly to remove contaminants. This will prevent blockages. See also → separate installation and cleaning instruction for water filter.

2. Open the water tap carefully, checking the leak tightness of the connection points. The screw connection is under mains water pressure.

Water outlet

Caution!

Water damage

When water is being pumped away, the outlet hose is under water pressure and may slip out of the wash basin or connection point.

Secure the outlet hose so that it cannot slip out.

Note: Do not kink the water drain hose or put strain on it lengthways.

You can lay the water drain hose as follows:

- **Outlet in a sink**

Warning **Risk of scalding!**

When you are washing at high temperatures, there is a risk of scalding if you come into contact with hot water e.g. if hot water is being drained into a wash basin. Do not reach into the hot water.

Caution!

Damage to the appliance/fabrics

If the end of the drain hose is immersed in the drained water, water may be sucked back into the appliance and may damage the appliance/fabrics.

Make sure that:

- The plug does not block drainage from the sink.
- The end of the drain hose is not immersed in the drained water.
- The water drains away quickly enough.

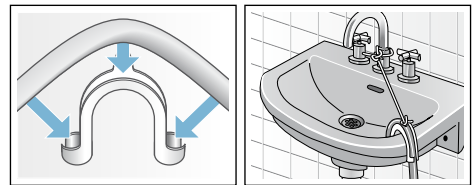

■ Drainage into a siphon

The connection point must be secured using a hose clamp with a diameter of 24-40 mm (available from specialist dealers).

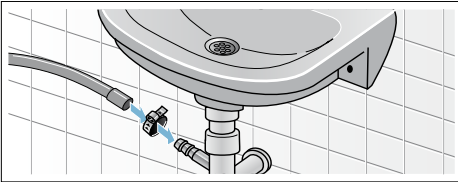

■ Outlet into a plastic pipe with rubber bushing or into a drainage pit

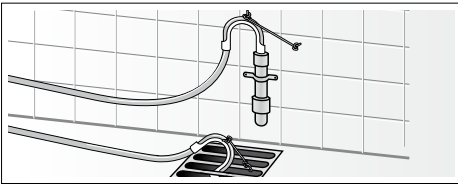

Levelling

Level the appliance using a spirit level. Incorrect levelling may result in intense noise, vibrations and "wandering".

1. Loosen the lock nuts using a wrench, by turning it in a clockwise direction.
2. Check the alignment of the washing machine with a spirit level, and adjust it if necessary. Change the height by turning the appliance feet. All four appliance feet must stand firmly on the ground.
3. Tighten the lock nut against the housing.
In doing so, hold the foot tight and do not adjust its height. The lock nuts on all four appliance feet must be screwed tightly against the housing.



Electrical connection

Warning **Risk of death!**

There is a risk of electric shock if you touch live components.

- Never touch or hold the mains plug with wet hands.
- Only pull out the mains cable by the plug and never by the cable, as this could damage it.

Observe the following information and ensure that:

Notes

- The mains voltage and voltage indicated on the appliance (rating plate) are the same. The connected load and fuse required are specified on the rating plate.
- The appliance is only connected to an alternating current via a properly installed earthed socket.
- The mains plug fits the socket.
- The earthing system is properly installed.
- The mains cable is only replaced by a qualified electrician (if this is necessary). Replacement mains cables are available from the after-sales service.
- No multiple plugs/couplings or extension cables are used.
- If an earth-leakage circuit breaker is used, only a type which displays this symbol is used: . Only this symbol guarantees compliance with the currently applicable regulations.
- The mains plug can be accessed at all times.
- The mains cable is not bent, squashed, modified, cut through, or in contact with heat sources.

Before washing for the first time

The washing machine was thoroughly tested before leaving the factory. To remove any water that may be left over from the test, run the first wash cycle **without** any laundry.

Notes

- The washing machine **must be correctly installed and connected** → *Page 12*
 - Never use a damaged machine. Inform customer services.
1. Check the machine.
 2. Remove the protective film from the control panel.
 3. Connect the mains plug.
 4. Turn on the tap.
 5. Close the door (do not load any laundry).
 6. Depending on the model, run the **Drum Clean 90 °C** or **Cottons 90 °C** program. For AU variant, two cycles of **Cottons 90 °C** programme without laundry are required to be run at initial setup, and this operation only needs to be completed once.
 7. Open the detergent drawer.
 8. Pour approximately 1 litre of water into compartment **II**.
 9. Pour standard detergent into compartment **II**.
Note: To prevent foaming, only use half the amount of detergent recommended by the detergent manufacturer. Do not use detergent designed for wool or delicates.
 10. Close the detergent drawer.
 11. Press the  Start/Reload button.
 12. When the program ends, switch off the appliance.

Your washing machine is now ready to use.

Transportation

e.g. when moving home

Preparatory work:

1. Turn off the water tap.
2. Reduce the water pressure in the supply hose.
Maintenance – filter in the water supply → *Page 40*
3. Disconnect the washing machine from the main plug.
4. Drain the remaining detergent solution.
Maintenance – detergent solution pump blocked → *Page 39*
5. Remove the hoses.

Installing the transport locks:

1. Remove the covers and keep them in a safe place.
Use a screwdriver if necessary.

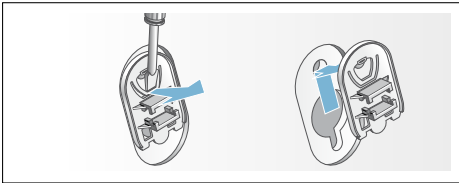

2. Insert all four sleeves.
Clip the mains cable securely in the holders. Insert and tighten the screws.

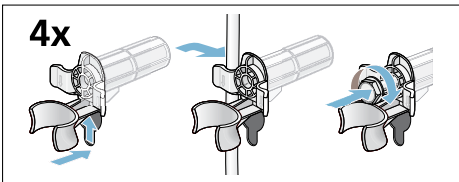

Before switching on the appliance again:

Notes

- The support struts **must** be removed.
- The transport locks **must** be removed. → *"Removing the transport locks" on page 14*
- To prevent unused detergent from flowing straight into the drain during the next wash: Pour approx. 1 litre of water into compartment **II** and start the **Spin** program.

Getting to know the appliance

Appliance

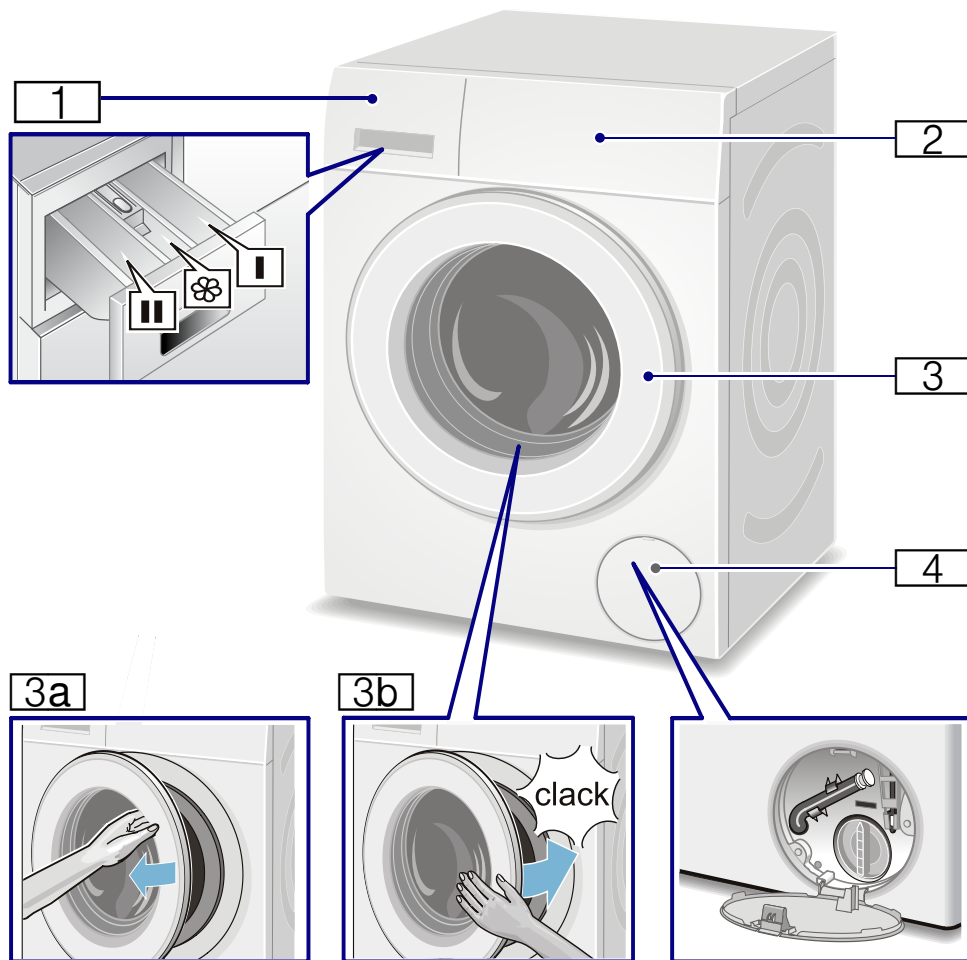

- 1** Detergent dispenser
- 2** Control panel
- 3** Door

- 3a** Open the door
- 3b** Close the door
- 4** Service flap

Control panel

You can find possible programme default settings and additional programme settings in the overview; these differ depending on the model.

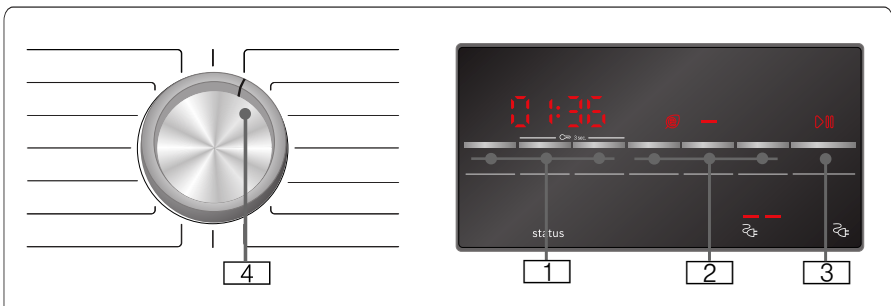
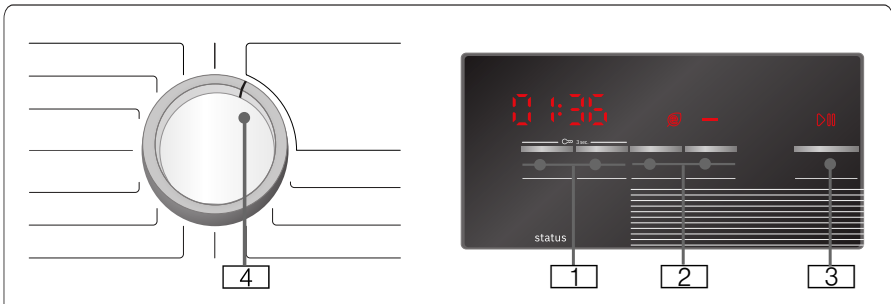

- 1 **Programme default settings** can be changed.
Overview of all programme default settings → *Page 30*
- 2 **additional programme settings** can be selected.
Overview of all additional programme settings → *Page 31*
- 3 **Start button** for starting, interrupting, (e.g. adding laundry) and cancelling a programme.
- 4 **Programme selector** for selecting the programme and for switching the washing machine on and off.

Display panel

In the table you can find possible settings and information in the display panel; these differ depending on the model.

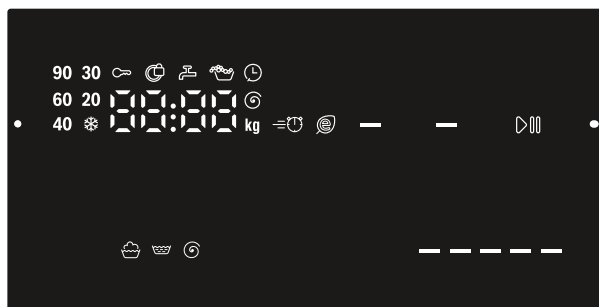







Settings for the selected programme

* - 90*	Temperature in °C	Temperature
----, 0 - 1400*	Spin speed in rpm (revolutions per minute)	Maximum spin speed or ---- (Rinse stop = no final drain, washing remains in the water after the last rinse)
1:30	Programme length	Depends on the programme selection in h: min (hours: minutes)
1 - 24	Finish in h (hours)	End of programme after ... Hours
10 kg	Load in kg	Maximum load

* Depending on the model

Status indicators for the programme progress (programme sequence)

 ,  , End		Wash, rinse, spin/drain, programme end.
	Childproof lock	Lights up: The childproof lock is activated. Flashes: The childproof lock is activated, and if the programme selector has been adjusted or the buttons have been pressed.
	Door lock	Lights up: When the door can not be opened.
	Tap	Lights up: Water pressure is too low. This extends the programme duration. Flashes: The tap has not been turned on or there is no water supply.
	Overdosage	On if too much foam detected, one additional rinse cycle switched on.
---- 		Power consumption.

* Depending on the model



Laundry

Prepare the laundry

Caution!

Damage to the appliance/fabrics

Foreign objects (e.g. coins, paperclips, needles, nails) may damage the laundry or components in the washing machine.

You should therefore note the following tips when preparing your laundry:

- Empty any pockets.

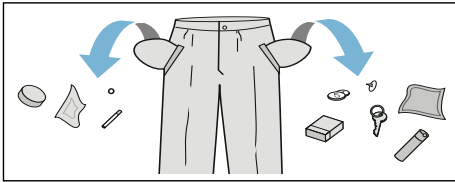

- Look out for metal items (paperclips, etc.) and remove them.
- Wash delicates in a laundry bag (tights, underwired bras, etc.).
- Close any zips; button up any cover buttons.
- Brush sand out of pockets and collars.
- Remove curtain fittings or place curtains in a laundry bag.

Sorting laundry

Sort your laundry according to the care instructions and manufacturer's information on the care labels, depending on:

- Type of fabric/fibre
- Colour

Note: Laundry may discolour. Wash white and coloured items separately. Wash new coloured items separately the first time you wash them.







- Soiling

Wash laundry with the same level of soiling together.

Some examples of soiling levels can be found in the chapter

- **Light:** Do not need to pretreat, select the  **Speed** setting if necessary.
- **Normal**
- **Heavy:** Load less laundry, need to pretreat or soak laundry firstly.
- **Stains:** Remove/pretreat stains while they are fresh. First dab with soapy water; do not rub. Then wash the items of laundry with the appropriate programme. Stubborn or dried-in stains can sometimes only be removed by washing several times.

- Symbols on the care labels

-  Suitable for normal washing process; e.g. Cottons programme
-  A gentle washing process is required; e.g. Easy-Care programme
-  An especially gentle washing process is required; e.g. Delicates/Silk programme
-  Suitable for washing by hand; e.g.  Wool programme
-  Do not machine wash.

Starching

Note: Laundry should not be treated with fabric softener.

Liquid starch can be used to stiffen fabrics particularly in the Rinse and Cottons programmes. Measure starch into compartment  in accordance with the manufacturer's instructions (clean first if necessary).

Dyeing/bleaching

Dye should only be used in normal household quantities. Salt may damage stainless steel. Always follow the dye manufacturer's instructions.

Do **not** use the washing machine to bleach clothes.

Detergent

Correct selection of detergent

The care label is crucial to ensure correct detergent selection, temperature and laundry treatment.

- **Standard detergent with optical brighteners**
suitable for heat-resistant white washing made from linen or cotton
Programme: Cottons/
cold – max. 90 °C
- **Detergent for colours without bleach or optical brighteners**
suitable for coloured washing made from linen or cotton
Programme: Cottons/
cold – max. 60 °C
- **Detergent for colours/delicates without optical brighteners**
suitable for coloured laundry made from easy-care fibres, synthetic fibres
Programme: Easy-Care/
cold – max. 60 °C
- **Detergent for delicates**
suitable for delicate, fine fabrics, silk or viscose
Programme: Delicates/Silk/
cold – max. 40 °C
- **Detergent for woollens**
suitable for woollen fabrics
Programme:  Wool/
cold – max. 40 °C



Saving energy and detergent

For light and normal soiling, you can save energy (lower washing temperature) and detergent.

Saving	Soiling/note
<p>Reduced temperature and detergent quantity as per the recommended dosage</p> 	<p>Light No visible dirt or stains. Clothing has taken on some body odour, e.g.:</p> <ul style="list-style-type: none"> ■ Light summer/sports clothing (worn for a few hours) ■ T-shirts, shirts, blouses (worn for up to one day) ■ Guest bed linen and hand towels (used for one day) <hr/> <p>Normal Visible dirt or a few light stains, e.g.:</p> <ul style="list-style-type: none"> ■ T-shirts, shirts, blouses (sweat soaked, worn a few times) ■ Towels, bedding (used for up to one week)
<p>Temperature as per the care label and detergent quantity as per the recommended dosage for heavy soiling</p>	<p>Heavy Dirt and/or stains clearly visible, e.g. tea towels, baby items, work clothing</p>

Note: When measuring the amount of all detergents/additives/care products and cleaning agents, please always check the manufacturer's instructions and information.

Overview of programmes

Programme/Type of washing	Options/Information
<p>Name of the programme Brief explanation of the programme and for which fabrics it is suitable.</p>	<p>Max. load * as kg depending on the model and the programme</p> <p>selectable temperature as °C depending on the model and the programme</p> <p>selectable spin speed in rpm, depending on the model and the programme</p> <p>possible additional programme settings, depending on the model and the programme</p> <p>softener</p>
<p>Cottons Hard-wearing fabrics, heat-resistant fabrics made of cotton or linen.</p>	<p>Max. 10.0 kg/5.0** kg</p> <p>✳ - 90 °C</p> <p>---, 400 - 1400 rpm</p> <p>≡⌚ Speed, Ⓞ Eco, ≡ Soaking,  Rinse Plus</p> <p>possible</p>
<p>Mixed Load Mixed load of cottons and synthetic fabrics.</p>	<p>Max. 4.0 kg</p> <p>✳ - 40 °C</p> <p>---, 400 - 1400 rpm</p> <p>≡⌚ Speed, Ⓞ Eco, ≡ Soaking,  Rinse Plus</p> <p>possible</p>
<p>Easy-Care Textiles made of synthetic materials or blended fabrics.</p>	<p>Max. 4.0 kg</p> <p>✳ - 60 °C</p> <p>---, 400 - 1200 rpm</p> <p>≡⌚ Speed, Ⓞ Eco, ≡ Soaking,  Rinse Plus</p> <p>possible</p>
<p>* Max load according to the model and programme. ** Reduced load with ≡⌚ Speed programme additional setting</p>	

Programme/Type of washing	Options/Information
<p>Delicates/Silk</p> <p>For delicate, washable textiles, e.g. made of silk, satin, synthetic fibres or blended fabrics (e.g. silk blouses, silk scarf).</p> <p>Note: Use a detergent suitable for appliance-washing delicates or silk.</p>	<p>Max. 2.0 kg</p> <p>✳ - 40 °C</p> <p>---, 0 - 800 rpm</p> <p>≡⌚ Speed, 🌿 Eco, 🛏 Soaking, 👑 Rinse Plus</p> <p>possible</p>
<p> Wool</p> <p>Hand or appliance-washable wool or rich-wool textiles. Especially gentle wash program to prevent shrinkage, longer program pauses (textiles rest in wash liquor).</p> <p>Notes</p> <ul style="list-style-type: none"> ■ Wool is of animal origin, e.g.: Angora, alpaca, llama, sheep. ■ Use a detergent that is suitable for appliance-washing wool. 	<p>Max. 2.0 kg</p> <p>✳ - 40 °C</p> <p>---, 0 - 800 rpm</p> <p>-</p> <p>possible</p>
<p>Jeans</p> <p>Program suitable for washing Jeans and other dark color textiles made of cotton or synthetic textiles.</p>	<p>Max. 3.5kg</p> <p>✳ - 40 °C</p> <p>---, 400 - 1200 rpm</p> <p>≡⌚ Speed, 🌿 Eco, 🛏 Soaking, 👑 Rinse Plus</p> <p>possible</p>
<p>Rinse</p> <p>For rinsing with a subsequent spin cycle.</p>	<p>-</p> <p>-</p> <p>---, 0 - 1400 rpm</p> <p>👑 Rinse Plus</p> <p>possible</p>
<p>Spin</p> <p>For spinning with a selectable spin speed and subsequent draining. Only to be emptied, set spin speed to 0.</p>	<p>-</p> <p>-</p> <p>0 - 1400 rpm</p> <p>-</p> <p>not possible</p>
<p>* Max load according to the model and programme.</p> <p>** Reduced load with ≡⌚ Speed programme additional setting</p>	

Programme/Type of washing	Options/Information
<p>Drum Clean</p> <p>Special program for drum hygiene or fluff removal. Do not load any laundry.</p> <p>90°C = antibacterial program. 40°C = antibacterial program, special drum cleaning detergent can be used.</p> <p>* = no antibacterial programme, to remove hair or fluff from the tub.</p> <p>Notes</p> <ul style="list-style-type: none"> ■ Switching the drum-clean information signal on/off. ■ Select 90°C antibacterial program, always follow the manufacturer's instructions when dosing the detergent. ■ This programme can not be interrupted. 	<p>Max. 0.0 kg</p> <p>* , 40°C, 90 °C</p> <p>1200 rpm</p> <p>-</p> <p>not possible</p>
<p>Night Wash</p> <p>Program special designed for washing at night with lower machine noises. Suitable for mixed textiles..</p>	<p>Max. 4.0 kg</p> <p>* - 40 °C</p> <p>---, 400- 1400 rpm</p> <p>⇒ Speed, Eco, Soaking, Rinse Plus</p> <p>possible</p>
<p>Down Wear</p> <p>Appliance-washable items stuffed with synthetic fibres, such as pillows, quilts and bedspreads; also suitable for items stuffed with down.</p> <p>Note: Wash large items separately. Use a detergent designed for delicates and follow the instructions on the item's care label. Use detergent sparingly.</p>	<p>Max. 2.0 kg</p> <p>* - 60 °C</p> <p>---, 400 - 1200 rpm</p> <p>⇒ Speed, Eco, Rinse Plus</p> <p>not possible</p>
<p>Allergy+</p> <p>Special programme for using clothing disinfectant, suitable for mixed load consisting of textiles made of cotton and synthetics.</p> <p>Notes</p> <ul style="list-style-type: none"> ■ Please don't use ☹ Finished In When you select this programme, and start the programme immediately after you add disinfectant. ■ Please use antibacterial detergent/disinfectant in dispenser I and add regular front load detergent powder in dispenser II. 	<p>Max. 4.0 kg</p> <p>* - 40 °C</p> <p>---, 400 - 1400 rpm</p> <p>⇒ Speed, Eco, Soaking, Rinse Plus</p> <p>possible</p>
<p>* Max load according to the model and programme.</p> <p>** Reduced load with ⇒ Speed programme additional setting</p>	

Programme/Type of washing	Options/Information
<p>Kidswear</p> <p>Suitable for washing soiled babies / kids clothes made of cotton, effectively removing bacteria.</p>	<p>Max. 6.5 kg</p> <p>✳ - 60 °C</p> <p>----, 400 - 1400 rpm</p> <p>≡⌚ Speed, 🌿 Eco, 🛏 Soaking, 👑 Rinse Plus</p> <p>possible</p>
<p>Sportswear</p> <p>Weatherproof and outdoor clothing with membrane coating and water-resistant textiles.</p>	<p>Max. 1.0 kg</p> <p>✳ - 40 °C</p> <p>400 - 800 rpm</p> <p>≡⌚ Speed, 🌿 Eco, 👑 Rinse Plus</p> <p>not possible</p>
<p>SuperQuick 15'</p> <p>For less soiling and low load capacity, e.g., daily changing laundry or new laundry.</p>	<p>Max. 2.0 kg</p> <p>✳ - 40 °C</p> <p>----, 400 - 1200 rpm</p> <p>-</p> <p>possible</p>
<p>* Max load according to the model and programme.</p> <p>** Reduced load with ≡⌚ Speed programme additional setting</p>	

P+ Programme default settings

Note: You can find possible programme default settings in the overview; these differ depending on the model.

The programme default settings for all programmes are preset at the factory and are displayed in the display panel after the programme is selected.

Temperature

(🔊 Temperature)

Setting depending on the model

Depending on what stage the program is in, you can change the set temperature before and at the beginning of the program.

The maximum temperature that can be set depends on the program that has been selected.

Spin Speed

((🌀 rpm))

Depending on what stage the program is in, you can change the spin speed (in rpm; revolutions per minute) before and during the program.

Setting 0: The rinsing water is drained but there is no final spin. The laundry stays wet inside the drum, e.g. for items that should not be spun.

Setting - - - -: (Rinse Stop) = no final spin. The laundry stays in the water after the final rinse.

You can select "Rinse Stop" to prevent creasing if the laundry will not be taken out of the washing machine immediately after the program has ended.

To continue/end the program
→ Page 36

The maximum speed that can be set depends on the model and program that has been selected.

Finish in time

(🕒 Finished In)

Before starting the program, you can preselect the program end ("Ready in" time) in hourly increments (h = hour) up to a maximum of 24 hours.

To do this:

1. Select a program.
The program duration is displayed for the selected program, e.g. **2:30** (hours:minutes).
2. Press the 🕒 **Finished In** button repeatedly until the required number of hours is displayed.
3. Press the ▶🔊 Start/Reload button.
The door will be locked.
The selected number of hours (e.g. **8 h**) is shown in the display panel and counts down until the wash program starts. The duration of the program is then displayed.

During the timer count-down, you can change the preselected number of hours as follows:

1. Press the ▶🔊 Start/Reload button.
2. Use the 🕒 **Finished In** button to change the number of hours.
3. Press the ▶🔊 Start/Reload button.

During the timer count-down, you can add or remove laundry as required:

1. Press the ▶🔊 Start/Reload button.
2. Open the door and add or remove laundry.
3. Close the door.
4. Press the ▶🔊 Start/Reload button.

Note: The length of the program is automatically adjusted when the program is running.

Certain factors can affect the program length, e.g.:

- Program settings,
- Detergent dosage (additional rinse cycles if required due to foaming),
- Load size/type of textiles (longer washing for higher load and for textiles which absorb more water),
- Imbalances (e. g. due to fitted sheets) are offset with several start-ups of spin cycles,
- Fluctuations in power supply,
- Water pressure (infeeding speed).

P+ Additional programme settings

Note: You can find possible additional programme settings in the overview; these differ depending on the model.

Speed/Eco

(≡🔄/🌱 Speed/Eco)

Button with two possible settings for adapting the selected programme:

- ≡🔄 **Speed**
Washing in a shorter time while achieving a washing result that is consistent with, but uses more energy than, the selected programme, without the Speed/Eco setting.
Note: Do not exceed the maximum load.
- 🌱 **Eco**
Energy-optimised washing by reducing the temperature while achieving a washing result that is consistent with the selected programme, without the Speed/Eco setting.

Select the button to do this. First of all, you can select the ≡🔄 **Speed** setting. If you select the button again, the 🌱 **Eco** setting is active. The respective symbol is shown in the display when the setting is activated.

If you select the button again, no setting is active.

Rinse Plus

(👑 Rinse Plus)

Additional rinse cycle depending on the programme; longer programme length for particularly sensitive skin and/or for areas with very soft water.

Soak

(👉 Soaking)

Before the main wash cycle starts, the washing remains for longer in the water to partially dissolve intensive soiling.

Notes

- Put detergent in dispenser **I** before starting the appliance.
- Load laundry of the same colour.
- If your appliance does not have this additional programme setting, you can soak as follows:
 1. Put detergent in dispenser **II** before starting the appliance.
 2. Select the **Cottons 40 °C** programme and the ▷||| **Start/Reload** button.
 3. Select the ▷||| **Start/Reload** button after approx. 10 minutes. The laundry remains in the soaking solution.
 4. Leave the laundry to soak for as long as required, then either select the ▷||| **Start/Reload** button again to continue the programme or change the programme.

Operating the appliance

Note: Install and connect washing machine properly.

Before the 1st wash → *Page 18*

Preparing the washing machine

Notes

- Never switch on a damaged washing machine!
 - Inform customer service!
1. Connect the mains plug.
 2. Turn on the tap.
 3. Open the door.
 4. Check that the drum is completely emptied. Empty if necessary.

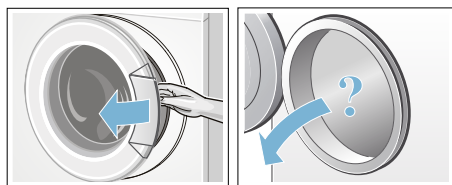

Select programme/switch on the appliance

Note: If you have activated the childproof lock, you must first deactivate it before you can set a program.

Use the program selector to select the required program. Can be rotated in either direction.

The appliance is switched on.

The **program default settings** for the selected program appear in the display panel:

- Temperature*,
- Spin speed*,
- The maximum load and the duration of the program (alternately),
- Energy consumption*.

*depending on the model

Change the programme default settings

You can use the default settings or change them.

To do this, repeatedly select the corresponding button until the required setting is displayed.

The settings are activated without needing to be confirmed.

They are not saved when the appliance is switched off.

Programme default settings

→ *Page 30*

Overview of programmes

→ *Page 26*

Select additional programme settings

By selecting additional settings, you can better adapt the washing process to your items of laundry.

The settings can be selected or deselected depending on the programme progress.

The indicator lamp for the button lights up if a setting is active.

The settings are not saved when the appliance is switched off.

Additional settings → *Page 31*

Overview of programmes → *Page 26*

Placing laundry into the drum

Warning **Danger of death!**

Items of laundry pretreated with cleaning agents that contain solvents, e.g. stain remover/cleaning solvent, may cause an explosion after being loaded into the washing machine. Hand-rinse items of laundry thoroughly beforehand.

Notes

- Mix items of laundry of varying sizes. Laundry items of different sizes distribute themselves better during the spin cycle. Individual items of laundry may lead to imbalances.
- Observe the specified maximum load. Overfilling has a negative impact on the washing result and promotes creasing.

1. Place presorted items of laundry unfolded in the washing drum.
2. Make sure that no items of laundry are trapped between the washing machine door and the rubber seal, and close the door.



The  Start/Reload button indicator lamp flashes to indicate that the washing program can be started. It is possible to change the settings.

Measure and add detergent and care products

Caution!

Damage to the appliance!

Detergents and agents for the pretreatment of laundry (e.g. stain remover, prewash sprays, etc.) may damage the surfaces of the appliance. Keep these agents away from the surfaces of the appliance. Using a damp cloth, immediately remove any fine spray residue and other residue or droplets.

Dosing

Dose the detergents and care products according to:

- water hardness (ask your water supply company),
- the manufacturer's specifications on the packaging,
- the amount of laundry,
- soiling.

Filling the dispensers

1. Pull out the detergent drawer.



Warning **Eye / skin irritation!**

If the detergent drawer is opened while the appliance is running, detergent or care product may run out.



Open the drawer carefully.

If detergent or care product comes into contact with eyes or skin, rinse thoroughly.

If accidentally swallowed, seek medical advice.

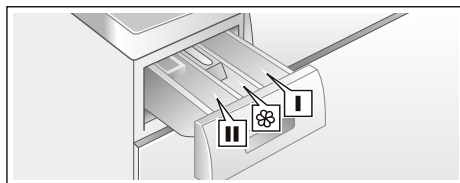
2. Pour in detergent and/or cleaning product.



- Dispenser I  Clothing disinfectant. (**Disinfectant** additional programme setting or **Disinfectant** programme is selected only.)
- Dispenser  Softener. Do not exceed the maximum load.
- Dispenser II  Detergent for main wash, liquid detergent.

Notes

- Dilute viscous fabric softener and fabric conditioner with water. This will prevent blockages.
- Be careful when opening the detergent drawer while the appliance is running.

Starting the programme

Press the  Start/Reload button. The indicator lamp lights up and the program starts.

The display panel shows the Ready in time while the program is running or the program duration and the program progress symbols once the wash cycle has started.

Note: Foam detection

If the  symbol also lights up in the display panel, the washing machine has detected too much foam during the wash cycle and automatically activated additional rinse cycles to remove the foam.



Add less detergent to the next wash cycle with the same load.



If you want to lock the program to prevent it from being inadvertently adjusted, you can select the childproof lock as follows.

Childproof lock

(≈ 3sec.)

You can lock the washing machine to prevent the functions you have set from being changed inadvertently. To do this, **activate the childproof lock when the program has started.**

To **activate/deactivate**, press and hold the  **rpm** and  **Finished In** buttons at the same time after the washing program has started. Keep pressing the two buttons for approx. three seconds. The  symbol appears in the display panel.

-  lights up: The childproof lock is active.
-  flashes: The childproof lock is active and the program selector has been adjusted. To deactivate the childproof lock, reset the program selector to the initial program. The symbol lights up again.

Note: To avoid the program to terminate, do not turn the program selector beyond the Off position.

Note: The childproof lock remains active after the program has ended and the appliance is switched off. You must always deactivate the childproof lock if you want to start a new program.



Adding/removing laundry

Following the start of the program, you can add or remove laundry as required.

Press the  Start/Reload button to do this.

The  Start/Reload button indicator lamp flashes and the machine checks whether it is possible to add laundry.

If the following appears in the display panel:

- The  symbol disappears: adding laundry is possible.
- The  symbol lights up: it is not possible to add laundry.

To continue the program, press the button  Start/Reload. The program continues automatically.

Notes



- Do not leave the door open for too long when adding laundry as water from the laundry may leak out.
- For safety reasons, the door remains locked when the water level or temperature is high, or while the drum is turning, and it is not possible to add laundry during this time.
- The load display is not active during reloading.

Changing the programme



1. Press the  Start/Reload button.
2. Select another program.
3. Press the  Start/Reload button. The new program starts from the beginning.

Cancel the programme



For programs at high temperature:

1. Press the  Start/Reload button.
2. To cool down laundry: Select **Rinse**.
3. Press the  Start/Reload button.

For programs at low temperature:

1. Press the  Start/Reload button.
2. Select **Spin**.
3. Press the  Start/Reload button.

Programme end during rinse hold

----  appears in the display panel and the indicator lamp of the  Start/Reload button flashes.

Continue the program by:

- Pressing the  Start/Reload button (the laundry will be drained with the default spin speed setting*) or
- Selecting a spin speed or set the program selector to **Spin** and then pressing the  Start/Reload button.

* depending on the chosen program -> Overview of programmes

Programme end

End appears in the display panel and the indicator lamp of the  Start/Reload button is off.

Removing laundry/switching off the appliance

1. Open the washing machine door and remove the laundry.
2. Turn the programme selector to **Off**. Appliance is switched off.
3. Turn off the tap.
Not required for Aqua-Stop models.
Contents of package

Notes

- Do not leave any items of laundry in the drum. They may shrink in the next wash or discolour another item.
- Remove any foreign objects from the drum and the rubber seal – risk of rusting.

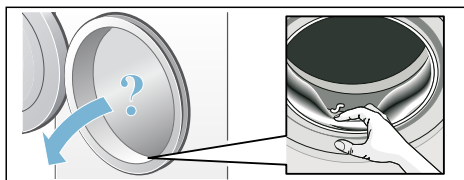

- Leave the washing machine door and detergent drawer open so that any residual water can dry away.
- Always remove the washing.
- Always wait until the programme ends, as the appliance could still be locked. Switch the appliance on and wait for the unlocking device.
- If at the end of the programme the display has gone out, the energy saving mode is active. To activate, select any button.

Setting the signal

You can change the following settings:

- The volume for the information signals (e.g. at the end of the program) and/or
- The volume of the audible button signals.

You will need to activate the setting mode in order to change these settings.

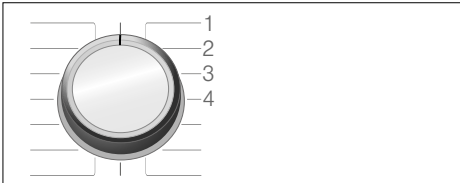

1/2/3/... positions on the program selector

Activate setting mode:

1. Set the program selector to position 1. The washing machine is switched on.
2. Press the  Start/Reload button and, at the same time, turn the program selector clockwise to position 2. Release the button.

The setting mode is activated and the preset volume for the information signals appears in the display panel (e.g. at the end of the program).

Changing the volume

Use the  **Finished In** button to change the following settings at the corresponding program selector positions:

- 2: The volume of the information signals and/or
- 3: The volume of the button signals.



0 = off, 1 = quiet,
2 = medium, 3 = loud,
4 = very loud

Exiting setting mode

You can now end the process and set the program selector to the **Off** position. The settings are saved.



Sensors

Unbalanced load detection system

The automatic unbalanced load detection system detects imbalances and ensures even distribution of the laundry by repeatedly starting and stopping drum spinning.

If the laundry is extremely unevenly distributed, the spin speed is reduced or the spin cycle is not performed for safety reasons.

Note: Place large and small items of laundry evenly in the drum.



Cleaning and maintenance



Warning

Danger of death!

There is a risk of electric shock if you touch live components. Switch off the appliance and unplug the mains plug.



Warning

Risk of poisoning!

Toxic vapours can be produced by cleaning agents that contain solvents, e.g. cleaning solvent. Do not use cleaning agents that contain solvents.

Caution!

Damage to the appliance

Cleaning agents that contain solvents, e.g. cleaning solvent, can damage surfaces and components in the machine. Do not use cleaning agents that contain solvents.

Machine housing/control panel

- Wipe the housing and the control panel with a soft, damp cloth.
- Remove the detergent residue immediately.
- Do not clean with a water jet.

Drum

Use chlorine-free cleaning agents, do not use steel wool.

If there are odours in the washing machine, or to clean the drum, run the **Drum Clean 90 °C** or **Cottons 90 °C** program without laundry. Add washing powder. → "Faults and what to do about them" on page 43

Descaling

Descaling should not be necessary if the detergent is measured out correctly. However, if it is required, follow the manufacturer's instructions for the descaling agent. Suitable descalers can be obtained via our website or from our after-sales service. → Page 45

Detergent drawer and housing

If the detergent drawer contains detergent or fabric softener residues:

1. Pull out the detergent drawer. Press down the insert and fully remove the drawer.
2. To remove the insert: Push the insert upwards from below with your finger.

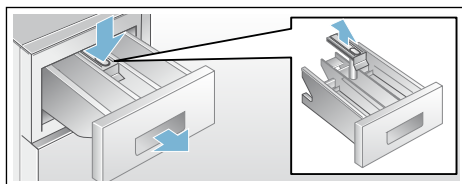

3. Clean the detergent dispenser tray and insert with water and a brush, and dry it. Clean the inside of the housing as well.
4. Fit the insert and lock it in place (push the cylinder onto the guide pin).
5. Push in the detergent drawer.

Note: Leave the detergent drawer open so that any residual water can evaporate.

Detergent solution pump blocked



Warning Risk of scalding!

When you wash at high temperatures, the water gets very hot. If you come into contact with the hot water, you may be scalded.

Allow the water to cool down.

After the water has cooled down:

1. Turn off the water tap so that no more water can flow in and has to be drained via the drain pump.
2. Switch off the appliance.
3. Disconnect the mains plug.
4. Open and remove the service flap.

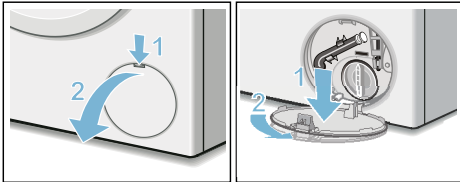

5. Take the drain hose out of the retainer. Remove the sealing cap, allow the water to flow out into a suitable container. Replace the sealing cap and place the drainage hose in the retainer.

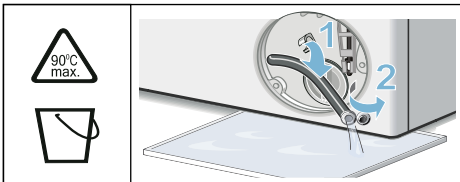

6. Carefully unscrew the pump cover, residual water may leak out. Clean the interior, pump cover thread and pump housing. The impeller in the detergent solution pump must be able to rotate. Refit the pump cover and screw it on tightly. The handle must be in a vertical position.

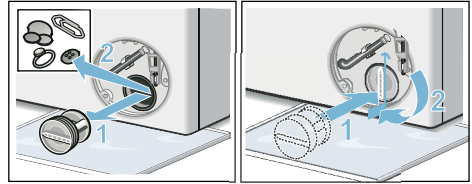

7. Place the service flap back on, lock it into place, and close it.

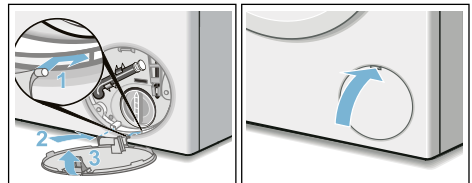

Note: To prevent unused detergent from flowing straight into the drain during the next wash, pour 1 litre of water (without detergent) into compartment **II** and start the **Spin** programme. Do the next wash as usual.

The drain hose at the siphon is blocked

1. Switch off the appliance.
2. Disconnect the mains plug.
3. Loosen the hose clamp. Carefully remove the drain hose; residual water may leak out.
4. Clean the drain hose and siphon connecting piece.

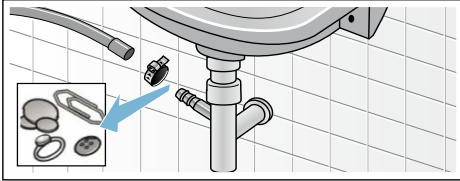

5. Reattach the drain hose and secure the connection using the hose clamp.

Filter in the water supply is blocked

First, reduce the water pressure in the supply hose:

1. Turn off the tap.
2. Select any program (except Spin).
3. Press the Start/Reload button. Allow the program to run for approximately 40 seconds.
4. Turn the program selector to off position.
5. Pull out the mains plug.
6. Clean the filter on the tap: Disconnect the hose from the tap. Clean the filter with a small brush.

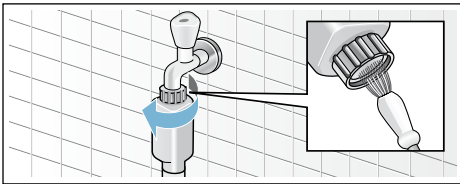

7. For standard and Aqua-Secure models, clean the filter on the rear of the appliance: Remove the hose from the rear of the appliance. Use pliers to remove the filter and then clean it.

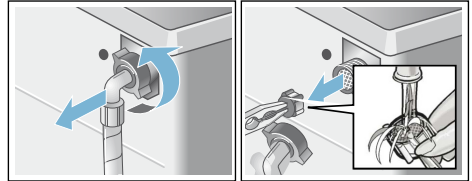

8. Insert the filter, connect the hose and check for leaks.

Faults and what to do about them

Emergency release

(depending on the model)

e.g. in the event of a power outage

Note: The programme will continue running when the power supply has been restored.

Warning

Risk of scalding!

When you are washing at high temperatures, there is a risk of scalding if you come into contact with detergent solution and laundry.

If possible, leave it to cool down.

Warning

Risk of injury!

You may injure your hands if you reach into the drum while it is turning.

Do not reach into the drum when it is turning. Wait until the drum has stopped turning.

Caution!

Water damage



Any escaping water may cause water damage. Do not open the washing machine door if water can be seen through the glass.

If the laundry has to be removed, the washing machine door can be opened as follows:

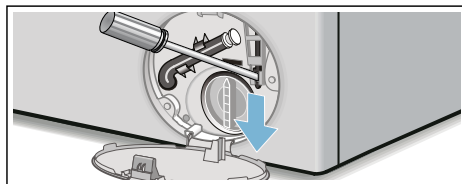
1. Switch off the appliance.
2. Disconnect the mains plug.
3. Drain the water. → *Page 39*
4. Pull the emergency release downwards with a tool and release. The washing machine door can now be opened.





Information on the display panel

Display	Cause/Remedy
	<ul style="list-style-type: none">■ Flashes fast + warning signal: The door was opened and the water level is too high. Close the door, continue the programme with  Start/Reload button or select Spin programme.■ Flashes slowly: The door lock temperature is too high to open the door. Wait approx. 30 seconds until the door lock temperature cools down.
	<ul style="list-style-type: none">■ Flashes (no water supply): Tap turned on? Water inlet filter blocked? Clean the water inlet filter. If an additional water filter has been installed (depending on the model), check for contaminants and clean if required → separate installation and cleaning instruction for water filter. Water hose kinked or blocked?■ Lights up (low water pressure): For information only. This will not affect the programme progress. The programme duration is extended.
E:18	Drain pump blocked; clean the drain pump. Clean the drainage hose on the siphon.
Other displays	Switch off the appliance, wait for five seconds and then switch it on again. If the display appears again, call customer services.

Faults and what to do about them

Faults	Cause/Remedy
Water is leaking from the machine.	<ul style="list-style-type: none"> ■ Attach the drain hose correctly or replace it. ■ Tighten the screw connection of the drain hose.
The machine is not filling with water.	<ul style="list-style-type: none"> ■ Have you pressed the ▷ Start/Reload button? ■ Is the tap turned on?
Detergent is not being dispensed.	<ul style="list-style-type: none"> ■ Could the filter be clogged? Clean the filter → <i>Page 40</i> ■ Note: If an additional water filter has been installed (depending on the model), check for contaminants and clean if required → separate installation and cleaning instruction for water filter. ■ Is the supply hose kinked or trapped?
The door cannot be opened.	<ul style="list-style-type: none"> ■ The safety function is activated. Stop the program? ■ Is the ∞ childproof lock activated? Deactivate. ■ Is “- - -” selected (Rinse Stop = no final drain)? ■ Can the door only be opened by the emergency release?
The program will not start.	<ul style="list-style-type: none"> ■ Have you pressed the ▷ Start/Reload or ⏻ Finished In button? ■ Is the door closed? ■ Is the ∞ childproof lock activated? Deactivate.
The drum briefly jerks or judders after the program has started.	Not a fault – the internal motor test may cause the drum to jerk or judder briefly when the wash program starts.
The water is not draining.	<ul style="list-style-type: none"> ■ Is “- - -” selected (Rinse Stop = no final drain)? ■ Clean the drain pump → <i>Page 39</i> ■ Clean the drain pipe and/or the drain hose.
Water is not visible in the drum.	Not a fault – the water is below the visible area.
The spin result is not satisfactory. Laundry is wet/too damp.	<ul style="list-style-type: none"> ■ Not a fault – the unbalanced load detection system has interrupted the spin cycle because the laundry is unevenly distributed. Distribute small and large items of laundry evenly in the drum. ■ Anti-crease (depending on the model) selected? ■ Is the selected speed too low?
The spin cycle runs several times.	Not a fault – the unbalanced load detection system is adjusting an imbalance.
The program is taking longer than usual.	<ul style="list-style-type: none"> ■ Not a fault – the unbalanced load detection system is adjusting an imbalance by repeatedly distributing the laundry. ■ Not a fault – the foam detection system is active – a rinse cycle has been switched on.
The length of the program changes during the wash cycle.	Not a fault – the program sequence is optimised for the specific washing process. This may change the length of the program shown in the display panel.
Residual water in the care-product compartment ☼.	<ul style="list-style-type: none"> ■ Not a fault – the effect of the care product is not affected. ■ Clean the insert if necessary.

Faults	Cause/Remedy
Odours in the washing machine.	<p>Depending on the model, run the Drum Clean 90 °C or Cottons 90 °C program without laundry.</p> <p>Add washing powder or a detergent containing bleach.</p> <p>Note: To prevent foaming, only use half the amount of detergent recommended by the detergent manufacturer. Do not use detergents designed for wool or delicates.</p>
The  symbol lights up in the display panel. Foam may also be leaking from the detergent drawer.	<p>Have you used too much detergent?</p> <p>Mix one tablespoon of fabric softener with 1/2 litre of water and pour it into compartment II (not suitable for outdoor clothing, sportswear or items stuffed with down).</p> <p>Use less detergent in the next wash cycle.</p>
Loud noises, vibrations and machine "movement" during the spin cycle.	<ul style="list-style-type: none"> ■ Is the appliance aligned? Align the appliance → <i>Page 17</i> ■ Are the appliance's feet fixed? Secure the appliance's feet → <i>Page 17</i> ■ Have the transport braces been removed? Remove the transport braces → <i>Page 14</i>
The display panel/indicator lights do not work while the appliance is running.	<ul style="list-style-type: none"> ■ Has there been a power failure? ■ Have the fuses blown? Reset/replace the fuses. ■ If the fault occurs repeatedly, call customer services.
There is detergent residue on the laundry.	<ul style="list-style-type: none"> ■ Some phosphate-free detergents contain water-insoluble residue. ■ Select Rinse or brush the laundry after washing.
The  symbol lights up in the display in pause mode.	<ul style="list-style-type: none"> ■ Door is locked due to safety reasons (water level and/or temperature are too high). It is not possible to add laundry. Close the door immediately, if necessary. ■ Press the  Start/Reload button to continue the program.
<p>If you cannot rectify a fault yourself (after switching the machine off and on again) or a repair is required:</p> <ul style="list-style-type: none"> ■ Switch off the appliance and pull out the mains plug. ■ Turn off the tap and call customer services. 	



After-sales service

If you cannot correct the fault yourself
→ "*Faults and what to do about them*"
on page 41 please contact our after-
sales service. → Back page

We will always find an appropriate
solution in order to avoid unnecessary
visits by engineers.

Please give the after-sales service the
product number (E no.) and the
production number (FD) of the
appliance.

E-Nr. _____	FD _____
Product number	Production number

You can find this information:

- on the inside of the washing machine door*
- in the opened service flap*
- on the rear of the appliance*

*depending on the model

Trust the expertise of the manufacturer.

Contact us for assistance. By doing so,
you will ensure that the repairs are
carried out by trained service personnel
using genuine spare parts.



Consumption values table

Energy and water consumption, programme duration and residual moisture for the main washing programme

(approximate values)

Programme	Load	Energy consumption*	Water consumption*	Programme duration*
Cottons 20 °C	10 kg	0,39 kWh	90 l	3 h
Cottons 40 °C	10 kg	1,29 kWh	90 l	3½ h
Cottons 60 °C	10 kg	1,55 kWh	90 l	3¼ h
Cottons 90 °C	10 kg	2,75 kWh	106 l	3 h
Easy-Care 40 °C	4 kg	0,85 kWh	62 l	2 h
Mixed Load 40 °C	4 kg	0,66 kWh	45 l	1¼ h
Delicates/Silk 30 °C	2 kg	0,25 kWh	37 l	¾ h
 Wool 30 °C	2 kg	0,22 kWh	41 l	¾ h

Programme	Approximate information on the residual moisture***	
	WAU28460TH Max. 1400 rpm	
Cottons	48 %	
Easy-Care	40 %	
Delicates/Silk	30 %	
 Wool	45 %	

Values determined according to the valid version of IEC60456.

* Observed values may deviate from the indicated values due to influence of water pressure, hardness and inlet temperature, ambient temperature, type, amount and soiling of laundry, detergent used, fluctuations in power supply and selected additional functions.



Technical data

Dimensions:

848 mm x 598 mm x 590 mm
(height x width x depth)

Weight:

79 kg

Mains connection:

Nominal voltage 220-240V, 50 Hz

Minimum installation protection
() 10 A

Nominal power 1900-2300 W

Water pressure:

100–1000 kPa (1–10 bar)



Thank you for buying a Bosch Home Appliance!

Register your new device on MyBosch now and profit directly from:

- **Expert tips & tricks for your appliance**
- **Warranty extension options**
- **Discounts for accessories & spare-parts**
- **Digital manual and all appliance data at hand**
- **Easy access to Bosch Home Appliances Service**

Free and easy registration – also on mobile phones:

www.bosch-home.com/welcome



Looking for help? You'll find it here.

Expert advice for your Bosch home appliances, need help with problems or a repair from Bosch experts.

Find out everything about the many ways Bosch can support you:

www.bosch-home.com/service

Contact data of all countries are listed in the attached service directory.

Robert Bosch Hausgeräte GmbH

Carl-Wery-Straße 34

81739 München, GERMANY

www.bosch-home.com



9001365601 (9903)

en