

Built-in oven

Use and Care Manual

HBE5452UC



BOSCH
Invented for life



Table of Contents

Safety Definitions	4	Declaration of conformity	24
IMPORTANT SAFETY INSTRUCTIONS	5	Wi-Fi® Module	24
Proper Installation and Maintenance	5	Cleaning and maintenance	25
Fire Safety	5	Suitable cleaning agents	25
Burn Prevention	6	Surfaces in the cooking compartment	27
Child Safety	6	Keeping the appliance clean	27
Cleaning Safety	6	Cleaning function	27
Cookware Safety	6	Rails	28
State of California Proposition 65 Warnings:	7	Appliance door	29
Causes of damage	8	Troubleshooting	31
Protecting the environment	8	Eliminating faults yourself	31
Saving energy	8	Maximum operating time	32
Getting to know the appliance	9	Replacing the cooking compartment bulb on the ceiling	32
Parts	9	Glass cover	33
Control panel	10	Customer Service	33
Operating controls	10	Before Calling Service	33
Display	11	Data Plate	33
Operating modes	11	Service	33
Heating modes	12	Parts and Accessories	33
Further information	12	STATEMENT OF LIMITED PRODUCT WARRANTY ..	34
Cooking compartment functions	13	What this Warranty Covers & Who it Applies to	34
Accessories	13	How Long the Warranty Lasts	34
Before using the appliance for the first time	14	Repair/Replace as Your Exclusive Remedy	34
Initial use	14	Out of Warranty Product	34
Cleaning the cooking compartment and accessories	14	Warranty Exclusions	34
Operation	15	Dishes	35
Switching the appliance on and off	15	Information on the settings	35
Starting the operation	15	Selecting a dish	35
Setting an operating mode	15	Applying settings for dishes	36
Setting the heating mode and temperature	15	Tested for you in our cooking studio	37
Fast preheat	16	Cakes and small baked items	37
Time-setting options	16	Bread and Rolls	40
Setting the cooking time	17	Pizza, Quiche, and Savoury Pastries	42
Setting the end time	17	Casseroles and Soufflés	43
Setting the timer	18	Poultry	44
Child lock	18	Meat	45
Activating and deactivating	18	Fish	48
Basic Settings	19	Vegetables and Side Dishes	49
Changing the basic settings	19	Slow Cooking	49
List of basic settings	19	Drying	51
Power failure	19	Proofing Dough	51
Changing the time	19	Defrosting	52
Sabbath mode	20	Keeping Food Warm	52
Starting Sabbath mode	20		
Home Connect	21		
Setting up	21		
Remote start	23		
Home Connect settings	23		
Information on data protection	24		

Additional information on products, accessories, replacement parts and services can be found at www.bosch-home.com and in the online shop www.bosch-home.com/us/store

Safety Definitions

▲ WARNING

This indicates that death or serious injuries may occur as a result of non-observance of this warning.

▲ CAUTION

This indicates that minor or moderate injuries may occur as a result of non-observance of this warning.

NOTICE: This indicates that damage to the appliance or property may occur as a result of non-compliance with this advisory.

Note: This alerts you to important information and/or tips.

IMPORTANT SAFETY INSTRUCTIONS

READ AND SAVE THESE INSTRUCTIONS

WARNING

When properly cared for, your new appliance has been designed to be safe and reliable. Read all instructions carefully before use. These precautions will reduce the risk of burns, electric shock, fire, and injury to persons. When using kitchen appliances, basic safety precautions must be followed, including those in the following pages.

This appliance is intended for use at an elevation of no more than 2000 meters above sea level.

Proper Installation and Maintenance

Have the installer show you the location of the circuit breaker or fuse. Mark it for easy reference.

This appliance must be properly installed and grounded by a qualified technician. Connect only to properly grounded outlet. Refer to Installation Instructions for details.

This appliance is intended for normal family household use only. It is not approved for outdoor use. See the Statement of Limited Product Warranty. If you have any questions, contact the manufacturer.

Do not store or use corrosive chemicals, vapors, flammables or nonfood products in or near this appliance. It is specifically designed for use when heating or cooking food. The use of corrosive chemicals in heating or cleaning will damage the appliance and could result in injury.

Do not operate this appliance if it is not working properly, or if it has been damaged. Contact an authorized servicer.

Do not obstruct oven vents.

Do not repair or replace any part of the appliance unless specifically recommended in this manual. Refer all servicing to an authorized servicer.

In the event of an error the display flashes and beeps continuously. Disconnect appliance from the power supply and call an authorized servicer.

WARNING

When removing the door make sure oven is cool and power to the oven has been turned off before removing the door. Failure to do so could result in burns.

The oven door is heavy and fragile. Use both hands to remove the oven door. The door front is glass. Handle carefully to avoid breaking.

Grasp only the sides of the oven door. Do not grasp the handle as it may swing in your hand and cause injury or damage.

Failure to grasp the oven door firmly and properly could result in personal injury or product damage.

Lay the door on a flat smooth surface so that the door cannot fall over. Failure to do so may result in personal injury or damage to the appliance.

WARNING

To avoid injury from hinge bracket snapping closed, be sure that both levers are securely in place before removing door. Also, do not force door open or closed - the hinge could be damaged and injury could result.

WARNING

Make sure the appliance and lights are cool and power to the appliance has been turned off before replacing the light bulb(s). Failure to do so could result in electrical shock or burns. The lenses (if equipped) must be in place when using the appliance. The lenses (if equipped) serve to protect the light bulb from breaking. The lenses (if equipped) are made of glass. Handle carefully to avoid breaking. Broken glass can cause an injury.

WARNING

Light socket is live when door is open if main power supply is not turned off.

Fire Safety

WARNING

NEVER cover any slots, holes or passages in the oven bottom or cover an entire rack with materials such as aluminum foil. Doing so blocks air flow through the oven. Aluminum foil linings may also trap heat, causing a fire hazard.

If materials inside an oven or warming drawer should ignite, keep door closed. Turn off the appliance and disconnect the circuit at the circuit breaker box.

WARNING

Use this appliance only for its intended use as described in this manual. NEVER use this appliance as a space heater to heat or warm the room. Doing so may result in overheating the appliance. Never use the appliance for storage.

Always have a working smoke detector near the kitchen. In the event that personal clothing or hair catches fire, drop and roll immediately to extinguish flames.

Have an appropriate fire extinguisher available, nearby, highly visible and easily accessible near the appliance. Smother flames from food fires other than grease fires with baking soda. Never use water on cooking fires.

IMPORTANT SAFETY INSTRUCTIONS

READ AND SAVE THESE INSTRUCTIONS

WARNING

TO REDUCE THE RISK OF INJURY TO PERSONS IN THE EVENT OF A GREASE FIRE, OBSERVE THE FOLLOWING:

- a. **SMOTHER FLAMES** with a close-fitting lid, cookie sheet, or metal tray, then turn off the burner. **BE CAREFUL TO PREVENT BURNS.** If the flames do not go out immediately, **EVACUATE AND CALL THE FIRE DEPARTMENT.**
 - b. **NEVER PICK UP A FLAMING PAN** – You may be burned.
 - c. **DO NOT USE WATER**, including wet dishcloths or towels – a violent steam explosion will result.
 - d. Use an extinguisher **ONLY** if:
 - You know you have a Class ABC extinguisher, and you already know how to operate it.
 - The fire is small and contained in the area where it started.
 - The fire department is being called.
 - You can fight the fire with your back to an exit.
-

Burn Prevention

DO NOT TOUCH HEATING ELEMENTS OR INTERIOR SURFACES OF OVEN - Heating elements may be hot even though they are dark in color. Interior surfaces of an oven become hot enough to cause burns. During and after use, do not touch, or let clothing, potholders, or other flammable materials contact heating elements or interior surfaces of oven until they have had sufficient time to cool. Other surfaces of the appliance may become hot enough to cause burns. Among these surfaces are oven vent openings, surfaces near these openings and oven doors.

Exercise caution when opening the appliance. Standing to the side, open the door (or drawer) slowly and slightly to let hot air and/or steam escape. Keep your face clear of the opening and make sure there are no children or pets near the unit. After the release of hot air and/or steam, proceed with your cooking. Keep doors shut unless necessary for cooking or cleaning purposes. Do not leave open doors unattended.

Do not heat or warm unopened food containers. Build-up of pressure may cause the container to burst and cause injury.

Use caution when cooking foods with high alcohol content (e.g. rum, brandy, bourbon) in the oven. Alcohol evaporates at high temperatures. There is a risk of burning as the alcohol vapors may catch fire in the oven. Use only small quantities of alcohol in foods, and open the oven door carefully.

Always place oven racks in desired location while oven is cool. Always use oven mitts, when the oven is warm. If a rack must be moved while oven is hot, do not let potholder contact the heating elements.

CAUTION

To avoid possible injury or damage to the appliance, ensure rack is installed exactly per installation instructions and not backwards or upside down.

Always use dry potholders. Moist or damp potholders on hot surfaces may result in burns from steam. Do not let potholder touch hot heating elements. Do not use a towel or other bulky cloth.

Secure all loose garments, etc. before beginning. Tie long hair so that it does not hang loose, and do not wear loose fitting clothing or hanging garments, such as ties, scarves, jewelry, or dangling sleeves.

Child Safety

When children become old enough to use the appliance, it is the responsibility of the parents or legal guardians to ensure that they are instructed in safe practices by qualified persons.

Do not allow anyone to climb, stand, lean, sit, or hang on any part of an appliance, especially a door, warming drawer, or storage drawer. This can damage the appliance, and the unit may tip over, potentially causing severe injury.

Do not allow children to use this appliance unless closely supervised by an adult. Children and pets should not be left alone or unattended in the area where the appliance is in use. They should never be allowed to play in its vicinity, whether or not the appliance is in use.

CAUTION

Items of interest to children should not be stored in an appliance, in cabinets above an appliance or on the backsplash. Children climbing on an appliance to reach items could be seriously injured.

Cleaning Safety

Keep oven free from grease build up.

WARNING

RISK OF BURNS

 The appliance will become very hot on the outside during the cleaning function. Never touch the appliance door. Allow the appliance to cool down. Keep children away from the appliance.

Cookware Safety

NOTICE: Do not place food directly on oven bottom. Follow the manufacturer's directions when using cooking or roasting bags.

IMPORTANT SAFETY INSTRUCTIONS

READ AND SAVE THESE INSTRUCTIONS

State of California Proposition 65 Warnings:

WARNING

This product can expose you to chemicals including vinyl chloride, which is known to the State of California to cause cancer and birth defects or other reproductive harm. For more information go to www.P65Warnings.ca.gov.

Causes of damage

NOTICES

- Accessories, foil, greaseproof paper or ovenware on the cooking compartment floor:
 - Do not place accessories on the cooking compartment floor.
 - Do not cover the cooking compartment floor with any sort of foil or greaseproof paper.
 - Do not place ovenware on the cooking compartment floor if a temperature of over 122° F (50°C) has been set.

This will cause heat to accumulate. The baking and roasting times will no longer be correct and the enamel will be damaged.

- Aluminum foil: Aluminum foil in the cooking compartment must not come into contact with the door glass. This could cause permanent discoloration of the door glass.
- Water in a hot cooking compartment: do not pour water into the cooking compartment when it is hot. This will cause steam. The change in temperature can cause damage to the enamel.
- Moisture in the cooking compartment: Over an extended period of time, moisture in the cooking compartment may lead to corrosion. Allow the cooking compartment to dry after use. Do not keep moist food in the closed cooking compartment for extended periods of time. Do not store food in the cooking compartment.

- Cooling with the appliance door open: Following operation at high temperatures, only allow the cooking compartment to cool down with the door closed. Do not trap anything in the appliance door. Even if the door is only left open a crack, the front of nearby furniture may become damaged over time. Only leave the cooking compartment to dry with the door open if a lot of moisture was produced during operation.
- Fruit juice: when baking particularly juicy fruit pies, do not pack the baking tray too generously. Fruit juice dripping from the baking tray leaves stains that cannot be removed. If possible, place on a baking sheet lined with aluminum foil.
- Dirty seal: If the seal is very dirty, the appliance door will no longer close properly during operation. The fronts of adjacent cabinets could be damaged. Always keep the seal clean.
- Appliance door as a seat, shelf or worktop: Do not sit on the appliance door, or place or hang anything on it. Do not place any cookware or accessories on the appliance door.
- Inserting accessories: depending on the appliance type, accessories can scratch the door glass when closing the door. Always slide accessories into the cooking compartment as far as they will go.
- Transporting the appliance: Do not carry or hold the appliance by the door handle. The door handle cannot support the weight of the appliance and could break.

Protecting the environment

Your new appliance is energy-efficient. Here you can find tips on how to save even more energy when using the appliance, and how to dispose of your appliance properly.

Unpack the appliance and dispose of the packaging in an environmentally friendly manner.

Saving energy

- Only preheat the appliance if this is specified in the recipe or in the tables in the operating instructions.
- Use baking tins that are dark-colored, painted black or have an enamel coating. They absorb the heat particularly well.
- Open the appliance door as infrequently as possible when the appliance is in use.
- It is best to bake several cakes one after the other. The cooking compartment is still warm. This reduces the baking time for the second cake. You can place two cake tins next to each other in the cooking compartment.
- For longer cooking times, you can switch the appliance off 10 minutes before the end of the cooking time and use the residual heat to finish cooking.

Getting to know the appliance

In this section, we will explain the indicators and controls. You will also find information on the various functions of your appliance.

Note: Depending on the appliance model, individual details and colors may differ.

Parts



1	Control panel
2	Door seal
3	Broil element
4	Convection fan
5	Door hinges
6	Oven vents

NOTICE: Do not place food directly on oven bottom.
Do not obstruct oven vents.

Control panel

In the control panel, you can use the various buttons, touch fields, touch-screen displays and the rotary selector to set the different appliance functions. The current settings are shown on the display.

The overview shows the control panel when the appliance is switched on with the menu display.

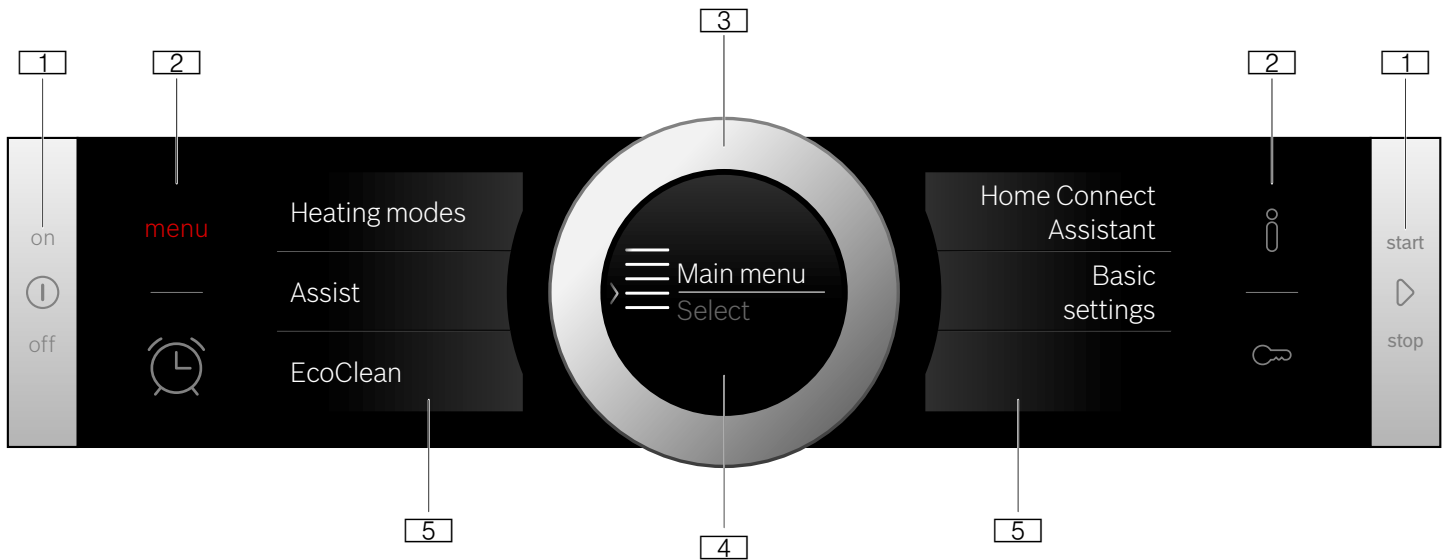

1 Buttons

The buttons on the left- and right-hand side of the control panel have a pressure point. Press these buttons to activate them.

For appliances that do not have a stainless steel front, these two button touch fields do not have a pressure point.

2 Touch fields

There are sensors under the touch fields. Simply touch the respective symbol to select the function.

3 Rotary selector

The rotary selector is fitted so that you can turn it indefinitely to the left or right. Press it lightly and move it in the direction required using your finger.

4 Display

You can see the current adjustment values, options or notes in the display.

5 Touch-screen displays

You can see the current selection options in the touch-screen displays. You can select these here directly by touching the appropriate text field. The text fields change depending on the selection.

Operating controls

The individual controls are adapted for the various functions of your appliance. You can set your appliance simply and directly.

Buttons and touch fields

Here you can find a short explanation of the various buttons and touch fields.

Symbol		Meaning
Buttons		
ⓘ	on/off	Switching the appliance on and off
▶	start/stop	Starting, pausing or cancelling (hold down for approx. 3 secs) an operation
Touch fields		
menu	Menu	Opens the "Operating modes" menu
🕒	Timer	Selects the timer
ℹ	Information	Displays information
🔒	Child lock	Activating and deactivating (hold down for approx. 4 secs) the childproof lock

Rotary selector

You can use the rotary selector to change the setting values shown on the display.

You can also use the rotary selector to scroll through the selection lists on the touch-screen displays.

In most selection lists, you have to turn the rotary selector in the opposite direction once you reach the beginning or the end of the list.

Display

The display is structured so that the information can be read at a glance in any situation.

The value that you can currently set is highlighted in white text in the display. The value in the background is displayed in gray text.

Focus	The highlighted value can be changed immediately without first being selected. After starting an operation, either the temperature or level remains highlighted. The white line also serves as the heating line and gradually turns red.
Enlargement	As long as you use the rotary selector to change the highlighted value, only this value will be displayed larger.

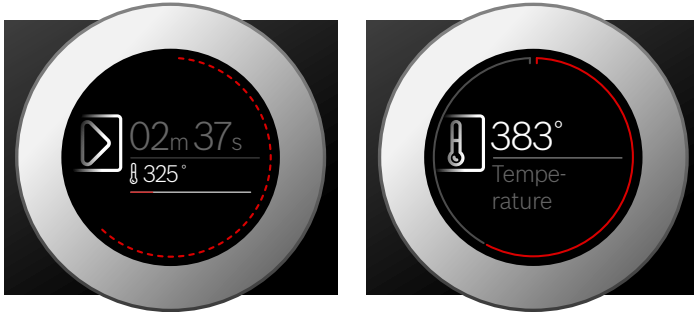

Display ring

The display ring can be found around the outside of the display.

If you change a value, the display ring shows you where you are in the selection list. Depending on the settings area and length of the selection list, the display ring may be continuous or divided into segments.

During operation, the display ring turns red at second-long intervals. After every full minute, the segments turn red again from the beginning. As the cooking time counts down, one segment disappears every second.

Temperature display

After the operation has started, the current cooking compartment temperature is displayed graphically on the display.

Heating line	The white line under the temperature turns red from left to right as the cooking compartment heats up. When you are preheating the appliance, the optimal time to place the food in the cooking compartment is when the line has completely turned red, and a beep indicates that preheating is complete. For set levels, e.g. the broil setting, the heating line turns red immediately.
Residual heat indicator	When the appliance is switched off, the display ring shows the residual heat in the cooking compartment. As the residual heat cools down, the display ring becomes darker and disappears completely at some point.

Note: Due to thermal inertia, the temperature displayed may be slightly different to the actual temperature inside the oven.

Touch-screen displays

The touch-screen displays are both a display medium and control element at the same time. They show the options that you can select for a function and the current setting. To select a function, simply touch the text field directly.

The function currently selected is identified by a red vertical bar next to it. Its corresponding value is highlighted in white on the display.

The small red arrow next to the text field shows the functions to which you can scroll forwards or backwards.



Operating modes

Your appliance has various operating modes that make your appliance easier to use.

You can find more precise descriptions of these in the corresponding sections.

You can open the "Operating modes" menu by pressing the **menu** field.











Operating mode	Use
Heating modes → "Operation" on page 15	There are various finely tuned heating types for the optimal preparation of your food.
Assist → "Dishes" on page 35	For many dishes, there are preprogrammed setting values.
EcoClean → "Cleaning function" on page 27	The cleaning function cleans the cooking compartment almost by itself.
Home Connect Assistant → "Home Connect" on page 21	This function allows you to connect your oven with a mobile device.
Basic settings → "Basic Settings" on page 19	You can change your appliance's basic settings to suit your needs.

Heating modes

To enable you to find the correct type of heating for your dish, we have explained the differences and scopes of application here.

The symbols for each type of heating help you to remember them.

When cooking at very high temperatures, the appliance lowers the temperature slightly after an extended period.

Type of heating	Temperature	Use
 Bake	150-550° F (65-285)	For traditional baking and roasting on one level. Especially suitable for cakes with moist toppings. Heat is emitted evenly from the top and bottom.
 Broil	Broil settings: 1 = low 2 = medium 3 = high	For broiling flat items, such as steaks or sausages, for making toast, and for browning food. The whole area below the broiler element becomes hot.
 Roast	150-550° F (65-285)	For less tender cuts of meat and poultry. The heat is emitted from above and more intensively from below.
 Convection Multi-Rack	150-525° F (65-275 °C)	For baking and roasting on one or more levels. The fan distributes the heat from the ring heating element in the back panel evenly around the cooking compartment.
 Convection Broil	450-550° F (230-285 °C)	For roasting poultry, whole fish and larger pieces of meat. The grill heating element and the fan switch on and off alternately. The fan circulates the hot air around the food.
 Pizza setting	150-525° F (65-275 °C)	For preparing pizza and dishes that require a lot of heat from underneath. The bottom heating element and the ring heating element in the back panel heat up.
 Slow Cook	100-250° F (35-120 °C)	For gentle and slow cooking of seared, tender pieces of meat in ovenware without a lid. The heat is emitted evenly from the top and bottom at low temperatures.
 Proof	80-110° F (25-45 °C)	For the rising of dough or yeast. Heat is emitted from below.
 Warming	140-220° F (60-105 °C)	For keeping cooked food warm.
 Plate warming	100-150° F (35-65 °C)	For preheating plates.
 Defrost	100-140° F (35-60 °C)	For gently defrosting frozen food.

Default values

For each type of heating, the appliance specifies a default temperature or level. You can accept this value or change it in the appropriate area.

Further information

In most cases, the appliance provides notes and further information on the action just carried out.

Touch the *i* field. The note is shown in the display for a few seconds. Use the rotary selector to scroll to the end of longer notes.

Some notes are displayed automatically, for example as confirmation, or to provide an instruction or warning.

Cooking compartment functions

The functions in the cooking compartment make your appliance easier to use. These functions include, for example, that the cooking compartment is well lit and that a cooling fan prevents the appliance from overheating.

▲ CAUTION

Do not place anything on the cooking compartment floor. Do not cover it with aluminium foil. A build-up of heat could damage the appliance or cause injury.

Opening the appliance door

If you open the appliance door during an operation, the operation is paused. The operation continues to run when you close the door.

Interior lighting

When you open the appliance door, the interior lighting switches on. If the door remains open for longer than 15 minutes, the lighting switches off again.

For most operating modes, the interior lighting switches on as soon as the operation is started. When the operation has finished, the lighting switches off.

Note: You can set the interior lighting not to come on during the operation in the basic settings. → "Basic Settings" on page 19

Cooling fan

The cooling fan switches on and off as required. The hot air escapes above the door.

▲ CAUTION

Do not cover the ventilation slots. Otherwise, the appliance may overheat.

So that the cooking compartment cools down more quickly after the operation, the cooling fan continues to run for a certain period afterwards.

Note: You can change how long the cooling fan continues to run in the basic settings. → "Basic Settings" on page 19

Accessories

Your appliance is accompanied with a variety of accessories. Here, you can find an overview of the accessories included and information on how to use them correctly.

▲ CAUTION

Do not slide any accessories between the rack positions, or they may tip.

Accessories included

Your appliance is equipped with the following accessories:

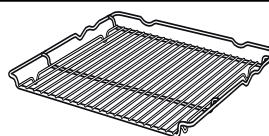

Wire rack (3x)

For ovenware, cake tins and ovenproof dishes, roasts, grilled items and frozen meals.

Only use original accessories. They are specially designed for your appliance.

You can buy accessories from customer service or online.

Note: The accessories may slightly flex when they become hot. This does not affect the function of the accessory. Once they have cooled down, they will regain their original shape.

Inserting accessories

The cooking compartment has five rack positions. The rack positions are counted from the bottom up.

In some appliances, the highest rack position is marked on the cooking compartment with the grill symbol.

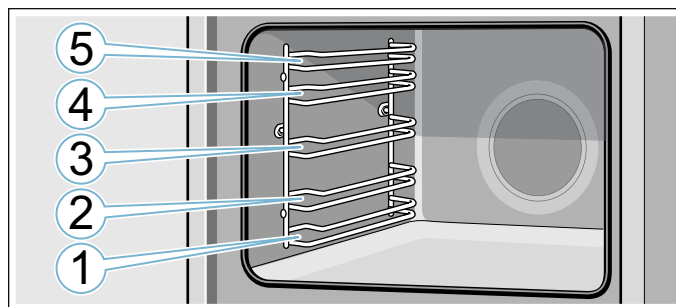

Always insert the accessory between the two guide rods for a rack position.

The accessories can be pulled out approximately halfway without tipping.

Notes

- Ensure that you always insert the accessories into the cooking compartment facing the correct way.
- Always insert the accessories fully into the cooking compartment so that they do not touch the appliance door.

Locking function

The accessories can be pulled out approximately halfway until they lock in place. The locking function prevents the accessories from tilting when they are pulled out. The accessories must be inserted into the oven cavity correctly for the tilt protection to work properly.

When inserting the wire rack, ensure that the locking catch **a** is at the rear and is facing downwards. The open side must be facing towards the appliance door and the curvature must be facing downwards .

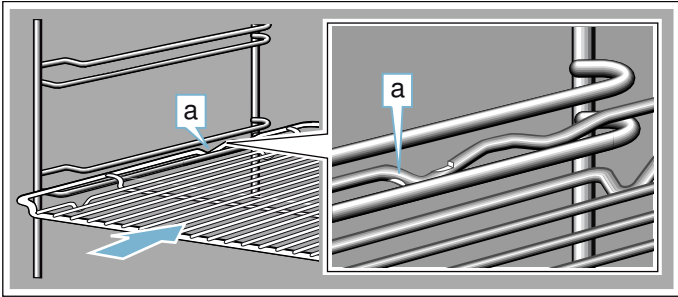

Special accessories

You can buy optional accessories from customer service or online. *You will find a list of products for your appliance in our brochures and online.

Availability of products differ by country and whether available for order online. Please see your sales brochures for more details.

Note: Not all optional accessories are suitable for every appliance. When purchasing, please always use the exact identification number (E-no.) of your appliance.

→ "Customer Service" on page 33

Special accessories



Broiling Pan

(available via eShop)

Pan: #00449757

Grill(top): #00449756

Before using the appliance for the first time

Before you can use your new appliance, you must enter certain settings. You must also clean the cooking compartment and accessories.

Initial use

After connecting the appliance to the power or following a power failure, the settings for initial use are shown in the display. It may take a few seconds for the instruction to appear.

Note: You can change these settings again at any time in the basic settings. → "Basic Settings" on page 19

With HomeConnect

You can apply the initial settings on the appliance or with Home Connect on your mobile device.

1. Touch the "With Home Connect" text field.
2. Follow the instructions in the "Home Connect" section.

On the appliance

Make the following initial settings on your appliance:

Setting the language

The language is the first setting displayed. "English" is the preset language.

1. Turn the rotary selector to set the required language.
2. Touch the next text field to confirm.
The next setting appears.

Setting the time

The time starts at "12:00."

1. Touch the "Clock" text field.
2. Set the time using the rotary selector.
3. Touch the "Finish settings" text field to confirm.

A note appears in the display confirming that the initial use has been completed.

Cleaning the cooking compartment and accessories

Before using the appliance to prepare food for the first time, you must clean the cooking compartment and accessories.

Cleaning the cooking compartment

To eliminate the new-appliance smell, heat up the cooking compartment when it is empty and with the oven door closed.

Make sure that there is no leftover packaging, such as polystyrene pellets, in the cooking compartment. Before heating the appliance, wipe the smooth surfaces in the cooking compartment with a soft, damp cloth. Keep the kitchen ventilated while the appliance is heating.

Apply the settings indicated below. You can find out how to set the heating function and the temperature in the next section. → "Operation" on page 15

Settings

Heating mode	Convection Multi-Rack 
Temperature	maximum
Cooking time	1 hour

Switch off the appliance after the indicated cooking time using the  On/Off button.

Once the cooking compartment has cooled down, clean the smooth surfaces with soapy water and a dish cloth.

Cleaning the accessories

Clean the accessories thoroughly using soapy water and a dish cloth or soft brush.

Operation

You have already learned about the controls and how they work. Now we will explain how to apply settings on your appliance. You will learn about what happens when you switch the appliance on and off, and how to select the operating mode.

Switching the appliance on and off

Before you are able to set the appliance, you must switch it on.

Note: The childproof lock and the timer can also be set when the appliance is switched off. Certain displays and notes, such as those relating to the residual heat in the cooking compartment, remain visible on the display after the appliance has been switched off.

Switch off your appliance when you do not need to use it. If no settings are applied for a long time, the appliance switches itself off automatically.

Switching on the appliance

Press the **ⓘ** On/Off button to switch on the appliance. The Bosch logo appears on the display, followed by the selection list for the heating modes.

Note: In the basic settings, you can specify which operating mode should appear after the appliance is switched on.

Switching off the appliance

Press the **ⓘ** On/Off button to switch off the appliance. Any functions that may be running are cancelled. The time, or if applicable, the residual heat indicator, appears on the display.

Note: You can set whether or not the time should be displayed when the appliance is switched off in the basic settings.

Starting the operation

You must press the **▶** Start/Stop button to start each operation.

After starting the appliance, the time display is shown on the display along with the settings. The display ring and the heating line also appear.

Pausing the operation

You can also interrupt and then continue an operation using the **▶** Start/Stop button.

If you press and hold the **▶** Start/Stop button for approx. 3 seconds, the operation is cancelled and all settings are reset.

Note: The fan may continue to run after an operation has been paused or cancelled.

Setting an operating mode

Once the appliance is switched on, the default operating mode is displayed.

If you would like to select a different operating mode, you can do so using the menu. You can find detailed descriptions of the individual operating modes in the corresponding sections.

The following always applies:

1. Touch the appropriate text field.
The function is highlighted.
2. Turn the rotary selector to change the highlighted selection.
3. If necessary, apply other settings.
To do this, touch the appropriate text field and change the value using the rotary selector.
4. Press the Start/Stop button **▶** to start.
The appliance starts the operation.

Setting the heating mode and temperature

If the "Heating modes" operating mode has not been selected, touch the "Heating modes" text field in the menu. The selection list for the heating modes appears on the touch-screen displays.

Example in the picture: Bake **☐** at 350° F (195 °C).

1. Touch the text field with the required heating mode. If necessary, scroll through the selection list using the rotary selector.



The temperature is highlighted white.

2. Turn the rotary selector to set the temperature.

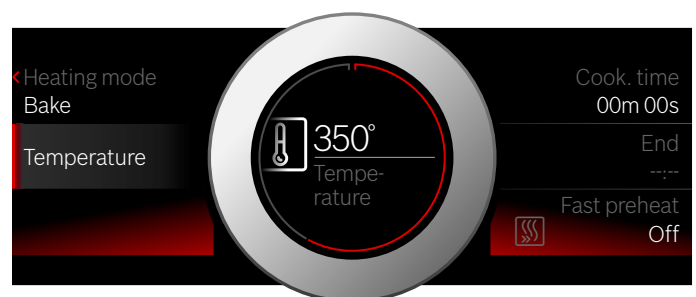

3. Press the Start/Stop button  to start.

The time in the display shows how long the operation has already been running.



The appliance begins to heat up.

When your dish is ready, use the  On/Off button to switch off the appliance.

Note: You can also set the cooking time and an end time for the operation on the appliance.

Changing

After starting the appliance, the temperature remains highlighted. When you move the rotary selector, the temperature is changed and applied immediately.



To change the type of heating, first use the  Start/Stop button to interrupt the operation and then touch the "Type of heating" text field. The selection list is displayed. Touch the required type of heating. The corresponding default temperature appears on the display.

Note: When you change the type of heating, the other settings are also reset.

Fast preheat

With Fast preheat, you can shorten the heat-up time for some heating types.

The heating types suitable for Fast preheat are:

-  Convection Multi-Rack
-  Bake

To achieve an even cooking result, do not place your food or accessories into the cooking compartment until "Fast preheat" is complete.

Setting

Ensure you have selected a suitable type of heating and set a temperature of at least 200° F (95 °C). Otherwise, rapid heating cannot be activated.

1. Set the type of heating and temperature.

2. Touch the "Rapid heating" text field.

"On" is displayed in the text field. A confirmation message appears on the display.

When rapid heating comes to an end, an audible signal sounds and a message appears on the display. "Off" is displayed in the text field. Place your food in the cooking compartment.



Note: The "Cooking time" time-setting option starts at the same time as rapid heating. Therefore, only set a cooking time when rapid heating has come to an end.

Cancelling

To cancel the fast preheat, touch the "Fast preheat" text field again. "Off" is displayed in the text field.

Time-setting options

Your appliance has different time-setting options.

Time-setting option	Use
 Cooking time	Once the set cooking time has elapsed, the appliance will automatically stop heating.
 End	Enter a cooking time and the required end time. The appliance will start up automatically so that it finishes cooking at the required time.
 Timer	The timer functions like an egg timer. It runs independently of the operation and the other time-setting options. After the set time has elapsed, the appliance does not switch on or off automatically.

You can call up the cooking time and the end time after setting an operation using the touch-screen displays. The timer has a separate field  and can be adjusted at any time.

An audible signal will sound once the cooking time or timer duration has elapsed. You can cancel the audible signal early by touching a field or touch-screen display.

Note: You can change how long the audible signal sounds for in the basic settings.

Setting the cooking time

You can set the cooking time for your food on the appliance. This prevents the food from accidentally being cooked for too long, and means that you do not have to stop what you are doing to switch off the oven.

Setting

Depending on which direction you turn the rotary selector first, the cooking time starts at a particular default value: Left = 10 minutes, right = 30 minutes.

The cooking time can be set in one-minute increments up to one hour, and then in five-minute increments.

The maximum time that can be set is 23 hours and 59 minutes.

Example in the picture: It is 10:00, cooking time of 45 minutes.

1. Set the operating mode and temperature or level.
The cooking time is highlighted in white in the display.
2. Before starting the operation, touch the "Cooking time" text field.
The end time is calculated automatically.
3. Turn the rotary selector to set the cooking time.
The end time is calculated automatically.



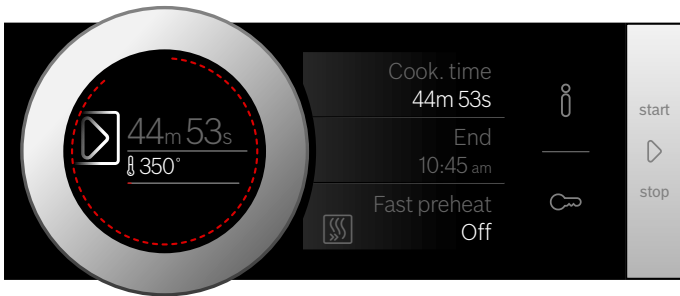

4. Press the Start/Stop button  to start.
The cooking time counts down.



The appliance begins to heat up.

Once the cooking time has elapsed, an audible signal sounds. The appliance stops heating up. The cooking time 00 m 00 s is shown in the display.

You can reset the cooking time using the "Cooking time" text field or you can press the  Start/Stop button to continue the operation without a cooking time.

When your dish is ready, use the  On/Off button to switch off the appliance.

Changing and cancelling

To change the cooking time, touch the "Cooking time" text field. The cooking time is highlighted, and can be changed using the rotary selector. The change is applied immediately.

If you want to cancel the cooking time, reset the cooking time to zero. After the change has been adopted, operating continues without a cooking time.

Setting the end time

You can delay the time at which cooking is due to finish. You can, for example, put your food in the cooking compartment in the morning and set the cooking time so that it is ready at lunch time.

Notes

- Ensure that food is not left in the cooking compartment for too long, as it may spoil. PLEASE OBSERVE ALL SAFE FOOD HANDLING PRACTICES TO ENSURE FOOD SAFETY.
- Do not adjust the end time once the operation has started. The cooking result would no longer be correct.

Setting

The end of the cooking time can be delayed by up to 23 hours and 59 minutes.

Example in the picture: It is 10:00, the set cooking time is 45 minutes and the dish should be ready at 12:00.

1. Set the operating mode and temperature or level.
2. Set the cooking time.
3. Before starting the operation, touch the "End" text field.
The projected end time is highlighted white in the display.
4. Turn the rotary selector to set a later end time.





5. Press the Start/Stop button  to start.
The time at which the appliance will start is shown in the display.



The appliance is in standby mode. When the appliance starts, the cooking time counts down in the display.

Once the cooking time has elapsed, an audible signal sounds. The appliance stops heating up. The cooking time 00 m 00 s is shown in the display.

You can reset the cooking time using the "Cooking time" text field or you can press the  Start/Stop button to continue the operation without a cooking time.

When your dish is ready, use the  On/Off button to switch off the appliance.

Changing and cancelling

After starting the appliance, the end time can no longer be changed.

If you want to cancel the cooking time and end time, interrupt the operation by pressing the  Start/Stop button. You can continue the operation without a cooking time or end time.

Setting the timer

The timer runs alongside other settings. You can set it at any time, even if the appliance has been switched off. It has its own audible signal so that you can tell whether it is the timer duration or a cooking time that has elapsed.

Setting

The timer duration always starts at zero minutes.

The higher the value, the greater the time steps when setting the timer.

The maximum setting is 24 hours.

1. Touch the  field.

The symbol lights up red. On the display, the timer duration is shown in white and in focus.

2. Set the timer duration using the rotary selector.

3. Press the  field to start.

Note: After a few seconds, the timer will also start automatically.

The timer duration counts down.

The timer remains visible in the display if the appliance is switched off. When an operation is running, the settings for this operation are shown in the foreground. When you touch the  field, the timer duration is displayed for a few seconds.

When the timer duration comes to an end, an audible signal sounds and a note appears on the display. The symbol is no longer lit up.

Tip: If the set timer duration is the duration for which you wish to cook your food, use the cooking time. The time is visible in the foreground and the appliance switches off automatically.

Changing and cancelling

To change the timer duration, touch the  field. The timer duration is displayed in white and in focus, and can be changed by using the rotary selector.

If you want to cancel the timer, reset the duration on the timer to zero. Once the change has been applied, the symbol is no longer lit up.

Child lock

Your appliance is equipped with a childproof lock so that children cannot switch it on accidentally or change any settings.



The control panel is locked and no settings can be made. The appliance can only be switched off using the  On/Off button.

Activating and deactivating

You can activate and deactivate the childproof lock when the appliance is switched on or off.

In each case, press the  field for approx. 4 seconds.

A confirmation note appears on the display.

The  field lights up red when the appliance is switched on. The  field does not light up when the appliance is switched off.

Basic Settings

There are various settings available to you in order to help use your appliance effectively and simply. You can change these settings as required.

Changing the basic settings

The appliance must be switched on.

1. Touch the **menu** field.
The list of operating modes is displayed.
2. Touch the "Basic settings" text field.
The settings appear on the touch-screen displays.
3. Touch the text field with the required setting.
The red bar next to the text field identifies the setting that is currently selected.
Its corresponding value is shown on the display.
4. Turn the rotary selector to change the value as required.
5. Touch the text field for the next setting.
Its value is shown on the display and can be changed using the rotary selector.
6. Work through the settings and use the rotary selector to make changes as required.
To scroll through the settings, touch the "Further settings" text field.
7. Touch the **menu** field to confirm.
A query is displayed asking whether the changes should be saved.
8. Touch the "Save" text field.
A message is shown on the display to confirm that the settings have been saved.

Cancelling

If you do not want to save the settings, touch the **menu** field and then touch the "Do not save" text field. A message is shown on the display to confirm that the settings have not been saved. Switch off the appliance using the ⏻ On/Off button if you do not need to use it.

List of basic settings

Depending on the features of your appliance, not all basic settings will be available.

Setting	Options
Language	Additional languages are available
Time	Clock in 12-hour format
Home Connect	Switches Wi-Fi on or off
Factory settings	Reset Do not restore*
Beeping sound	Short cooking time (30 sec.) Medium cooking time (1 min)* Long cooking time (5 min.)
Volume	Scale with 5 levels

Button tone	Switched on Switched off* (tone remains for ⏻ On/Off)
Display brightness	Five levels
Clock display	Off Digital* Analog
Lighting	Off when in operation On during operation*
Operation after switch-on	Main menu Heating modes* Assist
Night-time dimming	Switched off* Switched on
Brand logo	Display* Do not display
Fan run-on time	Recommended* Minimum
Pull-out system	Not retrofitted* (for rails and single pull-out system) Retrofitted (for double and triple pull-out systems)
Sabbath mode	Switched on Switched off*

* Factory setting (factory settings may vary depending on the appliance model)

Power failure

The changes you make to the settings are retained even after a power failure.

You only have to reset the settings for the initial use following a long-term power failure. The appliance can bridge a short-term power failure.

Changing the time

If you want to change the time, for example from summer to winter time, you must change the basic setting.

The appliance must be switched on.

1. Touch the **menu** field.
The list of operating modes is displayed.
2. Touch the "Basic settings" text field.
The settings appear on the touch-screen displays.
3. Touch the "Clock" text field.
The time appears on the display.
4. Turn the rotary selector to change the time.
5. Touch the **menu** field to confirm.
A query is displayed asking whether the changes should be saved.
6. Touch the "Save" text field.
A message is shown on the display to confirm that the settings have been saved.

Sabbath mode

With the Sabbath mode, a cooking time of up to 74 hours can be set. You can keep the food in the cooking compartment warm without having to switch the oven on or off.

Starting Sabbath mode

Before you are able to use the Sabbath mode, you must activate it in the basic settings. → *"Basic Settings" on page 19*

When the basic setting has been changed accordingly, Sabbath mode is listed with the heating modes as the last type of heating.

The appliance heats up with Bake. You can set a temperature between 150° F and 300° F (85 °C and 140 °C).

The "Heating modes" operating mode must be selected. The selection list for the heating modes appears on the touch-screen displays.

1. Touch the "Sabbath" text field.
The default temperature is highlighted white in the display.
2. Set the required temperature using the rotary selector.
3. Before starting the operation, touch the "Cooking time" text field.
The default cooking time is highlighted white in the display.
4. Set the required cooking time using the rotary selector.
Note: The end time is calculated automatically but cannot be changed.
5. Press the Start/Stop button  to start.
The cooking time will count down on the display.



The appliance begins to heat up.

When the cooking time for Sabbath mode has ended, an audible signal sounds. The appliance stops heating up. The cooking time 00 m 00 s is shown in the display. Press the  On/Off button to switch off the appliance.

Note: The operation is not interrupted if you open the appliance door.

Changing and cancelling

After starting the appliance, the settings can no longer be changed.

If you would like to cancel Sabbath mode, switch the appliance off using the  On/Off button. You can no longer pause the operation using the  Start/Stop button.

Home Connect

This appliance is Wi-Fi-capable and can be remotely controlled using a mobile device.

If the appliance is not connected to the home network, the appliance functions in the same way as an oven with no network connection and can still be operated via the display.

Notes

- Ensure that you follow the safety instructions in this instruction manual and that these are complied with when operating the appliance via the Home Connect app and when you are away from home. Follow the instructions in the Home Connect app.
- Operating the appliance directly from the appliance always has priority. During this time, it is not possible to operate the appliance using the Home Connect app.

Setting up

To implement settings via Home Connect, you must have installed and set up the Home Connect app on your mobile device.

Observe the supplied Home Connect documents with regard to this.

Follow the steps specified by the app to implement the settings.

The app must be open in order to perform the setup process.

Automatic registration in the home network

Notes

- A router that has WPS functionality is required.
- You can start the Home Connect Assistant during initial start-up or using the main menu.

1. Touch the **menu** field.

2. Touch the "Home Connect Assistant" text field.

The appliance is ready to connect to the network automatically.



3. Press the WPS button on the router.
Wait until "Network connection - Successful" is shown in the display.



4. Touch "Connect with app".



The appliance is ready to connect to the app.

5. Start the app on the mobile device and follow the instructions for automatic network registration.

The process for registering is completed once "Connect to app - Successful" is shown on the display.



Manual registration in the home network

Note: You can start the Home Connect Assistant during initial start-up or using the menu.

1. Touch the **menu** field.
2. Touch the "Home Connect Assistant" text field.
3. Touch the "Manually connect" text field.



The appliance is ready to connect to the network manually.

The SSID and the key for the oven network are shown on the display.



4. Use the "Home Connect" SSID and the "Home Connect" key to register the mobile device on the oven network.



Wait until "Network connection - Successful" is shown in the display.



5. Touch "Connect with app".



The appliance is ready to connect to the app.

6. Start the app on the mobile device and follow the instructions for manual network registration.
The process for registering is completed once "Connect to app - Success" is shown on the display.



Remote start

If you want to start an oven operation using your mobile device, you must activate remote start.

Notes

- The "Remote start" text field is only visible if the Home Connect Assistant has been successfully completed.
- Note that some operating modes can only be started on the oven itself.

1. Touch the **menu** field.
2. Touch the "Remote Start" text field.
☰ appears in the display



Remote start is automatically deactivated in the following situations:

- The oven door is opened 15 minutes after remote start is activated.
- The oven door is opened 15 minutes after the oven operation ends.
- 24 hours after remote start is activated.

When you start the oven operation on the appliance, remote start is automatically activated. You can therefore make changes on your mobile device or start a new program.

Home Connect settings

You can adjust Home Connect to suit your requirements at any time.

Note: In the Home Connect settings, press the ⓘ field to display network and device information.

WiFi

If WiFi is activated, you can use the Home Connect functions.

Note: In the networked standby mode, your appliance requires a maximum of 3 W.

1. Touch the **Menu** field.
2. Touch the "Basic settings" text field.
3. Touch the "Home Connect" text field.

4. Touch "WiFi" text field to switch the wireless module on or off.



Disconnecting from the network

You can disconnect your oven from the network at any time.

Note: If your oven is disconnected from the network, it is not possible to operate the oven using Home Connect.

1. Touch the **menu** field.
2. Touch the "Basic settings" text field.
3. Touch the "Home Connect" text field.
4. Touch the "Disconnect from network" text field.



Connecting to the network

1. Touch the **menu** field.
2. Touch the "Basic settings" text field.
3. Touch the "Home Connect" text field.
4. Touch the "Connect to network" text field.
5. Touch the "Assist" text field.
"Connect manually" or
"Connect automatically".
6. Follow the instructions in the section entitled "Manual registration in the home network" or "Automatic registration in the home network".

Connect to App

If the Home Connect app is installed on your mobile device, you can connect it to your oven.

Note: The appliance must be connected to the network.

1. Touch the **menu** field.
2. Touch the "Basic settings" text field.
3. Touch the "Home Connect" text field.
4. Touch the "Connect with app" text field.



Remote control

You can use the Home Connect app to easily access the functions of your oven.

Notes

- Operating the appliance directly from the appliance always has priority. During this time, it is not possible to operate the appliance using the Home Connect app.
 - The remote control is already activated when the appliance is delivered.
 - If the remote control has been deactivated, only the oven's operating statuses will be displayed in the Home Connect app.
 - The remote control is automatically activated when the remote start is activated.
1. Touch the **menu** field.
 2. Touch the "Basic settings" text field.
 3. Touch the "Home Connect" text field.
 4. Touch the "Remote control" text field to switch operation via the Home Connect app on or off.



Information on data protection

When your appliance is connected to a WLAN network that is connected to the Internet for the first time, your appliance transmits the following categories of data to the Home Connect server (initial registration):

- Unique appliance identification (consisting of appliance codes as well as the MAC address of the installed WiFi communication module).
- Security certificate of the Wi-Fi communication module (to ensure a secure data connection).
- The current software and hardware version of your domestic appliance.
- Status of any previous resetting to factory settings.

This initial registration prepares the Home Connect functions for use and is only required when you want to use these Home Connect functions for the first time.

Note: Ensure that the Home Connect functions can be used only in conjunction with the Home Connect app. Information on data protection can be accessed in the Home Connect app.

Declaration of conformity

Robert Bosch Hausgeräte GmbH hereby declares that the appliance with Home Connect functionality meets the basic requirements and other relevant provisions of Directive 2014/53/EU.

A detailed RED Declaration of Conformity can be found online at

www.bosch-home.com

among the additional documents on the product page for your appliance.



Wi-Fi® Module

FCC/IC Statements

Model: COM1

FCC ID: 2AHES-COMGEN1

IC: 21152-COMGEN1

The Home Connect module is a communication device designed to provide communication between appliances and smart devices.

This module is integrated at the factory, under direct control of BSH Home Appliances Corporation, and is not user servicable or upgradable. At least 7⁷/₈ inch (20 cm) separation distance should be maintained from device to user.

FCC COMPLIANCE STATEMENT

⚠ CAUTION

Changes or modifications not expressly approved could void your authority to use this equipment.

This device complies with Part 15 of the FCC Rules. Operation to the following two conditions:

1. This device may not cause harmful interference, and
2. This device must accept any interference received, including interference that may cause undesired operation.

Cleaning and maintenance

With good care and cleaning, your appliance will retain its appearance and remain fully functioning for a long time to come. We will explain here how you should correctly care for and clean your appliance.

⚠ WARNING

Do not clean the appliance while it is still hot. Some cleaners produce noxious fumes when applied to a hot surface. Wet clothes and sponges can cause burns from steam.

⚠ WARNING

RISK OF BURNS

The appliance becomes very hot. Never touch the hot inside surfaces of the oven interior or heating elements. Always allow the appliance to cool down. Keep children away.

⚠ WARNING

RISK OF ELECTRICAL SHOCK

Moisture entering the appliance can cause an electrical shock. Don't use a high-pressure cleaner or steam cleaner.

⚠ WARNING

RISK OF INJURY

Scratched glass in the appliance door can burst. Do not use any glass scrapers or strong or abrasive cleaning agents.

INDUSTRY CANADA STATEMENT

This device complies with Industry Canada licence-exempt RSS standard(s).

Operation is subject to the following two conditions:

1. This device may not cause interference, and
2. This device must accept any interference, including interference that may cause undesired operation of the device.

Suitable cleaning agents

To ensure that the different surfaces are not damaged by using the wrong cleaning agent, follow the information in the following table. Depending on the appliance model, not all of the areas listed may be on/in your appliance.

⚠ CAUTION

SURFACE DAMAGE!

Do not use any

- Harsh or abrasive cleaning agents,
 - Cleaning agents with a high alcohol content,
 - Hard scouring pads or cleaning sponges,
 - High-pressure cleaners or steam cleaners,
 - Special cleaners for cleaning the appliance while it is hot.
-

Wash new sponge cloths thoroughly before use.

Tip: Recommended cleaning and care products can be purchased through customer service. Observe the respective manufacturer's instructions.

⚠ WARNING

RISK OF BURNS

The appliance becomes very hot. Never touch the hot inside surfaces of the oven interior or heating elements. Always allow the appliance to cool down. Keep children away.

Area	Cleaning
Appliance exterior	
Stainless steel front	<p>Hot soapy water: Clean with a dishcloth and then dry with a soft cloth.</p> <p>Remove flecks of lime scale, grease, starch and albumin (e.g. egg white) immediately. Corrosion can form under such flecks.</p> <p>Special stainless steel cleaning products suitable for hot surfaces are available for purchase from customer service or from specialist retailers. Apply a very thin layer of the cleaning product with a soft cloth.</p>
Plastic	<p>Hot soapy water: Clean with a dishcloth and then dry with a soft cloth.</p> <p>Do not use glass cleaner or a glass scraper.</p>
Painted surfaces	<p>Hot soapy water: Clean with a dishcloth and then dry with a soft cloth.</p>
Control panel	<p>Hot soapy water: Clean with a dishcloth and then dry with a soft cloth.</p> <p>Do not use glass cleaner or a glass scraper.</p>
Door panels	<p>Hot soapy water: Clean with a dishcloth and then dry with a soft cloth.</p> <p>Do not use a glass scraper or a stainless steel scouring pad.</p>
Door handle	<p>Hot soapy water: Clean with a dishcloth and then dry with a soft cloth.</p> <p>If descaler comes into contact with the door handle, wipe it off immediately. Otherwise, any stains will not be able to be removed.</p>

Appliance interior

Enamel surfaces and self-cleaning surfaces	Observe the instructions for the surfaces of the cooking compartment that follow the table.
Glass cover for the interior lighting	<p>Hot soapy water: Clean with a dishcloth and then dry with a soft cloth.</p> <p>If the cooking compartment is heavily soiled, use oven cleaner.</p>
Door seal Do not remove.	<p>Hot soapy water: Clean with a dish cloth.</p> <p>Do not scour.</p>
Stainless steel door cover	<p>Stainless steel cleaner: Observe the manufacturer's instructions.</p> <p>Do not use stainless steel care products.</p> <p>Remove the door cover for cleaning.</p>
Rails	<p>Hot soapy water: Soak and clean with a dish cloth or brush.</p>
Accessories	<p>Hot soapy water: Soak and clean with a dish cloth or brush.</p> <p>If there are heavy deposits of dirt, use a stainless steel scouring pad.</p>

Notes

- Slight differences in color on the front of the appliance are caused by the use of different materials, such as glass, plastic and metal.
- Shadows on the door panels, which look like streaks, are caused by reflections made by the interior lighting.
- Enamel is baked on at very high temperatures. This can cause some slight color variation. This is normal and does not affect operation.

The edges of thin trays cannot be completely enameled. As a result, these edges can be rough. This does not impair the anti-corrosion protection.

Surfaces in the cooking compartment

The slightly textured surface of the back wall, ceiling and sides in the cooking compartment are self-cleaning.

The cooking compartment floor is enameled and has a smooth surface.

Cleaning enamel surfaces

Clean the smooth enamel surfaces with a dish cloth and hot soapy water or a vinegar solution. Dry with a soft cloth.

Soften baked-on food residues with a damp cloth and soapy water. If there are heavy deposits of dirt, use a stainless steel scouring pad or oven cleaner.

Leave the cooking compartment open to dry after cleaning.

Note: Food residues can leave a white coating behind. These are harmless and do not affect performance. You can remove these residues using lemon juice if required.

Cleaning self-cleaning surfaces

The self-cleaning surfaces are coated with a porous, matte ceramic layer. This coating absorbs and dispels splashes from baking and roasting while the appliance is in operation.

If the self-cleaning surfaces no longer clean themselves sufficiently and dark stains appear, they can be cleaned using the cleaning function. To do this, refer to the information in the relevant section. → "Cleaning function" on page 27

⚠ CAUTION

Do not use oven cleaner on the self-cleaning surfaces. These will damage the surfaces. If oven cleaner does get onto these surfaces, dab it off immediately using water and a sponge cloth. Do not rub the surface and do not use abrasive cleaning aids.

Keeping the appliance clean

Always keep the appliance clean and remove dirt immediately so that stubborn deposits of dirt do not build up.

Tips

Clean the cooking compartment after each use. This will ensure that dirt cannot be baked on.

Always remove flecks of limescale, grease, starch and albumin (e.g. egg white) immediately.

Use suitable ovenware for roasting, e.g. a roasting dish.

Cleaning function

The self-cleaning surfaces in the cooking compartment are cleaned with the "EcoClean" cleaning function.

The self-cleaning surfaces (back panel, ceiling panel and side panels) are coated with a porous, matt ceramic material. This coating absorbs and breaks down splashes from baking, roasting and grilling while the oven is in operation. If the surfaces no longer clean themselves adequately and dark patches appear, the surfaces can be cleaned by the cleaning function.

Note: The appliance records the number of times it is used. The appliance indicates when it has reached a point in time after which cleaning is recommended. The recommendation is displayed until the cleaning function has finished.

If you do not act on this recommendation, the self-cleaning surfaces may become damaged.

If your appliance becomes prematurely dirty or if you notice dark patches on the back panel, do not wait until your appliance recommends cleaning to do so. The more often the appliance is cleaned, the longer the self-cleaning surfaces will retain their cleaning capability. You can clean your appliance at any time needed using the cleaning function.

Before running the cleaning function

Remove racks, rails, accessories and ovenware from the cooking compartment.

Cleaning the cooking compartment floor and the inside of the appliance door

Remove the worst dirt from the cooking compartment floor, the inside of the appliance door and the interior lighting. Otherwise, patches will appear that cannot be removed.

⚠ CAUTION

Do not use oven cleaner on the self-cleaning surfaces. These will damage the surfaces. If oven cleaner does get onto these surfaces, dab it off immediately using water and a sponge cloth. Do not rub the surface and do not use abrasive cleaning aids.

⚠ WARNING

RISK OF BURNS

⚠ The appliance will become very hot on the outside during the cleaning function. Never touch the appliance door. Allow the appliance to cool down. Keep children away from the appliance.

Setting the cleaning function

Before setting the cleaning function, ensure that you have followed all instructions for preparation.

The duration of the cleaning function is preset to 1 hour. It cannot be changed.

1. Touch the **menu** field.

The list of operating modes is displayed.

2. Touch the "EcoClean" text field.

3. Press the Start/Stop button  to start.

The cooking time will count down on the display. The heating line does not appear for the cleaning function.

The cleaning function starts.

Ventilate the kitchen when the cleaning function is running.



When the cleaning function has ended, an audible signal sounds. The cooking time 00 m 00 s is shown in the display. Press the  On/Off button to switch off the appliance.

Setting a later end time

You can set a later end time. Before starting the appliance, touch the "End" text field and set a later end time using the rotary selector.

The appliance switches to standby after it is started. The end time can no longer be changed.

Cancelling

If you would like to cancel the cleaning function, switch the appliance off using the  On/Off button. You can no longer pause the operation using the  Start/Stop button.

Note: The operating hour counter is not reset. The instruction for the cleaning function is still shown on the display.

Once the cleaning function has ended

Once the cooking compartment has cooled down, wipe down the cooking compartment with a damp cloth if necessary.

Note: During operation and while the cleaning function is active, reddish patches may form on the surfaces. This is not rust, but food residues. These patches are not hazardous to your health and do not limit the cleaning capacity of the self-cleaning surfaces.

Rails

With good care and cleaning, your appliance will retain its appearance and remain fully functioning for a long time to come. This will tell you how to remove the shelves and clean them.

Detaching and refitting the rails

⚠ WARNING

RISK OF BURNS

The rails become very hot. Never touch the hot rails. Always allow the appliance to cool down. Keep children away from the appliance.

Detaching the rails

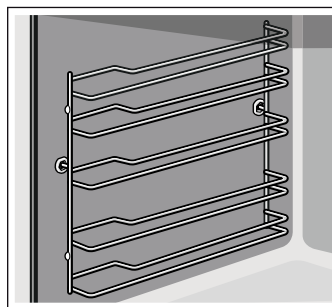

1. Lift the rail slightly at the front **a** and detach it **b** (figure **1**).
2. Then pull the whole rail to the front and remove it (figure **2**).

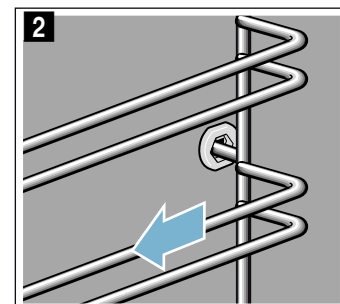
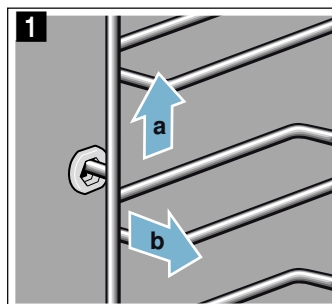

Clean the rails with cleaning agent and a sponge. For stubborn dirt deposits, use a brush.

Attaching the rails

The rails only fit on the right or the left side. For both rails, ensure that the curved rods are at the front.

1. First, insert the rail in the middle into the rear socket **a**, until the rail rests against the cooking compartment wall, and push it back slightly **b** (figure **1**).
2. Then insert the rail into the front socket **c**, until the rail also rests against the cooking compartment wall here and press it downwards **d** (figure **2**).

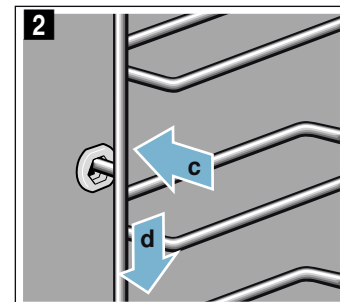
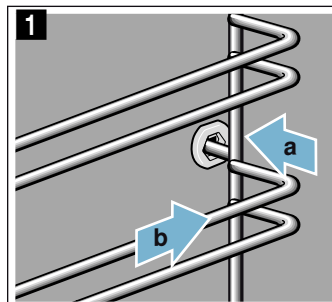

Appliance door

With good care and cleaning, your appliance will retain its appearance and remain fully functioning for a long time to come. This will tell you how to remove the appliance door and clean it.

⚠ CAUTION

WHEN REMOVING THE OVEN DOOR:

- Make sure oven is cool and power to the oven has been turned off before removing the door. Failure to do so could result in electrical shock or burns.
- The oven door is heavy and parts of it are fragile. Use both hands to remove the oven door. The door front includes glass components. Handle carefully to avoid breakage.
- Grasp only the sides of the oven door. Do not grasp the handle as it may swing in your hand and cause damage or injury.
- Failure to grasp the oven door firmly and properly could result in personal injury or product damage.
- To avoid injury from hinge bracket snapping closed, be sure that both locking levers are securely in place before removing the door. Also, do not force the oven door open or closed - the hinge could be damaged and injury could result.
- Do not lay the removed door on sharp or pointed objects as this could break the glass. Lay the door on a flat, smooth surface, positioned so that the door cannot fall over.

Removing and fitting the appliance door

To clean and remove the door panels, you can detach the appliance door.

The oven door hinges each have a locking lever. When the locking levers are closed (figure A **1**), the oven door is secured in place. It cannot be detached. When the locking levers are open in order to detach the oven door (figure **2**), the hinges are locked. They cannot snap shut.

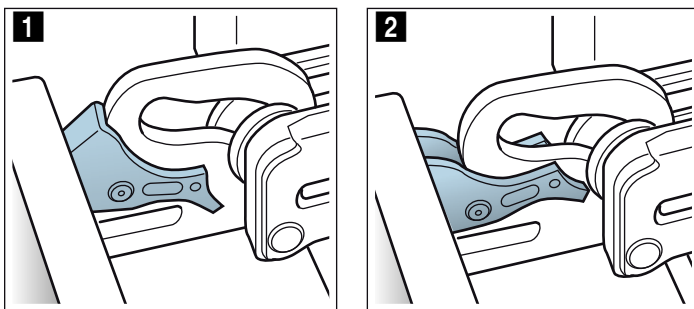

⚠ WARNING

RISK OF INJURY

- Whenever the hinges are not locked, they can snap shut with great force. Ensure that the locking levers are always fully closed or, when detaching the appliance door, fully open.

⚠ WARNING

- The hinges on the appliance door move when opening and closing the door, and you may be pinched. Keep your hands away from the hinges.

Removing the appliance door

1. Open the appliance door fully and push it in the direction of the appliance.
2. Open the two locking levers on the left and right (figure **1**).
3. Close the appliance door as far as it goes **a**. With both hands, grip the door on the left- and right-hand side **b** and pull it up and out (figure **2**).

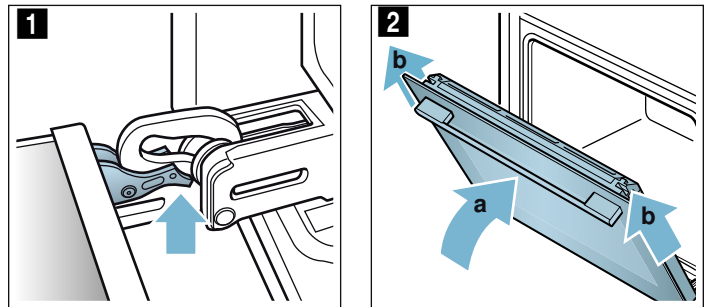

Refitting the appliance door

Follow the instructions in the reverse order to refit the appliance door.

1. When fitting the appliance door, ensure that both hinges are inserted straight into the opening (figure **1**).
Place both hinges at the bottom on the outer panel and use this as a guide.
Ensure that the hinges are inserted into the correct opening. You must be able to insert them easily and without resistance. If you can feel any resistance, check that the hinges are inserted into the correct opening.

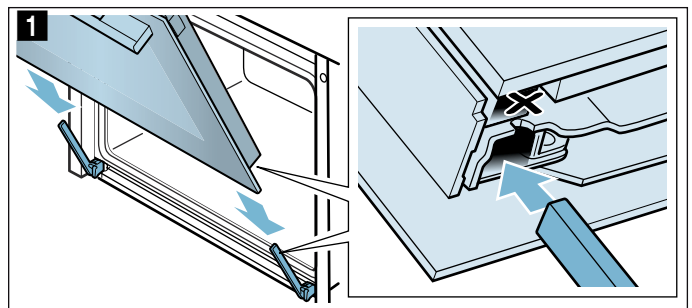

- Open the appliance door fully. Close the two locking levers (figure 2).

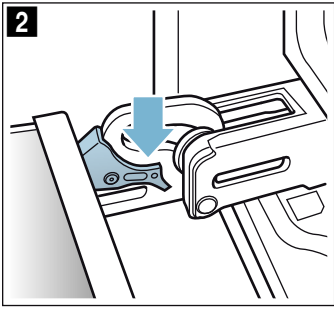

- Close the cooking compartment door.

Removing the door cover

The stainless steel insert in the door cover can discolor. To carry out thorough cleaning, you can remove the cover.

- Open the appliance door a little.
- Press on the left and right of the cover (figure 1).
- Remove the cover (figure 2).
Close the appliance door carefully.

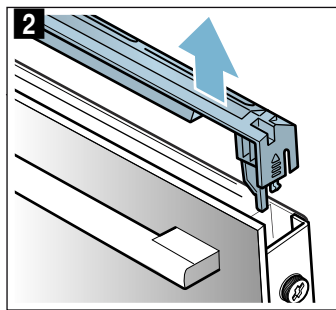
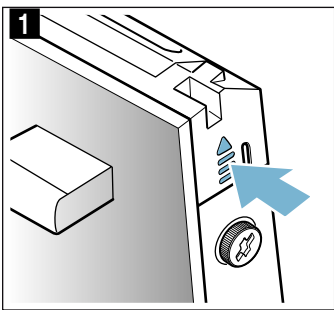

Note: Clean the stainless steel insert in the cover with stainless steel cleanser. Clean the rest of the door cover with dishwashing detergent and a soft cloth.

- Open the appliance door a little again. Put the cover back in place and press on it until it clicks audibly into place (figure 3).

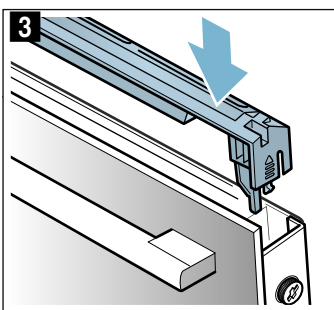

- Close the appliance door.

Removing and installing the door panels

For better cleaning, you can remove the glass panels from the appliance door.

Removing door panels from the appliance

- Open the appliance door a little.
- Press on the left and right of the cover (figure 1).
- Remove the cover (figure 2).

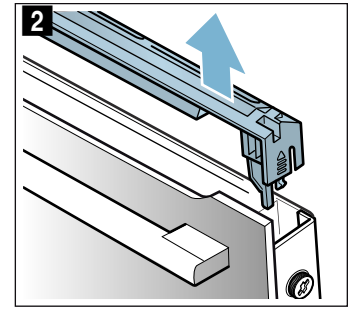
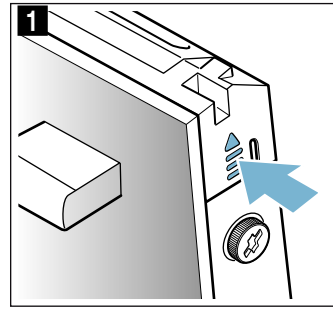

- Undo and remove the screws on the left and right of the appliance door (fig. 3).
- Fold a dish towel several times and place it between the appliance and the door before shutting the door on the dish towel (figure 4).
Pull out the front panel upwards and lay it on a flat surface with the door handle facing downwards.

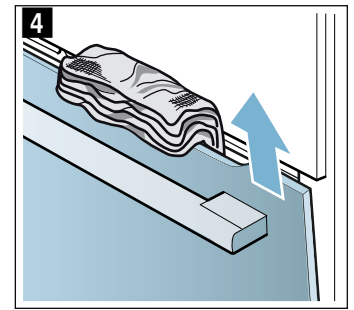
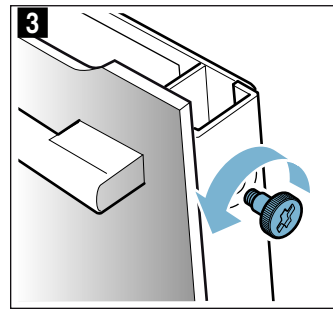

Clean the panels with glass cleaner and a soft cloth.

▲ WARNING

RISK OF INJURY

- Scratched glass in the appliance door can burst. Do not use any glass scrapers or strong or abrasive cleaning agents.

▲ WARNING

- The hinges on the appliance door move when opening and closing the door, and you may be pinched. Keep your hands away from the hinges.

Refitting door panels on the appliance

1. Insert the front panel downwards into the retainers (figure 1).
2. Close the front panel until the two upper hooks are opposite the opening (figure 2).

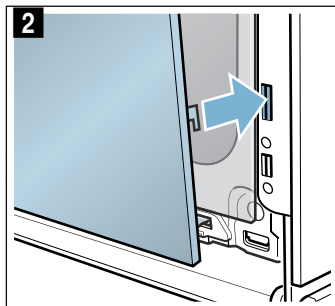
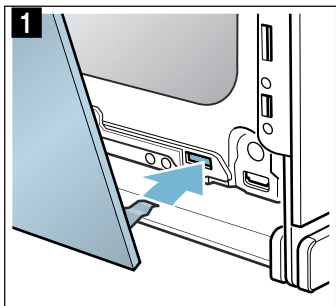

3. Push the front panel in at the bottom until you hear it click into place (figure 3).
4. Open the appliance door a little and remove the dish towel.

5. Screw both screws back in on the left and right.
6. Put the cover back in place and press on it until it clicks audibly into place (figure 4).

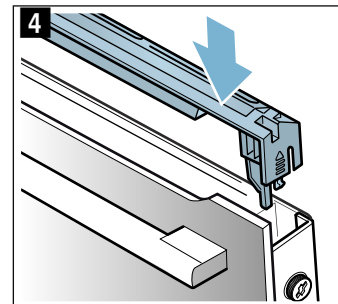
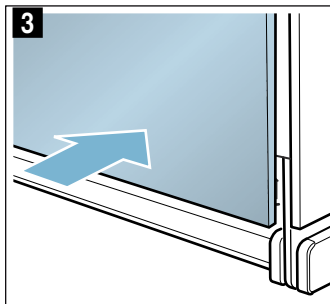

7. Close the appliance door.

⚠ CAUTION

Do not use the cooking compartment again until the panels have been correctly fitted.

Troubleshooting

Faults often have simple explanations. Before calling customer service, please refer to the table below and attempt to correct the fault yourself.

⚠ CAUTION

Repairs should only be done by an authorized servicer.
Improper repair of your appliance may result in risk of severe physical injury or death.

Eliminating faults yourself

You can often easily eliminate technical faults on the appliance yourself.

If a dish does not turn out exactly as you wanted, you can find many tips and instructions for preparation at the end of the operating manual. → "Tested for you in our cooking studio" on page 37

Fault	Possible cause	Notes/remedy
The appliance does not work.	Faulty fuse.	Check the circuit breaker in the fuse box.
	Power failure	Check whether the kitchen light or other kitchen appliances are working.
"Language English" appears on the display.	Power failure	Reset the language and the time.
The time does not appear when the appliance is switched off.	Basic setting is changed.	Change the basic setting for the clock display.
The appliance does not heat up; the  symbol lights up on the display.	Demo mode is activated in the basic settings.	Briefly disconnect the appliance from the mains (switch off the circuit breaker in the fuse box) and then deactivate demo mode in the basic settings within 3 minutes.
The appliance will not start and "Cooking compartment too hot" appears on the display	The cooking compartment is too hot for the selected dish or type of heating	Allow the cooking compartment to cool down and start again
The rotary selector has fallen out of the support in the control panel.	The rotary selector has been accidentally disengaged.	The rotary selector can be removed. Simply place the rotary selector back in its support in the control panel and push it in so that it engages and can be turned as usual.

The rotary selector can no longer be turned easily.

There is dirt under the rotary selector.

The rotary selector can be removed. To disengage the rotary selector, simply remove it from the support. Alternatively, press on the outer edge of the rotary selector so that it tips and can be picked up easily.

Carefully clean the rotary selector and its support on the appliance using a cloth and soapy water. Dry with a soft cloth. Do not use any sharp or abrasive materials. Do not soak or clean in the dishwasher.

Do not remove the rotary selector too often so that the support remains stable.

HomeConnect does not work correctly.

Go to www.home-connect.com

▲ WARNING

RISK OF ELECTRIC SHOCK

Improper repairs are dangerous. Only an authorized servicer may perform repairs and may replace damaged plug and connections. Remove the power plug or turn off the circuit breaker or fuse in the fuse box if the appliance is damaged or not working. Call Customer Service.

Error messages on the display

When an error message appears on the display with "D" or "E", e.g. D0111 or E0111, switch the appliance off and on again using the Ⓜ On/Off button.

If it was a one-time error, the display goes out. If the error message appears again, call customer service and quote the exact error message.

Maximum operating time

If you do not change the settings on your appliance for several hours, the appliance stops heating up automatically. This prevents unwanted continuous operation.

The respective settings for the operating mode govern when the maximum operating time is reached.

Maximum operating time reached

A note appears on the display confirming that the maximum operating time has been reached.

To continue operation, touch any field or turn the rotary selector.

Switch the appliance off using the Ⓜ On/Off button if you do not need to use it.

Tip: Set a cooking time so that the appliance does not switch off when you do not want it to, e.g. with an extremely long preparation time. The appliance heats up until the set cooking time has elapsed.

Replacing the cooking compartment bulb on the ceiling

If the cooking compartment light bulb burns out, it must be replaced. Heat-resistant, 40 watt, 230 V halogen bulbs are available from customer service or specialist retailers.

When handling the halogen bulb, use a dry cloth. This will increase the service life of the bulb. Only use these bulbs.

▲ WARNING

Light socket is live when door is open if main power supply is not turned off.

▲ WARNING

Make sure the appliance and lights are cool and power to the appliance has been turned off before replacing the light bulb(s). Failure to do so could result in electrical shock or burns. The lenses (if equipped) must be in place when using the appliance. The lenses (if equipped) serve to protect the light bulb from breaking. The lenses (if equipped) are made of glass. Handle carefully to avoid breaking. Broken glass can cause an injury.

▲ WARNING

RISK OF ELECTRIC SHOCK

When you replace the oven interior lamp, the contacts of the lamp holder are live. Before replacing the lamp, remove the power plug or deactivate the circuit breaker or fuse in the fuse box.

▲ WARNING

RISK OF BURNS

The appliance becomes very hot. Never touch the hot inside surfaces of the oven interior or heating elements. Always allow the appliance to cool down. Keep children away.

1. Place a dish towel in the cold cooking compartment to prevent damage.
2. Turn the glass cover counter-clockwise to remove it (figure 1).
3. Pull out the bulb – do not turn it (figure 2). Insert the new bulb, making sure that the pins are in the correct position. Push the bulb in firmly.

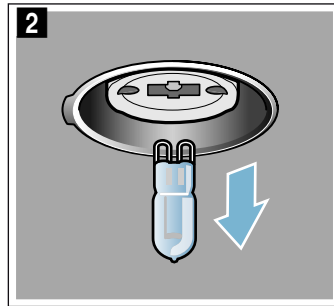
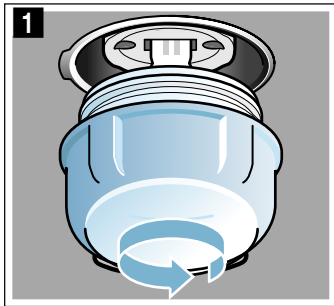

4. Screw the glass cover back on. Depending on the appliance model, the glass cover may have a sealing ring. If the glass cover has a sealing ring, put it back in place before screwing the cover back on.
5. Remove the dish towel and switch on the circuit breaker.

Glass cover

If the glass cover of the halogen bulb is damaged, it must be replaced. You can obtain a new glass cover from customer service. Please specify the E number and FD number of your appliance.

Customer Service

Before Calling Service

See the Use and Care Manual for troubleshooting information. Refer to the “Statement of Limited Product Warranty” in the Use and Care Manual.

To reach a service representative, see the contact information at the front of the manual or in the following section. Please be prepared with the information printed on your product data plate prior to calling.

Data Plate

The data plate shows the model and serial number. Refer to the data plate on the appliance when requesting service.

The data plate can be found at the left side of the oven cavity.

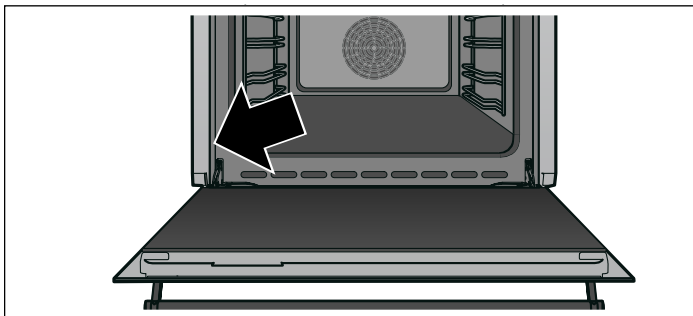

To avoid having to search for each piece of information when calling, you can enter the four items needed in the spaces provided below.

Model No.
FD-No.
Date of Purchase
Customer Service ☎

Keep your invoice or escrow papers for warranty validation if service is needed.

Service

We realize that you have made a considerable investment in your kitchen. We are dedicated to supporting you and your appliance so that you have many years of creative cooking.

Please don't hesitate to contact our Customer Support Department if you have any questions or in the unlikely event that your Bosch® appliance needs service. Our service team is ready to assist you.

USA

800-944-2904

www.bosch-home.com/us/support

Canada

800-944-2904

www.bosch-home.ca/en/support

Parts and Accessories

Parts, filters, descalers, stainless steel cleaners and more can be purchased in the Bosch® eShop or by phone.

USA

www.bosch-home.com/us/store

Canada

Marcone 800-482-6022

or

Reliable Parts 800-941-9217

STATEMENT OF LIMITED PRODUCT WARRANTY

What this Warranty Covers & Who it Applies to

The limited warranty provided by BSH Home Appliances Corporation ("BSH") in this Statement of Limited Product Warranty applies only to the Bosch appliance ("Product") sold to you, the first using purchaser, provided that the Product was purchased:

- For your normal, household (non-commercial) use, and has in fact at all times only been used for normal household purposes.
- New at retail (not a display, "as is", or previously returned model), and not for resale, or commercial use.
- Within the United States or Canada, and has at all times remained within the country of original purchase.

The warranties stated herein apply only to the first purchaser of the Product and are not transferable.

Please make sure to return your registration card; while not necessary to effectuate warranty coverage, it is the best way for BSH to notify you in the unlikely event of a safety notice or product recall.

How Long the Warranty Lasts

BSH warrants that the Product is free from defects in materials and workmanship for a period of three hundred sixty-five (365) days from the date of purchase. The foregoing timeline begins to run upon the date of purchase, and shall not be stalled, tolled, extended, or suspended, for any reason whatsoever.

This Product is also warranted to be free from *cosmetic* defects in material and workmanship (such as scratches of stainless steel, paint/porcelain blemishes, chip, dents, or other damage to the finish of the Product), for a period of thirty (30) days from the date of purchase or closing date for new construction. This *cosmetic* warranty excludes slight color variations due to inherent differences in painted and porcelain parts, as well as differences caused by kitchen lighting, product location, or other similar factors. This *cosmetic* warranty specifically excludes any display, floor, "As Is", or "B" stock appliances.

Repair/Replace as Your Exclusive Remedy

During this warranty period, BSH or one of its authorized service providers will repair your Product without charge to you (subject to certain limitations stated herein) if your Product proves to have been manufactured with a defect in materials or workmanship. If reasonable attempts to repair the Product have been made without success, then BSH will replace your Product (upgraded models may be available to you, in BSH's sole discretion, for an additional charge). All removed parts and components shall become the property of BSH at its sole option. All replaced and/or repaired parts shall assume the identity of the original part for purposes of this warranty and this warranty shall not be extended with respect to such parts. BSH's sole liability and responsibility hereunder is to repair manufacturer-defective Product only, using a

BSH-authorized service provider during normal business hours. For safety and property damage concerns, BSH highly recommends that you do not attempt to repair the Product yourself, or use an un-authorized servicer; BSH will have no responsibility or liability for repairs or work performed by a non-authorized servicer. If you choose to have someone other than an authorized service provider work on your Product, THIS WARRANTY WILL AUTOMATICALLY BECOME NULL AND VOID. Authorized service providers are those persons or companies that have been specially trained on BSH products, and who possess, in BSH's opinion, a superior reputation for customer service and technical ability (note that they are independent entities and are not agents, partners, affiliates or representatives of BSH). Notwithstanding the foregoing, BSH will not incur any liability, or have responsibility, for the Product if it is located in a remote area (more than 100 miles from an authorized service provider) or is reasonably inaccessible, hazardous, threatening, or treacherous locale, surroundings, or environment; in any such event, if you request, BSH would still pay for labor and parts and ship the parts to the nearest authorized service provider, but you would still be fully liable and responsible for any travel time or other special charges by the service company, assuming they agree to make the service call.

Out of Warranty Product

BSH is under no obligation, at law or otherwise, to provide you with any concessions, including repairs, pro-rates, or Product replacement, once this warranty has expired.

Warranty Exclusions

The warranty coverage described herein excludes all defects or damage that are not the direct fault of BSH, including without limitation, one or more of the following:

- Use of the Product in anything other than its normal, customary and intended manner (including without limitation, any form of commercial use, use or storage of an indoor product outdoors, use of the Product in conjunction with air or water-going vessels).
- Any party's willful misconduct, negligence, misuse, abuse, accidents, neglect, improper operation, failure to maintain, improper or negligent installation, tampering, failure to follow operating instructions, mishandling, unauthorized service (including self-performed "fixing" or exploration of the appliance's internal workings).
- Adjustment, alteration or modification of any kind.
- A failure to comply with any applicable state, local, city, or county electrical, plumbing and/or building codes, regulations, or laws, including failure to install the product in strict conformity with local fire and building codes and regulations.
- Ordinary wear and tear, spills of food, liquid, grease accumulations, or other substances that accumulate on, in, or around the Product.

- Any external, elemental and/or environmental forces and factors, including without limitation, rain, wind, sand, floods, fires, mud slides, freezing temperatures, excessive moisture or extended exposure to humidity, lightning, power surges, structural failures surrounding the appliance, and acts of God.

In no event shall BSH have any liability or responsibility whatsoever for damage to surrounding property, including cabinetry, floors, ceilings, and other structures or objects around the Product. Also excluded from this warranty are Products on which the serial numbers have been altered, defaced, or removed; service visits to teach you how to use the Product, or visits where there is nothing wrong with the Product; correction of installation problems (you are solely responsible for any structure and setting for the Product, including all electrical, plumbing or other connecting facilities, for proper foundation/flooring, and for any alterations including without limitation cabinetry, walls, floors, shelving, etc.); and resetting of breakers or fuses.

TO THE EXTENT ALLOWED BY LAW, THIS WARRANTY SETS OUT YOUR EXCLUSIVE REMEDIES WITH RESPECT TO PRODUCT, WHETHER THE CLAIM ARISES IN CONTRACT OR TORT (INCLUDING STRICT LIABILITY, OR NEGLIGENCE) OR OTHERWISE. THIS WARRANTY

IS IN LIEU OF ALL OTHER WARRANTIES, WHETHER EXPRESS OR IMPLIED. ANY WARRANTY IMPLIED BY LAW, WHETHER FOR MERCHANTABILITY OR FITNESS FOR A PARTICULAR PURPOSE, OR OTHERWISE, SHALL BE EFFECTIVE ONLY FOR THE PERIOD THAT THIS EXPRESS LIMITED WARRANTY IS EFFECTIVE. IN NO EVENT WILL THE MANUFACTURER BE LIABLE FOR CONSEQUENTIAL, SPECIAL, INCIDENTAL, INDIRECT, "BUSINESS LOSS", AND/OR PUNITIVE DAMAGES, LOSSES, OR EXPENSES, INCLUDING WITHOUT LIMITATION TIME AWAY FROM WORK, HOTELS AND/OR RESTAURANT MEALS, REMODELLING EXPENSES IN EXCESS OF DIRECT DAMAGES WHICH ARE DEFINITELY CAUSED EXCLUSIVELY BY BSH, OR OTHERWISE. SOME STATES DO NOT ALLOW THE EXCLUSION OR LIMITATION OF INCIDENTAL OR CONSEQUENTIAL DAMAGES, AND SOME STATES DO NOT ALLOW LIMITATIONS ON HOW LONG AN IMPLIED WARRANTY LASTS, SO THE ABOVE LIMITATIONS MAY NOT APPLY TO YOU. THIS WARRANTY GIVES YOU SPECIFIC LEGAL RIGHTS, AND YOU MAY ALSO HAVE OTHER RIGHTS WHICH VARY FROM STATE TO STATE. No attempt to alter, modify or amend this warranty shall be effective unless authorized in writing by an officer of BSH.

Dishes

You can use the "Assist" operating mode to prepare a wide variety of food. The appliance selects the optimal settings for you.

To achieve good results, the cooking compartment must not be too hot for the type of food you have selected. If it is, a message will appear on the display. Allow the cooking compartment to cool down and start again.

Information on the settings

- The cooking result depends on the quality of the food and the size and type of cookware. For an optimal cooking result, use food that is in good condition and chilled meat only. For frozen food, use food straight out of the freezer only.
- For some food, a temperature, heating mode and cooking time is suggested. The temperature and the cooking time can be changed according to your requirements.
- When roasting dishes for which the appliance will apply the temperature selection for you, temperatures of up to 570° F (300 °C) can be saved. Therefore, make sure that you use cookware that is sufficiently heat resistant.
- Information is provided, e.g. on cookware, rack position or the addition of liquid when cooking meat. Some food requires turning or stirring, etc. during cooking. This is shown in the display shortly after operation starts. An audible signal will remind you at the right time.
- Information on the right kind of cookware to use and tips and tricks for the preparation can be found at the end of the instruction manual. → "Tested for you in our cooking studio" on page 37

Selecting a dish

The dishes are arranged in a uniform structure:

- Category
- Food
- Dish

The following table lists the categories with the corresponding food. One or more dishes are listed beside each food.

Categories	Food
Cake	Cakes in tins
	Cakes on baking trays
	Small baked items
	Cookies
Bread/bread rolls	Bread
	Bread rolls
Pizza, savory cakes	Pizza
	Savory cakes, quiche
Bakes, soufflés	Casserole, savory, fresh, cooked ingredients
	Lasagna, fresh
	Potatoes au gratin
	Casserole, sweet
	Soufflé in individual molds
	Fruit crisp

Categories	Food
Frozen products	Pizza
	Bread rolls
	Casseroles
	Potato products
	Poultry, fish
Poultry	Chicken
	Duck, goose
	Turkey
Meat	Pork
	Beef
	Lamb
	Meat dishes
Fish	Fish
Vegetables	Vegetables au gratin
	Baked potatoes, halved
	Whole baked potatoes



Applying settings for dishes

You will be guided through the entire setting process for your chosen food.

Use the rotary selector to scroll through the individual levels.

1. Touch the **menu** field.
The list of operating modes is displayed.
2. Touch the "Assist" text field.
The categories are displayed.
3. Touch the required category.
The foods in this category are displayed.
4. Touch the required food.
The individual dishes are displayed.
5. Touch the required dish.
The settings for this dish appear on the display. For many dishes, you can change the settings to suit your needs.

Tip:The "Tip" text field provides you with information about accessories and rack height.

6. Press the Start/Stop button  to start.
The cooking time will count down on the display.
The appliance begins to heat up.
Once the cooking time has elapsed, an audible signal sounds. The appliance stops heating up.
When your dish is ready, use the  On/Off button to switch off the appliance.

Continue cooking

After the cooking time has ended, you can leave some dishes to continue cooking if you are not satisfied with the cooking result.

A query appears on the display, which asks if you want to continue cooking. If you want to continue cooking, touch the "Extend cooking time" text field. A cooking time is suggested, which can be changed. Press the  Start/Stop button to start.

Note: You can extend the cooking time as often as required.

If you are satisfied with the cooking result, touch the "Finish" text field.

Press the  On/Off button to switch off the appliance.



Setting a later end time

You can set a later end time for some dishes. Before starting the appliance, touch the "End" text field and set a later end time using the rotary selector.

The appliance switches to standby after it is started. The end time can no longer be changed.

Changing and cancelling

After starting the appliance, the settings can no longer be changed.

If you would like to cancel the operation, switch the appliance off using the  On/Off button. You can no longer pause the operation using the  Start/Stop button.

Tested for you in our cooking studio

Here, you can find a selection of dishes and the ideal settings for them. We will show you which heating method and temperature are best suited to your dish. You will be provided with information on suitable cooking accessories and the height at which they should be placed in the oven. You will also be provided with tips about cookware and preparation methods.

Note: A lot of steam can build up in the cooking compartment when cooking food.

Your appliance is very energy-efficient and radiates very little heat to its surroundings during operation. Due to the high difference in temperature between the appliance interior and the external parts of the appliance, condensation may build up on the door, control panel, or adjacent kitchen cabinet panels. This is a normal physical phenomenon. Condensation can be reduced by preheating the oven or opening the door carefully.

Cakes and small baked items

Your appliance offers you a range of heating types for the preparation of cakes and small baked items. You can find the ideal settings for many dishes in the settings tables.

Also refer to the notes in the section on allowing dough to rise.

Only use original accessories supplied with your appliance. These have been tailored to the cooking compartment and the operating modes of your appliance.

Rack positions

Use the indicated rack positions.

Baking on one rack

When baking on one rack, use the following rack positions:

- Tall baked items: rack position 2
- Flat baked items: rack position 3

If you are using Convection Multi-Rack as the heating mode, you can choose between rack positions 1, 2, 3 and 4.

Baking on several racks

Use Convection Multi-Rack. Baked items that are placed into the oven on two racks at the same time will not necessarily be ready at the same time.

Baking on two racks:

- First wire rack: rack position 3
- Second wire rack: rack position 1

Baking on three racks:

- First wire rack: rack position 5
- Second wire rack: rack position 3
- Third wire rack: rack position 1

Position baking tins/dishes next to one another or offset and vertically stacked in the cooking compartment.

Accessories

Ensure that you always use suitable accessories and that they are placed in the oven the right way around.

Wire Rack

Insert the wire rack with the open side facing the appliance door and the curved lip pointing downwards. Always place cookware, tins, and dishes on the wire rack.

Baking pans

Shiny aluminum baking pans are most suitable.

Tinplate baking pans, ceramic dishes and glass dishes extend baking time and mean that the baked item will not brown evenly. If you wish to bake using these baking pans/dishes and using top/bottom heating, slide in the pan/dish at rack position 1.

Parchment Paper

Only use parchment paper that is suitable for the selected temperature. Always cut parchment paper to size.

Recommended setting values



The table lists the optimal heating modes for various baked items. The temperature and baking time depend on the amount and consistency of the dough/mixture. For this reason, the table specifies setting ranges. Try using the lower values to start with. A lower temperature will result in more even browning. You can use a higher setting next time if necessary.

Note: Baking times cannot be reduced by using higher temperatures. Cakes or small baked items would only be cooked on the outside, and would not be fully baked in the middle.





















If you wish to follow one of your own recipes when baking, you should use the setting values listed for similar baked items in the table as reference. Additional information can be found in the baking tips listed after the settings table.

Remove unused accessories from the cooking compartment. This will ensure that you achieve the best possible cooking results.

Heating methods used:

-  Convection Multi-Rack
-  Bake
-  Pizza

Dish	Accessories / cookware	Rack position	Heating mode	Temperature in °F (°C)	Cooking time in mins.
Cakes in pans					
Sponge cake, simple	Cake pan/cake tin	3		300-340 (150-170)	50-70
Sponge cake, simple, 2 racks	Cake pan/cake tin	3+1		285-320 (140-160)	25-35
Sponge cake, delicate	Cake pan/cake tin	2		300-340 (150-170)	60-80
Sponge flan base	Flan base tin	3		320-355 (160-180)	20-30
Fruit tart or cheesecake with shortcrust pastry base	Springform cake pan, Ø10 ¹ / ₄ " (26 cm)	2		340-375 (170-190)	60-80
Swiss flan	Pizza tray	3		430-465 (220-240)	35-45
Tart	Flan-base cake tin, black	3		375-410 (190-210)	30-45
Bundt yeast cake	Bundt cake pan	2		300-340 (150-170)	50-70
Yeast cake	Springform cake pan, Ø11" (28 cm)	2		320-340 (160-170)	20-30
Sponge base, 2 eggs	Flan base tin	3		300-340 (150-170)	20-30
Sponge flan, 3 eggs	Springform cake pan, Ø10 ¹ / ₄ " (26 cm)	2		320-340 (160-170)	25-35
Sponge flan, 6 eggs	Springform cake pan, Ø11" (28 cm)	2		300-340 (150-170)	30-50
Cakes on baking sheets					
Sponge cake with topping	Baking sheet	3		320-355 (160-180)	20-40
Sponge cake, 2 racks	Baking sheets	1+3		285-320 (140-160)	30-50
Shortcrust tart with dry topping	Baking sheet	3		340-375 (170-190)	20-30
Shortcrust tart with dry topping, 2 racks	Baking sheets	1+3		320-340 (160-170)	35-45
Shortcrust tart with moist topping	Baking sheet	3		320-355 (160-180)	55-65
Swiss flan	Baking sheet	3		390-410 (200-210)	40-50
Yeast cake with dry topping	Baking sheet	3		320-355 (160-180)	15-20
Yeast cake with dry topping, 2 racks	Baking sheets	1+3		300-340 (150-170)	20-30
Yeast cake with moist topping	Baking sheet	3		355-390 (180-200)	30-40
Yeast cake with moist topping, 2 racks	Baking sheets	1+3		300-340 (150-170)	45-60
Braided loaf, savarin	Baking sheet	2		320-340 (160-170)	25-35
Swiss roll	Baking sheet	3		355-390 (180-200)	8-15
Strudel, sweet	Baking sheet	2		375-410 (190-210)	55-65
Strudel, frozen	Baking sheet	3		390-430 (200-220)	35-45

Dish	Accessories / cookware	Rack position	Heating mode	Temperature in °F (°C)	Cooking time in mins.
Small baked items					
Cupcakes	Muffin tray	3		320 (160)	25-35
Cupcakes	Muffin tray	3		300 (150)	25-35
Cupcakes, 2 racks	Muffin trays	1+3		300 (150)	30-40
Cupcakes, 3 racks	Muffin trays	5+3+1		285 (140)	35-45
Muffins	Muffin tray	3		340-375 (170-190)	15-20
Muffins, 2 racks	Muffin trays	3+1		320-355 (160-180)	15-40
Puff pastry	Baking sheet	3		340-375 (170-190)	20-35
Puff pastry, 2 racks	Baking sheets	3+1		340-375 (170-190)	20-45
Puff pastry, 3 racks	Baking sheets	5+3+1		340-375 (170-190)	20-45
Puff pastry, flat, 4 racks	Baking sheets	5+3+2+1		355-390 (180-200)	20-35
Danish pastry	Baking sheet	3		320-355 (160-180)	20-30
Cookies					
Shortbread	Baking sheet	3		285-300 (140-150)	25-40
Shortbread	Baking sheet	3		285-300 (140-150)	25-40
Shortbread, 2 racks	Baking sheets	3+1		285-300 (140-150)	30-40
Shortbread, 3 racks	Baking sheets	5+3+1		265-285 (130-140)	35-55
Cookies	Baking sheet	3		285-320 (140-160)	15-30
Cookies, 2 racks	Baking sheets	3+1		285-320 (140-160)	15-30
Cookies, 3 racks	Baking sheets	5+3+1		285-320 (140-160)	15-30
Macaroons	Baking sheet	3		195-230 (90-110)	20-40
Macaroons, 2 racks	Baking sheets	3+1		195-230 (90-110)	25-45
Macaroons, 3 racks	Baking sheets	5+3+1		195-230 (90-110)	30-45

Tips on baking

You want to find out whether the cake is completely cooked in the middle.	Push a toothpick into the highest point on the cake. If the toothpick comes out clean with no dough residue, the cake is ready.
The cake collapses.	Next time, use less liquid. Alternatively, set the temperature to be 50° F (10 °C) lower and extend the baking time. Adhere to the specified ingredients and preparation instructions in the recipe.
The cake has risen in the middle but is lower around the edge.	Only grease the base of the springform cake pan. After baking, loosen the cake carefully with a knife.
The fruit juice overflows.	Next time, line the baking sheet with aluminum foil.

Small baked items stick to one another during baking.	There should be a gap of approx. 1 inch (2 cm) around each item. This gives enough space for the baked items to expand well and brown on all sides.
The cake is too dry.	Set the temperature 50° F (10 °C) higher and shorten the baking time.
The cake is generally too light in color.	If the rack position and the cookware are correct, then you should increase the temperature if necessary or extend the baking time.
The cake is too light on top, and too dark underneath.	Bake the cake one rack level higher in the oven the next time.
The cake is too dark on top, and too light underneath.	Bake the cake one rack level lower in the oven the next time. Select a lower temperature and extend the baking time.
Cakes baked in a tray or tin are too brown at the back.	Place the baking tray in the middle of the accessories, not directly against the back wall.
The whole cake is too dark.	Select a lower temperature next time and extend the baking time if necessary.
The cake is unevenly browned.	Select a slightly lower temperature. Protruding greaseproof paper can affect the air circulation. Always cut greaseproof paper to size. Ensure that the baking tin does not stand directly in front of the openings in the cooking compartment back wall. When baking small items, you should use similar sizes and thicknesses wherever possible.
You were baking on several levels. The items on the top rack are darker than those on the lower rack.	Always select Convection Multi-Rack when baking on several levels. Baked items that are placed into the oven on trays or in baking tins/dishes at the same time will not necessarily be ready at the same time.
The cake looks good, but is not cooked properly in the middle.	Use a lower temperature and bake slightly longer; if necessary, add slightly less liquid. For cakes with a moist topping, bake the base first. Sprinkle it with almonds or flour and then place the topping on top.
The cake cannot be turned out of the dish when it is turned upside down.	Allow the cake to cool down for 5 to 10 minutes after baking. If it still sticks, carefully loosen the cake around the edges again using a knife. Turn the cake pan upside down again and cover it several times with a cold, wet cloth. Next time, grease the baking tin/dish and sprinkle with flour.

Bread and Rolls

Your appliance offers you a range of heating methods for baking bread and rolls. You can find the ideal settings for many dishes in the settings tables.

Also refer to the notes in the section on allowing dough to rise.

Only use original accessories supplied with your appliance. These have been tailored to the cooking compartment and operating modes of your appliance.

Rack positions

Use the indicated rack positions.

Baking on one rack

When baking on one rack, use the following rack positions:

- Tall baked items: rack position 2
- Flat baked items: rack position 3

If you are using Convection Multi-Rack as the heating mode, you can choose between rack positions 1, 2, 3 and 4.

Baking on two racks

Use Convection Multi-Rack. Baked items that are placed into the oven on two racks at the same time will not necessarily be ready at the same time.

Baking tins/dishes on the wire rack:

- First wire rack: rack position 3
- Second wire rack: rack position 1

Position baking tins/dishes next to one another or offset and vertically stacked in the cooking compartment.

Accessories

Ensure that you always use suitable accessories and that they are placed in the oven the right way around.

Wire Rack

Insert the wire rack with the open side facing the appliance door and the curved lip pointing downwards. Always place cookware, tins, and dishes on the wire rack.

Baking pans

Shiny aluminum baking pans are most suitable.

Tinplate baking pans, ceramic dishes and glass dishes extend baking time and mean that the baked item will not brown evenly. If you wish to bake using these baking pans/dishes and using top/bottom heating, slide in the pan/dish at rack position 1.

Parchment Paper

Only use parchment paper that is suitable for the selected temperature. Always cut parchment paper to size.

Frozen Products

Do not use frozen products that are heavily frosted. Remove any ice on the food.

Some frozen products may be unevenly pre-baked. Uneven browning may remain even after baking.

Recommended Setting Values

The table lists the optimal heating method for various types of breads and rolls. The temperature and baking time depend on the amount and consistency of the dough/mixture. For this reason, setting ranges are indicated. Try using the lower values to start with. A lower temperature results in more even browning. You can increase the temperature next time if necessary.

Note: Baking times cannot be reduced by using higher temperatures. The bread or rolls would only be cooked on the outside, but would not be fully baked in the middle.

The setting values apply to food that is placed into the cold cooking compartment. If you preheat the oven, you can reduce the indicated baking times by several minutes.





Preheating is necessary for selected food, and this is indicated in the table. Do not place your food or accessories into the cooking compartment until it has finished preheating. Some food turns out best if it is baked in several stages. These foods are indicated in the table.













The setting values for bread dough apply to both dough placed on a baking tray and dough placed in a loaf tin. If you wish to follow one of your own recipes when baking, you should use similar baked goods in the table as a reference.



▲ CAUTION

Never pour water into the hot cooking compartment or place cookware containing water onto the bottom of the cooking compartment. The change in temperature can cause damage to the enamel.

Heating methods used:

-  Convection Multi-Rack
-  Bake
-  Convection Broil
-  Broil
-  Pizza

Dish	Accessories	Rack position	Heating mode	Temperature in °F (°C)	Broil setting	Cooking time in mins.
Bread						
White bread, 1.5 lb (750 g)	Loaf pan	2		355-390 (180-200)	-	25-40
Multigrain bread, 3 lb (1.5 kg)	Loaf pan	2		390 (200) 355 (180)	-	10 20-30
Multigrain bread, 3 lb (1.5 kg)	Baking sheet	2		390-410 (200-210)	-	40-50
Wholemeal bread, 2.5 lb (1 kg)	Baking sheet	2		390-410 (200-210)	-	40-50
Flatbread	Baking sheet	3		480-520 (250-270)	-	20-25
Bread rolls						
Part-cooked rolls or baguette, pre-baked	Baking sheet	3		355-390 (180-200)	-	10-15
Bread rolls, sweet, fresh	Baking sheet	3		340-375 (170-190)	-	15-20
Bread rolls, sweet, fresh, 2 racks	Baking sheets	3+1		300-340 (150-170)	-	20-30
Bread rolls, fresh	Baking sheet	3		355-390 (180-200)	-	20-30
Baguette, pre-baked, chilled	Baking sheet	3		355-390 (180-200)	-	20-30
Bread rolls, frozen						
Part-cooked rolls or baguette, pre-baked	Baking sheet	3		355-390 (180-200)	-	10-15
Croissant, pieces of dough	Baking sheet	3		340-375 (170-190)	-	30-35

Dish	Accessories	Rack position	Heating mode	Temperature in °F (°C)	Broil setting	Cooking time in mins.
Toast						
Toast with topping, 4 slices	Wire rack	3		375-410 (190-210)	-	10-15
Toast with topping, 12 slices	Wire rack	3		445-480 (230-250)	-	10-15
Toasting bread (do not preheat)	Wire rack	5		-	3	4-6

Pizza, Quiche, and Savoury Pastries

Your appliance offers you a range of heating methods for preparing pizza, quiche, and savoury pastries. You can find the ideal settings for many dishes in the settings tables.

Also refer to the notes in the section on allowing dough to rise.

Only use original accessories supplied with your appliance. These have been tailored to the cooking compartment and operating modes of your appliance.

Rack positions

Use the indicated rack positions.

Baking on one rack

When baking on one rack, use the following rack positions:

- Tall baked items: rack position 2
- Flat baked items: rack position 3

If you are using Convection Multi-Rack as the heating mode, you can choose between rack positions 1, 2, 3 and 4.

Baking on several racks

Use Convection Multi-Rack. Baked items that are placed into the oven on two racks at the same time will not necessarily be ready at the same time.

Baking on two racks:

- First rack with greaseproof paper: rack position 3
- Second rack with greaseproof paper: rack position 1

Baking on four racks:

- First rack with greaseproof paper: rack position 5
- Second rack with greaseproof paper: rack position 3
- Third rack with greaseproof paper: rack position 2
- Fourth rack with greaseproof paper: rack position 1

Position baking tins/dishes next to one another or offset and vertically stacked in the cooking compartment.

Accessories

Ensure that you always use suitable accessories and that they are placed in the oven the right way around.

Wire Rack

Insert the wire rack with the open side facing the appliance door and the curved lip pointing downwards. Always place cookware, tins, and dishes on the wire rack.

Baking pans

Shiny aluminum baking pans are most suitable.

Tinplate baking pans, ceramic dishes and glass dishes extend baking time and mean that the baked item will not brown evenly. If you wish to bake using these baking pans/dishes and using top/bottom heating, slide in the pan/dish at rack position 1.

Parchment Paper

Only use parchment paper that is suitable for the selected temperature. Always cut parchment paper to size.

Frozen Products

Do not use frozen products that are heavily frosted. Remove any ice on the food.

Some frozen products may be unevenly pre-baked. Uneven browning may remain even after baking.

Recommended Setting Values

The table lists the optimal heating method for various types of food. The temperature and baking time depend on the amount and consistency of the dough/mixture. For this reason, setting ranges are indicated. Try using the lower values to start with. A lower temperature results in more even browning. You can increase the temperature next time if necessary.

Note: Baking times cannot be reduced by using higher temperatures. The food would only be cooked on the outside, but would not be fully cooked in the middle.



The setting values apply to food that is placed into the cold cooking compartment. If you preheat the oven, you can reduce the indicated baking times by several minutes.

















Preheating is necessary for selected food, and this is indicated in the table. Do not place your food or accessories into the cooking compartment until it has finished preheating.

If you wish to follow one of your own recipes when baking, you should use similar baked goods in the table as a reference.

Remove unused accessories from the cooking compartment. This will ensure that you achieve the best possible cooking results.

Heating methods used:

-  Convection Multi-Rack
-  Bake
-  Pizza

Dish	Accessories	Rack position	Heating mode	Temperature in °F (°C)	Cooking time in mins.
Pizza					
Pizza, fresh	Perforated pizza pan	3		390-430 (200-220)	25-35
Pizza, fresh	Perforated pizza pan	3		390-430 (200-220)	25-35
Pizza, fresh, 2 racks	Perforated pizza pan	3+1		355-390 (180-200)	35-45
Pizza, fresh, thin base	Perforated pizza pan	2		430-445 (220-230)	20-30
Pizza, chilled	Wire rack	3		375-410 (190-210)	10-15
Pizza, frozen					
Pizza with thin base x 1	Wire rack	3		375-410 (190-210)	15-20
Pizza with thin base x 2	Wire rack	3+1		375-410 (190-210)	20-25
Pizza, deep-pan, x 1	Wire rack	3		355-390 (180-200)	20-25
Pizza, deep-pan, x 2	Wire rack	3+1		375-410 (190-210)	20-30
Pizza baguette	Wire rack	3		390-430 (200-220)	15-20
Mini pizzas	Wire rack	3		355-390 (180-200)	15-20
Mini pizzas, Ø2.5" (7 cm), 4 racks	4 wire racks	5+3+2+1		355-390 (180-200)	20-30
Savoury cakes & quiches					
Savoury cakes in a tin	Springform cake pan Ø11" (28 cm)	2		340-375 (170-190)	65-75
Quiche	Tart pan	3		375-410 (190-210)	35-45
Tarte flambée	Baking sheet	3		500-535 (260-280)	10-15
Pierogi	Ovenproof dish	2		340-375 (170-190)	50-70

Casseroles and Soufflés

Your appliance offers a range of heating methods for preparing casseroles and soufflés. You can find the ideal settings for many dishes in the settings tables.

Only use original accessories supplied with your appliance. These have been tailored to the cooking compartment and operating modes of your appliance.

Rack positions

Always use the indicated rack position.

Baking tins/dishes on the wire rack: Rack position 2

Position baking tins/dishes next to one another in the cooking compartment.

Accessories

Ensure that you always use suitable accessories and that they are placed in the oven the right way around.

Wire Rack

Insert the wire rack with the open side facing the appliance door and the curved lip pointing downwards. Always place cookware, tins, and dishes on the wire rack.

Cookware

Use wide, shallow cookware for casseroles and gratins. Food takes longer to cook in narrow, deep cookware and browns more on top.

Recommended Setting Values

The table lists the optimal heating method for various types of casseroles and soufflés. Temperature and cooking time depend on the quantity of food and the recipe. How well cooked a casserole is will depend on the size of the cookware and the thickness of the casserole. For this reason, setting ranges are indicated. Try using the lower values to start with. A lower temperature results in more even browning. You can increase the temperature next time if necessary.



Note: Cooking times cannot be reduced by using higher temperatures. Casseroles or soufflés would only be cooked on the outside, but would be raw in the middle.









The setting values apply to food that is placed into the cold cooking compartment. If you preheat the oven, you can reduce the indicated cooking times by several minutes.

If you wish to follow one of your own recipes, you should use similar dishes in the table as a reference.

Remove unused accessories from the cooking compartment. This will ensure that you achieve the best possible cooking results.

Heating methods used:

-  Convection Multi-Rack
-  Bake

Bakes & soufflés	Accessories / cookware	Rack position	Heating mode	Temperature in °F (°C)	Cooking time in mins.
Casserole, savoury, cooked ingredients	Ovenproof dish	2		390-430 (200-220)	30-50
Casserole, sweet	Ovenproof dish	2		340-375 (170-190)	40-60
Lasagna, fresh, 2.5 lb (1 kg)	Ovenproof dish	2		320-355 (160-180)	50-60
Lasagna, frozen, 1 lb (400 g)	Wire rack	2		375-410 (190-210)	30-35
Potato gratin, raw ingredients, 1.5" (4 cm) deep	Ovenproof dish	2		320-375 (160-190)	50-70
Potato gratin, raw ingredients, 1.5" (4 cm) deep, 2 racks	Ovenproof dish	3+1		300-340 (150-170)	60-80
Soufflé	Ovenproof dish	2		340-375 (170-190)	35-45
Soufflé	Individual molds	3		375-410 (190-210)	25-30

Poultry

Your appliance offers you a range of heating methods for preparing poultry. You can find the ideal settings for certain dishes in the settings tables.

Roasting in Cookware

Only use cookware that is suitable for use in an oven. Check that the cookware fits in the cooking compartment.

Glass cookware is the most suitable. Place hot glass cookware onto a dry mat after cooking. The glass could crack if placed on a cold or wet surface.

Shiny roasting dishes made from stainless steel or aluminum reflect heat like a mirror and are therefore not particularly suitable. Poultry cooks slower and does not brown so well. Use a higher temperature and/or a longer cooking time.

Observe the manufacturer's instructions for your roasting cookware.

Uncovered Cookware

It is best to use a deep roasting pan/dish for roasting poultry. Place the pan/dish onto the wire rack.

Covered Cookware

When preparing food with covered cookware, the cooking compartment remains considerably cleaner. Ensure that the lid fits well and closes properly. Place the cookware onto the wire rack.

Very hot steam may escape when opening the lid after cooking. Lift the lid in the back, so that the hot steam can escape away from you.

Poultry can also become crispy in a covered roasting dish. To do so, use a roasting dish with a glass lid and set a higher temperature.

Recommended Setting Values

You can find the ideal heating method for the kind of poultry you are cooking in the table. Temperature and cooking time depend on the quantity, consistency, and temperature of the food. For this reason, setting ranges are indicated. Try using the lower values to start with. You can increase the temperature next time if necessary.

The setting values are based on the assumption that unstuffed, chilled, ready-to-roast poultry is placed into a cold cooking compartment. If you preheat the oven, you can reduce the indicated cooking times by several minutes.

In the table, you can find specifications for poultry with default values for the weight. If you wish to cook heavier poultry, use the lower temperature in every case. If cooking multiple pieces, use the weight of the heaviest piece as a reference for determining the cooking time. The individual pieces should be approximately equal in size.

A general rule: the larger the poultry, the lower the cooking temperature and the longer the cooking time. Turn the poultry after approx. 1/2 to 2/3 of the indicated time.

Note: Only use parchment paper that is suitable for the selected temperature. Always cut parchment paper to size.

Tips

When cooking duck or goose, pierce the skin underneath the wings. This allows the fat to run out.



When cooking duck breast, score the skin. Do not turn duck breasts.









If you turn poultry when cooking, ensure that the breast side or the skin side is underneath at first.

Poultry will turn out particularly crispy and brown if you baste it towards the end of the roasting time with butter, salted water, or orange juice.

Remove unused accessories from the cooking compartment. This will ensure that you achieve the best possible cooking results.

Heating methods used:

-  Bake
-  Convection Broil
-  Broil

Dish	Accessories / cookware	Rack position	Heating mode	Temperature in °F (°C)	Broil setting	Cooking time in mins.
Chicken						
Chicken, 2.5 lb (1 kg)	Broil pan	2		390-430 (200-220)	-	60-70
Chicken breast fillet, 0.5 lb (150 g) each (broiling)	Broil pan	4		-	3	15-20
Small chicken portions, 0.5 lb (250 g) each	Broil pan	3		390-445 (220-230)	-	30-35
Chicken nuggets, frozen	Broil pan	3		375-410 (190-210)	-	20-25
Whole chicken, 3.5 lb (1.5 kg)	Broil pan	2		390-430 (200-220)	-	70-90
Turkey						
Small turkey, 5.5 lb (2.5 kg)	Broil pan	2		355-390 (180-200)	-	70-90
Turkey breast, boned, 2.5 lb (1 kg)	Cookware, covered	2		465-500 (240-260)	-	80-100
Turkey thigh, with bones, 2.5 lb (1 kg)	Broil pan	2		355-390 (180-200)	-	80-100

Meat

Your appliance offers a range of heating methods for preparing meat. You can find the ideal settings for many dishes in the settings tables.

Roasting and Braising

Baste lean meat with fat as required or cover it with strips of bacon.

Score the rind crosswise. If you turn the roast when cooking, ensure that the rind is underneath at first.

When the roast is ready, turn off the oven and allow it to rest for another 10 minutes in the cooking compartment. This allows the meat juices to be better distributed. Wrap the roast in aluminum foil if necessary. The recommended resting time is not included in the indicated cooking time.

Roasting and Braising in Cookware

It is more convenient to roast and braise meat in cookware. You can take the roast out of the cooking compartment more easily in the cookware, and prepare the sauce in the cookware itself.

Only use cookware that is suitable for use in an oven. Check that the cookware fits in the cooking compartment.

Glass cookware is the most suitable. Place hot glass cookware onto a dry mat after cooking. The glass could crack if placed on a cold or wet surface.

When roasting, add in a little liquid if the meat is lean. With glass cookware, the bottom of the cookware should be covered with approx. 1/2 inch (2 cm) of liquid.

The quantity of liquid is dependent on the type of meat, the cookware material, and also on whether or not a lid is used. When preparing meat in an enamelled or dark metal roasting dish, it will need a little more liquid than when cooked in glass cookware.

During roasting, the liquid in the cookware will evaporate. Carefully pour in more liquid if required.

Shiny roasting dishes made from stainless steel or aluminum reflect heat like a mirror and are therefore not particularly suitable. The meat cooks more slowly and will not brown so much. Use a higher temperature and/or a longer cooking time.

Observe the manufacturer's instructions for your roasting cookware.

Uncovered Cookware

It is best to use a deep roasting pan/dish for roasting meat. Place the pan/dish onto the wire rack.

Covered Cookware

When preparing food with covered cookware, the cooking compartment remains considerably cleaner. Ensure that the lid fits well and closes properly. Place the cookware onto the wire rack.

The distance between the meat and the lid should be at least 3 cm. The meat may rise.

Very hot steam may escape when opening the lid after cooking. Lift the lid in the back, so that the hot steam can escape away from you.

If necessary, braise the meat first by searing it. Add water, wine, vinegar, or a similar liquid for the braising liquid. Cover the bottom of the cookware with approx. 1–2 cm of liquid.

During roasting, the liquid in the cookware will evaporate. Carefully pour in more liquid if required.

Meat can also become crispy in a covered roasting dish. To do so, use a roasting dish with a glass lid and set a higher temperature.

Broiling

Keep the appliance door closed when using the broil mode. Never broil with the appliance door open.

When broiling, try wherever possible to use pieces of food which are of a similar thickness and weight. This will allow them to brown evenly and remain succulent and juicy.

Use tongs to turn the pieces of food you are broiling. If you pierce the meat with a fork, the juices will run out and it will become dry.

Do not add salt until after the meat has been broiled. Salt draws water from the meat.

Notes

- The grill element switches itself on and off continuously; this is normal. The grill setting determines how frequently this occurs..
- Smoke may be produced when grilling.

Recommended Setting Values

You can find the ideal heating method for many meat dishes in the table. Temperature and cooking time depend on the quantity, consistency, and temperature of the food. For this reason, setting ranges are indicated. Try using the lower values to start with. You can increase the temperature next time if necessary.

The setting values apply to chilled meat placed into the cold cooking compartment. If you preheat the oven, you can reduce the indicated cooking times by several minutes.

You can find information on roasts and default values for weights in the table. If you wish to roast a heavy piece of meat, you should definitely use a lower temperature. If cooking multiple pieces, use the weight of the heaviest piece as a reference for determining the cooking time. The individual pieces should be approximately equal in size.



A general rule: the larger the roast, the lower the cooking temperature and the longer the cooking time.







Turn roasts and grilled items after approx. $\frac{1}{2}$ to $\frac{2}{3}$ of the indicated time.











If you wish to follow one of your own recipes, you should use similar dishes as a reference. Additional information can be found in the tips on roasting, braising, and grilling listed after the settings table.

Remove unused accessories from the cooking compartment. This will ensure that you achieve the best possible cooking results.

Heating methods used:

-  Bake
-  Convection Broil
-  Broil

Dish	Accessories / cookware	Rack position	Heating mode	Temperature in °F (°C)	Broil setting	Cooking time in mins.
Pork						
Joint of pork without rind, e.g. neck, 3.5 lb (1.5 kg)	Cookware, uncovered	2		355-375 (180-190)	-	110-130
Joint of pork with rind, e.g. shoulder, 4.5 lb (2 kg)	Wire rack	2		375-390 (190-200)	-	130-140
Pork tenderloin steak, 3.5 lb (1.5 kg)	Cookware, uncovered	2		430-445 (220-230)	-	70-80
Pork fillet, 0.8 lb (400 g)	Wire rack	3		430-445 (220-230)	-	20-25
Smoked pork on the bone, 2.2 lb (1 kg) (with a little added water)	Cookware, covered	2		410-445 (210-230)	-	70-90
Pork steak, 1 inch (2 cm) thick	Wire rack	5		-	2	16-20
Pork medallions, 1.2 inch (3 cm) thick	Wire rack	5		-	3	8-12

Dish	Accessories / cookware	Rack position	Heating mode	Temperature in °F (°C)	Broil setting	Cooking time in mins.
Beef						
Fillet of beef, medium, 2.5 lb (1 kg)	Wire rack	2		410-430 (210-220)	-	40-50
Pot-roasted beef, 3.5 lb (1.5 kg)	Cookware, covered	2		390-430 (200-220)	-	130-160
Sirloin, medium, 3.5 lb (1.5 kg)	Wire rack	2		430-445 (220-230)	-	60-70
Steak, 1 inch (3 cm) thick, medium	Wire rack	3		-	3	15-20
Burger, 1 inch (3 cm) deep	Wire rack	4		-	3	25-30
Lamb						
Leg of lamb, boned, medium	Cookware, uncovered	2		340-375 (170-190)	-	50-80
Saddle of lamb on the bone (remove sinews, cut lengthwise from the bone without turning)	Wire rack	2		355-375 (180-190)	-	40-50
Lamb cutlet	Wire rack	3		-	3	12-16
Sausages						
Grilled sausages	Wire rack	4		-	3	10-15
Meat dishes						
Meat loaf, 2.5 lb (1 kg)	Cookware, uncovered	2		340-355 (170-180)	-	60-70

Tips for Roasting and Braising

The cooking compartment is very dirty.	Prepare your food in an enclosed roaster at higher temperatures or use the grill tray. You will achieve the best roasting results if you use the grill tray. You can buy the grill tray later as a special accessory.
The roast is too dark and the crackling is burned in places, and/or the roast is too dry.	Check the shelf position and temperature. Select a lower temperature the next time and reduce the roasting time if necessary.
The crackling is too thin.	Increase the temperature or switch on the grill briefly at the end of the roasting time.
The roast looks good but the juices are burnt.	Next time, use a smaller roasting dish and add more liquid if necessary.
The roast looks good but the juices are too clear and watery.	Next time, use a larger roasting dish and add less liquid if necessary.
The meat is burned slightly during braising.	The roasting dish and lid must fit together well and close properly. Reduce the temperature and add more liquid when braising if necessary.

Fish

Your appliance offers you a range of heating methods for preparing fish. You can find the ideal settings for many dishes in the settings tables.

Whole fish does not have to be turned. Place the whole fish into the cooking compartment in swimming position with the dorsal fin facing upwards. Placing half a potato or a small oven-proof container in the stomach cavity of the fish will provide stability.

You can tell when the fish is cooked because the dorsal fin can be removed easily.

Roasting and Steaming in Cookware

Only use cookware that is suitable for use in an oven. Check that the cookware fits in the cooking compartment.

Glass cookware is the most suitable. Place hot glass cookware onto a dry mat after cooking. The glass could crack if placed on a cold or wet surface.

Shiny roasting dishes made from stainless steel or aluminum reflect heat like a mirror and are therefore not particularly suitable. Fish cooks slower and does not brown so well. Use a higher temperature and/or a longer cooking time.

Observe the manufacturer's instructions for your roasting cookware.

Uncovered Cookware

It is best to use a deep roasting tin/dish for cooking whole fish. Place the tin/dish onto the wire rack.

Covered Cookware

When preparing food with covered cookware, the cooking compartment remains considerably cleaner. Ensure that the lid fits well and closes properly. Place the cookware onto the wire rack.

When steaming, add two to three tablespoons of liquid and a little lemon juice or vinegar into the cookware.

Very hot steam may escape when opening the lid after cooking. Lift the lid in the back, so that the hot steam can escape away from you.

Fish can also become crispy in a covered roasting dish. To do so, use a roasting dish with a glass lid and set a higher temperature.

Recommended Setting Values

You can find the ideal heating method for your fish dishes in the table. Temperature and cooking time depend on the quantity, consistency, and temperature of the food. For this reason, setting ranges are indicated. Try using the lower values to start with. You can increase the temperature next time if necessary.

The setting values apply to chilled fish placed into the cold cooking compartment. If you preheat the oven, you can reduce the indicated cooking times by several minutes.

In the table, you can find specifications for fish with default values for the weight. If you wish to cook heavier fish, use the lower temperature in every case. If cooking several fish, use the weight of the heaviest fish as a reference for determining the cooking time. The individual fish should be approximately equal in size.



A general rule: the larger the fish, the lower the cooking temperature and the longer the cooking time.







Turn fish that are not in swimming position after approx. 1/2 to 2/3 of the indicated time.

Note: Only use parchment paper that is suitable for the selected temperature. Always cut parchment paper to size.

Remove unused accessories from the cooking compartment. This will ensure that you achieve the best possible cooking results.

Heating methods used:

-  Bake
-  Convection Broil
-  Broil

Dish	Accessories / cookware	Rack position	Heating mode	Temperature in °F (°C)	Broil setting	Cooking time in mins.
Fish						
Fish, grilled, whole 1/2 inch (300 g), e.g. trout	Broil pan	2		340-375 (170-190)	-	20-30
Fish, grilled, whole 3.5 inch (1.5 kg), e.g. salmon	Broil pan	2		340-375 (170-190)	-	30-40
Fish fillets						
Fish fillet, plain, broiled	Broil pan	4		-	1	15-25
Fish steaks						
Fish steak, 1 inch (3 cm) thick	Broil pan	4		-	3	10-20
Fish, frozen						
Fish fillet, plain	Cookware, covered	2		410-445 (210-230)	-	20-30
Fish sticks (turn during cooking)	Baking sheet	3		390-430 (200-220)	-	20-30

Vegetables and Side Dishes

Here, you can find information for preparing grilled vegetables, potatoes, and frozen potato products.

Remove unused accessories from the cooking compartment. This will allow you to achieve optimum cooking results and save energy.

Rack positions

Use the indicated rack positions.

Cooking on one rack

Adhere to the specifications in the table.

Cooking on two racks

Use Convection Multi-Rack. Food on different racks placed in the oven at the same time will not necessarily be ready at the same time.

- First wire rack: rack position 3
- Second wire rack: rack position 1

Accessories

Ensure that you always use suitable accessories and that they are placed in the oven the right way around.

Wire Rack

Insert the wire rack with the open side facing the appliance door and the curved lip pointing downwards. Always place cookware, tins, and dishes on the wire rack.

Parchment Paper

Only use parchment paper that is suitable for the selected temperature. Always cut parchment paper to size.



Recommended Setting Values





The table lists the optimal heating method for various types of food. Temperature and cooking time depend on the amount and consistency of the food. For this reason, setting ranges are indicated. Try using the lower values to start with. A lower temperature results in more even browning. You can increase the temperature next time if necessary.

The setting values apply to food that is placed into the cold cooking compartment. If you preheat the oven, you can reduce the indicated cooking times by several minutes.

If you wish to follow one of your own recipes, you should use similar dishes in the table as a reference.

Heating methods used:

-  Convection Multi-Rack
-  Bake

Dish	Accessories	Rack position	Heating mode	Temperature in °F (°C)	Broil setting	Cooking time in mins.
Vegetable dishes						
Grilled vegetables	Baking sheet	5		-	3	10-15
Potatoes						
Baked potatoes, halved	Baking sheet	3		320-355 (160-180)	-	45-60
Potato products, frozen						
Hash browns	Baking sheet	3		390-430 (200-220)	-	25-35
French fries	Baking sheet	3		375-410 (190-210)	-	25-35
French fries, 2 racks	Baking sheet	3+1		375-410 (190-210)	-	30-40

Slow Cooking

Slow cooking is a technique for cooking food over a long period at low temperatures. For this reason, it is also called "low-temperature cooking".

Slow cooking is ideal for all prime cuts (e.g., tender portions of beef, veal, pork, lamb, or poultry) that are to be cooked medium/medium rare or "à point." The meat will remain moist and tender.

The benefit of this cooking method is that you have plenty of leeway for menu planning because slow-cooked meat is easy to keep warm. You do not have to turn the meat when cooking. Keep the appliance door closed in order to maintain an even cooking climate.

Only use fresh, good-quality meat without bones. Carefully remove sinews and fat from around the edge.

Fat develops a strong, distinct flavor during slow cooking. You can also use seasoned or marinated meat. Do not use defrosted meat.

Meat can be carved immediately following slow cooking. No resting time is required. As a result of the special cooking method, the meat looks pink, but it is not raw or undercooked.

Note: A delayed-start operation with an end time is not possible for the slow cooking heating method.

Cookware

Use shallow cookware, e.g., a porcelain or glass serving dish. Place the cookware into the cooking compartment to preheat.

Always place the uncovered cookware onto the wire rack at rack position 2.

Additional information can be found in the tips on slow cooking listed after the settings table.

Your appliance features the heating method "Slow Cook." Only start operation when the cooking compartment has fully cooled down. Allow the cooking compartment to warm up for approx. 15 minutes with the cookware inside.













Sear the meat on the hotplate at a very high heat and for a sufficiently long time on all sides, even on the ends. Place food onto/into the preheated cookware immediately. Put the cookware containing the meat back into the cooking compartment and slow cook.

Recommended Setting Values

The slow cooking temperature and cooking time are dependent on the size, thickness, and quality of the meat. For this reason, setting ranges are indicated.

Heating methods used:

 Slow Cook

Dish	Cookware	Rack position	Heating mode	Searing time in mins.	Temperature in ° F (°C)	Cooking time in mins.
Poultry						
Duck breast, 1 lb (400 g)	Cookware, uncovered	2		6-8	175 (80)*	60-120
Chicken breast fillet, 1/2 lb (200 g) each	Cookware, uncovered	2		5-7	195 (90)*	60-90
Turkey breast, boned, 2.5 lb (1 kg)	Cookware, uncovered	2		8-10	195 (90)*	150-210
Pork						
Pork tenderloin steak, 2 in (5-6 cm) thick, 3.5 lb (1.5 kg)	Cookware, uncovered	2		8-10	175 (80)*	180-210
Pork fillet, whole	Cookware, uncovered	2		6-8	175 (80)*	60-120
Pork medallions, 1.5 in (4 cm) dick	Cookware, uncovered	2		5-7	175 (80)*	90-120
Beef						
Joint of beef (rump), 3 in (6-7 cm) thick, 3.5 lb (1.5 kg)	Cookware, uncovered	2		8-10	175 (80)*	180-240
Beef tenderloin, whole, 2.5 lb (1 kg)	Cookware, uncovered	2		4-6	175 (80)*	180-240
Sirloin, 2.5 in (5-6 cm) thick	Cookware, uncovered	2		6-8	175 (80)*	210-270
Beef medallions/rump steak, 1.5 in (4 cm) thick	Cookware, uncovered	2		5-7	175 (80)*	30-60
Lamb						
Saddles of lamb, boneless, 1/2 in (200 g) each	Cookware, uncovered	2		5-7	175 (80)*	120-180
Leg of lamb, boned, medium, 2.5 in (1 kg) tied	Cookware, uncovered	2		6-8	175 (80)*	150-210

* preheat

Slow Cooking Tips

Slow cook duck breast.	Place the cold duck breast into a pan and sear the skin side first. After slow cooking, grill for 3 to 5 minutes until crispy.
Slow-cooked meat is not as hot as conventionally roasted meat.	Warm the plates and serve the gravy very hot so that the roasted meat does not cool as quickly.

Drying

With Convection Multi-Rack, you can dry foods with outstanding results. With this type of preserving, flavorings are concentrated by the dehydration.

Only use fruit, vegetables, and herbs that are in good condition, and wash them thoroughly. Line the wire rack with baking or parchment paper. Drain the excess water from the fruit, then dry it.

Cut it into equal chunks or thin slices, if necessary. Place unpeeled fruit onto the tray with the sliced surfaces facing upwards. Ensure that neither fruit nor mushrooms overlap on the wire rack.

Grate vegetables and then blanch them. Allow the blanched vegetables to drain and distribute them evenly on the wire rack.

Dry herbs on the stem. Position the herbs evenly and slightly heaped on the wire rack.

Use the following shelf positions for drying:

- 1 Wire rack: rack position 3
- 2 Wire racks: rack positions 3+1

Turn very juicy fruit and vegetables several times. After drying, remove the dried fruit and vegetables from the paper immediately.





Recommended Setting Values

In the table, you can find settings for drying various food items. Temperature and cooking time are dependent on the type, moisture, ripeness, and thickness of the food to be dried. The longer you leave the food to be dried, the better it will be preserved. The thinner the slices are, the quicker the drying process will be and the more aromatic the dried food will remain. For this reason, setting ranges are indicated.

If you wish to dry additional food items, you should use similar food items in the table as a reference.

Heating methods used:

 Convection Multi-Rack

Fruit, vegetables and herbs	Accessories	Heating mode	Temperature in °F (°C)	Cooking time in hours
Apples (apple rings, 0.1 in (3 mm) thick, per wire rack 0.5 lb (200 g))	1-2 wire racks		175 (80)	5-9
Stone fruit (plums)	1-2 wire racks		175 (80)	8-10
Root vegetables (carrots), grated, blanched	1-2 wire racks		175 (80)	5-8
Sliced mushrooms	1-2 wire racks		175 (80)	6-9
Herbs, washed	1-2 wire racks		175 (80)	2-6

Proofing Dough

You can proof yeast dough in your appliance more quickly than at room temperature. Use the Bake mode. Only start operation when the cooking compartment has fully cooled down.

Always allow yeast dough to proof twice. Observe the specifications in the settings tables for the 1st and 2nd proofing processes (dough fermentation and final fermentation).

Dough Fermentation

Use the settings indicated in the table and heat up the appliance. Place the dough bowl on the wire rack.

Do not open the appliance door during the proofing process, as moisture will escape. Cover the dough with a damp cloth.

Final Fermentation

Place your pastry into the oven at the shelf position indicated in the table.



If you want to preheat the oven, the final fermentation takes place outside the appliance in a warm place.

Recommended Setting Values

Temperature and proving time are dependent on the type and quantity of the ingredients. Therefore, the values in the table are meant to be guide values only.

Heating methods used:

 Bake

Dish	Accessories / cookware	Rack position	Heating mode	Step	Temperature in °F (°C)	Cooking time in mins.
Yeast dough, light	Bowl	2		Dough fermentation	95-105 (35-40)	25-30
	Baking tray	2		Final fermentation	95-105 (35-40)	10-20

Dish	Accessories / cookware	Rack position	Heating mode	Step	Temperature in °F (°C)	Cooking time in mins.
Yeast dough, heavy and rich	Bowl	2		Dough fermentation	95-105 (35-40)	20-40
	Baking tray	2		Final fermentation	95-105 (35-40)	15-25

Defrosting

The "Defrost" heating method is suitable for defrosting frozen fruit, vegetables, and baked items. Poultry, meat, and fish should ideally be defrosted in the refrigerator. Use the following shelf positions when defrosting:

- 1 Wire rack: rack position 2
- 2 Wire racks: rack positions 3+1

▲ WARNING

HEALTH RISK

Liquid will be produced when defrosting meat or poultry. Drain off this liquid when turning meat and poultry, and under no circumstances, use it for other purposes, or allow it to come into contact with other foods.

Recommended Setting Values

The times specified in the table are intended as a guide. They are dependent on the quality, freezing temperature (0°F / -18°C), and composition of the food. Time ranges are indicated. Set the shortest time first and then extend the time if necessary.

Tip: Items which were frozen flat or portioned defrost faster than those frozen in a block.

Remove frozen food from the packaging and place it onto the wire rack in suitable cookware.

Turn or stir the food once or twice during the defrosting time. Large pieces of food should be turned several times. Occasionally break up the food or remove items which have already defrosted from the cooking compartment.

Leave the defrosted food to rest for another 10 to 30 minutes in the appliance while it is switched off to compensate for the temperature difference.

Heating methods used:

Defrost

Dish	Accessories	Rack position	Heating mode	Temperature in °F (°C)	Cooking time in mins.
Bread, bread rolls					
Bread & bread rolls general	Baking tray	2		120 (50)	40-70
Cake					
Cake, moist	Baking tray	2		120 (50)	70-90
Cake, dry	Baking tray	2		140 (60)	60-75

Keeping Food Warm

You can keep cooked dishes warm using the "Keep Warm" heating method. This will prevent condensation from developing, meaning you will not have to wipe out the cooking compartment.

Do not keep cooked dishes warm for longer than two hours. Be aware that some dishes may continue cooking while being kept warm. Cover the food if necessary.



9001235753

980227



BOSCH

Invented for life

1901 Main Street, Suite 600 • Irvine, CA 92614 • 800-944-2904
www.bosch-home.com • © 2018 BSH Home Appliances