



**BOSCH**



**Register** your  
new device on  
MyBosch now and  
get free benefits:  
**[bosch-home.com/  
welcome](https://bosch-home.com/welcome)**

# Gas hob

**PCP6A5B90V, PCQ7A5B90V, PCQ7A5M90V, PCS7A5M90V, PCR9A5M90V**

<b>[en]</b>	Instruction manual	Gas hob	3
<b>[es]</b>	Instrucciones de uso	Placa de cocción a gas	15
<b>[fr]</b>	Notice d'utilisation	Table de cuisson gaz	26
<b>[nl]</b>	Gebruiksaanwijzing	Gaskookplaat	37

PCP6A5B90V

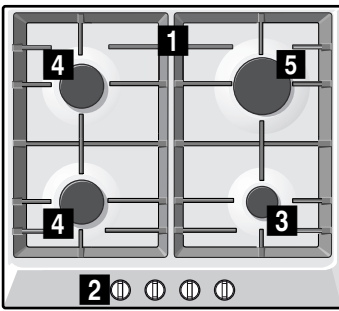

PCQ7A5B90V

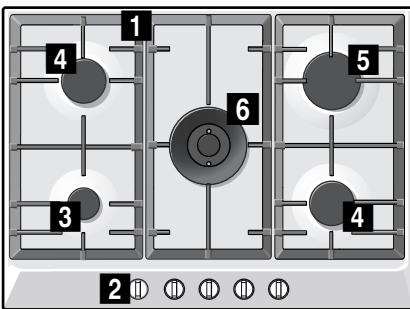

PCQ7A5M90V

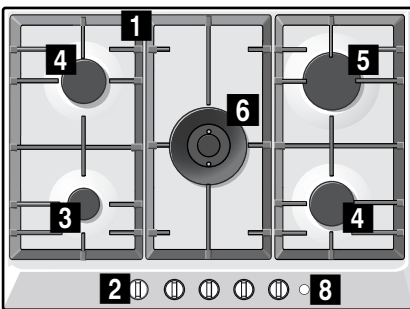

PCS7A5M90V

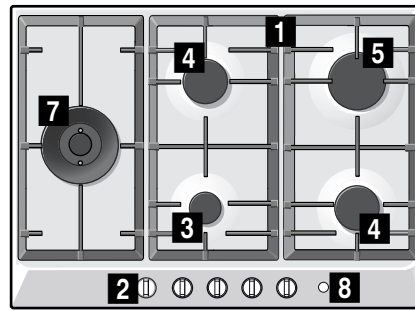

PCR9A5M90V

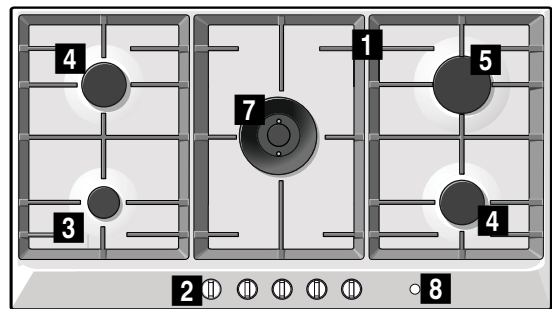

- 1** Pan supports
- 2** Control knobs
- 3** Economy burner with an output of up to 1 kW
- 4** Standard-output burner with an output of up to 1.75 kW

- 5** High-output burner with an output of up to 3 kW
- 6** Wok burner with an output of up to 4 kW
- 7** Dual-wok burner with an output of up to 5 kW
- 8** Main Switch

- 1** Parrillas
- 2** Mandos
- 3** Quemador auxiliar de hasta 1 kW
- 4** Quemador semi-rápido de hasta 1,75 kW

- 5** Quemador rápido de hasta 3 kW
- 6** Quemador wok de hasta 4 kW
- 7** Quemador wok dual de hasta 5 kW
- 8** Main Switch











- 1** Grilles
- 2** Boutons de commande
- 3** Brûleur éco avec jusqu'à 1 kW
- 4** Brûleur standard avec jusqu'à 1,75 kW

- 5** Brûleur puissant avec jusqu'à 3 kW
- 6** Brûleur pour wok avec jusqu'à 4 kW
- 7** Double brûleur pour wok avec jusqu'à 5 kW
- 8** Interrupteur principal (Main Switch)

- 1** Roosters
- 2** Knoppen
- 3** Hulpbrander met max. 1 kW
- 4** Halfsnelbrander met max. 1,75 kW

- 5** Sterke brander met maximaal 3 kW
- 6** Wokbrander met max. 4 kW
- 7** Tweevoudige wokbrander met max. 5 kW
- 8** Main Switch

# Table of contents

 <b>Intended use</b> . . . . .	3
 <b>Important safety information</b> . . . . .	4
 <b>General information</b> . . . . .	5
Technical information . . . . .	5
IMPORTANT . . . . .	5
 <b>Getting to know your appliance</b> . . . . .	6
Controls and burners . . . . .	6
Accessories . . . . .	6
 <b>Gas burners</b> . . . . .	7
Switching on manually . . . . .	7
Automatic ignition . . . . .	7
Safety system . . . . .	7
Switching off a burner . . . . .	7
Main switch/Hob lock (Main Switch) . . . . .	8
Warnings . . . . .	8
 <b>Settings table and tips</b> . . . . .	8
Suitable pans . . . . .	8
Instructions for use . . . . .	8
Table of cooking times . . . . .	9
 <b>Cleaning and maintenance</b> . . . . .	12
Cleaning . . . . .	12
Maintenance . . . . .	12
 <b>Trouble shooting</b> . . . . .	13
 <b>Customer service</b> . . . . .	14
Warranty conditions . . . . .	14
 <b>Environmental protection</b> . . . . .	14
Environmentally-friendly disposal . . . . .	14

Additional information on products, accessories, replacement parts and services can be found at [www.bosch-home.com](http://www.bosch-home.com) and in the online shop [www.bosch-eshop.com](http://www.bosch-eshop.com)

## Intended use

Read these instructions carefully. You will only be able to use your appliance safely and effectively when you have read them. These operating and installation instructions should be retained, and passed onto the buyer if the appliance is sold.

**The manufacturer is exempt from all responsibility if the requirements of this manual are not complied with.**

The images shown in these instructions are for guidance only.

Do not remove the appliance from its protective packaging until it is installed in the unit. Do not switch on the appliance if it is damaged in any way. Contact our Technical Assistance Service.

This appliance is class 3 type, according to the EN 30-1-1 regulation for gas appliances: built-in appliance.

Before installing your new hob, ensure that it is being installed according to the installation instructions.

This appliance cannot be installed on yachts or in caravans.

This appliance must only be used in well ventilated places.

This appliance is not intended for operation with an external clock timer or a remote control.

**All operations relating to installation, connection, regulation and conversion to other gas types must be performed by an authorised technician, respecting all applicable regulations, standards and the specifications of the local gas and electricity suppliers. Special attention shall be paid to ventilation regulations.**

This appliance leaves the factory set to the gas type that is indicated on the specifications plate. If this needs to be changed, please consult the assembly instructions. It is recommended you contact the Technical Assistance Service to change to another gas type.

This appliance has been designed for home use only, not for commercial or professional use. This appliance is only intended for

cooking purposes, not as a heating system. The warranty will only be valid if the appliance is used for the purpose for which it was designed.

This appliance is intended for use up to a maximum height of 2000 metres above sea level.

Do not use lids or hob guards for children which are not recommended by the hob manufacturer. They may cause accidents such as those due to the overheating, ignition or detachment of fragments of materials.

This appliance may be used by children over the age of 8 years old and by persons with reduced physical, sensory or mental capabilities or by persons with a lack of experience or knowledge if they are supervised or are instructed by a person responsible for their safety how to use the appliance safely and have understood the associated hazards.

Children must not play with, on, or around the appliance. Children must not clean the appliance or carry out general maintenance unless they are at least 15 years old and are being supervised.

Keep children below the age of 8 years old at a safe distance from the appliance and power cable.

---

## Important safety information

### **Warning – Risk of deflagration!**

Accumulation of unburned gas in an enclosed area carries a risk of deflagration. Do not subject the appliance to draughts. These might blow out the burners. Carefully read the instructions and warnings on the operation of gas burners.

### **Warning – Risk of poisoning!**

The kitchen will become hot and humid and combustion products produced when this gas appliance is used. Make sure the kitchen is well ventilated, particularly when the hob is in operation: either keep the natural ventilation apertures open, or install a ventilation system (extractor hood). Intense prolonged use of the appliance may require additional or more effective ventilation: open a window or increase the power of the ventilation system.

### **Warning – Risk of burns!**

- The burners and their immediate vicinity get very hot. Never touch the hot surfaces. Keep children under 8 years old well away from this appliance.
- If the liquefied gas bottle is not upright, liquefied propane/butane can enter the appliance. Intense darting flames may therefore escape from the burners. Components may become damaged and start to leak over time so that gas escapes uncontrollably. Both can cause burns. Always use liquefied gas bottles in an upright position.

### **Warning – Risk of fire!**

- The cooking process must be supervised. A short cooking process must be supervised without interruption.
- The burners get very hot. Do not rest inflammable objects on the hob. Do not store objects on the hob.
- Do not store or use corrosive chemicals, products which produce fumes, inflammable materials or non-food products below or near this domestic appliance.
- Fat or oil which is overheated can catch fire easily. Never leave fat or oil to heat up unattended. If oil or fats do catch fire, never use water to put the fire out. Put the fire out by covering the pan with a lid and switch off the hotplate.

**⚠ Warning – Risk of injuries!**

- Pans which are damaged, are not the right size, hang over the edge of the hob or are not positioned correctly can cause serious injuries. Follow the advice and warnings provided relating to the cooking pans.
- Incorrect repairs are dangerous. Repairs may only be carried out, and damaged power and gas lines replaced, by an after-sales engineer trained by us. If the appliance is faulty, unplug the mains plug or switch off the fuse in the fuse box. Shut off the gas supply. Contact the after-sales service.

- If a control knob is too stiff to turn or it is loose, it must not be used. Contact our after-sales service immediately to have the control knob repaired or replaced.

**⚠ Warning – Risk of electric shock!**

Do not clean the appliance using steam cleaners.

## General information

### Technical information

		Economy burner	Standard-output burner	High-output burner	Wok burner	Dual wok burner
Thermal capacity	NATURAL GAS	1,00 kW	1,75 kW	3,00 kW	4,00 kW	5,00 kW
	LP GAS					4,60 kW
Model PCP6A5B90V		1	2	1	-	-
Model PCQ7A5B90V		1	2	1	1	-
Model PCQ7A5M90V		1	2	1	1	-
Model PCS7A5M90V		1	2	1	-	1
Model PCR9A5M90V		1	2	1	-	1
Regulation options	NATURAL GAS G20/17,6 - 19,6 mbar; 1,76 - 1,96 kPa					
	LP GAS G30/27,5 mbar; 2,75 kPa					
Electrical characteristics	110 - 240 V~ 50/60 Hz					

NOTE: This product functions using LP gas. If you wish to operate the product using natural gas, call our service center.

### IMPORTANT

- Place the pan supports and burners as shown in the diagrams that describe the model.
- Maintain the area surrounding the appliance free of flammable materials, gasoline and other flammable vapors or liquids.
- Do not use as a space heater as this may be dangerous.

### FOR YOUR SAFETY

#### IF YOU SMELL GAS:

- OPEN THE WINDOWS
- DO NOT TOUCH POWER SWITCHES
- TURN OFF ALL FLAMES BY CLOSING THE MAIN VALVE
- CALL THE GAS LEAK HOTLINE OR YOUR GAS PROVIDER

### FOR YOUR SAFETY

- DO NOT STORE GASOLINE OR OTHER FLAMMABLE LIQUIDS NEAR THE APPLIANCE
- INSTALL YOUR PRODUCT IN ACCORDANCE WITH THE INSTALLATION GUIDE TO AVOID HEAT DAMAGE TO YOUR CABINETS

## Getting to know your appliance

You can find your appliance and the burner powers in the model overview. → Page 2

### Controls and burners

Each control knob is marked with the burner it controls. You can use the control knobs to set the output required in each case to various positions between the maximum and the minimum settings. Never try to switch directly from position 0 to position 1 or from position 1 to position 0.

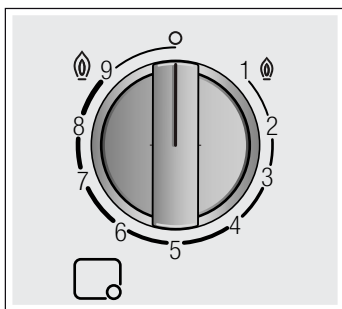

Indicators	
	Burner controlled by control knob
	Switched-off burner
	Highest power setting and electric ignition
	Lowest power setting

For dual double-flame burners, the inner and outer flames can be controlled separately. The available power levels are as follows:

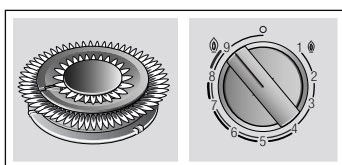

Inner and outer flame on full power.

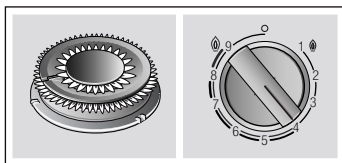

Outer flame on low power, inner flame on full power.

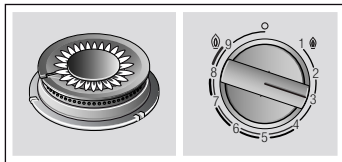

Inner flame on full power.

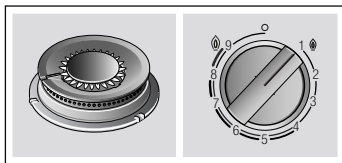

Inner flame on low power.

It is essential to ensure that all the burner parts and pan supports are correctly installed for the appliance to work correctly. Do not swap the burner caps around.

Always remove the pan supports carefully. When moving a pan support, the pan supports next to it may also move.

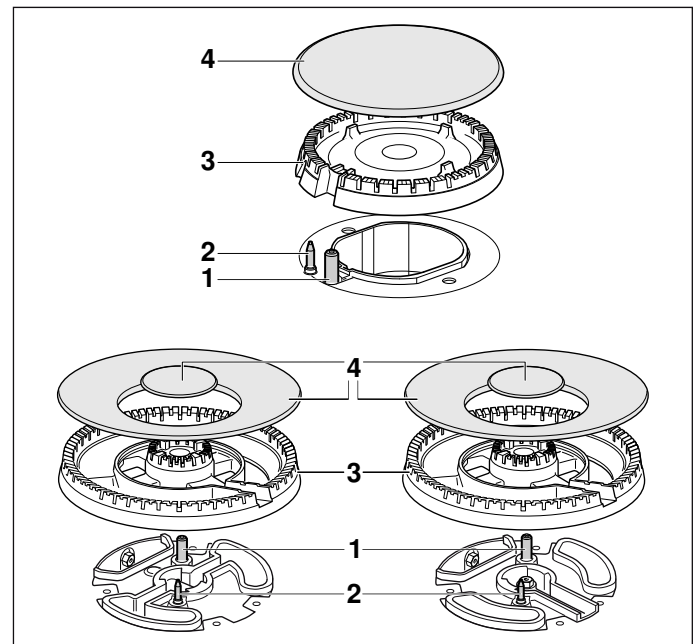

Burner parts	
1	Ignition plug
2	Thermocouple
3	Burner cup
4	Burner cap

### Accessories

Depending on the model, the hob may include the following accessories. These can also be acquired from the Technical Assistance Service.

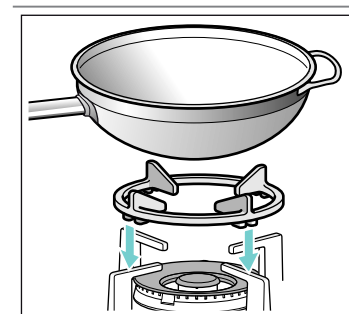

#### Additional wok grid

Only suitable for use on wok burners. Use cookware with a rounded base.

To extend the service life of the appliance, we recommend using the additional wok grid.

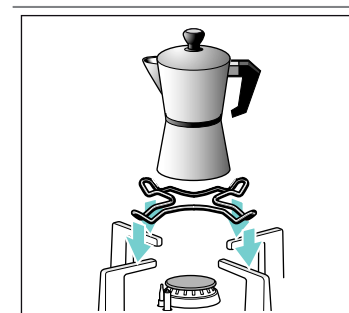

#### Additional espresso maker grid

Only suitable for use on the smallest burner. Use cookware with a diameter of less than 12 cm.

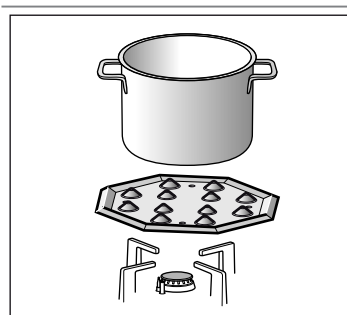

### Simmer plate

This accessory part is only suitable for simmering. It can be used with the economy burner or the standard-output burner. If your hob has several standard-output burners, we recommend placing the simmer plate on the rear or front-right standard-output burner.

Place the accessory component with the projections facing upwards on the holder; never place it directly on the burner.

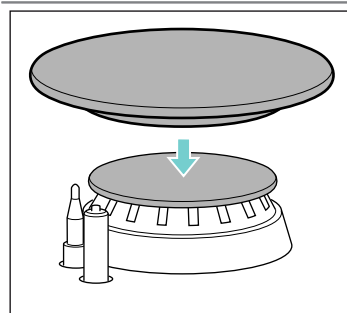

### Simmer cap

Only use the cap for cooking with minimal power. Place the simmer cap on the cover of the economy burner. Always place cookware on the pan support, never directly on the simmer cap.

### Code

HEZ298107 Additional wok grid: Cast iron (4-5 kW)

HEZ298110 Additional wok grid: Enamelled steel

HEZ298115 Additional espresso maker grid

HEZ298105 Simmer Plate

HEZ211310 Simmer cap

The manufacturer accepts no liability if these accessories are not used or are used incorrectly.

## Gas burners

### Switching on manually

1. Press the control knob for the selected burner and turn it anticlockwise to the highest power setting.
2. Hold an igniter or a naked flame (such as a lighter or a match) against the burner.

### Automatic ignition

If the hob has automatic ignition (ignition plugs):

1. Press the control knob for the selected burner and turn it anticlockwise to the highest power level. While the control knob is held down, all the burners will generate sparks. The flame ignites. Wait a few seconds.
2. Release the control knob.
3. Turn the control knob to the required position.

If the burner does not ignite, switch it off and repeat the steps described above. This time, hold the control knob down for longer (up to 10 seconds).

### **Warning – Risk of deflagration!**

If the flame does not ignite after 15 seconds, switch off the burner and open a window or the door to the room. Wait at least one minute before switching the burner on again.

**Note:** It is important to keep the appliance clean. If the ignition plugs are dirty, this may cause ignition problems. Clean the ignition plugs regularly with a small, non-metallic brush. Take care to prevent the ignition plugs from suffering any heavy knocks.

### Safety system

Your hob is equipped with a safety system (thermocouple) that cuts off the gas when the burners are accidentally switched off.

To ensure that this device is active:

1. Switch on the burner as usual.
2. Without releasing the control knob, press and hold it down firmly for 4 seconds after lighting the flame.

### Switching off a burner

Turn the corresponding control knob clockwise to the 0 setting.

A few seconds after the burner is switched off, a sound (thud) will be produced. This is not a fault - this means that the safety device is no longer operating.



## Main switch/Hob lock (Main Switch)

The hob may have a main switch to cut off the mains gas supply and switch off all the burners at the same time. This switch is very practical if there are children in the house or, if for any reason, all the burners must be switched off quickly.

### To lock the hob:

Press the main switch.

This switches off all the burners which are on. The hob is locked.

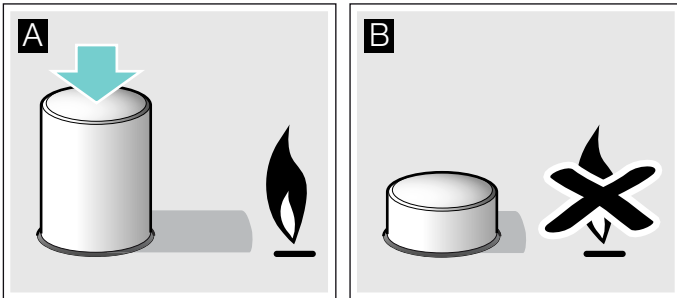

### To unlock the hob:

1. Turn all the control knobs to the "off" position.
2. Press the main switch and turn it fully clockwise.

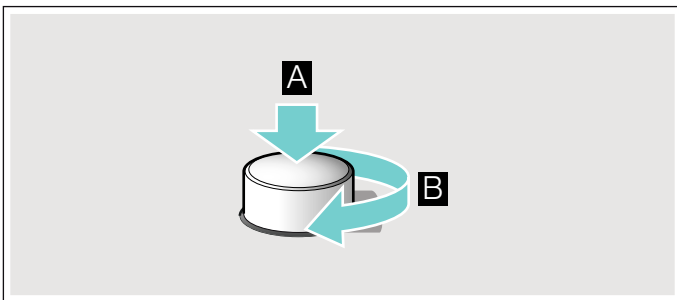

The mains gas supply is turned on. You can now use your hob normally.

## Warnings

It is normal to hear a soft whistling noise while the burner is operating.

When first used, it is normal for the burner to give off odours. This does not pose any risk and does not indicate a malfunction. They will disappear in time.

An orange-coloured flame is normal. This is caused by the presence of dust in the atmosphere, spilt liquids, etc.

If the burner flames are accidentally blown out, switch off the burner operating control knob and do not try to relight it for at least 1 minute.

## Settings table and tips

### Suitable pans

Burner	Minimum diameter of the cookware base	Maximum diameter of the cookware base
Wok burner	22 cm	30 cm
High-output burner	20 cm	26 cm
Standard-output burner	14 cm	22 cm
Economy burner	12 cm	16 cm

The cookware must not overhang the edge of the hob.

### Instructions for use

**Note:** When using certain pots or pans, a slight and temporary deformation of the steel cooking surface may occur. This is normal and does not affect the functionality of the appliance.

The following recommendations can help you save energy and avoid damaging your cookware:

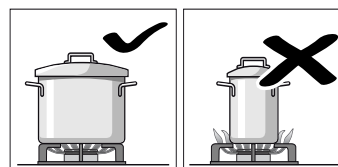

Use pans which are the right size for each burner. Do not use small pans on large burners. The flame must not touch the sides of the pan.

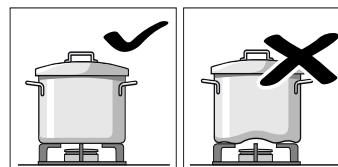

Do not use damaged pans, which do not sit evenly on the hob. Pans may tip over. Only use pans with a thick, flat base.

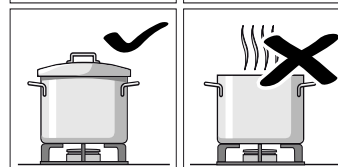

Do not cook without using a lid and make sure the lid is properly fitted. This wastes energy.

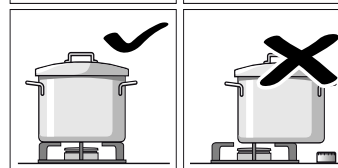

Always centre the pan over the burner, not to one side. Otherwise it could tip over. Do not place large pans on the burners near the control knobs. These may be damaged by the very high temperatures.

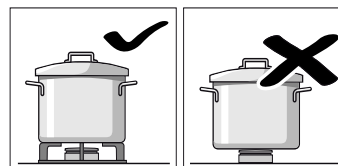

Place the pans on the pan supports, never directly on the burner. Make sure that the pan supports and burner caps are correctly positioned before using the appliance.

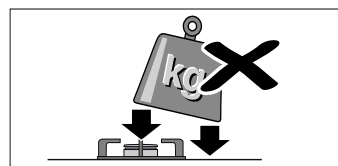

Pans should be placed on the hob carefully. Do not strike the hob and do not place excessive weight on it.



## Table of cooking times



The table below lists the optimal heat settings and cooking times for various types of food. The information given applies when cooking four portions.

The cooking times and heat settings may vary depending on the type of food, its weight and quality, on the type of gas used, and on the material from which the cookware is made. To prepare this dish, stainless steel cookware was mainly used.







Always use cookware that is the right size and place it in the centre of the burner. You can find information about the diameter of the cookware under → "Suitable pans"

### Information on the table

Each type of food can be prepared in one or two steps. Each step contains information about the following:

-  Cooking method
-  Heat setting
-  Cooking time in minutes













### Cooking methods featured in the table

-  Bringing to the boil
-  Continuing cooking
-  Building up pressure in the pressure cooker
-  Maintaining pressure in the pressure cooker
-  Frying on high heat
-  Frying gently
-  Melting, liquefying
- \* Without lid
- \*\* Stirring constantly

**Note:** The symbols do not appear on the appliance. They are used here to represent the various cooking methods.

Information on how to cook food on the different burners is displayed. We recommend using the first burner that was mentioned. The model overview describes all of the burners on the hob. → Page 2

Example:













































Meal Burner	Total time in min.	Step 1			Step 2		
							
<b>Soups, creamy soups</b>							
Fish soup							
High-output burner	12-17		8	7-9		1	5-8
Standard-output burner	17-22		8	11-13		1	6-9
Wok burner	10-15		9	4-6		4	6-9

This example shows the preparation of fish soup using the high-output burner, the standard-output burner and the wok burner.

When using the high-output burner (recommended option), the total cooking time is between 12 and 17 minutes.



































- Step 1: Bring to the boil. Set heat setting 8 for 7-9 minutes.
- Step 2: Continue boiling. Switch to heat setting 1 for 5-8 minutes.









































This information also applies for the other suggested burners.

Food Burner	Total time in min.	Step 1			Step 2		
							
<b>Soups, creamy soups</b>							
Fish soup							
High-output burner	12-17		8	7-9		1	5-8
Standard-output burner	17-22		8	11-13		1	6-9
Wok burner	10-15		9	6-8		4	4-7
Cream of pumpkin, borscht							
High-output burner	30-35		9	10-12		5	20-23
Standard-output burner	45-50		9	15-17		6	30-33
Wok burner	25-30		9	8-10		2	17-20
Minestrone (vegetable soup)							
High-output burner	47-52		9	10-12		5	37-40
Standard-output burner	57-62		9	10-12		6	47-50
Wok burner	43-48		8	8-10		3	35-38
<b>Pasta and rice</b>							
Spaghetti							
High-output burner	18-22		9	8-10		6	10-12
Standard-output burner	20-24		9	10-12		7	10-12
Wok burner	18-22		8	8-10		6	10-12
Rice							
High-output burner	17-22		9	5-7		2	12-15
Standard-output burner	18-23		9	7-9		6	11-14
Wok burner	15-20		8	4-6		2	11-14
Ravioli							
High-output burner	9-14		9	4-6		6	5-8
Standard-output burner	17-22		8	12-14		8	5-8
Wok burner	10-15		8	5-7		8	5-8
<b>Vegetables and pulses</b>							
Boiled potatoes (mashed, potato salad)							
High-output burner	23-28		9	8-10		5	15-18

Food Burner	Total time in min.	Step 1			Step 2		
Standard-out-put burner	25-30		9	10-12		6	15-18
Wok burner	25-30		7	11-13		5	14-17
Hummus (puréed chickpeas)							
High-output burner	50-55		9	10-12		4	40-43
Standard-out-put burner	52-57		9	12-14		5	40-43
Wok burner	47-52		7	10-12		5	37-40
Lentils							
High-output burner	40-45		9	8-10		8	32-35
Standard-out-put burner	50-55		9	18-20		6	32-35
Wok burner	45-50		6	20-22		4	25-28
Deep-fried vegetables							
High-output burner	12-17		7	6-8		6	6-9
Standard-out-put burner	15-20		8	8-10		7	7-10
Dual wok burner	10-15		7	5-7		5	5-8
Sautéed fresh vegetables**							
Wok burner	6-8		9	6-8			
High-output burner	6-8		9	6-8			
Chips							
Wok burner	15-20		7	15-20			
High-output burner	15-20		9	15-20			
Standard-out-put burner	25-30		9	25-30			
<b>Eggs</b>							
Shakshuka							
Standard-out-put burner	15-20		9	10-12		4	5-8
High-output burner	13-18		8	7-9		3	6-9
Dual wok burner	15-20		6	11-13		4	4-7
Omelette (1 port.)							
Standard-out-put burner	3-5		8	3-5			
High-output burner	2-4		9	2-4			
Wok burner	2-4		5	2-4			
Spanish tortilla							
High-output burner	25-30		9	25-30			
Wok burner	18-23		9	18-23			

Food Burner	Total time in min.	Step 1			Step 2		
Dual wok burner	25-30		7	25-30			
<b>Sauces</b>							
Béchamel sauce**							
Economy burner	10-15		6	2-4		6	8-11
Standard-out-put burner	10-15		5	2-4		5	8-11
Wok burner	3-8		5	1-2		5	2-6
Blue cheese sauce**							
Economy burner	4-6		7	4-6			
Standard-out-put burner	3-5		7	3-5			
High-output burner	3-5		5	3-5			
Neapolitan sauce							
Standard-out-put burner	18-23		6	2-4		4	16-19
Wok burner	13-18		7	1-3		5	12-15
High-output burner	15-20		8	1-3		6	14-17
Carbonara sauce							
Standard-out-put burner	10-15		6	5-7		3	5-8
High-output burner	8-13		5	4-6		3	4-7
Economy burner	10-15		9	5-7		5	5-8
<b>Fish</b>							
Roman-style hake							
High-output burner	5-10		8	5-10			
Standard-out-put burner	8-13		9	8-13			
Wok burner	4-9		6	4-9			
Baked salmon							
High-output burner	5-10		7	2-4		1	3-6
Dual wok burner	5-10		6	2-4		1	3-6
Wok burner	7-12		8	2-4		1	5-8
Mussels							
High-output burner	5-7		9	5-7			
Wok burner	4-6		9	4-6			
Standard-out-put burner	10-12		9	10-12			

Food Burner	Total time in min.	Step 1			Step 2		
							
<b>Meat</b>							
Duck breast (x 1)							
Standard-out-put burner	6-8	 *	7	6-8			
High-output burner	9-11	 *	7	9-11			
Wok burner	6-8	 *	5	6-8			
Beef tenderloin stroganoff							
High-output burner	8-13	 *	9	8-13			
Wok burner	5-10	 *	8	5-10			
Standard-out-put burner	12-17	 *	9	12-17			
Chicken schnitzels (8 chicken breast fillets)							
High-output burner	7-12	 *	9	2-4	 *	6	5-8
Wok burner	7-12	 *	9	2-4	 *	6	5-8
Standard-out-put burner	7-12	 *	9	7-12			
Minced meat (meat pies, pasties and other pastry-covered meat, meatballs, bolognese sauce)							
High-output burner	15-20	 *	8	15-20			
Standard-out-put burner	20-25	 *	9	20-25			
Wok burner	15-20	 *	6	15-20			
<b>Convenience products</b>							
Frozen croquettes (x 16) Frozen fish fingers (x 12)							
High-output burner	6-10	 *	8	6-10			
Wok burner	5-9	 *	8	5-9			
Standard-out-put burner	8-12	 *	8	8-12			
Fried sausages (x 12)							
High-output burner	5-10	 *	9	1-3	 *	7	4-7
Standard-out-put burner	7-12	 *	9	7-12			
Wok burner	5-10	 *	9	1-3	 *	7	4-7
Boiled sausages (x 12)							
Standard-out-put burner	8-13	 *	9	8-13			
Wok burner	9-14	 *	4	9-14			
High-output burner	7-12	 *	7	7-12			
Hamburgers (x 4)							
High-output burner	4-9	 *	9	1-3	 *	7	3-6
Wok burner	4-9	 *	9	1-3	 *	7	3-6

Food Burner	Total time in min.	Step 1			Step 2		
							
Standard-out-put burner	5-10	 *	9	1-3	 *	8	4-7
Frozen vegetables**							
High-output burner	7-12	 *	9	7-12			
Wok burner	5-10	 *	9	5-10			
Standard-out-put burner	12-17	 *	9	12-17			
Pizza (8 inch)							
Wok burner	4-8	 *	1	4-8			
High-output burner	16-20	 *	1	16-20			
Standard-out-put burner	20-25	 *	1	20-25			
<b>Desserts</b>							
Rice pudding**							
Standard-out-put burner	30-35	 *	8	9-11	 *	4	21-24
Economy burner	40-45	 *	9	12-14	 *	2	28-31
Wok burner	35-40	 *	7	11-13	 *	1	24-27
Milk chocolate							
Economy burner	10-14	 *	1	10-14			
Standard-out-put burner	16-20	 *	1	16-20			
Crêpes (x 4)							
High-output burner	17-22	 *	7	1-3	 *	5	16-19
Wok burner	8-13	 *	7	1-3	 *	4	7-10
Dual wok burner	9-14	 *	5	1-3	 *	4	8-11
Bread pudding							
High-output burner	25-30	 *	9	10-12	 *	6	15-18
Wok burner	23-28	 *	9	8-10	 *	7	15-18
Standard-out-put burner	27-32	 *	9	10-12	 *	7	17-20
Spanish pudding**							
High-output burner	3-8	 *	5	3-8			
Standard-out-put burner	8-13	 *	5	8-13			
Wok burner	3-8	 *	2	3-8			
Sponge cake (in bain marie)							
High-output burner	35-40	 *	9	35-40			
Wok burner	40-45	 *	9	40-45			
Standard-out-put burner	45-50	 *	9	45-50			

### Cooking tips

- Use a pressure cooker to cook creamy soups and pulses. This significantly reduces the cooking time. If you are using a pressure cooker, follow the manufacturer's instructions. Add all of the ingredients at the start.
- Always use a lid when cooking potatoes and rice. This significantly reduces the cooking time. The water must be boiling before you add pasta, rice or potatoes. Then adjust the heat setting to continue boiling.
- For pan-cooked dishes, heat the oil up first. As soon as you have started the frying, keep the pan at a constant temperature by adjusting the heating setting as required. When preparing several portions, wait until the relevant temperature has been reached again. Turn the food regularly.
- When cooking soups, cream, lentils or chickpeas, add all of the ingredients to the cookware at the same time.



## Cleaning and maintenance

### Cleaning

Once the appliance is cool, use a sponge to clean it with soap and water.

After each use, clean the surface of the respective burner parts once they have cooled down. If any residue is left (baked-on food, drops of grease etc.), however little, it will become stuck to the surface and more difficult to remove later. The holes and grooves must be clean for the flame to ignite properly.

The movement of some pans may leave metal residue on the pan supports.

Clean the burners and pan supports using soapy water and scrub with a non-wire brush.

If the pan supports are fitted with rubber rests, ensure that these are also cleaned. The rests may come loose and the pan support may scratch the hob.

Always dry the burners and pan supports completely. Water droplets or damp patches on the hob at the start of cooking may damage the enamel.

After cleaning and drying the burners, make sure the burner caps are correctly positioned on the diffuser.

### Caution!

- Do not remove the control knobs when cleaning the appliance. The appliance may be damaged if moisture finds its way inside.
- Do not use steam cleaners. This could damage the hob.
- If your hob is fitted with a glass or aluminium panel, never use a knife, scraper or similar implement to clean the point where it joins the metal.

### Maintenance

Always clean off any liquid as soon as it is spilt. This will prevent food remains from sticking to the hob surface and you will save yourself any unnecessary effort.

Due to the high temperatures endured, the wok burner and the stainless steel zones (grease drip tray, burner outline, etc.) can change colour. This is normal. After each use, clean these areas with a product that is suitable for stainless steel.

It is recommended that the cleaning product available from our Technical Assistance Service (code 311499) is used regularly.

### Caution!

The stainless steel cleaner must not be used in the area around the controls. The (printed) symbols may be wiped off.

Do not leave acidic liquids (e.g. lemon juice, vinegar, etc.) on the hob.

## Trouble shooting

Sometimes certain faults detected can be easily resolved. Before calling the Technical Assistance Service, bear in mind the following advice:

Fault	Possible cause	Solution
The general electrical system is malfunctioning.	Defective fuse.	Check the fuse in the main fuse box and change it if it is damaged.
	The automatic safety switch or circuit breaker has tripped.	Check the main control panel to see if the automatic safety switch or circuit breaker has tripped.
The automatic switching on function does not work.	There may be food or cleaning products stuck between the ignition sparkers and the burners.	The space between the ignition sparker and the burner must be clean.
	The burners are wet.	Dry the burner caps carefully.
	The burner caps are not correctly positioned.	Check that the burner caps are correctly positioned.
	The appliance is not earthed, is poorly connected or the earthing is faulty.	Contact the installation technician.
The burner flame is not uniform.	The burner components are not correctly positioned.	Correctly place the parts on the appropriate burner.
	The grooves on the burner are dirty.	Clean the grooves on the burner.
The gas flow is not normal or there is no gas.	The gas supply is blocked by gas taps.	Open all gas taps.
	If the gas is supplied from a gas cylinder, check that it is not empty.	Change the gas cylinder.
The kitchen smells of gas.	A gas tap has been left on.	Turn off the taps.
	Incorrect coupling of gas cylinder.	Check that the coupling is sound.
	Possible gas leak.	Shut off the gas supply, ventilate the premises and immediately notify an authorised installation technician to check and certify the installation. Do not use the appliance until ensuring that there is no gas leak in the installation or appliance itself.
The burner immediately switches off after releasing the control knob.	The control knob was not held down for long enough.	Once the burner is on, hold the control knob down a few seconds longer.
	The grooves on the burner are dirty.	Clean the grooves on the burner.

## Customer service

When contacting our customer service, please provide the product number (E-Nr.) and production number (FD) of the appliance. This information is given on the specifications plate located on the lower section of the hob and on the label in the user manual.

After-sales contact details for all countries can be found in the attached after-sales service directory.

### Warranty conditions

In the unlikely event that the appliance is damaged or does not meet your expectations in terms of quality, please inform us as soon as possible. For the warranty to be valid, the appliance must not have been tampered with, or used inappropriately.

The applicable warranty conditions are those set out by the company's representative office in the country of purchase. Detailed information is available from retail outlets. Proof of purchase must be presented to obtain the benefits of the warranty.

We reserve the right to introduce changes.

## Environmental protection

If the  symbol is shown on the specifications plate, bear in mind the following instructions:

### Environmentally-friendly disposal

Dispose of packaging in an environmentally-friendly manner.



This appliance is labelled in accordance with European Directive 2012/19/EU concerning used electrical and electronic appliances (waste electrical and electronic equipment - WEEE). The guideline determines the framework for the return and recycling of used appliances as applicable throughout the EU.

The packaging of your appliance has been manufactured using only the materials which are strictly necessary to guarantee efficient protection during transport. These materials are 100% recyclable, thus reducing the environmental impact. You can also contribute to caring for the environment by following the advice below:

- Dispose of the packaging in the appropriate recycling bin.
- Before you get rid of an old appliance, make sure you disable it. Contact your local authority to find out the address of your nearest recycling centre to dispose of your appliance.
- Do not pour used oil down the sink. Collect it in a sealed container and take it to an appropriate collection point or, failing that, place it in the rubbish bin (it will end up in a controlled dump; this is probably not the best option, but it will avoid contaminating ground water).



# Índice

	<b>Uso correcto del aparato</b> . . . . .	15
	<b>Indicaciones de seguridad importantes</b> . . . . .	16
	<b>Consejos y advertencias generales</b> . . . . .	17
	Información técnica . . . . .	17
	IMPORTANTE . . . . .	17
	<b>Presentación del aparato</b> . . . . .	18
	Mandos y quemadores . . . . .	18
	Accesorios . . . . .	18
	<b>Quemadores de gas</b> . . . . .	19
	Encendido manual . . . . .	19
	Encendido automático . . . . .	19
	Sistema de seguridad . . . . .	19
	Apagar un quemador . . . . .	19
	Interruptor principal / Bloqueo de la placa de cocción (Main Switch) . . . . .	20
	Advertencias . . . . .	20
	<b>Tablas y consejos</b> . . . . .	20
	Recipientes apropiados . . . . .	20
	Advertencias de uso . . . . .	20
	Tabla de cocción . . . . .	21
	<b>Limpieza y cuidados del aparato</b> . . . . .	24
	Limpieza . . . . .	24
	Mantenimiento . . . . .	24
	<b>¿Qué hacer en caso de avería?</b> . . . . .	24
	<b>Servicio de Asistencia Técnica</b> . . . . .	25
	Condiciones de garantía . . . . .	25
	<b>Protección del medio ambiente</b> . . . . .	25
	Eliminación de residuos respetuosa con el medio ambiente . . . . .	25

Encontrará más información sobre productos, accesorios, piezas de repuesto y servicios en internet: [www.bosch-home.com](http://www.bosch-home.com) y también en la tienda online: [www.bosch-eshop.com](http://www.bosch-eshop.com)

## **Uso correcto del aparato**

Lea atentamente estas instrucciones. Solo entonces podrá manejar su aparato de manera efectiva y segura. Conserve las instrucciones de uso e instalación y entréguelas con el aparato si este cambia de dueño.

**El fabricante queda exento de toda responsabilidad si no se cumplen las disposiciones de este manual.**

Las imágenes representadas en estas instrucciones tienen carácter orientativo.

No saque el aparato del embalaje protector hasta el momento del encastre. Si observa algún daño en el aparato, no lo conecte. Póngase en contacto con nuestro Servicio Técnico.

Este aparato corresponde a la clase 3, según la norma EN 30-1-1 para aparatos a gas: aparato encastrado en un mueble.

Antes de instalar su nueva placa de cocción asegúrese de que la instalación se realiza siguiendo las instrucciones de montaje.

Este aparato no puede ser instalado en yates o caravanas.

Este aparato se debe utilizar únicamente en lugares suficientemente ventilados.

Este aparato no está previsto para el funcionamiento con un reloj temporizador externo o un mando a distancia.

**Todos los trabajos de instalación, conexión, regulación y adaptación a otros tipos de gas deben ser realizados por un técnico autorizado, respetando toda la normativa y legislación aplicables y las prescripciones de las compañías locales proveedoras de gas y electricidad. Se pondrá especial atención a las disposiciones aplicables en cuanto a la ventilación.**

Este aparato sale de fábrica adaptado al tipo de gas que indica la placa de características. Si fuera necesario cambiarlo, consulte las instrucciones de montaje. Se recomienda llamar a nuestro Servicio Técnico para la adaptación a otros tipos de gas.

Este aparato ha sido diseñado solo para uso doméstico, no está permitido su uso comercial o profesional. Utilice el aparato únicamente para cocinar, nunca como

calefacción. La garantía únicamente tendrá validez en caso de que se respete el uso para el que fue diseñado.

Este aparato está previsto para ser utilizado a una altura máxima de 2.000 metros sobre el nivel del mar.

No use tapas o barreras de protección para niños que no estén recomendadas por el fabricante de la placa de cocción. Pueden provocar accidentes, p. ej. debido al sobrecalentamiento, ignición o desprendimiento de fragmentos de materiales.

Este aparato puede ser utilizado por niños a partir de 8 años y por personas con limitaciones físicas, sensoriales o psíquicas, o que carezcan de experiencia y conocimientos, siempre y cuando sea bajo la supervisión de una persona responsable de su seguridad o que le haya instruido en el uso correcto del aparato siendo consciente de los daños que se pudieran ocasionar.

No dejar que los niños jueguen con el aparato. La limpieza y el mantenimiento rutinario no deben encomendarse a los niños a menos que sean mayores de 15 años y lo hagan bajo supervisión.

Mantener a los niños menores de 8 años alejados del aparato y del cable de conexión.

## **Indicaciones de seguridad importantes**

### **Advertencia – ¡Peligro de deflagración!**

La acumulación de gas sin quemar en un recinto cerrado conlleva peligro de deflagración. No someta el aparato a corrientes de aire. Los quemadores podrían apagarse. Lea atentamente las instrucciones y advertencias relativas al funcionamiento de los quemadores de gas.

### **Advertencia – ¡Peligro de intoxicación!**

El uso de un aparato de cocción a gas produce calor, humedad y productos de combustión en el local donde está instalado. Asegure una buena ventilación de la cocina, especialmente mientras la placa de cocción esté en funcionamiento: mantenga abiertos los orificios de ventilación natural o instale un dispositivo de ventilación mecánica (campana extractora). La utilización intensa y prolongada del aparato puede necesitar una ventilación complementaria o más eficaz: abra una ventana o aumente la potencia de la ventilación mecánica.

### **Advertencia – ¡Peligro de quemaduras!**

- Las zonas de cocción y adyacentes se calientan mucho. No toque nunca las superficies calientes. Mantenga alejados a los niños menores de 8 años.
- Si la botella de gas líquido no está en posición vertical, el propano/butano líquido puede llegar al interior del aparato, por lo que puede causar llamas vivas en los quemadores. Con el tiempo, los componentes pueden dañarse y perder estanqueidad, de modo que puede escaparse gas. Ambos casos pueden producir quemaduras. Utilizar botellas de gas líquido siempre en posición vertical.

### **Advertencia – ¡Peligro de incendio!**

- Debe vigilarse el proceso de cocción. Si el proceso de cocción es breve, debe vigilarse ininterrumpidamente.
- Las zonas de cocción se calientan mucho. No coloque objetos inflamables sobre la placa de cocción. No almacene objetos sobre la placa de cocción.
- No almacene ni utilice productos químicos corrosivos, vapores, materiales inflamables ni productos no alimenticios debajo de este electrodoméstico ni cerca de él.

- Las grasas o aceites sobrecalentados se inflaman fácilmente. No se ausente mientras caliente grasa o aceite. Si se inflaman, no apague el fuego con agua. Cubra el recipiente con una tapa para sofocar el fuego y desconecte la zona de cocción.

### **⚠ Advertencia – ¡Peligro de lesiones!**

- Los recipientes que presenten daños, tengan un tamaño inadecuado, rebasen los bordes de la placa de cocción o estén mal situados pueden provocar lesiones graves. Observe los consejos y advertencias relativos a los recipientes de cocinado.

- Las reparaciones inadecuadas son peligrosas. Las reparaciones y la sustitución de cables eléctricos y conductos de gas defectuosos solo pueden ser efectuadas por personal del Servicio Técnico debidamente instruido. Si el aparato está averiado, desenchufarlo de la red o desconectar el interruptor automático del cuadro eléctrico y cortar la alimentación de gas. Avisar al Servicio de Asistencia Técnica.
- Si alguno de los mandos no se puede girar o está suelto, no lo use. Llame inmediatamente al servicio técnico para que proceda a su reparación o sustitución.

### **⚠ Advertencia – ¡Peligro de descarga eléctrica!**

No utilice máquinas de limpieza a vapor para limpiar el aparato.

## Consejos y advertencias generales

### Información técnica

		Quemador auxiliar	Quemador semi-rápido	Quemador rápido	Quemador wok	Quemador wok dual
Capacidad térmica	GAS NATURAL	1,00 kW	1,75 kW	3,00 kW	4,00 kW	5,00 kW
	GAS LP					4,60 kW
Modelo PCP6A5B90V		1	2	1	-	-
Modelo PCQ7A5B90V		1	2	1	1	-
Modelo PCQ7A5M90V		1	2	1	1	-
Modelo PCS7A5M90V		1	2	1	-	1
Modelo PCR9A5M90V		1	2	1	-	1
Opciones de regulación	GAS NATURAL G20/17,6 - 19,6 mbar; 1,76 - 1,96 kPa					
	GAS LP G30/27,5 mbar; 2,75 kPa					
Características eléctricas	110 - 240 V~ 50/60 Hz					

NOTA: Este producto opera con gas L.P. Si se quiere utilizar el producto con gas natural llame a nuestro centro de servicio.

### IMPORTANTE

- Coloque las parrillas y los quemadores como se indica en los esquemas donde se describe el modelo.
- Mantenga los alrededores del aparato libres de materiales combustibles, gasolina y otros vapores o líquidos inflamables.
- No utilice el aparato como calefacción, ya que esto es peligroso.

### PARA SU SEGURIDAD

#### SI HUELE A GAS:

- ABRA LAS VENTANAS
- NO TOQUE INTERRUPTORES ELÉCTRICOS
- APAGUE TODAS LAS LLAMAS CERRANDO LA VÁLVULA GENERAL DE PASO
- LLAME INMEDIATAMENTE A LOS BOMBEROS O A SU PROVEEDOR DE GAS

### PARA SU SEGURIDAD

- NO ALMACENE GASOLINA U OTROS FLUIDOS FLAMABLES EN LA CERCANÍA DE SU APARATO
- INSTALE SU PRODUCTO CONFORME A LAS INSTRUCCIONES DEL EMPOTRE PARA EVITAR DAÑO A SUS MUEBLES POR TEMPERATURA

## Presentación del aparato



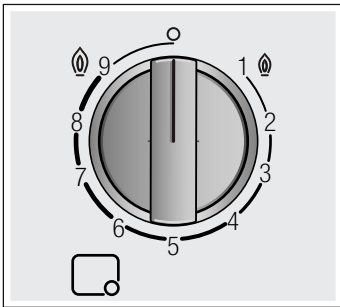

En el resumen de los modelos encontrará una vista general de su aparato así como la potencia de los quemadores. → *Página 2*

### Mandos y quemadores

Cada mando de accionamiento tiene señalado el quemador que controla. Los mandos le permiten regular la potencia que necesite, según las distintas posiciones, entre los niveles máximo y mínimo. Nunca intente pasar directamente de la posición 0 a la 1 ni volver de la posición 1 a la 0.



#### Indicaciones

	Quemador controlado por el mando
	Quemador apagado
	Potencia máxima y encendido eléctrico
	Potencia mínima

En los quemadores de doble llama duales, las llamas interior y exterior se pueden regular de forma independiente. Los niveles de potencia posibles son:

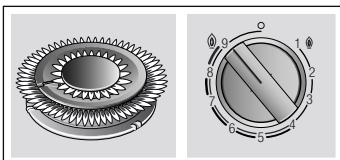

Llama exterior e interior a la máxima potencia.

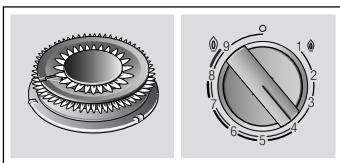

Llama exterior a la mínima potencia, llama interior a la máxima potencia.

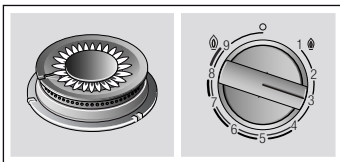

Llama interior a la máxima potencia.

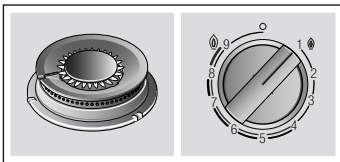

Llama interior a la mínima potencia.

Para un correcto funcionamiento del aparato es imprescindible asegurarse de que las parrillas y todas las piezas de los quemadores estén bien colocadas. No intercambie las tapas de los quemadores.

Retire las parrillas siempre con cuidado. El movimiento de una parrilla puede desplazar las parrillas contiguas.

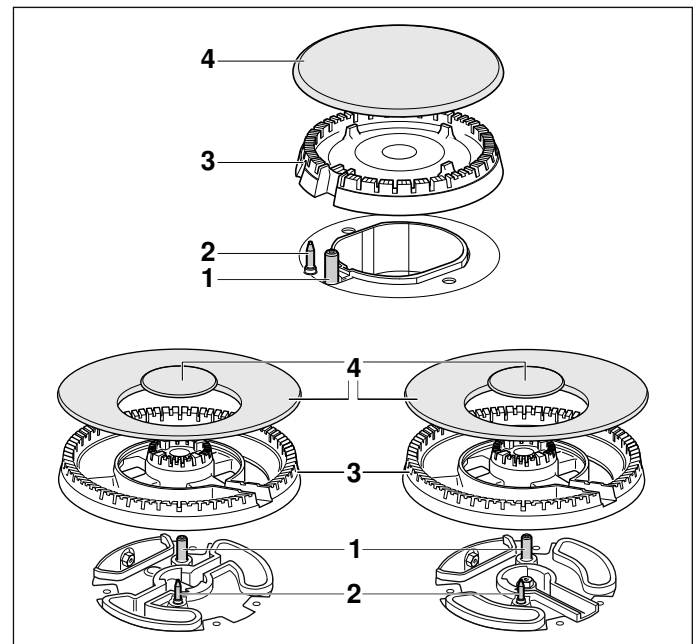

#### Elementos

1	Bujía
2	Termopar
3	Difusor
4	Tapa

### Accesorios

Según modelo, la placa de cocción puede incluir los siguientes accesorios. Estos también se pueden adquirir en el Servicio Técnico.

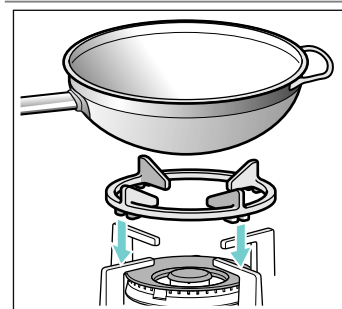

#### Parrilla supletoria wok

Para utilizar exclusivamente en quemadores wok con recipientes de base cóncava. Se recomienda utilizar la parrilla supletoria wok para prolongar la vida útil del aparato.

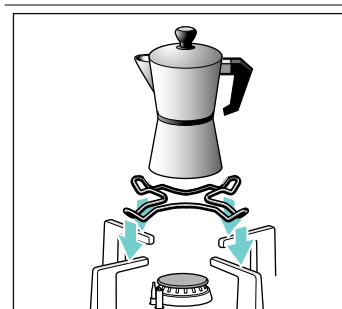

#### Parrilla supletoria cafetera

Para utilizar exclusivamente en el quemador de menor potencia con recipientes de diámetro inferior a 12 cm.

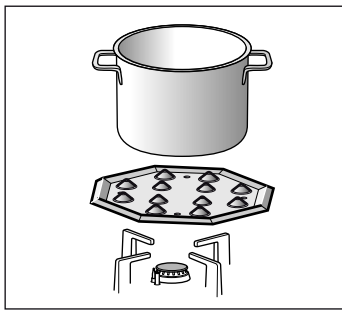

### Simmer Plate

Este accesorio ha sido diseñado para cocinar a fuego lento. Se puede utilizar sobre el quemador auxiliar o el semi-rápido. Si su placa de cocción dispone de varios quemadores semi-rápidos, se recomienda utilizar la Simmer Plate sobre el quemador semi-rápido trasero o el delantero derecho.

Colocar el accesorio directamente sobre la parrilla con los volcanes hacia arriba, nunca directamente sobre el quemador.

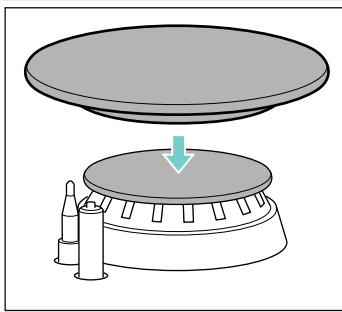

### Simmer Cap

Tapa exclusivamente indicada para cocinar en la potencia mínima. Coloque la tapa Simmer Cap sobre la tapa del quemador auxiliar. Coloque el recipiente de cocinado sobre la parrilla, nunca cocine directamente sobre la Simmer Cap.

### Código

HEZ298107 Parrilla supletoria wok: hierro fundido (4-5 kW)

HEZ298110 Parrilla supletoria wok: acero esmaltada

HEZ298115 Parrilla supletoria cafetera

HEZ298105 Simmer Plate

HEZ211310 Simmer Cap

El fabricante no asume responsabilidad si no se utilizan o se utilizan incorrectamente estos accesorios.

## Quemadores de gas

### Encendido manual

1. Presione el mando del quemador elegido y gírelo hacia la izquierda hasta la posición de máxima potencia.
2. Acerque algún tipo de encendedor o llama (mecheros, cerillas, etc.) al quemador.

### Encendido automático

Si su placa de cocción dispone de encendido automático (bujías):

1. Presione el mando del quemador elegido y gírelo hacia la izquierda hasta la posición de máxima potencia. Mientras el mando está presionado se producen chispas en todos los quemadores. La llama se enciende. Espere unos segundos.
2. Deje de presionar el mando.
3. Gire el mando a la posición deseada.

Si no se produce el encendido, gire el mando a la posición de apagado y repita los pasos. Esta vez mantenga el mando presionado durante más tiempo (hasta 10 segundos).

### Advertencia – ¡Peligro de deflagración!

Si transcurridos 15 segundos la llama no se enciende, apague el quemador y abra la puerta o ventana del recinto. Espere al menos un minuto antes de intentar encender el quemador.

**Nota:** Mantenga la máxima limpieza. Si las bujías están sucias el encendido será defectuoso. Límpielas periódicamente con un cepillo no metálico pequeño. Tenga en cuenta que las bujías no deben sufrir impactos violentos.

### Sistema de seguridad

Su placa de cocción dispone de un sistema de seguridad (termopar) que impide el paso de gas si los quemadores se apagan accidentalmente.

Para garantizar que este dispositivo esté activo:

1. Encienda el quemador con normalidad.
2. Sin soltar el mando, manténgalo presionado firmemente durante 4 segundos tras haberse encendido la llama.

### Apagar un quemador

Gire el mando correspondiente hacia la derecha hasta la posición 0.

Unos segundos después del apagado del quemador se producirá un sonido (golpe seco). No es ninguna anomalía, eso significa que la seguridad se ha desactivado.



## Interruptor principal / Bloqueo de la placa de cocción (Main Switch)

La placa de cocción puede disponer de un interruptor principal, que corta el paso de gas general, y apaga todos los quemadores a la vez. Este interruptor es muy práctico si se tienen niños en casa, o si por algún motivo tiene que apagar rápidamente todos los quemadores.

### Para bloquear la placa de cocción:

Presione el interruptor principal.

Todos los quemadores que están encendidos se apagan. La placa de cocción se bloquea.

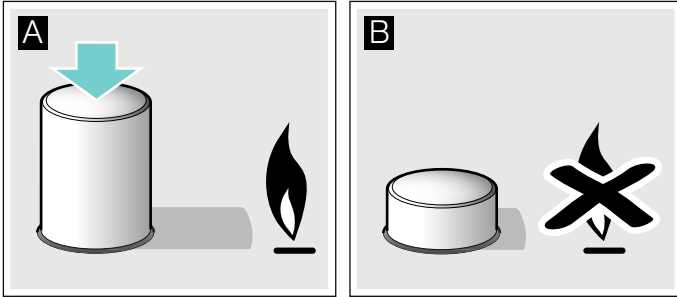

### Para desbloquear la placa de cocción:

1. Coloque todos los mandos en la posición de apagado.
2. Presione y gire el interruptor principal en sentido horario hasta el tope.

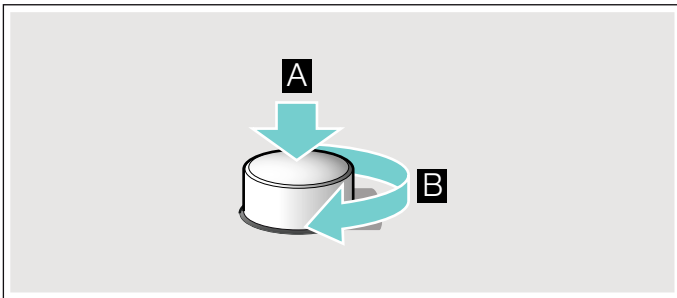

Se abre el paso de gas general. Ya puede utilizar la placa de cocción con normalidad.

## Advertencias

Durante el funcionamiento del quemador es normal que se escuche un leve silbido.

En los primeros usos es normal que se desprendan olores. Esto no supone ningún riesgo ni mal funcionamiento. Irán desapareciendo.

Una llama de color naranja es normal. Se debe a la presencia de polvo en el ambiente, líquidos derramados, etc.

En el caso de una extinción accidental de las llamas del quemador, cierre el mando de accionamiento del quemador y no intente reencenderlo durante por lo menos 1 minuto.

## Tablas y consejos

### Recipientes apropiados

Quemador	Diámetro mínimo de la base del recipiente	Diámetro máximo de la base del recipiente
Quemador wok	22 cm	30 cm
Quemador rápido	20 cm	26 cm
Quemador semi-rápido	14 cm	22 cm
Quemador auxiliar	12 cm	16 cm

El recipiente no debe rebasar los bordes de la placa de cocción.

### Advertencias de uso

**Nota:** El uso de algunos recipientes puede causar cierta deformación temporal en la grasera. Esto es normal y no tiene influencia en el funcionamiento del aparato.

Los siguientes consejos le ayudarán a ahorrar energía y a evitar daños en los recipientes:

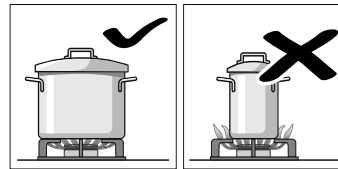

Utilice recipientes de tamaño apropiado a cada quemador.

No utilice recipientes pequeños en quemadores grandes. La llama no debe tocar los laterales del recipiente.

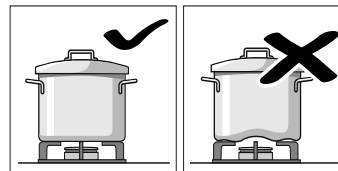

No utilice recipientes deformados que se muestren inestables sobre la placa de cocción. Los recipientes podrían volcar. Utilice solo recipientes de base plana y gruesa.

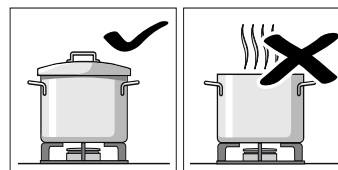

No cocine sin tapa o con esta desplazada. Se desperdicia parte de la energía.

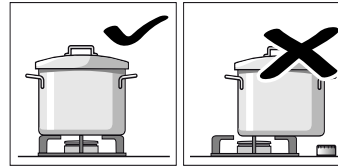

Coloque el recipiente bien centrado sobre el quemador. En caso contrario podría volcar. No coloque los recipientes grandes en los quemadores cercanos a los mandos. Estos pueden resultar dañados debido al exceso de temperatura.



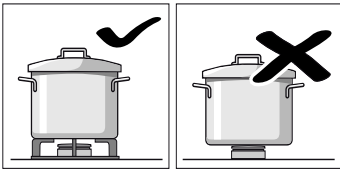

Coloque los recipientes sobre las parrillas, nunca directamente sobre el quemador. Asegúrese de que las parrillas y tapas de los quemadores estén bien colocadas antes de su uso.

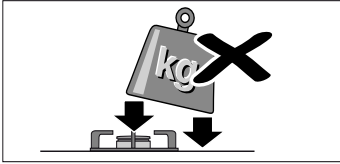

Maneje los recipientes con cuidado sobre la placa de cocción. No golpee la placa de cocción ni coloque sobre ella pesos excesivos.

### Tabla de cocción

En la tabla siguiente se presentan las posiciones y tiempos de cocción óptimos para una selección de platos. Los datos son valores de referencia para cuatro comensales.

El tiempo y las posiciones de cocción dependen del tipo, peso y calidad de los alimentos, del tipo de gas, así como del material de los recipientes de cocinado. Para cocinar estos platos se han utilizado principalmente recipientes de cocinado de acero inoxidable.

Utilice siempre recipientes de cocinado de diámetros adecuados y colóquelos bien centrados sobre el quemador. Consulte la información relativa a los diámetros de recipientes de cocinado. → "Recipientes apropiados"

### Cómo interpretar la tabla

La elaboración de cada plato consta de uno o dos pasos. Cada paso contiene información sobre:

- Método de cocción
- Posición de cocción
- Duración en minutos

### Métodos de cocción indicados en la tabla

- Llevar a ebullición
- Mantener ebullición
- Ganar presión en olla a presión
- Mantener presión en olla a presión
- Freír fuerte
- Freír suave
- Derretir, fundir
- \* Sin tapa
- \*\* Remover continuamente

**Nota:** Los símbolos no aparecen en el aparato, se utilizan como orientación sobre los cambios de modo de cocinado.

Se presentan indicaciones para cocinar cada plato en diferentes quemadores. La opción recomendada es el primer quemador mencionado. En el resumen de los modelos está identificado cada quemador de la placa de cocción. → *Página 2*

Ejemplo:

Plato	Tiempo total en min	Paso 1			Paso 2		
Quegador							

### Sopas, cremas

Sopa de pescado							
Quegador rápido	12-17		8	7-9		1	5-8
Quegador semi-rápido	17-22		8	11-13		1	6-9
Quegador wok	10-15		9	6-8		4	4-7

En el ejemplo se muestran indicaciones para cocinar sopa de pescado utilizando los quemadores rápido, semi-rápido o wok.

Utilizando el quemador rápido (opción recomendada) el tiempo total para la cocción es de 12 a 17 minutos.

- Paso 1: llevar a ebullición. Utilice la posición de cocción 8 durante 7-9 minutos.
- Paso 2: mantener ebullición. Cambie a la posición 1 durante 5-8 minutos.

Las indicaciones para el resto de quemadores propuestos se deben interpretar de forma análoga.

Plato	Tiempo total en min	Paso 1			Paso 2		
Quegadores							

### Sopas, cremas

Sopa de pescado							
Quegador rápido	12-17		8	7-9		1	5-8
Q. semi-rápido	17-22		8	11-13		1	6-9
Quegador wok	10-15		9	6-8		4	4-7
Crema de calabaza, sopa Borsch							
Quegador rápido	30-35		9	10-12		5	20-23
Q. semi-rápido	45-50		9	15-17		6	30-33
Quegador wok	25-30		9	8-10		2	17-20
Minestrone (sopa de verduras)							
Quegador rápido	47-52		9	10-12		5	37-40
Q. semi-rápido	57-62		9	10-12		6	47-50
Quegador wok	43-48		8	8-10		3	35-38

### Pasta y arroz

Espaguetis								
Quegador rápido	18-22		*	9	8-10		6	10-12
Q. semi-rápido	20-24		*	9	10-12		7	10-12
Quegador wok	18-22		*	8	8-10		6	10-12
Arroz								
Quegador rápido	17-22			9	5-7		2	12-15
Q. semi-rápido	18-23			9	7-9		6	11-14
Quegador wok	15-20			8	4-6		2	11-14

Plato	Tiempo total en min	Paso 1	Paso 2
-------	---------------------	--------	--------

Plato	Tiempo total en min	Paso 1	Paso 2
Ravioli			
Quegador rápido	9-14	9	4-6
Q. semi-rápido	17-22	8	12-14
Quegador wok	10-15	8	5-7

**Verduras y legumbres**

Plato	Tiempo total en min	Paso 1	Paso 2
Patatas cocidas (puré, ensaladilla rusa)			
Quegador rápido	23-28	9	8-10
Q. semi-rápido	25-30	9	10-12
Quegador wok	25-30	7	11-13
Hummus (puré de garbanzos)			
Quegador rápido	50-55	9	10-12
Q. semi-rápido	52-57	9	12-14
Quegador wok	47-52	7	10-12

Plato	Tiempo total en min	Paso 1	Paso 2
Lentejas			
Quegador rápido	40-45	9	8-10
Q. semi-rápido	50-55	9	18-20
Quegador wok	45-50	6	20-22

Plato	Tiempo total en min	Paso 1	Paso 2
Tempura de verduras			
Quegador rápido	12-17	7	6-8
Q. semi-rápido	15-20	8	8-10
Q. wok dual	10-15	7	5-7

Plato	Tiempo total en min	Paso 1	Paso 2
Salteado de verduras frescas**			
Quegador wok	6-8	9	6-8
Quegador rápido	6-8	9	6-8

Plato	Tiempo total en min	Paso 1	Paso 2
Patatas fritas			
Quegador wok	15-20	7	15-20
Quegador rápido	15-20	9	15-20
Q. semi-rápido	25-30	9	25-30

**Huevos**

Plato	Tiempo total en min	Paso 1	Paso 2
Shakshuka			
Q. semi-rápido	15-20	9	10-12
Quegador rápido	13-18	8	7-9
Q. wok dual	15-20	6	11-13

Plato	Tiempo total en min	Paso 1	Paso 2
Tortilla francesa (1 ud.)			
Q. semi-rápido	3-5	8	3-5
Quegador rápido	2-4	9	2-4
Quegador wok	2-4	5	2-4

Plato	Tiempo total en min	Paso 1	Paso 2
Tortilla de patata			
Quegador rápido	25-30	9	25-30
Quegador wok	18-23	9	18-23
Q. wok dual	25-30	7	25-30

Plato	Tiempo total en min	Paso 1	Paso 2
-------	---------------------	--------	--------

**Salsas**

Plato	Tiempo total en min	Paso 1	Paso 2
Salsa bechamel**			
Q. auxiliar	10-15	6	2-4
Q. semi-rápido	10-15	5	2-4
Quegador wok	3-8	5	1-2

Plato	Tiempo total en min	Paso 1	Paso 2
Salsa de queso azul**			
Q. auxiliar	4-6	7	4-6
Q. semi-rápido	3-5	7	3-5
Quegador rápido	3-5	5	3-5

Plato	Tiempo total en min	Paso 1	Paso 2
Salsa napolitana			
Q. semi-rápido	18-23	6	2-4
Quegador wok	13-18	7	1-3
Quegador rápido	15-20	8	1-3

Plato	Tiempo total en min	Paso 1	Paso 2
Salsa carbonara			
Q. semi-rápido	10-15	6	5-7
Quegador rápido	8-13	5	4-6
Q. auxiliar	10-15	9	5-7

**Pescado**

Plato	Tiempo total en min	Paso 1	Paso 2
Merluza a la romana			
Quegador rápido	5-10	8	5-10
Q. semi-rápido	8-13	9	8-13
Quegador wok	4-9	6	4-9

Plato	Tiempo total en min	Paso 1	Paso 2
Salmón asado			
Quegador rápido	5-10	7	2-4
Q. wok dual	5-10	6	2-4
Quegador wok	7-12	8	2-4









Plato	Tiempo total en min	Paso 1	Paso 2
Mejillones			
Quegador rápido	5-7	9	5-7
Quegador wok	4-6	9	4-6
Q. semi-rápido	10-12	9	10-12

**Carne**

Plato	Tiempo total en min	Paso 1	Paso 2
Magret de pato (1 ud.)			
Q. semi-rápido	6-8	7	6-8
Quegador rápido	9-11	7	9-11
Quegador wok	6-8	5	6-8

Plato	Tiempo total en min	Paso 1	Paso 2
Solomillo Strogonoff			
Quegador rápido	8-13	9	8-13
Quegador wok	5-10	8	5-10
Q. semi-rápido	12-17	9	12-17









Plato	Tiempo total en min	Paso 1	Paso 2
Schnitzel de pollo (8 filetes de pechuga de pollo)			
Quegador rápido	7-12	9	2-4
Quegador wok	7-12	9	2-4

Plato Quemadores	Tiem- po to- tal en min	Paso 1			Paso 2		
							
Q. semi-rápido	7-12	 *	9	7-12			
Carne picada (pastel de carne, albóndigas, salsa boloñesa)							
Quegador rápido	15-20	 *	8	15-20			
Q. semi-rápido	20-25	 *	9	20-25			
Quegador wok	15-20	 *	6	15-20			



**Productos preparados**

Croquetas congeladas (16 uds.)







Varitas de pescado congeladas (12 uds.)

Quegador rápido	6-10	 *	8	6-10			
Quegador wok	5-9	 *	8	5-9			
Q. semi-rápido	8-12	 *	8	8-12			
Salchichas fritas (12 uds.)							
Quegador rápido	5-10	 *	9	1-3	 *	7	4-7
Q. semi-rápido	7-12	 *	9	7-12			
Quegador wok	5-10	 *	9	1-3	 *	7	4-7



Salchichas calentadas en agua (12 uds.)

Q. semi-rápido	8-13	 *	9	8-13			
Quegador wok	9-14	 *	4	9-14			
Quegador rápido	7-12	 *	7	7-12			



Hamburguesas (4 uds.)

Quegador rápido	4-9	 *	9	1-3	 *	7	3-6
Quegador wok	4-9	 *	9	1-3	 *	7	3-6
Q. semi-rápido	5-10	 *	9	1-3	 *	8	4-7

Verduras congeladas\*\*







Quegador rápido	7-12	 *	9	7-12			
Quegador wok	5-10	 *	9	5-10			
Q. semi-rápido	12-17	 *	9	12-17			

Pizza (20 cm de diámetro)

Quegador wok	4-8	 *	1	4-8			
Quegador rápido	16-20	 *	1	16-20			
Q. semi-rápido	20-25	 *	1	20-25			

**Postres**

Pudin de arroz\*\*

Q. semi-rápido	30-35	 *	8	9-11	 *	4	21-24
Q. auxiliar	40-45	 *	9	12-14	 *	2	28-31
Quegador wok	35-40	 *	7	11-13	 *	1	24-27

Chocolate con leche

Q. auxiliar	10-14	 *	1	10-14			
Q. semi-rápido	16-20	 *	1	16-20			

Crepes (4 uds.)

Quegador rápido	17-22	 *	7	1-3	 *	5	16-19
Quegador wok	8-13	 *	7	1-3	 *	4	7-10
Q. wok dual	9-14	 *	5	1-3	 *	4	8-11

Plato Quemadores	Tiem- po to- tal en min	Paso 1			Paso 2		
							
Pudin de pan							
Quegador rápido	25-30	 *	9	10-12	 *	6	15-18
Quegador wok	23-28	 *	9	8-10	 *	7	15-18
Q. semi-rápido	27-32	 *	9	10-12	 *	7	17-20
Natillas**							
Quegador rápido	3-8	 *	5	3-8			
Q. semi-rápido	8-13	 *	5	8-13			
Quegador wok	3-8	 *	2	3-8			
Bizcocho (al baño maría)							
Quegador rápido	35-40	 *	9	35-40			
Quegador wok	40-45	 *	9	40-45			
Q. semi-rápido	45-50	 *	9	45-50			

**Consejos de cocinado**

- Los tiempos de cocción de las cremas y legumbres pueden reducirse utilizando una olla a presión. Si utiliza una olla a presión siga las instrucciones del fabricante. Introduzca todos los ingredientes a la vez desde el principio.
- Utilizando tapa para la cocción de arroz y patata se reduce significativamente el tiempo de cocción. Lleve el agua a ebullición antes de introducir pasta, arroz o patatas y ajuste después la potencia para mantener la ebullición.
- Para las frituras se debe precalentar el aceite. Una vez iniciada la fritura del alimento, mantenga la temperatura constante ajustando la potencia si es necesario. Deje recuperar la temperatura del aceite entre diferentes lotes y dé vuelta a los alimentos frecuentemente.
- Introduzca todos los ingredientes a la vez en el recipiente para cocinar sopas, cremas, lentejas estofadas o garbanzos.



## Limpieza y cuidados del aparato

### Limpieza

Una vez frío el aparato, límpielo con una esponja, agua y jabón.

Después de cada uso, limpie la superficie de los respectivos elementos del quemador una vez que se haya enfriado. Si se dejan restos (alimentos recocidos, gotas de grasa, etc.), por poco que sea, se incrustarán en la superficie y serán luego más difíciles de eliminar. Es necesario que los agujeros y ranuras estén limpios para que la llama sea correcta.

El movimiento de algunos recipientes puede dejar restos metálicos sobre las parrillas.

Limpie los quemadores y las parrillas con agua jabonosa y frótelos con un cepillo no metálico.

Si las parrillas disponen de tacos de goma, tenga cuidado al limpiarlas. Los tacos pueden soltarse y la parrilla puede rayar la placa de cocción.

Seque completamente los quemadores y las parrillas siempre. La presencia de gotas de agua o zonas húmedas al comienzo de la cocción puede deteriorar el esmalte.

Después de la limpieza y secado de los quemadores, asegúrese de que las tapas estén bien colocadas sobre el difusor.

### ¡Atención!

- No extraiga los mandos para la limpieza del aparato. Si la humedad penetra en el aparato puede dañarlo.
- No utilice máquinas de limpieza a vapor. Podría dañar la placa de cocción.
- Si la placa de cocción posee un panel de cristal o de aluminio, no utilice un cuchillo, rasqueta o similar para limpiar la unión con el metal.

### Mantenimiento

Limpie al instante los líquidos que se derramen. Así evitará que los restos de comida se peguen y se ahorrará esfuerzos innecesarios.

Debido a las altas temperaturas que soportan, el quemador wok y las zonas de acero inoxidable (grasera, contorno de los quemadores, etc.) pueden cambiar de color. Esto es normal. Después de cada uso, limpie dichas zonas con un producto apropiado para acero inoxidable.

Se recomienda utilizar regularmente el producto de limpieza disponible en nuestro Servicio Técnico con código 311499.

### ¡Atención!

El limpiador de inoxidable no se debe utilizar en la zona alrededor de los mandos. Las indicaciones (serigrafía) se pueden borrar.

No deje líquidos ácidos (zumo de limón, vinagre, etc.) sobre la placa de cocción.

## ¿Qué hacer en caso de avería?

En ocasiones, las anomalías detectadas se pueden solucionar fácilmente. Antes de llamar al Servicio Técnico tenga en cuenta los siguientes consejos:

Anomalía	Posible causa	Solución
El funcionamiento eléctrico general está averiado.	Fusible defectuoso.	Comprobar en la caja general de fusibles si el fusible está averiado y cambiarlo.
	El automático o un diferencial ha saltado.	Comprobar en el cuadro general de mando si ha saltado el automático o un diferencial.
El encendido automático no funciona.	Pueden existir residuos de alimentos o de limpieza entre las bujías y los quemadores.	El espacio entre la bujía y el quemador debe estar limpio.
	Los quemadores están mojados.	Secar cuidadosamente las tapas del quemador.
	Las tapas del quemador están mal colocadas.	Comprobar que las tapas están bien colocadas.
	El aparato no está conectado a tierra, está mal conectado o la toma de tierra es defectuosa.	Póngase en contacto con el instalador eléctrico.
La llama del quemador no es uniforme.	Las piezas del quemador están mal colocadas.	Colocar correctamente las piezas sobre el quemador correspondiente.
	Las ranuras del quemador están sucias.	Limpia las ranuras del quemador.
El flujo de gas no parece normal o no sale gas.	El paso de gas está cerrado por llaves intermedias.	Abrir las posibles llaves intermedias.
	Si el gas proviene de una bombona, comprobar que no está vacía.	Cambiar la bombona.

Anomalía	Posible causa	Solución
Hay olor a gas en la cocina.	Algún grifo está abierto.	Cerrar los grifos.
	Mal acoplamiento de la bombona.	Comprobar que el acoplamiento es perfecto.
	Posible fuga de gas.	Cerrar la llave general de gas, ventilar el recinto y avisar inmediatamente a un técnico de instalación autorizado para la revisión y certificación de la instalación. No utilizar el aparato hasta asegurarse de que no existe ninguna fuga de gas en la instalación o el aparato.
El quemador se apaga inmediatamente después de soltar el mando.	No ha mantenido el mando presionado el tiempo suficiente.	Una vez encendido el quemador, mantener el mando presionado unos segundos más.
	Las ranuras del quemador están sucias.	Limpia las ranuras del quemador.

## Servicio de Asistencia Técnica

Si se solicita nuestro Servicio Técnico, se debe facilitar el número de producto (E-Nr.) y el número de fabricación (FD) del aparato. Esta información figura en la placa de características, situada en la parte inferior de la placa de cocción, y en la etiqueta del manual de uso.

Los datos de contacto del Servicio de Asistencia Técnica de cada país se encuentran en el listado adjunto.

### Condiciones de garantía

Si, contrariamente a nuestras expectativas, el aparato presentara algún daño o no cumpliera con sus exigencias de calidad previstas, le rogamos nos lo haga saber lo antes posible. Para que la garantía tenga validez, el aparato no deberá haber sido manipulado, ni sometido a un mal uso.

Las condiciones de garantía aplicables son las establecidas por la representación de nuestra empresa en el país donde se haya efectuado la compra. Puede solicitarse información detallada en los puntos de venta. Es necesario presentar el justificante de compra para hacer uso de la garantía.

Reservado el derecho de modificaciones.

## Protección del medio ambiente

Si en la placa de características del aparato aparece el símbolo , tenga en cuenta las siguientes indicaciones.

### Eliminación de residuos respetuosa con el medio ambiente



Eliminar el embalaje de forma ecológica.



Este aparato está marcado con el símbolo de cumplimiento con la Directiva Europea 2012/19/UE relativa a los aparatos eléctricos y electrónicos usados (Residuos de aparatos eléctricos y electrónicos RAEE).

La directiva proporciona el marco general válido en todo el ámbito de la Unión Europea para la retirada y la reutilización de los residuos de los aparatos eléctricos y electrónicos.

El embalaje de su aparato se ha fabricado con los materiales estrictamente necesarios para garantizar una protección eficaz durante el transporte. Estos materiales son totalmente reciclables, reduciendo así el impacto medioambiental. Le invitamos a contribuir también en la conservación del medio ambiente, siguiendo los siguientes consejos:

- deposite el embalaje en el contenedor de reciclaje adecuado,
- antes de deshacerse de un aparato desechado, inutilícelo. Consulte en su administración local la dirección del centro recolector de materiales reciclables más próximo y entregue allí su aparato,
- no tire el aceite usado por el fregadero. Guárdelo en un recipiente cerrado y entréguelo en un punto de recogida o, en su defecto, en un contenedor de basura (acabará en un vertedero controlado; probablemente no es la mejor solución, pero evitamos la contaminación del agua).



# Table des matières

	<b>Utilisation conforme</b> .....	26
	<b>Précautions de sécurité importantes</b> .....	27
	<b>Consignes générales</b> .....	28
	Information technique .....	28
	IMPORTANT .....	28
	<b>Présentation de l'appareil</b> .....	29
	Éléments de commande et brûleurs .....	29
	Accessoires .....	29
	<b>Brûleurs à gaz</b> .....	30
	Mise sous tension manuelle .....	30
	Allumage automatique .....	30
	Système de sécurité .....	30
	Éteindre un brûleur .....	30
	Interrupteur principal / Blocage de la plaque de cuisson (Main Switch) .....	31
	Avertissements .....	31
	<b>Tableaux et conseils</b> .....	31
	Récipients appropriés .....	31
	Conseils d'utilisation .....	31
	Tableau de cuisson .....	32
	<b>Nettoyage et maintenance</b> .....	35
	Nettoyage .....	35
	Maintenance .....	35
	<b>Anomalies, que faire ?</b> .....	35
	<b>Service après-vente</b> .....	36
	Conditions de garantie .....	36
	<b>Protection de l'environnement</b> .....	36
	Élimination écologique .....	36

Vous trouverez des informations supplémentaires concernant les produits, accessoires, pièces de rechange et services sur Internet sous : **www.bosch-home.com** et la boutique en ligne : **www.bosch-eshop.com**

## Utilisation conforme

Lisez attentivement ces instructions. Ce n'est qu'à cette condition que vous pourrez utiliser votre appareil efficacement et en toute sécurité. Conservez la notice d'utilisation et d'installation, et remettez-la avec l'appareil si celui-ci change de propriétaire.

**Le fabricant est exempt de toute responsabilité si les instructions de cette notice ne sont pas respectées.**

Les images de cette notice sont proposées à titre indicatif.

Ne retirez l'appareil de son emballage protecteur qu'au moment de son encastrement. Si vous constatez des dommages sur l'appareil, ne le branchez pas. Contactez notre Service Technique.

Cet appareil correspond à la classe 3, selon la norme EN 30-1-1 pour les appareils à gaz : appareil encastré dans un meuble.

Assurez-vous que l'installation de votre plaque de cuisson est réalisée dans le respect de la notice de montage.

Cet appareil ne peut pas être installé dans des yachts ou des caravanes.

Cet appareil doit être utilisé uniquement dans des endroits suffisamment ventilés.

Cet appareil n'est pas conçu pour un fonctionnement avec une minuterie externe ou une commande à distance.

**Tous les travaux d'installation, de branchement, de réglage et d'adaptation à un autre type de gaz doivent être réalisés par un technicien agréé qui doit respecter les normes et la législation applicables, ainsi que les prescriptions des sociétés locales de distribution d'électricité et de gaz. Les dispositions applicables quant à la ventilation seront attentivement respectées.**

En sortie d'usine, cet appareil est adapté au type de gaz indiqué sur la plaque signalétique. S'il était nécessaire de le changer, veuillez consulter la notice de montage. Il est recommandé de faire appel à notre service technique pour l'adaptation à un autre type de gaz.

Cet appareil a été conçu pour une utilisation domestique ; son utilisation à titre commercial



ou professionnel est interdite. N'utilisez l'appareil que pour cuisiner, jamais comme chauffage. La garantie ne sera valable que si l'utilisation pour laquelle il a été conçu a été respectée.

Cet appareil est conçu pour une utilisation jusqu'à une altitude maximale de 2 000 m.

N'utilisez pas de couvercles ou de barrières de protection pour enfants non recommandés par le fabricant de la plaque de cuisson. Ils peuvent provoquer des accidents, notamment en raison de la surchauffe, de la combustion ou du décollement de fragments de matériaux.

Cet appareil peut être utilisé par des enfants de 8 ans ou plus et par des personnes dotées de capacités physiques, sensorielles ou mentales réduites ou disposant de connaissances ou d'expérience insuffisantes, sous la surveillance d'un tiers responsable de leur sécurité ou bien lorsqu'ils ont reçu des instructions liées à l'utilisation de l'appareil en toute sécurité et qu'ils ont intégré les risques qui en résultent.

Les enfants ne doivent pas jouer avec l'appareil. Le nettoyage et l'entretien effectué par l'utilisateur ne doivent pas être accomplis par des enfants, sauf s'ils sont âgés de 15 ans et plus et qu'un adulte les surveille.

Les enfants de moins de 8 ans doivent être tenus à distance de l'appareil et du cordon d'alimentation.

## Précautions de sécurité importantes

### Mise en garde – Risque de déflagration !

L'accumulation de gaz non brûlés dans un lieu fermé pourrait comporter un risque de déflagration. Ne placez pas l'appareil dans des courants d'air. Les brûleurs pourraient s'éteindre. Lisez attentivement les instructions et les avertissements concernant le fonctionnement des brûleurs à gaz.

### Mise en garde – Risque d'intoxication !

L'utilisation d'un appareil de cuisson à gaz produit de la chaleur, de l'humidité et émet des produits de combustion dans la pièce où il est installé. Assurez-vous que la cuisine soit bien ventilée, en particulier lorsque la plaque de cuisson est en fonctionnement: laissez les orifices de ventilation naturelle ouverts ou installez un dispositif de ventilation mécanique (hotte aspirante). Lorsque l'utilisation de l'appareil est intense et prolongée, une ventilation complémentaire ou plus efficace peut être nécessaire: ouvrez une fenêtre ou augmentez la puissance de la ventilation mécanique.

### Mise en garde – Risque de brûlures !

- Les zones de cuisson et les zones adjacentes chauffent fortement. Ne touchez pas les surfaces chaudes. Ne laissez pas les enfants de moins de 8 ans s'approcher.
- Si la bouteille de gaz liquide n'est pas à la verticale, du propane/butane liquide peut parvenir dans l'appareil. Des jets de flamme violents peuvent alors sortir aux brûleurs. Des composants peuvent être endommagés et devenir non étanches avec le temps, si bien que du gaz sort de manière incontrôlée. Les deux peuvent conduire à des brûlures. Utiliser les bouteilles de gaz liquide toujours en position verticale.

### Mise en garde – Risque d'incendie !

- Le processus de cuisson doit être effectué sous surveillance. Un processus de cuisson court doit être surveillé sans interruption.
- Les zones de cuisson chauffent fortement. Ne posez pas d'objets inflammables sur la plaque de cuisson. N'entrez pas d'objets sur la plaque de cuisson.
- Ne stockez ni utilisez de produits chimiques corrosifs, de vapeurs, de matériels inflammables ni de produits non alimentaires sous cet appareil, ni à proximité.

- Les graisses et les huiles surchauffées s'enflamment facilement. Ne vous absentez pas si vous avez mis de la graisse ou de l'huile à chauffer. Si elles s'enflamment, n'éteignez pas le feu avec de l'eau. Couvrez le récipient avec un couvercle hermétique pour étouffer le feu puis éteignez la zone de cuisson.

### **Mise en garde – Risque de blessures !**

- Les récipients qui présenteraient des dommages, dont la taille ne serait pas adaptée, qui dépasseraient de la plaque de cuisson ou qui seraient mal placés, pourraient occasionner des lésions graves. Respectez les conseils et les avertissements concernant les récipients de cuisson.

- Les réparations inexpertes sont dangereuses. Seul un technicien du service après-vente formé par nos soins est habilité à effectuer des réparations et à remplacer des câbles électriques ou conduites de gaz défectueux. Si l'appareil est défectueux, retirer la fiche secteur ou déconnecter le fusible dans le boîtier à fusibles, fermer l'arrivée de gaz. Appeler le service après-vente.
- S'il n'est pas possible de tourner un bouton de commande ou si celui-ci est mal fixé, il ne doit plus être utilisé. Contactez immédiatement le service après-vente afin de faire réparer ou remplacer le bouton de commande.

### **Mise en garde – Risque de décharge électrique !**

Ne pas utiliser de machines de nettoyage à vapeur pour nettoyer l'appareil.

## **Consignes générales**

### Information technique

		Brûleur éco	Brûleur standard	Brûleur puissant	Brûleur wok	Double brûleur wok
Capacité thermique	GAZ DE VILLE	1,00 kW	1,75 kW	3,00 kW	4,00 kW	5,00 kW
	GPL					4,60 kW
Modèle PCP6A5B90V		1	2	1	-	-
Modèle PCQ7A5B90V		1	2	1	1	-
Modèle PCQ7A5M90V		1	2	1	1	-
Modèle PCS7A5M90V		1	2	1	-	1
Modèle PCR9A5M90V		1	2	1	-	1
Options de réglage	GAZ DE VILLE G20/17,6 - 19,6 mbar; 1,76 - 1,96 kPa					
	GPL G30/27,5 mbar; 2,75 kPa					
Caractéristiques électriques	110 - 240 V~ 50/60 Hz					

REMARQUE : Ce produit fonctionne au GPL. Si vous souhaitez utiliser le produit avec du gaz de ville, contactez notre centre de service.

### IMPORTANT

- Placez les grilles et les brûleurs conformément aux schémas de description du modèle.
- Laissez les zones autour de l'appareil libres de tout matériel combustible, essence et autres vapeurs ou liquides inflammables.
- N'utilisez pas de réchauffeur d'air, celui-ci étant dangereux.

### POUR VOTRE SÉCURITÉ

#### EN CAS D'ODEUR DE GAZ :

- OUVREZ LES FENÊTRES
- NE TOUCHEZ PAS LES INTERRUPTEURS ÉLECTRIQUES
- ÉTEIGNEZ TOUTES LES FLAMMES EN FERMANT LA SOUPE GÉNÉRALE D'ADMISSION
- CONTACTEZ IMMÉDIATEMENT LE CENTRE DE FUITES OU VOTRE COMPAGNIE DE GAZ

### POUR VOTRE SÉCURITÉ

- NE STOCKEZ PAS D'ESSENCE OU D'AUTRES LIQUIDES INFLAMMABLES À PROXIMITÉ DE VOTRE APPAREIL
- INSTALLEZ VOTRE APPAREIL CONFORMÉMENT AUX INSTRUCTIONS D'ENCASTREMENT AFIN D'ÉVITER D'ENDOMMAGER VOS MEUBLES AVEC LA TEMPÉRATURE

## Présentation de l'appareil

Sur la vue d'ensemble des modèles, vous retrouverez votre appareil avec les puissances des brûleurs.

→ Page 2

### Éléments de commande et brûleurs

Le brûleur correspondant est indiqué sur chaque manette de commande. Les boutons de commande vous permettent de régler les puissances requises entre les valeurs maximales et minimales selon les différentes positions. Ne tentez jamais de passer directement de la position 0 à la position 1 ou de la position 1 à la position 0.

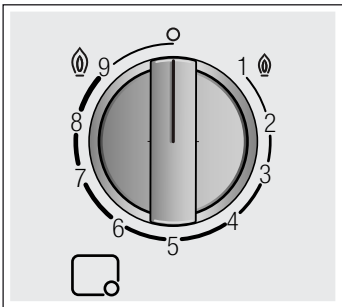

#### Affichages

	Brûleur commandé par la manette de commande
	Brûleur désactivé
	Puissance de chauffe la plus élevée et allumage électrique
	Puissance de chauffe la plus faible

Les flammes intérieures et extérieures du brûleur à double flamme peuvent être régulées indépendamment les unes des autres. Les niveaux de puissance possibles sont :

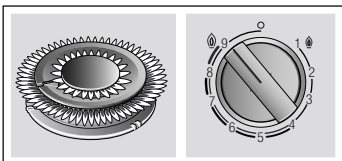

Flammes extérieures et intérieures à la puissance maximale.

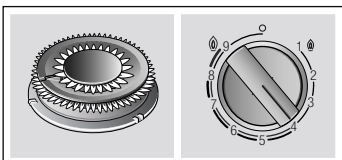

Flammes extérieures à la puissance minimale, flammes intérieures à la puissance maximale.

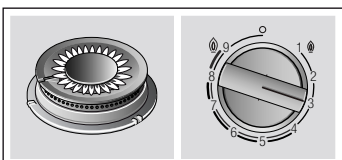

Flammes intérieures à la puissance maximale.

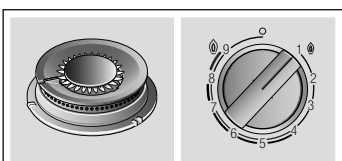

Flammes intérieures à la puissance minimale.

Pour un fonctionnement correct de l'appareil, il est indispensable de s'assurer que les grilles et toutes les pièces des brûleurs sont correctement mises en place. N'intervertissez pas les couvercles des brûleurs.

Retirez toujours les grilles avec précaution. Le déplacement d'une grille peut par ailleurs déplacer les grilles attenantes.

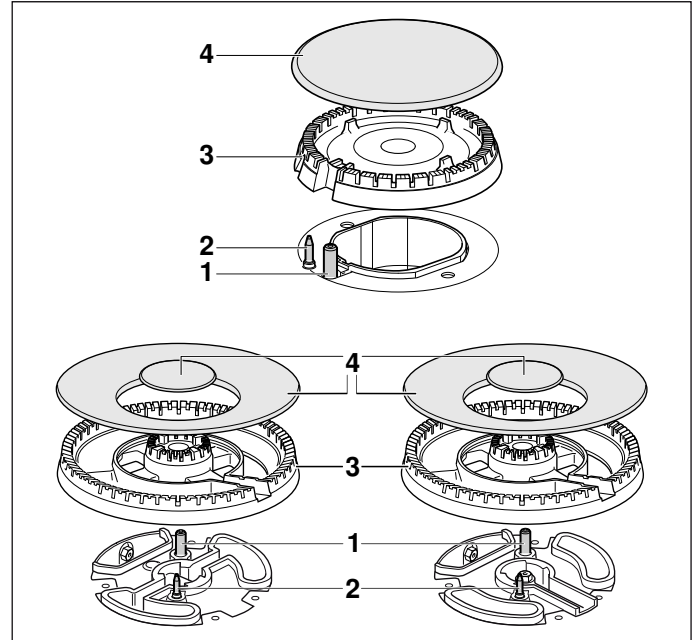

#### Éléments

1	Bougie d'allumage
2	Thermocouple
3	Corps du brûleur
4	Chapeau du brûleur

### Accessoires

Selon le modèle, la plaque de cuisson peut inclure les accessoires suivants. Ceux-ci peuvent également être achetés auprès du Service Technique.

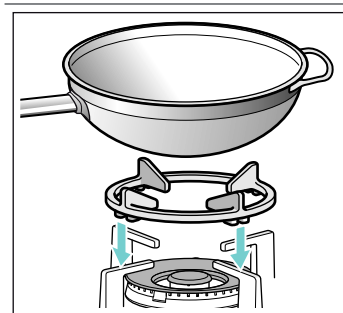

#### Grille wok supplémentaire

Uniquement appropriée pour l'utilisation sur des brûleurs wok. Utilisez des ustensiles de cuisson à fond bombé. Afin de prolonger la durée de vie de l'appareil, l'utilisation d'une grille wok supplémentaire est recommandée.

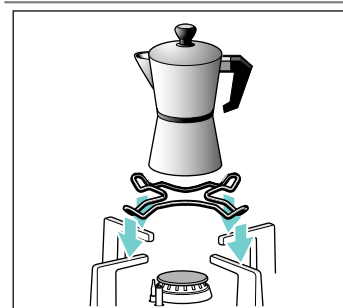

#### Grille supplémentaire pour cafetière Espresso

Uniquement appropriée pour l'utilisation sur le plus petit brûleur. Utilisez des ustensiles de cuisson d'un diamètre inférieur à 12 cm.

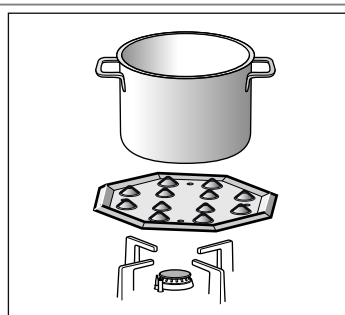

#### Plaque de cuisson à feu doux

Cette pièce d'accessoire est uniquement appropriée pour la cuisson basse température. Elle peut être utilisée avec le brûleur éco ou le brûleur standard. Si votre table de cuisson est dotée de plusieurs brûleurs standards, il est recommandé de placer la plaque de cuisson à feu doux sur le brûleur standard arrière ou avant droit.

Placez la pièce d'accessoire avec les renflements vers le haut sur le support, jamais directement sur le brûleur.

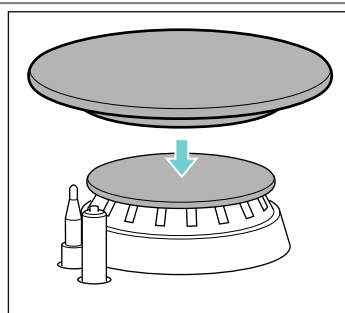

#### Simmer Cap

Utilisez exclusivement le couvercle pour cuisiner à une puissance minimale. Placez le Simmer Cap sur le cache du brûleur éco. Placez le récipient sur la grille, jamais directement sur le Simmer Cap.

#### Code

HEZ298107 Grille wok supplémentaire : fonte (4-5 kW)

HEZ298110 Grille wok supplémentaire : acier émaillé

HEZ298115 Grille supplémentaire pour cafetière Espresso

HEZ298105 Plaque de cuisson à feu doux

HEZ211310 Simmer Cap

Le fabricant décline toute responsabilité si ces accessoires ne sont pas utilisés ou sont employés de manière incorrecte.

## Brûleurs à gaz

### Mise sous tension manuelle

1. Appuyez sur la manette de commande du brûleur sélectionné, puis tournez-la vers la gauche jusqu'à la puissance de chauffe la plus élevée.
2. Approchez un allumeur ou une flamme (briquet, allumette, etc.) du brûleur.

### Allumage automatique

Si la table de cuisson dispose d'un allumage automatique (bougies d'allumage) :

1. Appuyez sur le bouton de commande du brûleur sélectionné, puis tournez-le vers la gauche jusqu'à la puissance de chauffe la plus élevée. Tant que le bouton de commande est maintenu enfoncé, tous les brûleurs génèrent une étincelle. La flamme s'enflamme. Patientez quelques secondes.
2. Relâchez le bouton de commande.
3. Tournez le bouton de commande dans la position souhaitée.

Si aucun allumage ne se produit, éteignez le brûleur et répétez les étapes précédemment décrites. Cette fois, maintenez enfoncé le bouton de commande plus longtemps (jusqu'à 10 secondes).

#### **⚠ Mise en garde – Risque de déflagration !**

Si la flamme ne s'allume pas après 15 secondes, éteignez le brûleur et ouvrez la porte ou la fenêtre de la pièce. Patientez au moins une minute avant d'allumer de nouveau le brûleur.

**Remarque :** Veillez à une propreté maximale. Si les bougies d'allumage sont encrassées, cela peut entraîner un allumage défectueux. Nettoyez régulièrement les bougies d'allumage avec une petite brosse non métallique. Veillez à ne pas soumettre les bougies d'allumage à des chocs importants.

### Système de sécurité

Votre plaque de cuisson dispose d'un système de sécurité (thermocouple) qui empêche le passage de gaz si les brûleurs s'éteignent accidentellement.

Pour que cet dispositif soit actif :

1. Allumez le brûleur normalement.
2. Maintenez le bouton de commande enfoncé sans le lâcher pendant 4 secondes après l'allumage de la flamme.

### Éteindre un brûleur

Tournez le bouton de commande correspondant vers la droite jusqu'à la position 0.

Quelques secondes après avoir éteint le brûleur, un son est émis (coup sec). Il ne s'agit pas d'une anomalie, ceci signifie que la sécurité a été désactivée.

## Interrupteur principal / Blocage de la plaque de cuisson (Main Switch)

La plaque de cuisson peut disposer d'un interrupteur principal qui coupe le passage du gaz général et qui éteint tous les brûleurs en même temps. Cet interrupteur est très pratique si vous avez des enfants à la maison ou si, pour une raison, vous devez éteindre rapidement tous les brûleurs.

### Pour bloquer la plaque de cuisson :

Appuyez sur l'interrupteur principal.

Tous les brûleurs qui sont allumés s'éteignent. La plaque de cuisson se bloque.

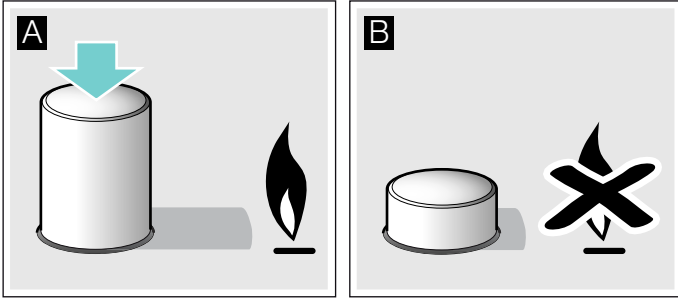

### Pour débloquer la plaque de cuisson :

1. Placez tous les boutons de commande sur la position d'arrêt.
2. Enfoncez et tournez l'interrupteur principal dans le sens des aiguilles d'une montre jusqu'à la butée.

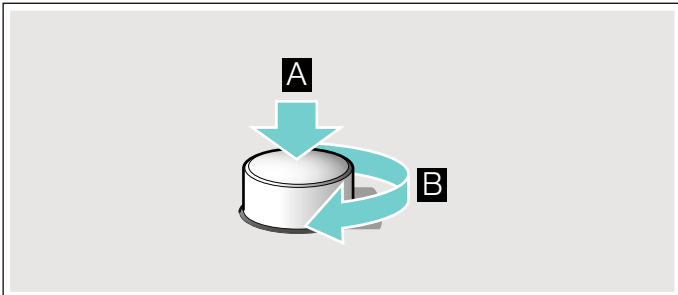

Le passage de gaz général est ouvert. Vous pouvez alors utiliser normalement votre plaque de cuisson.

## Avertissements

Pendant le fonctionnement du brûleur, il est normal d'entendre un léger sifflement.

Lors des premières utilisations, il est normal que des odeurs se dégagent. Mais cela ne suppose aucun dysfonctionnement. Ces odeurs disparaîtront petit à petit.

Une flamme de couleur orange est normale. Ceci est dû à la présence de poussière dans l'atmosphère, de liquides déversés, etc.

S'il se produit une extinction accidentelle des flammes du brûleur, éteignez le bouton de commande du brûleur et attendez au moins 1 minute avant de le rallumer.

## Tableaux et conseils

### Récipients appropriés

Brûleurs	Diamètre minimum du fond du récipient	Diamètre maximum du fond du récipient
Brûleur wok	22 cm	30 cm
Brûleur puissant	20 cm	26 cm
Brûleur standard	14 cm	22 cm
Brûleur éco	12 cm	16 cm

Le récipient ne doit pas dépasser le bord du foyer.

### Conseils d'utilisation

**Remarque :** En cas d'utilisation avec certaines poêles ou casseroles, une légère déformation passagère de la surface de cuisson en acier peut se produire. C'est normal et cela ne nuit pas au bon fonctionnement de l'appareil.

Les recommandations suivantes vous aident à économiser de l'énergie et vous empêchent d'endommager les ustensiles :

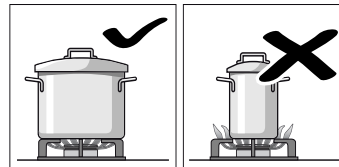

Utilisez des récipients de la taille appropriée à chaque brûleur.

N'utilisez pas de petits récipients sur les grands brûleurs. La flamme ne doit pas toucher les côtés du récipient.

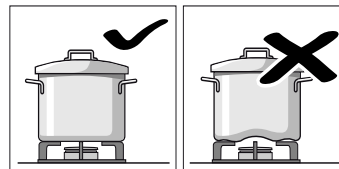

N'utilisez pas de récipients déformés, ayant tendance à être instables sur la plaque de cuisson. Les récipients pourraient se renverser. N'utilisez que des récipients à base plane et épaisse.

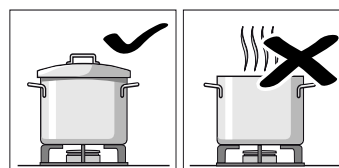

Ne cuisinez pas sans couvercle ni avec celui-ci mal mis. Vous risqueriez ainsi de perdre une partie de l'énergie.

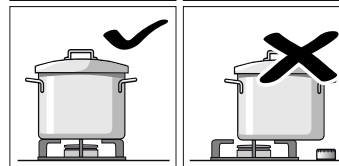

Placez le récipient bien au centre du brûleur. Dans le cas contraire, il risque de se renverser.

Ne placez pas les récipients de grande taille sur les brûleurs situés près du boutons de commandes. Ils risqueraient d'être endommagés en raison de l'excès de chaleur.



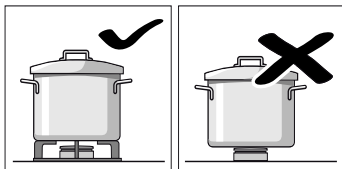

Placez les récipients sur les grilles, jamais directement sur le brûleur. Vérifiez que les grilles et les couvercles des brûleurs sont bien placés avant de les utiliser.

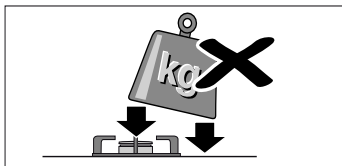

Manipulez soigneusement les récipients sur la plaque de cuisson. Ne cognez pas la plaque de cuisson et n'y posez pas d'objets lourds.

## Tableau de cuisson

Le tableau suivant répertorie les positions de chauffe et les temps de cuisson de différents plats. Les indications sont des valeurs de référence pour quatre portions.

Les temps de cuisson et les positions de chauffe dépendent du type, du poids et de la qualité des aliments, du type de gaz utilisé, ainsi que du matériau du récipient. Pour la préparation de ces plats, un ustensile de cuisson en acier inoxydable a principalement été utilisé.

Utilisez toujours un ustensile approprié et positionnez-le au centre du brûleur. Vous trouverez des informations sur le diamètre de l'ustensile sous. → "Récipients appropriés"

### Informations sur le tableau

La préparation de chaque plat se compose d'une ou de deux étapes. Chaque étape présente des informations sur ce qui suit :

- Mode de cuisson
- Position de chauffe
- Durée en minutes

### Modes de cuisson répertoriés dans le tableau

- Porter à ébullition
- Poursuivre la cuisson
- Faire monter la pression dans la cocotte minute
- Maintenir la pression dans la cocotte minute
- Saisir fortement
- Faire rissoler
- Faire fondre, fondre
- \* Sans couvercle
- \*\* Remuer constamment

**Remarque :** Les symboles n'apparaissent pas sur l'appareil. Ils servent d'orientation pour les différents modes de cuisson.

Le tableau présente des indications pour la préparation de plats sur différents brûleurs. L'option recommandée est le premier brûleur mentionné. Tous les brûleurs de la table de cuisson sont décrits dans la vue d'ensemble des modèles. → Page 2

Exemple :

Plat	Durée totale en min.	Étape 1			Étape 2		
<b>Brûleurs</b>							

### Soupes, soupes crémeuses

Soupe au poisson

Brûleur puissant	12-17		8	7-9		1	5-8
Brûleur standard	17-22		8	11-13		1	6-9
Brûleur wok	10-15		9	6-8		4	4-7

Cet exemple montre la préparation de soupe de poisson avec le brûleur puissant, le brûleur standard et le brûleur pour wok.

Avec le brûleur puissant (option recommandée) le temps de cuisson total se situe entre 12 de 17 minutes.

- Étape 1 : porter à ébullition. Régler la position de chauffe 8 pendant 7 à 9 minutes.
- Étape 2 : continuer la cuisson. Passer à la position de chauffe 1 pendant 5 à 8 minutes.

Ces indications sont également valables pour les autres brûleurs proposés.

Plat	Durée totale en min.	Étape 1			Étape 2		
<b>Brûleurs</b>							

### Soupes, soupes crémeuses

Soupe au poisson

Brûleur puissant	12-17		8	7-9		1	5-8
Brûleur standard	17-22		8	11-13		1	6-9
Brûleur wok	10-15		9	6-8		4	4-7

Crème de potiron, bortsch (soupe de betterave)

Brûleur puissant	30-35		9	10-12		5	20-23
Brûleur standard	45-50		9	15-17		6	30-33
Brûleur wok	25-30		9	8-10		2	17-20

Minestrone (soupe de légumes)

Brûleur puissant	47-52		9	10-12		5	37-40
Brûleur standard	57-62		9	10-12		6	47-50
Brûleur wok	43-48		8	8-10		3	35-38

### Pâtes et riz

Spaghettis

Brûleur puissant	18-22		9*	8-10		6	10-12
Brûleur standard	20-24		9*	10-12		7	10-12
Brûleur wok	18-22		8*	8-10		6	10-12

Riz

Brûleur puissant	17-22		9	5-7		2	12-15
Brûleur standard	18-23		9	7-9		6	11-14
Brûleur wok	15-20		8	4-6		2	11-14

Ravioli







Brûleur puissant	9-14		9	4-6		6	5-8
Brûleur standard	17-22		8	12-14		8	5-8









Plat Brûleurs	Durée totale en min.	Étape 1			Étape 2		
							
Brûleur wok	10-15		8	5-7		8	5-8

### Légumes et légumes secs







Pommes de terre cuites (purée, salade de pommes de terre)

Brûleur puissant	23-28		9	8-10		5	15-18
Brûleur standard	25-30		9	10-12		6	15-18
Brûleur wok	25-30		7	11-13		5	14-17

Hummus (purée de pois chiches)

Brûleur puissant	50-55		9	10-12		4	40-43
Brûleur standard	52-57		9	12-14		5	40-43
Brûleur wok	47-52		7	10-12		5	37-40

Lentilles

Brûleur puissant	40-45		9	8-10		8	32-35
Brûleur standard	50-55		9	18-20		6	32-35
Brûleur wok	45-50		6	20-22		4	25-28

Légumes frits

Brûleur puissant	12-17		7	6-8		6	6-9
Brûleur standard	15-20		8	8-10		7	7-10
Double brûleur wok	10-15		7	5-7		5	5-8

Légumes frais sautés\*\*







Brûleur wok	6-8		9	6-8			
Brûleur puissant	6-8		9	6-8			

Frites



Brûleur wok	15-20		7	15-20			
Brûleur puissant	15-20		9	15-20			
Brûleur standard	25-30		9	25-30			

œufs

Shakshuka

Brûleur standard	15-20		9	10-12		4	5-8
Brûleur puissant	13-18		8	7-9		3	6-9
Double brûleur wok	15-20		6	11-13		4	4-7

Omelette (1 port.)

Brûleur standard	3-5		8	3-5			
Brûleur puissant	2-4		9	2-4			
Brûleur wok	2-4		5	2-4			











Tortilla espagnole

Brûleur puissant	25-30		9	25-30			
Brûleur wok	18-23		9	18-23			
Double brûleur wok	25-30		7	25-30			

Sauces

Sauce béchamel\*\*



Brûleur éco	10-15		6	2-4		6	8-11
-------------	-------	---	---	-----	---	---	------

Plat Brûleurs	Durée totale en min.	Étape 1			Étape 2		
							
Brûleur standard	10-15		5	2-4		5	8-11
Brûleur wok	3-8		5	1-2		5	2-6





Sauce avec bleu\*\*

Brûleur éco	4-6		7	4-6			
Brûleur standard	3-5		7	3-5			
Brûleur puissant	3-5		5	3-5			

Sauce napolitaine



Brûleur standard	18-23		6	2-4		4	16-19
Brûleur wok	13-18		7	1-3		5	12-15
Brûleur puissant	15-20		8	1-3		6	14-17

Sauce carbonara







Brûleur standard	10-15		6	5-7		3	5-8
Brûleur puissant	8-13		5	4-6		3	4-7
Brûleur éco	10-15		9	5-7		5	5-8

Poisson



Merlan à la romaine

Brûleur puissant	5-10		8	5-10			
Brûleur standard	8-13		9	8-13			
Brûleur wok	4-9		6	4-9			

Saumon cuit

Brûleur puissant	5-10		7	2-4		1	3-6
Double brûleur wok	5-10		6	2-4		1	3-6
Brûleur wok	7-12		8	2-4		1	5-8

Moules



Brûleur puissant	5-7		9	5-7			
Brûleur wok	4-6		9	4-6			
Brûleur standard	10-12		9	10-12			

Viandes





Magret de canard (1 pièce)

Brûleur standard	6-8		7	6-8			
Brûleur puissant	9-11		7	9-11			
Brûleur wok	6-8		5	6-8			

Filet de bœuf Stroganoff

Brûleur puissant	8-13		9	8-13			
Brûleur wok	5-10		8	5-10			
Brûleur standard	12-17		9	12-17			

Blancs de poulet (8 filets de poulet)

Brûleur puissant	7-12		9	2-4		6	5-8
Brûleur wok	7-12		9	2-4		6	5-8
Brûleur standard	7-12		9	7-12			

Viande hâchée (tourte à la viande, boulettes de viande, sauce bolognaise)

Brûleur puissant	15-20		8	15-20			
------------------	-------	---	---	-------	--	--	--

Plat Brûleurs	Durée totale en min.	Étape 1			Étape 2		
							
Brûleur standard	20-25	 *	9	20-25			
Brûleur wok	15-20	 *	6	15-20			



### Plats cuisinés

Croquettes surgelées (16 pièces)



Bâtonnets de poisson surgelés (12 pièces)

Brûleur puissant	6-10		8	6-10			
Brûleur wok	5-9		8	5-9			
Brûleur standard	8-12		8	8-12			







Saucisses à griller (12 pièces)

Brûleur puissant	5-10		9	1-3		7	4-7
Brûleur standard	7-12		9	7-12			
Brûleur wok	5-10		9	1-3		7	4-7

Saucisses (12 pièces)

Brûleur standard	8-13		9	8-13			
Brûleur wok	9-14		4	9-14			
Brûleur puissant	7-12		7	7-12			



Hamburger (4 pièces)

Brûleur puissant	4-9		9	1-3		7	3-6
Brûleur wok	4-9		9	1-3		7	3-6
Brûleur standard	5-10		9	1-3		8	4-7

Légumes congelés\*\*







Brûleur puissant	7-12		9	7-12			
Brûleur wok	5-10		9	5-10			
Brûleur standard	12-17		9	12-17			

Pizza (diamètre 20 cm)

Brûleur wok	4-8		1	4-8			
Brûleur puissant	16-20		1	16-20			
Brûleur standard	20-25		1	20-25			

### Desserts

Riz au lait\*\*

Brûleur standard	30-35		8	9-11		4	21-24
Brûleur éco	40-45		9	12-14		2	28-31
Brûleur wok	35-40		7	11-13		1	24-27





Chocolat au lait















Brûleur éco	10-14		1	10-14			
Brûleur standard	16-20		1	16-20			

Crêpes (4 pièces)

Brûleur puissant	17-22		7	1-3		5	16-19
Brûleur wok	8-13		7	1-3		4	7-10
Double brûleur wok	9-14		5	1-3		4	8-11

Pudding de pain

Brûleur puissant	25-30		9	10-12		6	15-18
Brûleur wok	23-28		9	8-10		7	15-18

Plat Brûleurs	Durée totale en min.	Étape 1			Étape 2		
							
Brûleur standard	27-32		9	10-12		7	17-20
Flan espagnol**							
Brûleur puissant	3-8		5	3-8			
Brûleur standard	8-13		5	8-13			
Brûleur wok	3-8		2	3-8			
Génoise (au bain-marie)							
Brûleur puissant	35-40		9	35-40			
Brûleur wok	40-45		9	40-45			
Brûleur standard	45-50		9	45-50			

### Conseils de cuisson

- Utilisez une cocotte minute pour préparer les soupes et les légumes secs. Le temps de cuisson est ainsi considérablement réduit. Si vous utilisez une cocotte minute, suivez les instructions du fabricant. Ajoutez tous les ingrédients en même temps dès le début.
- Utilisez toujours un couvercle pour cuire les pommes de terre et le riz. Le temps de cuisson est ainsi considérablement réduit. L'eau ne doit pas bouillir avant d'ajouter les pâtes, le riz ou les pommes de terre. Adaptez la position de chauffe pour poursuivre la cuisson.
- Pour les plats préparés à la poêle, réchauffez d'abord cette dernière avec de l'huile. Dès que vous commencez à faire frire vos aliments, maintenez la température et ajustant si besoin la position de chauffe. Si vous préparez plusieurs portions, patientez jusqu'à ce que la température soit de nouveau atteinte. Retournez régulièrement les aliments.
- Si vous préparez des soupes, des crèmes, des lentilles ou des pois chiches, ajoutez tous les ingrédients en même temps dans l'ustensile de cuisson.

## Nettoyage et maintenance

### Nettoyage

Quand l'appareil a refroidi, nettoyez-le avec une éponge, de l'eau et du savon.

Après chaque utilisation, nettoyez la surface des différents éléments du brûleur quand il a refroidi. Si des restes sont laissés (aliments recuits, gouttes de graisse, etc.), même infimes, ils s'incrusteront dans la surface et seront plus difficiles à éliminer par la suite. Les trous et les rainures doivent être propres afin que la flamme soit optimale.

Le frottement de certains récipients peut laisser des traces métalliques sur les grilles.

Lavez les brûleurs et les grilles à l'eau savonneuse et frottez-les à l'aide d'une brosse non métallique.

Si les grilles disposent de chevilles en caoutchouc, faites très attention en les nettoyant. Les chevilles peuvent se détacher et la grille peut rayer la plaque de cuisson.

Séchez toujours complètement les brûleurs et les grilles. La présence de gouttes d'eau ou de zones humides au début de la cuisson peut détériorer l'émail.

Après le nettoyage et le séchage des brûleurs, assurez-vous que les couvercles sont bien placés sur le diffuseur.

### Attention !

- Ne retirez pas les éléments de commande pour nettoyer l'appareil. Si de l'humidité pénètre dans l'appareil, cela risque de l'endommager.
- N'utilisez pas de machines de nettoyage à vapeur. Cela pourrait endommager la plaque de cuisson.
- Si la plaque de cuisson possède un panneau en verre ou en aluminium, n'utilisez pas de couteau, de racleur ou d'objet similaire pour nettoyer le joint avec le métal.

### Maintenance

Nettoyez immédiatement tous les liquides qui coulent. Vous éviterez ainsi que les restes d'aliment ne collent et économiserez des efforts inutiles.

En raison des hautes températures supportées, le brûleur wok et les zones en acier inoxydable (lèchefrite, pourtour des brûleurs, etc.) peuvent changer de couleur. Cela est normal. Après chaque utilisation, nettoyez ces zones avec un produit adapté à l'acier inoxydable.

Il est recommandé d'utiliser régulièrement le produit de nettoyage disponible auprès de notre service technique sous le code 311499.

### Attention !

La nettoyant d'acier inoxydable ne doit pas être utilisé dans la zone autour du bandeau de commandes. Les indications (sérigraphie) pourraient être effacées.

Ne laissez pas de liquides acides (jus de citron, vinaigre, etc.) sur la plaque de cuisson.

## Anomalies, que faire ?

Dans certains cas, les défauts survenus peuvent facilement être éliminés. Avant d'appeler le service après-vente, observez les remarques suivantes :

Anomalie	Cause probable	Solution
Le fonctionnement électrique général est en panne.	Fusible défectueux.	Vérifiez dans le boîtier de fusibles général si le fusible est en panne et remplacez-le.
	L'interrupteur magnétothermique ou un interrupteur différentiel a sauté.	Vérifiez dans le tableau de distribution électrique si l'interrupteur magnétothermique ou un interrupteur différentiel a sauté.
L'allumage automatique ne fonctionne pas.	Il peut y avoir des résidus d'aliments ou de nettoyage entre les bougies et les brûleurs.	L'espace entre la bougie et le brûleur doit être propre.
	Les brûleurs sont mouillés.	Séchez soigneusement les couvercles du brûleur.
	Les couvercles du brûleur sont mal placés.	Vérifiez que les couvercles sont bien placés.
La flamme du brûleur n'est pas uniforme.	L'appareil n'est pas raccordé à la terre, est mal raccordé à la terre, ou la prise de terre est défectueuse.	Contactez votre installateur électrique.
	Les pièces du brûleur sont mal placées.	Placez correctement les pièces sur le brûleur correspondant.
Le flux de gaz ne paraît pas normal ou aucun gaz ne sort.	Les rainures du brûleur sont sales.	Nettoyez les rainures du brûleur.
	Le passage de gaz est obstrué par des robinets intermédiaires.	Ouvrez les robinets intermédiaires éventuels.
	Si le gaz provient d'une bouteille, vérifiez qu'elle n'est pas vide.	Changez la bouteille.

Anomalie	Cause probable	Solution
Il y a une odeur de gaz dans la cuisine.	Un robinet est ouvert.	Fermez les robinets.
	Mauvais raccord de la bouteille.	Vérifiez que le raccord est parfait.
	Fuite de gaz éventuelle.	Fermez l'arrivée générale du gaz, aérez l'enceinte et prévenez immédiatement un technicien d'installation agréé afin qu'il vérifie et qu'il atteste du bon fonctionnement de l'installation. N'utilisez pas l'appareil jusqu'à ce que l'absence de fuite de gaz dans l'installation ou l'appareil ait été vérifiée.
Le brûleur s'éteint immédiatement après avoir relâché le bouton de commande.	Vous n'avez pas maintenu le bouton de commande enfoncé suffisamment longtemps.	Une fois le brûleur allumé, maintenez le bouton de commande enfoncé quelques secondes de plus.
	Les rainures du brûleur sont sales.	Nettoyez les rainures du brûleur.

## Service après-vente

Si vous faites appel à notre Service Technique, vous devez communiquer le numéro de produit (E-Nr.) ainsi que le numéro de fabrication (FD) de l'appareil. Cette information figure sur la plaque signalétique située sur la partie inférieure de la plaque de cuisson, et sur l'étiquette de la notice d'utilisation.

Pour les contacts dans les différents pays, consulter le répertoire de SAV joint.

## Conditions de garantie

Si, contrairement à nos attentes, l'appareil présente un dommage ou ne respecte pas les exigences de qualité prévues, veuillez nous l'indiquer dans les plus brefs délais. Pour que la garantie soit valide, l'appareil ne devra pas avoir été manipulé, ni soumis à une mauvaise utilisation.

Les conditions de garantie applicables sont celles établies par la représentation de notre entreprise dans le pays où l'achat a été effectué. Il est possible d'obtenir des informations détaillées dans les points de vente. Il est nécessaire de présenter le bon d'achat pour bénéficier de la garantie.

Tout droit de modification réservé.

## Protection de l'environnement

Si la plaque signalétique de l'appareil comporte le symbole , observez les remarques suivantes.

### Élimination écologique



Éliminez l'emballage en respectant l'environnement.



Cet appareil est marqué selon la directive européenne 2012/19/UE relative aux appareils électriques et électroniques usagés (waste electrical and electronic equipment - WEEE). La directive définit le cadre pour une reprise et une récupération des appareils usagés applicables dans les pays de la CE.

L'emballage de votre appareil a été fabriqué avec les matériaux indispensables pour garantir une protection efficace pendant le transport. Ces matériaux sont entièrement recyclables, ce qui réduit l'impact sur l'environnement. Nous vous encourageons à contribuer également à la préservation de l'environnement, en suivant les conseils ci-dessous :

- déposez l'emballage dans une benne de recyclage adaptée,
- avant de vous défaire d'un appareil, mettez-le hors d'état. Consultez votre administration locale pour connaître l'adresse du centre de collecte de matériels recyclables le plus près de chez vous, et apportez-le à ce site,
- ne jetez pas l'huile usagée dans l'évier. Conservez-la dans un récipient fermé et remettez-le à un point de collecte ou, le cas échéant, dans un bac approprié (qui sera remis à un déversoir contrôlé ; ce n'est probablement pas la meilleure solution, mais nous évitons ainsi de polluer l'eau).

## Inhoudsopgave

	<b>Gebruik volgens de voorschriften</b> .....	<b>37</b>
	<b>Belangrijke veiligheidsvoorschriften</b> .....	<b>38</b>
	<b>Algemene aanwijzingen</b> .....	<b>39</b>
	Technische informatie .....	39
	BELANGRIJK .....	39
	<b>Het apparaat leren kennen</b> .....	<b>40</b>
	Bedieningselementen en branders .....	40
	Toebehoren .....	40
	<b>Gasbranders</b> .....	<b>41</b>
	Met de hand inschakelen .....	41
	Automatische ontsteking .....	41
	Veiligheidssysteem .....	41
	Een brander uitdoven .....	41
	Hoofdschakelaar / Vergrendeling van de kookplaat (Main Switch) .....	42
	Waarschuwingen .....	42
	<b>Tabellen en tips</b> .....	<b>42</b>
	Geschikte pannen .....	42
	Gebruiksaanwijzingen .....	42
	Kooktabel .....	43
	<b>Reinigen en onderhouden</b> .....	<b>46</b>
	Reiniging .....	46
	Onderhoud .....	46
	<b>Wat te doen bij storingen?</b> .....	<b>46</b>
	<b>Servicedienst</b> .....	<b>47</b>
	Garantievoorwaarden .....	47
	<b>Milieubescherming</b> .....	<b>47</b>
	Milieuvriendelijk afvoeren .....	47

Meer informatie over producten, accessoires, onderdelen en diensten vindt u op het internet: [www.bosch-home.com](http://www.bosch-home.com) en in de online-shop: [www.bosch-eshop.com](http://www.bosch-eshop.com)

## Gebruik volgens de voorschriften

Lees deze instructies aandachtig. Alleen dan kunt u uw apparaat op een juiste en veilige manier gebruiken. Bewaar de gebruiks- en installatie-instructies en overhandig deze met het apparaat indien het van eigenaar wisselt.

**De fabrikant is vrij van elke verantwoordelijkheid, indien de beschikkingen van deze handleiding niet nageleefd worden.**

De afbeeldingen die bij deze aanwijzingen staan afgedrukt zijn slechts ter oriëntatie.

Haal het apparaat niet uit de beschermende verpakking, tot het moment van de inbouw. Indien u schade waarneemt aan het apparaat, sluit het dan niet aan. Neem contact op met onze Technische Dienst.

Dit apparaat behoort tot klasse 3, volgens de norm EN 30-1-1 voor gasapparaten: apparaat ingebouwd in een meubel.

Zorg, voordat uw nieuwe kookplaat geïnstalleerd wordt, dat de installatie uitgevoerd wordt volgens het installatievoorschrift.

Dit apparaat mag niet worden geïnstalleerd in jachten of caravans.

Dit apparaat mag alleen gebruikt worden in voldoende geventileerde ruimtes.

Dit apparaat is niet bestemd voor gebruik met een externe tijdschakelklok of een afstandbediening.

**Alle werkzaamheden betreffende installatie, afstelling en aanpassing aan een ander soort gas moeten worden uitgevoerd door een bekwaam installateur, waarbij alle toepasbare normen en wetgeving en de voorschriften van de lokale gas- en elektriciteitsmaatschappijen moeten worden nageleefd. Er wordt met name gelet op de voorschriften met betrekking tot ventilatie.**

Dit apparaat is vanuit de fabriek aangepast aan het soort gas dat vermeld staat op het gegevensplaatje. Raadpleeg het installatievoorschrift indien dat gewijzigd moet worden. Het wordt aanbevolen onze Technische dienst te bellen voor de aanpassing aan een ander soort gas.



Dit apparaat is enkel ontworpen voor huishoudelijk gebruik. Commercieel of professioneel gebruik hiervan is niet toegestaan. Gebruik het apparaat enkel om te koken, nooit als verwarming. De garantie is alleen geldig als het apparaat gebruikt wordt voor het doel waarvoor het ontworpen is.

Dit apparaat is bestemd voor gebruik tot op hoogten van maximaal 2.000 meter boven zeeniveau.

Gebruik geen deksels of beschermingsbarrières voor kinderen die niet aanbevolen worden door de fabrikant van de kookplaat. Ze kunnen ongevallen veroorzaken, bv. wegens oververhitting, ontsteking of loskomen van materiaaldeeltjes.

Dit toestel kan worden gebruikt door kinderen vanaf 8 jaar en door personen met beperkte fysieke, sensorische of geestelijke vermogens of personen die gebrek aan kennis of ervaring hebben, wanneer zij onder toezicht staan van een persoon die verantwoordelijk is voor hun veiligheid of geleerd hebben het op een veilige manier te gebruiken en zich bewust zijn van de risico's die het gebruik van het toestel met zich meebrengt.

Kinderen mogen niet met het apparaat spelen. Reiniging en onderhoud van het toestel mogen niet worden uitgevoerd door kinderen, tenzij zij 15 jaar of ouder zijn en onder toezicht staan.

Zorg ervoor dat kinderen die jonger zijn dan 8 jaar uit de buurt blijven van het toestel of de aansluitkabel.

---

## **Belangrijke veiligheidsvoorschriften**

### **Waarschuwing – Deflagratiegevaar!**

Ophoping van onverbrand gas in een afgesloten ruimte veroorzaakt deflagratiegevaar. Stel het apparaat niet bloot aan luchtstromen. De branders zouden kunnen uitgaan. Lees de aanwijzingen en waarschuwingen omtrent de werking van gasbranders aandachtig door.

### **Waarschuwing – Risico op vergiftiging!**

Het gebruik van een gaskookapparaat veroorzaakt warmte, vocht en verbrandingsproducten in de ruimte waar het geïnstalleerd is. Zorg voor een goede ventilatie in de keuken, met name wanneer kookplaat aan staat: laat de natuurlijke ventilatieopeningen open of installeer een voorziening voor mechanische ventilatie (afzuigkap). Bij intensief en langdurig gebruik van het apparaat kan extra of doeltreffendere ventilatie nodig zijn: zet een raam open of verhoog het vermogen van de mechanische ventilatie.

### **Waarschuwing – Gevaar voor brandwonden!**

- De kookzones en nabijgelegen zones worden zeer heet. Raak de hete oppervlakken nooit aan. Houd kinderen jonger dan 8 jaar uit de buurt.
- Wanneer de fles voor vloeibaar gas niet loodrecht staat, kan het vloeibare propaan/ butaan/ in het apparaat terechtkomen. Er kunnen dan heftige steekvlammen bij de branders optreden. Onderdelen kunnen beschadigd raken en in de loop van de tijd ondicht worden, waardoor er op een ongecontroleerde manier gas ontsnapt. Deze beide oorzaken kunnen leiden tot verbrandingen. Flessen voor vloeibaar gas altijd in een loodrechte stand houden.

### **Waarschuwing – Risico van brand!**

- Het kookproces moet regelmatig worden gecontroleerd. Een kort kookproces moet continu in de gaten worden gehouden.
- De kookzones worden zeer heet. Leg nooit ontvlambare voorwerpen op de kookplaat. Bewaar geen voorwerpen op de kookplaat.



- Sla geen corrosieve chemische producten, stoom, ontvlambare materialen of niet-voedingsmiddelen op onder dit huishoudelijk apparaat of in de buurt daarvan.
- Oververhit vet of olie vat gemakkelijk vlam. Ga nooit weg terwijl u vet of olie verhit. Indien dit vlam vat, doof het vuur dan niet met water. Doe een deksel op de pan om het vuur te doven en zet de kookzone uit.

### **Waarschuwing – Risico op verwonding!**

- Pannen die beschadigd zijn, een ongeschikte afmeting hebben, buiten de randen van de kookplaat uitkomen of niet goed geplaatst zijn kunnen ernstig letsel veroorzaken. Neem de tips en waarschuwingen omtrent pannen in acht.

- Ondeskundige reparaties zijn gevaarlijk. Reparaties en vervangingen van beschadigde elektriciteits- en gasleidingen mogen uitsluitend worden uitgevoerd door technici die zijn geïnstrueerd door de klantenservice. Is het toestel defect, haal dan de stekker uit het stopcontact of schakel de zekering in de meterkast uit, de gastoevoer sluiten. Contact opnemen met de klantenservice.
- Wanneer een bedieningsknop los zit of er niet aan kan worden gedraaid, mag hij niet meer worden gebruikt. Neem direct contact op met de servicedienst, om de knop te laten repareren of vervangen.

### **Waarschuwing – Gevaar voor elektrische schokken!**

Gebruik geen stoomreinigers om het apparaat te reinigen.

## **Algemene aanwijzingen**

### Technische informatie

		Hulpbrander	Halfsnelbrander	Sterke brander	Wokbrander	Tweevoudige wokbrander
Thermisch vermogen	AARDGAS	1,00 kW	1,75 kW	3,00 kW	4,00 kW	5,00 kW
	VLOEIBAAR PETROLEUMGAS					4,60 kW
Model PCP6A5B90V		1	2	1	-	-
Model PCQ7A5B90V		1	2	1	1	-
Model PCQ7A5M90V		1	2	1	1	-
Model PCS7A5M90V		1	2	1	-	1
Model PCR9A5M90V		1	2	1	-	1
Afstelmogelijkheden	AARDGAS G20/17,6 - 19,6 mbar; 1,76 - 1,96 kPa					
	VLOEIBAAR PETROLEUMGAS G30/27,5 mbar; 2,75 kPa					
Elektrische eigenschappen	110 - 240 V~ 50/60 Hz					

LET OP: Dit product werkt op vloeibaar petroleumgas. Als u het product wilt gebruiken met aardgas, neem dan contact op met ons servicecenter.

### **BELANGRIJK**

- Plaats de roosters en de branders zoals aangegeven staat in de schema's waarop het model wordt beschreven.
- Houd het gebied rond het apparaat vrij van brandbare materialen, benzine en andere brandbare dampen en vloeistoffen.
- Niet als verwarming gebruiken, dat is gevaarlijk.

### **VOOR UW VEILIGHEID**

#### **ALS U GAS RUIKT:**

- OPEN ALLE RAMEN
- RAAK DE ELEKTRISCHE SCHAKELAARS NIET AAN
- DOOF DE VLAMMEN DOOR DE HOOFD DOORLAATKLEP TE SLUITEN
- BEL DIRECT UW GASLEVERANCIER OF HET CENTRALE NUMMER VOOR GASLEKKEN

#### **VOOR UW VEILIGHEID**

- BEWAAR GEEN BENZINE OF ANDERE BRANDBARE VLOEISTOFFEN IN DE NABIJHEID VAN UW APPARAAT
- INSTALLEER HET PRODUCT VOLGENS DE GEBRUIKSAANWIJZING OM ZO WARMTESCHADE AAN UW MEUBELS TE VOORKOMEN

## Het apparaat leren kennen

In het modeloverzicht vindt u uw apparaat met de brandervermogens. → B/z. 2

### Bedieningselementen en branders

Bij elke bedieningsknop wordt de bijbehorende brander aangegeven. Met de bedieningsknoppen kunt u, in overeenstemming met de verschillende posities, het benodigde vermogen instellen tussen de maximale en minimale waarden. Probeer nooit om van stand 0 direct naar stand 1 of om van stand 1 naar stand 0 te gaan.

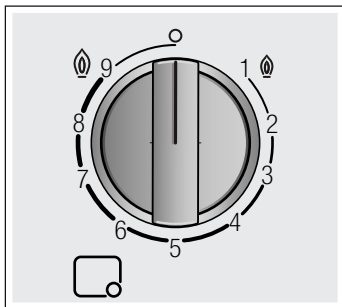

Indicaties	
	Brander die m.b.v. de bedieningsknop wordt geregeld
	Uitgeschakelde brander
	Hoogste vermogensstand en elektrische ontsteking
	Laagste vermogensstand

De binnenste en buitenste vlammen van de tweevoudige dubbelbrander kunnen onafhankelijk van elkaar worden geregeld. De mogelijke vermogensstanden zijn:

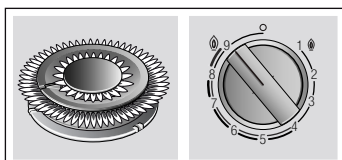

Buitenste vlam op maximaal vermogen.

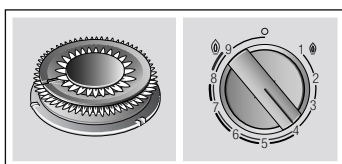

Buitenste vlam op minimaal, binnenste vlam op maximaal vermogen.

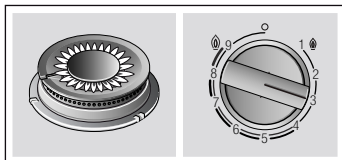

Binnenste vlam op maximaal vermogen.

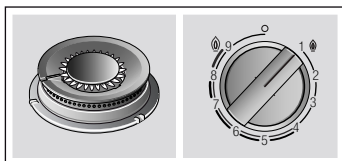

Binnenste vlam op minimaal vermogen.

Voor een correcte werking van het apparaat is het noodzakelijk om te controleren of de roosters en alle delen van de branders juist geplaatst zijn. Verwissel de deksels van de branders niet.

Roosters altijd voorzichtig verwijderen. Door een rooster te verschuiven kan het rooster daaronder ook van plaats veranderen.

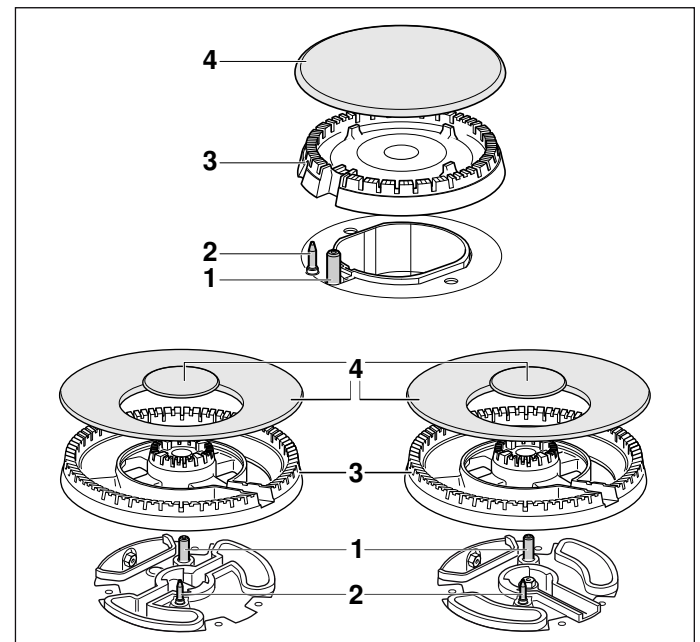

Elementen	
1	Ontstekingskaars
2	Thermo-element
3	Branderkelk
4	Branderdeksel

### Toebehoren

Afhankelijk van het model, kan de kookplaat de onderstaande toebehoren bevatten. Deze kunnen ook worden aangeschaft bij de technische dienst.

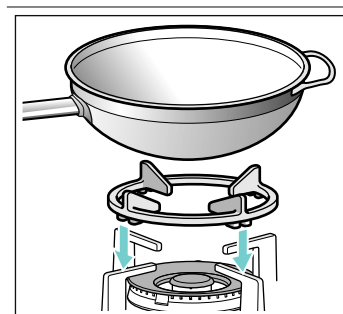

#### Extra wokrooster

Alleen geschikt voor gebruik op wokbranders. Gebruik pannen met gewelfde bodem.

Ter verlenging van de levensduur van het apparaat adviseren wij om het extra wokrooster te gebruiken.

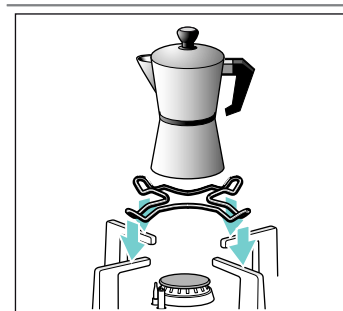

#### Extra rooster espresso-koker

Alleen geschikt voor gebruik met de kleinste brander. Gebruik kookgerei met een diameter van minder dan 12 cm.

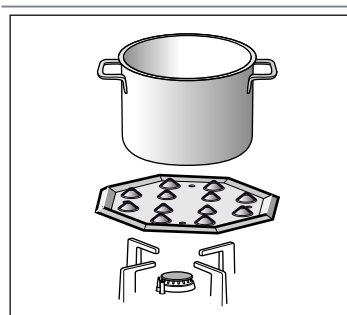
**Sudderplaat**

Dit accessoire is alleen geschikt voor het garen op lage temperatuur. Het kan met de hulpbrander of de halfsnelbrander worden gebruikt. Beschikt uw kookplaat over meerdere halfsnelbranders, dan is het raadzaam om de sudderplaat op de halfsnelbrander rechtsachter of rechtsvoor te plaatsen.

Leg de plaat met de gewelfde kant naar boven op de houder en nooit direct op de brander.

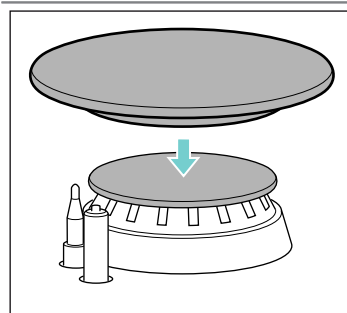
**Simmer Cap**

Het deksel uitsluitend voor het koken met minimaal vermogen gebruiken. De Simmer Cap op het deksel van de hulpbrander plaatsen. De pan op het rooster plaatsen, nooit direct op de Simmer Cap.

**Code**

HEZ298107 Extra wokrooster: gietijzer (4-5 kW)  
 HEZ298110 Extra wokrooster: geëmailleerd staal  
 HEZ298115 Extra rooster espressokoker  
 HEZ298105 Sudderplaat  
 HEZ211310 Simmer cap

De fabrikant neemt geen verantwoordelijkheid op zich wanneer deze toebehoren niet of verkeerd gebruikt worden.



## Gasbranders

### Met de hand inschakelen

1. Druk op de bedieningsknop van de gekozen brander en draai hem naar links tot de hoogste vermogensstand.
2. Houd een aansteker of een vlam (van een lucifer bijv.) bij de brander.

### Automatische ontsteking

Als de kookplaat over een automatische ontsteking beschikt (ontstekingskaarsen):

1. De bedieningsknop van de geselecteerde brander indrukken en naar links tot aan de hoogste vermogensstand draaien. Zolang de bedieningsknop ingedrukt blijft, maken alle branders vonken. De vlam ontsteekt. Enkele seconden wachten.
2. De bedieningsknop loslaten.
3. De bedieningsknop in de gewenste positie draaien.

Als er geen ontsteking plaatsvindt, de brander uitschakelen en de voordien beschreven stappen herhalen. Deze keer de bedieningsknop langer ingedrukt houden (tot 10 seconden).

**⚠ Waarschuwing – Ontploffingsgevaar!**

Als de vlam na 15 seconden niet ontsteekt, de brander uitschakelen en de deur of het raam van de kamer openen. Vooraleer de brander opnieuw wordt ingeschakeld, minstens een minuut wachten.

**Aanwijzing:** Op maximale netheid letten. Als de ontstekingskaarsen vervuild zijn, kan het tot een foute ontsteking komen. De ontstekingskaarsen regelmatig met een kleine, niet-metalen borstel reinigen. Erop letten dat de ontstekingskaarsen niet aan heftige stoten worden blootgesteld.

### Veiligheidssysteem

Uw kookplaat beschikt over een veiligheidssysteem (thermokoppel) dat de gasuitlaat verhindert indien de branders per ongeluk uitgaan.

Om te garanderen dat deze voorziening actief zou zijn:

1. Ontsteek de brander op gewone wijze.
2. Laat de knop niet los, houd deze stevig ingedrukt gedurende 4 seconden nadat de vlam ontstoken is.

### Een brander uitdoven

Draai de overeenstemmende knop naar rechts tot stand 0.

Enkele seconden nadat de brander uitgaat, klinkt er een geluid (plof). Dit is geen afwijking, dit betekent dat de veiligheid gedeactiveerd is.

## Hoofdschakelaar / Vergrendeling van de kookplaat (Main Switch)

De kookplaat kan voorzien zijn van een hoofdschakelaar, die de algemene gasverdeling afsluit en alle branders gelijktijdig uitdooft. Deze schakelaar is heel praktisch wanneer er kinderen in huis zijn, of indien om een bepaalde reden snel alle branders moeten worden uitgedoofd.

### Om de kookplaat te vergrendelen:

Druk op de hoofdschakelaar.

Alle branders die ingeschakeld zijn, gaan uit. De kookplaat wordt vergrendeld.

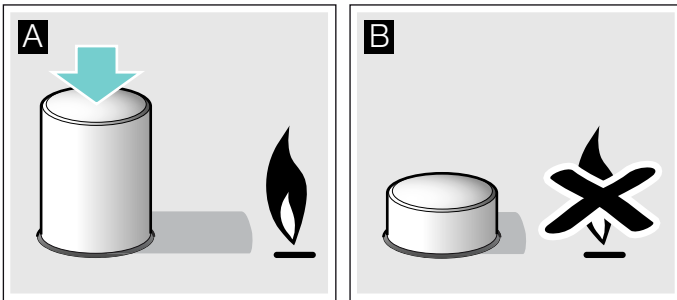

### Om de kookplaat te ontgrendelen:

1. Plaats alle knoppen in de uitstand.
2. Druk en draai de hoofdschakelaar rechtsom tot tegen de aanslag.

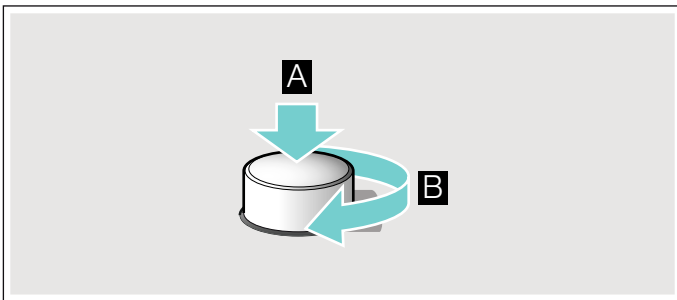

De algemene gasverdeling wordt geopend. U kan de kookplaat normaal gebruiken.

## Waarschuwingen

Tijdens de werking van de brander is het normaal dat u een zachte fluittoon hoort.

De eerste keren dat het apparaat gebruikt wordt is het normaal dat er geuren vrijkomen. Dit betekent geen risico noch defecte werking. Deze verdwijnen na verloop van tijd.

Een vlam met een oranje kleur is normaal. Dit komt door de aanwezigheid van stof in de omgeving, gemorste vloeistof, enz.

Mocht de vlam van de brander per ongeluk uitgaan, sluit dan de bedieningsknop van de brander en wacht ten minste 1 minuut alvorens hem weer te proberen aan te steken.

## Tabellen en tips

### Geschikte pannen

Branders	Minimale diameter van de bodem van de pan	Maximale diameter van de bodem van de pan
Wokbrander	22 cm	30 cm
Sterke brander	20 cm	26 cm
Halfsnelbrander	14 cm	22 cm
Hulpbrander	12 cm	16 cm

De pan mag niet over de rand van de kookplaat uitsteken.

### Gebruiksaanwijzingen

**Aanwijzing:** Bij gebruik met bepaalde pannen kan er een tijdelijke, lichte vervorming van de stalen kookvlakken ontstaan. Dit is normaal en heeft geen invloed op de werking van het apparaat.

De volgende adviezen helpen u om energie te sparen en schade aan het kookgerei te voorkomen:

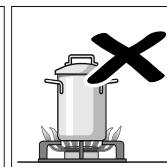
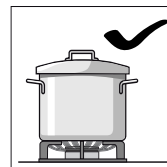

Gebruik pannen met een geschikte maat voor elke brander.

Gebruik geen kleine pannen op grote branders. De vlam mag de zijkanten van de pan niet raken.

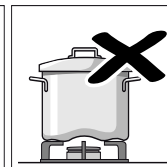
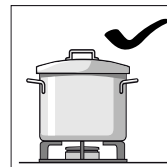

Gebruik geen vervormde pannen die onstabiel staan op de kookplaat. De pannen zouden kunnen kantelen.

Gebruik altijd pannen met een vlakke en dikke bodem.

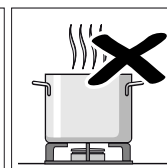
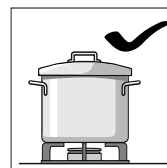

Kook niet zonder deksel of met verschoven deksel. Een deel van de energie gaat verloren.

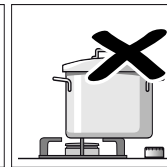
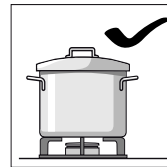

Plaats de pan op het midden van de brander. Zo niet, dan kan deze omvallen.

Plaats geen grote pannen op de branders naast de knoppen. Deze kunnen beschadigd worden wegens te hoge temperatuur.

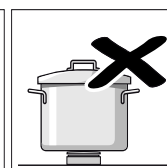
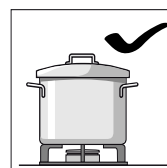

Plaats de pannen op de roosters, nooit rechtstreeks op de brander. Controleer voor gebruik of de roosters en de branderdeksels op de juiste wijze zijn geplaatst.

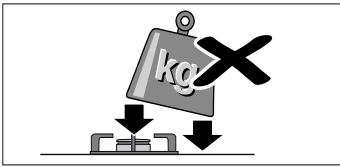

Hanteer de pannen voorzichtig op de kookplaat. Stoot niet tegen de kookplaat aan, noch plaats hierop te hoge gewichten.

### Kooktabel

In de volgende tabel staan de optimale kookstanden en bereidingstijden voor verschillende gerechten. Bij de recepten wordt steeds uitgegaan van vier porties.

De bereidingstijden en kookstanden zijn afhankelijk van het soort, het gewicht en de kwaliteit van de gerechten evenals het type gas en het materiaal van de pan. Voor de bereiding van deze gerechten zijn hoofdzakelijk pannen van roestvrij staal gebruikt.

Gebruik altijd pannen met de juiste afmetingen en plaats ze midden op de brander. Informatie over de diameter van de pannen vindt u onder. → "Geschikte pannen"

### Informatie over de tabel

De bereiding van elk gerecht bestaat uit één of twee stappen. Bij elke stap vindt u informatie over:

- Bereidingsmethode
- Kookstand
- Tijdsduur in minuten

### In de tabel opgegeven bereidingsmethoden

- Opkoken
- Doorkoken
- Druk in de snelkookpan opbouwen
- Druk in de snelkookpan behouden
- Sterk aanbraden
- Zacht aanbraden
- Smelten
- \* Zonder deksel
- \*\* Voortdurend roeren

**Aanwijzing:** Er verschijnen geen symbolen op het apparaat. Zij dienen ter oriëntatie voor verschillende bereidingsmethoden.

Er verschijnen opgaven voor het bereiden van gerechten op verschillende branders. De brander die het eerst vermeld wordt, is de aanbevolen optie. In het modeloverzicht worden alle branders van de kookplaat beschreven. → Blz. 2

Voorbeeld:

Gerecht	Totale tijd in min.	Stap 1		Stap 2	
Branders					
<b>Soepen, crèmesoepen</b>					
Vissoep					
Sterke brander	12-17		8 7-9		1 5-8
Halfsnelbrander	17-22		8 11-13		1 6-9
Wokbrander	10-15		9 6-8		4 4-7

In dit voorbeeld staat de bereiding van vissoep met de sterke brander, de halfsnelbrander en de wokbrander.

Met de sterke brander (aanbevolen optie) bedraagt de totale bereidingstijd 12 tot 17 minuten.











































- **Stap 1:** Aan de kook brengen. Voor een tijdsduur van 7-9 minuten kookstand 8 instellen.
- **Stap 2:** Doorkoken. Voor een tijdsduur van 5-8 minuten overgaan naar kookstand 1.

De opgaven gelden ook voor de andere voorgestelde branders.







Gerecht	Totale tijd in min.	Stap 1		Stap 2	
Branders					
<b>Soepen, crèmesoepen</b>					
Vissoep					
Sterke brander	12-17		8 7-9		1 5-8
Halfsnelbrander	17-22		8 11-13		1 6-9
Wokbrander	10-15		9 6-8		4 4-7
Pompoenroom, borsjt-soep					
Sterke brander	30-35		9 10-12		5 20-23
Halfsnelbrander	45-50		9 15-17		6 30-33
Wokbrander	25-30		9 8-10		2 17-20
Minestrone (groentesoep)					
Sterke brander	47-52		9 10-12		5 37-40
Halfsnelbrander	57-62		9 10-12		6 47-50
Wokbrander	43-48		8 8-10		3 35-38
<b>Pasta en rijst</b>					
Spaghetti					
Sterke brander	18-22		9 8-10		6 10-12
Halfsnelbrander	20-24		9 10-12		7 10-12
Wokbrander	18-22		8 8-10		6 10-12
Rijst					
Sterke brander	17-22		9 5-7		2 12-15
Halfsnelbrander	18-23		9 7-9		6 11-14
Wokbrander	15-20		8 4-6		2 11-14
Ravioli					
Sterke brander	9-14		9 4-6		6 5-8
Halfsnelbrander	17-22		8 12-14		8 5-8
Wokbrander	10-15		8 5-7		8 5-8
<b>Groente en peulvruchten</b>					
Gekookte aardappelen (puree, aardappelsalade)					
Sterke brander	23-28		9 8-10		5 15-18
Halfsnelbrander	25-30		9 10-12		6 15-18
Wokbrander	25-30		7 11-13		5 14-17
Hummus (gepureerde kikkererwten)					
Sterke brander	50-55		9 10-12		4 40-43
Halfsnelbrander	52-57		9 12-14		5 40-43





Gerecht Branders	Totale tijd in min.	Stap 1			Stap 2		
							
Wokbrander	47-52		7	10-12		5	37-40
Linzen							
Sterke brander	40-45		9	8-10		8	32-35
Halfsnelbrander	50-55		9	18-20		6	32-35
Wokbrander	45-50		6	20-22		4	25-28
Gefrituurde groente							
Sterke brander	12-17		7	6-8		6	6-9
Halfsnelbrander	15-20		8	8-10		7	7-10
Tweevoudige wokbrander	10-15		7	5-7		5	5-8
Gesauteerde, verse groente**							
Wokbrander	6-8		9	6-8			
Sterke brander	6-8		9	6-8			
Frites							
Wokbrander	15-20		7	15-20			
Sterke brander	15-20		9	15-20			
Halfsnelbrander	25-30		9	25-30			
<b>Eieren</b>							
Shakshuka							
Halfsnelbrander	15-20		9	10-12		4	5-8
Sterke brander	13-18		8	7-9		3	6-9
Tweevoudige wokbrander	15-20		6	11-13		4	4-7
Omelet (1 portie)							
Halfsnelbrander	3-5		8	3-5			
Sterke brander	2-4		9	2-4			
Wokbrander	2-4		5	2-4			
Spaanse tortilla							
Sterke brander	25-30		9	25-30			
Wokbrander	18-23		9	18-23			
Tweevoudige wokbrander	25-30		7	25-30			
<b>Sauzen</b>							
Bechamelsaus**							
Hulpbrander	10-15		6	2-4		6	8-11
Halfsnelbrander	10-15		5	2-4		5	8-11
Wokbrander	3-8		5	1-2		5	2-6
Saus met blauwe schimmelkaas**							
Hulpbrander	4-6		7	4-6			
Halfsnelbrander	3-5		7	3-5			
Sterke brander	3-5		5	3-5			
Napoletana-saus							
Halfsnelbrander	18-23		6	2-4		4	16-19
Wokbrander	13-18		7	1-3		5	12-15









Gerecht Branders	Totale tijd in min.	Stap 1			Stap 2		
							
Sterke brander	15-20		8	1-3		6	14-17
Carbonara-saus							
Halfsnelbrander	10-15		6	5-7		3	5-8
Sterke brander	8-13		5	4-6		3	4-7
Hulpbrander	10-15		9	5-7		5	5-8
<b>Vis</b>							
Stokvis op Romeinse wijze							
Sterke brander	5-10		8	5-10			
Halfsnelbrander	8-13		9	8-13			
Wokbrander	4-9		6	4-9			
Gebakken zalm							
Sterke brander	5-10		7	2-4		1	3-6
Tweevoudige wokbrander	5-10		6	2-4		1	3-6
Wokbrander	7-12		8	2-4		1	5-8
Mosselen							
Sterke brander	5-7		9	5-7			
Wokbrander	4-6		9	4-6			
Halfsnelbrander	10-12		9	10-12			
<b>Vlees</b>							
Eendenborst (1 stuk)							
Halfsnelbrander	6-8		7	6-8			
Sterke brander	9-11		7	9-11			
Wokbrander	6-8		5	6-8			
Runderfilet Stroganoff							
Sterke brander	8-13		9	8-13			
Wokbrander	5-10		8	5-10			
Halfsnelbrander	12-17		9	12-17			
Kipschnitzel (8 kipfilets)							
Sterke brander	7-12		9	2-4		6	5-8
Wokbrander	7-12		9	2-4		6	5-8
Halfsnelbrander	7-12		9	7-12			
Gehakt (vleespastei, gehaktballen, bolognesesaus)							
Sterke brander	15-20		8	15-20			
Halfsnelbrander	20-25		9	20-25			
Wokbrander	15-20		6	15-20			
<b>Kant-en-klaar producten</b>							
Diepvrieskroketten (16 stuks)							
Diepvrieskroketten (12 stuks)							
Sterke brander	6-10		8	6-10			
Wokbrander	5-9		8	5-9			
Halfsnelbrander	8-12		8	8-12			



Gerecht Branders	Totale tijd in min.	Stap 1			Stap 2		
							
Braadworsten (12 stuks)							
Sterke brander	5-10		9	1-3		7	4-7
Halfsnelbranders	7-12		9	7-12			
Wokbranders	5-10		9	1-3		7	4-7
Gekookte worst (12 stuks)							
Halfsnelbranders	8-13		9	8-13			
Wokbranders	9-14		4	9-14			
Sterke branders	7-12		7	7-12			
Hamburgers (4 stuks)							
Sterke brander	4-9		9	1-3		7	3-6
Wokbranders	4-9		9	1-3		7	3-6
Halfsnelbranders	5-10		9	1-3		8	4-7
Diepvriesgroente**							
Sterke brander	7-12		9	7-12			
Wokbranders	5-10		9	5-10			
Halfsnelbranders	12-17		9	12-17			
Pizza (20 cm diameter)							
Wokbranders	4-8		1	4-8			
Sterke branders	16-20		1	16-20			
Halfsnelbranders	20-25		1	20-25			

## Desserts

Rijstpudding**							
Halfsnelbranders	30-35		8	9-11		4	21-24
Hulpbranders	40-45		9	12-14		2	28-31
Wokbranders	35-40		7	11-13		1	24-27
Melkchocolade							
Hulpbranders	10-14		1	10-14			
Halfsnelbranders	16-20		1	16-20			
Crêpes (4 stuks)							
Sterke branders	17-22		7	1-3		5	16-19
Wokbranders	8-13		7	1-3		4	7-10
Tweevoudige wokbranders	9-14		5	1-3		4	8-11
Broodpudding							
Sterke branders	25-30		9	10-12		6	15-18
Wokbranders	23-28		9	8-10		7	15-18
Halfsnelbranders	27-32		9	10-12		7	17-20
Spaanse pudding**							
Sterke branders	3-8		5	3-8			
Halfsnelbranders	8-13		5	8-13			
Wokbranders	3-8		2	3-8			
Cake (au bain-marie)							
Sterke branders	35-40		9	35-40			

Gerecht Branders	Totale tijd in min.	Stap 1			Stap 2		
							
Wokbranders	40-45		9	40-45			
Halfsnelbranders	45-50		9	45-50			

## Kooktips

- Gebruik voor de bereiding van crèmesoeppen en peulvruchten een snelkookpan. De bereidingstijd wordt dan merkbaar korter. Gebruikt u een snelkookpan, houd u dan aan de aanwijzingen van de producent. Voeg alle ingrediënten direct aan het begin toe.
- Tijdens het koken van aardappels en rijst moet de pan altijd afgedekt zijn. De bereidingstijd wordt daardoor merkbaar korter. Voordat u pasta, rijst of aardappels toevoegt, moet het water koken. Pas vervolgens de kookstand aan om verder te gaan met de bereiding.
- Bij pannengerechten dient u eerst de olie te verhitten. Zorg ervoor dat de temperatuur tijdens het bakken constant blijft door zo nodig de kookstand aan te passen. Wacht bij het klaarmaken van meerdere porties tot de bereidingstemperatuur weer bereikt is. U dient de gerechten regelmatig te keren.
- Maakt u soepen, crème, linzen of kikkererwten klaar, doe alle ingrediënten dan gelijktijdig in de pan.

## Reinigen en onderhouden

### Reiniging

Wanneer het apparaat koud is, reinig het met een spons, water en zeep.

Reinig na elk gebruik het oppervlak van de verschillende elementen van de brander, nadat deze is afgekoeld. Achtergebleven resten (aangekoekt voedsel, vetdruppels, enz.), hoe weinig ook, zetten zich vast op het oppervlak en zijn later moeilijker te verwijderen. Voor een correcte vlam moeten de openingen en gleuven schoon zijn.

De beweging van sommige pannen kan metaalresten achterlaten op de roosters.

Reinig de branders en de roosters met zeepsop en wrijf erover met een niet-metalen borstel.

Indien de roosters rubber voetjes hebben, wees voorzichtig bij het reinigen hiervan. De voetjes kunnen losraken en het rooster kan de kookplaat krassen.

Droog de branders en de roosters altijd volledig. De aanwezigheid van waterdruppels of vochtige zones bij de aanvang van het koken kan het email beschadigen.

Na het reinigen en drogen van de branders, zorg dat de branderdeksels juist geplaatst zijn op de diffusor.

#### Attentie!

- Het is niet toegestaan de bedieningselementen te verwijderen om het apparaat schoon te maken. Het apparaat kan dan beschadigd raken door inkomend vocht.

- Gebruik geen stoomreinigers. Dit zou de kookplaat kunnen beschadigen.
- Indien de kookplaat een glazen of aluminium paneel heeft, gebruik geen mes, schraper of dergelijke om de verbinding met het metaal te reinigen.

### Onderhoud

Reinig meteen gemorste vloeistof. Zo wordt vermeden dat de etensresten zouden kleven en bespaart u onnodige inspanningen.

Vanwege de hoge temperatuur kunnen de wokbrander en de roestvrij stalen zones (vetpot, omtrek van de branders, etc.) van kleur veranderen. Dit is normaal. Reinig, na elk gebruik, deze zones met een geschikt product voor roestvrij staal.

Er wordt aanbevolen regelmatig het reinigingsmiddel te gebruiken dat beschikbaar is bij onze technische dienst met code 311499.

#### Attentie!

Het schoonmaakmiddel voor roestvrij staal mag niet gebruikt worden in de zone rond de bedieningsknoppen. Dit om te voorkomen dat de aanwijzingen (serigrafie) worden uitgeveegd.

Laat geen zure vloeistoffen (citroensap, azijn, enz..) op de kookplaat.

## Wat te doen bij storingen?

Soms kunnen storingen gemakkelijk worden verholpen. Neem de volgende aanwijzingen in acht voor u de servicedienst belt:

Afwijking	Mogelijke oorzaak	Oplossing
De algemene elektrische werking is defect.	Defecte zekering.	Controleer in de zekeringkast of de zekering stuk is en vervang deze.
	De automaat of een differentieel is gesprongen.	Controleer op het schakelbord of de automaat of een differentieel is gesprongen.
De automatische vonkontsteking werkt niet.	Er kunnen voedingsresten of resten van reinigingsmiddelen tussen de bougies en de branders zitten.	De ruimte tussen de bougie en de brander moet schoon zijn.
	De branders zijn nat.	Maak de branderdeksels zorgvuldig droog.
	De branderdeksels zijn niet juist geplaatst.	Controleer of de deksels juist geplaatst zijn.
	Het apparaat is niet geaard, niet goed aangesloten of de aardleiding is defect.	Neem contact op met de elektrische installateur.
De vlam van de brander is niet gelijkmatig.	De delen van de brander zijn niet juist geplaatst.	Plaats de onderdelen op de juiste wijze op de bijbehorende brander.
	De gleuven van de brander zijn vuil.	Reinig de gleuven van de brander.
De gasstroom lijkt niet normaal of er komt geen gas uit.	De gasuitlaat is gesloten met afsluitkranen.	Open de mogelijke afsluitkranen.
	Indien het gas uit een gasfles komt, kijk dan of deze leeg is.	Vervang de gasfles.

Afwijking	Mogelijke oorzaak	Oplossing
Het ruikt naar gas in de keuken.	Een kraan is open.	Sluit de kranen.
	De gasfles is niet goed aangesloten.	Controleer of de aansluiting perfect is.
	Mogelijk gaslek.	Draai de gaskraan dicht, ventileer de ruimte en waarschuw onmiddellijk een installatietechnicus, voor controle en certificatie van de installatie. Gebruik het apparaat niet totdat zeker is gesteld dat er geen gaslek is in de installatie of het apparaat.
De brander gaat meteen uit als de knop wordt losgelaten.	De knop is niet lang genoeg ingedrukt.	Houd de knop, nadat de brander ontvlamt, nog enkele seconden ingedrukt.
	De gleuven van de brander zijn vuil.	Reinig de gleuven van de brander.

## Servicedienst

Indien onze Technische Dienst aangevraagd wordt, dient het productnummer (E-Nr.) en het fabricagenummer (FD) van het apparaat te worden verstrekt. Deze informatie staat op het gegevensplaatje, op de onderzijde van de kookplaat en op het label van de gebruiksaanwijzing.

De contactgegevens voor alle landen vindt u in de bijgaande klantenservicemap.

## Garantievoorwaarden

Indien het apparaat, tegen onze verwachting in, schade vertoont of niet voldoet aan de voorziene kwaliteitseisen, verzoeken we u om ons dit zo snel mogelijk te laten weten. Opdat de garantie geldig zou zijn, mag het apparaat niet gemanipuleerd noch onderworpen zijn aan een ongeschikt gebruik.

De garantievoorwaarden die van toepassing zijn, worden bepaald door de vertegenwoordiging van onze onderneming in het land waarin de aankoop uitgevoerd is. U kunt gedetailleerde informatie aanvragen op onze verkooppunten. U moet het aankoopbewijs tonen om gebruik te maken van de garantie.

Recht op wijzigingen voorbehouden.

## Milieubescherming

Staat het symbool  op het typeplaatje, neem dan de volgende aanwijzingen in acht.

### Milieuvriendelijk afvoeren

Voer de verpakking op een milieuvriendelijke manier af.



Dit apparaat is gekenmerkt in overeenstemming met de Europese richtlijn 2012/19/EU betreffende afgedankte elektrische en elektronische apparatuur (waste electrical and electronic equipment - WEEE). De richtlijn geeft het kader aan voor de in de EU geldige terugname en verwerking van oude apparaten.

De verpakking van uw apparaat is vervaardigd uit materialen die strikt noodzakelijk zijn om een goede bescherming te garanderen tijdens het vervoer. Deze materialen zijn volledig recyclebaar, op deze wijze wordt het milieueffect verminderd. We nodigen u uit om ook bij te dragen tot het behoud van het milieu, door onderstaande raadgevingen op te volgen:

- gooi de verpakking in de daarvoor bestemde container voor recycling,
- maak een afgedankt apparaat onbruikbaar alvorens het weg te doen. Raadpleeg bij uw lokale overheid het adres van het dichtstbijzijnde inzamelplaats voor recyclebaar materiaal en lever daar uw apparaat in,
- spoel gebruikte olie niet door de gootsteen. Bewaar deze in een gesloten vat en geef deze af in een inzamelpunt of bij het ontbreken hiervan, in een vuilnisbak, (deze komt terecht op een gecontroleerde stortplaats; waarschijnlijk is dit niet de beste oplossing, maar we vermijden waterverontreiniging).



## Thank you for buying a Bosch Home Appliance!

Register your new device on MyBosch now and profit directly from:

- **Expert tips & tricks for your appliance**
- **Warranty extension options**
- **Discounts for accessories & spare-parts**
- **Digital manual and all appliance data at hand**
- **Easy access to Bosch Home Appliances Service**

Free and easy registration – also on mobile phones:

**[www.bosch-home.com/welcome](http://www.bosch-home.com/welcome)**



## Looking for help? You 'll find it here.

Expert advice for your Bosch home appliances, need help with problems or a repair from Bosch experts.

Find out everything about the many ways Bosch can support you:

**[www.bosch-home.com/service](http://www.bosch-home.com/service)**

**Contact data of all countries are listed in the attached service directory.**

### **BSH Hausgeräte GmbH**

Carl-Wery-Straße 34  
81739 München, GERMANY  
[www.bosch-home.com](http://www.bosch-home.com)

A Bosch Company



9001124124 (021005)