

Your new dryer

Congratulations - You have chosen a modern, high-quality Bosch domestic appliance. The condensation dryer is distinguished by its economical energy consumption.

Every dryer which leaves our factory is carefully checked to ensure that it functions correctly and is in perfect condition. Should you have any questions, our after-sales service will be pleased to help.

Disposal in an environmentally-responsible manner

This appliance is labelled in accordance with European Directive 2012/19/EU concerning used electrical and electronic appliances (waste electrical and electronic equipment - WEEE). The guideline determines the framework for the return and recycling of used appliances as applicable throughout the EU.

For further information about our products, accessories, spare parts and services, please visit: www.bosch-home.com

Observe the safety instructions on page 13.

Read these instructions and the separate **Energy-saving mode** instructions before operating the dryer.

Contents

Preparation	Page
Control panel	2
Drying	3/4
Display panel and settings	5
Notes on laundry	6
Overview of programmes	7
Care and cleaning	8
Installation	9
Frost protection / Transport	9
Optional accessories	10
Technical data	10
Consumption rates	10
After-sales service	11
What to do if	11/12
Safety instructions	13

Intended use

- exclusively for domestic use,
- only for drying fabrics which have been washed using water.

Keep children younger than 3 years old away from the dryer. Do not let children make the cleaning and maintenance work on the dryer without supervision. Do not leave children unsupervised near the dryer. Keep pets away from the dryer.

The dryer can be operated by children 8 years old and older, by persons with reduced physical, sensory or mental abilities and by persons with insufficient experience or knowledge if they are supervised or have been instructed in its use by a responsible adult. This appliance is intended for use up to a maximum height of 4000 metres above sea level.

Programmes / Fabrics

Detailed overview of the programmes and fabrics → *Programme overview, page 7*. Observe the care instructions on the care label.

Cottons	Hard-wearing fabrics.
Easy-Care	Fabrics made from synthetic or blended fabrics.
Dryness levels to select with the Cottons and Easy-Care programmes:	
Cupboard Dry Plus	Thick and multi-layered fabrics.
Cupboard Dry	Single-layered laundry.
Iron Dry	Laundry suitable for ironing after drying.
Sportswear	Functional clothing made of microfibre.
Allergy Plus	Cotton fabrics for drying in higher temperatures.
Mixed Load	A mixed load of fabrics made of cotton and synthetic fabrics.
Timed program warm	All types of fabric; time programme.
Timed program cold	
Shirts 15'	Cotton or linen fabrics that are still damp and easy-care fabrics.
Super Quick 40'	Synthetics, cotton or blended fabrics.
Down	Fabrics with down filling.
Wool Finish	Woolen fabrics that are suitable for use in washers.

Preparation

Installation → page 9.

Never start the dryer if it is damaged! Inform your after-sales service!

Make sure your hands are dry. Only grasp the plug by the plug body.

Remove all items from pockets, especially cigarette lighters. The drum must be empty prior to loading. See programme overview on page 7. See also separate instructions for "Woolens basket" (depending on model).

Programme selector for setting the programme and switching the appliance on/off. Can be turned in both directions.

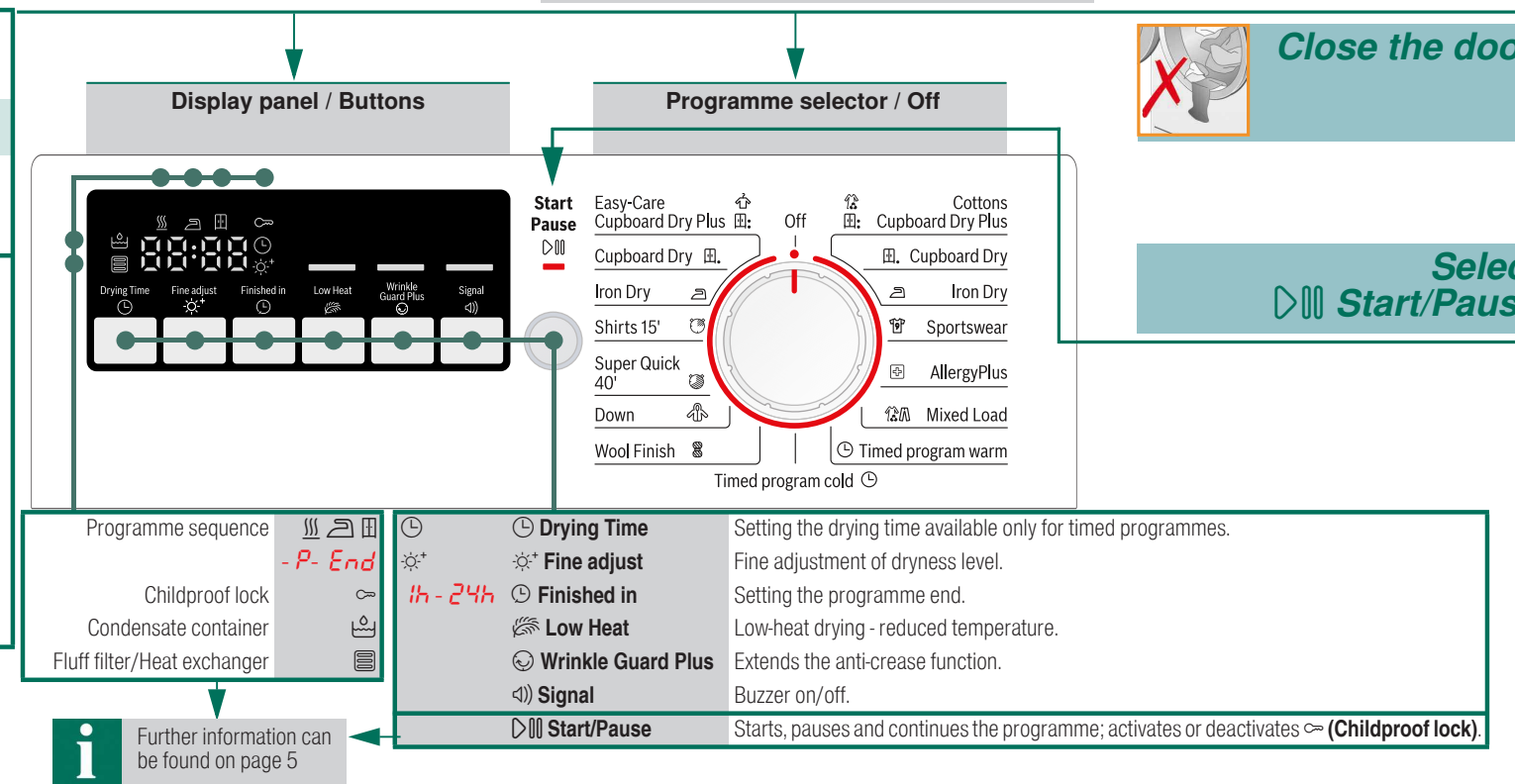

Drying

Inspect the dryer

Connect the mains plug

Sort the laundry

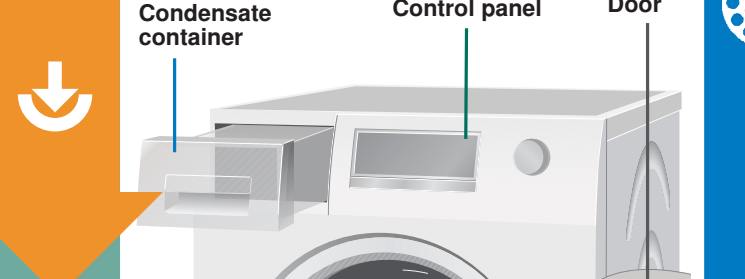

Set and adjust the programme individually

Close the door

Select Start/Pause

Remove the laundry and switch off the dryer

End of the programme... Interrupt the programme

The drum and door may be hot!

Empty the condensate container

Empty the container after each drying cycle.

Clean fluff filter

Settings (indicators lights and buttons)

Environmental protection / Energy-saving tips

Programme overview

Notes on laundry

Labelling of fabrics

Drying tips

Programme overview

Environmental protection / Energy-saving tips

Programme overview

Notes on laundry

Labelling of fabrics

Drying tips

Programme overview

Environmental protection / Energy-saving tips

Programme overview

Notes on laundry

Labelling of fabrics

Drying tips

Display panel and settings

Settings (indicators lights and buttons)

Environmental protection / Energy-saving tips

Programme overview

Notes on laundry

Labelling of fabrics

Drying tips

Programme overview

Environmental protection / Energy-saving tips

Programme overview

Notes on laundry

Labelling of fabrics

Drying tips

Programme overview

Environmental protection / Energy-saving tips

Programme overview

Notes on laundry

Labelling of fabrics

Drying tips

Programme overview

Notes on laundry

Notes on laundry ...

Labelling of fabrics

Drying tips

Programme overview

Notes on laundry

Labelling of fabrics

Drying tips

Programme overview

Environmental protection / Energy-saving tips

Programme overview

Notes on laundry

Labelling of fabrics

Drying tips

Programme overview

Environmental protection / Energy-saving tips

Programme overview

Notes on laundry

Labelling of fabrics

Drying tips

Programme overview

Notes on laundry

Programme overview

Sort the laundry according to type of textile and fabric. Fabrics must be suitable for tumble drying.

After drying, laundry is to be ...

Programmes

Programme overview

Notes on laundry

Labelling of fabrics

Drying tips

Programme overview

Environmental protection / Energy-saving tips

Programme overview

Notes on laundry

Labelling of fabrics

Drying tips

Programme overview

Environmental protection / Energy-saving tips

Programme overview

Notes on laundry

Labelling of fabrics

Drying tips

Programme overview

Programme overview

Sort the laundry according to type of textile and fabric. Fabrics must be suitable for tumble drying.

After drying, laundry is to be ...

Programmes

Programme overview

Notes on laundry

Labelling of fabrics

Drying tips

Programme overview

Environmental protection / Energy-saving tips

Programme overview

Notes on laundry

Labelling of fabrics

Drying tips

Programme overview

Environmental protection / Energy-saving tips

Programme overview

Notes on laundry

Labelling of fabrics

Drying tips

Programme overview

Programme overview

Sort the laundry according to type of textile and fabric. Fabrics must be suitable for tumble drying.

After drying, laundry is to be ...

Programmes

Programme overview

Notes on laundry

Labelling of fabrics

Drying tips

Programme overview

Environmental protection / Energy-saving tips

Programme overview

Notes on laundry

Labelling of fabrics

Drying tips

Programme overview

Environmental protection / Energy-saving tips

Programme overview

Notes on laundry

Labelling of fabrics

Drying tips

Programme overview

Programme overview

Sort the laundry according to type of textile and fabric. Fabrics must be suitable for tumble drying.

After drying, laundry is to be ...

Programmes

Programme overview

Notes on laundry

Labelling of fabrics

Drying tips

Programme overview

Environmental protection / Energy-saving tips

Programme overview

Notes on laundry

Labelling of fabrics

Drying tips

Programme overview

Environmental protection / Energy-saving tips

Programme overview

Notes on laundry

Labelling of fabrics

Drying tips

Programme overview

Care and cleaning Only when switched off!

Dryer housing, control panel

- Wipe clean with a soft, damp cloth.
- Do not clean with a water jet.
- Remove detergent and cleaning agent residue immediately.
- During drying, water may occasionally accumulate between the window and the seal. This does not affect the proper operation of your dryer.

Heat exchanger

The heat exchanger requires cleaning once a month, however this varies depending on how frequently the dryer is used. Allow the dryer to cool down and place an absorbent cloth under the maintenance flap. Residual water may escape.

- Unlock the maintenance flap and open completely.
- Turn both locking levers towards each other.
- Pull out the cap.
- Remove the heat exchanger.

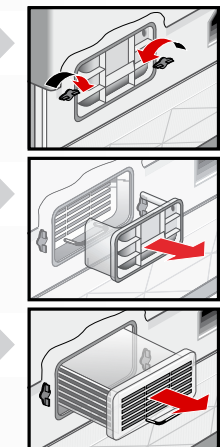

 Take care not to damage the heat exchanger. When cleaning, use water only. Do not use hard or sharp-edged objects.

- Rinse the heat exchanger and the cap on all sides with a jet of water to completely remove all of the fluff.
- Remove any fluff from the seals on the dryer and heat exchanger.
- Allow to drip dry fully.
- First insert the heat exchanger, then the cap.
- Turn back both locking levers and close the maintenance flap until it locks closed.

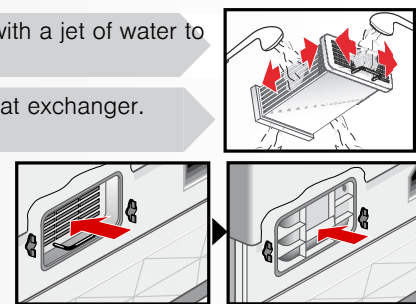

Moisture sensors

The dryer is equipped with stainless steel moisture sensors. Moisture sensors measure the moisture level of the laundry. After sustained, repeated operation, a fine layer of limescale may form on the moisture sensors.

- Open the door.
 - Clean the moisture sensors with a damp sponge which has a rough surface.
-  Do not use steel wool or abrasive agents!

Installation

- Scope of delivery: dryer, operating and installation instructions, basket for woollens (depending on the model).
- Check the dryer for transport damage.
- The dryer is very heavy. Do not attempt to lift it on your own.
- Be careful to avoid sharp edges.
- Do not lift the dryer by protruding parts (e.g. the door) - risk of breakage.
- Do not set up in a room that is susceptible to frost.
- Freezing water may cause damage.
- If in doubt, have the appliance connected by a specialist.

- Setting up the dryer**
 - The mains plug must always be accessible.
 - Ensure that the appliance is placed on a clean, level and firm surface.
 - Do not obstruct the air inlet on the dryer.
 - Keep the area around the dryer clean.
 - Level the dryer using the threaded feet and a spirit level.
 - Never remove the threaded feet!

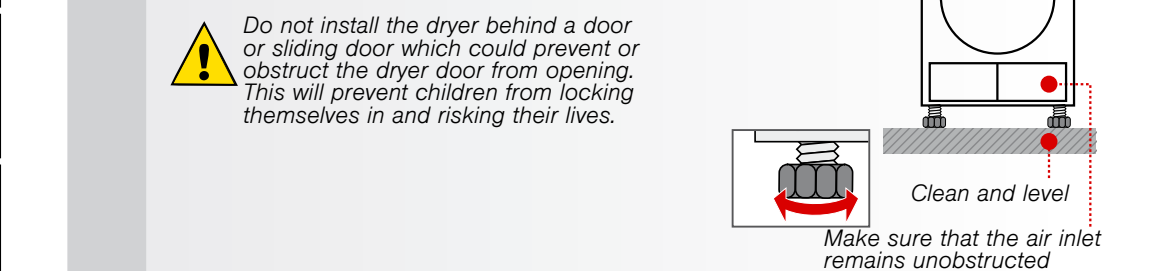

- For mains connection, see Safety instructions → page 13.**
 - Connect to an AC earthed socket. If in doubt have the socket checked by a specialist.
 - The mains voltage and the voltage shown on the rating plate (→ page 10) must be the same.
 - The connected load and necessary fuse protection are specified on the rating plate.

- Converting the installed load** Note the fuse protection of the socket (10/16 Amps.).
 - Turn the programme selector to **Off**.
 - Press and hold the **Fine adjust** button.
 - Turn the programme selector to **Cottons** **Cupboard Dry Plus**; wait until the recent setting appears in the display: $L/D=10A$ or $H/I=16A$.
 - Press the **Fine adjust** button to change the settings.
 - Turn the programme selector to **Off**.



Frost protection / Transport Do not operate the dryer if there is a risk of frost.

- Preparation**
- Empty the condensate container → page 4/11.
 - Select any programme using the programme selector.
 - Press the **Start/Pause** button → condensation is pumped into the container.
 - Wait several minutes or until the dryer stops, and then empty the condensate container again.
 - Turn the programme selector to **Off**.

Optional accessories (order from the after-sales service using the order number, depending on the model)

- WMZ 20500 Platform**
For easier loading and unloading. The basket contained in the drawer can be used to carry the laundry.
- WMZ 20600 Woollens basket**
For drying individual wollen fabrics, sports shoes and soft toys (see separate instructions for "Woollens basket").
- WTZ 20410 Washer-dryer stack connection set**
The dryer can be placed on top of a suitable washing machine with the same width and depth to save space. The dryer **must** be fastened to the washing machine using this connection set. WTZ 11400: with pull-out worktop.
- WTZ 1110 Connection fittings for condensation outlet**
The condensation is conveyed directly via a hose.

Technical data

- Dimensions (DxWxH)** 60 x 60 x 85 cm (height adjustable)
 - Weight** approx. 45 kg
 - Max. capacity** 8 kg
 - Condensate container** 4.2 l
 - Connection voltage** 220-240 V
 - Connected load** 2100-2800 W
 - Fuse protection** 16 A/10 A
 - Ambient temperature** 5-35°C
 - Product number** Inside of door
 - Production number** Inside of door
 - Drum interior light** (depending on model): The drum lights up after the door is opened and after the programme starts, and switches off automatically.
- The rating plate can be found on the back of the dryer.

Consumption rates (The value on the label is achieved at the maximum heat setting.)

Fabrics/programmes	Residual moisture in the fabrics after spinning	Drying time**		Energy consumption**	
		10 A	16 A	10 A	16 A
Cottons 8 kg	1400 U/min (50%)	140 min	108 min	3.84 kWh	3.84 kWh
	1000 U/min (60%)	158 min	126 min	4.61 kWh	4.61 kWh
	800 U/min (70%)	176 min	144 min	5.31 kWh	5.31 kWh
Iron Dry*	1400 U/min (50%)	116 min	86 min	2.30 kWh	2.30 kWh
	1000 U/min (60%)	135 min	103 min	3.53 kWh	3.53 kWh
	800 U/min (70%)	153 min	121 min	3.96 kWh	3.96 kWh
Easy-Care 3.5 kg	800 U/min (40%)	52 min	46 min	1.42 kWh	1.42 kWh
	600 U/min (50%)	65 min	56 min	1.74 kWh	1.74 kWh

* Programme setting for testing in accordance with applicable standard DIN EN61121.
** The values may differ from those specified, depending on the type of fabric, composition of laundry to be dried, residual moisture in the fabric, the degree of dryness that has been set and the amount of laundry being loaded.

Fabrics/programmes	Drying time	Annual energy consumption
Cottons 8 kg / 4 kg*		
Cupboard Dry***	97 min / cycle	561 kWh / year

*** Programme setting for testing and energy labelling in accordance with Directive 2010/30/EU.

After-sales service

If you cannot rectify the fault yourself (e.g. switching off/on) → *What to do if...*, page 11/12, please contact our after-sales service. We will always find an appropriate solution and avoid unnecessary visits by engineers.

The contact details of your local **after-sales service** can be found in the enclosed after-sales service directory.

Please provide the after-sales service the product number (E no.) and the production number (FD) of the appliance.

E-Nr. _____ FD _____

Product number Production number

You can find this information: inside the door* / in the opened service flap* and on the rear of the appliance. *depending on the model

Trust the expertise of the manufacturer. Contact us for assistance. In this way, you can rest assured that the repair will be carried out by trained service technicians using original spare parts.

What to do if ...

- Turn the programme selector to **Off** and remove the mains plug from the socket.
- The **Start/Pause** indicator light does not light up. Mains plug plugged in? Programme selected? Check the socket fuse.
- The display panel light and indicator lights (depending on model) go out and the **Start/Pause** indicator light flashes. Energy-saving mode is activated → see the separate *Energy-saving mode* instructions.
- The display panel switches off. The appliance goes into the sleep mode after activating **Finished in** option → page 5.
- The **(Condensate container)** indicator light flashes. Empty the condensate container → page 4. Press the **Start/Pause** button to reset the displayed indication and then press the **Start/Pause** button again to restart the appliance if necessary. If featured, check the hose for condensation outlet.
- (Fluff filter/Heat exchanger)** indicator light flashes. Clean the fluff filter → page 4. Press the **Start/Pause** button to reset the displayed indication and then press the **Start/Pause** button again to restart the appliance if necessary. Clean the heat exchanger → page 8.
- Dryer does not start. **Start/Pause** button selected? Door closed? Programme set?

What to do if ...

- Programme terminates shortly after starting. Ambient temperature greater than 5°C? Is the appliance loaded with the laundry? Load too small for selected programme?/Use timed programme → page 6/7. Loaded laundry dry?
- Water is leaking out. Make sure the dryer is level. Clean the heat exchanger seal.
- The door opens by itself. Push the door closed until you hear it engage.
- Creasing. Laundry load exceeded? Remove articles of clothing immediately after the end of the programme, hang up and pull into shape. Unsuitable programme selected → page 7.
- Laundry is not dried correctly or is still too damp. After the end of the programme, warm laundry feels damper than it actually is. Spread the laundry out and allow the heat to disperse. Finely adjust the dryness level – this extends the drying time but does not increase the temperature. Your laundry will become drier. Select a programme with a longer drying time or increase the drying level. This does not increase the temperature. Select a time programme for extended drying of laundry that is still damp. If you have exceeded the maximum load for the programme, the laundry may not be dried correctly. Clean the moisture sensor in the drum. A fine layer of limescale may adversely affect the performance of the sensors and your washing will not dry properly. Drying has been interrupted as a result of a power cut, because the condensate container is full or because the maximum drying time has been exceeded. Select a programme with a longer drying time or increase the drying level. This does not increase the temperature. Select a time programme for extended drying of laundry that is still damp. If you have exceeded the maximum load for the programme, the laundry may not be dried correctly. Clean the moisture sensor in the drum. A fine layer of limescale may adversely affect the performance of the sensors and your washing will not dry properly. Drying has been interrupted as a result of a power cut, because the condensate container is full or because the maximum drying time has been exceeded. Clean the fluff filter under running water → page 4/11. Insufficient supply of air → Ensure that air can circulate. Air inlet possibly blocked → Clear inlet → page 9. Ambient temperature higher than 35°C → Ventilate the room.
- Drying time too long. Clean the fluff filter under running water → page 4/11. Insufficient supply of air → Ensure that air can circulate. Air inlet possibly blocked → Clear inlet → page 9. Ambient temperature higher than 35°C → Ventilate the room.
- One or more indicator lights are flashing. Clean the fluff filter and heat exchanger → page 4,8/11. Check the installation conditions → page 9. Switch off, allow to cool, switch back on and restart the programme.
- Power failure. Remove the laundry from the dryer immediately and spread out. This allows the heat to dissipate. Be careful as the door, the drum and the laundry may be hot.

Safety instructions

- Emergency ONLY use the dryer...** Pull the appliance plug out of the socket immediately or disconnect the fuse. – in rooms inside the house. – to dry fabrics.
- The dryer must NEVER...** be used for purposes other than those described above. – be modified in terms of its technology or properties.
- Hazards** – The dryer must not be used by children or persons who have not been instructed in its use. – Do not leave children unsupervised near the dryer. – Keep pets away from the dryer. – Remove all objects from pockets, and lighters in particular → **Risk of explosion**. – Do not lean or sit on the door → **Risk of tipping**.
- Installation** – Secure loose cables → **Risk of tripping**. – Do not operate a dryer if there is a risk of frost.
- Mains connection** – Connect the dryer to an AC earthed socket according to specifications, otherwise it cannot be guaranteed that the appliance is completely safe. – The cable cross-section must be sufficient. – Only use earth-leakage circuit breakers with the following symbol: – The appliance plug and socket must be compatible. – Do not use multiple plugs/connectors and/or extension cables. – Do not touch or hold the appliance plug with wet hands → **Risk of electric shock**. – Never pull the appliance plug out of the socket by its cable. – Do not damage the mains lead → **Risk of electric shock**.
- Operation** – Only load the drum with laundry. Check the contents before you switch the dryer on. – Do not use the dryer if the laundry has been in contact with solvents, oil, wax, grease or paint (e.g. hair styling products, nail varnish remover, stain remover, cleaning solvent, etc.) → **Risk of fire/explosion**. – The tumble dryer is not to be used if industrial chemicals have been used for cleaning. – Dust (e.g. coal dust, flour) poses a danger: Do not use the dryer → **Risk of explosion**. – Do not turn off the dryer until the drying process ends, unless the laundry will be removed quickly and spread out, so that the heat can dissipate. – Do not put laundry containing foamed material/rubber in the dryer → elastic material may be destroyed and the dryer be damaged due to possible deformation of the foamed material. – When cleaning the fluff filter, make sure that no foreign material (down or filling material) gets into the air duct opening. If necessary, clean the drum beforehand with a vacuum cleaner. If foreign material should still get into the air duct → call the after-sales service → **Risk of fire/explosion**. – Light things, such as long hair, may be sucked into the air inlet of the dryer → **Risk of injury**. – Final part of a tumble dryer cycle occurs without heat (cool down cycle), to ensure that the items are left at a temperature that ensures that the items will not be damaged. – Switch off the dryer once the programme has ended. – The exterior of the appliance's rear panel becomes very hot during operation. Never touch the hot surface of the appliance's rear panel. Keep children away from the appliance → **Risk of burns**. – The water from condensation is not drinking water and may be contaminated with fluff. 
- Defect** – Do not use the dryer if it is defective or if you suspect that it is. Repairs must only be carried out by the after-sales service. – Do not use the dryer if the mains cable is defective. To avoid danger, only have the defective mains cable replaced by the after-sales service.
- Spare parts** – For safety reasons, you must only use genuine spare parts and accessories.
- Disposal** – Pull out the appliance plug, then cut off the mains cable from the appliance. Dispose of the appliance at a municipal waste disposal site. – Packaging: Keep all packaging out of reach of babies and children → **Risk of suffocation**. – All materials are environmentally sound and can be reused. Dispose of them in an environmentally-responsible manner.



Register your new Bosch now:
www.bosch-home.com/welcome

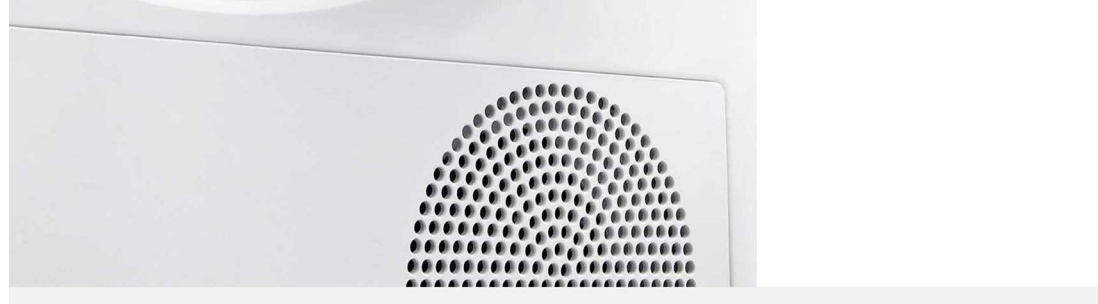

Dryer WTB86200ID 

en Instruction manual

Your new dryer

Congratulations - You have chosen a modern, high-quality Bosch domestic appliance.
The condensation dryer is distinguished by its economical energy consumption.

Every dryer which leaves our factory is carefully checked to ensure that it functions correctly and is in perfect condition.
Should you have any questions, our after-sales service will be pleased to help.

Disposal in an environmentally-responsible manner

This appliance is labelled in accordance with European Directive 2012/19/EU concerning used electrical and electronic appliances (waste electrical and electronic equipment - WEEE). The guideline determines the framework for the return and recycling of used appliances as applicable throughout the EU.















For further information about our products, accessories, spare parts and services, please visit: www.bosch-home.com

 Observe the safety instructions on page 13.

 Read these instructions and the separate **Energy-saving mode** instructions before operating the dryer.

Contents

Page

	Preparation	2
	Control panel	2
	Drying	3/4
	Display panel and settings	5
	Notes on laundry	6
	Overview of programmes	7
	Care and cleaning	8
	Installation	9
	Frost protection / Transport	9
	Optional accessories	10
	Technical data	10
	Consumption rates	10
	After-sales service	11
	What to do if ...	11/12
	Safety instructions.	13

















Intended use

- exclusively for domestic use,
- only for drying fabrics which have been washed using water.

 *Keep children younger than 3 years old away from the dryer.
Do not let children make the cleaning and maintenance work on the dryer without supervision.
Do not leave children unsupervised near the dryer.
Keep pets away from the dryer.
The dryer can be operated by children 8 years old and older, by persons with reduced physical, sensory or mental abilities and by persons with insufficient experience or knowledge if they are supervised or have been instructed in its use by a responsible adult.
This appliance is intended for use up to a maximum height of 4000 metres above sea level.*

Programmes / Fabrics

Detailed overview of the programmes and fabrics
→ Programme overview, page 7.
Observe the care instructions on the care label.

 Cottons	Hard-wearing fabrics.
 Easy-Care	Fabrics made from synthetic or blended fabrics.
Dryness levels to select with the  Cottons and  Easy-Care programmes:	
 Cupboard Dry Plus	Thick and multi-layered fabrics.
 Cupboard Dry	Single-layered laundry.
 Iron Dry	Laundry suitable for ironing after drying.
 Sportswear	Functional clothing made of microfibre.
 Allergy Plus	Cotton fabrics for drying in higher temperatures.
 Mixed Load	A mixed load of fabrics made of cotton and synthetic fabrics.
 Timed program warm	} All types of fabric; time programme.
 Timed program cold	
 Shirts 15'	Cotton or linen fabrics that are still damp and easy-care fabrics.
 Super Quick 40'	Synthetics, cotton or blended fabrics.
 Down	Fabrics with down filling.
 Wool Finish	Woollen fabrics that are suitable for use in washers.

Preparation

Installation → page 9.

 Never start
Inform you



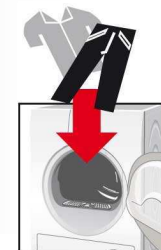

 Programme sel
the programme
on/off. Can be

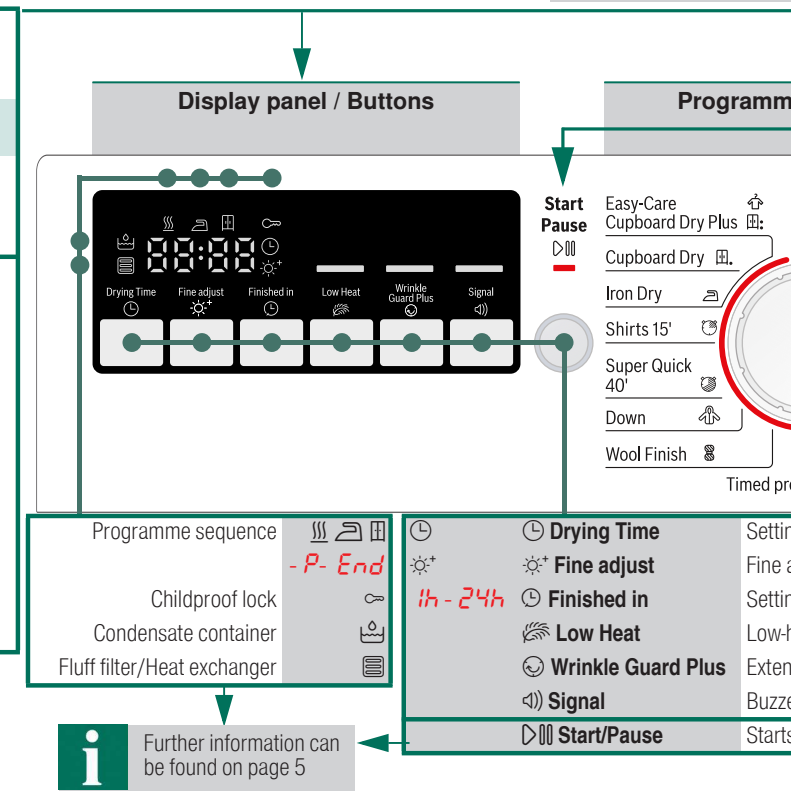

...t the dryer if it is damaged!
...r after-sales service!

Inspect the dryer



Make sure your hands are dry.
Only grasp the plug by the plug
body.

Connect the mains plug



Sort the laundry

Remove all items from pockets,
especially cigarette lighters.
The drum must be empty prior to loading.

See programme overview on page 7.
See also separate instructions for "Woollens basket"
(depending on model).

Director for setting
and switching the appliance
turned in both directions.

Set and adjust the programme individually

...e selector / Off



Close the door

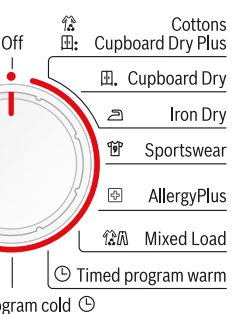

Select Start/Pause

...g the drying time available only for timed programmes.

...adjustment of dryness level.

...g the programme end.

...eat drying - reduced temperature.

...ds the anti-crease function.

...r on/off.

... pauses and continues the programme; activates or deactivates (Childproof lock).

Drying



1

2

3



7



6

5

4

Empty the condensate container

Empty the container **after each** drying cycle.

1. Remove the container, holding it level.
2. Pour out the condensate.
3. Push the container back in until it clicks into place.

If (Condensate container) flashes in the display panel → What to do if..., page 11.



Clean fluff filter

i Do not operate the dryer without a fluff filter or with a defective fluff filter. A clean fluff filter minimises energy consumption.

Clean the fluff filter **after** each drying cycle.

1. Open the door. Remove any fluff from the door/around the door and pull out the fluff filter.
2. Remove the fluff from the shaft of the fluff filter.
3. Open the fluff filter and remove the fluff (sweep your hand over the fluff filter). If the fluff filter is very dirty or blocked, rinse with warm water and dry thoroughly.
4. Close and reinsert the fluff filter.



Remove the laundry and switch off the dryer

End of the programme...

Interrupt the programme

1. Open the door or press the **Start/Pause** button; the drying cycle is interrupted.
2. Add or remove laundry and close the door.
3. If required, select a new programme and additional functions. Select the **Start/Pause** button. The remaining time is updated after a few minutes.



The drum and door may be hot!

Drying

Display panel and settings

● Display panel (status indicators)



(Fluff filter/Heat exchanger) Clean the fluff filter → page 4/11
or clean the heat exchanger → page 8.



(Condensate container) Empty the condensate container → page 4/11.



(Programme sequence) These indicators show the programme progress in the next steps of the drying cycle:

- Drying;
- Iron Dry;
- Cupboard Dry;
- P- Programme pause → if required;
- End Programme end.



(Childproof lock) You can lock the dryer to prevent the functions you have set from being changed inadvertently. To activate/deactivate (**Childproof lock**) start the programme and hold the **Start/Pause** button for 5 seconds until a long acoustic signal is heard. The option activated/deactivated → (**Childproof lock**) indicator light on/off.

[h:min]
(Remaining time)

When a programme is selected, the anticipated drying time (remaining time) for the recommended load is displayed. While drying, the moisture sensors detect the actual load and correct the programme length. This is shown by jumps in the remaining time in the display panel.

● Settings (indicators lights and buttons)



Selected option activated/deactivated → indicator light on/off.
See the separate **Energy-saving mode** instructions.

Drying Time Drying time, available only for timed programmes, can be selected from min. 0:20 h to max. 3:00 h, in 10-minute steps.

Fine adjust The dryness levels (e.g. Cupboard Dry) can be increased in three levels. The laundry is made drier. Default = 0. Selectable values: 0, 1, 2, 3. After setting the level of the fine adjustment for a programme, it is also retained for other programmes, until **Fine adjust** is changed again.

Finished in The time when the programme has to end can be set by selecting the **Finished in** time. The **Finished in** time can be selected in one-hour steps, up to a maximum of 24 hours. Select the **Finished in** button repeatedly until the required number of hours is displayed. Then press the **Start/Pause** button to activate the **Finished in** option. The programme ends after the selected number of hours. Several minutes after activating **Finished in** option the display switches off to save energy. To switch it on select any button, close/open the door or turn the programme selector.

Low Heat Reduced temperature for delicate fabrics, e.g. polyacrylic, polyamide or elastane, with a longer drying time.

Wrinkle Guard Plus After the programme finishes, the drum moves at regular intervals to prevent creases. Laundry remains loose and fluffy. The standard setting for each programme is 60 min. Automatic anti-crease function can be extended by up to 60 min.

Signal For switching the buzzer on and off. **Signal** indicates program end if it is activated. Other sounds are not influenced by this option.

Notes on laundry ...



Labelling of fabrics

Follow the manufacturer's care instructions.

- Suitable for tumble drying.
- Dry at normal temperature.
- Dry at low temperature → in addition, select **Low Heat**.
- Do not tumble dry.

Do not tumble dry the following fabrics:

- Non-breathable fabrics (e.g. rubber-coated).
- Delicate materials (silk, curtains made from synthetic material) → these may crease.
- Oil-stained laundry.



Drying tips

- To ensure a consistent drying result, sort the laundry by fabric type and drying programme.
- Always dry very small fabrics (e.g. baby socks) together with large items of laundry (e.g. towels).
- Close zips, hooks and eyelets, and button up covers. Tie cloth belts, apron strings, etc. together or use a laundry bag.
- Do not over-dry easy-care laundry → risk of creasing. Allow laundry to finish drying in the air.
- Do not dry woollens in the dryer. They may, however, be refreshed in the dryer → page 7, **Wool finish** programme (depending on model).
- Do not iron laundry immediately after drying; fold items up and leave for a while → residual moisture will then be distributed evenly.
- Knitted fabrics (e.g. T-shirts, jerseys) often shrink slightly the first time they are tumble-dried. → Do not use the **Cupboard Dry Plus** programme.
- Starched laundry is not always suitable for dryers → starch leaves behind a coating that reduces the drying effect.
- When washing laundry that is to be tumble dried afterwards, use the correct amount of fabric softener as specified in the manufacturer's instructions.
- For pre-dried, multi-layered fabrics or small, individual items of laundry, use the timed programme. Also suitable for subsequent drying.

Environmental protection / Energy-saving tips

- Before drying, spin the laundry in the washing machine → higher spin speeds minimise the drying time and reduce energy consumption.
- Use the maximum recommended capacity, but do not exceed it → Programme overview, page 7.
- Make sure the room is well ventilated during drying.
- Clean the fluff filter after every drying cycle → Clean the fluff filter, page 4/11.
- Do not cover or seal the air inlet on the dryer.

Programme overview

see also page 6.

Sort the laundry according to type of textile and fabric. Fabrics must be suitable for tumble drying.

After drying, laundry is to be ...		☑ ironed	☑ lightly ironed	☒ not ironed	🔄 mangled
PROGRAMMES					
TEXTILE TYPE AND INFORMATION					
*👤 Cottons	max. 8 kg				
*👤 Easy-Care	max. 3.5 kg	☑☑☑☑☑			
☑ Iron Dry The condition of the laundry means it is suitable for ironing (iron clothes in order to avoid creases).					
☑ Cupboard Dry Single-layered laundry.					
☑ Cupboard Dry Plus Laundry with thick, multi-layered parts.					
👤 Sportswear	max. 1.5 kg				
Fabrics with membrane coating, water-repellent fabrics, functional clothing, fleece fabrics (dry jackets/trousers with removable internal lining separately).					
☑ Allergy Plus	max. 6 kg				
☑ Mixed Load	max. 3 kg				
Mixed items of laundry made of cotton and synthetics (Mix).					
🕒 Timed program warm	max. 3 kg				
Suitable for pre-dried or slightly damp laundry and for drying off multi-layered, thick laundry. Only dry wool, sports shoes and soft toys with the basket for woollens → <i>Optional Accessories, page 10</i> .					
In the time programme, the laundry's residual moisture is not automatically detected. If the laundry is still too damp after the drying programme, repeat the programme and, if required, extend the programme length.					
🕒 Timed program cold	max. 3 kg				
All types of fabrics. For freshening up or airing of items of laundry that have been worn for a short period of time.					
👤 Shirts 15'	max. 1 kg				
For optimal drying result dry a maximum of 5 business shirts together. After drying, iron clothes or hang them out and leave for a while. The remaining moisture will be distributed evenly.					
👤 Super Quick 40'	max. 2 kg				
Laundry made of synthetic fibres, cotton or blended fabrics (for example) that needs to be dried quickly. The values may differ from the those specified depending on the type of fabric, mixture of laundry to be dried, residual moisture in the fabric and loading capacity.					
👤 Down	max. 1.5 kg				
Garments with down feather fillings, pillows and blankets. By non quilt loads - please add just 1 piece per drying.					
👤 Wool Finish	max. 3 kg				
Woolen fabrics suitable for washers. Fabrics become fluffier but not dry. Remove fabrics once the programme has ended and allow to dry.					

*Dryness levels can be selected individually → ☑☑ Cupboard Dry Plus, ☑☑ Cupboard Dry and ☑☑ Iron Dry (depending on the model).

Degree of dryness can be finely adjusted; multi-layered textiles require a longer drying time than single-layered items of clothing. Recommendation: Dry separately.

9505/ 9001117700



Robert Bosch Hausgeräte GmbH
Carl-Wery-Str. 34
81739 München/Deutschland

WTB86200ID

Care and cleaning



Only when switched off!

Dryer housing, control panel

- Wipe clean with a soft, damp cloth.
- Do not clean with a water jet.
- Remove detergent and cleaning agent residue immediately.
- During drying, water may occasionally accumulate between the window and the seal. This does not affect the proper operation of your dryer.

Heat exchanger

The heat exchanger requires cleaning once a month, however this varies depending on how frequently the dryer is used. Allow the dryer to cool down and place an absorbent cloth under the maintenance flap. Residual water may escape.

1. Unlock the maintenance flap and open completely.
2. Turn both locking levers towards each another.

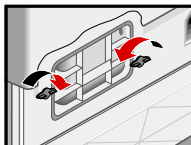

3. Pull out the cap.

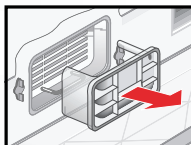

4. Remove the heat exchanger.

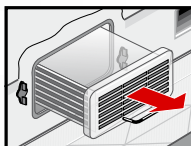

 Take care not to damage the heat exchanger. When cleaning, use water only. Do not use hard or sharp-edged objects.

5. Rinse the heat exchanger and the cap on all sides with a jet of water to completely remove all of the fluff.

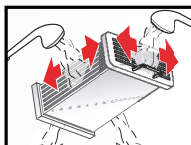

6. Remove any fluff from the seals on the dryer and heat exchanger.

7. Allow to drip dry fully.

8. First insert the heat exchanger, then the cap.

9. Turn back both locking levers and close the maintenance flap until it locks closed.

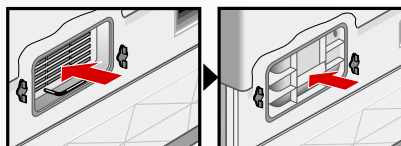

Moisture sensors

The dryer is equipped with stainless steel moisture sensors. Moisture sensors measure the moisture level of the laundry. After sustained, repeated operation, a fine layer of limescale may form on the moisture sensors.

1. Open the door.
2. Clean the moisture sensors with a damp sponge which has a rough surface.



 Do not use steel wool or abrasive agents!

Installation

- Scope of delivery: dryer, operating and installation instructions, basket for woollens (depending on the model).
- Check the dryer for transport damage.
- The dryer is very heavy. Do not attempt to lift it on your own.
- Be careful to avoid sharp edges.
- Do not lift the dryer by protruding parts (e.g. the door) - risk of breakage.
- Do not set up in a room that is susceptible to frost. Freezing water may cause damage.
- If in doubt, have the appliance connected by a specialist.

1. Setting up the dryer

- The mains plug must always be accessible.
- Ensure that the appliance is placed on a clean, level and firm surface.



Take all accessory parts out of the drum. The drum must be empty.

- Do not obstruct the air inlet on the dryer.
- Keep the area around the dryer clean.
- Level the dryer using the threaded feet and a spirit level. Never remove the threaded feet!



Do not install the dryer behind a door or sliding door which could prevent or obstruct the dryer door from opening. This will prevent children from locking themselves in and risking their lives.

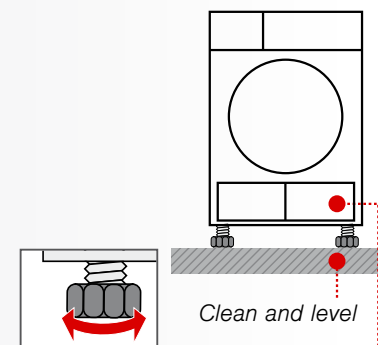





Clean and level
Make sure that the air inlet remains unobstructed

2. For mains connection, see Safety instructions → page 13.

- Connect to an AC earthed socket. If in doubt have the socket checked by a specialist.
- The mains voltage and the voltage shown on the rating plate (→ page 10) must be the same.
- The connected load and necessary fuse protection are specified on the rating plate.

3. Converting the installed load Note the fuse protection of the socket (10/16 Amps.).

1. Turn the programme selector to **Off**.
2. Press and hold the  **Fine adjust** button.
3. Turn the programme selector to  **Cottons**  **Cupboard Dry Plus**; wait until the recent setting appears in the display: **LQ=10A** or **H=16A**.
4. Press the  **Fine adjust** button to change the settings.
5. Turn the programme selector to **Off**.



Frost protection / Transport



Do not operate the dryer if there is a risk of frost.



Preparation

1. Empty the condensate container → page 4/11.
2. Select any programme using the programme selector.
3. Press the  **Start/Pause** button → condensation is pumped into the container.
4. Wait several minutes or until the dryer stops, and then empty the condensate container again.
5. Turn the programme selector to **Off**.

Optional accessories (order from the after-sales service using the order number, depending on the model)

WMZ 20500 Platform
For easier loading and unloading. The basket contained in the drawer can be used to carry the laundry.

WMZ 20600 Wollens basket
For drying individual wollen fabrics, sports shoes and soft toys (see separate instructions for "Wollens basket").

WTZ 20410 Washer-dryer stack connection set
The dryer can be placed on top of a suitable washing machine with the same width and depth to save space. The dryer **must** be fastened to the washing machine using this connection set. WTZ 11400: with pull-out worktop.

WTZ 1110 Connection fittings for condensation outlet
The condensation is conveyed directly via a hose.

Technical data

● Dimensions (DxWxH)	60 x 60 x 85 cm (height adjustable)
Weight	approx. 45 kg
Max. capacity	8 kg
Condensate container	4.2 l
Connection voltage	220-240 V
Connected load	2100-2800 W
Fuse protection	16 A/10 A
Ambient temperature	5-35°C
Product number	Inside of door
Production number	

The rating plate can be found on the back of the dryer.

- **Drum interior light** (depending on model): The drum lights up after the door is opened and after the programme starts, and switches off automatically.

Consumption rates (The value on the label is achieved at the maximum heat setting.)

Fabrics/programmes	Residual moisture in the fabrics after spinning		Drying time**		Energy consumption**	
			10 A	16 A	10 A	16 A
👤 Cottons 8 kg	1400 U/min (50%)	140 min	108 min	3.84 kWh	3.84 kWh	
	1000 U/min (60%)	158 min	126 min	4.61 kWh	4.61 kWh	
	800 U/min (70%)	176 min	144 min	5.31 kWh	5.31 kWh	
👚 Iron Dry*	1400 U/min (50%)	116 min	86 min	2.30 kWh	2.30 kWh	
	1000 U/min (60%)	135 min	103 min	3.53 kWh	3.53 kWh	
	800 U/min (70%)	153 min	121 min	3.96 kWh	3.96 kWh	
👶 Easy-Care 3.5 kg	800 U/min (40%)	52 min	46 min	1.42 kWh	1.42 kWh	
	600 U/min (50%)	65 min	56 min	1.74 kWh	1.74 kWh	

* Programme setting for testing in accordance with applicable standard DIN EN61121.

** The values may differ from those specified, depending on the type of fabric, composition of laundry to be dried, residual moisture in the fabric, the degree of dryness that has been set and the amount of laundry being loaded.

Fabrics/programmes	Drying time	Annual energy consumption
👤 Cottons 8 kg / 4 kg*		
👤 Cupboard Dry***	97 min / cycle	561 kWh / year

*** Programme setting for testing and energy labelling in accordance with Directive 2010/30/EU.

After-sales service

If you cannot rectify the fault yourself (e.g. switching off/on) → *What to do if...*, page 11/12, please contact our after-sales service. We will always find an appropriate solution and avoid unnecessary visits by engineers.

The contact details of your local **after-sales service** can be found in the enclosed after-sales service directory.

Please provide the after-sales service the product number (E no.) and the production number (FD) of the appliance.

E-Nr. _____ FD _____

Product number Production number

You can find this information:
inside the door* / in the opened service flap*
and on the rear of the appliance.
*depending on the model

Trust the expertise of the manufacturer. Contact us for assistance. In this way, you can rest assured that the repair will be carried out by trained service technicians using original spare parts.

What to do if ...



Turn the programme selector to **Off** and remove the mains plug from the socket.



- The **Start**/Pause indicator light does not light up. Mains plug plugged in? Programme selected? Check the socket fuse.
- The display panel light and indicator lights (depending on model) go out and the **Start**/Pause indicator light flashes. Energy-saving mode is activated → see the separate *Energy-saving mode* instructions.
- The display panel switches off. The appliance goes into the sleep mode after activating **Finished in** option → page 5.
- The (**Condensate container**) indicator light flashes. Empty the condensate container → page 4. Press the **Start**/Pause button to reset the displayed indication and then press the **Start**/Pause button again to restart the appliance if necessary. If featured, check the hose for condensation outlet.
- The (**Fluff filter/Heat exchanger**) indicator light flashes. Clean the fluff filter → page 4. Press the **Start**/Pause button to reset the displayed indication and then press the **Start**/Pause button again to restart the appliance if necessary. Clean the heat exchanger → page 8.
- Dryer does not start. **Start**/Pause button selected? Door closed? Programme set?

What to do if ...

● Programme terminates shortly after starting.	Ambient temperature greater than 5 °C? Is the appliance loaded with the laundry? Load too small for selected programme?/Use timed programme → <i>page 6/7</i> . Loaded laundry dry?
● Water is leaking out.	Make sure the dryer is level. Clean the heat exchanger seal.
● The door opens by itself.	Push the door closed until you hear it engage.
● Creasing.	Laundry load exceeded? Remove articles of clothing immediately after the end of the programme, hang up and pull into shape. Unsuitable programme selected → <i>page 7</i> .
● Laundry is not dried correctly or is still too damp.	After the end of the programme, warm laundry feels damper than it actually is. Spread the laundry out and allow the heat to disperse. Finely adjust the dryness level – this extends the drying time but does not increase the temperature. Your laundry will become drier. Select a programme with a longer drying time or increase the drying level. This does not increase the temperature. Select a time programme for extended drying of laundry that is still damp. If you have exceeded the maximum load for the programme, the laundry may not be dried correctly. Clean the moisture sensor in the drum. A fine layer of limescale may adversely affect the performance of the sensors and your washing will not dry properly. Drying has been interrupted as a result of a power cut, because the condensate container is full or because the maximum drying time has been exceeded.
● Drying time too long.	Clean the fluff filter under running water → <i>page 4/11</i> . Insufficient supply of air → Ensure that air can circulate. Air inlet possibly blocked → Clear inlet → <i>page 9</i> . Ambient temperature higher than 35 °C → Ventilate the room.
● One or more indicator lights are flashing.	Clean the fluff filter and heat exchanger → <i>page 4,8/11</i> . Check the installation conditions → <i>page 9</i> . Switch off, allow to cool, switch back on and restart the programme.
● Power failure.	Remove the laundry from the dryer immediately and spread out. This allows the heat to dissipate. Be careful as the door, the drum and the laundry may be hot.

Safety instructions



Emergency	– Pull the appliance plug out of the socket immediately or disconnect the fuse.
ONLY use the dryer...	– in rooms inside the house. – to dry fabrics.
The dryer must NEVER...	– be used for purposes other than those described above. – be modified in terms of its technology or properties.
Hazards	– The dryer must not be used by children or persons who have not been instructed in its use. – Do not leave children unsupervised near the dryer. – Keep pets away from the dryer. – Remove all objects from pockets, and lighters in particular → Risk of explosion . – Do not lean or sit on the door → Risk of tipping .
Installation	– Secure loose cables → Risk of tripping . – Do not operate a dryer if there is a risk of frost.
Mains connection	– Connect the dryer to an AC earthed socket according to specifications, otherwise it cannot be guaranteed that the appliance is completely safe. – The cable cross-section must be sufficient. – Only use earth-leakage circuit breakers with the following symbol:  – The appliance plug and socket must be compatible. – Do not use multiple plugs/connectors and/or extension cables. – Do not touch or hold the appliance plug with wet hands → Risk of electric shock . – Never pull the appliance plug out of the socket by its cable. – Do not damage the mains lead → Risk of electric shock .
Operation	– Only load the drum with laundry. Check the contents before you switch the dryer on. – Do not use the dryer if the laundry has been in contact with solvents, oil, wax, grease or paint (e.g. hair styling products, nail varnish remover, stain remover, cleaning solvent, etc.) → Risk of fire/explosion . – The tumble dryer is not to be used if industrial chemicals have been used for cleaning. – Dust (e.g. coal dust, flour) poses a danger: Do not use the dryer → Risk of explosion . – Do not turn off the dryer until the drying process ends, unless the laundry will be removed quickly and spread out, so that the heat can dissipate. – Do not put laundry containing foamed material/rubber in the dryer → elastic material may be destroyed and the dryer be damaged due to possible deformation of the foamed material. – When cleaning the fluff filter, make sure that no foreign material (down or filling material) gets into the air duct opening. If necessary, clean the drum beforehand with a vacuum cleaner. If foreign material should still get into the air duct → call the after-sales service → Risk of fire/explosion . – Light things, such as long hair, may be sucked into the air inlet of the dryer → Risk of injury . – Final part of a tumble dryer cycle occurs without heat (cool down cycle), to ensure that the items are left at a temperature that ensures that the items will not be damaged. – Switch off the dryer once the programme has ended. – The exterior of the appliance's rear panel becomes very hot during operation. Never touch the hot surface of the appliance's rear panel. Keep children away from the appliance → Risk of burns .  – The water from condensation is not drinking water and may be contaminated with fluff.
Defect	– Do not use the dryer if it is defective or if you suspect that it is. Repairs must only be carried out by the after-sales service. – Do not use the dryer if the mains cable is defective. To avoid danger, only have the defective mains cable replaced by the after-sales service.
Spare parts	– For safety reasons, you must only use genuine spare parts and accessories.
Disposal	– Pull out the appliance plug, then cut off the mains cable from the appliance. Dispose of the appliance at a municipal waste disposal site. – Packaging: Keep all packaging out of reach of babies and children → Risk of suffocation . – All materials are environmentally sound and can be reused. Dispose of them in an environmentally-responsible manner.



Register your new Bosch now:
www.bosch-home.com/welcome



Dryer
WTB86200ID



en Instruction manual