



Sensixx B22L

Operating instructions



BOSCH

Index		Page
	General safety instructions	4
1	Description	6
2	Preparations	7
3	Setting the temperature	8
4	Ironing with steam	8
5	“PulseSteam” function	9
6	“Intelligent steam” function	9
7	Ironing without steam	9
8	Vertical steam	9
9	Energy saving button	10
10	Auto shut-off	10
11	Fabric protection soleplate cover	10
12	Calc’n’Clean Advanced	10
13	Rinsing the iron steam chamber	11
14	Cleaning & Maintenance	12
15	Storing the appliance	13
16	Tips to help you save energy	13
17	Advice on disposal	13
18	Guarantee conditions	13
19	Trouble shooting	14

Thank you for buying the Sensixx B22L steam station, the new steam-ironing system from Bosch. Carefully read through the operating instructions for the appliance and safeguard them for future reference.

Introduction

These instructions for use contain valuable information about the unique features of this system and some hints to make ironing easier for you. We hope that you enjoy ironing with this steam station.

Important

Carefully read through the operating instructions for the appliance and safeguard them for future reference. Open out the first page of the booklet, this will help you to understand how the appliance works.

This appliance complies with international safety standards.

This appliance has been designed exclusively for domestic use and must not be used for industrial purposes.

This appliance must be used only for the purposes for which it was designed, i.e. as an iron. Any other use will be considered improper and consequently dangerous. The manufacturer will not be held responsible for any damage arising from misuse or improper use.

General safety instructions

- The iron must not be left unattended while it is connected to the supply mains.
- Remove the plug from the socket before filling the appliance with water or before pouring out the remaining water after use.
- The appliance must be used and placed on a stable surface.
- When placed on its stand, make sure that the surface on which the stand is placed is stable.
- The iron should not be used if it has been dropped, if there are visible signs of damage or if it is leaking water. It must be checked by an authorized Technical Service Centre before it can be used again.
- With the aim of avoiding dangerous situations, any work or repair that the appliance may need, e.g. replacing a

faulty mains cable, must only be carried out by qualified personnel from an Authorised Technical Service Centre.

- This appliance can be used by children aged from 8 years and above and persons with reduced physical, sensory or mental capabilities or lack of experience and knowledge if they have been given supervision or instruction concerning use of the appliance in a safe way and understand the hazards involved. Children shall not play with the appliance. Cleaning and user maintenance shall not be made by children without supervision.
- Keep the iron and its cord out of reach of children less than 8 years of age when it is energized or cooling down.



CAUTION. Hot surface.

Surface is liable to get hot during use.

- This appliance is to be connected and used in accordance with the information stated on its characteristics plate.
- This appliance must be connected to an earthed socket. If it is absolutely necessary to use an extension cable, make sure that it is suitable for 16A and has a socket with an earth connection.
- If the safety fuse fitted in the appliance blows, the appliance will be rendered inoperative. To restore normal operation the appliance will have to be taken to an authorised Technical Service Centre.
- In order to avoid that, under unfavourable mains conditions, phenomena like transient voltage drops or lighting fluctuations can happen, it is recommended that the iron is connected to a power supply system with a maximum impedance of 0.27Ω. If necessary, the user can ask the public power supply company for the system impedance at the interface point.
- The appliance must never be placed directly under the tap to fill the water tank.
- Unplug the appliance from the mains supply after each use, or if a fault is suspected.
- The electrical plug must not be removed from the socket by pulling the cable.
- Never immerse the iron in water or any other fluid.
- Do not leave the appliance exposed to weather conditions (rain, sun, frost, etc.).

1 Description

1. Water tank
2. Removable iron pad
3. Steam hose storage fixing
4. "Calc'n'Clean Advanced" scale collector
5. Mains cable storage compartment
6. Mains cable
7. Steam hose
8. "Energy Saving" button *
9. "Steam ready" / "Auto shut-off**" indicator lamp
10. "on / off" indicator lamp *
11. Variable steam control *
12. "Refill water tank" / "Clean warning" indicator lamp*
13. Main power switch (O/I)
14. Iron fixation system "SecureLock"
15. Housing with internal steam generator
16. Temperature selector
17. Steam release button
18. Steam shot button "Ultimate" *
19. Iron indicator lamp
20. Soleplate
21. Fabric-protection soleplate cover*.
* **Model dependent**

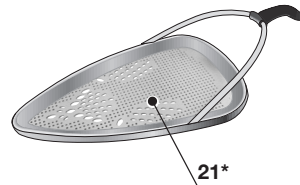
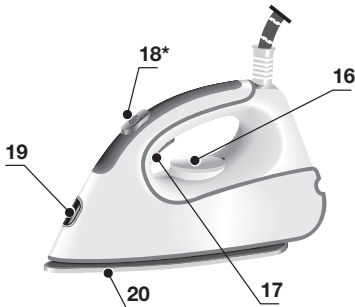
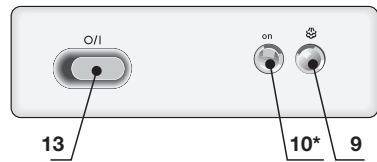
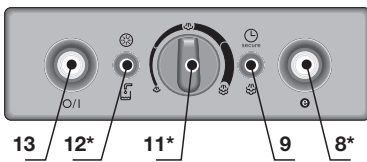
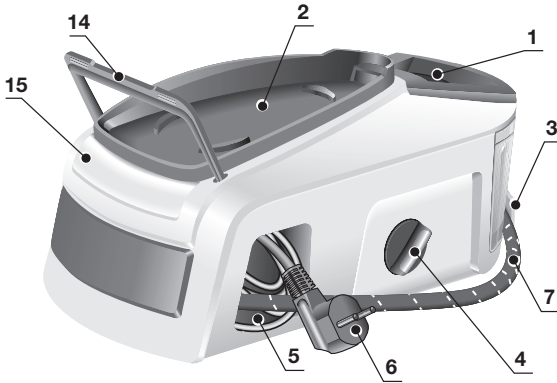

2 Preparations



1. Release the iron from its lock system (14) by pulling the lever located at the heel of the iron backwards.
2. Remove any label or protective covering from the soleplate.
3. Place the appliance horizontally on a solid, stable surface. You may remove the iron pad from the appliance and place the iron on it on another solid, stable, horizontal surface.
4. Fill the water tank, making sure not to pass the level mark.
5. Unwind the mains cable (6) fully and plug it into an earthed socket.
6. Set the main power switch (13) to the on position.
7. The “Steam ready” indicator lamp (9) will light up after several minutes, indicating that the appliance is ready to use.

The steam generator will take more time to reach “Steam ready” state only upon the initial heating up, or after performing the de-scaling operation (Calc’n’Clean).

When water is already present in the steam generator during regular use, heat up time to reach the operating temperature will be faster.

8. This appliance has a built-in water level sensor. The “refill water tank” indicator lamp (12*) will light when the water tank is empty.

or (model dependent):

If the “steam ready” indicator lamp (9) lights and steam is not released when pressing the steam release button (17-18*), refill the water tank.



Important:

- Normal tap water can be used. To prolong the optimum steam function, mix tap water with distilled water 1:1. If the tap water in your district is very hard, mix tap water with distilled water 1:2. You can inquire about the water hardness with your local water supplier.
- The water tank can be filled at any time while using the appliance.
- To avoid damage and/or contamination of the water tank and the boiler, do not put perfume, vinegar, starch, descaling agents, additives or any other type of chemical product into the water tank.
Any damage caused by the use of the aforementioned products, will make the guarantee void.
- Do not use condensation water from tumble dryers, air conditioning systems or similar. This appliance has been designed to use normal tap water.

- The iron is not designed to rest on its heel. Please always position it horizontally on the iron pad (2).
- The iron pad can be placed into the specially designed recess on the appliance or somewhere suitable alongside the ironing area.

Never rest the iron on the appliance without the iron pad!.

- During its first use the iron may produce certain vapours and odours, along with white particles on the soleplate, this is normal and it will stop after a few minutes
- While the steam release button is pressed, the water tank may produce a pumping sound, this is normal, indicating that water is being pumped to the steam tank.

3 Setting the temperature



1. Check the ironing instruction label on the garment to determine the correct ironing temperature.
2. Turn the temperature selector (16) to the required setting:

- Synthetics
- Silk – Wool
- Cotton – Linen

3. The indicator lamp (19) will remain lit while the iron is heating and go out as soon as the iron has reached the selected temperature.

Tips:

- Sort your garments out based on their cleaning symbol labels, always starting with clothes that have to be ironed at the lowest temperatures.
- If you are not sure what the garment is made of then begin ironing at a low temperature and decide on the correct temperature by ironing a small section not usually seen when worn.

4 Ironing with steam



The steam control is used to adjust the amount of steam produced when ironing.

1. Turn the temperature selector (16) to the required setting.

2. Model dependent:

Set the amount of steam to suit your needs, using the variable steam control (11*).

For normal use, please choose one of the following recommended settings:

Temperature	Steam setting
•	
••	
•••	

3. Press the steam (17-18*) release button to release steam.

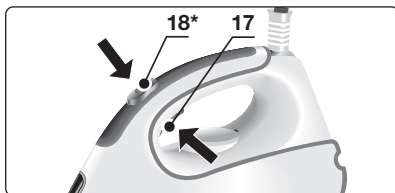
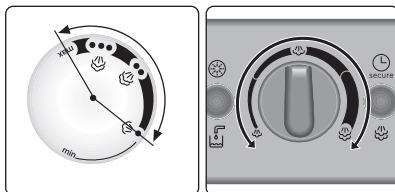

Attention:

When ironing on a lower temperature setting “•”.

- If the appliance has variable steam control (11*), set the variable steam control to its lowest position .
- If the appliance does not have variable steam control, press the steam release button only for a few seconds at a time when ironing at lower temperatures.

In both cases, if you find that water is dripping out of the soleplate, set the temperature selector (16) to a higher position (**take care that the garment can be ironed on this heat temperature setting**).

- At the beginning of each use, it is possible that drops of water will be dispensed alongside steam. Therefore, it is advisable to try the iron on the ironing board or a piece of cloth to start with.

Tip : for better ironing results, iron the last strokes without steam to dry the garment.

5

“PulseSteam” function



This appliance has a special function for tackling difficult creases.

The “PulseSteam” function helps soften stubborn garments like jeans or linen faster.

When the steam release button is activated, the steam generator will release three powerful shots of steam so that the steam reaches even deeper into the fabrics.

1. Set the temperature selector (16) on “...”
2. Briefly press the steam shot button (18*) on the top of the handle.

or (model dependent)

Press the steam release button (17) on the bottom of the handle two times in quick succession (double-click).

Remarks:

- It is possible to stop the shots of steam by quickly pressing the steam button again.
- Some water drops may appear when you use the “PulseSteam” function for the first time.

The water drops will disappear after you have used the function for some time.

6

“Intelligent steam” function

(model dependent)

This system has intelligent steam control, which, after releasing the steam release button (17), provides a small amount of additional steam.

The additional steam can always be stopped by briefly pressing the steam release button once again.

7

Ironing without steam



Begin ironing but without pressing the steam release button.

8

Vertical steam



This can be used to remove creases from hanging clothes, curtains etc.

Warning!:

- **Never direct the steam jet at garments that are being worn.**
- **Never aim the steam at people or animals.**

1. Set the temperature control knob to at least the “...” position.
2. Hold the iron in an upright position 15 cm away from the garment being steamed.
3. You can steam iron curtains and hanging garments (jackets, suits, coats...) by placing the iron in a vertical position and pressing the steam release button (17-18*).

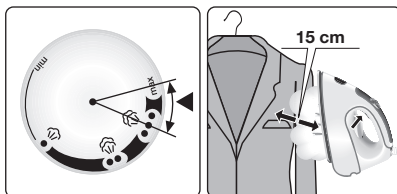

9

Energy saving button



(model dependent)

If the “Energy saving” button (8*) is switched on, you can save up to 25% of the energy and 40% of the water consumption (*), and still achieve good results when ironing most of your garments.

It is advisable to use the normal energy setting only for thick and very wrinkled fabrics.

(* In comparison to the maximum setting.

Note: If you work with the “Energy saving” function, the variable steam regulation and temperature regulation can still be used as recommended.

10

Auto shut-off



(model dependent)

If during ironing, the steam release button (17-18*) on the iron handle is not pressed for a certain length of time (8 minutes), the steam station will automatically switch off.

The “auto shut-off” indicator lamp (9) will flash when auto shut-off has been activated.

To switch the steam station back on, press the steam release button again.

11

Fabric protection soleplate cover



(model dependent)

The fabric-protection soleplate cover (21*) is used for steam-ironing delicate garments at maximum temperature without damaging them. Use of the soleplate cover also does away with the need for a cloth to prevent shine on dark materials.

It is advisable to first iron a small section on the inside of the garment to see if it is suitable.

To attach the soleplate cover to the iron, place the tip of the iron into the end of the soleplate cover and pull the elastic strap over the lower rear of the iron until it fits tightly. To release the soleplate cover, pull the elastic strap and remove the iron.

The fabric-protection soleplate cover may be purchased from our customer service or from our website.

Accessory code (After-sales)	Name of accessory (online shop)
571510	TDZ2045

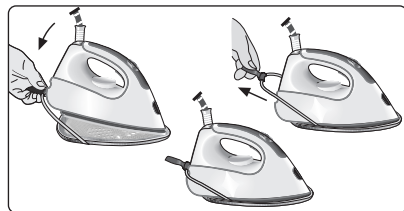

12

Calc'n'Clean Advanced



Cleaning the Boiler

To extend the life of your steam generator and to prevent any build up of scale, it is essential that you rinse out the scale collector (4) and the boiler after several hours of use. If the water is hard, increase the frequency.

Do not use descaling agents for rinsing out the boiler, as they could damage it.

Automatic clean warning

Indicator lamp (12*) will flash indicating that boiler must be rinsed.

1. Check carefully that the appliance is cold and unplugged for more than 2 hours, and that the water tank (1) is empty.
2. Fix the iron to the stand by inserting the tip of the iron into the front slot and moving the fixation lever (14) against the heel of the iron.

3. Place your appliance over a sink or bucket.
4. Lean the appliance on the opposite side of the filter opening.
5. Unscrew the scale collector (4) and take it out.
6. **(model dependent)**

To wash the filter, you may:

- a. Place the filter under the water tap and wash it up until calc residues are removed. Squeeze the filter as indicated in the picture E.
- b. Immerse the filter in tap water (250 ml) mixed with a measure (25 ml) of descaling fluid.

The descaling fluid can be obtained from our After-sales service or from our website.

Accessory code (After-sales)	Name of accessory (Online shop)
311144	TDZ1101

7. Holding your steam generator in the lateral position and using a jug, fill the boiler with 1/4 litre of water and replace the filter.
8. Shake the base unit for a few moments, unscrew the filter again and empty the boiler completely over a sink or bucket.

For best results, we recommend that this operation is performed twice.

Important: before re-closing, make sure no water remains in the boiler.

9. Replace and tighten up the filter.

To reset the “Calc’n’Clean” counter, switch the steam station off twice, keeping it off for at least 30 seconds each time.

(on → 30s off → on → 30s off → on)

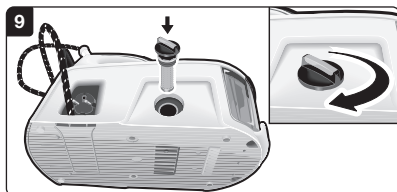
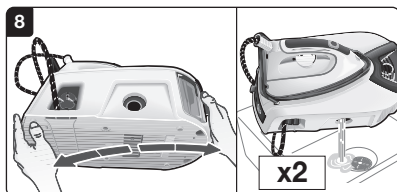
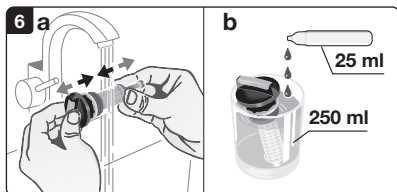
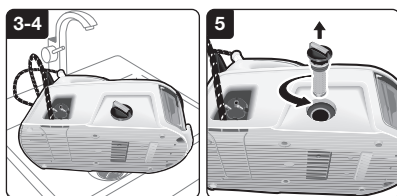
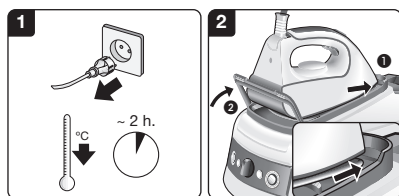

13 Rinsing the iron steam chamber

⚠ Caution! Risk of burns!

This procedure helps to remove scale particles out of the steam chamber.

This cleaning procedure may be performed occasionally (approximately once a year), when after a long period of use with very hard water, scale particles start to come out of the soleplate.

- a) Ensure that the iron is cooled down.
- b) Set the temperature selector (16) of the iron to the “min” position.
- c) Fill the tank with tap water.
- d) Plug in the mains cable and set the main power switch (13) to the “I” position.
- e) Wait until the “steam ready” indicator lamp (9) lights up.
- f) If the steam station has variable steam control (11*), set it to the maximum position .
- g) Hold the iron over the sink or a container to collect the water.
- h) Press the steam release button (17) and gently shake the iron. Boiling water and steam will come out, carrying scale and or deposits that might be there. This could take approximately 5 minutes.
- i) Set the temperature selector (16) of the iron to the “max” position, without pressing the steam release button (17). The water in the steam chamber will start evaporating. Wait until all the water inside the chamber has been evaporated.
- j) To clean the soleplate, immediately rub off any residue by running the hot iron over dry cotton cloth.

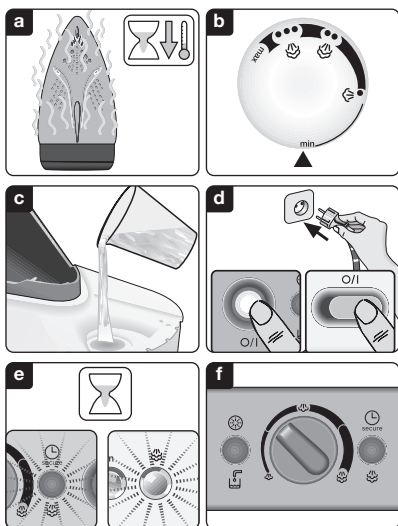
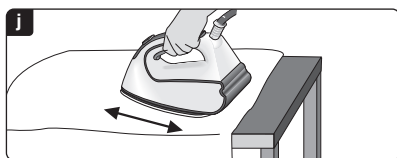
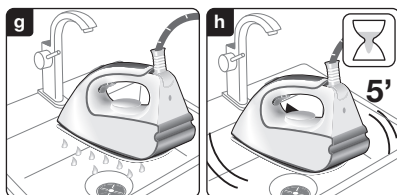

14 Cleaning & Maintenance

Attention! Risk of burns!

Always unplug the appliance from the mains supply before carrying out any cleaning or maintenance operation on it.

1. After ironing, pull out the plug and allow the appliance to cool down before cleaning.
2. Wipe the housing, handle and iron body with a damp cotton cloth.
3. If the soleplate is soiled with dirt or scale, clean it with a damp cotton cloth.
4. If the cloth is synthetic, it may melt due to the high temperature on the soleplate (20). Switch off the steam and rub off any residue immediately with a thickly folded, dry cotton cloth.
5. Never use abrasive products or solvents. To keep the soleplate (20) smooth, you should avoid hard contact with metal objects. Never use a scouring pad, or chemicals to clean the soleplate.

15 Storing the appliance



1. Always allow the appliance to cool down before storing it.
2. Set the main power button to the "0" position (the red light will go off) and disconnect the mains cable.
3. Empty the water tank.
4. Place the iron on the iron pad (2), standing on the soleplate, and fix it by inserting the tip of the iron into the front slot and moving the lock lever (14) against the heel of the iron.
5. Store the mains cable in the storage compartment (5) and the steam hose in the storage fixing (3). Do not wrap the cords too tight.
6. Use the iron's handle when moving the appliance, as shown in figure below.

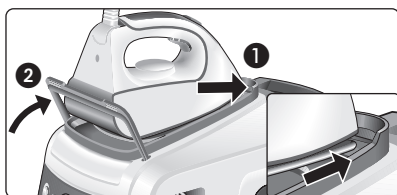

16 Tips to help you save energy



Steam production consumes the most energy. To help minimise the energy used, follow the advice below:

- Start by ironing the fabrics that require the lowest ironing temperature.
Check the recommended ironing temperature in the label on the garment.

- Regulate the steam according to the selected ironing temperature, following the instructions in this manual.
- Try to Iron the fabrics while they are still damp and reduce the steam setting. Steam will be generated from the fabrics rather than the iron. If you tumble dry your fabrics before ironing them, set the tumble drier on the 'iron dry' programme.
- If the fabrics are damp enough, turn off the steam regulator completely.

17 Advice on disposal

Our goods come in optimised packaging. This basically consists in using non-contaminating materials which should be handed over to the local waste disposal service as secondary raw materials. Your local town council can give you information about how to dispose of obsolete appliances.



This appliance is labelled in accordance with European Directive 2012/19/EU concerning used electrical and electronic appliances

(waste electrical and electronic equipment - WEEE).

The guideline determines the framework for the return and recycling of used appliances as applicable throughout the EU.

18 Guarantee conditions

The terms of the guarantee for this appliance are in accordance with that stated by our representative for the country in which it is sold.

The details of these conditions can be obtained from the retailer from whom the appliance was purchased. The purchase receipt must be presented when making any claims against the terms of this guarantee.

19 Trouble shooting

Problem	Possible causes	Solution
Indicator lamp (12*) flashes	Boiler and filter must be rinsed.	Rinse the filter and the boiler according to the cleaning instructions in this manual (see section 12).
The steam generator does not come on.	<ul style="list-style-type: none"> • There is a connection problem. • The main power switch is not switched on. 	<ul style="list-style-type: none"> • Check the mains cable (6), the plug and the socket. • Set the main power switch (13) to the "I" position.
The iron does not heat up.	<ul style="list-style-type: none"> • The main power switch is not switched on. • The temperature is set to a low position. 	<ul style="list-style-type: none"> • Set the main power switch (13) to the "I" position. • Set the temperature to the desired position.
The iron begins to smoke when switched on.	<ul style="list-style-type: none"> • During first use: certain components on the appliance have been lightly greased at the factory and may produce a little smoke when initially heated. • During subsequent use: the soleplate may be soiled. 	<ul style="list-style-type: none"> • This is completely normal and will stop after a short while. • Clean the soleplate according to the cleaning instructions in this manual.
Water flows through the holes on the soleplate.	<ul style="list-style-type: none"> • The steam function is being used before it has reached the correct temperature. • The water is condensing inside the pipes because steam is being used for the first time or has not been used for a long time. • The steam generator contains too much scale. 	<ul style="list-style-type: none"> • Reduce the steam flow when ironing at low temperatures. • Point the iron away from the ironing area and press the steam release button until steam is produced. • Clean the boiler as described in section "Calc'n'Clean Advanced".
Dirt comes out through the soleplate.	<ul style="list-style-type: none"> • There is a build up of scale or minerals in the steam tank. • Chemical products or additives have been used. 	<ul style="list-style-type: none"> • Use tap water mixed 50% with distilled or demineralised water. To prolong the optimum steam function, mix tap water with distilled water 1:1. If the tap water in your district is very hard, mix tap water with distilled water 1:2. • Clean the soleplate with a damp cloth. • Never add products to the water.

Problem	Possible causes	Solution
The iron does not produce any steam.	<ul style="list-style-type: none"> The boiler is not switched on or the water tank is empty. The steam regulation is set to the minimum position. 	<ul style="list-style-type: none"> Set the main power switch (13) to the "I" position, and/or fill the water tank. Increase the steam flow (see section 4).
The ironed garment turns dark and/or sticks to the soleplate.	<ul style="list-style-type: none"> The selected temperature is too high and has damaged the garment. 	<ul style="list-style-type: none"> Select a suitable temperature for the material being ironed and clean the soleplate with a damp cloth.
The soleplate turns brown.	<ul style="list-style-type: none"> This is a regular consequence of continued use over a long period of time. 	<ul style="list-style-type: none"> Clean the soleplate with a damp cloth.
The appliance makes a pumping sound.	<ul style="list-style-type: none"> Water is being pumped into the steam tank. The sound will not stop. 	<ul style="list-style-type: none"> This is normal. If the sound will not stop, do not use the steam generator and contact an authorised technical service centre.
Loss of pressure during ironing.	Steam release button has been activated for too long a period of time, that is, it has been pressed too frequently.	Use the steam release button at intervals. This improves the ironing result as the textiles will be steamed, dried and ironed properly.
Water spots appear on the garment during ironing.	May be caused by steam condensed on the ironing board.	Wipe the textile cover of the ironing board, and iron any water drops to dry them.
Water spots appear on the garment during use of the "PulseSteam" function.	Water spots are caused by steam condensation in the hose when cooling down after use.	Water drops stop coming out of the soleplate after using the "PulseSteam" function for some time.
The hose gets hot during use.	This is normal. It is caused by the steam passing through the hose during steam ironing.	Place the hose on the opposite side so that you cannot touch the hose during ironing.
Water leakage from the boiler.	The scale collector (4) located at the side of the appliance is loose.	Tighten up the filter.
The iron does not stop steaming after placing it on the pad (2).	"PulseSteam" function has been activated by double click.	Just press the trigger once again and the iron will stop steaming at once.

If the above does not solve the problem, get in touch with an authorised technical service.

You can download this manual from the local homepages of Bosch.



Customer Service

Great Britain

Bosch Customer Service

Grand Union House

Old Wolverton Road

Milton Keynes

MK12 5PT

UK +44 (0)844 892 8979

IRL +353 (0)1450 2655

www.bosch-home.co.uk