



Built-in oven HB.64B...



BOSCH

[en] Instruction manual

en Table of contents

Important safety information	2	Unhooking and hanging the oven door	13
Causes of damage	4	Removing the door covering	13
Your new oven	4	Removing and installing the door panels	14
Control panel	4	Troubleshooting	15
Function control knob	5	Troubleshooting table	15
Sensors and display panel	5	Changing the oven bulb	15
Sensors to change the set values	5	Protective glass panels.....	15
Inside the oven	5	After-sales service	16
Your accessories	6	E number and FD number	16
inserting the accessories	6	Energy and environment tips	16
Optional accessories	6	Environmentally-friendly disposal of waste	16
Before using the oven for the first time	7	Saving energy.....	16
Setting the time	7	Eco hot air function	16
Heating the oven.....	7	Tested for you in our cooking studio	18
Cleaning the accessories.....	7	Cakes and pastries	18
Programming the oven	7	Practical cooking tips and suggestions	19
Type of heating and temperature	7	Meat, poultry, fish.....	19
Rapid heating	7	Tips for roasting and grilling.....	20
Setting the time functions	8	Cooking a menu	21
Timer	8	Ready-made products.....	21
Cooking time	8	Special dishes	22
End time.....	9	Defrosting	22
Time.....	9	Drying	22
Changing the basic settings	10	Jam making	23
Automatic shut off	10	Test dishes	24
Self-cleaning	10	Baking	24
Important notes	10	Grilling	24
Before using the self-clean function	11		
Setting	11		
After using the self-clean function	11		
Care and cleaning	12		
Cleaning products	12		
Light.....	12		
Removing and refitting the wire shelves or left and right hand side rails	12		

Additional information on products, accessories, replacement parts and services can be found at www.bosch-home.com and in the online shop www.bosch-eshop.com

Important safety information

Read these instructions carefully. Only then will you be able to operate your appliance safely and correctly. Retain the instruction manual and installation instructions for future use or for subsequent owners.

This appliance is only intended to be fully fitted in a kitchen. Observe the special installation instructions.

Check the appliance for damage after unpacking it. Do not connect the appliance if it has been damaged in transport.

Only a licensed professional may connect appliances without plugs. Damage caused by incorrect connection is not covered under warranty.

This appliance is intended for domestic use only. The appliance must only be used for the preparation of food and drink. The appliance must be supervised during operation. Only use this appliance indoors.

This appliance may be used by children over the age of 8 years old and by persons with reduced physical, sensory or mental capabilities or by persons with a lack of experience or knowledge if they are supervised or are instructed by a person responsible for their safety how to use the appliance safely and have understood the associated hazards.

Children must not play with, on, or around the appliance. Children must not clean the appliance or carry out general maintenance unless they are at least 8 years old and are being supervised.

Keep children below the age of 8 years old at a safe distance from the appliance and power cable.

Always slide accessories into the cooking compartment correctly. See "*Description of accessories*" in the instruction manual.

Risk of fire!

- Combustible items stored in the cooking compartment may catch fire. Never store combustible items in the cooking compartment. Never open the appliance door if there is smoke inside. Switch off the appliance and unplug it from the mains or switch off the circuit breaker in the fuse box.
- A draught is created when the appliance door is opened. Greaseproof paper may come into contact with the heating element and catch fire. Do not place greaseproof paper loosely over accessories during preheating. Always weight down the greaseproof paper with a dish or a baking tin. Only cover the surface required with greaseproof paper. Greaseproof paper must not protrude over the accessories.

Risk of burns!

- The appliance becomes very hot. Never touch the interior surfaces of the cooking compartment or the heating elements. Always allow the appliance to cool down. Keep children at a safe distance.
- Accessories and ovenware become very hot. Always use oven gloves to remove accessories or ovenware from the cooking compartment.
- Alcoholic vapours may catch fire in the hot cooking compartment. Never prepare food containing large quantities of drinks with a high alcohol content. Only use small quantities of drinks with a high alcohol content. Open the appliance door with care.

Risk of scalding!

- The accessible parts become hot during operation. Never touch the hot parts. Keep children at a safe distance.

- When you open the appliance door, hot steam may escape. Open the appliance door with care. Keep children at a safe distance.
- Water in a hot cooking compartment may create hot steam. Never pour water into the hot cooking compartment.

Risk of injury!

Scratched glass in the appliance door may develop into a crack. Do not use a glass scraper, sharp or abrasive cleaning aids or detergents.

Risk of electric shock!

- Incorrect repairs are dangerous. Repairs may only be carried out by one of our trained after-sales engineers. If the appliance is faulty, unplug the mains plug or switch off the fuse in the fuse box. Contact the after-sales service.
- The cable insulation on electrical appliances may melt when touching hot parts of the appliance. Never bring electrical appliance cables into contact with hot parts of the appliance.
- Do not use any high-pressure cleaners or steam cleaners, which can result in an electric shock.
- When replacing the cooking compartment bulb, the bulb socket contacts are live. Before replacing the bulb, unplug the appliance from the mains or switch off the circuit breaker in the fuse box.
- A defective appliance may cause electric shock. Never switch on a defective appliance. Unplug the appliance from the mains or switch off the circuit breaker in the fuse box. Contact the after-sales service.

Risk of fire!

- Loose food residues, grease and meat juices may catch fire during the Self-cleaning cycle. Remove coarse dirt from the cooking compartment and from the accessories before every Self-cleaning cycle.
- The appliance will become very hot on the outside during the Self-cleaning cycle. Never hang combustible objects, e.g. tea towels, on the door handle. Do not place anything against the front of the oven. Keep children at a safe distance.

Risk of burns!

- The cooking compartment will become very hot during the Self-cleaning cycle. Never open the appliance door or move the locking latch by hand. Allow the appliance to cool down. Keep children at a safe distance.
-  The appliance will become very hot on the outside during the Self-cleaning cycle. Never touch the appliance door. Allow the appliance to cool down. Keep children at a safe distance.

Risk of serious damage to health!

The appliance will become very hot during the Self-cleaning cycle. The non-stick coating on baking trays and tins is destroyed and noxious gases are released. Never let non-stick baking trays and tins go through the Self-cleaning cycle. Only enamelled accessories may be cleaned at the same time.

Causes of damage

Caution!

- Accessories, foil, greaseproof paper or ovenware on the cooking compartment floor: do not place accessories on the cooking compartment floor. Do not cover the cooking compartment floor with any sort of foil or greaseproof paper.

Do not place ovenware on the cooking compartment floor if a temperature of over 50 °C has been set. This will cause heat to accumulate. The baking and roasting times will no longer be correct and the enamel will be damaged.

- Water in a hot cooking compartment: do not pour water into the cooking compartment when it is hot. This will cause steam. The temperature change can cause damage to the enamel.
- Moist food: do not store moist food in the cooking compartment when it is closed for prolonged periods. This will damage the enamel.
- Fruit juice: when baking particularly juicy fruit pies, do not pack the baking tray too generously. Fruit juice dripping from the baking tray leaves stains that cannot be removed. If possible, use the deeper universal pan.
- Cooling with the appliance door open: only allow the cooking compartment to cool when it is closed. Even if the appliance door is only open a little, front panels of adjacent units could be damaged over time.
- Very dirty door seal: If the door seal is very dirty, the appliance door will no longer close properly when the appliance is in use. The fronts of adjacent units could be damaged. Always keep the door seal clean.
- Appliance door as a seat, shelf or worktop: Do not sit on the appliance door, or place or hang anything on it. Do not place any cookware or accessories on the appliance door.
- Inserting accessories: depending on the appliance model, accessories can scratch the door panel when closing the appliance door. Always insert the accessories into the cooking compartment as far as they will go.
- Carrying the appliance: do not carry or hold the appliance by the door handle. The door handle cannot support the weight of the appliance and could break.

Your new oven

We will now describe your new oven. This chapter explains the functions of the control panel and its individual elements. Information is also provided about the oven's accessories and internal components.

Control panel

Below is a general overview of the control panel. The display panel cannot show all the symbols at the same time. Elements may vary depending on the model.

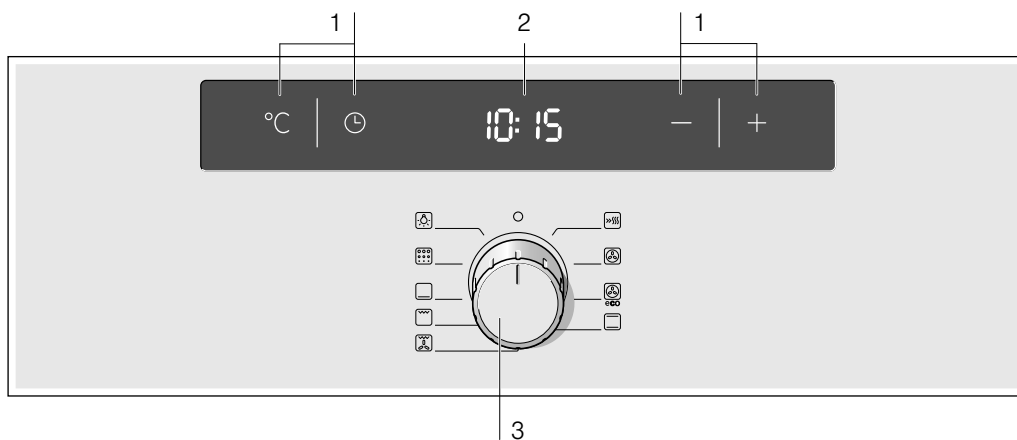

	Use
1	Sensors
2	Display panel
3	Function control knob

Retractable control knob

The control knob is retractable on some ovens. The control knob is retracted or returned by pressing it when at the zero setting.

Sensors

Do not press the sensors forcefully. Only press the relevant symbol.

Function control knob

The function control knob is used to select the type of heating.





Setting	Use
○ Zero setting	The oven is off.
⏏ Rapid heating	The oven reaches the programmed temperature very quickly.
🌀 3D hot air	For cakes and pastries. You can bake cakes and pastries on three levels. A fan located on the rear wall of the oven disperses the heat evenly.
🌿 Eco hot air function*	To prepare cakes, confectionery, deep frozen products, roasts and fish on one level and when pre-heating is not required. The fan distributes air evenly inside the oven to optimise energy use.
☑ Top and bottom heating*	For cakes, gratin dishes, and lean meat roasts, e.g. veal or game, on one level. The heat is provided by the bottom and top heating elements.
🔥 Grill with hot air	For roasting joints of meat, poultry and fish. The grill heating element and the fan switch on and off alternately. The fan circulates the heat generated by the grill around the food.
☑ Large surface grill	For grilling steaks, sausages, fish and toasting bread. The entire surface below the grill heating element is heated.
☑ Bottom heating	Confits, baking and cooking au gratin. The heat comes from the bottom heating element.
🧼 Self-cleaning	Using the self-cleaning function to clean the inside of the oven. The oven heats to clean itself.
💡 Light	For turning on the oven light.

* Type of heating used to determine the appliance's energy efficiency rating according to EN60350.

When a heating type is selected, the **---** symbol is displayed on the display panel.

Sensors and display panel

The sensors are used to set different functions. The set values are shown on the display panel.

Sensor	Sensor function
°C Temperature	Select the temperature and grill power or cleaning level.
🕒 Time functions	Select the timer  , the cooking time  , the end time  and the time  .
- Minus	Reduce programmed values.
+ Plus	Increase programmed values.

The symbol for the time function activated lights up on the display panel.



Sensors to change the set values

With the **+** or **-** sensors, all fixed and recommended settings can be changed.



+ = Increase programmed values.

- = Reduce programmed values.

Ranges

30-270	Temperature range	The temperature inside the oven in °C.
1-3	Grill power	The different levels for the large surface grill  . 1 = level 1, low 2 = level 2, medium 3 = level 3, high
	Cleaning levels	The self-cleaning levels  . 1 = level 1, low 2 = level 2, medium 3 = level 3, high
1 sec. - 23:59 h.		Cooking time.
1 sec. - 23:59 h.		Time set on the timer.

Heating symbol

While the oven is heating up, the  symbol will be lit up on the display panel. When the oven is ready for your dish and maintains its temperature the  symbol will switch off.

The  symbol never lights up for grill power and cleaning levels.

Inside the oven

There is a light inside the oven. A fan prevents the oven from overheating.

Light

The oven light remains on while the oven is working. The light switches off at set temperatures of less than 60°C and during the clean function. This ensures optimum precision control.

However, the light can be turned on without the oven being on by setting the function control knob to .

Fan

The fan can be turned on and off as necessary. The hot air escapes through the top of the door. Warning! Do not cover the vent. The oven could overheat.

The fan remains on for a certain length of time after the oven has been switched off so that it can cool down more quickly.

Your accessories

The accessories supplied with your appliance are suitable for making many meals. Ensure that you always insert the accessories into the cooking compartment the right way round.

There is also a selection of optional accessories, with which you can improve on some of your favourite dishes, or simply to make working with your oven more convenient.

inserting the accessories

The accessories can be placed inside the oven on 5 different levels. Always insert them as far as possible so that the accessories do not touch the door glass.

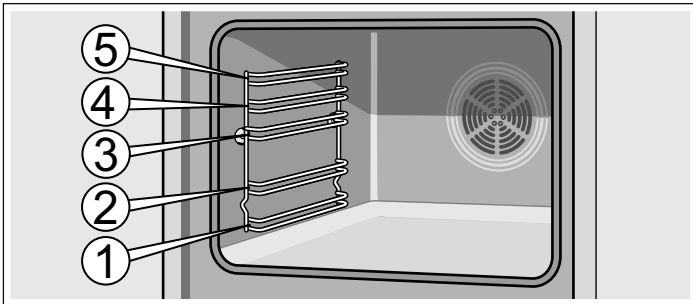

The accessories can be removed halfway until they are secured. This makes it easy to remove food.

When inserting an accessory in the oven, make sure the curvature is at the rear. This is the only way to ensure it fits perfectly.

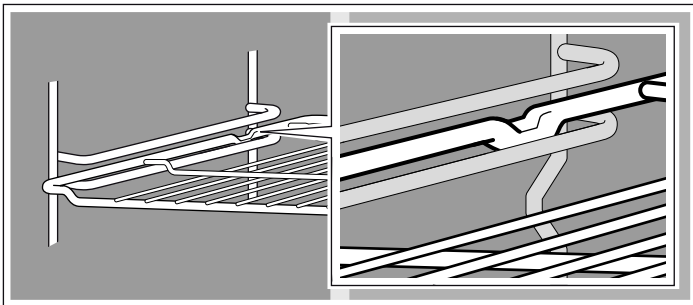

Depending on the equipment, if the appliance has guide rails, these will interlock slightly when fully removed. This means the accessory can be easily inserted. To unlock, reinsert the guide rails in the oven exerting slight pressure.

Note: Accessories may deform as they heat up. This deformation will disappear when they cool. This does not affect the normal operation.

Your oven is supplied with only some of the following accessories.

Accessories may be purchased from the Technical Assistance Service, from specialist retailers or on the Internet. Enter the HEZ number.



Wire shelf

For cookware, baking tins, roasts, grilled items and frozen meals.

Insert the wire shelf with the open end facing the oven door and the curvature downwards.



Flat enamel oven tray

For cakes, pastries and biscuits.

Place the tray in the oven with its raised lip facing the door.



Universal deep enamel tray

For juicy cakes, pastries, frozen meals and large joints for roasting. This can also be used as a tray to collect the fat when roasting directly on the wire shelf.

Place the tray in the oven with its raised lip facing the door.

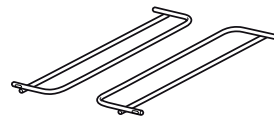

Accessory support

The universal deep tray or the flat oven tray can also be cleaned during the self-clean function.

Insert the accessory to the right and left.

Optional accessories

You can purchase optional accessories from the after-sales service or specialist retailers. You will find a comprehensive range of products for your oven in our brochures and online. The availability of optional accessories and whether it is possible to order them online may vary depending on your country. Please see the sales brochures for more details.

Not all optional accessories are suitable for every appliance. When purchasing, please always quote the exact designation (E no.) of your appliance.

Optional accessories	HEZ number	Use
Flat enamelled baking tray	HEZ361000	For cakes and biscuits.
Deep enamelled universal pan	HEZ362000	For moist cakes, pastries, frozen meals and large joints. It can also be used to catch dripping fat when you are grilling directly on the wire rack.
Wire rack	HEZ364000	For ovenware, cake tins, roasts, grilled items and frozen meals.
Pizza tray	HEZ317000	Ideal for pizza, frozen products or large, round cakes. You can use the pizza tray instead of the deep universal pan. Place the tray on the wire rack and refer to the specifications in the tables.
Glass roasting dish	HEZ915001	The glass roasting dish is suitable for stews and bakes that are cooked in the oven. Particularly suitable for the automatic programmes and automatic roasting.
Telescopic shelf x3	HEZ368301	The pull-out rails at levels 1, 2 and 3 allow you to pull the accessories out further without them tipping.

Before using the oven for the first time

In this section, you can find out what you must do before using your oven to prepare food for the first time. First read the section on *Safety information*.

Setting the time

Once the oven has been connected, the  and **0:00** symbols light up on the display panel. Set the clock to the right time.

1. Press the  sensor.

The display panel displays the time **12:00**

2. Set the time with the **+** or **-** sensors.
3. Confirm the time with the  sensor.

The programmed time is displayed after a few seconds.

Heating the oven

To remove the "new" smell, heat the oven empty with the door closed. The most effective option is to heat the oven for one hour with the top and bottom heating elements  set at 240 °C. Check that no packaging has been left inside the oven.

1. Select top and bottom heating  using the function control knob.
2. Press the **+** sensor until 240 °C is displayed on the display panel.

Turn the oven off after one hour. To do this, turn the function control knob to zero.

Cleaning the accessories

Before using the accessories for the first time, clean them thoroughly using a cloth, hot water and a little soap.

Programming the oven

There are different ways to programme the oven. Programming the type of heating, temperature or grill power. The oven can be programmed with the cooking time (duration) and the end time for each dish. For more information, see the chapter *Setting the time functions*.

Type of heating and temperature

Example in the picture: top and bottom heat  at 190 °C

1. Select the type of heating using the function control knob.

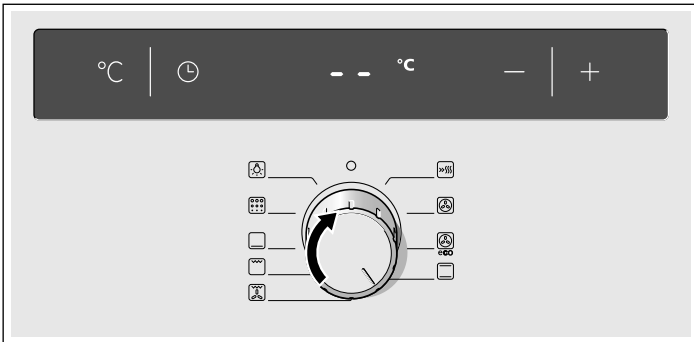

2. Set the temperature or required grill power using the **+** or **-** sensors.

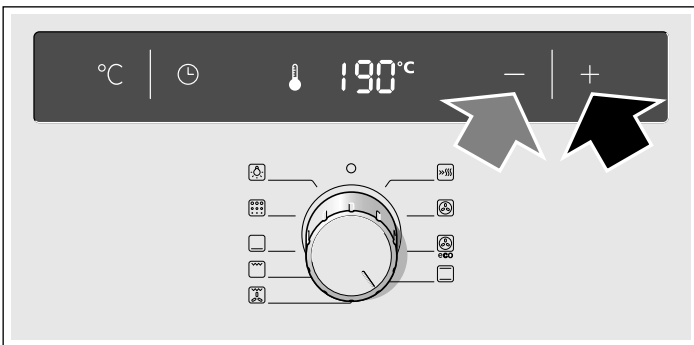

The oven will begin to heat up.

Switching the oven off

Set the function control knob to the zero setting.

Changing the settings

The type of heating and the temperature or grill power may be changed at any time.

Rapid heating

With the rapid heating setting, the oven reaches the programmed temperature very quickly.

Rapid heating must be used for temperatures of more than 100 °C.

To ensure uniform cooking, the food must not be put into the oven until rapid heating has been completed.

1. Select rapid heating  using the function control knob.
2. Select the required temperature using the **+** and **-** sensors.

The  symbol lights up on the display panel. The oven will begin to heat up.

End of rapid heating



A signal will sound, the  symbol will go out. Place the food in the oven and select the required function and temperature.

Cancelling rapid heating

Set the function control knob to the zero setting. The oven switches off.

Note: With the rapid heating function you cannot programme the cooking time duration.

Setting the time functions

This oven has various time functions. The  sensor activates the menu and moves through the different functions. The time symbols remain lit up while settings are programmed. A time function that has already been programmed can be modified with the  or  sensors.

Timer

The timer works independently of the oven. The timer has its own signal. You can therefore distinguish whether the time set for the timer or the automatic oven shut-off have finished (cooking time).

1. Press the  sensor.

The  symbol lights up on the display panel.

2. Programme the timer using the  or  sensors.

Sensor suggested value  = 10 minutes.



Sensor suggested value  = 5 minutes.

The programmed time is shown after a few seconds. The time set for the timer starts to count down. The  symbol lights up on the display panel and the time elapsed is displayed.

The time set for the timer has elapsed

A signal will sound. The display panel will show **00:00**. Switch off the timer using the  sensor.

Changing the time set on the timer.





Change the time set for the timer using the  or  sensors. The altered time is shown after a few seconds.

Cancelling the timer

When the oven switches off, the timer continues working. Resetting the timer to **00:00** with the  sensor. The timer switches off.

Viewing the time settings

If several time functions are programmed, the corresponding symbols light up on the display panel.

To view the timer , the cooking time , the end time  or the time , press the  sensor repeatedly until the required symbol lights up. The corresponding value will be shown for a few seconds on the display panel.

Cooking time

The oven allows you to set the cooking time for each type of food. The oven switches off automatically when the cooking time has elapsed. This avoids interrupting other tasks to switch the oven off or exceeding the cooking time by mistake.

Example in the picture: Cooking time: 45 minutes.

1. Select the type of heating using the function control knob.

2. Press the  sensor twice.

The display panel will show **00:00** and the cooking time symbol .





3. Programme the cooking time using the  or  sensors.

Sensor suggested value  = 30 minutes.

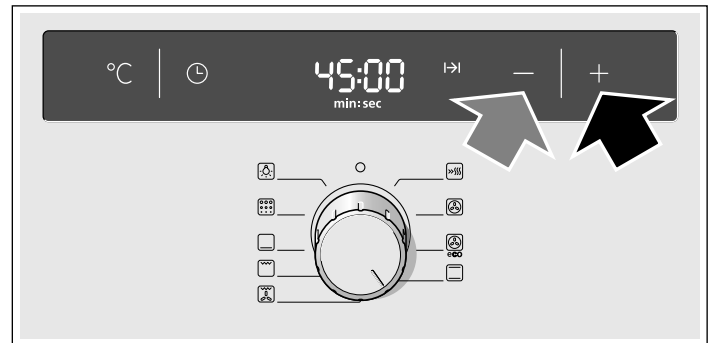
Sensor suggested value  = 10 minutes.







4. Press the  sensor.



Set the temperature or required grill power using the  or  sensors.

The oven will switch on after a few seconds. The programmed temperature will be shown on the display panel and the  symbol will light up.



The cooking time has finished

A beep will sound. The oven will stop heating. The display panel will show **00:00**. Press the  sensor twice. You can set a new cooking time with the  or  sensors, or press the  sensor and turn the function control knob to zero. The oven is switched off.

Changing the cooking time





Press the  sensor twice. Change the cooking time using the  or  sensors.

Cancelling the cooking time

Press the  sensor twice. Reset the cooking time to **00:00** with the sensor . The time has been cancelled.

Viewing the time settings

If several time functions are programmed, the corresponding symbols light up on the display panel.

To view the timer , the cooking time , the end time  or the time , press the  sensor repeatedly until the required symbol lights up. The corresponding value will be shown for a few seconds on the display panel.

End time

The oven allows you to set the time when you want the food ready. In this case the oven switches on automatically and switches off at the set time. For example, the food may be placed in the oven in the morning and the oven set so that it is ready at midday.

Ensure that the food will not go off if it is in the oven for too long.

Example in the picture: It is now 10:30 AM, the cooking time is 45 minutes and the oven should switch off at 12:30PM.

1. Set the function control knob.
2. Press the \odot sensor twice.
3. Programme the cooking time using the $+$ or $-$ sensors.
4. Press the \odot sensor.

The time when the dish will be ready and the end time symbol $\rightarrow|$ will be shown on the display panel.

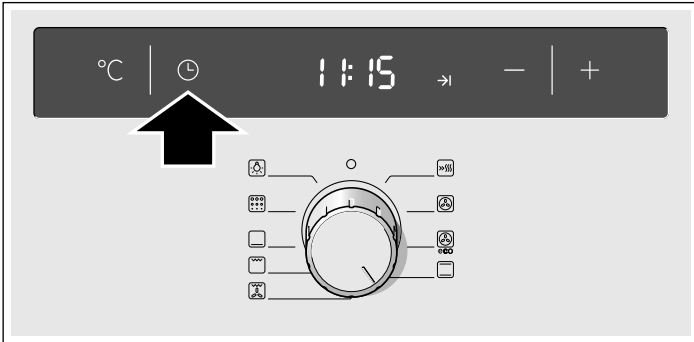

5. Delay the end time using the $+$ or $-$ sensors.

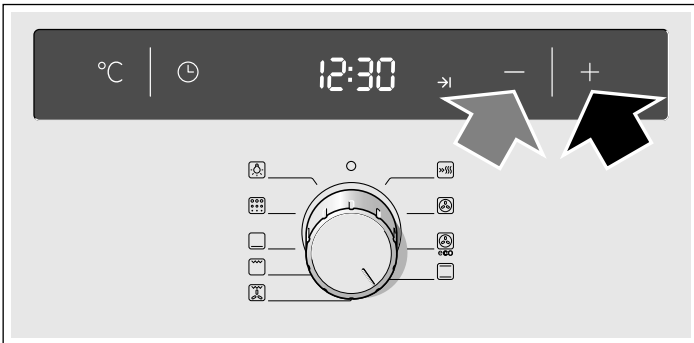

6. Press the $^{\circ}\text{C}$ sensor.

Set the temperature or required grill power using the $+$ or $-$ sensors.

The programmed temperature and the $\rightarrow|$ symbol will be shown on the display panel, and the oven will be set to standby. When the oven turns on, the programmed temperature and the $| \rightarrow$ symbol will be shown. The $\rightarrow|$ symbol turns off.

The cooking time has finished

A beep will sound. The oven will stop heating. The display panel will show $00:00$. Press the \odot sensor twice. You can set a new cooking time with the $+$ or $-$ sensors, or press the \odot sensor and turn the function control knob to zero. The oven is switched off.

Changing the end time

Press the sensor \odot three times. Change the end time using the $+$ or $-$ sensors. The altered time is shown after a few seconds. Do not change the end time if the cooking time has already started to count down. The final result may not be the same.

Cancelling the end time

Press the \odot sensor three times and reset the end time to the current time with the $-$ sensor. The oven switches on.

Viewing the time settings

If several time functions are programmed, the corresponding symbols light up on the display panel.

To view the timer \odot , the cooking time $| \rightarrow$, the end time $\rightarrow|$ or the time \odot , press the \odot sensor repeatedly until the required symbol lights up. The corresponding value will be shown for a few seconds on the display panel.

Time

Once the oven has been connected or after a power cut, the \odot and $0:00$ symbols light up on the display panel. Set the clock to the right time.

1. Press the \odot sensor.

The time is displayed $12:00$.

2. Set the time with the $+$ or $-$ sensors.

3. Confirm the time with the \odot sensor.

The programmed time is displayed after a few seconds.

Changing the time

No other time function must be programmed, the oven must be switched off.

1. Press the \odot sensor twice.

The display panel displays \odot .

2. Set the time with the $+$ or $-$ sensors.

3. Confirm the time with the \odot sensor.

The programmed time is displayed after a few seconds.

Hiding the time

The time can be hidden. See the *Modifying basic settings* chapter.

Changing the basic settings

This oven has different basic settings. The settings can be adapted to the user's own needs.

Basic setting	Option 0	Option 1	Option 2	Option 3
c 1 Duration of signal after the cooking time or the time set on the timer has elapsed	-	approx. 10 sec	approx. 2 min*	approx. 5 min
c 2 Time indicator	no	yes*	-	-
c 3 Time until a setting is applied	-	approx. 2 sec	approx. 4 sec*	approx. 10 sec
c 5 The shelf support rails have been refitted.	no	yes	-	-
c 6 Select default settings for all values.	no*	yes	-	-

* Default setting

The oven must be switched off.

1. Press the \ominus sensor for approximately 4 seconds.
The display panel will show the current basic setting for the duration of the signal, e.g., **c 1** Option **c 2**.
2. Change the basic setting using the **+** or **-** sensors.

3. Confirm with the sensor \ominus .

The display panel shows the following basic setting. The \ominus sensor allows you to run through all the settings and the **+** or **-** sensors allow you to modify them.

4. Finally, press the \ominus sensor for approximately 4 seconds. All basic settings have been applied.

The basic settings can be changed again at any time.

Automatic shut off

If the settings of the appliance are not changed for several hours it is automatically shut off. The oven will stop heating. This depends on the temperature or grill power selected.

Automatic shut off is activated

A signal will sound. The display shows **F8**. The oven will stop heating.

Turn the function control knob to the zero setting. The oven switches off.

Cancelling the automatic shut off function

To avoid triggering the automatic shut off, a cooking time must be set. The oven will heat until this time is up.

Self-cleaning

During the self-cleaning function, the oven heats to about 500 °C. In this way, baking and cooking remains are burned and only ash remains have to be cleaned from the oven.

There are three cleaning levels available.

Level	Cleaning level	Duration
1	mild	approx. 1 hour, 15 minutes
2	medium	approx. 1 hour, 30 minutes
3	intense	approx. 2 hours

The more intense and old the dirt, the higher the self cleaning level used. The inside of the oven only has to be cleaned once every two or three months. Complete cleaning requires approximately 2.5 - 4.7 kilowatt-hours.

Important notes

For your safety, the oven door locks automatically. The oven door cannot be opened again until the cooking compartment has cooled slightly and the padlock symbol for the locking mechanism disappears.

The oven light in the cooking compartment does not come on during Self-cleaning.

Risk of burns!

- The cooking compartment will become very hot during the Self-cleaning cycle. Never open the appliance door or move the locking latch by hand. Allow the appliance to cool down. Keep children at a safe distance.
- The appliance will become very hot on the outside during the Self-cleaning cycle. Never touch the appliance door. Allow the appliance to cool down. Keep children at a safe distance.

Risk of fire!

The appliance will become very hot on the outside during the Self-cleaning cycle. Never hang flammable objects, e.g. tea towels, on the door handle. Do not place anything against the front of the appliance.

Before using the self-clean function

The oven must be empty. Remove accessories, pans, guides or left and right hand side rails. See the *Cleaning and Care* chapter to release the guides or left and right hand side rails.

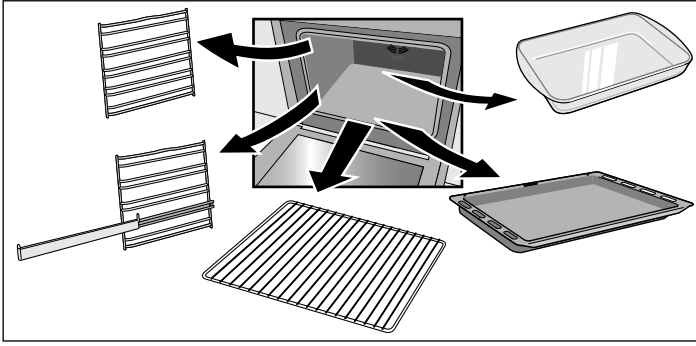

Clean the oven door and the side surfaces inside the oven around the area with seals.

⚠ Risk of fire!!

The remains of food and grease as well as roasting juices can catch fire. Use a damp cloth to clean the inside of the oven and the accessories that will be cleaned inside the oven.

Cleaning of the accessories

The wire shelves or left and right hand side rails are not suitable for self cleaning. Remove these from the oven.

For optimum cleaning of the oven interior, it is recommended that the self-clean function is not used with the trays. However, with the accessory support, the universal deep enamel tray or the flat enamel oven tray can also be cleaned using the self-clean function. Only clean one accessory at a time.

The shelf should not be cleaned using the self-clean function.

If your oven does not have this support, it can be purchased from the Technical Assistance Service or over the Internet by quoting part number 466546.

The accessory support is inserted to the right and left.

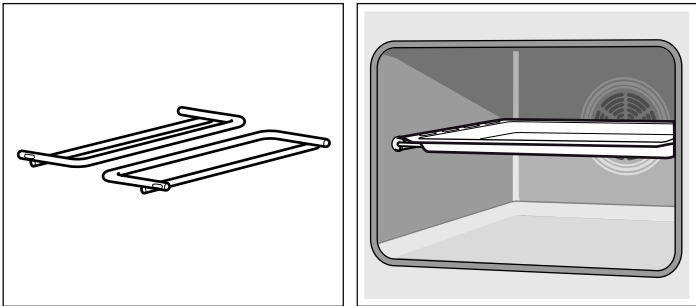

Use water to clean food remains, oil and roasting juices from the accessories.

Place the universal deep tray or the flat oven tray on the support.

⚠ Significant health risks!



Do not place non-stick baking tins or trays in the oven during self-cleaning. The intense heat removes the non-stick surface and creates toxic gases.

Setting

Once the cleaning level has been selected, set the oven.

1. Select the Self-cleaning  function with the function control knob.
2. Set the required cleaning level using the **+** or **-** sensors.

The display panel will show the cleaning level and the **I→** symbol. Self-cleaning starts within a few seconds.

The oven door locks shortly after the function has started. The  symbol lights up on the display panel. Only when the  symbol turns off can the oven door be opened again.

Self-cleaning has ended.

The display panel will show **00:00**. The oven will stop heating. Turn the function control knob to the zero setting. The oven switches off. The oven door can be opened again when the  symbol on the display panel turns off.

Changing the cleaning level

The cleaning level cannot be changed once it has started.

Stopping the self-cleaning

Turn the function control knob to the zero setting. The oven switches off. The oven door can be opened again when the  symbol on the display panel turns off.

Delaying the end time

The oven allows you to programme the self-cleaning end time. Self-cleaning can therefore be programmed at night for example, leaving the oven free for use during the day.

Programme as described in section 1 and 2. Before starting the self-cleaning, press the  sensor three times and delay the end time with the **+** or **-** sensors.

The oven is set to standby. The display panel will show the cleaning level and the **→** symbol. When self-cleaning starts, the cleaning level and the **I→** symbol are shown. The **→** symbol switches off.

Viewing the time settings

To view the duration of the cleaning level or the end time of the self-cleaning press the  sensor repeatedly until the required symbol lights up. The corresponding value will be shown for a few seconds on the display panel.

After using the self-clean function

Once the inside of the oven has cooled, clean the ash remains using a damp cloth.

Care and cleaning

If cleaned and properly cared for, your oven will keep its bright appearance and operating performance for many years to come. Advice on how to care for and clean your oven is provided below.

Notes

- Different colours may be seen in your front panel due to the various materials used in its manufacture, such as glass, plastic and metal.
- Dark patches in the door's glass panel may seem to be dirt but they are in fact reflections from the oven light.
- Enamel burns at very high temperatures. This may cause slight discolouration. This is normal and does not affect the oven's operation. The edges of thin baking trays may not be completely enamelled. They may therefore feel slightly rough, although their corrosive protection will be unaffected.

Cleaning products

Follow the indications provided in the table to avoid damaging the various oven surfaces by using unsuitable cleaning products. Do not use

- abrasive or acidic cleaning products
- strong products containing alcohol
- scourers or hard sponges
- high-pressure or steam cleaners.

Wash new dishcloths thoroughly before use.

Zone	Cleaning products
Front panel	Hot water and a little soap: Clean with a dishcloth and dry with a soft cloth. Do not use a glass cleaning product or a glass scraper.
Stainless steel	Hot water and a little soap: Clean with a dishcloth and dry with a soft cloth. Immediately remove any water marks, grease, cornflower or egg white stains since corrosion could occur underneath these marks or stains. Special products for the care of stainless steel which are suitable for hot surfaces may be obtained from Technical Assistance Service centres and specialist retail outlets. Use a very fine soft cloth to apply the cleaning product.
Glass panel	Glass cleaning products: Clean with a soft cloth. Do not use a glass scraper.
Display	Glass cleaning products: Clean with a soft cloth. Do not use alcohol, vinegar or other abrasive or acidic cleaning products.
Glass panels on oven door	Glass cleaning products: Clean with a soft cloth. Do not use a glass scraper.
Door covering	Only use products specially for cleaning stainless steel (these can be obtained from the Technical Assistance Service or from specialist shops). Follow the manufacturer's instructions.

Zone	Cleaning products
Inside the oven	Hot water with a little soap or water and vinegar: Clean with a dishcloth. If very dirty, use a stainless steel scourer or special oven cleaning products. These must only be used when the oven interior is cold. Whenever possible, use the self-cleaning function. See the chapter on the <i>Self-cleaning</i> function.
Glass cover for the oven light	Hot water and a little soap: Clean with a dishcloth.
Guides or rails	Hot water and a little soap: Soak and clean using a dishcloth or brush.
Sliding guides	Hot water and a little soap: Clean with a dishcloth or a brush. Do not leave this to soak or wash in a dishwasher.
Accessories	Hot water and a little soap: Soak and clean using a dishcloth or brush.

Light

The oven light can be turned on manually to facilitate cleaning.

Connecting the oven bulb

Turn the function control knob to the  position.

The light will come on.

Turning the oven light off

Turn the function control knob to the  position.

Removing and refitting the wire shelves or left and right hand side rails

The wire shelves or left and right hand side rails can be removed for cleaning. The oven must be cold.

Release the guides or rails

1. Lift the front of the guide or rail and release it (figure A).
2. Then pull the guide or rail forwards completely and remove it (figure B).

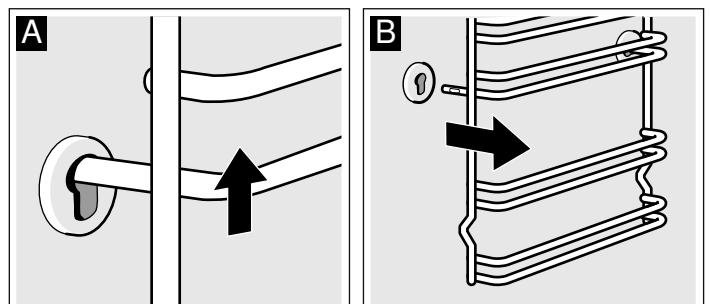

Clean the guides or rails with detergents and a sponge. The use of a brush is recommended for stubborn stains.

Install the wire shelves or rails

1. First insert the shelf or the rail in the rear groove by pushing it back slightly (figure A)
2. then insert it in the front groove (figure B).

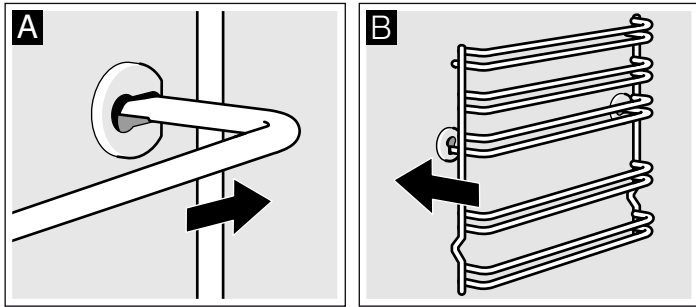

Wire shelves or rails can be adjusted on the left and right hand side. Their curvature should always be face down.

Unhooking and hanging the oven door

The front panel can be unhooked to help remove the oven door and clean the glass panels.

The oven door hinges are fitted with a locking lever. The door cannot be unhooked if the locking lever is closed (figure A). Once the locking lever has been opened to unhook the door (figure B), the hinges will be locked in position. This prevents the door from suddenly closing.

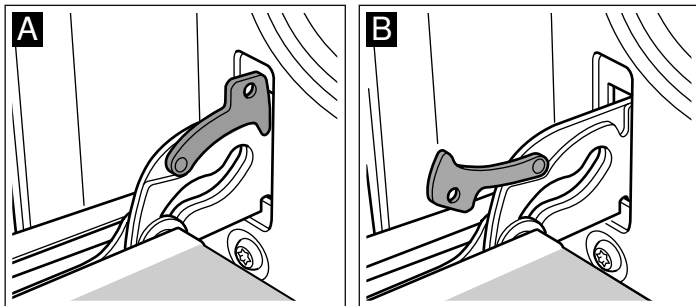

⚠ Risk of injuries.!

The hinges may close suddenly if they are not locked in position by the lever. Note that the locking levers are always closed, apart from when unhooking the door, when the levers must be open.

Unhooking the door

1. Fully open the oven door.
2. Remove both locking levers located on the right and left hand sides (figure A).
3. Fully close the oven door as far as possible (figure B). Grip the left and right hand sides of the door with both hands. Close the door slightly more and remove it.

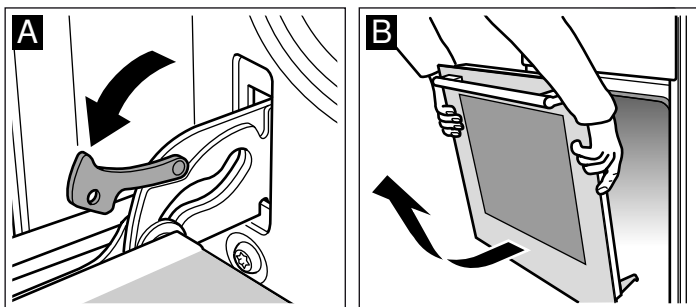

Hanging the door

Rehang the door by following the same steps but in reverse order.

1. When refitting the door, check that both hinges are positioned exactly inside their respective openings (picture A).
2. The bottom groove of the hinges must fit snugly on both sides.

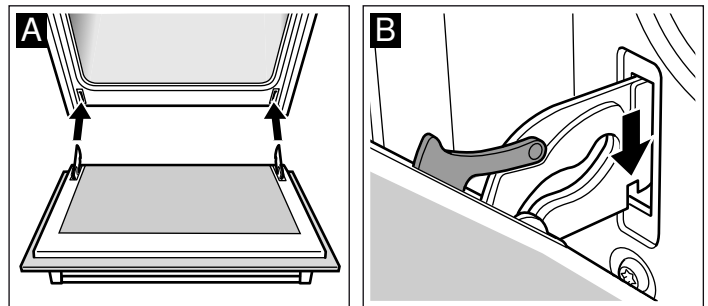

The door may be left crooked if the hinges are not mounted properly.

3. Reclose the attachment levers (picture C). Close the oven door.

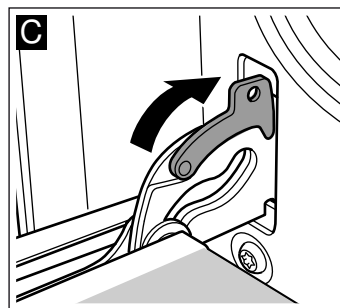

⚠ Risk of injuries.!

Do not touch the hinges; the door might accidentally fall or a hinge might suddenly close. Notify the Technical Assistance Service.

Removing the door covering

The oven door cover can change colour with time. For better cleaning, we recommend removing the cover.

1. Fully open the oven door.
2. Unscrew the oven door cover. To do this, unscrew the right and left hand side bolts (figure A).
3. Remove the cover (figure B).

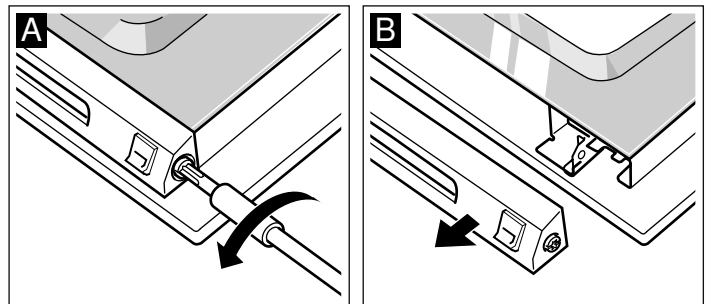

Ensure that the oven door does not close when the cover is not in place. The inside glass may damage.

Clean the surface using a product specifically for cleaning stainless steel.

4. Refit and secure it.
5. Close the oven door.

Removing and installing the door panels

To facilitate cleaning, you can remove the glass panels from the oven door.

When removing the inner panels, pay attention to the sequence in which the panels are removed. In order to reassemble the panels in the correct sequence, use the numbers that appear on each panel.

Removal

1. Detach the oven door and lay it on a cloth with the handle facing down.
2. Unscrew the cover at the top of the oven door. To do this, unscrew the left and right screws (fig. A).
3. Lift the top panel up and pull it out and remove the two small seals (fig. B).

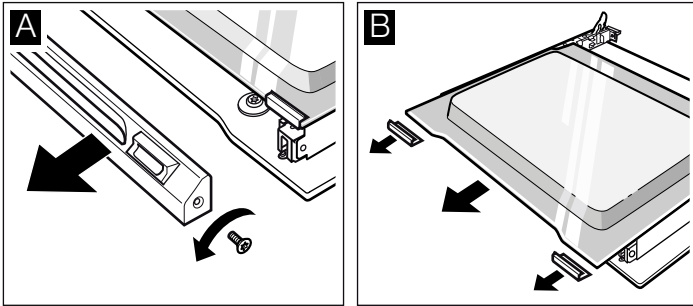

4. Unscrew the retaining clips on the right and left. Lift the panel and remove the clips from the panel (fig. C).
5. Remove the seal from the bottom of the panel (fig. D). Pull the seal and remove it up and out. Pull out the panel.

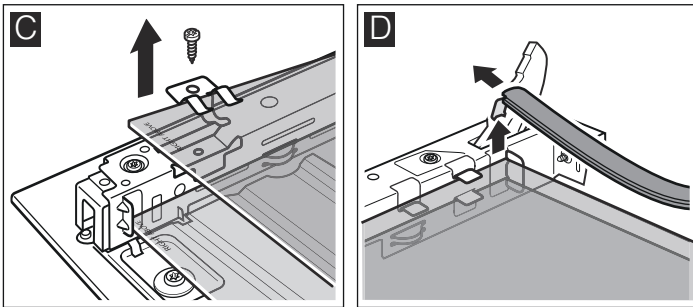

6. Pull the lower panel at an angle, upwards and out.
7. Do NOT unscrew the left and right-hand screws from the sheet metal part (fig. E).

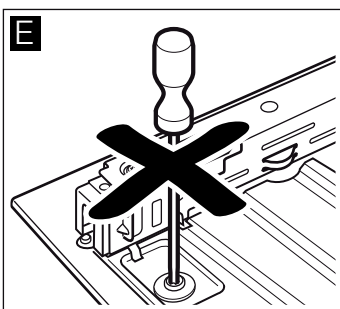

Clean the panels with glass cleaner and a soft cloth.

⚠ Risk of injury!

Scratched glass in the appliance door may develop into a crack. Do not use a glass scraper, sharp or abrasive cleaning aids or detergents.

Installation

During installation, make sure that the lettering "top right" is upside down at the bottom left of both panels.

1. Insert the lower panel at an angle towards the back (fig. A).
2. Slide in the middle panel (fig. B).

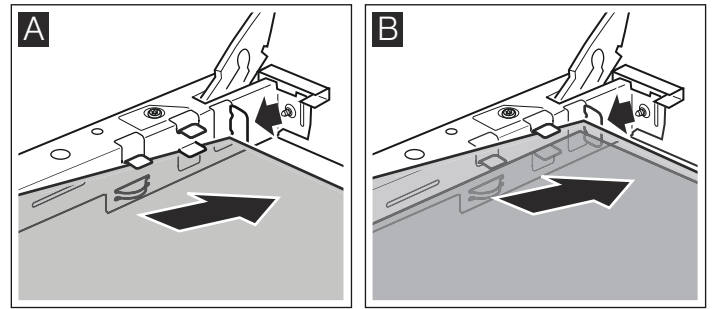

3. Stick the retaining clips onto the right and left-hand side of the panel, aligning them so that the retaining carriers are over the screw holes, and then screw into place (fig. C).
4. Hook the seal in to the bottom of the panel again (fig. D).

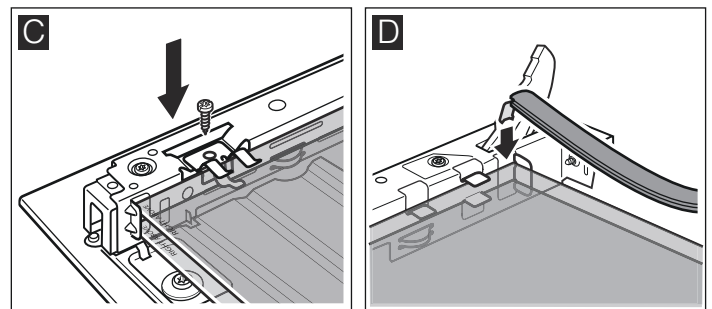

5. Insert the uppermost panel at an angle to the back into the brackets. Take care not to push the seal to the back (fig. E).
6. Insert the two small seals on the left and right of the panel again (fig. F).

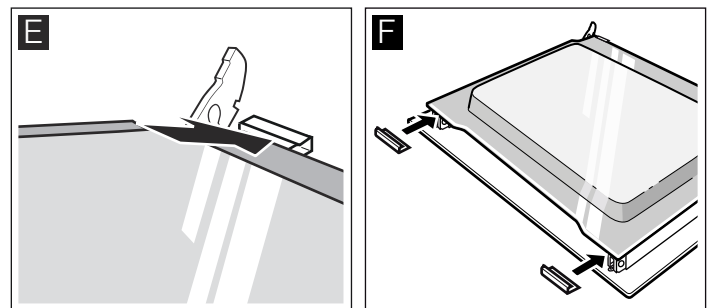

7. Put the cover back in place and screw it on.
8. Attach the oven door.

Do not use the oven again until the panels have been correctly installed.

Troubleshooting

Quite often, when there is a malfunction, it is usually a small irregularity which is easy to rectify. Before contacting the Technical Assistance Service, try to determine the cause of the fault using the following table.

Troubleshooting table

Fault	Possible cause	Solution/advice
The oven does not work.	The fuse has blown.	Check the condition of the fuse/circuit breaker in the fuse box.
	Power cut	Check that the light in the kitchen and other household appliances are working.
The ⊖ symbol lights up on the display with some zeros.	Power cut	Set the time once again.
The oven does not work.	There is dust in the contacts.	Turn the control knob several times in both directions.
The oven door does not open. The 🔒 symbol lights up on the display panel.	The oven door has been locked by the self-cleaning function  .	Wait until the oven has cooled and the 🔒 symbol turns off.
The display shows <i>F8</i> .	The appliance has been automatically turned off.	Turn the function control knob to the zero setting.

Error messages

When the indicator displays an error message with *E*, press the ⊖ sensor. The message will disappear. The set time function will be deleted. If the error message does not disappear, call the Technical Assistance Service.

The following error messages can be solved by the user.

Error message	Possible cause	Solution/advice
<i>E011</i>	A sensor has been pressed for too long or has got stuck.	Press all the sensors one by one. Check if a sensor is stuck, covered or dirty
<i>E105</i>	The door lock has been activated with the door open.	Press the ⊖ sensor. You can now begin programming again.
<i>E115</i>	The temperature inside the oven is too high.	The door oven is locked and heating has stopped. Wait until the oven has cooled. Press the ⊖ sensor and reset the time.

Risk of electrical discharge and the resulting shock.!

Incorrect repairs can be dangerous. Repairs can only be carried out by qualified personnel from the Technical Assistance Service.

Changing the oven bulb

If the oven light bulb is damaged it must be replaced. Special 25 W, E14, 220 V-240 V heat-resistant light bulbs (to 300 °C temperature) can be obtained from the Technical Support Service or in specialist shops. Only use this type of bulb.

Risk of electrical discharge and the resulting shock.!

Disconnect the appliance from the mains. Ensure that this is turned off.

1. Place a dishcloth into the cold oven to avoid damage.
2. Remove the glass protection by unscrewing it to the left.

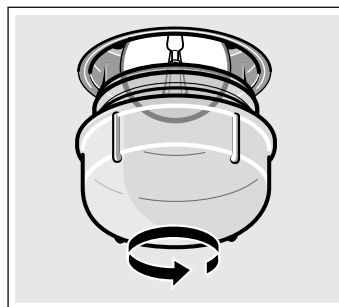

3. Replace the bulb with a similar bulb.
4. Screw the protection glass back into place.
5. Remove the dishcloth and switch the oven back on at the mains.

Protective glass panels

Damaged protective glass panels must be replaced. Protective glass panels can be obtained from the Technical Assistance Service. Please quote your appliance's product number and production number.

After-sales service

Our after-sales service is there for you if your appliance needs to be repaired. We will always find the right solution in order to avoid unnecessary visits from a service technician.

E number and FD number

When calling us, please give the product number (E no.) and the production number (FD no.) so that we can provide you with the correct advice. The rating plate containing these numbers can be found on the right-hand side of the oven door. You can make a note of the numbers of your appliance and the telephone number of the after-sales service in the space below to save time should it be required.

E no.	FD no.
-------	--------

After-sales service

Please note that there will be a fee for a visit by a service technician in the event of a malfunction, even during the warranty period.

Please find the contact data of all countries in the enclosed customer service list.

To book an engineer visit and product advice

GB 0344 892 8979

Calls charged at local or mobile rate.

IE 01450 2655

0.03 € per minute at peak. Off peak 0.0088 € per minute.

Rely on the professionalism of the manufacturer. You can therefore be sure that the repair is carried out by trained service technicians who carry original spare parts for your appliances.

Energy and environment tips

Here you can find tips on how to save energy when baking and roasting and how to dispose of your appliance properly.

Environmentally-friendly disposal of waste

Dispose of packaging with the environment in mind.



This appliance is identified according to the Waste Electrical and Electronic Equipment Directive WEEE 2002/96/EC. This directive defines the framework for the recycling and reuse of appliances used in EU territory.

Saving energy

- Preheat the oven only if this is required by a recipe or is indicated in the tables.
- Use dark, lacquered or black enamel baking tins. These are more efficient at absorbing heat.
- Keep the oven door closed during cooking, baking and roasting cycles.
- When baking several cakes, these should be preferably baked one after the other. The oven will still be hot, thereby reducing the cooking time for the second cake. Two rectangular baking tins can be placed side-by-side.

Type of heating =  eco hot air

- For long cooking times, the oven may be turned off 10 minutes prior to the specified time, allowing the item to continue to cook but taking advantage of the oven's residual heat.

Eco hot air function

Using the eco  hot air function, significant energy savings can be made cooking dishes on one level. The cooking, baking and roasting cycles do not require preheating.

Notes

- So that the energy-saving function works efficiently, the dish should be placed in a cold and empty oven.
- During the roasting cycle, the oven door should only be opened whenever really necessary, for example, to turn food over. In the chapter "Tables and suggestions", there are advice and suggestions on baking and roasting.

Table

The following table shows the selection of dishes suitable for the energy-saving function. The table gives details of suitable temperature settings, accessories and heights for each dish.

The temperature and the cooking time can change depending on quantity, condition and the quality of food. Thus, the values given in the table are approximate. We recommend beginning with the lowest value. Items will be more evenly browned at a lower temperature. If the result is not as expected, use a higher temperature setting next time.

	Accessory	Level	Temperature in °C	Cooking time, minutes
Cakes and confectionery				
Walnut triangles	flat oven tray	3	185-195	30-40
Easy sponge cake	wire shelf + rectangular baking tin	2	170-180	50-60
Apricot puff pastries	flat oven tray	3	190-200	25-30
Marble cake	wire shelf + rectangular baking tin	2	160-170	95-100
Butter sponge cake	wire shelf + rectangular baking tin	2	150-160	60-70
Savoy cake	wire shelf + baking tin	2	150-160	75-80
Swiss roll	flat oven tray	3	160-170	15-20

	Accessory	Level	Temperature in °C	Cooking time, minutes
Sponge cake	wire shelf + black enamel baking tin	2	160-165	40-45
Spanish sponge cake, 3 eggs	wire shelf + black enamel baking tin	1	160-170	40-45
Pastry case	flat oven tray	3	160-170	30-40
Biscuits and cookies	flat oven tray	3	130-140	15-25
Apple pie	universal deep tray	3	170-180	50-60
Fairy cakes	flat oven tray	3	150-160	20-30
Cream-filled buns	universal deep tray	3	200-210	35-40
Butter buns (12 buns)	flat oven tray	3	170-180	15-20
Bread (1 kg)	flat oven tray	3	200-210	55-65
Meat				
Roast veal (1.5 kg of veal)	wire shelf + closed pan	2	200-210	110-120
Roast pork (1 kg)	wire shelf + open pan	2	180-190	110-120
Fish				
Baked gilthead bream/sea bass (2 pieces, 350 g each)	universal deep tray	2	180-190	30-35
Gilthead bream in a salt crust (2 pieces, 450 g each)	flat oven tray	3	180-190	40-45
Hake (1 piece, of 1 kg)	flat oven tray	2	180-190	50-55
Trout (2 pieces, 300 g each)	flat oven tray	2	180-190	25-30
Monkfish (2 pieces, 400 g each)	flat oven tray	2	180-190	30-35
Frozen ready-meal				
Thin base frozen pizza	wire shelf	2	210-220	12-15
Thick base pizza	wire shelf	2	180-190	25-30
Chips for baking	flat oven tray	3	210-220	20-25
Chicken wings	flat oven tray	3	200-210	15-20
Fish fingers	flat oven tray	3	210-220	20-25
Mini filled puff pastries	flat oven tray	3	180-190	15-20
Frozen lasagne (450 g)	wire shelf	2	210-230	40-50
Lasagne (2 pieces, 450 g each)	wire shelf	2	210-230	40-50
Mozzarella sticks	flat oven tray	2	230-240	12-20
Jalapeño peppers	flat oven tray	3	200-210	15-20
Other				
Dauphinoise potatoes	wire shelf + open pan	2	155-165	65-75
Fresh lasagne	wire shelf + open pan	2	175-180	45-55

Tested for you in our cooking studio

Here you will find a selection of dishes and the ideal settings for them. We will show you which type of heating and which temperature are best suited for your dish. You can find information about suitable accessories and the height at which they should be inserted. There are also tips about cookware and preparation methods.

Notes

- The values in the table always apply to dishes placed into the cooking compartment when it is cold and empty.
Only preheat the appliance if the table specifies that you should do so. Do not line the accessories with greaseproof paper until after they have been preheated.
- The times specified in the tables are guidelines only. They will depend on the quality and composition of the food.
- Use the accessories supplied. Additional accessories may be obtained as special accessories from specialist retailers or from the after-sales service.
Before using the oven, remove any unnecessary accessories and ovenware from the cooking compartment.
- Always use oven gloves when taking hot accessories or ovenware out of the cooking compartment.

Cakes and pastries

Bake on one level

To bake a cake it is best to place it on one level with top and bottom heat .

If baking with hot air , the following levels are recommended for inserting the accessories:

- Cakes in moulds: level 2
- Cakes on a tray: level 3

Baking at different levels

Using the hot air mode .

Baking on two levels:

- Universal tray: level 3.
- Oven tray: level 1.

Trays put in the oven at the same time are not necessarily ready at the same time.

In these tables you will find numerous tips for your dishes.

If 3 rectangular moulds are used at the same time, place on the wire shelf as shown in the diagram.

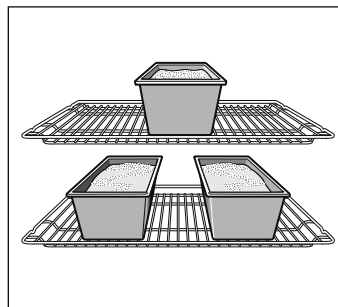

Baking tins

It is best to use dark-coloured metal baking tins.

Baking times are increased when light-coloured baking tins made of thin metal or glass dishes are used, and cakes do not brown so evenly.

If you wish to use silicone baking tins, use the information and recipes provided by the manufacturer as a guide. Silicone baking tins are often smaller than normal tins. The amount of mixture and recipe instructions may differ.

Tables





The table shows the optimum heating methods for each type of cake or dessert. The temperature and cooking time will depend on the amount and the consistency of the dough. For this reason the cooking tables always provide approximate cooking times. Always begin by trying the lowest value. The items will be more evenly browned at a lower temperature. If necessary, this can be increased next time.







If the oven is preheated, cooking times are reduced by 5 to 10 minutes.

Additional information is provided in the Tips for baking section as an appendix to the tables.

To bake a cake only on one level, place the mould on the enamel tray.

When baking several cakes at the same time, the moulds can be placed together on the wire shelf.

Cakes in moulds:	Cookware	Level	Type of heating	Temperature in °C	Cooking time, minutes
Tart	Corrugated tart baking tin, Ø 31 cm.	1		240-260	30-40
	2 corrugated tart baking tins Ø 31 cm.	3+1		180-200	40-50
Quiche	Corrugated tart baking tin, Ø 31 cm.	1		220-230	40-50
Cake	Corrugated cake baking tin Ø 28 cm.	1		190-200	40-50

Food	Accessories	Level	Type of heating	Temperature in °C	Cooking time, minutes
Pizza	Universal tray	2		200-220	25-35
	Universal tray + oven tray	3+1		180-190	35-40
Flambéed tart (preheat)	Universal tray	2		270	15-20
Yeast plait	Universal tray	2		170-190	25-35
Brioche	Oven tray with 12 brioche moulds Ø 8 cm	2		200-220	20-25
Ensaimadas / eclairs	Universal tray	2		200-220	30-45

Food	Accessories	Level	Type of heating	Temperature in °C	Cooking time, minutes
Puff pastry	Universal tray	3	☼	180-200	20-30
	Universal tray + oven tray	3+1	☼	180-190	40-50
Meringue (preheat for 10 minutes)	Universal tray	3	☼	80-90	180-210
Butter cookies (preheat)	Universal tray	3	☐	150-160	20-30
	Universal tray	2	☼	140-160	20-30
	Universal tray + oven tray	3+1	☼	140-150	25-30
Macaroons	Universal tray	2	☐	110-130	30-40
	Universal tray + oven tray	3+1	☼	100-120	35-45
Börek	Universal tray	2	☐	190-200	40-55

Practical cooking tips and suggestions

If you want to use your own recipe.	You can use a similar one listed in the cooking table.
How to check if your sponge cake is ready.	Ten minutes before the end of the cooking time indicated in the recipe, test the thickest part of the cake with a thin wooden skewer. The cake is ready when the skewer comes out clean, with no traces of cake batter left on the skewer.
The cake is too flat.	Next time, try using less liquid or reduce the oven temperature by 10 degrees. Ensure you mix the batter according to the times given in the recipe.
The cake has a peaked centre, but the edges have shrunk.	Do not grease the tin. Once the cake is ready, use a knife to carefully remove it from the tin.
If the cake is too brown on top.	Position the cake deeper in the oven, reduce the oven temperature and bake it for longer.
The cake is too dry.	Use a skewer to make small holes in the finished cake. Pour a few drops of fruit juice or alcohol over the cake. Next time, increase the oven temperature by 10 degrees and reduce the cooking time.
The bread or cake (fruit cake, for example) looks fine on the outside but still has soft (soggy) areas inside.	Next time, use less liquid and leave the product for a little longer in the oven, at a lower temperature. The bases of cakes with juicy toppings should be baked first on their own. Then sprinkle chopped almonds or breadcrumbs on the base before adding the topping. Follow the recipe and observe the cooking times.
Biscuits are not evenly browned.	Select a lower temperature; the biscuits will be browned more uniformly. Bake more delicate pastries with top and bottom heating ☐ on one level. Overhanging greaseproof paper may also affect air circulation. Always trim it to fit the baking tray.
Products have been baked on different levels. Biscuits on the upper tray are darker than those on the lower tray.	Always use the hot air function ☼ when baking products on different levels. Although several baking trays may be placed in the oven at the same time, this does not mean that they will necessarily all be ready at the same time.
Baking moist cakes produces condensation.	Condensation may form when baking. Some of this moisture may evaporate via the door handle, and droplets of condensation may form on the control panel or on the front of nearby kitchen units. The oven is physically designed with this in mind.

Meat, poultry, fish

Cookware

Any heatproof cookware can be used. For large roasts, the enamel tray can also be used.

It is best to use glass containers. Check that the lid of the cookware will fit and close properly.

If using enamel containers, add more liquid.

When using stainless steel pans, the meat does not brown well and may even be left rare. If so, lengthen the cooking time.

Data shown in tables:

Uncovered cookware = open

Covered cookware = closed

Always place cookware in the centre of the wire shelf.

Hot glass cookware should be placed on a dry dishcloth. The glass could shatter if rested on a wet or cold surface.

Roasting

Add in a little liquid if the meat is lean. Cover the base of the ovenware with approx. ½ cm of liquid.

Add liquid generously for pot roasts. Cover the base of the ovenware with approx. 1 - 2 cm of liquid.

The amount of liquid depends on the type of meat and the material the ovenware is made of. If preparing meat in an enamelled roasting dish, it will need a little more liquid than if cooked in glass ovenware.

Roasting dishes made from stainless steel are not ideal. The meat cooks more slowly and browns less fully. Use a higher temperature and/or a longer cooking time.

Grilling

Always use the grill with the oven closed.

For grilling, preheat the oven for about 3 minutes before the food is placed inside the oven.

Place the pieces directly on the wire shelf. If only one piece is prepared, it is best if placed in the centre of the wire shelf.

Place the enamel tray at level 1. The tray will help keep the oven clean by catching any meat juices.

Do not place the baking tray or universal tray at level 4 or 5. Due to the extreme heat, it could be deformed and cause damage to the oven interior when it is removed.

In so far as it is possible, use pieces of the same thickness. This will help them brown evenly and remain juicy. Salt the fillets after grilling.

Turn the pieces after $\frac{2}{3}$ the time has elapsed.

The grill resistance switches on and off automatically. This is normal. The frequency depends on the chosen power level.

Meat

Turn pieces of meat halfway through the cooking time.

When the roast is ready, turn off the oven and allow it to rest for an additional 10 minutes. This allows better distribution of the meat juices.

After cooking, wrap sirloin in aluminium foil and leave it to rest for 10 minutes in the oven.

For roast pork with a rind, score the rind in a crossways pattern, then lay the roast in the dish with the rind at the bottom.

Food	Weight	Accessories and cookware	Level	Type of heating	Temperature at °C, grill power	Cooking time, minutes
Meat						
Rare roast beef	1.0 kg	open	1		240-250	40-50
Roastbeef, medium rare	1.0 kg	open	1		250-260	50-60
Leg of lamb, boneless, rolled, medium rare	1.5 kg	open	1		160-170	100-110
Kebab	1.0 kg	open	1		190-210	100-120
Pork roll	2.0 kg	open	1		170-190	170-180
Poultry						
Chicken	1.5 kg	open	1		190-210	65-85
Duck	2.0 kg	open	1		190-210	100-110
Fish						
Fish, whole, grilled	300 g	Wire shelf + universal tray	2+1		2	20-25
Au gratin dishes.						
Dauphinoise potatoes		Springform tin on the wire shelf	2		160-180	50-70
Toast						
Au gratin toast	12 slices	Wire shelf + universal tray	3+1		170-180	8-12

Tips for roasting and grilling

The table does not contain information for the weight of the joint.	Select the next lowest weight from the instructions and extend the time.
How to tell when the roast is ready.	Use a meat thermometer (available from specialist shops) or carry out a "spoon test". Press down on the roast with a spoon. If it feels firm, it is ready. If the spoon can be pressed in, it needs to be cooked for a little longer.
The roast is too dark and the crackling is partly burnt.	Check the shelf height and temperature.
The roast looks good but the juices are burnt.	Next time, use a smaller roasting dish or add more liquid.
The roast looks good but the juices are too clear and watery.	Next time, use a larger roasting dish and use less liquid.
Steam rises from the roast when basted.	This is normal and due to the laws of physics. The majority of the steam escapes through the steam outlet. It may settle and form condensation on the cooler switch panel or on the fronts of adjacent units.

Cooking a menu

With hot air  you can prepare a full menu in the oven. The oven's heat is fully exploited. With hot air, no smells or flavours are imparted.

Place the cookware on a shelf.

Menu	Cookware	Level	Temperature in °C	Cooking time, minutes	Notes
Menu 1					
Half-cooked boned and rolled leg of lamb, 1.3 kg and baked potatoes	Open cookware	1	180	80	After 30 minutes of cooking, you can place the potatoes around the leg of lamb and put the cake in the oven
Cake	Corrugated tart baking tin, Ø 31 cm	3			
Menu 2					
Half-cooked boned and rolled leg of lamb, 1.3 kg*	Open cookware	1	180	80	After 30 minutes of cooking, you can place the dauphinoise potatoes in the oven. If the topping is overcooked, cover the pan for the last 10 minutes.
Dauphinoise potatoes	Open cookware	3			



















* Suggestion: 20 minutes before the end of the cooking time, you can add tomatoes around the leg of lamb.

Ready-made products

Read the manufacturer's instructions on the packaging.

When covering accessories with baking paper, ensure that the paper is suitable for high temperatures. Cut the paper to the size of dish to be prepared.

The result depends directly on the type of food. There may be irregularities and colour differences in raw products.

Food	Accessories	Level	Type of heating	Temperature at °C, grill power	Cooking time, minutes
Pizza, deep frozen					
Thin base pizza	Universal tray	2		210-230	15-30
	Universal tray + wire shelf	3+1		190-210	20-30
Thick base pizza	Universal tray	2		180-200	20-30
	Universal tray + wire shelf	3+1		180-190	30-35
Pizza-baguette	Universal tray	3		190-200	20-25
Minipizza	Universal tray	3		190-210	10-20
Frozen pizza					
Pizza (preheating)	Universal tray	1		190-210	10-20
Potato-based products, deep frozen					
Chips	Universal tray	3		190-210	20-30
	Universal tray + oven tray	3+1		180-200	30-40
Croquettes	Universal tray	3		200-220	25-30
Potato cakes, stuffed potatoes	Universal tray	3		210-230	15-25
Bakery products, deep frozen					
Bread rolls and baguettes	Universal tray	3		180-200	10-20
Pretzels (bread dough)	Universal tray	3		210-230	15-25
Bakery products, prebaked					
Bread rolls and baguettes	Universal tray	2		190-210	10-20
	Universal tray + wire shelf	3+1		160-180	20-30
Fried foods, deep frozen					
Fishfingers	Universal tray	2		220-240	10-20
Chicken fingers, nuggets	Universal tray	3		200-220	15-25
Strudel, deep frozen					
Strudel	Universal tray	3		200-220	35-40

Special dishes

At low temperatures, a good creamy yoghurt and a spongy yeast dough can be obtained.

First remove accessories and wire shelves or left and right-hand side rails from inside the oven.



Making yoghurt

1. Boil 1 litre of milk (3.5 % fat) and allow it to cool to about 40 °C.
2. Mix 150 g of yoghurt (at fridge temperature).

3. Pour the mixture into jars or bowls and cover them with transparent film.
4. Preheat the oven as instructed.
5. Now, place the bowls or jars on the bottom of the oven and prepare as follows.

Leaving yeast dough to rise

1. Prepare the yeast dough as usual. Pour the dough into a heat-resistant ceramic baking dish and cover it.
2. Preheat the oven as instructed.
3. Turn off the appliance and allow the dough to rise inside the oven.

Food	Cookware	Level	Type of heating	Temperature	Time
Yoghurt	Place the bowls or jars	at the bottom of the oven		Preheat to 50 °C 50 °C	5 min. 8 h
Allow the dough with yeast to rise	Place a heat resistant cookware	at the bottom of the oven		Preheat to 50 °C turn off the appliance and place the dough inside the oven.	5-10 min. 20-30 min.

Defrosting



Defrosting time depends on the type and amount of food.

Follow the manufacturer's instructions on the packet.

Remove the frozen items from the packet and place them in an appropriate pan on the shelf.

Place the bird on a plate with the breast facing down.

Note: The oven light does not come on until reaching 60 °C. This helps achieve optimum precise regulation.

Food	Accessories	Level	Type of heating	Temperature
Delicate frozen products E. g. cream cakes, custard tarts, chocolate or sugar coated cakes, fruit, etc.	Shelf	1		30 °C
Other frozen products Chicken, sausage and meat, bread and rolls, cakes and other pastries	Shelf	1		50 °C





Drying

Use only fruit and vegetables that are in perfect condition and wash them thoroughly first.

Drain well and dry thoroughly.

Place the universal tray on level 3 and the shelf on level 1.

Cover the universal tray and shelf with special baking parchment or greaseproof paper. .

Food	Level	Type of heating	Temperature in °C	Cooking time, hours
600 g of sliced apples	1+3		80	approximately 5 h
800 g of pears cut into chunks	1+3		80	approximately 8 h
1.5 kg of cherries	1+3		80	approximately 8-10 h
200 g of cleaned, fresh herbs	1+3		80	approximately 1½ h

Note: If the fruit or vegetables contain a lot of juice or water, they will have to be turned over several times. Once dried, remove them from the paper immediately.

Jam making

For cooking, the jars and the elastic bands must be clean and in perfect condition. Whenever possible, use jars of equal sizes. The values in the tables are given for round 1-Litre jars.

Caution!

Do not use larger or taller jars. Their lids could explode.

Only use fruit and vegetables that are in good condition. Clean them well.

The times given in tables are only given as an indication. These can vary according to the outside temperature, number of jars, quantity and temperature of the jar content. Before turning off the appliance, ensure the jars have begun to bubble.

Preparation

1. Tip the fruit or vegetable into the jars but do not fill them to the brim.
2. Clean the edges of the jars; these must be clean.

3. Place a cover and wet elastic band on each jar.

4. Close the jars with clamps.

Do not place more than six jars in the oven at the same time.

Setting

1. Place the universal tray on level 2. Place the jars on the tray so that they do not touch each other.

2. Pour ½ litre of water (approx. 80 °C) on the universal tray.

3. Close the oven door.

4. Position the control knob to bottom heat position .

5. Set the temperature between 170 and 180 °C.

Jam making

After approximately 40 - 50 minutes, bubbles begin to form rapidly. Switch the oven off

Take the jars out of the oven after approximately 25 - 35 minutes (the residual heat is used in this time). If these are allowed to cool in the oven for more time, this could promote the formation of germs making the jam acidic.

Fruit in 1 L jars	from when bubbles start to appear	Residual heat
Apples, gooseberries, strawberries	To switch off	approx. 25 minutes
Cherries, apricots, peaches, gooseberries	To switch off	approx. 30 minutes
Apple, pear or cherry puree	To switch off	approx. 35 minutes

Cooking vegetables

When small bubbles begin to form in the jars, adjust the temperature to approximately 120 - 140 °C. About 35 - 70 minutes, depending on the type of vegetables. After this time, turn off the oven to use the residual heat.

Cold cooking vegetables in 1 L jars	When bubbles start to appear 120-140 °C	Residual heat
Peppers	-	approx. 35 minutes
Beetroot	approx. 35 minutes	approx. 30 minutes
Brussels sprouts	approx. 45 minutes	approx. 30 minutes
Beans, kohlrabi, red cabbage	approx. 60 minutes	approx. 30 minutes
Peas	approx. 70 minutes	approx. 30 minutes

Remove the jars from the oven

Remove the jars from inside the oven when cooking is finished.

Caution!

Do not place hot jars on a cold or wet surface. They could explode.

Test dishes

These tables have been produced for test institutes to facilitate the inspection and testing of the various appliances.

In accordance with EN 50304/EN 60350 (2009) and IEC 60350.

Baking

Baking on 2 levels:

Always place the universal deep tray on the upper level and the flat tray on the lower level.

Butter cookies:

Trays put in the oven at the same time are not necessarily ready at the same time.

Apple pie on level 1:

Place dark springform tins with some space between them.





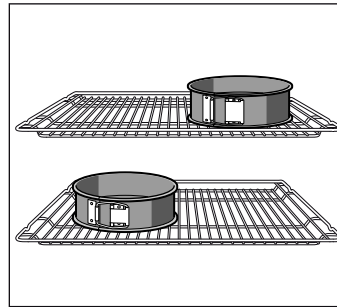







Apple pie on 2 levels:

Place dark springform tins on top of one another.



Corrugated cake springform tins:

Bake using top and bottom heating  on level 1. Use the universal tray instead of the wire shelf and place the springform tins on it.



Food	Accessories and moulds	Level	Type of heating	Temperature in °C	Time in minutes
Butter cookies (preheating*)	Universal tray	3		150-160	20-30
	Universal tray	2		140-160	20-30
	Universal tray + oven tray	3+1		140-160	20-30
Small cakes (pre-heating*)	Universal tray	3		150-170	20-30
	Universal tray + oven tray	3+1		140-160	25-35
	Universal tray	3		150-160	20-25
Sponge cake (preheating*)	Detachable baking tin on the wire shelf	2		170-180	30-40
Sponge cake	Detachable baking tin on the wire shelf	2		160-170	30-40
Pastry case	Universal tray	3		160-180	30-40
	Universal tray	3		140-160	35-45
	Universal tray + oven tray	3+1		160-170	30-40
Apple pie	Wire shelf + 2 springform tins Ø 20 cm.	1		190-210	70-90
	2 wire shelves + 2 springform tins Ø 20 cm.	3+1		170-190	60-80

* Do not use rapid heating to preheat the oven

Shelves and baking trays may be obtained as optional accessories from specialist retail outlets.

Grilling

If food is placed directly on the wire shelf, place the enamel tray at level 1. The tray will help keep the oven clean by catching any meat juices.

Food	Accessories	Level	Type of heating	Grill power	Time in minutes
Brown toast (preheat for 10 min.)	Shelf	5		3	1/2-2
12 beefburgers* (no pre-heating)	Grill + enamel tray	4+1		3	25-30

* Turn once after time 2/3.



Robert Bosch Hausgeräte GmbH

Carl-Wery-Straße 34

81739 München

Germany

www.bosch-home.com



9000753087