

de Bohrschablone
en Drilling template
fr Gabarit de perçage
es Plantilla para taladros

GV 640 Voll-H - 86,7 cm - m.GS - US 9000 689 009 (9109)

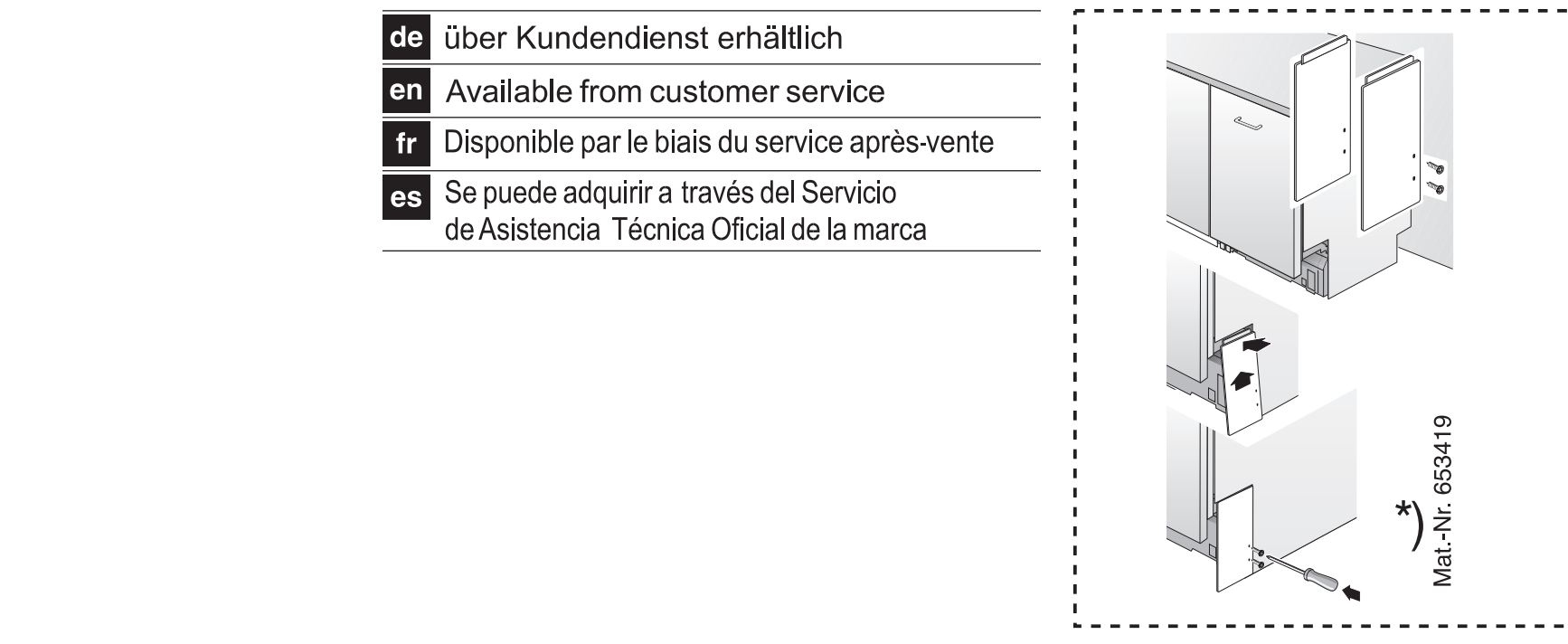

de über Kundendienst erhältlich
en Available from customer service
fr Disponible par le biais du service après-vente
es Se puede adquirir a través del Servicio de Asistencia Técnica Oficial de la marca

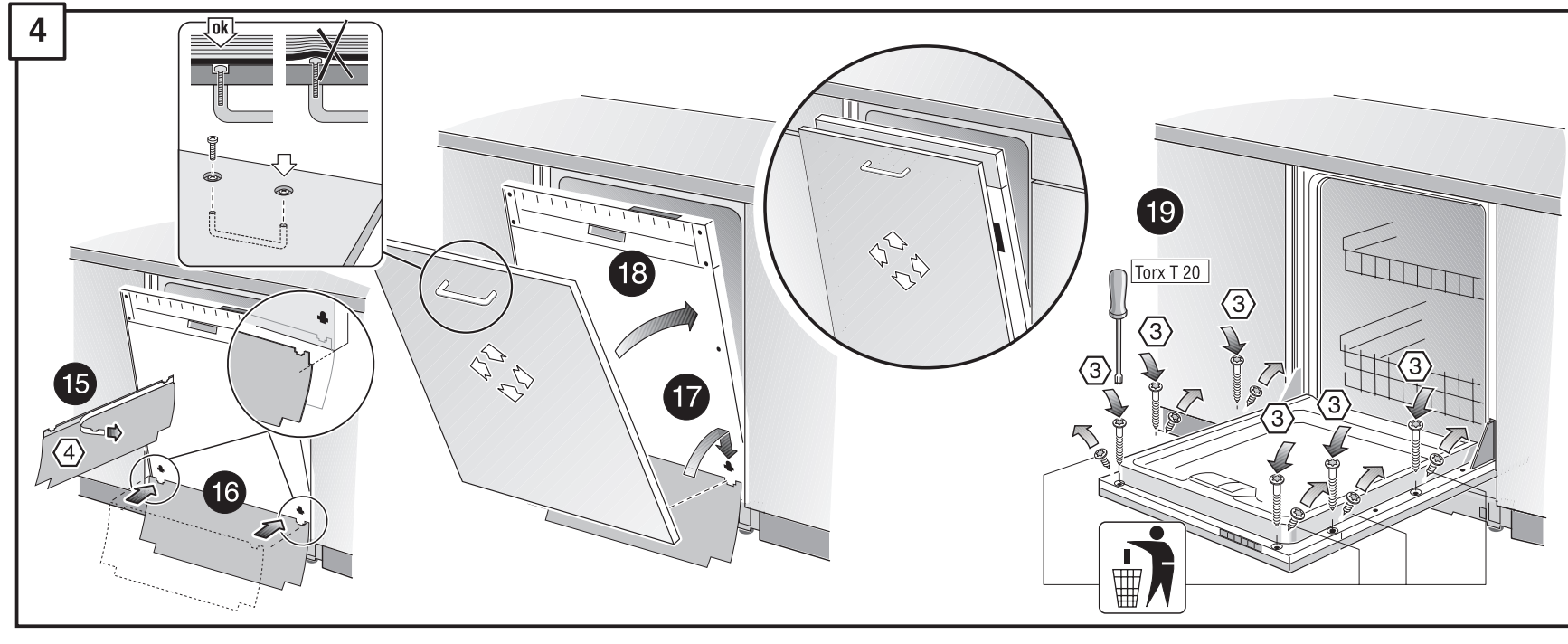
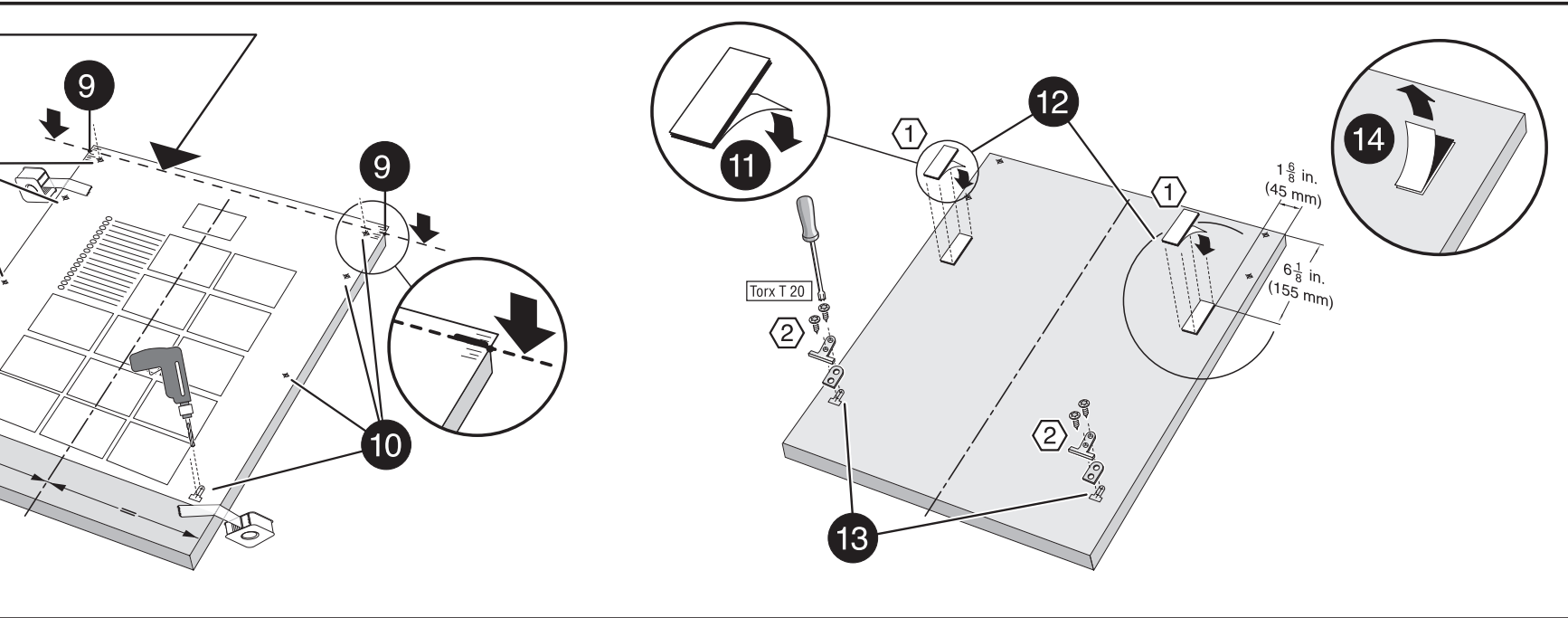
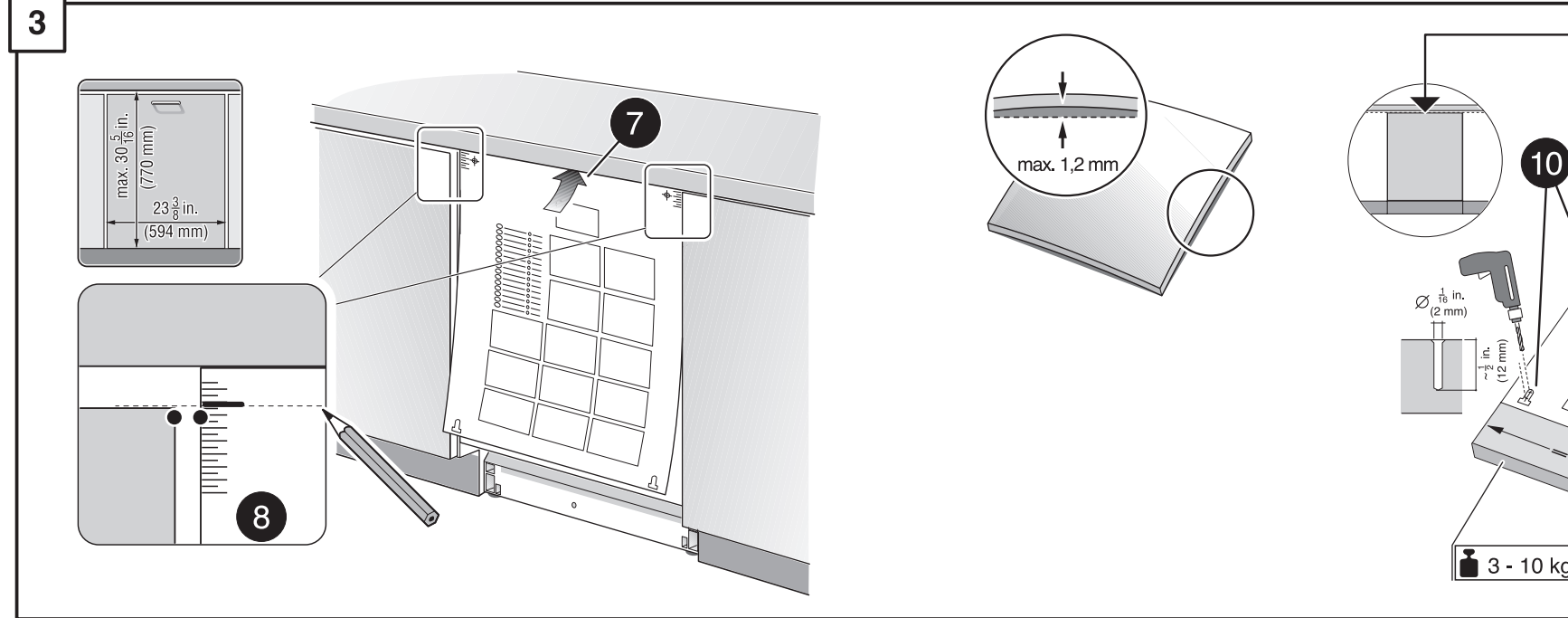
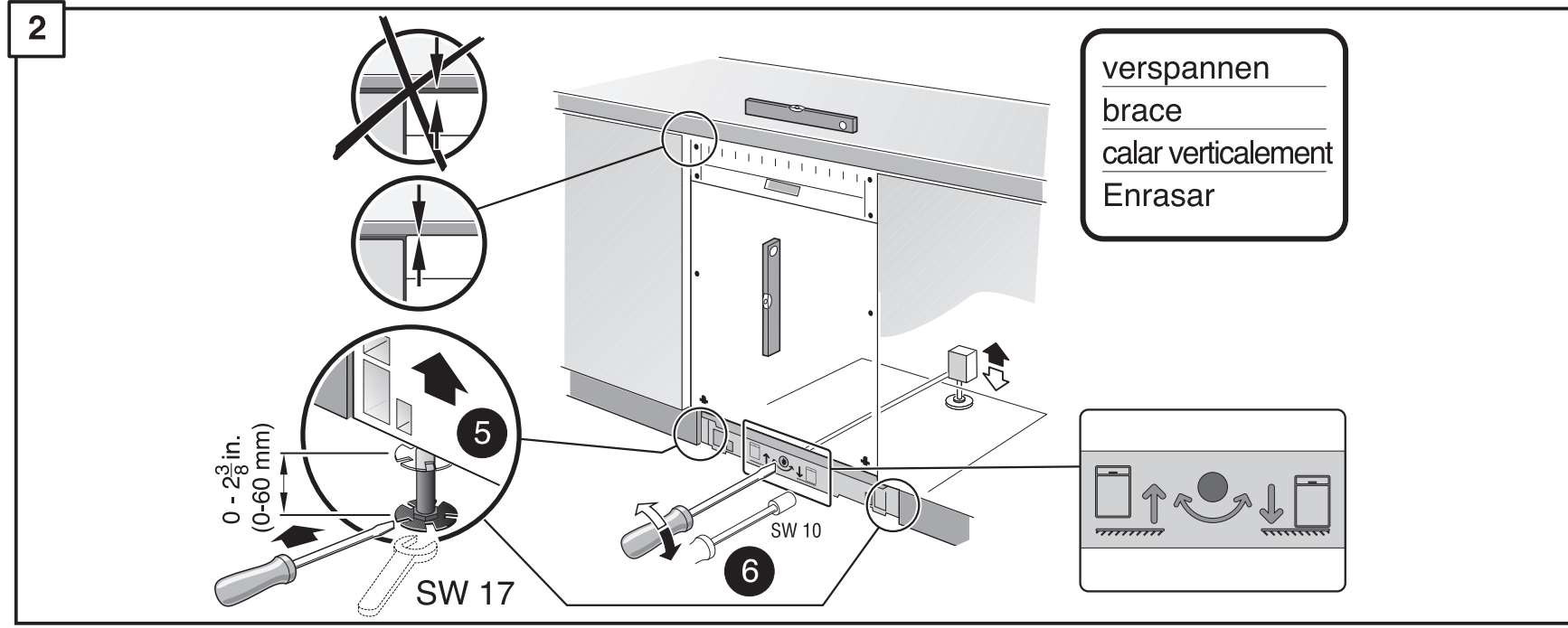
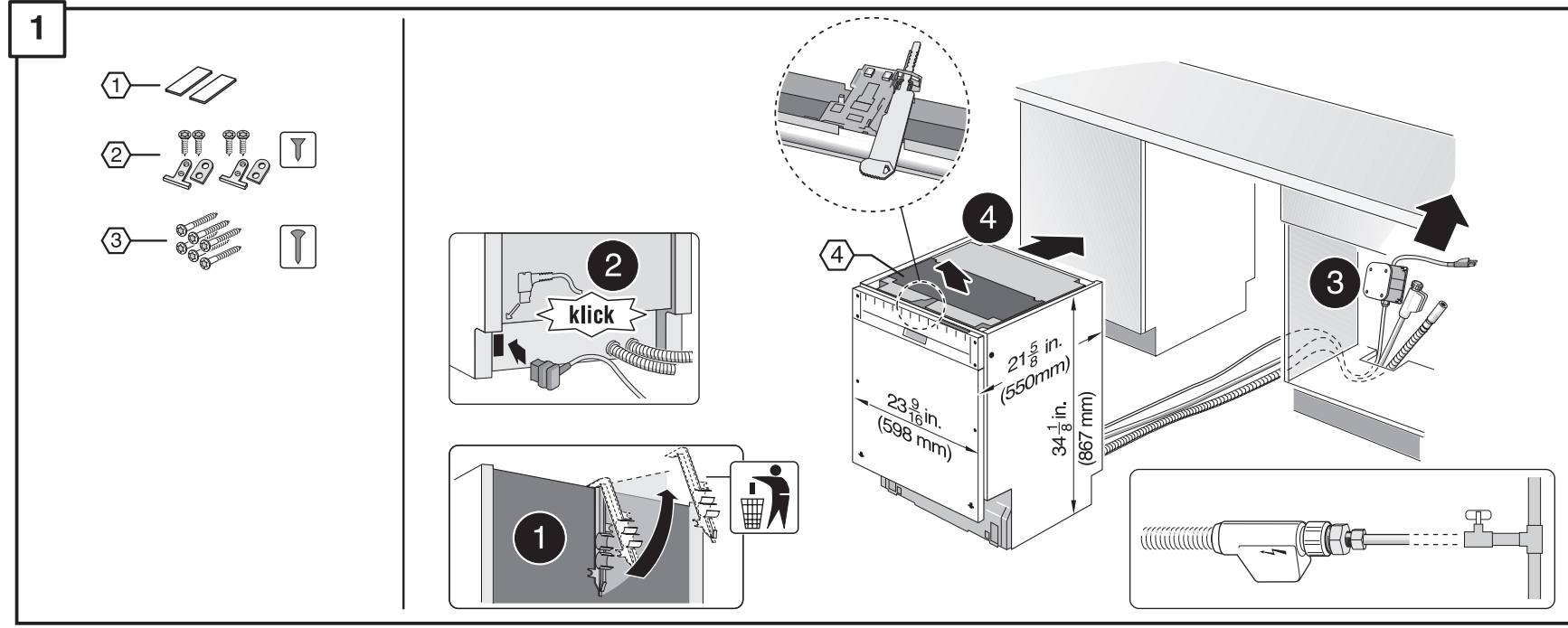