

Dishwasher



BOSCH

9000 531 248 (9001)

en Instructions for use

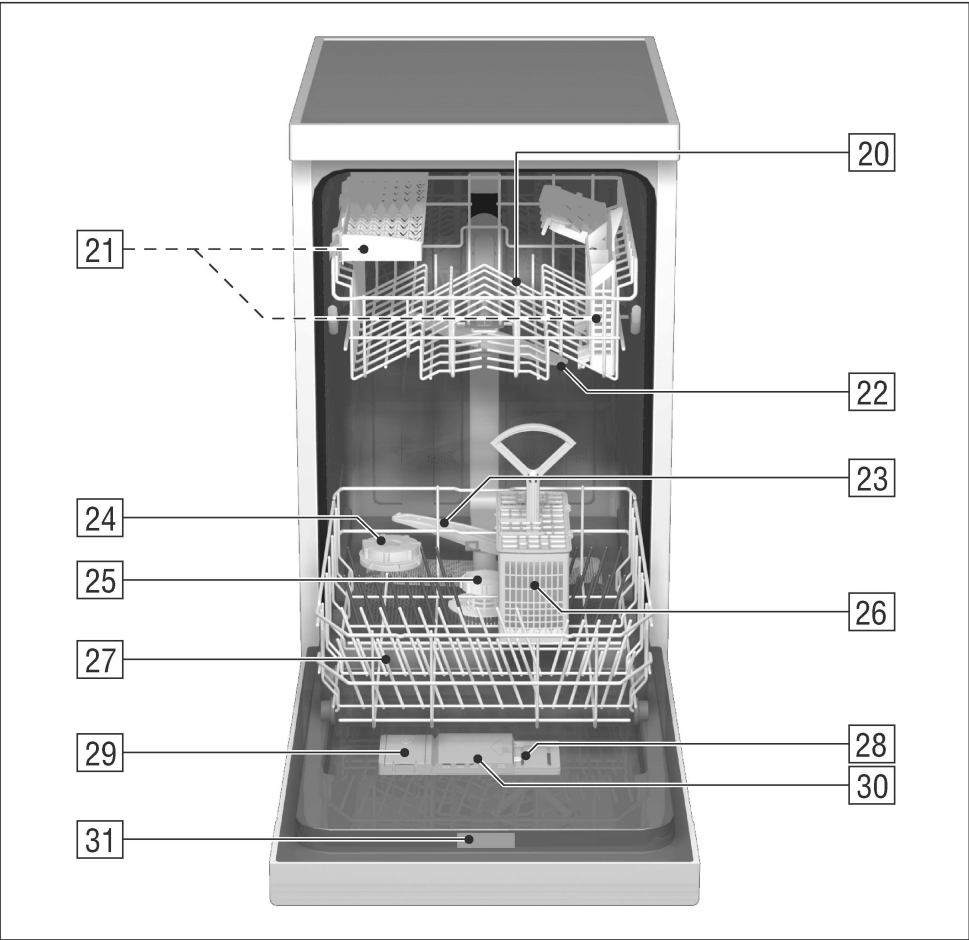
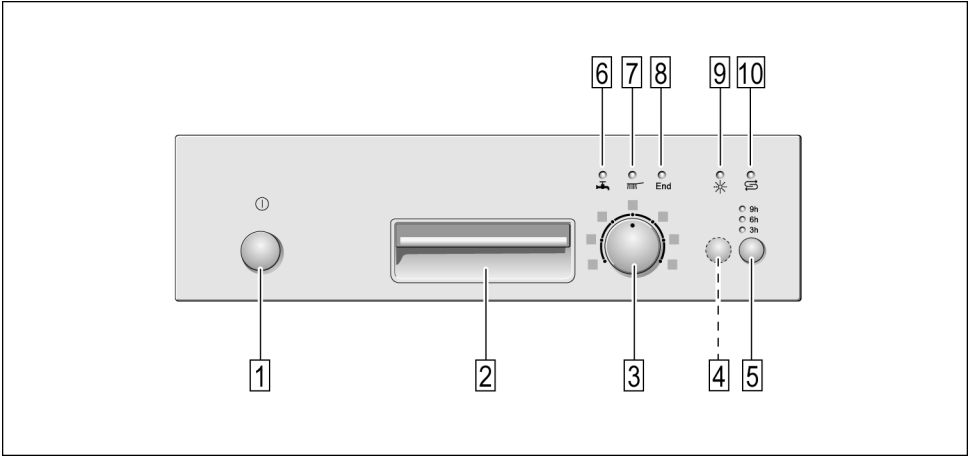

en Index

Safety instructions	4	Washing dishes	15
Getting to know your appliance ..	5	Additional functions	17
Water softener	6	Maintenance and care	17
Filling the salt dispenser	7	Fault finding	19
Adding rinse aid	8	Customer Service	22
Utensils	9	Information	22
Detergent	12	Installation	23
Overview of programmes	14	Waste disposal	24

Safety instructions

Delivery

- Immediately check the packaging and dishwasher for any damage which may have been caused in transit. Do not use a damaged appliance, but consult your supplier.
- Please dispose of packaging material properly.

Installation

- Install and connect the appliance according to the installation and assembly instructions.
- The dishwasher must NOT be connected to the power supply during installation.
- Ensure that the protective conductor system of the domestic electricity supply has been installed correctly.
- Electrical connection conditions must correspond with the specifications on the rating plate of the dishwasher.
- If the dishwasher is to be installed in a high-sided unit, ensure that the unit is attached properly and also at the rear.
- Built-under and built-in appliances should always be installed under a continuous work surface which is attached to the adjacent cupboards, in order to ensure that the appliance is entirely stable.
- After the appliance has been installed, the mains plug should still be easily accessible.
- Not on all models:
The plastic housing on the water input contains an electrically operated valve. The connecting wires are inside the inlet hose. Do not cut through this hose and do not immerse the plastic housing in water.



Warning

For safety reasons, if the appliance is not fitted in a recess, thereby making a side wall accessible, the door hinge area should be covered at the side.

(Risk of injury)

Covers are available as optional accessories from customer services or specialist stores.

In daily use



Warning

Knives and other sharp-pointed utensils must be placed with the points down in the cutlery basket or horizontally in the utensils basket.

- Use the dishwasher only in the household and only for its designed purpose, i.e. for washing domestic dishes.
- Do not lean or sit on the open door. The appliance could tip.
- Please note that free-standing appliances may tip over if the baskets are overloaded.
- The water in the appliance is not drinking water.
- Do not add any solvents to the washing chamber. Danger of explosion!
- Open the door carefully when the programme is still running. There is a risk of hot water spraying out of the appliance.
- To prevent injuries, e.g. caused by stumbling, open the dishwasher only briefly in order to load and unload the dishwasher.
- Read and observe the safety information and instructions for use on the packaging for cleaning and rinsing agents.

Children in the household

- If fitted, use the childproof lock. An exact description can be found in the back of the envelope.
- Do not allow children to play with or operate the appliance.
- Keep children away from detergents and rinse aid. These may cause chemical burns in the mouth, throat and eyes or asphyxiation.
- Keep children away from an open dishwasher. There could still be detergent residue inside.
- If the appliance is installed at eye-level, ensure when opening and closing the door that children are not caught or crushed between the appliance door and the cupboard door situated below.

Damage

- The appliance may be repaired and opened up by a technician only. First disconnect the appliance from the power supply. Pull out the mains plug (do not tug the power cord!) or switch off the fuse. Turn off the tap.

Disposal

- Make redundant appliances unusable to prevent subsequent accidents.
- Dispose of the appliance in an environmentally friendly manner.



Warning

Children could get locked in the appliance (risk of suffocation) or get stuck in other positions.

Therefore: Remove the mains plug, cut the mains wire and set aside. Damage the door lock so that the door can no longer be closed.

You will need to purchase the following before using the dishwasher for the first time:

- special salt for use in dishwashers
- detergent
- rinse-aid

Only use products, which are suitable for dishwashers.

Getting to know your appliance

Diagrams of the control panel and the interior of the appliance can be found in the envelope at the front.

Individual positions are referred to in the text.

Control panel

- 1 Main switch
- 2 Door Opener
- 3 Programme selector (retractable*)
- 4 Additional options*
- 5 Time delay
- 6 “Check water supply” display
- 7 Programme sequence display
- 8 “End of programme” display
- 9 Rinse-aid refill indicator
- 10 Salt refill indicator

* some models

Appliance interior

- 20 Upper basket with additional cup rack
- 21 Additional cutlery basket for the top basket*
- 22 Top spray arm
- 23 Bottom spray arm
- 24 Dispenser for salt
- 25 Filters
- 26 Cutlery basket
- 27 Bottom basket
- 28 Lock for detergent dispenser
- 29 Dispenser for rinse aid
- 30 Detergent dispenser
- 31 Rating plate

* some models

Water softener

In order to rinse dishes and glasses satisfactorily, the dishwasher requires soft water, i.e. containing little or no lime, otherwise water stains will be left behind on crockery and glasses, etc.

If the tap water exceeds a certain level of hardness, it must be softened, i.e. decalcified, so that it can be used in the dishwasher.



This is achieved by adding a special salt to the water softener inside the dishwasher.

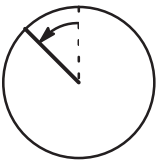

The water softener, that is the required amount of salt, is set up according to how hard the tap water is.

Setting up the water softener















- Determine the level of hardness of your tap water. Your local water company or service agent can help you with this.
- Identify setting from the following water hardness table.
- Close the door
- Rotate the programme selector from the 12 o'clock position by one notch to the left.



- Switch on main switch and hold down for at least 3 sec.
The display flashes and the lamps above the symbols  and  light up. (hardness value has been set to 2 at the factory).
- To change the setting: Rotate the programme selector .
You can select a set value between 0 and 3 according to the hardness of your water.

If the lamps ,  and End light up, the maximum set hardness value has been reached. If the set hardness value is now increased again, the lamps go out and the set hardness value is set to 0 (no lamp lights up).
- Switch off the main switch .
The chosen setting has now been stored.

Water hardness table

°dh	°FH	°Clarke	mmol/l				
0-6	0-11	0-8	0-1,1	0			
7-16	12-29	9-20	1,2-2,9	1			
17-21	30-37	21-26	3,0-3,7	2			
22-35	38-62	27-44	3,8-6,2	3			

Filling the salt dispenser

Salt must always be filled before the appliance is switched on, so that excess salt solution is immediately flushed away to prevent corrosion.

- Open the screw-type cap of the compartment 24.
- Before using the appliance for the first time, pour about 1 litre of water in the salt container.
- Then refill with salt (**not cooking salt**) until the salt container is full (max. 1.5 kg). When you refill the salt, water is being displaced and drains off.

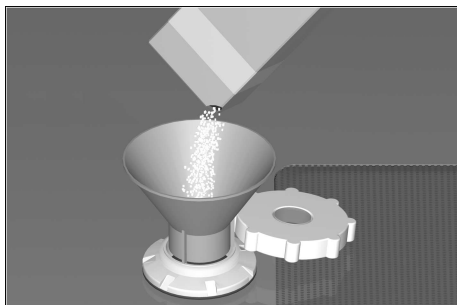

The LOW SALT indicator 10 on the front panel will light up initially but will extinguish again after a short period when the salt solution has become sufficiently concentrated.

If the set hardness value is "0", do not add salt because no salt is used during operation; the salt refill indicator is switched off.



Warning

Do not pour detergent into the container for special salt. This would destroy the water softener.

Salt refill indicator

As soon as the salt refill indicator 10 is lit on the control panel, refill with salt immediately before the next rinse cycle.

Depending on the washing frequency and the hardness setting, the regeneration salt may not have to be topped up for several months.

Adding rinse aid

The rinse aid is required for stain-free utensils and clear glasses. Use only rinse aid for domestic dishwashers.

- Open the cover on the rinse-aid dispenser [29]. To do this, press the mark (1) on the cover and simultaneously lift the cover on the control plate (2).

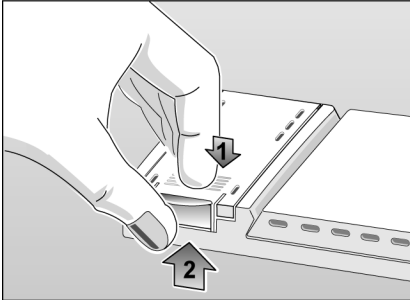

- Carefully pour in the rinse aid to just below the edge of the filler opening.

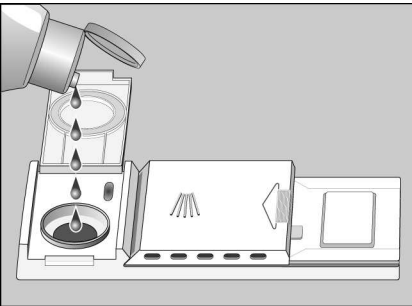

- Close the lid, ensuring that you hear it snap closed.

To prevent excessive foam formation during the next rinse cycle, remove any rinse aid which has run over with a cloth.

Adjusting the amount of rinse-aid

The amount of rinse-aid added to the water can be varied by adjusting the stepless control. The rinse-aid control has been set to "4" in the factory.

Do not alter the setting of the rinse-aid control unless streaks (turn knob towards "–") or water marks (turn knob towards "+") are left on the dishes.

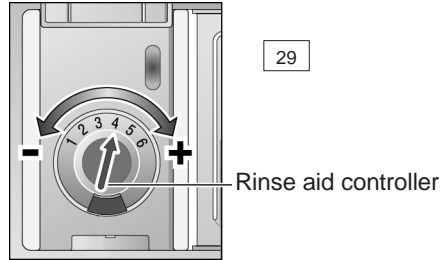

Rinse-aid refill indicator

As soon as the rinse-aid refill indicator lights up on the control panel [9], refill with rinse aid.

Utensils

Not suitable

- Cutlery and utensils made of wood.
- Fragile decorative glasses, hand-crafted and antique utensils. These decorative items are not dishwasher-proof.
- Plastic parts sensitive to hot water.
- Copper and tin utensils.
- Utensils which are soiled with ash, wax, lubricating grease or ink.
- Absorbent materials such as sponges and cloths.

Aluminium and silver parts have a tendency to discolour and fade during the wash cycle. Even some types of glass (e.g. crystal glass objects) may turn cloudy after many wash cycles.

Recommendation:

In future buy utensils which are identified as dishwasher-proof.

Damage to glassware and other dishes

Possible causes:

- type of glass or manufacturing process
- chemical composition of detergent
- water temperature and duration of dishwasher programme.

Suggested remedy:

- Use glassware or porcelain dishes that have been marked 'dishwasher-proof' by the manufacturer.
- Use a mild detergent that is described as 'kind to dishes'. If necessary, seek further information from detergent manufacturers.
- Select a programme with as low a temperature and as short a duration as possible.
- To prevent damage, take glass and cutlery out of the dishwasher as soon as possible after the programme has ended.

Loading the dishwasher

- Remove large food remnants. It is not necessary to rinse them off under running water.
- When loading the dishwasher, ensure that
 - all utensils are secure and cannot fall over.
 - the openings of all receptacles are face down.
 - curved or indented utensils are at an incline, allowing water to drain.
 - the two spray arms can rotate freely.

Very small items should not be washed in the dishwasher as they could easily fall out of the baskets.

Removing the dishes

To prevent water dripping from the top basket onto the dishes in the lower basket, we recommend that you empty the lower basket first and then the top basket.

Cups and glasses

Upper basket 20

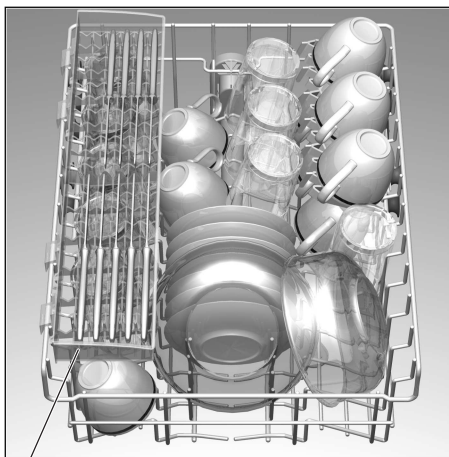

* not included with all models

Pots and pans

Lower basket 27

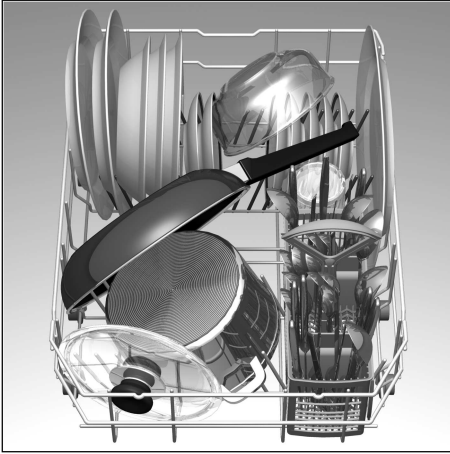

Cutlery

Cutlery should be placed in the dishwasher always unsorted and with the eating surface pointing downwards. The spray jet is then better able to reach the individual parts.

To prevent injuries, place long, pointed accessories and knives on the étagère (some models) or on the knife shelf (available as an accessory).

Folding spikes *

* on applicable models

To improve stacking of pots and pans, the spikes can be folded down.

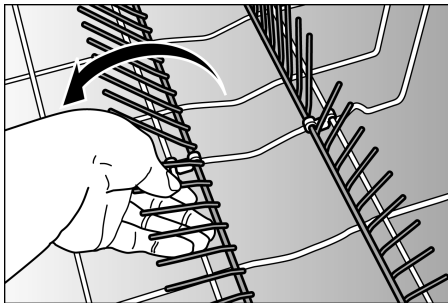

Shelf *

* not on all models

Lean tall glasses and those with long stems against the shelf – not against other items to be washed.

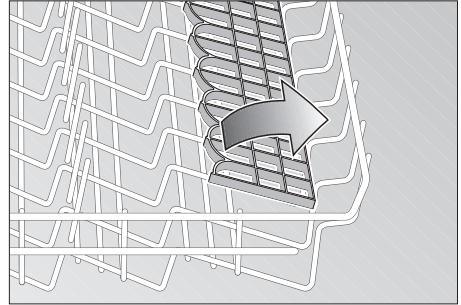

Place glasses, cups and small bowls on the additional cup rack. The additional cup rack can be swivelled in or out as required.

Small accessories holder*

* some models

Light-weight plastic accessories, e.g. cups, lids, etc. can be held securely in the small accessories holder.

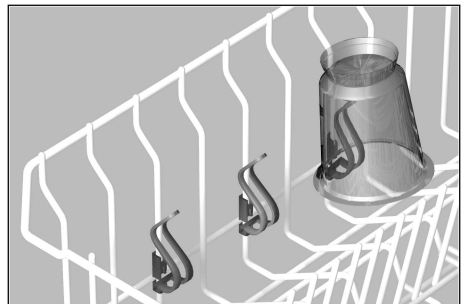

Adjusting the height of the basket *

* some models

If required, the height of the upper utensils basket can be adjusted to provide more space for tall utensils either in the upper or lower basket.

Appliance height in cm	81
Max. ø in cm upper	20/25*
max. ø in cm lower	28/23,5*

Top basket with upper and lower roller pairs

Select one of the two following procedures according to the design of the top basket for your appliance model:

- Pull out the top basket.
- Remove the top basket and re-attach it to the upper or lower rollers.

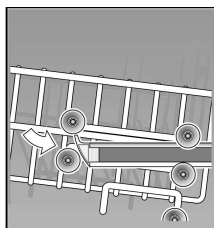
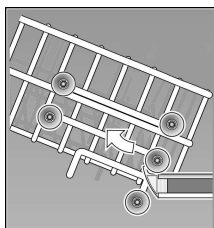

Top basket with side levers (Rackmatic)

- Pull out the top basket.
- To **lower** the basket, press in one lever and then the other situated on the left and right of the basket exterior, holding the basket firmly on the sides of the upper edge to prevent it from falling down.

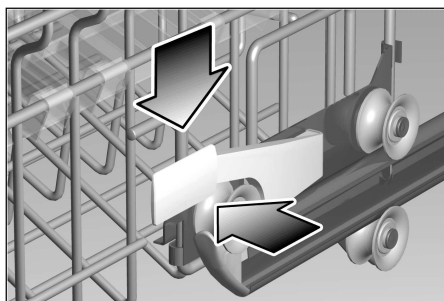

- To **raise** the basket, hold the basket on the sides of the upper edge and lift it up.
- Before re-inserting the basket again, ensure that it is at the same height on both sides. Otherwise, the appliance door cannot be closed and the upper spray arm will not be connected to the water circuit.

Detergent

You can use commercially available liquid or powder proprietary detergents for dishwashers or TABS (do not use handwash!).

If phosphate-free detergents are used with hard tap water, white deposits may be deposited more easily on utensils and the container walls. This can be remedied by adding more detergent.

See detergent packaging to determine whether a detergent is suitable for silver parts.

If you have any other questions, we recommend that you contact the helplines of the detergent manufacturers.

Detergent dispenser with dosing aid

The graduated detergent dispenser helps you pour in the correct amount.

Lower line: 15 ml

Middle line: 25 ml

Full to the brim: 40 ml

If the detergent dispenser [30] is still closed, press the lock [28] to open the detergent dispenser.

Adding detergent

- Fill the dispenser [30] with detergent.
Dosage: see manufacturer's instructions on the detergent packaging.



Note

The cleaning tabs from various manufacturers exhibit differing dissolving properties, so washing power may not develop fully during short programmes and there may be undissolved cleaning agent residue. It is recommended to use washing powder for these programmes.

The Intensive programme (on some models) requires one tab only. When using washing powder, you can apply some of this cleaning agent to the inside of the appliance's door.



Reduce costs!

If your dishes are only moderately dirty, you may be able to use less detergent than recommended.

- Close the lid on the detergent compartment.
Press down the lid (1) until it clicks shut (2).

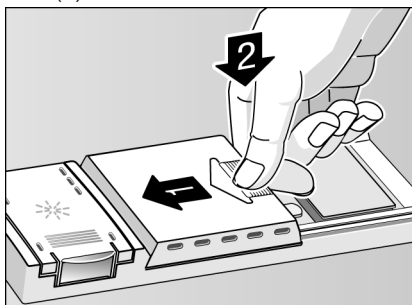

- If you are using detergent in tablet form, read the manufacturer's recommendations on the packaging in order to determine where the tablets should be placed inside the dishwasher (e.g. in cutlery basket, detergent compartment, etc.).
Make sure that the lid on the detergent compartment is closed, even if you are using tablets.

 **CAUTION**
IMPORTANT NOTE
ON THE USE OF
COMBINED CLEANING
PRODUCTS

Please note the following when using "combined cleaning products" which eliminate the need for a rinsing agent or salt, for example:

- Some products with a built-in rinsing agent are only used to their full effect in certain programmes.
- This type of product does not generally produce the desired effect with automatic programmes.
- Products which eliminate the need for regeneration salt can only be used within a certain water hardness range.
- If you wish to use these combined products, please read the instructions carefully and heed any notes on the packaging.

Contact the manufacturer of the cleaning agent if you have any questions, particularly if:

- the crockery is very wet once the programme has finished.
- limescale deposits are formed.

Any problems which arise as a direct result of the use of these products are not covered by our warranty.

Overview of programmes

The max. possible number of programmes is illustrated in this overview.
The corresponding programmes for your appliance can be found on the fascia.

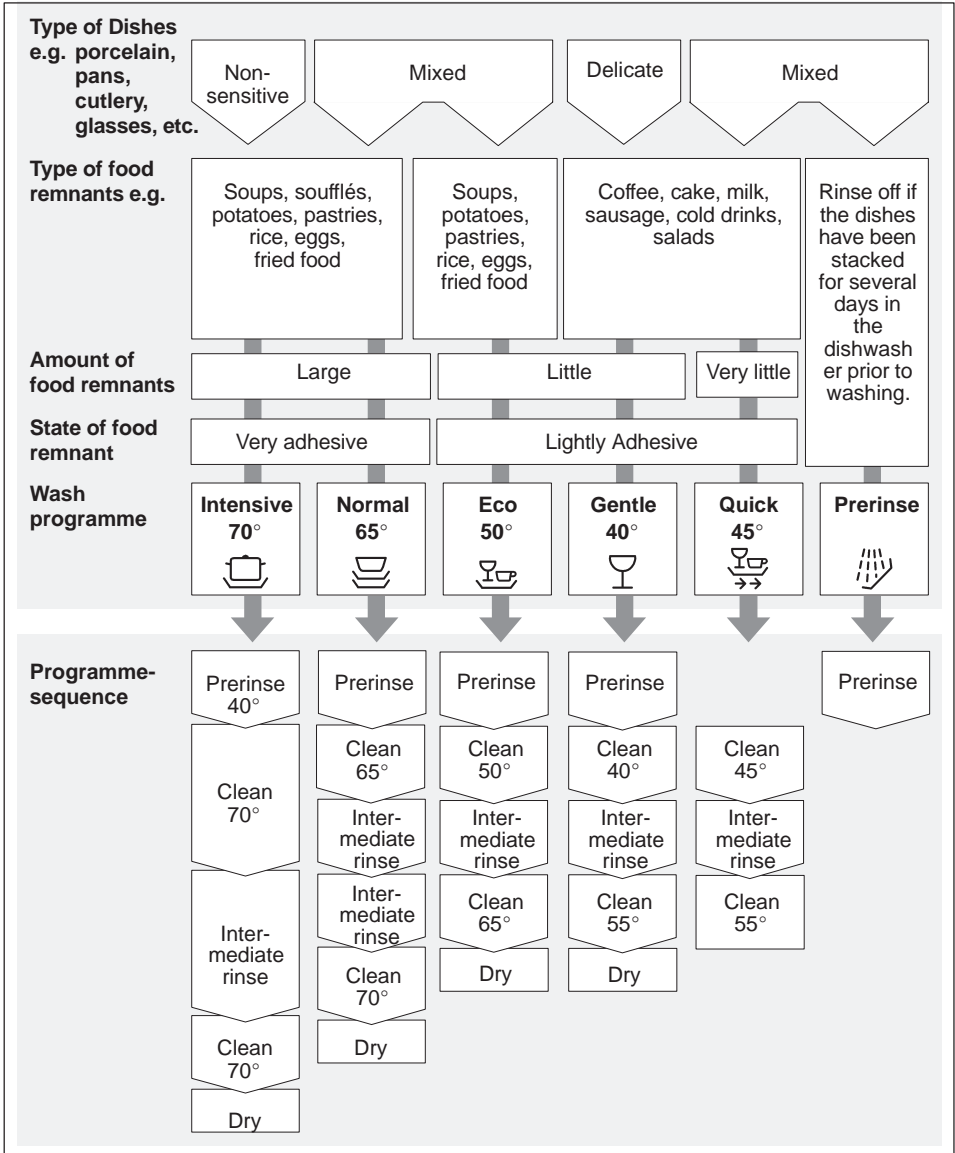

Programme selection

The most appropriate programme can be identified by comparing the type of crockery, cutlery, etc., as well as the amount and condition of food remains, with the details contained in the programme overview.

You will find the appropriate programme information in the introduction.

Washing dishes



Reduce costs!

If only a small number of dishes have been loaded into the dishwasher, selecting a programme that operates at the next lowest temperature will usually suffice.

Programme data

The programme data (duration, energy and water consumption) can be found in the summary of instructions and refers to standard conditions. Greater deviations may be caused by:

- different quantities of utensils
- inlet temperature of the water
- water pressure
- ambient temperature
- mains voltage tolerances
- and appliance-specific tolerances (e.g. temperature, water flow rate, etc.)

The water consumption values refer to water hardness value 2.

Switching on the appliance

- Close the door.
- Turn on the tap fully.
- Rotate programme selector to the required programme.
- Switch on the main switch .

The programme sequence display lights up, the programme sequence starts automatically.

Timer programming *

* some models

You can delay the start of the programme by up to 9 hours.

- Switch on the appliance.
- Press the timer programming button until the display comes on. The start of the programme is delayed by 3 hours.

- Keep pressing the timer programming button **5** until the time you require (3, 6, or 9, hours) is displayed.
- To delete the timer programming, keep pressing the timer programming button **5** until the display goes out.

You can change your programme selection at any time until the programme starts.

End of programme

The programme ends when the Programme progress indicator **7** has gone out and the End-of-programme indicator **8** illuminates. When the programme ends, the "Top basket washing" function is de-activated if required (only some models).

Several minutes after the programme has ended:

- Open the appliance door.
- Wait until the dishes have cooled down and then remove.

When the programme has ended, you can either switch off the appliance or restart it with the same or another programme.

Switching off the appliance

Several minutes after the end of the programme:

- Switch off the main switch **1**. "End of programme" display **8** goes out.
- Turn off the tap (does not apply to Aqua Stop). It is not necessary to adjust the programme selector.
- Remove the utensils when they have cooled down.

At the end of the programme please open the door fully and not partially when emptying the dishwasher. Any escaping water vapour could damage sensitive worktops.

Interrupting the programme

- Set the main switch **1** to OFF.
- Indicator lights extinguish.

If the hot water was switched ON or the appliance has already heated up and then the appliance door opened, leave the door ajar for several minutes and then close. Otherwise, the appliance door may fly open due to expansion.

- In order to resume the programme, set the main switch to ON again.

Terminating the programme (Reset)

- Only when the main switch is on: Rotate programme selector to the Reset position.
- The programme sequence lasts approx. 1 min.
- When the programme has run, switch off the main switch **1**.

To restart, rotate the programme selector **3** to the required programme. Switch on the main switch **1**. The programme sequence starts automatically.

Changing the programme

It is possible to change the programme within 2 minutes after you have switched the dishwasher on.

Should it be necessary to change the programme after this period, the programme cycle that has already been begun (e.g. washing) will be completed first of all.



Note

If the power supply is disconnected while the appliance is operating, e.g. by switching off the appliance or due to a power failure, all settings remain stored. Operation continues automatically as soon as the power supply is restored.

Additional functions

* on some models additional functions  can be set with the buttons.

Soaking *

The soaking cycle runs before the main programme and must be selected before the programme starts. In this additional programme cooking utensils, e.g. pans, bowls, etc., can be soaked and prerinsed in the **bottom basket**.

It is recommended to put approx. 5 g of detergent on the door.

Reduce/save time*

The rinsing times and the drying phase are reduced. The reduced time **lowers** the rinsing and drying performance.

Top basket washing only *

If there are only a few utensils (e.g. glasses, cups, plates), use the top basket. The bottom basket must be empty! Use slightly less detergent than is recommended for a complete load.

Bottom basket washing only *

If there are only a few utensils (e.g. plates, pans, bowls), use the bottom basket. The top basket must be empty! Use slightly less detergent than is recommended for a complete load.

Maintenance and care

A regular inspection and maintenance of your machine will help to prevent faults. This saves time and prevents problems.

Overall condition of the machine

- Check washing chamber for grease and limescale deposits.

If you find such deposits:

- Fill the detergent dispenser with detergent, start the appliance without utensils in the programme which has the highest wash temperature.

Clean the appliance with detergents/appliance cleaners which are particularly suitable for use with dishwashers.

- Regularly wipe the door seal with a damp cloth.

Never use a steam cleaner to clean your dishwasher. The manufacturer is not liable for any consequential damage.

Regularly wipe the front of the appliance and panel with a damp cloth; water and a little washing-up liquid will suffice.



Do not use sponges with a rough surface or abrasive detergents, as these could scratch the surfaces.



Attention!

Never use other chlorinated household detergents! Health hazard!

Salt and rinse aid

- Check the refill indicators  . If required, top up the salt and/or rinse aid.

Filters

The filters [25] prevent large particles of food in the water from reaching the pump. These particles may occasionally block the filters.

- When the appliance has finished washing, check the filters for particles of food and, if required, clean.
- After undoing the coarse micro-filter, the filter unit can be removed. Remove any particles of food and rinse the filters under running water.
- Insert the filter unit and tighten the coarse micro-filter.

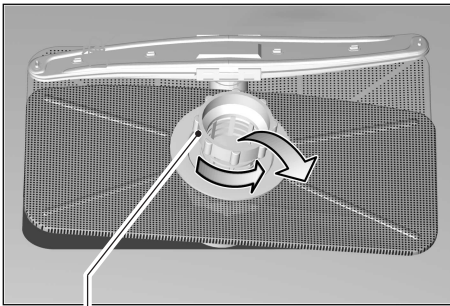

Coarse/microfilter

Spray arms

Lime and remnants of food in the washing water can block the nozzles in the spray arms [22] and [23] and the arm mountings .

- Inspect the nozzles in the spray arms for blocked holes due to remnants of food.
- If necessary, pull the lower arm [23] upwards and lift it off.
- Unscrew the upper spray arm [22] .
- Clean both spray arms under running water.

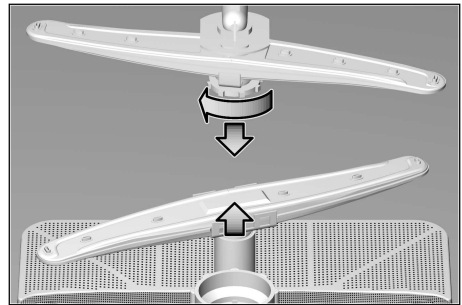

- Refit the spray arms. Ensure that the lower arm has locked into place and the upper one is screwed tight.

Pump *

* on applicable models

Larger remnants of food that have not been trapped by the filters and have been left in the water can cause a blockage in the pump. The water is no longer pumped out of the dishwasher and it can be seen covering the filter.

Proceed as follows:

- First, always disconnect the appliance from the power supply.
- Ladle out as much water as possible.
- Remove the filters [25](#).
- Undo the screw in the cover (Torx T 20) and remove the cover.
- Inspect the inside and remove any obstructions that you find.
- Re-insert the cover and screw down.
- Re-insert the filters and screw down.

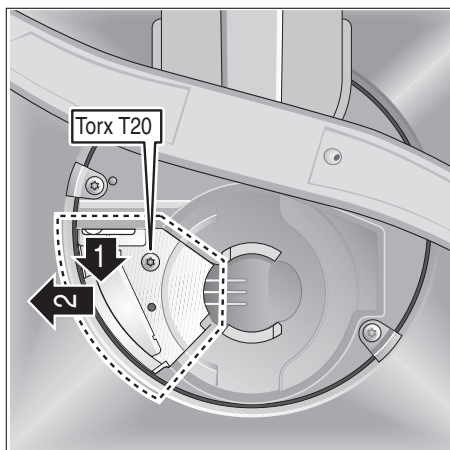

Fault finding

Resolving minor problems yourself

Experience has shown that you can resolve most problems that arise during normal daily usage yourself, without having to call out a service engineer. Not only does this save costs, but it also means that the appliance is available for use again that much sooner. The following list of common occurrences and their remedies should help you identify the causes of most problems.

Problems ...



Attention

Remember: Repairs may be carried out by a technician only. If a component has to be replaced, ensure that only original spare parts are used. Improper repairs or use of non-original spare parts may cause considerable damage and put the user at considerable risk.

... when the appliance is switched on

- **The appliance does not start.**
 - The mains fuse has tripped.
 - The appliance plug has not been inserted.
 - The appliance door has not been shut properly.
 - The tap has not been turned on.
 - The filter on the water supply hose is blocked.

Switch off the appliance and pull out the mains plug. Turn off the tap. Then clean the filter which is situated at the connection of the supply hose. Finally, restore the power, turn on the tap and switch on the appliance.

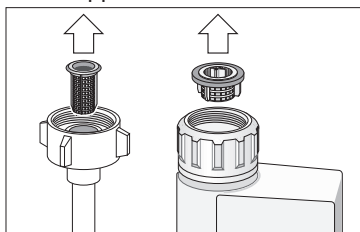

... with the appliance itself

- **Lower spray arm rotates with difficulty**
 - Spray arm is blocked by small items or food remains.
- **Lid in detergent compartment cannot be closed**
 - Detergent compartment has been overfilled.
 - Mechanism is clogged with remnants of detergent. Indicator lamps do not extinguish after washing has finished.
- **Indicator lights flash after the programme has started.**
 - No programme selected.
- **Indicator lamps do not extinguish after washing has finished**
 - Main switch is still set to ON.

- **“Check water supply” display 6 lights up.**
 - Tap turned off.
 - Water supply interrupted.
 - Filter in the water supply blocked.
 - Supply hose kinked.
- **Remnants of detergent stuck inside dispenser**
 - Compartment was damp when it was filled up with detergent. Compartment must be dry before detergent is added.
- **Water remains inside appliance after programme has ended**
 - Blockage or kink in drainage hose.
 - Pump is jammed.
 - Filters are blocked.
 - The programme is still running. Wait for the programme to end.
 - Perform “Reset” function.

... during washing

- **Unusual amount of foam is created**
 - Normal washing up liquid has been poured into the rinse-aid container.
 - Remove any spilled rinse aid with a cloth as it could otherwise lead to excessive foaming during the next washing cycle.
- **Appliance stops suddenly while washing is taking place**
 - Cut in electricity supply to appliance.
 - Water supply has been interrupted.
- **Knocking sound can be heard while washing is taking place**
 - A spray arm is knocking against the dishes inside the appliance.
- **Rattling sound can be heard while washing is taking place**
 - Crockery has not been stacked properly inside the appliance.

- **Knocking sound coming from inlet valves**
 - This is caused by the way the water pipes have been laid and it has no effect upon the way the appliance functions. There is no remedy for this.
- ... with the dishes, cutlery, etc.
- **Remnants of food are stuck to the dishes, cutlery, etc.**
 - Dishwasher was not loaded properly. Jets of water could not reach all parts of the dishes, etc.
 - Too many items in the rack.
 - Items in the rack were touching each other.
 - Not enough detergent was added to dispenser.
 - Selected wash programme was not intensive enough.
 - Rotation of spray arm was obstructed by dish, etc.
 - Nozzles in spray arm are blocked by remnants of food.
 - Filters are blocked.
 - Filters have been incorrectly fitted.
 - Waste-water pump is jammed.
- **Plastic items are discoloured**
 - Not enough detergent was added to dispenser.
- **White stains are left on crockery, glasses have a milky appearance**
 - Not enough detergent was added to input compartment.
 - Amount of rinse-aid was set too low.
 - Although water is quite hard, no salt has been put in appliance.
 - Water softener was set too low.
 - Lid on salt container is not screwed tight.
 - If you used a phosphate-free detergent, try a detergent containing phosphates and compare results.
- **Dishes, cutlery, etc. have not been dried**
 - Selected programme did not include drying function.
 - Amount of rinse-aid was set too low.
 - Items were removed from dishwasher too soon.
- **Glasses have a dull appearance**
 - Amount of rinse-aid was set too low.
- **Tea stains or traces of lipstick have not been completely removed**
 - Detergent does not have a sufficient bleaching effect.
 - Washing temperature was set too low.
- **Traces of rust on cutlery**
 - Cutlery is not sufficiently rustproof.
 - Salt content in washing water is too high.
 - Lid on salt container is not screwed tight.
 - Too much salt was spilt while filling container.
- **Glasses become clouded and discoloured; coating cannot be wiped off**
 - Unsuitable detergent was used.
 - Glasses are not dishwasher-proof.
- **Smears left behind on glasses and cutlery; glasses have acquired a metallic appearance**
 - Amount of rinse-aid set too high.

Customer Service

Please call your local service agent, if you are not able to resolve any problem yourself. The name of your nearest service agent is shown in the Customer Service address list. When you call, please provide details of the model number (1) and the production (FD) number (2) which are shown on the nameplate  on the appliance door.

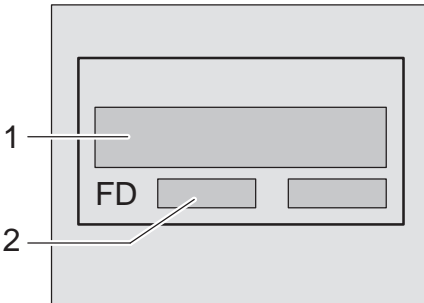

Attention

Please note that a visit by the customer service technician in the event of a fault or one of the problems previously discussed is not free of charge even during the warranty period.

Information

Notes on comparison tests

You will find details of the conditions for the comparison tests on the additional "Notes on comparison tests" sheet. The consumption values for the relevant programmes are given in the introduction.

General

- Built-under and integrated appliances which are subsequently installed as free-standing appliances must be secured to prevent them from falling over, e.g. by screwing them to the wall or by installing them under a continuous worktop which is screwed to the adjoining units.
- For Swiss version only:
The appliance can be installed without difficulty between wooden and plastic walls in a kitchen range. If the appliance is not connected via a plug, the installation side must feature an all-pole disconnector with a contact gap of at least 3 mm in order to satisfy the relevant safety regulations.

Installation

The dishwasher must be connected by a qualified technician to ensure correct operation. The specifications for supply, drainage and connected load must fulfil the required criteria as stated in the following paragraphs or in the installation instructions.

Install the appliance in the following sequence:

- Check the delivery
- Install the appliance
- Connect the waste water
- Connect the fresh water
- Connect the power supply

Delivery

Your dishwasher was checked at the factory to ensure that it was in perfect working order. This may have left some small water stains in the dishwasher. These will disappear after the first rinse cycle.

Installation

The required installation dimensions can be found in the installation instructions. Using the height-adjustable feet, adjust the appliance until it is level. Ensure that the appliance is standing firmly.

Waste water connection

See the installation instructions for the required connection steps. If required, attach a siphon with drainage spigot. Using the enclosed parts, connect the waste water hose to the drainage spigot of the siphon.

Ensure that the drainage hose is not kinked, crushed or twisted (ensure that there is no sealing cover which prevents the waste water from flowing away!).

Fresh water connection

Using the enclosed parts, connect the fresh water connection to the tap according to the installation instructions. Ensure that the fresh water connection is not kinked, crushed or twisted.

When replacing the appliance, always connect a new water supply hose to the water supply. The old supply hose must not be re-used.

Water pressure:

Minimum 0,05 MPa (0,5 bar) – maximum 1 MPa (10 bar).

If the water pressure is higher, install a pressure reducing valve.

Flow rate:

Minimum of 10 litres per minute.

Water temperature:

We recommend that you use cold water. If you do use hot water, the temperature should not exceed 60 °C.

Electrical connection

Connect the appliance only to 230 V alternating current via a correctly installed socket with protective conductor.

See rating plate for required fusing .

The socket must be attached near the dishwasher and be freely accessible.

The connection may be modified by an electrician only.

Use only a residual-current-operated circuit-breaker which features the  symbol. Only this circuit breaker guarantees compliance with the currently valid regulations.

Removing the appliance

It is essential, when removing the appliance, to observe the following sequence: First, disconnect the appliance from the power supply.

Pull out the mains plug.

Turn off the water supply.

Disconnect the waste water and fresh water connections.

Loosen the fastening screws under the worktop. If fitted, remove the base panel.

Pull out the appliance, carefully pulling the hose behind.

Transporting the dishwasher

Drain water from the dishwasher. Secure all loose parts. The appliance should only be transported in an upright position.

- If the appliance is not kept upright during transport, any water left inside may seep into the control module and cause subsequent errors with programme functions.
- Drain the appliance according to the following steps:
 - Turn on the tap.
 - Close the door.
 - Select ECO programme.
 - Switch on the main switch.
 - Wait until approx. 4 minutes have elapsed.
 - Rotate programme selector to the Reset position.
 - After another minute switch off the appliance.
 - Turn off the tap.

Protection from freezing temperatures

If the appliance is installed in a location where there is a risk of freezing temperatures (e.g. in a holiday home), all water must be completely drained out of the interior (see “Transporting the dishwasher”).

Turn OFF the tap, disconnect the supply hose and allow to drain.

Waste disposal

Disposal

Old appliances are not worthless rubbish. Valuable raw materials can be reclaimed by recycling old appliances.

Pull out the mains plug of the redundant appliance. Cut off the power cord and discard with mains plug.

To prevent children from locking themselves in the appliance and suffocating, destroy the door lock and childproof lock (if fitted).

You received your new appliance in a protective shipping carton. All packaging materials are environmentally friendly and recyclable.

Please contribute to a better environment by disposing of packaging materials in an environmentally-friendly manner. All plastic parts of the appliance are identified by internationally standardised symbols (e.g. >PS< polystyrene).

When the appliance is being disposed of, the plastic waste can be sorted for environmentally-friendly recycling.

Please ask your dealer or inquire at your local authority about current means of disposal.

Disposal of the packaging

- Please dispose of the packaging material in an environmentally friendly manner.
Keep children away from shipping carton and packaging components. Danger of suffocation from folding cartons and plastic film.
 - Corrugated cardboard consists mainly of wastepaper.
 - The moulded polystyrene parts do not contain any chlorofluorohydrocarbons.
 - The polyethylene film (PE) consists partly of secondary raw materials.
 - The wooden frames (if fitted) are made of untreated residual wood.
 - The hoops (if fitted) consist of polypropylene (PP).

Disposal of redundant appliances

- Make redundant appliances unusable to prevent subsequent accidents.
- Dispose of the appliance in an environmentally friendly manner.



Warning

Children could become locked in the appliance (risk of suffocation) or find themselves in other dangerous situations. Therefore: Pull out the mains plug, sever and dispose of the power cord. Destroy the door lock so that the door can no longer be closed.

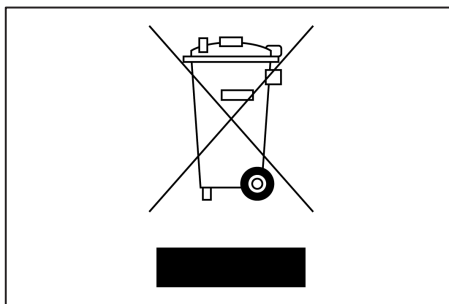

This appliance is labelled in accordance with European Directive 2002/96/EG concerning used electrical and electronic appliances (waste electrical and electronic equipment – WEEE). The guideline determines the framework for the return and recycling of used appliances as applicable throughout the EU.

Child-proof lock *

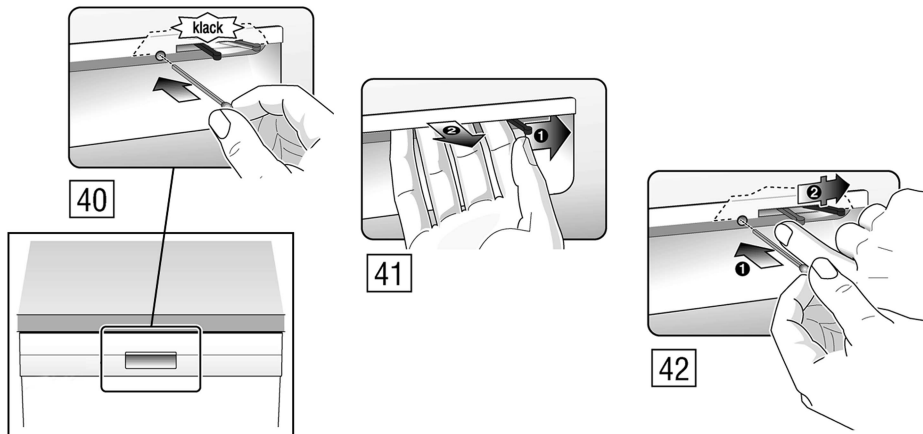

- 40 Switch on the child-proof lock
- 41 Open the door with child-proof lock switched on
- 42 Switch off the child-proof lock

When the door is open, the child-proof lock offers no protection.

Baking sheet spray head *

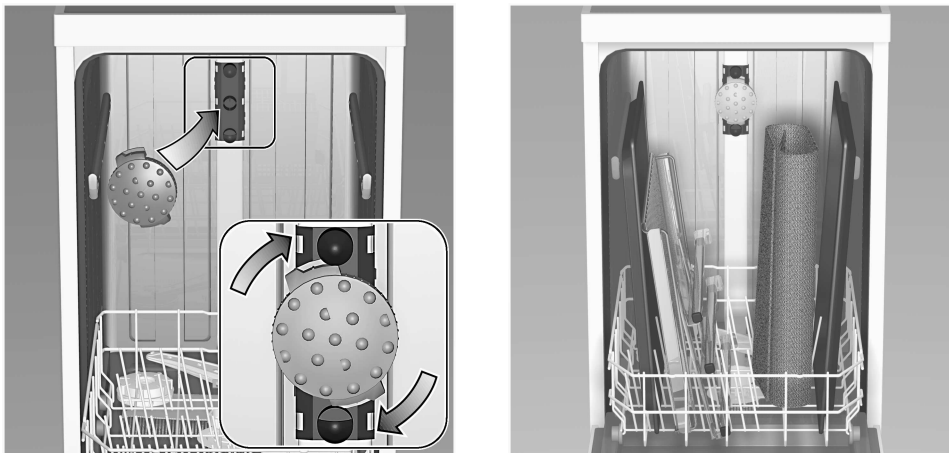

Large sheets or grilles and plates which have a diameter greater than 30 cm (gourmet plates, pasta plates, dinner plates) can be cleaned with the aid of the spray head. To do this, remove the top basket and insert the spray head as illustrated in the diagram.

To ensure that the spray jet can reach all parts, arrange the baking sheets as illustrated (max. 4 baking sheets and 2 grilles).

Never operate the dishwasher without the top basket or baking sheet spray head!

* some models

AQUA-STOP guarantee

(does not apply to appliances without Aqua-Stop)

In addition to warranty claims against the seller based on the purchase contract and in addition to our appliance warranty we will pay damages under the following conditions:

1. If our Aqua-Stop system is defective and causes water damage, we will make good the damage for private users.
2. This liability guarantee is valid for the service life of the appliance.
3. A prerequisite for the warranty claim is that the appliance has been correctly installed and connected with Aqua-Stop according to our instructions. "This also includes the correct installation of the Aqua-Stop extension (original accessory)." Our warranty does not extend to defective feed lines or fittings up to the Aqua-Stop connection on the tap.
4. If your appliance is fitted with Aqua-Stop, you can leave your appliance unattended during operation and leave the tap turned on afterwards. The tap should only be turned off if you are absent from home for a prolonged period, e.g. several weeks holiday.

Robert Bosch Hausgeräte GmbH
Carl-Wery-Straße 34
81739 München

To book an engineer visit and product advice

GB 0844 / 8928979

Calls from a BT landline will be charged at up to 3 pence per minute.

IE 01450 2655

A call set-up free of up to 6 pence may apply.

Please find the contact data of all countries in the enclosed customer service list.

Internet: www.bosch-home.com