

WVD24520
WVD2452X

en

Operating and Installation
Instructions



BOSCH

Table of Contents

Operating instructions

Information concerning waste disposal	4
Protection of the environment / hints and tips . . .	5
General safety instructions	6
Introducing your washer-dryer	7
Before using your washer-dryer for the first time .	13
Preparing, sorting and loading the laundry	14
Detergents and cleaning products	20
Programmes and functions	22
Washing/drying with standard settings	28
Washing/drying with individual settings	31
During washing/drying	37
When the programme has ended	39
Special applications	41
Cleaning and care	43
Help with minor problems	48
Consumption values	52
Customer service	53
Installing, connecting and transporting	54

Installation instructions

The new washer-dryer which you have just purchased is a modern, high-quality domestic appliance.

Your washer-dryer is distinguished by its economical consumption of energy, water and detergent.

Each washer-dryer which leaves our factory is checked carefully to ensure that it functions properly and is in perfect condition. If you have any questions - especially with respect to installing and connecting your washer-dryer - please do not hesitate to contact our customer service department.

Further information and a selection of our products can be found on our internet page:
<http://www.bosch-hausgeraete.de>

Please read these operating and installation instructions and all other information enclosed with the washer-dryer and act accordingly.

These operating and installation instructions describe various models. Differences are indicated in the appropriate places.

Retain all documentation for subsequent use or for the next owner of the appliance.

Information concerning waste disposal

Disposing of the packaging

The shipping package has protected your new appliance on its way to your home. All utilised materials are ecologically harmless and recyclable. Please contribute to a better environment by disposing of packaging materials in an environmentally conscious manner.

Please ask your dealer or inquire at your local authority about current means of disposal.

⚠ Risk of choking!

Do not let children play with packaging and associated parts. Risk of choking on plastic film and collapsible boxes.

Disposing of your old appliance

Old appliances are not worthless rubbish! Environment-conscious recycling can reclaim valuable raw materials.

⚠ Danger of death!

Unplug mains plug on redundant appliances. Cut off mains cable and discard with mains plug.

Destroy the lock on the door. To prevent playing children from becoming trapped and endangered, ensure that the door locking mechanism is disabled.

Packaging and old appliances

Unpack the appliance and dispose of the packaging in an environmentally-responsible manner.

This appliance is labelled in accordance with European Directive 2002/96/EC concerning used electrical and electronic appliances (waste electrical and electronic equipment - WEEE).

The guideline determines the framework for the return and recycling of used appliances as applicable throughout the EU.



Protection of the environment / hints and tips

Your washer-dryer uses water, energy and detergent efficiently, thereby protecting the environment and reducing your household costs. See page 52 for consumption values of your appliance.

Hints and tips

Using your washer-dryer in an efficient and environmentally friendly manner:

- Take advantage of recommended load quantity. The recommended load quantity is indicated in the display field according to the selected programme.

With smaller amounts of laundry, the load adjust reduces the water and energy consumption.

- Select the **Color eco/Cor eco 60 °C** with  programme instead of **Resistentes/Algod. 90 °C**. The longer washing time in this 60 °C programme means that the cleaning effects are comparable with those of a 90 °C programme, although the power consumption is considerably lower.
- Do not use prewash for lightly to normally soiled washing.
- Add detergent according to the degree of soiling, amount of laundry and water hardness, and observe the detergent manufacturer's instructions.
- If washing is then to be dried in the appliance, select the higher spin speed - because the more water that is spun out of the appliance, the less time and energy is required to dry it.

General safety instructions

Your washer-dryer is intended for

- use in the household only,
- for washing machine-washable fabrics in washing lye,
- operation with cold drinking water and commercially available detergents and cleaning products which are suitable for use in washing machines.

Do not leave children unsupervised near the washer-dryer.

Keep pets away from the washer-dryer.

Do not insert/pull out the mains plug with wet hands.

Do not pull out the mains plug by tugging the cable.

Do not touch the loading door when washing/drying at high temperatures.

Caution when draining hot water.

Do not climb onto the washer-dryer.

Do not lean on the open washer-dryer door.

Due to the use of the condensation principle in drying, please keep the connected water tap open during the drying process, otherwise the drying programme cannot start, please refer to Page 48 “Help with minor problems”.

Introducing your washer-dryer

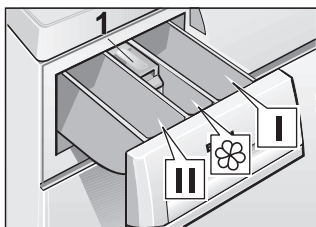

Adding detergent/cleaning product

Dispenser I:

Detergent for prewash or starch.

Dispenser II:

Detergent for main wash, soaking agent, water softener, bleach or stain remover.

Dispenser ☼:

Additives, e.g. fabric softener or former (do not fill above the lower edge of the insert **1**).

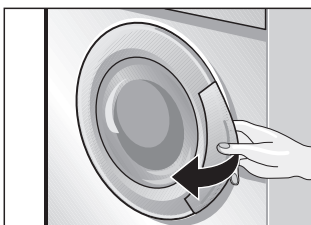

Opening ...

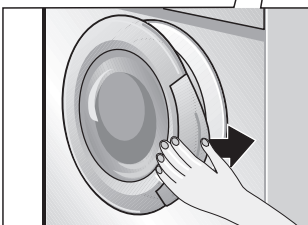

and closing the door

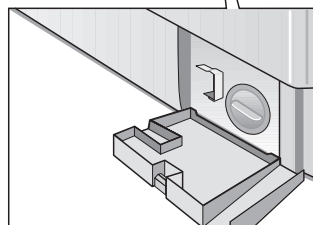

Service flap

Control panel

Touch buttons for additional options
(in addition to the programme if required)

Agua extra(Extra Rinse): Additional rinsing cycle

 **(Intensive):** Intensive wash

Fácil  (Reduced Ironing): Gentle spin

Prelava. (Prewash): Actuate prewash.

Additional options can be combined.

The indicator lights of the buttons come on, if the additional options are active.

Switching off the additional option: Touch the button again. Indicator light goes out.

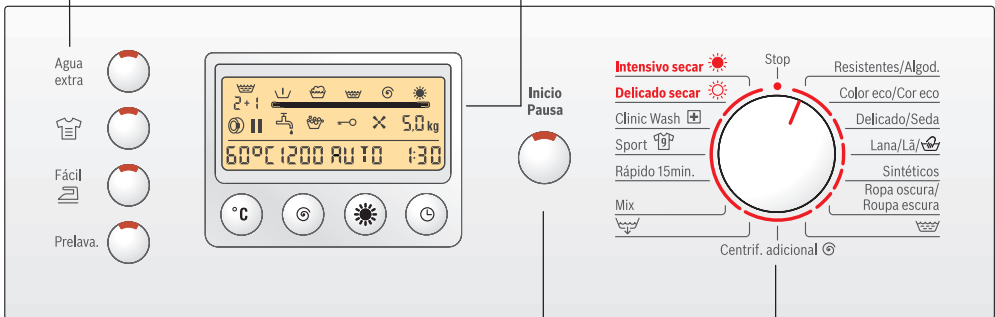

Inicio/Pausa(Start/Pause) -touch button

For starting the washing/drying cycle (programme must have been selected). The Pause function is not active during drying process.

Display panel

Indicates the settings which have been selected (e.g. washing temperature, spin speed, drying duration, finish in time, childproof lock, recommended load) as well as programme progress.

Touch button **°C Temp.**

Selects the washing temperature or cold wash.

Touch button  **Spin**

Selects the spin speed or no final spin.

Touch button  **Dry**

Selects the drying time or drying mode.

Touch button  **Finish in**

Selects the finish in time. (delays the end of the programme).

Programme selector

For switching the machine on and off and for selecting the programme.

Can be rotated in either direction.

The programme selector does not rotate when the programme is running, the programme sequence is electronically controlled.

*All buttons are sensitive, they only need to be touched gently!

Display panel



Display		Notes
	Prewash	On if selected
	Washing	Not on if Rinse, Spin, Empty or Drying programme was selected
	Rinse	Not on if Spin, Empty or Drying programme was selected
	Final spin / Empty	Not on if a programme with the “---” setting (without final spin) or drying programme is running
	Dry	On if the drying programmes or drying time/mode was selected
	Progress bar	For the programme status
	Low water pressure	On if the water pressure is too low.
	Overdosage	On if too much detergent dispensed
	Childproof lock	On if selected
	Fan	On if the drying programmes and drying time was selected
5,0kg*	Recommended load	Not on if Rinse, Spin, or Empty additional programme was selected
60 °C*	Washing temperature or	Expected washing temperature
cold*	Cold wash.	
1200*	Spin speed or	Default spin speed of the programme or selected speed
---*	without final spin	
2:00*	Drying duration or	Expected drying programme duration or auto drying.
AUTO*	Drying mode	
1:30*	Programme duration	Expected programme duration

Overdosage of detergent may cause excessive froth formation and impair the washing and rinsing results. A rinse cycle is automatically run.

i The  symbol goes out when the appliance switches off at the end of the programme or if the programme is changed.

→ Childproof lock

The activated childproof lock prevents the selected programme from being changed while the programme is running.

✕ Fan

The fan works at the last period of drying duration for cooling the laundry.

i Do not interrupt this cooling process.

Recommended load

The recommended load is displayed depending on the selected programme and additional functions, see from page 22.

Spin speed

The default spin speed is displayed depending on the selected programme and additional functions. You can change this speed, see page 32.

Washing temperature

The default washing temperature is displayed after selecting the programme and it can be changed by touching the **Temp. °C** button, see page 32.

Programme duration

When the programme has been selected, the expected programme duration (time after which the programme is expected to end) is displayed.

The programme duration is displayed in hours and minutes, e.g.

1:30 = 1 hour and 30 minutes

0:35 = 35 minutes.

When the programme has started, the programme duration counts down in minutes.

When the programme ends, the displays shows **-0-**.

i While the programme is running, the programme duration may be extended or reduced for the following reasons.

Reductions in time occur because of:

- small loads,
- reduced heating times, e.g. if the water is very hot,
- reduced washing temperature after the programme has started,

- the laundry for drying with low residual moisture.
- Increases in time** occur because of:
- additional rinse cycle if excessive foam is in the laundry,
 - multiple spinning if the laundry is distributed poorly in the drum,
 - increased heating times, e.g. when the water is too cold,
 - water pressure too low,
 - selection of an additional option, e.g. **Agua extra(Extra Rinse)** and/or  (**Intensive**) after the programme has started,
 - very absorbent washing extends the heating duration,
 - the laundry for drying is wet.

Finish in time

You can select the finish in time, see page 33.

Drying duration or automatic drying

You can set the drying duration or automatic drying by touching the **Dry**  button, see page 29. When the washing and drying without a break was selected, time drying or auto drying duration will add in programme duration automatically. Related programmes will prolong 5-15 minutes for good washing performance.

Rinse cycles 2+1

On if there is (are) rinse cycle(s) with the selected programme or "**Agua extra(Extra Rinse)**" was selected. The symbol means "default rinse cycle(s) + selected additional rinse cycle" by touching the "**Agua extra(Extra Rinse)**" button.

Before using your washer-dryer for the first time

Preparing your washer-dryer

Attention

The washer-dryer must have been installed and connected properly (refer to page 54).

- i** The washer-dryer was tested before leaving the factory. To remove any water left over from testing procedures, the first washing cycle should be carried out **without** laundry in the machine.
- Turn the tap on.
- Pull out the detergent drawer all the way.
- Pour approx. 1 litre of water into chamber **II** of the detergent dispenser.
- Half fill the measuring beaker with detergent and pour into chamber **II**.
- i** Do not use any special detergents for delicates or woollens (excessive foam).
- Close the detergent drawer.
- Close the washer-dryer door.
- Set the programme selector to **Resistentes/ Algod. 90 °C**.
- Touch the **Inicio/Pausa** button. The programme starts.

The programme ends when all symbols in the upper row of the display field go out, the progress bar is completely filled and the programme duration is on **-0-**:

- Turn the programme selector to **Stop**.

Preparing, sorting and loading the laundry

Preparing the laundry

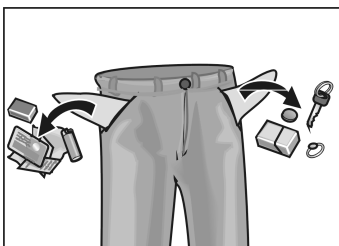

Attention

Loose debris (e.g. coins, paper clips, needles, nails) can damage items of clothing as well as parts of the washer-dryer (e.g. drum).

- Empty all pockets on items of clothing.
- Brush sand out of pockets and cuffs/turn-ups.
- Close zips, fasten pillow cases/cushion covers.
- Remove curtain runners or tie up in a net/bag.
- Wash in a net/cushion cover:
 - –delicates, e.g. tights, curtains,
 - –small laundry items, e.g. socks, handkerchiefs,
 - –underwired bras (underwire may become detached during washing and cause damage).
- Trousers, knitwear and knitted textiles, e.g. jersey garments, T-shirts or sweatshirts should be turned inside out.
- Only tumble-dry textiles which have been washed, rinsed and spun.
- Remove as much water as possible from the laundry. Do not press the button for reducing the spin speed.
- Before tumble-drying, easy-care items should also be spun using the appropriate spin programme (see programme table).
- In order to ensure uniform drying, sort the items according to fabric type and degree of drying required.

Preparing laundry for drying

- ❑ Easy-care items should if possible be removed from the machine while still slightly damp and allowed to continue drying in the open air. Overdrying may cause excessive creasing.
- ❑ Items which require ironing do not have to be ironed immediately after being tumble-dried. It is a good idea to fold or roll them together for a while, so that any remaining moisture is evenly distributed.

Sorting the laundry

According to colour and degree of dirt

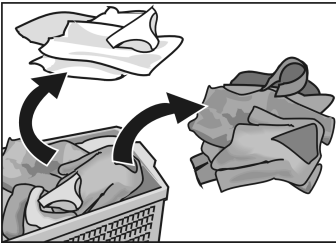

Attention

Washing may become discoloured. Do not wash new coloured washing with other washing.

White items may become grey. Wash white and coloured items separately.

Degrees of dirt

Lightly soiled

No visible soiling or stains. Washing has probably absorbed body odour.

- Light-weight summer clothing and sportswear worn for several hours.
- T-shirts, shirts, blouses worn for up to one day.
- Bed linen, guest towels used for one day.

Normally soiled

Visible soiling and/or a few light stains.

- T-shirts, shirts, blouses soaked in sweat or worn several times.
- Underpants, briefs worn for one day.
- Tea towels, hand towels, bed linen used for up to one week.
- Curtains (without nicotine soiling) used for up to six months.

Very soiled

Visible soiling and/or stains.

- Kitchen towels used for up to one week.
- Fabric serviettes.
- Baby bibs.
- Children's outer clothing or football jerseys and shorts soiled with grass and/or earth.
- Work clothes, e.g. mechanic's overalls, baker's and butcher's clothing.

Typical stains

- Skin grease, cooking oil/fat, sauces, mineral oil, wax (containing fat/oil).
- Tea, coffee, red wine, fruit, vegetables (which can be bleached).
- Blood, egg, milk, starch (containing protein, carbohydrate).
- Soot, earth, sand (pigments), tennis clothing soiled with red clay.

Removing stains

Remove/pretreat stains as soon as possible after they have occurred.

First dab with a soapy solution. Do not rub.

Then select the appropriate programme and wash the item.

Stubborn/dried in stains can sometimes only be removed by washing several times.

Sorting laundry according to the instructions on the care labels

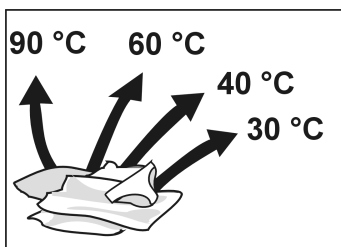

hard-wearing textiles, heat-resistant textiles
e.g. made from cotton or linen



for easy-care textiles
e.g. cotton, linen, synthetic materials or blended fabrics



for easy-care, washable textiles
e.g. silk, satin, synthetic materials or blended fabrics
(e.g. curtains)



for hand and machine washable wool or wool-rich textiles
e.g. cashmere, mohair or angora,
also suited for hand washable silk.

Do not wash laundry items which bear the following care label in the washer-dryer:



= do not wash

Only dry laundry that is labelled with the following care symbols:

☉ = tumble-dry at normal heat setting (Normal drying)

☺ = tumble-dry at low heating setting (Delicate drying)

i The following textiles should not be tumble-dried:

- Laundry marked with the care symbol ☒ = do not tumble-dry
- Wollens or items containing wool.
 - **Risk of shrinking!**
- Delicate fabric (silk, synthetic net curtains).
 - **Risk of creasing!**
- Items containing foam rubber or similar material.
- Items which have been treated with inflammable solvents, such as stain removers, petrol, paint thinners. **Explosion hazard!**
- Items still containing hair lacquer or similar substances. **Dangerous vapors!**
- Dripping-wet laundry. **Waste of energy!**

Loading the laundry

⚠ Risk of explosion!

Items of clothing that have been pretreated with solvent-based cleaning agents, e.g. stain remover and dry cleaning spirit, represent an explosion hazard once loaded into the washer-dryer. Before loading the laundry, rinse thoroughly by hand.

Attention

Foreign objects in the drum may damage the laundry. Before loading the laundry, check that there is no debris in the drum.



- ❑ Open the washer-dryer door.

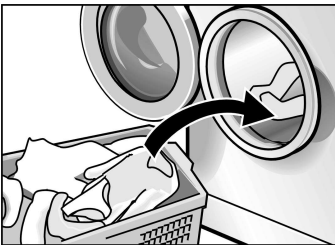

- ❑ Unfold the sorted items of clothing and place them loosely into the drum. Mix large and small items. Laundry items which vary in size are more evenly distributed during the spin cycle.
- ❗ Do not exceed recommended loads. Overloading will cause poor wash results and encourage creasing.



- ❑ Close the washer-dryer door. Take care not to trap any items of clothing between the loading door and rubber seal.

Detergents and cleaning products

Dosing detergent

⚠ Risk of poisoning!

Keep detergents and additives out of the reach of children.

Dose detergent according to

- the water hardness. You can find out the water hardness from your water utility company.
- the amount of laundry.
- the degree of soiling.
Information on soiling can be found on page 15.
- the specifications of the detergent manufacturer.
The correct dosage reduces the impact on the environment and produces a good washing result.

Pour liquid detergent into the corresponding dispenser.

Too little detergent:

- The laundry is not washed clean and eventually becomes grey and hard.
- Greyish-brown dots (grease spots) may stain the laundry.
- The heating elements are calcifying.

Too much detergent:

- The environment is loaded.
- Excessive froth may be generated during the wash cycle causing a reduction in the washing mechanism. This may be the cause of poor washing and rinsing results.

Adding detergent/ cleaning product

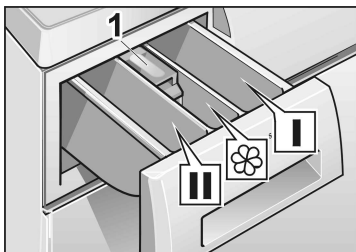

Dispenser I
Detergent for prewash or starch.

Dispenser II
Detergent for main wash, water softener, pre-soaking agent, bleach and stain removal product.

Dispenser ☼
Cleaning product, e.g. fabric softener or fabric conditioner (do not fill above the lower edge of the insert **1**).

- i** Concentrated or viscous fabric softener or fabric conditioner must be diluted with a little water before it is poured into the dispenser (prevents the overflow from becoming blocked).
- Pull out the detergent drawer all the way.
- Pour in detergent and/or cleaning product.
- Close the detergent drawer.

Programmes and functions

Programme selector

Select the desired programme.

i Programmes wash lightly soiled textiles in the shortest possible time. For heavily soiled textiles reduce the load or touch the **Intensive**  button!

Washing programmes

Resistentes/Algod. (Cottons) **cold-90 °C**, **Color eco/Cor eco**(Cottons Eco) **cold-60 °C**, **Clinic Wash** **+** (Sensitive) **cold-60 °C**

Hard-wearing textiles, heat-resistant textiles made of cotton or linen.

Color eco/Cor eco (Cottons Eco) 60 °C :

For stained, heavily soiled textiles, e.g. cotton or linen. Energy and water saving programme. The longer washing time in this 60 °C programme means that the cleaning effects are comparable with those of a 90 °C -programme, although the power and water consumption is considerably lower.

Resistentes/Algod. (Cottons) 90 °C:

Energy-intensive programme for heat-resistant textiles, e.g. made of cotton or linen.

To protect the waste-water pipes, the hot water is mixed with approx. 7 litres of cold water and cooled before being drained.

Delicado/Seda (Delicate/Silk) **cold-30 °C**

For delicate, washable textiles, e.g. silk, satin, synthetic materials or blended fabrics (e.g. curtains).

Delicates cycle at 30 °C for hand and machine washable silk.

i We do not recommend washing these textiles with other rougher textiles.

No spin between the rinse cycles.

Reduced spin speed.

Lana/Lä/  (Wool) cold-40 °C

Hand and machine washable wool or wool-rich textiles, e.g. cashmere, mohair or angora. Also suited for hand washable silk.

Reduced spin speed.

Sintéticos (Easy-Care) cold-60 °C

Easy-care textiles, e.g. made of cotton, linen, synthetic or blended fabrics.

Reduced spin speed.

Ropa oscura/Roupa escura(Dark Wash)cold-40 °C

Dark easy-care textiles.

Reduced spin speed.

Sport  cold-40 °C

Textiles for outdoor wear.

Reduced spin speed.

Rápido 15min (SuperQuick) cold-40 °C

Easy-care textiles, e.g. made of cotton, linen, synthetic or blended fabrics.

i Short programme approx. 15 minutes suitable for refreshing.

Reduced spin speed.

Mix cold-40 °C

Time-optimised programme for lightly soiled cotton textiles and easy-care textiles. Different types of washing can be washed together. Even suitable for washing new textiles before they are worn for the first time.

i Wash white and coloured items separately. Do not wash new coloured washing with other washing.

Reduced spin speed.

Intensivo secar  (Intensive Dry)

For resistant fabrics ;

White and coloured cottons and linens.

Maximum load 2.5 kg

Drying programmes

Delicado secar ☀ (Gentle Dry)

For delicate fabrics ☑ ;

Reduced drying temperature.

Easy-Care (drip-dry) laundry, such as synthetics and fabric blends, as well as cotton with drip-dry finish, e.g. viscose rayon, modern acrylic and polyester.

Maximum load 1.5 kg.

You can select automatic drying or time controlled drying by touching the **Dry** ☀ button.

During drying, the temperature sensor determines the residual moisture. The drying time is modified according to the machine load and the type of laundry. During the drying cycle, the remaining time is constantly updated in the display. In the continuous wash+dry programme, the washing programme determines the drying programme.

Automatic drying

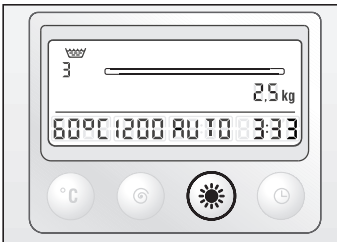

- i** Some items of laundry may still be damp. Dry damp items subsequently using the time-controlled programme. If it appears repeatedly, please use the “Fine-adjustment” function to adjust the automatic drying mode.

Fine-adjustment

Start “setting” mode:

step 1, 2, 3,4 and 5 are same as the setting steps for volume adjustment, see Page 36.

- Step 6: Turn the programme selector 2 steps right. 0 appears in the display.

- i** 0: default setting, normal automatic drying;
1: automatic drying + extra 5 minutes drying;
2: automatic drying + extra 10 minutes drying;
3: automatic drying + extra 15 minutes drying;
4: automatic drying + extra 20 minutes drying.

- Touch **Dry** ☀ button to select desired automatic drying mode. After setting, turn the programme selector to **Stop**. The setting is stored.



Time-controlled drying

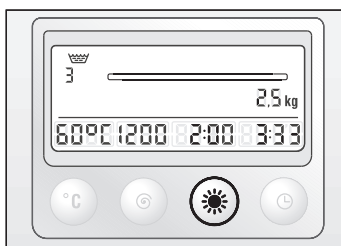

The drying duration is the drying time you have set.

Set the drying time using the **Dry** ☀ button.

- i** Time-controlled drying–15 minutes is the cooling down programme. If a drying process is interrupted, please select this programme to cool the laundry before opening the loading door.

Guide values for drying times

Drying for too long causes the laundry to shrink or crinkle and unnecessary energy consumption. Therefore, avoid drying times that are too long.

- i** Warm items feel damper than cold ones. This could lead to incorrect assumptions.

Cottons / coloureds (cotton, linen)					
Dry weight in kg	0.5	1.0	1.5	2.5	
	Recommended drying times (min)				Programme
Cupboard dry	50-60	60-70	70-80	90	Intensivo secar ☀
Iron dry	40-50	50-60	60-70	70-80	

Easy-Care / Synthetics					
Dry weight in kg	0.5	1.0	1.5		
	Recommended drying times (min)				Programme
Easy-Care	30-35	40-45	50-55		Delicado secar ☀
Acrylics		25	25-30		

- i** Drying times are approximate and refer to standard loads.

Programme options

Rinse

Rinse cycle with subsequent spin cycle for rinsing hand-washed items or for starching.

Touch the **Agua extra** button for desired additional rinse cycle.

Reduced spin speed.

Centrif. adicional **Spin**

Spin cycle after a programme with setting “---” (without final spin) or for spinning hand-washed washing with selection of the required speed.

Washing water or rinsing water is drained before the spin cycle.

Empty

Water is drained after a programme with the “---” (without final spin) setting on display panel for gentle treatment of delicate laundry.

Additional options - buttons

(Intensive)

The washing time is extended so that highly soiled washing or 5.0 kg of cottons/coloureds are washed more intensively.

Touch the button in addition to the programme for the following combinations of load and degree of soiling:

Amount of laundry	Programme and button 	Degree of soiling
5.0 kg	Resistentes/Algod. cold-60 °C	lightly to normally soiled
	Clinic Wash cold-60 °C	
	Color eco/Cor eco cold-60 °C	normally soiled with stains
up to 5 kg	Resistentes/Algod.70-90 °C	normally soiled
	Resistentes/Algod. cold-60 °C	normally to heavily soiled
up to 2.5 kg	Color eco/Cor eco 60 °C	normally to heavily soiled with stains
	Sintéticos cold-60 °C	normally to heavily soiled
	Mix cold-40 °C	
	Ropa oscura/Roupa escura cold-40 °C	
Sport cold-40 °C		
up to 2 kg	Delicado/Seda cold-30 °C	

Agua extra (Extra Rinse)

Additional rinsing of laundry.

Programme duration is extended accordingly.

Recommended in areas with very soft water.

Fácil (Reduced Ironing)

Gentler reduced spin cycle with subsequent fluffing.

After the spin cycle, the laundry is loose in the drum - creasing is reduced.

Prelava. (Prewash)

For very dirty, hard-wearing laundry, e.g. cotton or linen. The maximum washing temperature of the prewash is 30 °C. Prewash cannot be selected for **Lana/Lã**/ and **Rápido** 15min programme.

Washing/drying with standard settings

Your washer-dryer can be used in three ways:

- washing only,
- drying only,
- washing and drying without a break in between.

i For uninterrupted washing and drying, the maximum load must be reduced to 2.5 kg for cottons/coloureds or 1.5 kg for easy-care.

i To achieve good washing/drying result for terry towel, the recommended load is 4.0 kg for washing and 2.0 kg for drying.

The specified standard settings are optimally adjusted to the selected programme.

If you do not want to change these standard settings:

Washing

Example of **Sintéticos 40 °C** programme:



- Turn on the tap. Turn the programme selector to the desired programme.

Inicio/Pausa indicator light flashes.

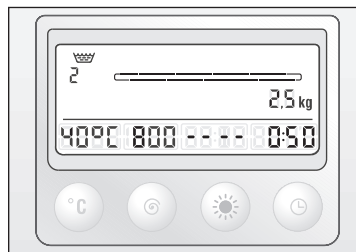

- The following is displayed for the selected programme.
 - progress bar,
 - default rinse cycle(s),
 - maximum load (do not exceed max load),
 - default washing temperature,
 - default spin speed,

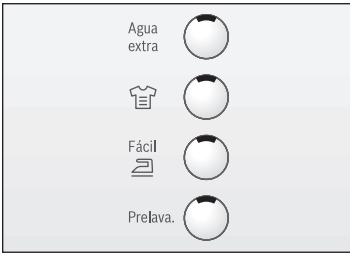

- drying duration (displays ---- , i.e. 0 min, if the laundry needs to be dried, please refer to “setting the drying time”),
- programme duration.

☐ If required, touch the button(s) for additional option(s). The programme duration, additional rinse cycles and other parameters showed in display will be changed accordingly.

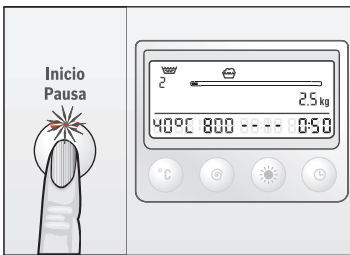

☐ Touch the **Inicio/Pausa** button.

The programme starts. The indicator light remains lit for the entire duration of the programme.

i The almost empty progress bar is indicated in the display field. While the programme is running, the programme duration counts down and the progress bar fills up with the segments. The symbol for the running programme sections appears.

Drying



☐ Turn on the tap.

i Due to the use of the condensation principle in drying, please keep the connected water tap open during the drying process.

☐ Turn the programme selector to **Intensivo secar** ☀ or **Delicado secar** ☀.

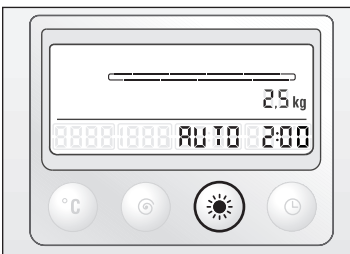

☐ Touch the **Dry** ☀ button to set the desired drying time or automatic drying. The following is displayed:

- progress bar,
- maximum drying load,
- drying time or automatic dry symbol,
- programme duration.

☐ Touch the **Inicio/Pausa** button. The drying programme starts.

Washing Drying without interruption

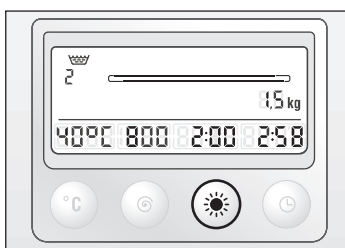
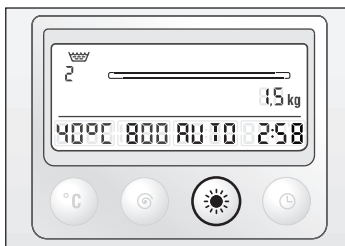

i The almost empty progress bar is indicated in the display field. While the programme is running, the programme duration counts down and the progress bar fills up with the segments. The drying symbol appears. In the cooling down phase, the fan symbol appears.

- Turn on the tap.
- Select desired washing programme.
- Select desired additional functions.
- Touch the **Dry** ☀ button to set the desired drying time or automatic drying, the programme will be washing and drying without interruption.

i The programme duration will be changed accordingly after the drying programme being set. See page 29.

i Do not interrupt the drying process, if it is necessary, please select 15 minutes cooling programme before opening the loading door.

i The following is displayed for the selected programme:

- progress bar,
- default rinse cycle(s),
- maximum load (do not exceed max. load),
- default spin speed,
- default washing temperature,
- drying time or automatic drying symbol,
- programme duration.

Touch the **Inicio/Pausa** button. The programme starts.

i The almost empty progress bar is indicated in the display field. While the programme is running, the programme duration counts down and the progress bar fills up with the segments. The symbols for the running programme sections appears.

Washing/drying with individual settings

You can adjust the settings to your requirements. First find a quick overview of the adjustable settings. The steps for changing the settings are described in detail overleaf.

Overview at a glance

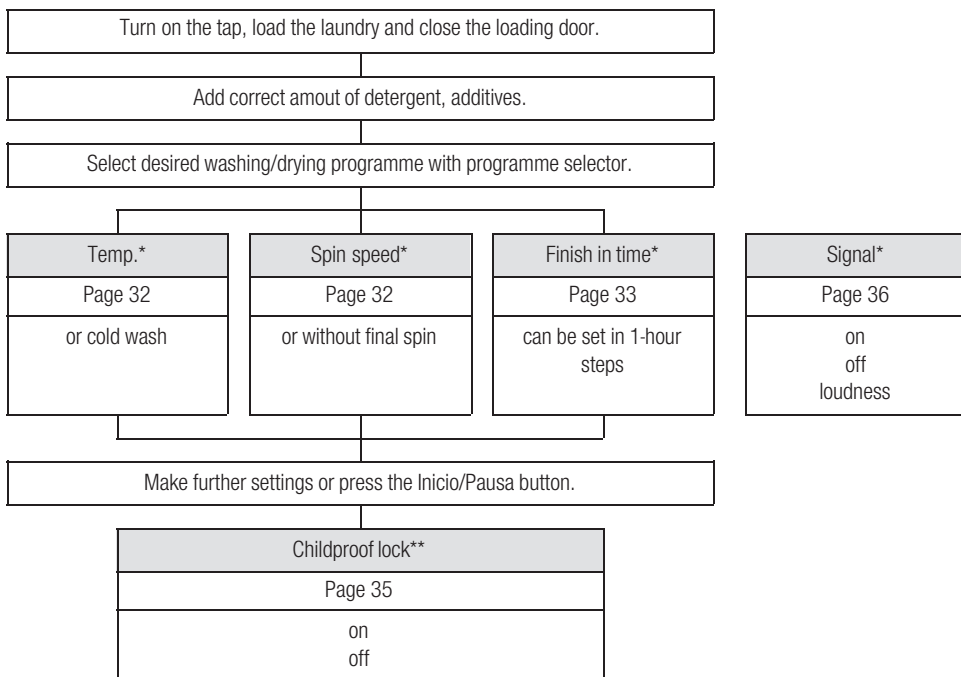

* Individual settings can be combined.

**This function is recommended to avoid misoperation by casual touching.

Washing temperature

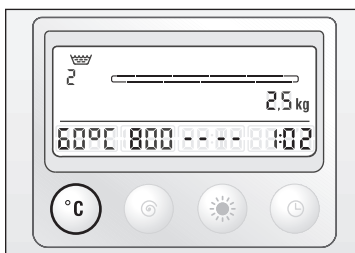
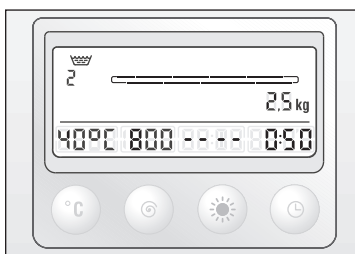

You can change the default washing temperature.

- Keep touching the temperature button **°C Temp.** until the desired temperature displays.
- i** For different clothing, there are different programmes with respective temperature ranges.

Spin speed

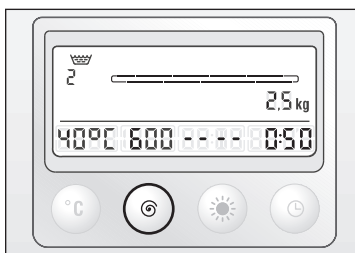
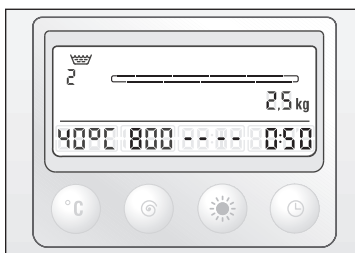

You can change the default spin speed.

- Touch the **G Spin** button until desired spin speed displays.
- i** If setting --- (without final spin) has been selected, the washing remains in the final rinsing water. Before the laundry can be unloaded, the  (Empty) or **Centrif.adicional G** (Spin) programme must be performed. Touch **Spin G** button to select the desired spin speed or touch the **Inicio/Pausa** button directly to start subsequent spin cycle with default spin speed.
- i** The speed can be changed at any time by touching the **Spin G** button until the new speed is displayed. Setting "----" (without final spin) is possible until the Rinse programme section starts.

Finish in time

Example of **Sintéticos 40 °C** programme:

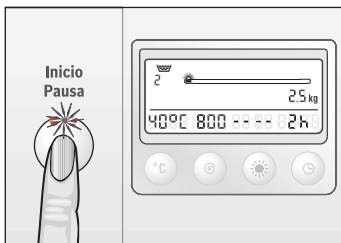
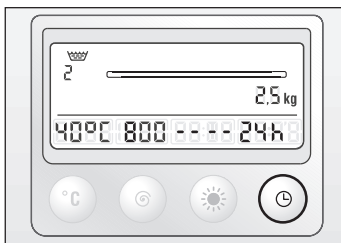
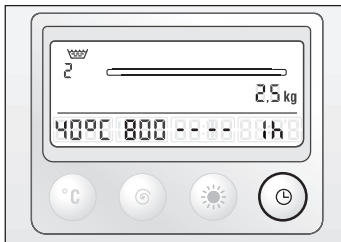

Before a programme starts, you can specify by how many hours later the programme is to be ended.

- ❑ Touch the **Finish in** button, the display shows the minimum finish in time of the selected programme. Such as 1h, i.e.1 hours.
- ❗ The minimum finish in time of different programmes are different. It depends on the duration of selected programme.

- ❑ Touch the **Finish in** button until the desired number of hours is displayed.
- ❗ The finish in time can be set in 1-hour steps. The time can be delayed up to a maximum of **24h**. If a finish in time of **24h** has been set, the programme duration mode can be accessed by touching the **Finish in** button again.

You can change other settings
or

- ❑ Touch the **Inicio/Pausa** button.
The finish in time starts counting down. The first segment of the progress bar flashes.
- ❗ The finish in time is counted down by the hour. When the finish in time has elapsed, the programme starts automatically and the programme duration is displayed.
- ❗ Changes to the finish in time or an immediate start are possible. To do this:
 - Touch the **Inicio/Pausa** button. The programme duration time appears.
 - Touch the **Inicio/Pausa** button directly to start the programme immediately. If required, reset the finish in time.
 - Touch the **Inicio/Pausa** button.

- i** If the programme sequence is changed by rotating the programme selector or the programme is cancelled, the preselected finish in time is also cancelled. The programme duration of the newly selected programme appears in the display. The finish in time must be reselected (see also chapter **Changing the programme**, page 37 and **Cancelling the programme**, page 37).
- i** The laundry can be topped up at any time during the finish in time. Close the washer-dryer door.

Childproof lock

You can secure your washer-dryer to prevent selected functions from being inadvertently changed.

If the childproof lock has been selected:

- no changes can be made while the programme is running,
- the symbol \rightarrow flashes if a programme setting is inadvertently changed,
- should the appliance be switched off and on while a programme is running, the programme will continue at the point at which it was interrupted,
- when the programme ends, the duration time is showed as 0:01, the loading door cannot be opened, deactivate the childproof lock, the door can be opened while the display shows -0-.

- Set the programme selector to the required programme and, if required, select other settings.
- Load the laundry and close the loading door.
- Touch the **Inicio/Pausa** button. The programme starts.
- Release the **Inicio/Pausa** button.

Activating the childproof lock

Example of **Sintéticos 40 °C** programme:

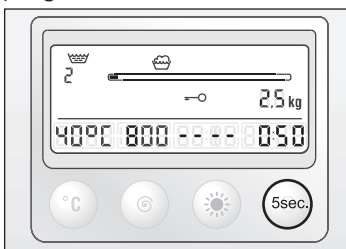

Deactivating the childproof lock

- Touch the \ominus button and hold down (for approx. 5 seconds) until the \rightarrow symbol is displayed.
- Release the \ominus button, the childproof lock is activated, the symbol is permanently on.

The childproof lock must be deactivated before making programme changes or ending programmes.

- Touch the \ominus button and hold down (for approx. 5 seconds) until the \rightarrow symbol goes out.
- If there is a power failure, the childproof lock remains on.

Signal

The acoustic signal indicates:

- that the additional functions (buttons) have been switched on or off,
- individual programme statuses (e.g. start of programme, end of programme), operating errors and faults.

Start the signal mode

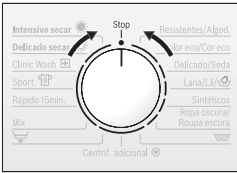

1. Set to "Off"

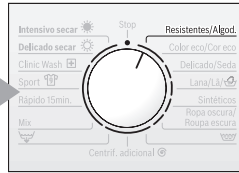

2.1 step to right



3. keep selected and

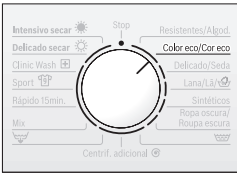

4. 1 step to right



5. release and find the number from 0 to 4



Set volume for...



6. button signals*



or 6.1 step to right



7. Information signals*

- ❑ After setting, turn the programme selector to "Stop", the volume of signal is stored.

* If required, set repeatedly.

During washing/drying





Changing the programme

If you have accidentally selected the wrong programme:

- If the childproof lock is active, temporarily deactivate, see page 35.
- Turn the programme selector to a newly selected programme. If required, change other settings.
- Touch the **Inicio/Pausa** button. The programme starts.
- If required, re-activate the childproof lock, see page 35.

Cancelling the programme



If you would like to terminate a programme and remove the laundry:

- If the childproof lock is active, deactivate, see page 35.
- Turn the programme selector to  (Empty) **Centrif. adicional**  (Spin) or  (Rinse) If required, select the desired spin speed (but not setting “---” (without final spin)).
- i** If a programme is interrupted at a high temperature,  (Rinse) should be selected to cool down the laundry.
- For drying programme, select time-dry 15 min cooling programm to cool down the laundry.
- Touch the **Inicio/Pausa** button.
- If required, switch on the childproof lock again.
- Wait until programme ends.
- Deactivate the childproof lock.
- Turn the programme selector to **Stop**.

Pausing the programme

- ❑ Open the washer-dryer door.
- ❑ Remove the laundry.
- ❑ **i** If a programme was interrupted at a high temperature, such as drying programme, please do not open the washer-dryer door until the appliance has cooled down.

If you would like to pause a running programme without changing the sequence:

- ❑ Touch the **Inicio/Pausa** button during washing cycle, the display shows **||** and “PAUS”(pause), if door open symbol  flashes at this moment means the door can be opened after 1 minute later, when the  symbol and “OPEn” come on, open the door if required, add/remove the laundry, close the door.
- ❑ To continue the programme. Touch the **Inicio/Pausa** button again.
- ❑ **i** The pause function cannot be activated during drying cycle and water pressure detecting period. If a programme was paused at a high water level or temperature, the door open symbol does not appear.

When the programme has ended



i Display panel:

- all symbols on the programme status display have gone out, the full progress bar, washing temperature, spin speed, drying time, rinse cycles and recommended load are displayed,
- the programme duration is on **-0-**,
- if the childproof lock is selected, the **→** symbol illuminates, the programme duration is on 0:01, please deactivate the childproof lock, see page 35.
- if detergent was overdosed, the **☹** symbol illuminates.

- If the water pressure is low, the **⚙** symbol illuminates.

- Turn the programme selector to **Stop**.

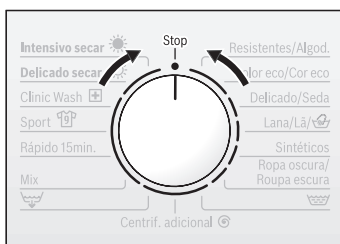

or

Setting “---” (without final spin) selected

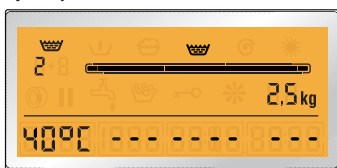



i Display panel:

- the **☙** symbol, rinse cycles, the full progress bar and the washing temperature are indicated on the programme status display,
- the programme duration and spin speed are on “---”.
- if the childproof lock is selected, the **→** symbol illuminates,
- if detergent was overdosed, the **☹** symbol illuminates.

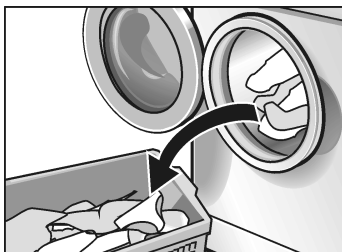
Removing the laundry



- If the water pressure is low, the  symbol illuminates.
- If required, deactivate the childproof lock.
- Select an additional programme , ; or touch the **Inicio/Pausa** button directly.
- If required, activate the childproof lock.

At the end of the additional programme:

- If required, deactivate the childproof lock.
- Turn the programme selector to **Stop**.



- Open the washer-dryer door.

If the loading door cannot be opened:

Wait 2 minutes (safety function is active)

or

there is still water in the washer-dryer if the “----” (without final spin) option was selected.

Select the  or  programme and touch the **Inicio/Pausa** button.

- Unload the laundry.

Attention

Remove any foreign objects (e.g. coins, paper clips) from the drum and rubber seal – **risk of rust!**

- Leave the washer-dryer door and detergent drawer open to allow the interior of the washer-dryer to dry.

After drying:

- Take the laundry out of the machine immediately to prevent creasing.
This is particularly important with synthetic fabrics.

Cottons + Linens

- Cotton and linen items which have been dried to **iron dry** should be rolled together to prevent them from drying out completely before they are ironed.
- **Cupboard dry** items must be smoothed out and folded up.

Easy-care/synthetics

- Hang shirts and blouses individually on hangers.

Special applications

Soaking

- Load laundry of the same colour.
- Pour soaking agent into dispenser **II** according to the manufacturer's instructions.
- Set the programme selector to **Resistentes/ Algod.** and the washing temperature **30 °C**.
- Touch the **Inicio/Pausa** button.
The programme starts.
- After approx. 10 minutes, turn the programme selector to **Stop**. The laundry is left to lie in the water.
- Select a programme according to the required soaking time, the detergent solution is pumped out.
- i** Only little detergent to be dispensed for the main wash.

Starching

The laundry must not be treated with fabric softener.

- Insert the washing.
- Dose a quantity of starch for approx. 15 litres of water. Dissolve starch according to the manufacturer's instructions.
- Turn the programme selector to .
- Set the spin speed; even setting "----" (without final spin) is possible.
- Touch the **Inicio/Pausa** button.

As soon as the water runs in:

- pull out the detergent drawer a little and
- pour starch solution into dispenser **I**.
- Close the detergent drawer.

If setting "----" has been selected, select the  programme.

Dyeing

Only use dyes that are environmentally compatible and suitable for use in washing machines.

Attention

Washing in subsequent wash cycles may become discoloured.

- Apply dyes according to the manufacturer's instructions.

After dyeing:

- Pour approx. ½ measuring beaker of detergent into dispenser **II**.
- Without any laundry in the drum, allow the **Resis-**
tentes/Algod. with temperature of **90 °C** programme to run through.
- Wipe out the rubber seal.

Bleaching

Attention

Bleaches may contain sulphur or chlorine which can corrode components of the washer-dryer. Do not bleach washing in the washer-dryer.

Cleaning and care

⚠ Risk of electric shock!

First, always disconnect the appliance from the power supply.

Never clean the appliance with a water jet.

⚠ Risk of explosion!

Never clean the appliance with solvents.

Clean housing, fascia and supply lines

As required:

- Use hot soapy water or a mild, non-abrasive cleaning agent.
- Wipe dry with a soft cloth.

Cleaning the drum

If metal items (e.g. coins, paper clips, needles, nails) left in the drum have caused rust spots:

- Use chlorine-free cleaning agents; comply with the manufacturer's instructions. Never use steel wool.

Cleaning the detergent dispenser

In the event that residual detergents or additives have accumulated:

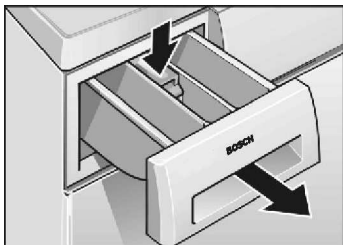

- Pull out the detergent drawer all the way,
- press down the insert and
- remove the detergent drawer.

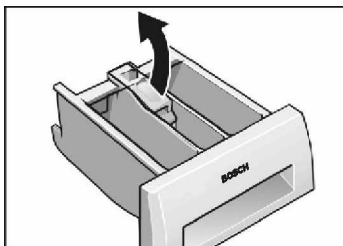

- Open the cover.
- Clean the detergent drawer and cover under running water and dry.

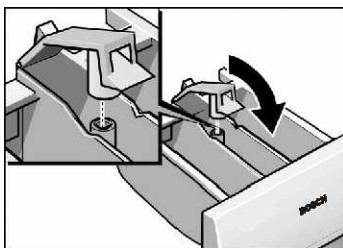

- Close the cover and lock into position.
- i** Insert the cover cylinder onto the guide pin.
- Slide in the detergent drawer.

Cleaning the drain pump

Drain the water

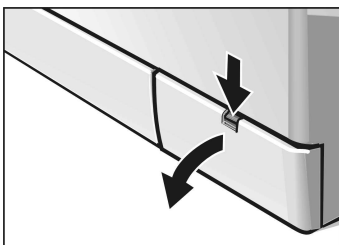

WVD24520

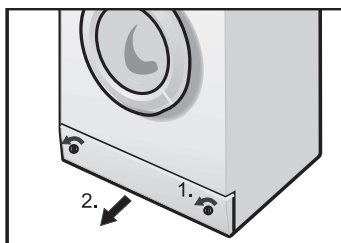

WVD2452X

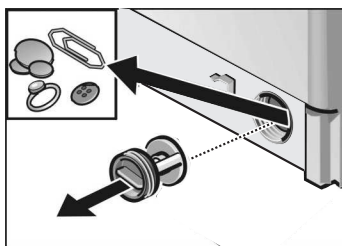
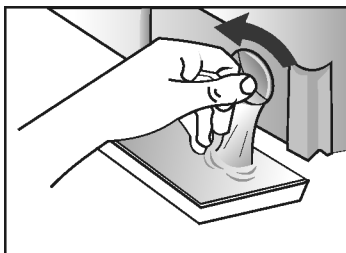

This is necessary if the washing solution has not been completely drained. The pump is blocked by either loose debris or fluff which accumulates if fluff-giving fabrics are washed.

(Up to 20 litres. Have a suitable container ready.)

⚠ Risk of scalding!

Allow the hot water to cool down beforehand. Keep children and pets away.

- Turn the programme selector to **Stop**.
- Open service flap.

- Carefully unscrew the pump cap - do not remove it completely - and let the water drain out into a shallow container (let the remainder drip onto a floor cloth). Repeat the operation until there is no water left in the machine.

- Remove the pump cover.
- Remove foreign objects/fluff from inside and clean the interior. The pump impeller wheel must be able to rotate.

Clean any residual lye or fluff from the thread of the pump cover and pump housing.

- Insert the pump cover and screw tight.
- Insert and close the service flap.

To prevent unused detergent from flowing into the drain during the next wash cycle:

- Pour 1 litre of water into chamber II.
- Select the  programme.

Cleaning water inlet strainers

This is necessary if very little or no water flows into the washer-dryer.

First, reduce the water pressure in the inlet hose:

- Turn off the tap.
- Turn the programme selector to any programme (except  / .
- Touch the **Inicio/Pausa** button, and allow the programme to run for approx. 40 seconds.
- Turn the programme selector to **Stop**.

Cleaning the strainer at the water tap

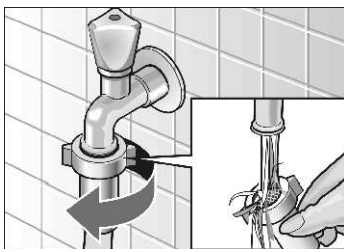

- Disconnect the hose from the water tap.
- Rinse the strainer under flowing water.
- Connect the hose.

Cleaning the strainer on the washer-dryer

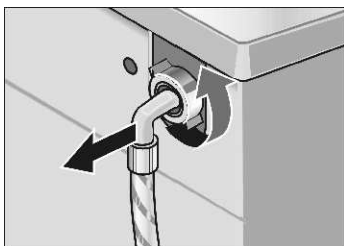

- Disconnect the hose from the back of the washer-dryer.

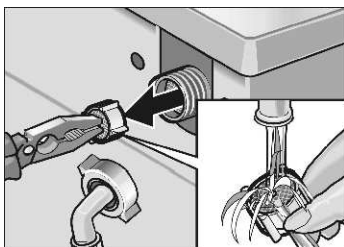

- Pull out the strainer and rinse under running water.
- Insert the strainer and reconnect the hose.
- Turn on the water tap and check whether water is still discharged. If water is leaking, check that the filter is correctly seated.
- Turn off the tap.

Descaling the washer-dryer

Attention

Descaling agents contain acids which may corrode the components of the washer-dryer and discolour the laundry.

Provided that you use the correct amount of detergent, it is not necessary to descale the washer-dryer.

If descaling is nevertheless required, please follow the instructions supplied by the manufacturer of the descaling agent.

Help with minor problems

If repairs are needed, and assuming that you cannot eliminate the fault yourself with the aid the following table:



- Turn the programme selector to **Stop**.
- Disconnect the appliance from the mains.
- Turn off the tap.
- Call customer service, see page 53.





⚠ Risk of electric shock!



Repairs may be carried out by customer service or authorised technicians only.

Fault displays

Text in display field and signal emitted	Possible cause	Remedial action
F:16	Door not closed properly.	Check whether laundry is trapped in door; Close the washer-dryer door.
F:17	Tap not turned on.	Turn the tap on.
	Inlet hose kinked or pinched.	Eliminate cause.
	Filter blocked in water inlet hose.	Clean filter, see page 46.
	Water pressure too low.	Eliminate cause.
F:18	Loose debris is blocking the pump.	Clean the pump, see page 45.
	Drainage pipe and/or drainage hose blocked.	Clean drainage pipe and/or drainage hose.
	There is too much residual water in the drum when drying.	Stop the drying programme, select the “  ” programme before drying.



Problems	Cause	Remedial action
Washer-dryer door cannot be opened.	There is still some water in the appliance, “----” (without final spin) selected.	Select  or  .
	Safety function is active.	Wait for 2 minutes.
Detergent residue in the detergent drawer.	Damp or lumpy detergent.	Clean and dry the detergent dispenser; see page 44.
	Difficult-to-dissolve detergent tablets used.	Use the dosing aid for liquid detergent. Before filling dispenser II , crush the tablets in the packet.
Odour in the appliance.	Washing at mainly low temperatures and/or with liquid detergents.	Run the Resistents/Algod. 90 °C programme without washing. Use a standard detergent.
Control lights do not come on.	A fuse has tripped.	Switch on/replace the fuse. If the fault occurs repeatedly, call Customer Service.
	Power failure.	An interrupted programme will be resumed when the power returns. If you wish to unload the laundry, proceed as in Cleaning the drain pump , page 45.
	Plug is loose or not plugged in.	
Programme does not start.	Loading door not closed properly.	Check whether laundry is trapped in door. Close the loading door (a click should be heard).
	Inicio/Pausa button not touched.	Touch the Inicio/Pausa button.
Water does not enter the machine or detergent is not washed away.	Tap not turned on.	Turn the tap on.
	Inlet hose kinked or pinched.	
	Filter blocked in water inlet hose.	Clean the strainer; see from page 46.
Detergent in chamber I is not washed away.	A programme without Prelava.(Prewash) was selected.	Select additional function Prelava.(Prewash) .

Problems	Cause	Remedial action
Water not visible in the drum.	Not a fault. The water lies below the visible part of the drum.	
Washing solution is not completely drained.	Pumped blocked by foreign objects. Fluff-producing laundry was washed. The water drainage pipe or drain hose is blocked.	Clean the pump (refer to page 45). Clean drainage pipe and/or drainage hose.
Water runs out from under the appliance.	Screw fitting of the inlet hose is leaking. Drainage hose is leaking.	Tighten the screw-fitting. Replace the drain hose.
Foam comes out of the detergent drawer. The  symbol is displayed at the end of the programme.	Too much detergent or detergent not suitable for use in washing machines used.	Mix 1 tablespoon of fabric softener with ½ litre of water and pour into chamber II of the detergent dispenser. Reduce detergent dosage for next wash cycle or use detergent which is suitable for use in washing machines.
The washing has not been spun correctly.	Large laundry items have become entangled and are not evenly distributed in the drum. For safety reasons, the high-speed final spin cycle was automatically cancelled.	Do not put only large items in the drum.
Spin result unsatisfactory.	Fácil  button touched - for reduced spin speed see page 27. The  or  programme selected maximum spin speed: see page 26.	
Spin cycle actuated several times.	Not a fault. Unbalanced load detection system is attempting to compensate the imbalance by spinning the washing several times.	
Washing result not satisfactory.	Soiling is greater than expected or recommended load has been exceeded. Detergent was underdosed.	Select suitable programme and touch the  button or reduce load. Dose detergent according to the manufacturer's instructions.

Problems	Cause	Remedial action
Detergent residue on the washing.	Some phosphate-free detergents contain water-insoluble residue which may appear as light stains on the washing.	Select  immediately or brush out the washing after drying.
Grey residue on the washing.	Soiling caused by ointment, grease or oil.	Select maximum detergent dosage and maximum permitted temperature for the next wash cycle.
Programme duration changed during the programme sequence	Not a fault. See also explanations in the chapter Display field, programme duration from page 11.	
Programme duration reduced	Not a fault. For small amounts of laundry, a reduction in time of approx. 30 minutes can result, depending on washing/drying programme.	
Programme duration extended	An overdosage of detergent has caused excessive formation of froth. An additional rinse cycle and spin cycle was run to ensure a good rinsing result. The  symbol is displayed when the overdosage of detergent is detected.	Reduce the detergent dosage for the next wash cycle.
	For severe imbalances during spinning, an increase in time of approx. 10 minutes can occur because of repeated distribution of the laundry.	Wash large and small items together in order to reduce the imbalance.
	If very cold water must be heated up, an increase in time up to 20 minutes can result.	
Drying programme does not start	Drying programme not selected.	Select the desired drying programme.
	Drying time/mode not set, or, set drying time is too short.	Set the reasonable drying time/mode.
	Tap not turned on.	Turn on the tap.
	Loading door not closed properly.	Check whether laundry is trapped in door. Close the loading door (a click should be heard).
	Pump is blocked.	Clean the pump, see page 45.

If the fault recurs, call Customer Service, see page 53.

Consumption values

Normal programme	Additional option	Load	Consumption values **		Programme duration
			Power	Water	
Resistentes/Algod. 40 °C	–	5 kg	0.46 kWh	51.6 l	1:08 h
Resistentes/Algod. 60 °C	–	5 kg	1.02 kWh	51.5 l	1:25 h
Color eco/Cor eco 60 °C	☰*	5 kg	0.90 kWh	44.9 l	2:10 h
Resistentes/Algod. 90 °C (the hot washing solution is mixed with approx. 7 litres of cold water before being drained)	–	5 kg	1.72 kWh	58.6 l	1:50 h
Sintéticos 40 °C	–	2.5 kg	0.34 kWh	33.8 l	0:50 h
Delicado/Seda 30 °C	–	2 kg	0.32 kWh	39 l	0:37 h
Lana/lã  30 °C	–	2 kg	0.17 kWh	33.1 l	0:42 h
Ropa oscura/Roupa escura 30 °C	–	2.5 kg	0.32 kWh	52.1 l	1:06 h
Clinic Wash 40 °C	–	5 kg	0.81 kWh	73.5 l	1:23 h
Sport 30 °C	–	2.5 kg	0.21 kWh	38.6 l	0:41 h
Rápido 15min 30 °C	–	2 kg	0.21 kWh	34.8 l	0:15 h
Mix 40 °C	–	2.5 kg	0.60 kWh	36.2 l	0:50 h
Intensivo secar 	–	2.5 kg	1.83 kWh	30.6 l	1:51 h
Delicado secar 	–	1.5 kg	1.16 kWh	29 l	1:27 h
Color eco/Cor eco 60 °C + Intensivo secar  (2 auto drying cycles)	☰*	5 kg	4.56 kWh	106 l	5:52 h (2:10h + 3:42 h)

* Programme setting with ☰ option for test in accordance or in conformity with EN 50 229 and IEC 50 229.

** Consumption values will differ from the indicated values depending on the water pressure, water hardness, water inlet temperature, ambient temperature, type and quantity of laundry and degree of soiling, utilised detergent, fluctuations in the mains voltage and selected additional options.

Customer service

Before you call customer service, please check whether you can eliminate the fault yourself (see from page 48).

A technician who is called out to give advice will charge you, even if the appliance is still under guarantee.

You can find your nearest customer service in the enclosed address list. Please provide customer service with the product number (E-Nr.) and the production number (FD) of the appliance.

Rating plate

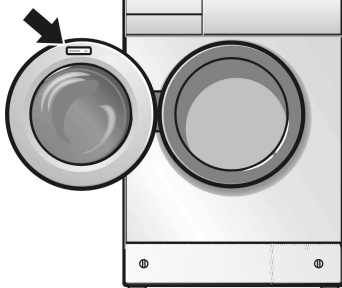

These numbers are shown on the rating plate which can be found on the frame of the open door and also on the identification plate, enclosed by a thick line, on the front of the machine behind the nameplate.

E-Nr. _____	FD _____
-------------	----------

Product number

Production number

Please note the two numbers in the space provided above.

In specifying the product number and production number of your appliance, you help us in our attempt to prevent unnecessary travelling and the associated extra costs.

Installing, connecting and transporting

Safety instructions

⚠ Risk of injury!

The washer-dryer is heavy. Take care when lifting it.

Attention

Frozen hoses may tear/burst. Do not install the washer-dryer in an area where there is a risk of frost or outdoors.

The washer-dryer may be damaged. Do not lift the washer-dryer by its projecting parts (e.g. door).

In addition to the safety information listed here, the local water and electricity supplier may have special requirements.

If in doubt, have the appliance connected by a specialist.

Standard accessories

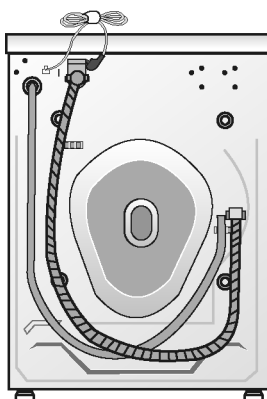

On the rear of the washer-dryer:

- Water drainage hose.
- Water-inlet hose.
- Elbow for attaching the drainage hose e.g. to the sink.
- Mains cable with plug.

Moisture in the drum is due to the final inspection which every washer-dryer undergoes before it leaves the factory.

Depending on the connection situation, the following part is also required:

- 1 hose clip \varnothing 24-40 mm (DIY store) is also required for connection to a siphon.

The bag contains:

- Covers for holes left by removing the transport bolts.

Useful tools

The following tools are helpful:

- Box wrench A/F 13 for removing the transportation bolts.
- Spirit level for aligning the washer-dryer.

Dimensions

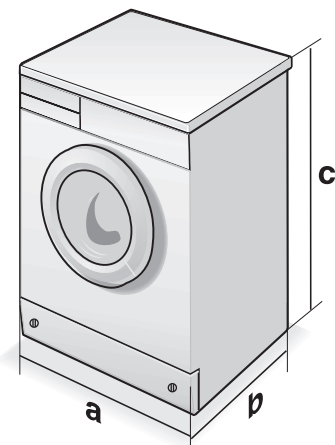

a = 600 mm

b = 560 mm

c = 860 mm

Weight 73 kg

Installation surface

Appliance stability is important so that the washer-dryer does not “wander” during the spin cycles.

The installation surface must be solid and level. Soft floor coverings, e.g. carpets or floor coverings with a foam backing are not suitable.

If the washer-dryer is to be installed on a wooden floor:

- If possible, install the washer-dryer in a corner.
- Screw a water-resistant wooden board (at least 30 mm thick) to the floor.
- Secure the washer-dryer feet with fixing brackets*.

If the washer-dryer is to be installed on a base:

- Secure the washer-dryer feet with fixing brackets*.

* Holding brackets (set) can be obtained from a specialist store or the Customer Service, order no. WMZ 2200.

Removing the transportation protection devices

⚠ Caution

The transport bolts must always be removed before using the appliance for the first time and must be retained for any subsequent transport (e.g. when moving).

- Release all screws **A** using the A/F 13 wrench until they can be moved freely.
- Remove the four spacers. They will fall to the floor when you tip the machine.

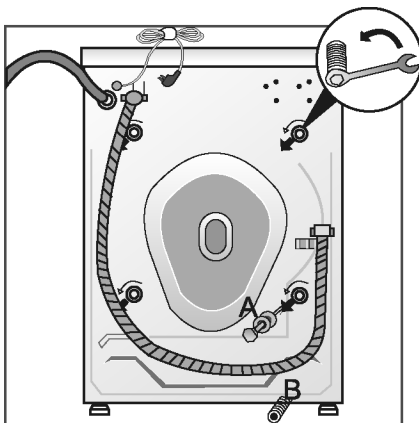

- Insert the covers.

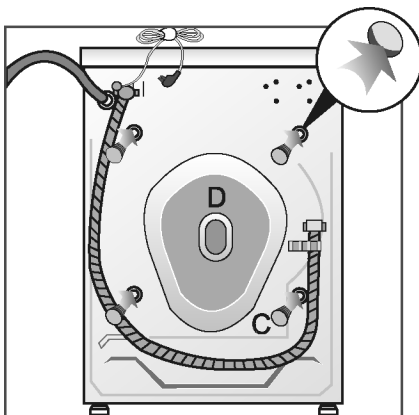

Built-under or built-in appliance installation

The appliance must be built under or built in prior to connecting the power supply.

The appliance can be built into or under a kitchen work surface. For this purpose, a recess width of 60 cm is required.

- The washer-dryer must only be installed under a one-piece worktop that is permanently attached to the surrounding cabinets.

Attention

For safety reasons in built-under installation, a cover plate* must be assembled by a specialist in place of the appliance cover plate.

- * Cover plate (set) can be obtained from a specialist store or the Customer Service, order no. WMZ 2420.

Hose and cable lengths

Connection on left side

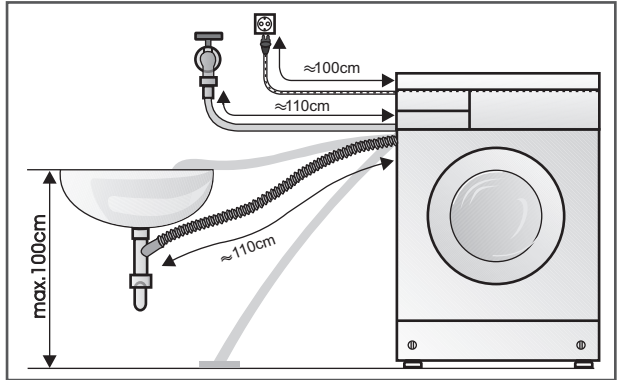

Connection on right side

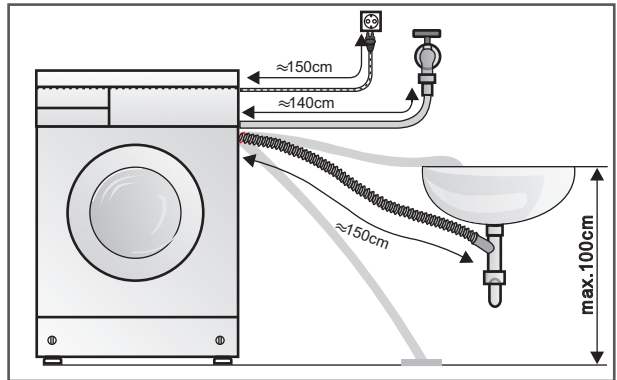

Other hoses

Available from specialist dealers:

- Extended supply hose (approx. 2.20 m).

Connecting the water

Water inlet hose

⚠ Risk of electric shock!

To prevent leaks or water damage, it is essential to follow the instructions in this chapter!

Attention

Operate the washer-dryer with cold drinking water only. Do not connect to the mixer tap of an unpressurised hot-water apparatus.

If in doubt, have the appliance connected by a specialist.

Do not use a used inlet hose. Only use the inlet hose supplied or one which was purchased from an authorised specialist dealer.

The water inlet hose must not be

- kinked or crushed,
- modified or severed (strength is no longer guaranteed).

Plastic threads must only be tightened by hand. Do not remove the strainers from the water supply hose.

Check the mains water pressure:

- The water pressure should be between 1 and 10 bars (when the tap is turned on, at least 8 litres of water is discharged per minute).
- If the water pressure is higher, install a pressure reducing valve.

Connect the water supply hose

- to the rear panel of the washer-dryer and ...

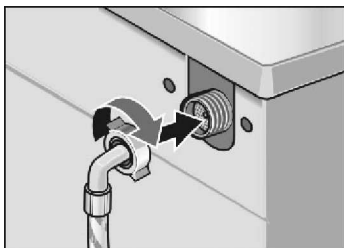

- to the tap.

- After connecting the water inlet hose: Turn on the water tap completely, and check connection points for water-tightness.

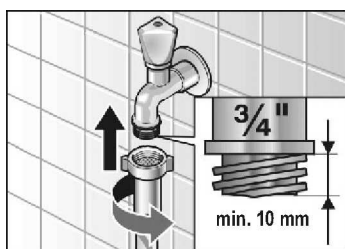

Water drainage hose

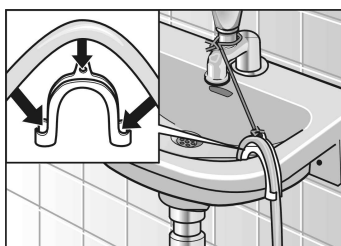
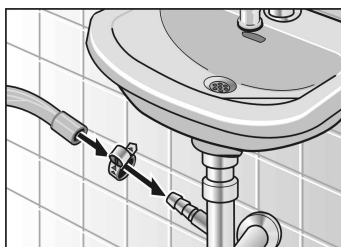

Warning

Do not bend or pull the water drainage hose.

Height difference between the placement area and drainage point: maximum 100 cm.

Drainage into a siphon:

- ❑ Secure connection point with 24-40 mm Ø hose clip (specialist outlet).

Drainage into a wash basin:

Attention

The plug must not block the drain of the wash basin.

- ❑ Secure the drainage hose to prevent it from slipping out of the sink.
- ❑ When the water is being pumped out of the washer-dryer, check that the water drains away quickly enough.

Aligning the washer-dryer

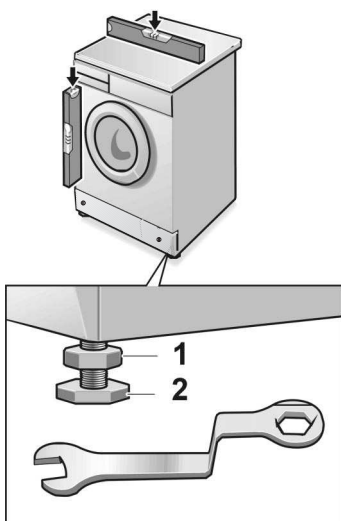

All four appliance feet must be firmly on the ground. The washer-dryer must not wobble.

Level the washer-dryer with the assistance of the four adjustable feet and a spirit level:

- ❑ Loosen the lock nut **1** using the wrench.
- ❑ Adjust the height by rotating the foot **2**.
- ❑ Tighten the lock nut **1** against the housing.

Connecting the power

Caution

Connect the washer-dryer only to an alternating current via a correctly installed earthed socket.

The mains voltage must correspond to the voltage specification on the washer-dryer (nameplate). Connection specifications as well as the required fuses are stipulated on the appliance nameplate.

Ensure that:

- The mains plug and socket are compatible.
- The cable cross-section is adequate.
- The earthing system has been installed correctly.

The mains cable may be changed (if required) by an electrician only.

Replacement mains cable available from Customer Service.

Do not use multiple plugs/sockets or extension cables.

In the event that an earth-leakage circuit breaker is to be used, only use types marked with the following symbol: .

Only this symbol can guarantee compliance with all current regulations.

Do not insert/pull out the mains plug with wet hands.

Do not pull out the mains plug by tugging the cable.

Transport, e.g. when moving

Before transporting the washer-dryer:

- Turn off the tap.
- Reduce the water pressure in the water inlet hose (refer to page 46).
- Drain any residual washing solution (refer to page 45).
- Disconnect the washer-dryer from the mains.
- Dismantle the supply and drainage hose.
- Install transportation protection devices.

Having transported the appliance and ensured proper installation and connection, allow the programme to run through before starting the first wash programme.

Transporting the washer-dryer:

Preparing and inserting the transport bolts

- Remove the 4 covers **C**.
- Remove the rear cover **D** and prepare the transport bolts.
- Insert and tighten the transport bolts.

