

Safety instructions

- The washing machine is heavy – caution when lifting it.
- Warning: Frozen hoses may tear/burst. Do not install washing machine in areas where there is a risk of frost and/or outdoors.
- Washing machine may be damaged. Do not lift by projecting components (e.g. washing machine door).
- In addition to the instructions mentioned here, special regulations of the relevant water and power supply companies may apply.
- If in doubt, have the appliance connected by a technician.
- Lay hoses and cables in such a way that there is no risk of stumbling.

Scope of delivery

according to model

Humidity in the drum is caused by the final inspection.

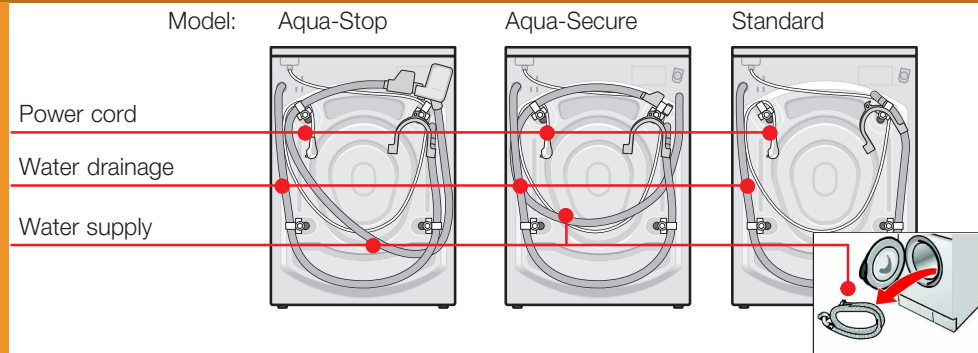

Depending on the connection

- 1 hose clip Ø24–40 mm (specialist outlet) for connection of the siphon is also required -> page 4; Water connection.

Useful tool

- Spirit level for alignment.

Installation area

- Stability is important to prevent the machine from wandering!
- The installation area must be firm and level.
- Soft floors/floor coverings are not suitable.

If installing the appliance on a base

- The feet of the appliance **must** be secured with holding brackets; order no. WMZ 2200, WX 9756, CZ110600, Z 7080X 0.

If installing the appliance on a wooden joist

- If possible, install the washing machine in a corner.
- Screw a water-resistant wooden panel (min. 30 mm thick) to the floor.
- The feet of the appliance **must** be secured with holding brackets; order no. see above.

1

Hose and cable lengths depending on model

Connection on left side or Connection on right side

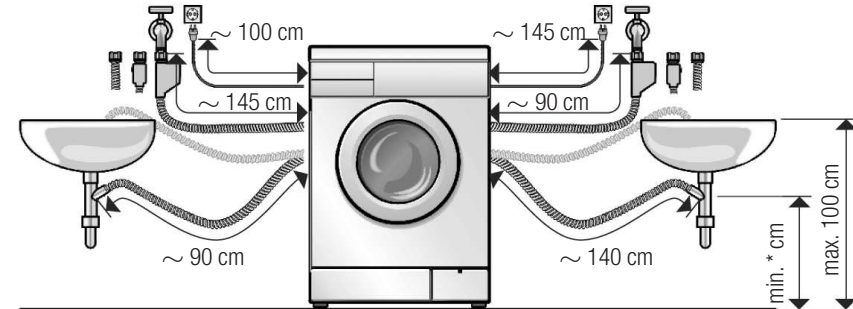

* Standard and Aqua-Secure models: min. 60 cm - max. 100 cm
Aqua-Stop model: 0 - max. 100 cm

Available from dealer/customer service:

- Extension for Aqua-Stop and cold water inlet hose (approx. 2.50 m), Order no. WMZ 2380, WZ 10130, CZ11350, Z 7070X 0.
- Longer supply hose (approx. 2.20 m), for standard model.

Built-under/Built-in appliance

- Build under/build in before connection to the power supply.

Installed in between kitchen units (built under or built in)

- 60 cm cavity width required.
- Install washing machine only under a continuous worktop connected firmly to the adjacent cupboards.

Built-under appliance

Risk of electric shock!

- 60 cm cavity width required.
- Instead of the appliance cover panel, have a technician install a sheet metal cover * (* order no. WMZ 2420, WZ 10190).

2

Remove transportation protection devices

- Before using the appliance for the first time, remove all the transportation protection devices and retain for subsequent transportation of the appliance.
- For any future transport, the transport braces must be refitted - this prevents the machine from being damaged. -> page 6.
- Keep the bolt and sleeve screwed together.

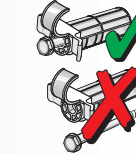

1. Take the hoses and elbow out of the holders, depending on model.

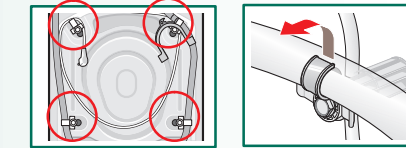

2. Loosen the bolts

... until they move freely in the sleeves.

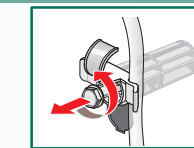

3. Completely remove all 4 transportation protection devices (each bolt together with sleeve) and take the main cable out of the holder.

Always displace bolt and sleeve together as shown in the illustration.

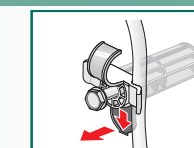

All bolts and sleeves must be removed.

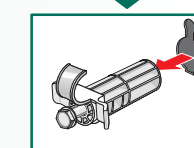

4. Insert covers.



3

Water connection depending on model

- Risk of electric shock! Do not immerse Aqua-Stop safety device in water (contains an electric valve).
- To prevent leakage or water damage, follow the instructions in this chapter!
- **Attention:** Operate the washing machine with cold drinking water only. Do not connect to a mixer tap of a pressureless hot-water heater.
- Do not use a used inlet hose. Only use the inlet hose supplied or one which was purchased from an authorised specialist dealer.
- If in doubt, have the appliance connected by a technician.

Water supply

Water supply hose:

Attention: Do not kink, crush, modify or sever water supply hose (strength is no longer guaranteed).

Optimum water pressure in the mains: 100–1000 kPa (1–10 bar)

- When the tap is turned on, the water flow is at least 8 l/min.
- If the water pressure is higher, install a pressure reducing valve.

Model: Aqua-Stop Aqua-Secure Standard

1. Connect water supply hose to the tap. Tighten plastic screw-fittings by hand only.

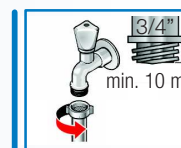
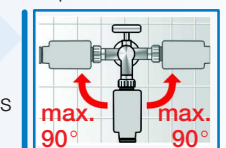

2. Open water tap carefully, checking the leak tightness of the connection points.

Attention: Screw fitting is under mains water pressure.

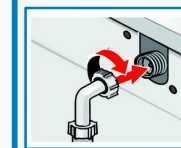
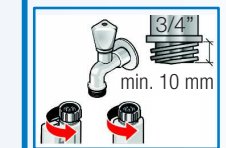

Water drainage

Water drainage hose:

Attention: Do not kink or protract the drainage hose.

Height difference between installation area and outlet:

- min. 60 cm – max. 100 cm for aqua-secure and standard models
- 0 – max. 100 cm for aqua-stop model

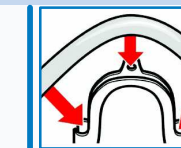

Drainage into a washbasin:

Attention: Secure the drainage hose from slipping out.

Attention: The washbasin outlet must not be sealed by the plug. Check that the water is pumped out quickly enough. Do not insert the end of the drainage hose into the pumped off water! There is a risk that water will be drawn back into the washing machine!

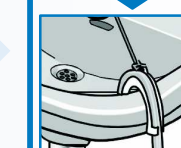

Drainage into a siphon:

Attention: Secure connection point with hose clip, Ø 24–40 mm (dealer).

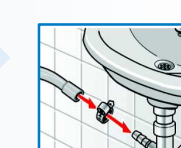

4

Alignment

 Loud noise formation, intense vibrations and "wandering" may be due to incorrect alignment!

Align washing machine with spirit level.

- Loosen lock nut in a clockwise direction with a wrench.

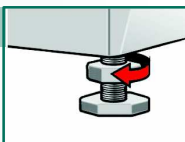

- Change height by rotating the appliance feet.

All four appliance feet must be firmly on the floor.
The washing machine must not wobble!

Check alignment of the washing machine with a spirit level and, if required, correct.

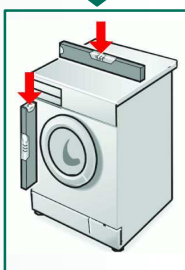

- Tighten the lock nut against the housing.

– Grip the foot and do not adjust the height.

The lock nuts on all four appliance feet must be screwed tightly against the housing!

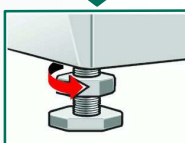

Electrical connection

Connect the washing machine to an alternating current via a correctly installed earthed socket only.

The mains voltage and voltage specifications on the washing machine (appliance rating plate) must match.

Connected load as well as required fuse are indicated on the appliance rating plate.

Ensure that:

- the mains plug and socket match,
- the cable cross-section is adequate,
- the earthing system has been installed correctly.

A damaged power cord may be replaced by an electrician only.
Replacement power cord available from customer service.

Do not use multiple plugs/couplings or extension cables.

If a residual current operated circuit-breaker is used, use only a type which features this symbol: 

Only this symbol guarantees compliance with the currently valid regulations.

Do not insert/pull out the plug with damp hands.

Do not pull out the mains plug by tugging the power cord.

Manufacturer (see Operating instructions)

0209/9000 296 544

5

Transportation, e.g. if moving house

1. Before transporting the washing machine:

- Turn off the tap.
- Release the water pressure in the supply hose.
–> *operating instructions, page 10*; Filter in the water supply.
- Drain any residual detergent solution.
–> *operating instructions, page 10*; Detergent solution pump.
- Isolate the washing machine from the power supply.
- Remove the hoses.

2. Preparing and installing the transportation protection devices:

- Remove the covers.

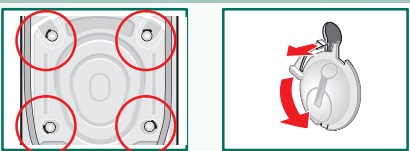

- Insert all 4 transportation protection devices and clamp the mains cable to the holders. Tighten the bolts.

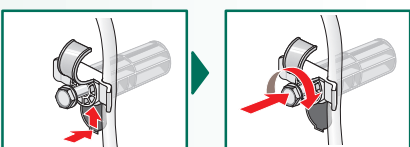

 After transportation, the transportation protection devices **must** be removed. –> *page 3*.

 To prevent unused detergent from flowing straight into the drain during the next wash: Pour 1 litre of water into compartment II and start the **Drain** programme.

Technical specifications

Dimensions (width x depth x height) 60 x 59 x 84,2 cm

Weight 69 - 83 kg *depending on model*

Mains connection Nominal voltage 220–240 V, 50 Hz
Nominal current 10A
Nominal power 2000–2300 W

Water pressure 100-1000 kPa (1-10 bar)

Test programmes According to currently valid IEC 60 456

6

Customer service

 Before calling customer service, please check whether you can eliminate the fault yourself.
–> *operating instructions, What to do if ...*

 If you require advice, even during the warranty period, you will incur costs for the call-out of a technician.

 You can find your nearest customer service in the enclosed list. Please give customer service the product number (E-Nr.) and the production number (FD) of the appliance.

E-Nr. _____ FD _____

Product number Production number

You can find the rating plate which contains this information in the frame of the open washing machine door and in the thick bordered box on the appliance rating plate at the back of the appliance.

 Please help by quoting the product number and production number to prevent unnecessary call-outs. This will save you additional costs.

Aqua-Stop warranty

For appliances with Aqua-Stop only

In addition to warranty claims against the seller based on the contract of sale and in addition to our appliance warranty we shall pay damages under the following conditions:

- If water damage was caused by a fault in our Aqua-Stop system, we shall compensate private users for damage.
- The liability warranty applies to the service life of the appliance.
- A claim can only be made under the warranty if the appliance and Aqua-Stop have been correctly installed and connected according to our instructions; this also includes a correctly installed Aqua-Stop extension (original accessory).
Our warranty does not extend to defective supply lines or fittings up to the Aqua-Stop connection on the tap.
- Appliances which feature Aqua-Stop can be left unattended during operation and it is not necessary to turn off the tap afterwards.
The tap should only be turned off if you are away for a prolonged period, e.g. several weeks holiday.

7

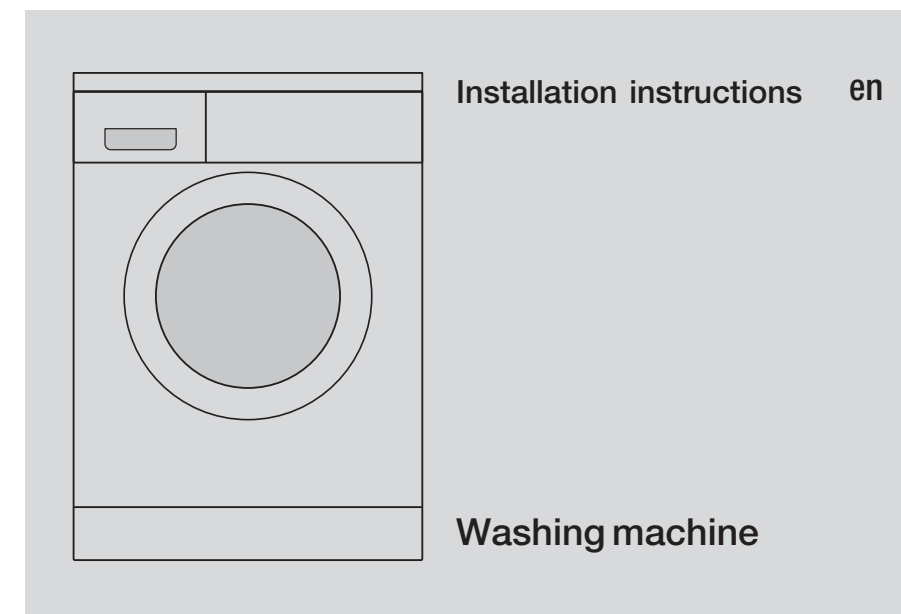















Installation instructions en

Washing machine

Contents

Page

	Safety instructions	1
	Scope of delivery	1
	Installation area	1
	Hose and cable lengths	2
	Built under and built in	2
	Removing transportation safety devices	3
	Water connection	4
	Aligning the appliance	5
	Electrical connection	5
	Transportation, e.g. if moving house	6
	Technical specifications	6
	Customer service	7
	Aqua-Stop warranty	7

 **Read these instructions before switching on the washing machine!**
Also follow the separate operating instructions.
Retain all documents for subsequent use or for the next owner.



Safety instructions

- The washing machine is heavy – caution when lifting it.
- Warning: Frozen hoses may tear/burst. Do not install washing machine in areas where there is a risk of frost and/or outdoors.
- Washing machine may be damaged. Do not lift by projecting components (e.g. washing machine door).
- In addition to the instructions mentioned here, special regulations of the relevant water and power supply companies may apply.
- If in doubt, have the appliance connected by a technician.
- Lay hoses and cables in such a way that there is no risk of stumbling.

Scope of delivery

according to model

Humidity in the drum is caused by the final inspection.

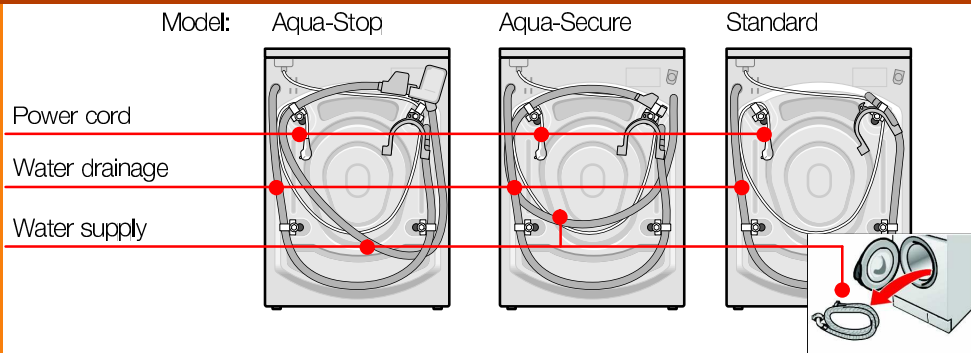

Covers

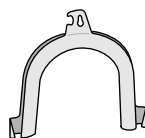

Elbow for fixing the waste water hose

Depending on the connection

- 1 hose clip $\varnothing 24-40$ mm (specialist outlet) for connection of the siphon is also required → page 4; Water connection.

Useful tool

- Spirit level for alignment.

Installation area



- Stability is important to prevent the machine from wandering!
- The installation area must be firm and level.
- Soft floors/floor coverings are not suitable.



If installing the appliance on a base

- The feet of the appliance **must** be secured with holding brackets; order no. WMZ 2200, WX 9756, CZ110600, Z 7080X 0.



If installing the appliance on a wooden joist

- If possible, install the washing machine in a corner.
- Screw a water-resistant wooden panel (min. 30 mm thick) to the floor.
- The feet of the appliance **must** be secured with holding brackets; order no. see above.

Hose and cable lengths depending on model



Connection on left side

or

Connection on right side

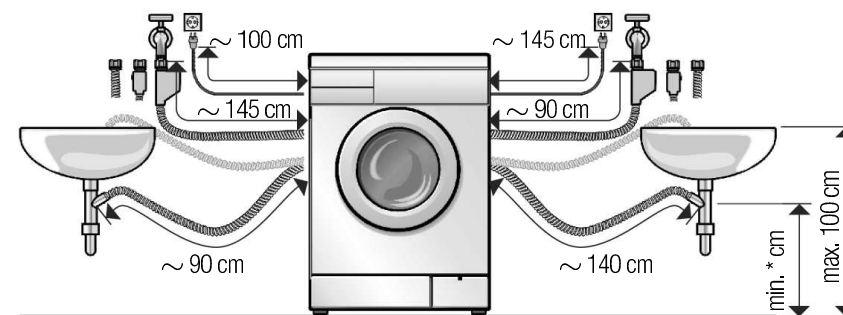

* Standard and Aqua-Secure models: min. 60 cm - max. 100 cm
 Aqua-Stop model: 0 - max. 100 cm

Available from dealer/customer service:

- Extension for Aqua-Stop and cold water inlet hose (approx. 2.50 m), Order no. WMZ 2380, WZ 10130, CZ11350, Z 7070X 0.
- Longer supply hose (approx. 2.20 m), for standard model.

Built-under/Built-in appliance



Build under/build in before connection to the power supply.



Installed in between kitchen units (built under or built in)

- 60 cm cavity width required.
- Install washing machine only under a continuous worktop connected firmly to the adjacent cupboards.

Built-under appliance

Risk of electric shock!



- 60 cm cavity width required.
- Instead of the appliance cover panel, have a technician install a sheet metal cover* (* order no. WMZ 2420, WZ 10190).

Remove transportation protection devices



- Before using the appliance for the first time, remove all the transportation protection devices and retain for subsequent transportation of the appliance.
- For any future transport, the transport braces must be refitted - this prevents the machine from being damaged. → page 6.
- Keep the bolt and sleeve screwed together.

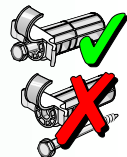

1. Take the hoses and elbow out of the holders, depending on model.

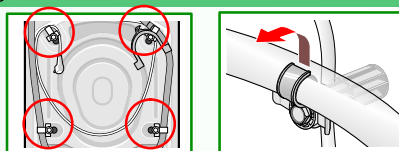

2. Loosen the bolts

... until they move freely in the sleeves.

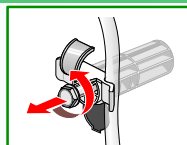

3. Completely remove all 4 transportation protection devices (each bolt together with sleeve) and take the main cable out of the holder.

Always displace bolt and sleeve together as shown in the illustration.

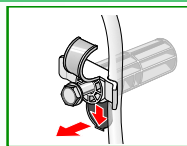

All bolts and sleeves must be removed.

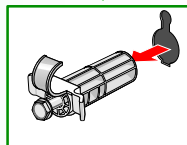

4. Insert covers.



Water connection

depending on model



- Risk of electric shock! Do not immerse Aqua-Stop safety device in water (contains an electric valve).
- To prevent leakage or water damage, follow the instructions in this chapter!
- **Attention:** Operate the washing machine with cold drinking water only. Do not connect to a mixer tap of a pressureless hot-water heater.
- Do not use a used inlet hose. Only use the inlet hose supplied or one which was purchased from an authorised specialist dealer.
- If in doubt, have the appliance connected by a technician.



Water supply

Water supply hose:

Attention: Do not kink, crush, modify or sever water supply hose (strength is no longer guaranteed).

Optimum water pressure in the mains: 100–1000 kPa (1–10 bar)

- When the tap is turned on, the water flow is at least 8 l/min.
- If the water pressure is higher, install a pressure reducing valve.

Model: Aqua-Stop
Aqua-Secure

Standard

1. Connect water supply hose to the tap. Tighten plastic screw-fittings by hand only.

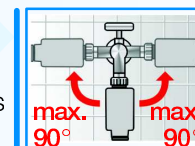

2. Open water tap carefully, checking the leak tightness of the connection points.

Attention: Screw fitting is under mains water pressure.

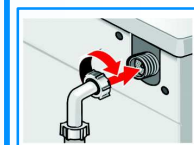
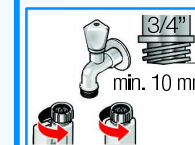

Water drainage

Water drainage hose:

Attention: Do not kink or protract the drainage hose.

Height difference between installation area and outlet:

- min. 60 cm – max. 100 cm for aqua-secure and standard models
- 0 – max. 100 cm for aqua-stop model

Drainage into a washbasin:

Attention: Secure the drainage hose from slipping out.

Attention: The washbasin outlet must not be sealed by the plug. Check that the water is pumped out quickly enough. Do not insert the end of the drainage hose into the pumped off water! There is a risk that water will be drawn back into the washing machine!

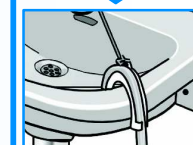
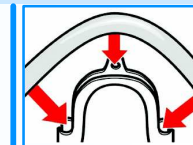

Drainage into a siphon:

Attention: Secure connection point with hose clip, Ø 24–40 mm (dealer).

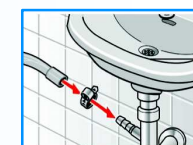

Alignment

 Loud noise formation, intense vibrations and "wandering" may be due to incorrect alignment!



Align washing machine with spirit level.

1. Loosen lock nut in a clockwise direction with a wrench.
2. Change height by rotating the appliance feet.
All four appliance feet must be firmly on the floor.
The washing machine must not wobble!
Check alignment of the washing machine with a spirit level and, if required, correct.
3. Tighten the lock nut against the housing.
– Grip the foot and do not adjust the height.
The lock nuts on all four appliance feet must be screwed tightly against the housing!

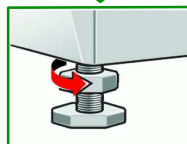
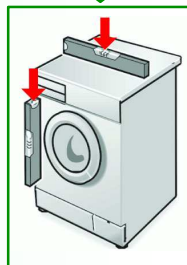
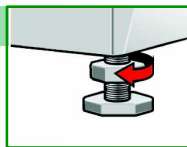

Electrical connection

- Connect the washing machine to an alternating current via a correctly installed earthed socket only.
- The mains voltage and voltage specifications on the washing machine (appliance rating plate) must match.
- Connected load as well as required fuse are indicated on the appliance rating plate.
- Ensure that:
 - the mains plug and socket match,
 - the cable cross-section is adequate,
 - the earthing system has been installed correctly.
- A damaged power cord may be replaced by an electrician only.
Replacement power cord available from customer service.
- Do not use multiple plugs/couplings or extension cables.
- If a residual current operated circuit-breaker is used, use only a type which features this symbol: 
Only this symbol guarantees compliance with the currently valid regulations.
- Do not insert/pull out the plug with damp hands.
Do not pull out the mains plug by tugging the power cord.

Manufacturer (see Operating instructions)

0209/9000 296 544

Transportation, e.g. if moving house

1. Before transporting the washing machine:

1. Turn off the tap.
2. Release the water pressure in the supply hose.
→ operating instructions, page 10; Filter in the water supply.
3. Drain any residual detergent solution.
→ operating instructions, page 10; Detergent solution pump.
4. Isolate the washing machine from the power supply.
5. Remove the hoses.

2. Preparing and installing the transportation protection devices:

1. Remove the covers.
2. Insert all 4 transportation protection devices and clamp the mains cable to the holders. Tighten the bolts.

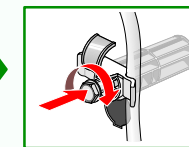
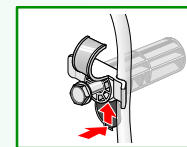
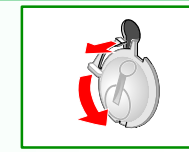
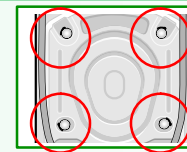

After transportation, the transportation protection devices **must** be removed. → page 3.



To prevent unused detergent from flowing straight into the drain during the next wash: Pour 1 litre of water into compartment II and start the **Drain** programme.

Technical specifications

Dimensions (width x depth x height)	60 x 59 x 84,2 cm
Weight	69 - 83 kg depending on model
Mains connection	Nominal voltage 220–240 V, 50 Hz Nominal current 10A Nominal power 2000–2300 W
Water pressure	100-1000 kPa (1-10 bar)
Test programmes	According to currently valid IEC 60 456

Customer service

Before calling customer service, please check whether you can eliminate the fault yourself. -> operating instructions, What to do if ...

If you require advice, even during the warranty period, you will incur costs for the call-out of a technician.

You can find your nearest customer service in the enclosed list. Please give customer service the product number (E-Nr.) and the production number (FD) of the appliance.

E-Nr. _____ FD _____

Product number Production number

You can find the rating plate which contains this information in the frame of the open washing machine door and in the thick bordered box on the appliance rating plate at the back of the appliance.

Please help by quoting the product number and production number to prevent unnecessary call-outs. This will save you additional costs.

Aqua-Stop warranty

For appliances with Aqua-Stop only

In addition to warranty claims against the seller based on the contract of sale and in addition to our appliance warranty we shall pay damages under the following conditions:

1. If water damage was caused by a fault in our Aqua-Stop system, we shall compensate private users for damage.
2. The liability warranty applies to the service life of the appliance.
3. A claim can only be made under the warranty if the appliance and Aqua-Stop have been correctly installed and connected according to our instructions; this also includes a correctly installed Aqua-Stop extension (original accessory). Our warranty does not extend to defective supply lines or fittings up to the Aqua-Stop connection on the tap.
4. Appliances which feature Aqua-Stop can be left unattended during operation and it is not necessary to turn off the tap afterwards. The tap should only be turned off if you are away for a prolonged period, e.g. several weeks holiday.

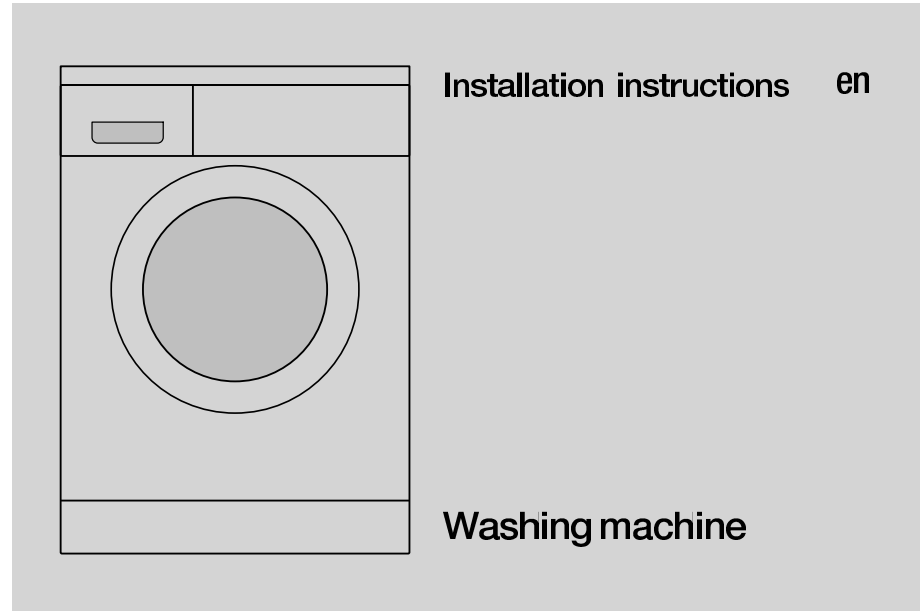

Contents

Page

■ Safety instructions	1
■ Scope of delivery	1
■ Installation area	1
■ Hose and cable lengths	2
■ Built under and built in	2
■ Removing transportation safety devices	3
■ Water connection	4
■ Aligning the appliance	5
■ Electrical connection	5
■ Transportation, e.g. if moving house	6
■ Technical specifications	6
■ Customer service	7
■ Aqua-Stop warranty	7



Read these instructions before switching on the washing machine!
Also follow the separate operating instructions.
Retain all documents for subsequent use or for the next owner.