

## **Making cooking as much fun as eating**

Please read this instruction manual. This will ensure that you make use of all the technical benefits the cooker has to offer.

It will provide you with important safety information. You will then be familiarised with the individual components of your new cooker. And we will show you how to make settings step by step. It is quite simple.

The tables list the settings and shelf positions for numerous well-known dishes. All these dishes are tested in our cooking studio.

In the unlikely event of a fault, look here for information on how to rectify minor faults yourself.

A detailed table of contents will help you to find your way around quickly.

Enjoy your meal!

---

## **Instruction manual**

---

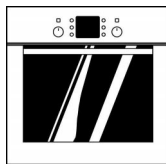

**HBN 7305.0 B**

en

---

**9000 193 840**

# Table of contents

<b>Important information</b> .....	<b>4</b>
Before installation .....	4
Safety information .....	4
Reasons for damage .....	6
<b>Your new cooker</b> .....	<b>7</b>
The control panel .....	7
Function selector .....	8
Temperature selector .....	8
Control buttons and display panel .....	9
Push-in control knobs .....	9
Types of heating .....	10
Oven and shelving accessories .....	12
Cooling fan .....	15
<b>Before using for the first time</b> .....	<b>15</b>
Heating up the oven .....	15
Pre-cleaning the accessories .....	15
<b>Setting the oven</b> .....	<b>16</b>
Setting procedure .....	16
If the oven is to switch off automatically .....	17
If the oven is to switch on and off automatically . . . .	18
<b>Rapid heating</b> .....	<b>19</b>
Setting procedure .....	19
<b>Time</b> .....	<b>20</b>
Setting procedure .....	20
<b>Timer</b> .....	<b>21</b>
Setting procedure .....	21

# Table of contents

<b>Basic settings</b> .....	<b>22</b>
Changing the basic settings .....	23
<b>Childproof lock</b> .....	<b>24</b>
<b>Automatic time limiter</b> .....	<b>24</b>
<b>Automatic self-cleaning</b> .....	<b>25</b>
<b>Care and cleaning</b> .....	<b>28</b>
Oven exterior .....	28
Oven .....	29
Cleaning the glass panels .....	31
Seal .....	32
Accessories .....	32
<b>Troubleshooting</b> .....	<b>33</b>
Replacing the oven light .....	34
<b>After-sales service</b> .....	<b>35</b>
<b>Packaging and old appliances</b> .....	<b>36</b>
<b>Tables and tips</b> .....	<b>36</b>
Cakes and pastries .....	36
Baking tips .....	39
Meat, poultry, fish .....	40
Tips for roasting and grilling .....	42
Frozen foods .....	43
Defrosting .....	44
Drying .....	44
Preserving .....	45
Energy saving tips .....	46
<b>Acrylamide in foodstuffs</b> .....	<b>47</b>
<b>Test dishes</b> .....	<b>48</b>

---

# Important information

Read this instruction manual carefully. Only then will you be able to operate your cooker safely and correctly.

Please keep the instruction and installation manual in a safe place. Please pass on the instruction manual to the new owner if you sell the appliance.

---

## Before installation

### Transport damage

Check the appliance after unpacking it. Do not connect the appliance if it has been damaged in transport.

### Electrical connection

The cooker may only be connected by an approved specialist. Losses resulting from damage caused by incorrect connection will invalidate warranty claims.

---

## Safety information

This appliance is intended only for domestic use. This appliance must only be used for food preparation.

Adults and children must not operate the appliance without supervision

- if they are physically or mentally incapable of doing so
- or if they lack the knowledge and experience required to operate the appliance correctly and safely.

Never let children play with the appliance.

### Children



Children may prepare meals only if they have been properly instructed. They must be able to operate the appliance correctly. They must understand the hazards indicated in the instruction manual. Children must be supervised when using the appliance, to ensure that they do not play with it.

## Hot oven



Open the oven door carefully. Hot steam may escape.

Never touch the internal surfaces of the microwave oven or the heating elements. There is a risk of being burnt.

Children must be kept at a safe distance from the appliance.

Never place combustible items in the oven. There is a risk of fire.

Never trap cables of electrical appliances in the hot oven door. The cable insulation could melt. There is a risk of short-circuiting.

Be careful with food that is prepared with drinks with a high alcohol content (e.g. cognac, rum).

Alcohol evaporates at high temperatures. In unfavourable circumstances, the alcoholic vapours could catch fire in the oven. There is a risk of burning. Only use small quantities of drinks with a high alcohol content and open the oven door carefully.

## Repairs



Incorrect repairs are dangerous. There is a risk of electrocution.

Repairs may only be carried out by one of our experienced after-sales engineers.

If the appliance is faulty, disconnect the fuse in the fuse box.

Call the after-sales service.

## Automatic self-cleaning



Loose food residue, grease and meat juices may ignite during self-cleaning. Risk of fire. Before every self-cleaning operation, remove any coarse dirt from the oven.

Never hang flammable items, such as tea towels, on the door handle. Risk of fire.

The oven exterior will be very hot to the touch during the self-cleaning operation. Keep children at a safe distance.

Never clean metal sheets and dishes which have been coated with a non-stick coating using the oven's automatic self-cleaning function (pyrolysis operation). High temperatures can cause poisonous gases to be formed from the non-stick coating - risk of serious damage to health.

---

## Reasons for damage

### **Baking tray, aluminium foil or dishes on the oven floor**

Do not place the baking tray on the oven floor. Do not cover it with aluminium foil.

Do not place dishes on the oven floor.

This will cause heat accumulation. The baking and roasting times will no longer be correct and the enamel will be damaged.

### **Water in the oven**

Never pour water directly into a hot oven. This could damage the enamel.

### **Fruit juice**

When baking very moist fruit cakes, do not put too much on the baking sheet. Fruit juice dripping from the baking sheet leaves stains that cannot be removed.

It is recommended that you use the deeper universal pan.

### **Cooling with the oven door open**

Only leave the oven to cool with the door closed. Do not allow anything to become trapped in the oven door. Even if you only leave the oven door open slightly, the fronts of adjacent units may become damaged over time.

### **Very dirty oven seal**

If the oven seal is very dirty, the oven door will no longer close properly when the oven is in use. The fronts of adjacent units could be damaged. Keep the oven seal clean.

### **Using the oven door as a seat**

Do not stand or sit on the oven door.

## Transporting the cooker

Do not hold or carry the cooker by the door handle. The door handle cannot hold the weight of the cooker and may break off.

---

# Your new cooker

Here you will learn more about your new oven. The control panel and its switches and indicators are explained here. The heating modes and the accessories included with your oven will be explained here.

---

## The control panel

Details vary according to the appliance model.

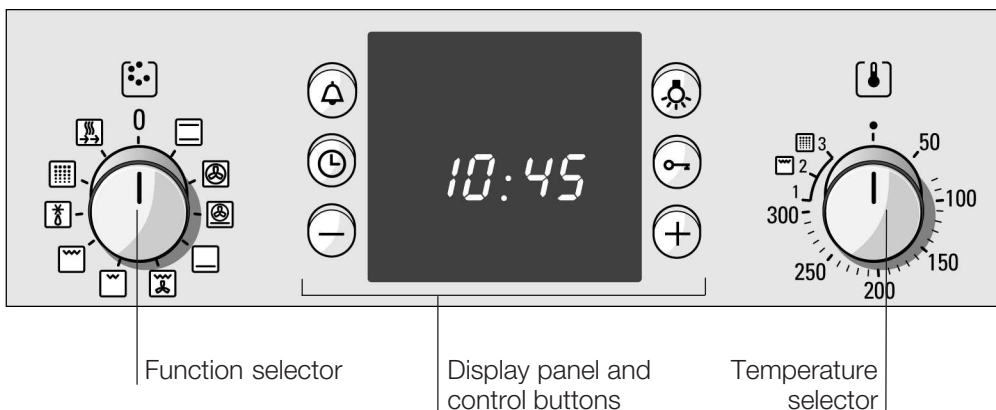

## Function selector

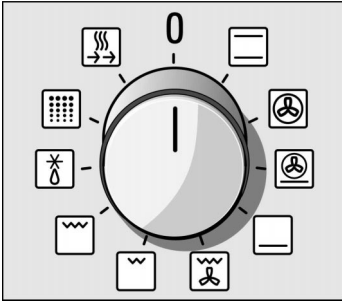

Use the function selector to select the type of heating for the oven.

### Settings

	Conventional heat
	3D hot air*
	Intensive fan-assisted cooking / pizza setting
	Bottom heating
	Hot air grilling
	Radiant grill - small area
	Radiant grill - large area
	Defrosting
	Automatic self-cleaning
	Rapid heating

\*Type of heating with energy efficiency class determined in accordance with EN50304.

When you select a function, the symbol lights up in the display. The oven light switches on.

## Temperature selector

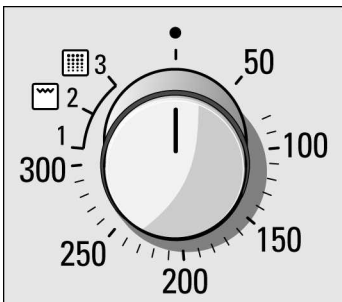

Use the temperature selector to select the temperature, grill setting or cleaning level.

### Temperature

50 - 300	Temperature range in °C
----------	-------------------------

### Grill

1	Low grill
2	Medium grill
3	High grill

### Cleaning



1	Light cleaning
2	Moderate cleaning
3	Intensive cleaning





## Grill settings and cleaning levels

### Note







The temperature symbol in the indicator comes on while the oven is heating up. It goes out when the oven stops heating up. The symbol does not come on when grilling, defrosting or during self-cleaning.

Settings 1, 2 and 3 apply to small area  and large area  radiant grilling and automatic self-cleaning .

The maximum temperature for the 3D hot air  and intensive hot air  setting is 275 °C.

## Control buttons and display panel



Timer button 	Use this button to set the timer.
Clock button 	Use this button to set the time of day, the cooking time  and the completion time  .
Minus button -	Use this button to reduce the values set.
Plus button +	Use this button to increase the values set.
Key button 	Use this button to switch the childproof lock on and off.
Oven light button 	Use this button to switch the oven light on and off.

The values set can be seen in the display panel.

## Push-in control knobs

The control knobs can be pushed in. Simply press the control knob to release or lock it.

You can turn the control knobs to the left or to the right.

## Types of heating

Different types of oven heating are available. You can therefore select the best method for cooking any dish.

### Top and bottom heating

This ensures the even distribution of heat onto the cake or roast from the top and bottom of the oven. This type of heating is best for cake mixtures in tins or for bakes. Top and bottom heating is also suitable for cooking lean roasts of beef, veal and game.

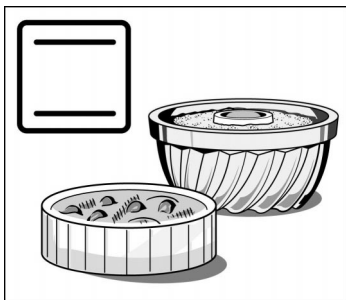

### 3D hot air

A fan in the rear panel distributes the heat from the ring heating element evenly inside the oven. Using 3D hot air, it is possible to bake cakes and pizza on two shelves. You can cook biscuits and puff pastry on three levels at the same time. The required oven temperatures are lower than those for top and bottom heating. Additional baking trays may be obtained from specialist shops.

3D hot air is ideal for drying food.

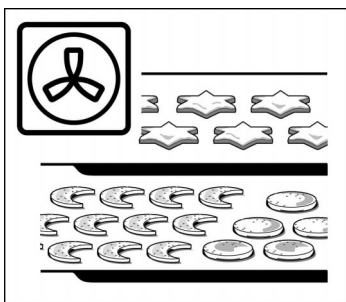

### Intensive hot air / pizza setting

This type of heating uses bottom heating and the ring heating element.

This type of heating is particularly suitable for deep-frozen foods. It is ideal for cooking pizzas, chips or strudels, without requiring preheating.

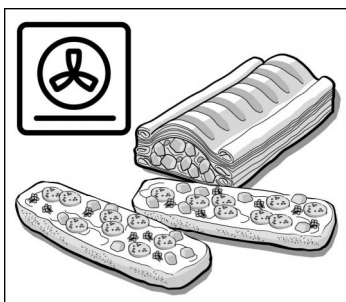

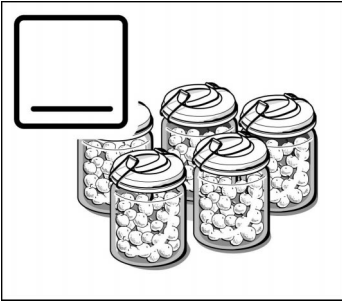

### Bottom heat

You can reheat or brown meals using bottom heating. It is also the most suitable type of heating for preserving food.

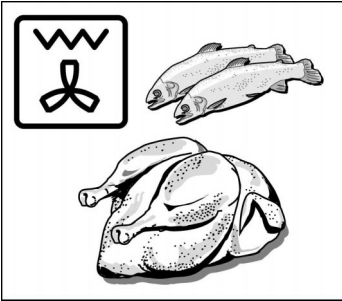

### Hot air grilling

This type of heating involves the grill element and the fan switching on and off alternately. During the pause in heating, the fan circulates the heat generated by the grill around the food. This ensures that pieces of meat are crisped and brown on all sides.

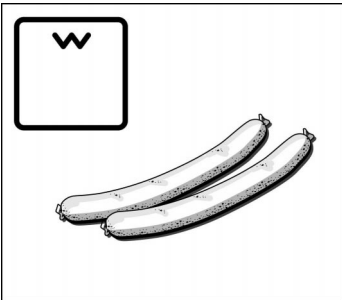

### Radiant grill - small surface

This involves the middle section of the grill element being switched on. This type of heating is ideal for cooking small quantities. This saves energy. Place the pieces to be grilled in the centre of the wire grill.

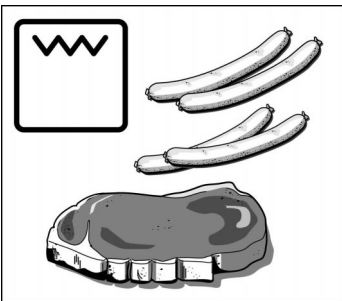

### Radiant grill - large area

The entire area under the grill element becomes hot. This is ideal if you wish to cook several steaks, sausages, fish or slices of toast.

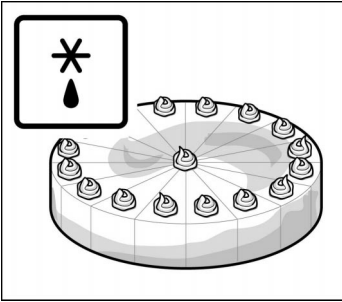

## Defrosting

A fan in the rear wall of the oven circulates the air in the oven around the frozen food. Frozen pieces of meat, poultry, bread and cakes defrost evenly.

### Note

To ensure that the heat is well distributed, the fan switches on for a short time during preheating for types of heating with top and bottom heating.

---

## Oven and shelving accessories

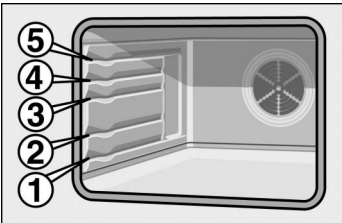

The shelf can be inserted at 5 different heights in the oven.

You can remove the shelf two thirds of the way without it tipping. This makes it easier to take food out of the oven.

### Accessories

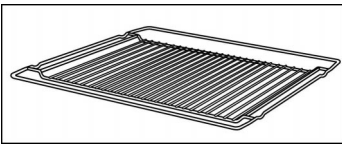

#### HEZ 334001 wire racks

For ovenware, cake tins, roasts, grilling and frozen meals.

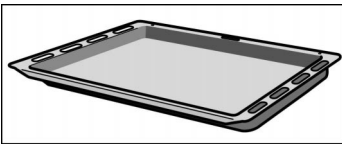

#### Universal pan HEZ 332070

for moist cakes, pastries, frozen food and large roasts. It can also be used to catch dripping fat when you are grilling directly on the wire grill.

Push the universal pan with the sloping edge facing towards the oven door.

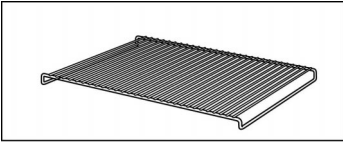

### **HEZ 324000 wire rack**

for grilling. Always place the wire rack in the universal pan. Fat and meat juices are collected.

#### **Optional accessory**

Optional accessories may be purchased from the after-sales service or from specialist shops. The availability of optional accessories varies according to country. Please consult our sales brochures.

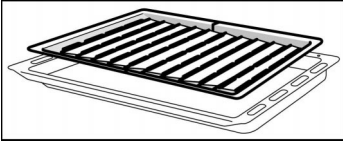

### **Grill pan HEZ 325070**

Can be used for grilling instead of the wire grill or as a spray guard to protect the oven against dirt. Only use the grill pan in the universal pan.

To grill using the grill pan: use the same shelf height as for the wire grill.

Using the grill pan as a spray guard: insert the universal pan with the grill pan under the wire grill.

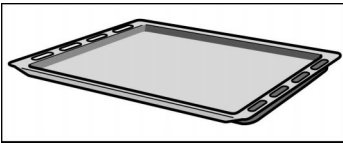

### **Enamelled baking tray HEZ 331070**

for cakes and biscuits.

Push the baking tray with the sloping edge facing towards the oven door.

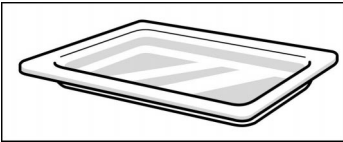

### **Glass pan HEZ 336000**

A deep baking tray made from glass. Can also be used as a serving dish.

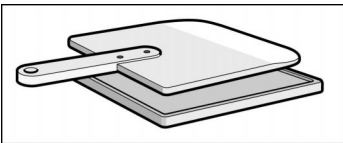

### **HEZ 327000 baking brick**

The baking brick is wonderful for preparing home-made bread, bread rolls and pizzas which need to have a crispy base.

The baking brick must always be preheated to the recommended temperature.

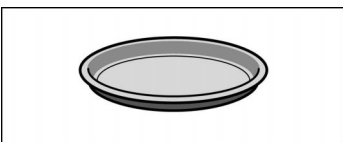

### **Pizza tray HEZ 317000**

Ideal for pizza, frozen foods and large round cakes, for example. You can use the pizza tray instead of the universal pan. Place the tray on the wire grill. Observe the information provided in the tables.

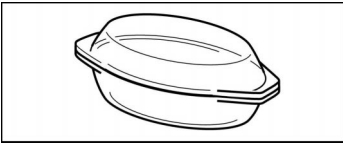

### **Glass roasting dish HMZ21 GB**

for braised dishes and bakes that are cooked in the oven. It is especially suitable for the automatic roasting function.

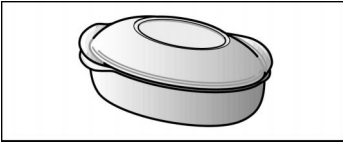

### **Metal roasting dish HEZ 6000**

It is intended for use in the extended cooking zone of the glass ceramic hob. The dish is suitable for the sensor cooking system as well as for the automatic roasting function.

The roasting dish is enamel on the outside and has a non-stick coating on the inside.

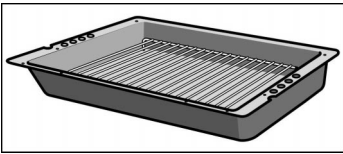

### **Profi extra-deep pan HEZ 333070**

for cooking large quantities of food.

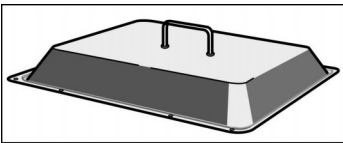

### **Lid for the Profi extra-deep pan HEZ 333001**

Converts the Profi extra-deep pan into the Profi roasting dish.

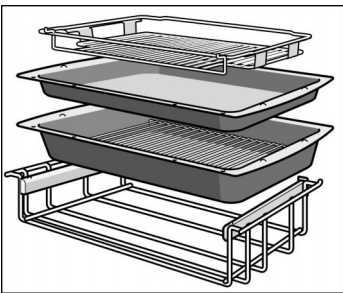

### **Profi oven drawer Plus HEZ 333102**

To be used for preparing large quantities of food. A deep pan, a shallow pan, a wire rack, a wire rack for placing on top and a telescopic shelf come as accessories.

You can grill foods very well using the wire rack placed on top of the drawer.

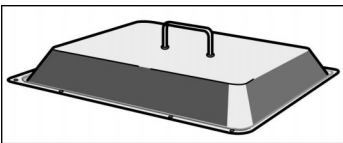

### **Lid for the Profi extension HEZ 333101**

Converts the Profi extra-deep pan into the Profi roasting dish.

---

## Cooling fan

The oven is fitted with a cooling fan. It switches itself on and off as necessary. The warm air escapes above the door.

---

## Before using for the first time



This section will tell you everything you need to do before using the cooker for the first time.

Heat the oven and clean the accessories. Read the safety instructions in the “Important information” section.

Firstly, check to see if the  symbol and three zeros are flashing in the display.

**If the  symbol and three zeros are flashing in the display**

Set the time.

1. Press the  clock button.  
12:00 appears and the  clock symbol flashes.
2. Set the time using the + or – button.

The time selected is adopted after a few seconds. The cooker is now ready for use.

---

## Heating up the oven

### Method

Heat the empty oven with the door closed to remove the new oven smell.

1. Set the function selector to .
2. Use the temperature selector to set the temperature to 240 °C.

Switch off the function selector after 60 minutes.

---

## Pre-cleaning the accessories

Please wash the accessories thoroughly with soapy water and a cleaning cloth before using them.

---

# Setting the oven

## Switching off the oven manually

## The oven switches off automatically

## The oven switches on and off automatically

## Tables and tips

You have various options for setting the oven.

When your meal is ready, switch off the oven yourself.

You can leave the kitchen for a long period.

You can put your meal in the oven in the morning, for example, and set the oven so that your meal is ready at midday.

The correct settings for many dishes can be found in the Tables and tips section.

---

## Setting procedure

Example: Top/bottom heating , 190 °C

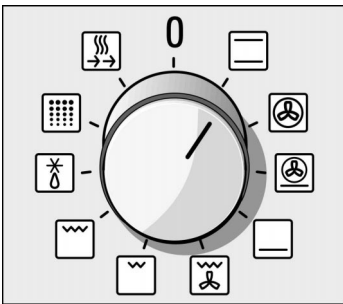

1. Select the desired type of heating using the function selector.

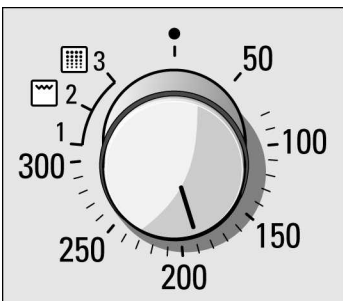

2. Use the temperature selector to set the temperature or grill setting.



## Switching off

Switch off the function selector when the meal is ready.

## Changing the setting

You may change the temperature or grill setting at any time.

---

## If the oven is to switch off automatically

Example: Cooking time of 45 minutes

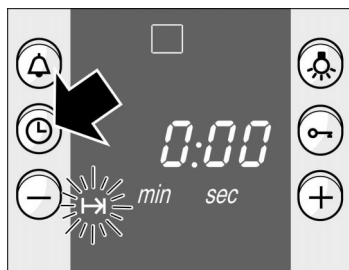

3. Press the ⌚ clock button.  
The cooking time symbol I-| will flash.

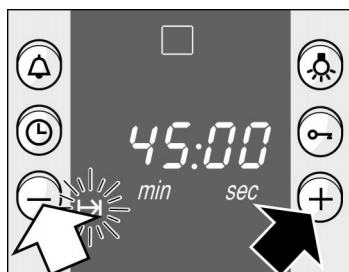

4. Set the cooking time using the + or – button.  
+ button default value = 30 minutes  
– button default value = 10 minutes.

The oven switches on after a few seconds. The I-| symbol lights up in the display.

The cooking time has elapsed

A signal sounds. The oven switches off.  
Switch off the function selector.

## Changing the setting

Press the ⌚ clock button. Change the cooking time using the + or – button.

## Cancelling the setting

Switch off the function selector.

## Calling up the settings

To call up the end time →| or time ⌚: Press the ⌚ clock button until the relevant symbol flashes.

## If the oven is to switch on and off automatically

Example: Imagine - it's 10:45 a.m. The meal will take 45 minutes to cook and must be ready at 12:45 pm.

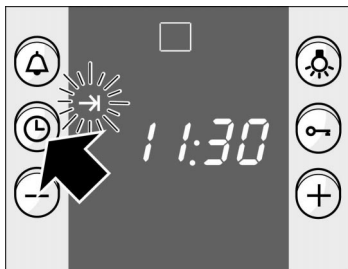

Please remember that easily spoiled foods must not be allowed to remain in the oven for too long.

Perform the settings as described in steps 1 to 4.

5. Press the ⌚ clock button until the →| end symbol flashes.  
In the display you will see the time when the meal will be ready.

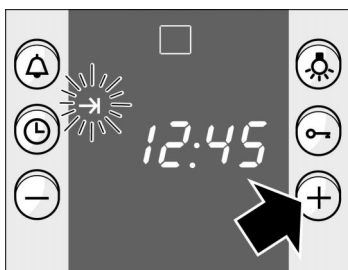

6. Use the + button to set a later end time.

The setting is adopted after a few seconds. The display will show the end time until the oven switches on.

**The cooking time has elapsed**

### Note

A signal sounds. The oven switches off. Switch off the function selector.

You can change the setting while the symbol is flashing. The setting has been adopted if the symbol lights up permanently. You may change the waiting time that elapses before the setting is adopted. See the Basic settings section for more details.

---

# Rapid heating

This allows you to heat up the oven particularly quickly.

---

## Setting procedure

1. Switch the function selector to rapid heating .
2. Use the temperature selector to set the required temperature.

The oven switches on after a few seconds. The  symbol lights up in the display.

**The rapid heating process is complete**

You will hear a short signal. The  symbol will go out. Put your meal in the oven and set the oven.

# Time

When the oven is first connected, or following a power cut, the ⌚ symbol and three zeros flash in the display. Set the time.

The function selector must be switched off.

## Setting procedure

Example: 13:00

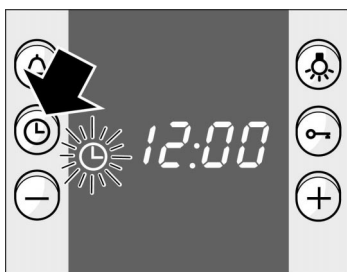

1. Press the ⌚ clock button.  
12.00 appears in the display and the ⌚ symbol flashes.

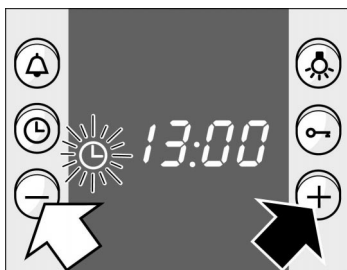

2. Set the time using the + or - button.

The time selected is adopted after a few seconds.

**Changing the time e.g. from summer to winter time**

Press the ⌚ clock button and change the time using the + and - buttons.

**Hiding the time**

You can hide the time. It will then only be visible when you are performing settings.

To do this, you must change the basic setting. See the Basic settings section.

# Timer

You can use the timer as a kitchen timer. It operates independently of the oven.



The timer has a special signal.

You can also set the timer if the childproof lock is active.

## Setting procedure

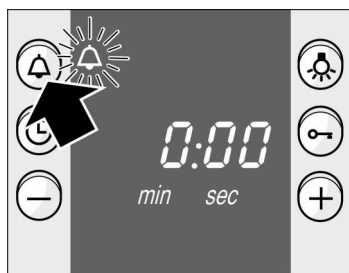
Example: 20 minutes



1. Press the  timer button.  
The  symbol will flash.

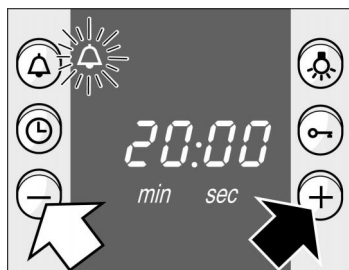

2. Set the timer period using the + or - button.  
+ button default value = 10 minutes  
- button default value = 5 minutes

The timer starts after a few seconds. The  symbol lights up in the display. The time counts down visibly.

### The time has elapsed

A signal sounds. Press the  timer button. The timer display will go out.

### Changing the timer period

Press the  timer button. Change the time using the + or - button.

### Cancelling the setting

Press the  timer button 3x.

## The timer and cooking time count down simultaneously

The symbols light up. The timer period counts down visibly in the display.

To call up the remaining cooking time **I→I**, end time **→I** or time **⌚**: Press the **⌚** clock button until the appropriate symbol flashes.

The value called up will then appear in the display for a few seconds.

---

## Basic settings

Your oven has several basic settings. You may change the basic settings for the time, the signal duration and the reset time for a setting.

Basic setting	Function	Change to
Time <b>⌚</b> <i>!</i> = Time in the foreground	Time display	Time <b>⌚</b> = Time hidden
Signal duration <b>⚠</b> <i>!</i> = approx. 10 seconds	Signal after cooking time or timer period has elapsed.	Signal duration <b>⌚</b> = approx. 1 min. <b>⌚</b> = approx. 4 mins.
Reset time <b>I→I</b> <b>⌚</b> = medium	Waiting time between the adjustment increments before the setting is adopted.	Reset time <i>!</i> = short <b>⌚</b> = long

## Changing the basic settings

Example: Hiding the time

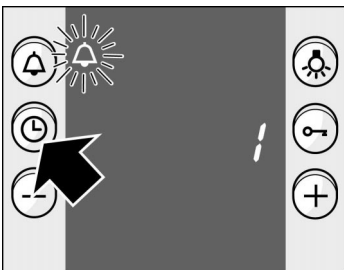
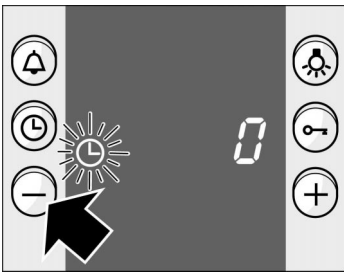
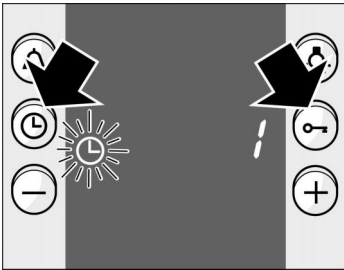

There must be no program set.

1. Press the ⌚ clock button and the 🔑 button simultaneously until a 1 appears in the display. The basic setting for the time is shown in the foreground.
2. Change the basic setting using the + or – button.
3. Confirm with the ⌚ clock button. A 1 will appear in the display for the basic setting for the signal duration.

Change the basic setting as described in step 2 and confirm with the ⌚ clock button. You can now change the reset time. To finish press the ⌚ clock button.

If you do not wish to change a basic setting, press the ⌚ clock button. The next basic setting will appear.

You may change your settings again at any time.

**You do not wish to change all the basic settings**

**Correcting settings**



---

# Childproof lock

The oven has a childproof lock to prevent children switching it on accidentally.

## Locking the oven

The function selector must be switched off.

Press the  key button until the  symbol appears in the display. This will take approximately 4 seconds.

## Unlocking

Press the  key button until the  symbol goes out.

## Notes

You can set the timer and the clock even when the oven is locked.

---

# Automatic time limiter

If you have forgotten to switch off the oven, the automatic time limiter will be activated. Oven operation will be interrupted. The time when this happens depends on the selected temperature or grill setting.

A **5** appears in the clock display when the oven is no longer heating up.

The heating function is interrupted until you switch off the function selector. The **5** will go out.

You can now reset the oven.

## Cancelling the automatic time limiter

If you enter a cooking time, the oven will then switch off automatically.

The time limiter is cancelled.



# Automatic self-cleaning

The oven is heated to approximately 500 °C. Any food residues from roasting, grilling and baking are burnt to ash.

You may choose from three cleaning levels.

Level	Degree of cleaning	Duration
1	Low	approx. 1¼ hours
2	Medium	approx. 1½ hours
3	Intensive	approx. 2 hours

## What you should know

For safety reasons, the oven locks automatically when it reaches approx. 250 °C. You will only be able to open the door again once the temperature has fallen below 300 °C.



The exterior of the oven will become very hot. Make sure that nothing is placed against the front panel. Keep children at a safe distance.

Never attempt to open the oven during the self-cleaning process. The cleaning process may be interrupted.

Please do not attempt to push in the latch by hand.

You cannot switch the oven light on during self-cleaning.

## Before self-cleaning

Remove unsuitable accessories and all ovenware from the oven.



Risk of fire. Loose food residue, grease and meat juices are flammable.

Wipe the oven and the accessories that are to be cleaned at the same time with a damp cloth.

Clean the oven door and along the edges of the oven around the seal. Do not scour the seal.

Make sure that the oven door is closed before you start cleaning.

## Cleaning accessories at the same time



Insert the universal pan at shelf position 2 for self-cleaning.

The wire grill is not suitable for self-cleaning.

Never clean metal sheets and dishes which have been coated with a non-stick coating using the oven's automatic self-cleaning function (pyrolysis operation). High temperatures can cause poisonous gases to be formed from the non-stick coating - risk of serious damage to health.

## Setting procedure

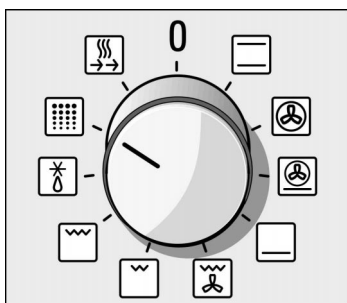

Example: Cleaning level 3

1. Set the function selector to .

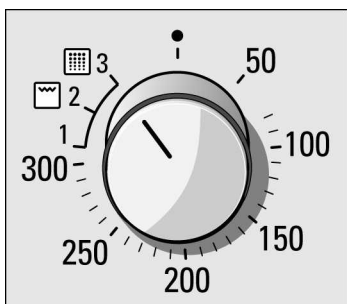

2. Use the temperature selector to set cleaning level 3.

Self-cleaning starts after a few seconds.

The cleaning time has finished

A signal sounds and the cooking time symbol  flashes.

Only switch off the function selector once the oven door can be opened.

Calling up the remaining time and end time

To call up the remaining time  or end time : Press the clock button  repeatedly until the appropriate symbol appears.

## Switching self-cleaning on and off automatically.

Example: You want automatic self-cleaning to be finished at 23:00.

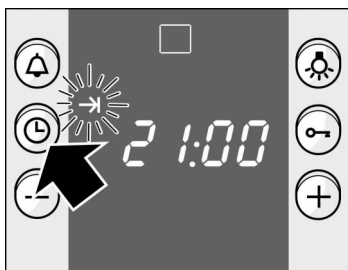

This enables you to make use of the cheaper off-peak electricity tariffs, for example.

Make settings as described in points 1 and 2.

3. Press the ⌚ clock button and hold it until the → end symbol in the display flashes.

The display indicates when automatic self-cleaning will be finished.

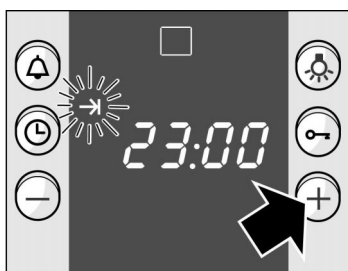

4. Use the + button to set a later end time.

The self-cleaning function switches on and off at the appropriate times.

The clock reappears once self-cleaning has started.

**The cleaning time has elapsed**

A signal sounds and the I→ cooking time symbol flashes.

Do not switch off the function selector until the oven door can be opened.

**Cancelling the setting**

Switch off the function selector.

**Note**

The cleaning level can no longer be changed once cleaning has started.

---

## When the oven has cooled

Wipe away any remaining ash from inside the oven using a moist cloth.

### Note

Under normal use, it is usually sufficient to clean the oven every two to three months. You only require about 2.5 - 4.7 kilowatt hours for each self-cleaning process.

The special heat-resistant enamel and the shiny parts in the oven may become dull or discoloured over time. This is normal and does not affect the function. Do not use coarse scouring pads or strong cleaning agents to remove such discolorations.

---

## Care and cleaning

Do not use high-pressure cleaners or steam jets.

---

### Oven exterior

Wipe the oven with water and a little washing-up liquid. Dry it with a soft cloth.

Caustic or abrasive substances are not suitable. If any such substances come into contact with the frontage, wipe it off immediately with water.

### Note

Slight differences in the colours on the appliance front are caused by the use of different materials, such as glass, plastic and metal.

Shadows on the door panel which resemble smears are reflections from the oven light.

### Appliances with stainless steel fronts

Always remove any flecks of limescale, grease, cornflour and egg white immediately. Corrosion can form under such flecks.

Use stainless steel care products. Follow the manufacturer's instructions. Try out the product on a small area first, before using on the whole surface.

## Appliances with aluminium fronts

Use a mild window-cleaning detergent. Wipe the area with a soft window cloth or a fluff-free micro-fibre cloth, using a horizontal action without applying pressure.

Aggressive cleaning products, scratchy sponges and rough cleaning cloths are not suitable.

---

## Oven

Never use coarse scouring pads or cleaning sponges. Oven cleaner may only be used on enamelled oven surfaces.

### For ease of cleaning

you can switch on the oven light with the  button and unhinge the oven door.

### Detaching the oven door



Make sure that you do not reach into the hinge. There is a risk of injury.

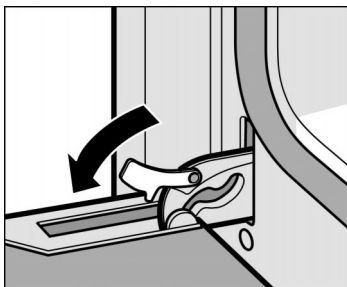

1. Open the oven door fully.
2. Move the two locking levers on the left and right-hand sides.

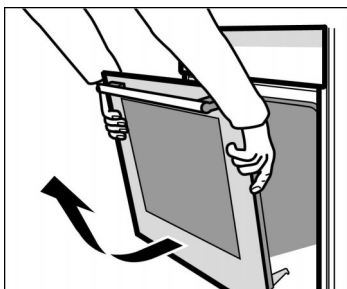

3. Half-close the oven door.  
With both hands, grip the door on the left and right-hand sides.  
Close the door a little more and pull it out.

After cleaning, refit the oven door in the reverse order to removal.

## Cleaning the enamelled surfaces of the oven

Use hot soapy water or a vinegar solution.

It is best to use oven cleaner if the oven is very dirty. Only use oven cleaner in a cold oven.

Note:

Enamel is baked on at very high temperatures. This can cause some slight colour variation. This is normal and does not affect the function. Do not use coarse scouring pads or strong cleaning agents to remove such discolorations.

The edges of thin trays cannot be completely enamelled. As a result, these edges can be rough. Anti-corrosion protection is guaranteed.

## Cleaning the glass cover for the oven light

It is best to clean the glass cover with washing-up liquid.

## Cleaning the oven door cover

The oven door cover can become discoloured. You must remove the cover in order to clean it.

Proceed as follows:

1. Open the oven door fully.
2. Unscrew the cover at the top of the oven door.  
To do this, undo the right and left-hand screws.

3. Remove the cover–

Make sure that the oven door is not closed while the cover is removed. The inner glass may be damaged.

Clean the cover with a stainless steel cleaning agent.

4. Replace the cover and fasten it.
5. Close the oven door.

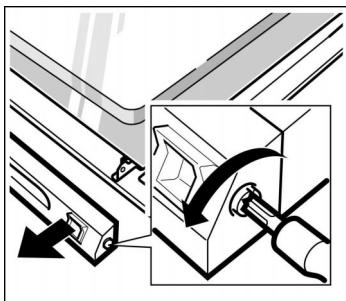

## Cleaning the glass panels

### Removal

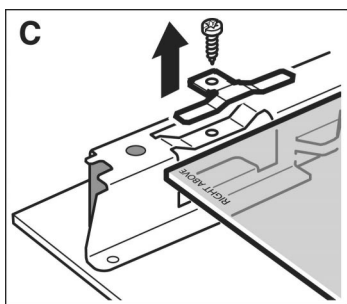
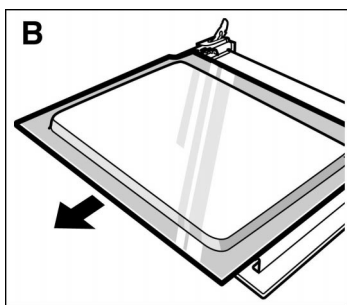
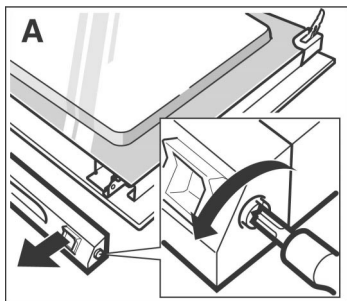

The glass panel on the oven door can be removed to assist in cleaning.

1. Remove the oven door and lay it down on a cloth with the handle facing downwards.
2. Unscrew the cover at the top of the oven door. Turn the screws clockwise or anti-clockwise to do this. (Fig. A)
3. Raise the upper panel and remove it. (Fig. B)
4. Unscrew the clips on the left and right and remove them. (Fig. C) Remove the panel.
5. The seal at the bottom of the panel can be removed for cleaning. To do this, unhook the seal on the left and right.

Clean the glass panels with glass cleaner and a soft cloth.

## Installation

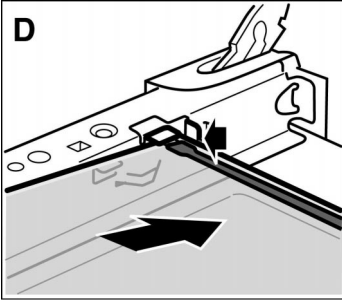

Ensure that the label “right above” is upside down at the bottom left of both panels.

1. Slide in the glass panel backwards at an angle. (Fig. D)
2. Replace the seal again at the bottom of the panel. (Fig. D)

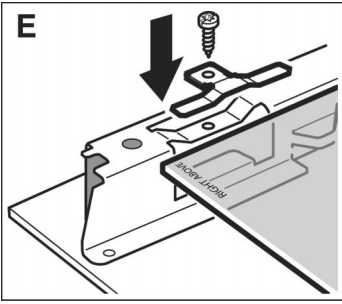

3. Fit the clips and screw them in again. (Fig. E)
4. Slide in the top panel backwards at an angle.
5. Replace the cover and screw it back on.
6. Refit the oven door.

**The oven must not be used again until the panels have been correctly installed.**

---

## Seal

Clean the seal on the oven with washing-up liquid. Never use caustic or abrasive detergents.

---

## Accessories

Immediately after use, soak the accessories in washing-up liquid. Food residues can then be easily removed with a brush or sponge.

The universal pan can be cleaned at the same time as the automatic self-cleaning.



# Troubleshooting

Should a malfunction occur, it is often only due to a minor fault. Please read the following instructions before calling the after-sales service:

<b>Problem</b>	<b>Possible cause</b>	<b>Comments/remedy</b>
The oven does not work.	Blown fuse.	Look in the fuse box and check that the fuse is in working order.
The clock display flashes.	Power cut.	Reset the time.
The oven door cannot be opened. The function selector is in the  position and three zeros are flashing in the display.	Power cut.	Switch off the function selector. Set the time of day and restart self-cleaning. If you no longer wish to repeat automatic self-cleaning, you must still wait for the oven temperature to fall below 300 °C.
The oven does not heat up or the type of heating selected cannot be set.	Dust on the contacts.	Turn the function selectors round completely several times.
The oven does not heat up. A square appears in the temperature display.	The appliance is currently in demo mode.	Switch off the fuse in the fuse box. Wait for approximately 20 seconds. Switch on the fuse again. Within the next 2 minutes, press the rapid heating up button for 6 seconds until the square in the display disappears.
A “5” appears in the clock display.	The automatic time limiter was activated.	Switch off the function selector.
The “Er 1” or “Er 4” error message appears in the clock display.	The temperature sensor has failed.	Contact the after-sales service.
The “Er 2” error message appears in the clock display.	Incorrect mains connection.	Switch off the fuses in the fuse box and connect the cooker properly.
The “Er 6” error message appears in the clock display. You have set self-cleaning.	The lock on the oven door is defective.	Switch off the function selector and call the after-sales service. All other oven functions can be used.

Problem	Possible cause	Comments/remedy
The oven door cannot be opened. The “Er 7” error message appears in the clock display.	The oven door release mechanism is faulty.	Contact the after-sales service.
The “Er 11” error message appears in the clock display.	A button has been pressed for too long or a button has jammed.	Press all buttons separately. If the error message remains, please contact the after-sales service.

**Repairs may only be carried out by fully trained after-sales service technicians.**

Improper repairs may constitute serious hazards to the user.

## Replacing the oven light

If the oven light fails, it must be replaced. 40 watt heat-resistant spare bulbs can be obtained from the after-sales service or specialist shops. Only use these bulbs.

### Method

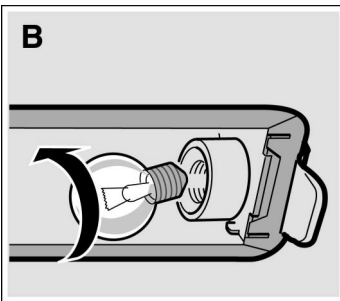
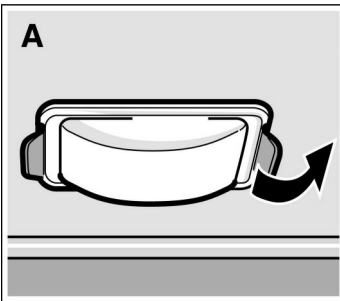

1. Switch off the oven fuse in the fuse box.
2. Place a tea towel in the cold oven to prevent damage.
3. Remove the glass cover. To do this, press back the metal tab with your thumb. Figure A.
4. Unscrew the bulb and replace it with one of the same type. Figure B.
5. Fit the glass cover back on. To do this, insert it on one side and press firmly on the other side. The glass cover will now click into place.
6. Remove the tea towel and switch the fuse back on.

## Replacing the glass cover

The glass cover on the oven light must be replaced if it is damaged. Replacement glass covers may be obtained from the after-sales service. To this end, please specify the E number and FD number of your appliance.

---

# After-sales service

Our after-sales service is there for you if your oven needs repairing. You will find the address and telephone number of your nearest after-sales service centre in the phone book. The after-sales service centres listed will also be happy to advise you of a service point in your local area.

## E number and FD number

Please quote the E number (product number) and the FD number (production number) of your appliance when contacting the after-sales service. The rating plate containing these numbers is found on the right, on the side of the oven door. You can make a note of these numbers in the space below to save time in the event of your appliance malfunctioning.

E no.	FD no.
-------	--------

After-sales service 
---

---

# Packaging and old appliances

## Disposing in an environmentally-responsible manner

Unpack the appliance and dispose of the packaging in an environmentally-responsible manner.



This appliance is labelled in accordance with the European Directive 2002/96/EC concerning used electrical and electronic appliances (waste electrical and electronic equipment – WEEE).

The guideline determines the framework for the return and recycling of used appliances as applicable.

---

# Tables and tips

This table contains a selection of dishes and the optimum settings at which to cook them. You can find out which type of heating and temperature is best for your dish, which accessories to use, and at which oven level the dish should be inserted. You will find a variety of tips about ovenware and preparation, and a small troubleshooting section in case anything should go wrong.

---

## Cakes and pastries

### Baking on one level

If you are baking cakes on one level, you should use top/bottom heating . This will give the best results for your cakes.

### Baking tins

It is best to use dark-coloured baking tins made of metal. Baking times are increased when light-coloured baking tins made of thin metal or glass dishes are used, and cakes do not brown so evenly.

Place the cake tin on the wire rack.

## Tables











The values in the table apply to dishes placed in a cold oven. This saves energy. Shorten the baking times indicated by 5 to 10 minutes if you have preheated the oven.

The tables show which type of heating is best for different cakes and bakes.

The temperature and cooking time you select depends on the quantity and type of pastry. This is why “ranges” are given in the tables. You should try to use a lower temperature setting to start with, since this allows more even browning. If necessary, use a higher temperature setting the next time.

More information can be found in the “Baking tips” section which follows the tables.





### Conventional heat

Food	Dish	Shelf position	Cooking method	Temp. °C	Time, minutes
Victoria sandwich	20 cm tin	2		180	20-30
Light fruit cake	20 cm tin	2		180	70-80
Fruit crumble	Glass dish	3		180	35-45
Jam tarts*	12 hole bun tin	2		200	15-20
Yeast cookery* (f.ex. Pizza)	universal pan	2		230	20-30
Tarts**	20 cm plate or pie tin	1		200	40-50
Quiches**	Glass dish	1		210	40-50
Swiss Roll*	Swiss roll tin	2		200	10-12
Rich Biscuits	baking tray	3		180	15-20
Soufflés*	1,2 l soufflé dish	2		180	40-50
Pies**	Pie dish	2		200	45-55

\* Preheat oven



\*\* For a crispy bottom always place dish on the universal pan

### 3D-Hot air

Food	Dish	Shelf position	Cooking method	Temp. °C	Time, minutes
Rich fruit cake	23 cm round tin or 20 cm square cake tin	2		140	180-190
Meringues	universal pan	3		80	100-150
Pavlova*	universal pan	3		150 100	90-100
Jacket Potatoes	universal pan	2		170	60-70









\* Preheat oven.

### Conventional baking

Food	Dish	Shelf position	Cooking method	Temp. °C	Time, minutes
Bread	loaf tin (900 g or 2x 450 g)	1		240	25-35
Scones*	baking tray	1		210	15-20
Yorkshire Pudding*	12 hole bun tin	1		200	25-35

\* Preheat oven.

### 3D-Hot air: Baking on 2 or 3 levels

Food	Dish	Shelf position	Cooking method	Temp. °C	Time, minutes
Victoria sandwich	20 cm tin	1+3		160	35-40
Scones*	baking trays	1+3		180	20-30
Jacket potatoes	wire rack	1+3		160	60-90
Biscuits	baking trays**	1+3		160	20-25
		2+3+5		150	25-30
Small Cakes*	baking trays**	1+3		150	25-35
Meringues	baking trays**	1+3		80	100-150
		2+3+5		80	100-150

Food	Dish	Shelf position	Cooking method	Temp. °C	Time, minutes
Full meal	universal pan + wire rack	1+4		180	75-85

\* Preheat oven

\*\* When baking on two levels, use the universal pan provided, at shelf position three. When baking on three levels, use the universal pan at shelf position two. The universal pan can be removed earlier.

## Baking tips

**You wish to cook to your own recipe.**

Refer to the instructions in the tables for similar types of food.

**How to check that a sponge cake is cooked properly.**

Approximately 10 minutes before the end of the baking time given in the recipe, pierce the tallest point of the cake with a cocktail stick. The cake is done if the cocktail stick comes out clean.

**The cake collapses.**

Next time, use less liquid or decrease the oven temperature by 10 degrees. Observe the cooking times in the recipe.

**The cake has risen in the centre but is lower at the edges.**

Do not grease the sides of the springform cake tin. As soon as the cake is done, carefully loosen the cake around the edges using a knife.

**The cake is too dark at the top.**

Insert it at a lower level in the oven, select a lower temperature and cook the cake a little while longer.

**The cake is too dry.**

Use a toothpick to make small holes in the finished cake. Then drizzle fruit juice or alcohol over the top. Next time you should decrease the temperature by around 10 degrees and reduce the baking times.

**The bread or cake (e.g. cheesecake) looks fine, but is soggy on the inside (soft, with watery areas).**

Next time you should add a little less liquid and cook for a little longer at a lower temperature. Cakes with fruit topping: Precook the base first of all. Sprinkle with almonds or breadcrumbs and then place the topping over this. Please observe the recipe and the baking times.

---

**The pastry is unevenly browned.**

Select a slightly lower temperature to ensure that the pastry is baked more evenly. Delicate pastry should be baked on one level using top/bottom heating . Baking paper that protrudes over the food can affect the air circulation. For this reason, always cut the baking paper to fit the baking tray.

---

**The fruit cake is too light at the bottom. The fruit juice flows over.**

Use the deeper universal pan next time.

---

**You were baking on several levels. The food on the top baking tray is darker than that on the bottom baking tray.**

Always use 3D hot air  when baking on several levels. Baking trays that are placed in the oven at the same time will not necessarily be ready at the same time.

---

**Condensation is formed when baking cakes containing fresh fruit.**

Baking may result in the formation of water vapour. It escapes above the door handle. The steam may settle and form water droplets on the control panel or on the fronts of adjacent units. This is a normal physical process.

---

---

## Meat, poultry, fish

### Ovenware

You may use any heat-resistant dishes. The universal pan is also suitable for larger roasts.

Always place the dishes in the centre of the wire grill.

Hot glass dishes should be placed on a dry kitchen towel after being removed from the oven. The glass could crack if placed on a cold or wet surface.

### Advice on roasting

The roasting result depends on the type and quality of meat.

Add 2 to 3 soup spoons of liquid to lean meat, and 8 to 10 soup spoons of liquid to pot roasts, depending on the size.

Meat should be turned half way through the cooking time.

When the roast is ready, switch off the oven and leave the roast to stand for 10 minutes with the oven door closed. This allows the meat juices to distribute more favourably.



## Advice on grilling

Always close the oven door when grilling.

If possible, use pieces of meat which are of the same thickness. They should be at least 2 to 3 cm thick. Such pieces will be browned evenly and stay juicy and soft in the middle. Only salt the steaks after they have been grilled.

Place the pieces of meat directly onto the wire grill. If you are grilling just one piece of meat, it will turn out best if you place it in the centre of the wire grill. You should also insert the universal pan at level 1. The meat juices are collected here and the oven is kept clean.











Turn the pieces of meat after two thirds of the cooking time indicated.

The grill element automatically switches itself off and back on again. This is normal. The number of times this happens depends on the grill setting you have selected.





## Tables

The table applies to insertion into a cold oven. The time specifications are provided as guidelines only and depend on the type and quality of the meat.

## Roasting

Food	Shelf position	Cooking method	Temp. °C	Cooking time min per 1 lb.
Beef rare	1		220-240	15+15
Beef medium	1		210-230	15+20
Beef well done	1		200-220	20+25
Beef fillet	1		210-230	15+20
Lamb medium	1		170-190	25+25
Lamb well done	1		150-170	30+30
Pork	1		180-200	30+30
Chicken, Duck, Goose and Turkey up to 5 kilo	1		160-200	20+20
Large Turkey	1		170-190	13+13
Chops and chicken joints	2		190-220	30

## Grilling

Food	Shelf position	Cooking method	Grill	Cooking time min per 1 lb.
Meat steaks, bacon	5		2 or 3	12-22
Sausages and Fish fingers	4		3	15-20
Fish	4		2	10-20
Toast, 4 pieces	4		3	6-7
9	4		3	4-5

## Tips for roasting and grilling

**The table does not contain information for the weight of the roast.**

Select the next lowest weight from the instructions and extend the time.

**How can you tell when the roast is ready?**

Use a meat thermometer (available from specialist shops) or carry out a "spoon test". Press down on the roast with a spoon. If it feels firm, it is ready. If the spoon can be pressed in, it needs to be cooked for a little longer.

**The roast is too dark and the crackling is partly burnt.**

Check the shelf position and temperature.

**The roast looks good, but the juices are burnt.**

Next time, use a smaller roasting dish or add more liquid.

**The roast looks good, but the juices are too clear and watery.**

Next time, use a larger roasting dish or add less liquid.















**Steam rises from the roast when the juice is basted.**

Use hot air grilling instead of top/bottom heating. This prevents the bottom of the roast from becoming too hot, thereby producing less steam.

## Frozen foods

Please observe the instructions on the packaging.

The values in the table apply to dishes placed in a cold oven.

Meal	Use for	Level	Type of heating	Temperature in °C	Cooking time in minutes
Pizza*	Pizza with a thin base	2		190-210	15-25
	Pizza with a thick base	2		180-200	20-30
	Pizza baguette	2		180-200	20-30
	Mini pizza	3		190-210	10-20
Potato products*	Chips	2		200-220	20-30
	Croquettes	2		200-220	20-30
	Duchess potatoes	2		200-220	20-30
	Fried potatoes	2		200-220	15-25
	Filled potato skins	2		200-220	15-25
Baked goods*	Rolls	3		180-200	10-20
	Pretzels	3		190-210	10-20
Fried foods*	Fish fingers	2		200-220	10-20
	Chicken nuggets	2		200-220	15-25
	Vegetable burgers	2		200-220	20-30
Strudel*	Apple strudel	3		190-210	30-40



\* Line the accessories with greaseproof paper. Please ensure that the greaseproof paper is suitable for use at these temperatures.

## Defrosting

Remove the food from its packaging and place it in a suitable dish on the wire grill.

Please observe the instructions on the packaging.

The defrosting times depend on the type and amount of food.

Meal	Accessories	Level	Type of heating	Temperature in °C
<b>Delicate frozen foods</b> e.g. cream gateaux, cream cakes, cakes with chocolate or icing, fruit etc.	Wire rack	2		The temperature selector remains switched off
<b>Other frozen foods*</b> Chicken, sausage and meat, bread, bread rolls and other pastries	Wire rack	2		50 °C





\* Cover frozen food with microwave foil. Place poultry onto the plate with the breast side down.

## Drying

Only use perfectly fresh fruit and vegetables, and wash them thoroughly.

Allow the food to drain well and dry it yourself.

Line the universal pan and wire rack with baking paper or greaseproof paper.

Meal	Level	Type of heating	Temperature in °C	Cooking time in hours
600 g apple rings	2 + 4		80	Approx. 5
800 g sliced pears	2 + 4		80	Approx. 8
1.5 kg prunes or plums	2 + 4		80	Approx. 8 - 10
200 g fresh herbs, washed	2 + 4		80	Approx. 1½

### Note

Very moist fruit or vegetables should be turned several times. Once dried, remove the food from the paper immediately.

---

# Preserving

## Preparation

The jars and rubber sealing rings must be clean and intact. Use jars of the same size if possible. The instructions in the table refer to round 1-litre jars.

**Caution** Do not use larger or taller jars. The lid could crack.

Only use perfectly fresh fruit and vegetables. Wash them thoroughly.

Pour the fruit or vegetables into the jars. Wipe clean the tops of the jars again if necessary. They must be clean. Place a wet rubber sealing ring and lid on each jar and lock the jars using clamps.

Do not place more than six jars in the oven.

The times specified in the tables are guidelines only. They can be influenced by the room temperature, the number of jars and the amount and temperature of the jar contents. Before you change settings or switch off the appliance, make sure that the contents of the jars are actually bubbling.

## Setting procedure

1. Place the universal pan on level 2. Place the jars inside the pan so that they do not come into contact with each other.
2. Pour ½ litre of hot water (approx. 80 °C) into the universal pan.
3. Close the oven door.
4. Switch the function selector to .
5. Set the temperature selector to 170 to 180 °C.

## Preserving fruit

As soon as the contents of the jars begins to simmer, that is when small bubbles appear at short intervals - after about 40 to 50 minutes - turn off the temperature selector. The function selector remains switched on.

The jars should be removed from the oven after being reheated for 25 to 35 minutes. If the food is left to cool in the oven for longer, bacteria might form, causing the preserved fruit to spoil prematurely. Switch off the function selector.

<b>Fruit in 1-litre jars</b>	<b>After bubbling</b>	<b>Reheating</b>
Apples, red/blackcurrants, strawberries	turn off	approx. 25 minutes
Cherries, apricots, peaches, gooseberries	turn off	approx. 30 minutes
Apple purée, pears, plums	turn off	approx. 35 minutes

### **Preserving vegetables**

As soon as the contents of the jars begins to simmer, set the temperature selector back to approximately 120 to 140 °C. The table shows when you can switch off the temperature selector. Allow the vegetables to stand in the oven for a further 30 to 35 minutes. The function selector remains switched on during this time.

<b>Vegetables with cold stock in 1-litre jars</b>	<b>After bubbling 120 - 140 °C</b>	<b>Reheating</b>
Cucumbers	–	approx. 35 minutes
Beetroot	approx. 35 minutes	approx. 30 minutes
Brussel sprouts	approx. 45 minutes	approx. 30 minutes
Beans, kohlrabi, red cabbage	approx. 60 minutes	approx. 30 minutes
Peas	approx. 70 minutes	approx. 30 minutes

### **Remove the jars**

Never place the hot jars on a cold or wet surface as this could cause the glass to crack.

## **Energy saving tips**

Only preheat the oven if it specifies in the recipe or in the table in the instruction manual that you should do so.

Use non-stick, black painted or enamelled tins. They absorb the heat especially well.

If you have several cakes to bake it is best to bake them one after the other. The oven is still warm. This shortens the baking time for the second cake. You can also put two baking tins in one after the other.

For long cooking times, the oven can be switched off 10 minutes before the end of the cooking time and the remaining heat can be used to finish the cooking.

---

# Acrylamide in foodstuffs

**Which foods are affected?** Acrylamide is mainly produced in grain and potato products heated at high temperatures, such as potato crisps, chips, toast, rolls, bread, baked goods (biscuits, gingerbread, cookies).

---

## Tips for keeping acrylamide to a minimum when preparing food

---

### General

Keep cooking times to a minimum.  
Cook meals until they are golden brown, not too dark.  
Large, thick pieces of food contain less acrylamide.

### Baking

With top/bottom heating, maximum 200 °C, with 3D hot air or hot air, maximum 180 °C.

### Biscuits

With top/bottom heating, maximum 190 °C, with 3D hot air or hot air, maximum 170 °C.  
Egg white and egg yolk reduce the formation of acrylamide.

### Oven chips







Spread out a single layer evenly on the baking tray. Bake at least 400 g per baking tray so that the chips do not dry out.

---

# Test dishes



referring to EN 60350.

## Baking

Food	Dish and notes	Shelf position	Cooking method	Temp. °C	Cooking time min
Small Cakes	baking tray	2		170-190	20-30
Small Cakes (preheat oven)	baking tray	3		140-160	20-30
	baking tray + universal pan*	1+3		140-160	25-35
Fatless sponge cake	baking tin (dark coated)	2		160-180	30-40
Apple pie	2 wire racks + 2 tinplate springform cake tins Ø 20 cm	2+4, placed diagonally		190-210	70-80
	universal pan + 2 tinplate springform cake tins Ø 20 cm	1 in the centre alongside one another		200-220	70-80

\* When baking on two levels, use the universal pan provided, at shelf position three.

## Grilling

Food	Dish and notes	Shelf position	Cooking method	Grill setting	Cooking time min
White bread (preheat oven 10 min)	wire rack	5		3	1-2
Beefburger*	wire rack	4		3	25-30

\* Turn the burgers over after 17-20 min. Insert the universal pan at level 1.