

Safety instructions

- The washing machine is heavy - take care when lifting.
- **Caution:** frozen hoses can crack/burst. Do not install the washing machine outdoors or in areas exposed to frost.
- The washing machine could be damaged. Do not lift the appliance by protruding components (e.g. the washing machine door).
- In addition to the instructions provided in this document, special regulations from the relevant water and electric utility companies may apply.
- If in doubt, have a technician connect the appliance.
- Route hoses and cables in such a way that there is no risk of tripping.

Environmentally-friendly disposal

- Dispose of packaging in an environmentally friendly manner.
- This appliance is labelled in accordance with European Directive 2002/96/EC on Waste Electrical and Electronic Equipment - WEEE. The directive provides an EU-wide framework for the return and recycling of used appliances.

Installation surface

- The machine must be stable so that it does not move around.
- The surface on which it is installed must be firm and level.
- Soft floors/floor coverings are not suitable.

Installation on a pedestal

- The feet of the washing machine **must** be secured with holding brackets *.
- * Order no. WMZ 2200, WX 9756

Installation on a wood joist floor

- If possible, place the washing machine in a corner.
- Screw a water-resistant wooden board (min. 30 mm thick) to the floor.
- The feet of the washing machine **must** be secured with holding brackets *.
- * See above for order no.

Installing the appliance

- Install the appliance before connecting it to the power supply.

Installation in a kitchenette

- Recess width of 60 cm required.
- Only install the washing machine underneath a continuous worktop that is securely connected to adjacent cabinets.

Installation underneath the worktop

- **Risk of electric shock.**
- Instead of the appliance covering plate, you **must** have a metal cover * fitted by an expert.
- * Order no. WMZ 2410, WZ 10170

- Recess width of 60 cm required.

Scope of delivery depending on model

Moisture inside the drum is due to final testing.

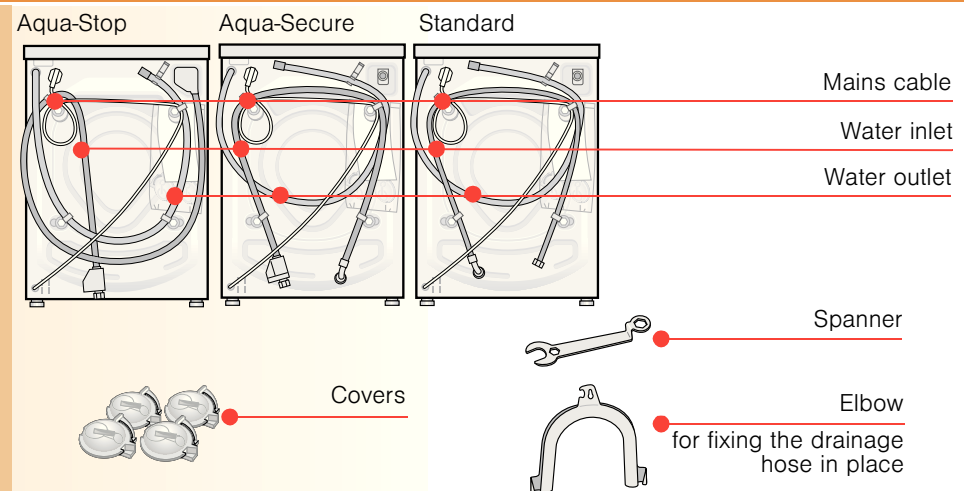

Also required, depending on the connection:

- 1 hose clamp \varnothing 24-40 mm (specialist retailers) to connect to a siphon → Page 4; water connection

Useful tools

- Spirit level for levelling.
- Spanner with WAF13: for loosening the transport safety devices → Page 3 and WAF17: for aligning the appliance feet → Page 5.

Hose and cable lengths depending on model

Left-hand connection or Right-hand connection

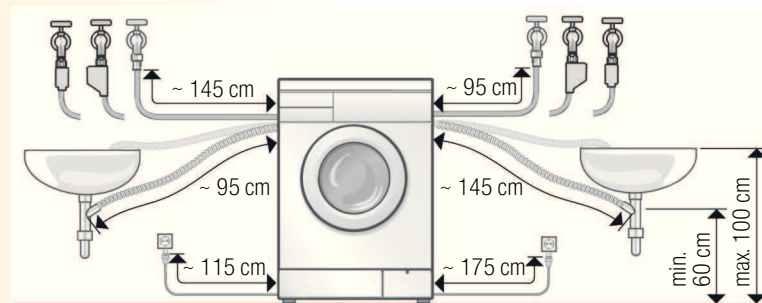

- Available from specialist retailers/the after-sales service:
- Extension for Aqua-Stop and cold water inlet hose (approx. 2.50 m). Order no. WMZ 2380, WZ 10130
 - Longer inlet hose (approx. 2.20 m) for standard model.

Removing the transport safety devices

- Before using the appliance for the first time, the 4 transport safety devices must be completely removed and kept safe.
- If you need to transport the appliance at a later date, always refit the transport safety devices to prevent damage to the machine. → Page 6.
- Store the screw and sleeve screwed together.

1. Remove hoses from the holders, depending on the model.

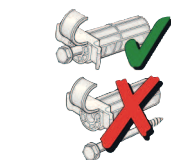

2. Loosen all 4 bolts from the transport safety devices until they are free to move in the sleeves.

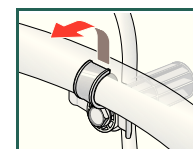

3. Remove mains cable from the holders. Completely remove all 4 transport safety devices.

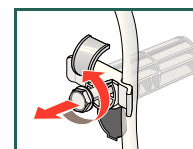

4. Insert the covers.

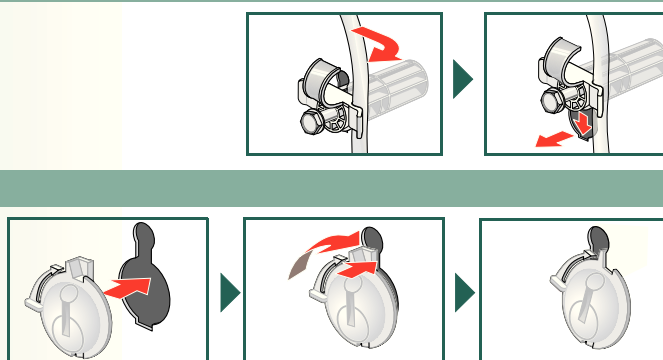

Water connection depending on model

- **Risk of electric shock.** Do not immerse the Aqua-Stop safety device in water (contains an electric valve).
- To prevent leaks or water damage, observe the instructions in this section.
- **Caution:** only operate the washing machine using cold drinking water.
- Do not connect to the mixer tap of an unpressurised hot-water boiler.
- Do not use a used inlet hose. Only use the inlet hose supplied or one which was purchased from an authorised specialist retailer.
- If in doubt, have a technician connect the appliance.

Water inlet

Water inlet hose:

Caution: do not kink, squash, modify or cut through (otherwise its strength is no longer guaranteed).

Optimum water pressure in the supply network: 100-1000 kPa (1-10 bar)

- When the tap is on, the water flow is at least 8 l/min.
- If the water pressure is higher than this, a pressure reducing valve must be installed.

1. Connect the water inlet hose to the tap. **Caution:** only tighten the screw connections by hand.

2. Open the water tap carefully, checking the leak tightness of the connection points. **Caution:** the screw connection is under mains water pressure.

Model: Aqua-Stop Aqua-Secure Standard

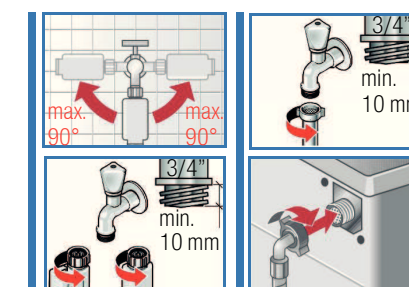

Water outlet

Water outlet hose:

Caution: do not kink or pull lengthways.

Height difference between the installation surface and the drain: min. 60 cm - max. 100 cm

Outlet into a sink

Caution: secure the drain hose so that it cannot slip out. **Caution:** the plug must not block drainage from the sink. During pumping, check whether the water is draining away quickly enough. The end of the drain hose must not be immersed in the water that is pumped out! This would result in the risk of water being sucked back into the washing machine!

Drainage into a siphon:

Caution: the connection point must be secured with a hose clamp, \varnothing 24-40 mm (specialist retailers).

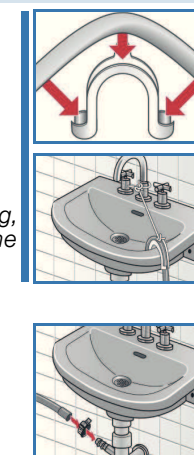

Levelling

 Intense noise, vibrations and "wandering" may be the result of incorrect levelling.

Levelling the washing machine with a spirit level

1. Loosen the lock nut using a spanner, by turning it in a clockwise direction.
2. Change the height by turning the appliance feet.
Caution: all four appliance feet must be firmly on the ground. The washing machine must not wobble. Check the levelness of the washing machine with a spirit level and adjust if necessary.
3. Tighten the lock nut against the housing.
In doing so, hold the foot tight and do not adjust its height.
Caution: the lock nuts on all four appliance feet must be screwed tightly against the housing.

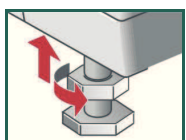
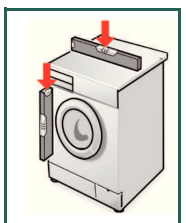
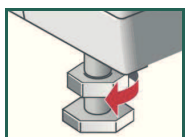

Electrical connection

- The washing machine must only be connected to an alternating current via a properly installed earthed socket.
- The power supply and voltage indicated on the washing machine (rating plate) must be the same.
- The connected load and fuse required are specified on the rating plate.
- Make sure that:
 - the mains plug fits the socket,
 - the cable cross-section is adequate,
 - the earthing system is properly installed.
- The mains cable may only be replaced by a qualified electrician (if required). Replacement mains cables are available from customer services.
- Do not use multiple plugs/couplings or extension cables.
- If a residual current circuit breaker is used, only use a type which displays this symbol: . Only this symbol guarantees compliance with the currently applicable regulations.
- Mains plug:
 - do not plug in to/pull out of the socket with damp hands.
 - when removing the plug from the socket, pull the plug body only, not the cable.
 - never pull the plug out during operation.

1010 / 9000124380



Transportation, e.g. when moving house

1. Before transporting the washing machine:

1. Turn off the tap.
2. Drain residual detergent solution → *Instruction manual*; Maintenance - drain pump.
3. Reduce the water pressure in the inlet hose → *Instruction manual*; Maintenance - filter in water inlet.
4. Disconnect the washing machine from the power supply.
5. Disconnect the hoses.

2. Install the transport safety devices:

1. Remove the covers.
2. Insert all 4 transport safety devices. Clip the mains cable securely in the holders. Tighten the bolts from the transport safety devices.

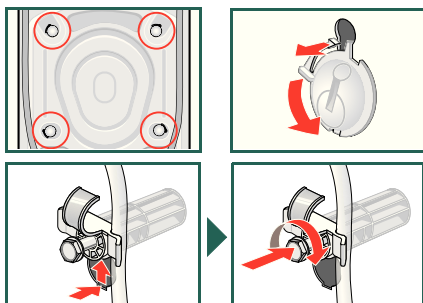

 After transportation, the transport safety devices must be removed. → Page 3.

 To prevent unused detergent from flowing straight into the drain during the next wash: Pour 1 litre of water into compartment II and start the **Empty** programme.

Technical specifications

● Dimensions (width x depth x height)	59.5 x 44 x 84.7 cm
● Weight	65 kg
● Mains connection	Nominal voltage 220-240 V, 50 Hz Nominal current 10 A Nominal power 2,300 W
● Water pressure	100-1000 kPa (1-10 bar)

Aqua-Stop warranty Only for appliances with Aqua-Stop

In addition to warranty claims against the vendor from the purchase agreement and in addition to our appliance warranty, we will pay damages under the following conditions:

1. If a fault in our Aqua-Stop system causes water damage, we will reimburse damages caused to private customers.
2. The liability warranty is valid for the service life of the appliance.
3. A warranty claim is only valid on condition that the appliance fitted with Aqua-Stop has been correctly installed and connected according to our instructions. This condition includes the correct fitting of an Aqua-Stop extension (genuine accessory). Our warranty goes not cover defective power cables or fittings between the Aqua-Stop connection and the tap.
4. Appliances with Aqua-Stop do not need to be supervised during operation, nor secured afterwards by turning off the tap. The tap only needs to be turned off if you are away from home for a long period, e.g. for several weeks' holiday.

After-sales service

- If you cannot rectify a fault yourself → *Instruction manual: What do to if ...*, Page 11, please contact our after-sales service. We can always find a suitable remedy, so that a technician is not called out unnecessarily.
- The contact details for your nearest after-sales service can be found here or in the After-sales service directory (depending on the model).
- Please give the after-sales service the product number (E-Nr.) and the production number (FD) of the appliance.

E-Nr. _____ FD _____

Product number Production number

*This information can be found:
inside the washing machine door* / on the open
service flap* and on the back of the appliance.
depending on model

- **You can rely on the competence of the manufacturer.** Please contact us. This way, you can ensure the repair is carried out by trained service technicians who are equipped with genuine spare parts.

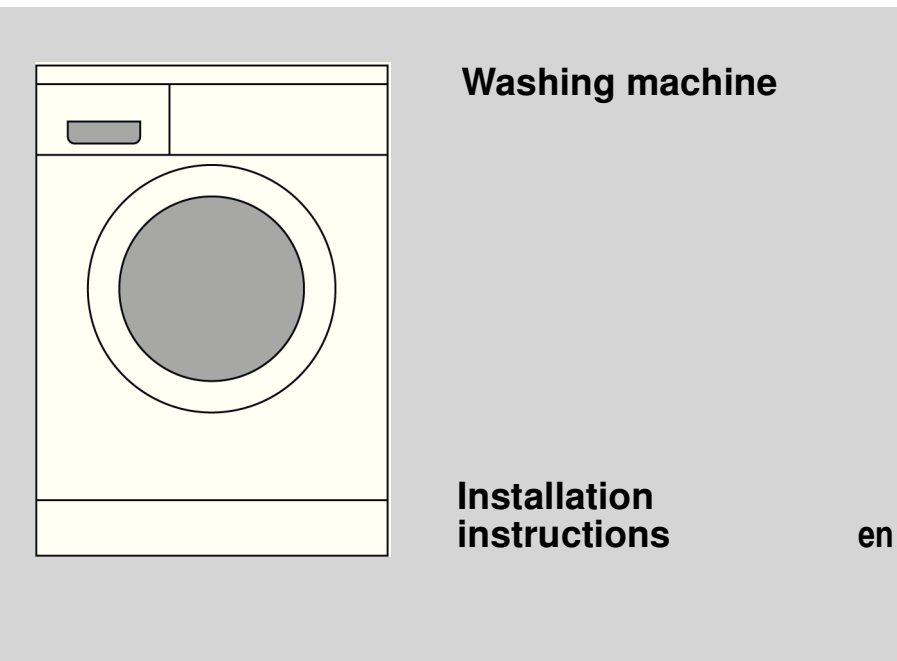

Washing machine

Installation instructions

en

Contents

	Page
■ Safety instructions	1
■ Environmentally-friendly disposal	1
■ Installation surface	1
■ Installing the appliance	1
■ Scope of delivery	2
■ Hose and cable lengths	2
■ Removing the transport safety devices	3
■ Water connection	4
■ Levelling	5
■ Electrical connection	5
■ Transportation, e.g. when moving house	6
■ Technical specifications	6
■ Aqua-Stop warranty	7
■ After-sales service	7



Do not operate the washing machine until you have read these instructions. Please also observe the separate instruction manual. Keep all the documents in a safe place for future reference, or to pass on to the next owner.



Safety instructions

- The washing machine is heavy - take care when lifting.
- Caution: frozen hoses can crack/burst. Do not install the washing machine outdoors or in areas exposed to frost.
- The washing machine could be damaged. Do not lift the appliance by protruding components (e.g. the washing machine door).
- In addition to the instructions provided in this document, special regulations from the relevant water and electric utility companies may apply.
- If in doubt, have a technician connect the appliance.
- Route hoses and cables in such a way that there is no risk of tripping.

Environmentally-friendly disposal



- Dispose of packaging in an environmentally friendly manner.
- This appliance is labelled in accordance with European Directive 2002/96/EC on Waste Electrical and Electronic Equipment - WEEE. The directive provides an EU-wide framework for the return and recycling of used appliances.

Installation surface

- The machine must be stable so that it does not move around.
- The surface on which it is installed must be firm and level.
- Soft floors/floor coverings are not suitable.



Installation on a pedestal

- The feet of the washing machine **must** be secured with holding brackets *.
* Order no. WMZ 2200, WX 9756



Installation on a wood joist floor

- If possible, place the washing machine in a corner.
- Screw a water-resistant wooden board (min. 30 mm thick) to the floor.
- The feet of the washing machine **must** be secured with holding brackets *.
* See above for order no.

Installing the appliance



Install the appliance before connecting it to the power supply.



Installation in a kitchenette

- Recess width of 60 cm required.
- Only install the washing machine underneath a continuous worktop that is securely connected to adjacent cabinets.



Installation underneath the worktop

Risk of electric shock.

- Instead of the appliance covering plate, you **must** have a metal cover * fitted by an expert.
* Order no. WMZ 2410, WZ 10170



- Recess width of 60 cm required.

Scope of delivery depending on model

Moisture inside the drum is due to final testing.

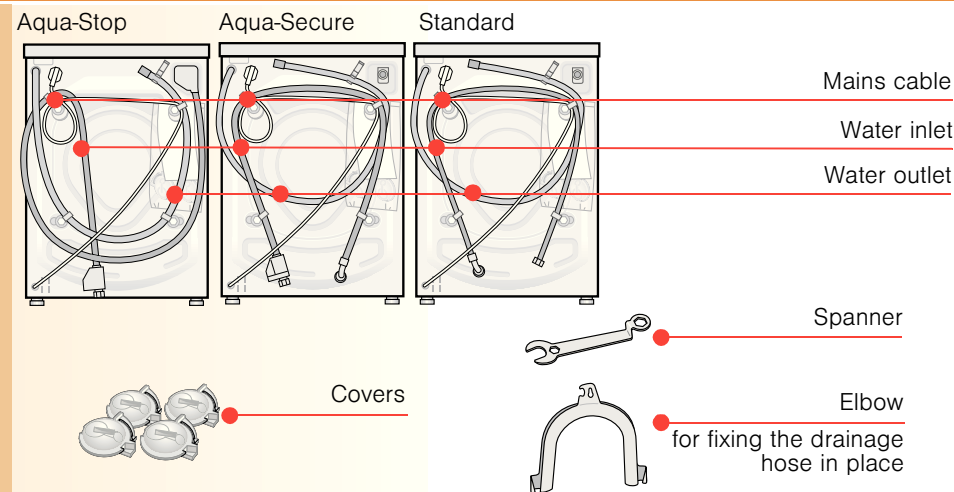

Also required, depending on the connection:

- 1 hose clamp \varnothing 24-40 mm (specialist retailers) to connect to a siphon
→ Page 4; water connection

Useful tools

- Spirit level for levelling.
- Spanner with WAF13: for loosening the transport safety devices → Page 3 and WAF17: for aligning the appliance feet → Page 5.

Hose and cable lengths depending on model



Left-hand connection

or

Right-hand connection

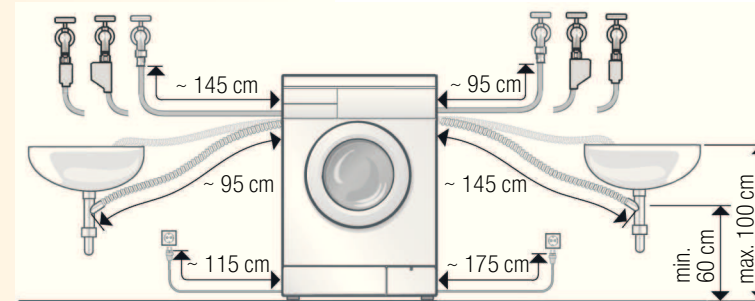

Available from specialist retailers/the after-sales service:

- Extension for Aqua-Stop and cold water inlet hose (approx. 2.50 m).
Order no. WMZ 2380, WZ 10130
- Longer inlet hose (approx. 2.20 m) for standard model.

Removing the transport safety devices



- Before using the appliance for the first time, the 4 transport safety devices must be completely removed and kept safe.
- If you need to transport the appliance at a later date, always refit the transport safety devices to prevent damage to the machine.
→ Page 6.
- Store the screw and sleeve screwed together.

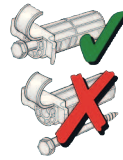

1. Remove hoses from the holders, depending on the model.

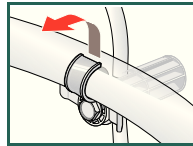

2. Loosen all 4 bolts from the transport safety devices until they are free to move in the sleeves.

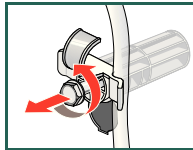

3. Remove mains cable from the holders. Completely remove all 4 transport safety devices.

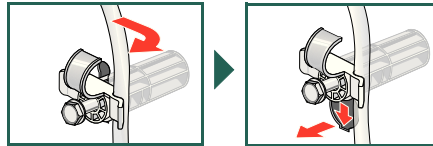

4. Insert the covers.

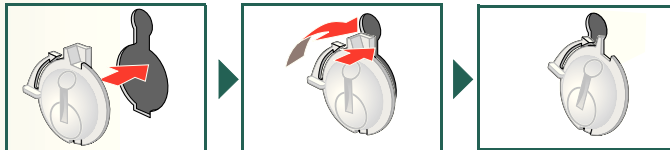

Water connection depending on model



- **Risk of electric shock.** Do not immerse the Aqua-Stop safety device in water (contains an electric valve).
- To prevent leaks or water damage, observe the instructions in this section.
- **Caution:** only operate the washing machine using cold drinking water.
- Do not connect to the mixer tap of an unpressurised hot-water boiler.
- Do not use a used inlet hose. Only use the inlet hose supplied or one which was purchased from an authorised specialist retailer.
- If in doubt, have a technician connect the appliance.



Water inlet

Water inlet hose:

Caution: do not kink, squash, modify or cut through (otherwise its strength is no longer guaranteed).

Optimum water pressure in the supply network: 100-1000 kPa (1-10 bar)

- When the tap is on, the water flow is at least 8 l/min.
- If the water pressure is higher than this, a pressure reducing valve must be installed.

Model: Aqua-Stop
Aqua-Secure

Standard

1. Connect the water inlet hose to the tap.
Caution: only tighten the screw connections by hand.
2. Open the water tap carefully, checking the leak tightness of the connection points.
Caution: the screw connection is under mains water pressure.

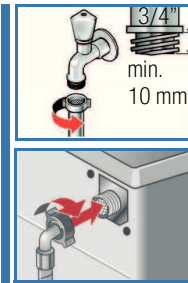
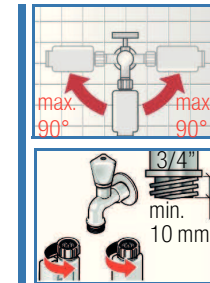

Water outlet

Water outlet hose:

Caution: do not kink or pull lengthways.

Height difference between the installation surface and the drain:
min. 60 cm - max. 100 cm

Outlet into a sink

Caution: secure the drain hose so that it cannot slip out.

Caution: the plug must not block drainage from the sink. During pumping, check whether the water is draining away quickly enough. The end of the drain hose must not be immersed in the water that is pumped out! This would result in the risk of water being sucked back into the washing machine!

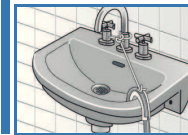
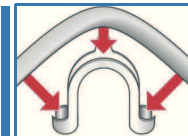

Drainage into a siphon:

Caution: the connection point must be secured with a hose clamp, Ø 24-40 mm (specialist retailers).

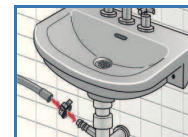

Levelling

 Intense noise, vibrations and “wandering” may be the result of incorrect levelling.

Levelling the washing machine with a spirit level

1. Loosen the lock nut using a spanner, by turning it in a clockwise direction.
2. Change the height by turning the appliance feet.
Caution: all four appliance feet must be firmly on the ground. The washing machine must not wobble. Check the levelness of the washing machine with a spirit level and adjust if necessary.
3. Tighten the lock nut against the housing.
In doing so, hold the foot tight and do not adjust its height.
Caution: the lock nuts on all four appliance feet must be screwed tightly against the housing.

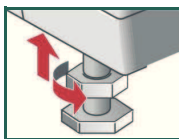
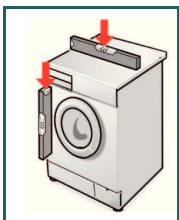
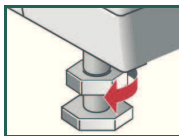

Electrical connection

- The washing machine must only be connected to an alternating current via a properly installed earthed socket.
- The power supply and voltage indicated on the washing machine (rating plate) must be the same.
- The connected load and fuse required are specified on the rating plate.
- Make sure that:
 - the mains plug fits the socket,
 - the cable cross-section is adequate,
 - the earthing system is properly installed.
- The mains cable may only be replaced by a qualified electrician (if required). Replacement mains cables are available from customer services.
- Do not use multiple plugs/couplings or extension cables.
- If a residual current circuit breaker is used, only use a type which displays this symbol: . Only this symbol guarantees compliance with the currently applicable regulations.
- Mains plug:
 - do not plug in to/pull out of the socket with damp hands.
 - when removing the plug from the socket, pull the plug body only, not the cable.
 - never pull the plug out during operation.



Manufacturer → *Instruction manual*

Transportation, e.g. when moving house

1. Before transporting the washing machine:

1. Turn off the tap.
2. Drain residual detergent solution → *Instruction manual*; Maintenance - drain pump.
3. Reduce the water pressure in the inlet hose → *Instruction manual*; Maintenance - filter in water inlet.
4. Disconnect the washing machine from the power supply.
5. Disconnect the hoses.

2. Install the transport safety devices:



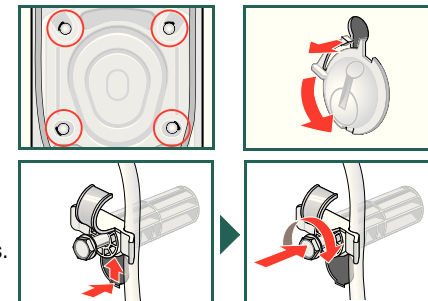

1. Remove the covers.
2. Insert all 4 transport safety devices. Clip the mains cable securely in the holders. Tighten the bolts from the transport safety devices.



 After transportation, the transport safety devices must be removed. → *Page 3*.

 To prevent unused detergent from flowing straight into the drain during the next wash: Pour 1 litre of water into compartment **II** and start the **Empty** programme.

Technical specifications

 Dimensions (width x depth x height)	59.5 x 44 x 84.7 cm
 Weight	65 kg
 Mains connection	Nominal voltage 220-240 V, 50 Hz Nominal current 10 A Nominal power 2,300 W
 Water pressure	100-1000 kPa (1-10 bar)

Aqua-Stop warranty Only for appliances with Aqua-Stop

In addition to warranty claims against the vendor from the purchase agreement and in addition to our appliance warranty, we will pay damages under the following conditions:

1. If a fault in our Aqua-Stop system causes water damage, we will reimburse damages caused to private customers.
2. The liability warranty is valid for the service life of the appliance.
3. A warranty claim is only valid on condition that the appliance fitted with Aqua-Stop has been correctly installed and connected according to our instructions. This condition includes the correct fitting of an Aqua-Stop extension (genuine accessory). Our warranty goes not cover defective power cables or fittings between the Aqua-Stop connection and the tap.
4. Appliances with Aqua-Stop do not need to be supervised during operation, nor secured afterwards by turning off the tap. The tap only needs to be turned off if you are away from home for a long period, e.g. for several weeks' holiday.

After-sales service

If you cannot rectify a fault yourself → Instruction manual: What do if ..., Page 11, please contact our after-sales service. We can always find a suitable remedy, so that a technician is not called out unnecessarily.

The contact details for your nearest after-sales service can be found here or in the After-sales service directory (depending on the model).

Please give the after-sales service the product number (E-Nr.) and the production number (FD) of the appliance.

E-Nr. _____ FD _____

Product number Production number

*This information can be found:
inside the washing machine door* / on the open
service flap* and on the back of the appliance.
depending on model

You can rely on the competence of the manufacturer. Please contact us. This way, you can ensure the repair is carried out by trained service technicians who are equipped with genuine spare parts.

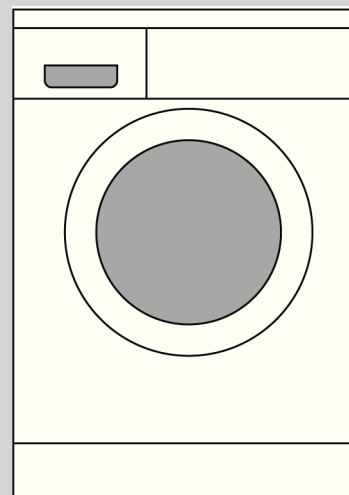

Washing machine

Installation instructions

en

Contents

	Page
■ Safety instructions	1
■ Environmentally-friendly disposal	1
■ Installation surface	1
■ Installing the appliance	1
■ Scope of delivery	2
■ Hose and cable lengths	2
■ Removing the transport safety devices	3
■ Water connection	4
■ Levelling	5
■ Electrical connection	5
■ Transportation, e.g. when moving house	6
■ Technical specifications	6
■ Aqua-Stop warranty	7
■ After-sales service	7



Do not operate the washing machine until you have read these instructions. Please also observe the separate instruction manual. Keep all the documents in a safe place for future reference, or to pass on to the next owner.