

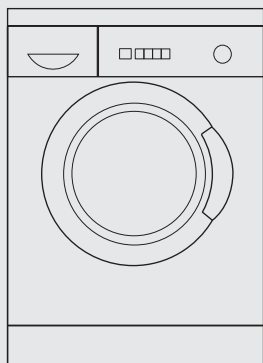

## Washing Machine



en Instruction Manual and  
Installation Instructions



Household Appliances

---

# Table of Contents

---

## Operating Instructions

Safety Instructions .....	4
Control panel .....	5
Before using your washing machine for the first time .....	6
Preparing, sorting and loading the washing ....	7
Preparing the washing .....	7
Sorting the washing .....	7
Degrees of dirt .....	8
Loading the washing .....	9
Detergents and cleaning products .....	10
Dosing detergent .....	10
Adding detergent/cleaning product .....	10
Programmes and functions .....	11
Programme selector .....	11
Additional option – buttons .....	14
Washing .....	18
Changing the programme .....	19
Cancelling the programme .....	19
After washing .....	20
Removing the washing .....	20
Special applications .....	21
Soaking .....	21
Starching .....	21
Cleaning and Care .....	22
Clean housing, fascia and supply lines .....	22
Cleaning the drum .....	22
Descaling the washing machine .....	22
Cleaning the detergent dispenser .....	23
Cleaning the drain pump .....	24
Cleaning water inlet strainers .....	25

Help with minor problems .....	26
Fault displays .....	26
Consumption values .....	31
Customer service .....	32
Installing, connecting and transporting the appliance .....	34
Safety instructions .....	34
Packaging and old appliances .....	34
Standard accessories .....	35
Dimensions .....	36
Installation surface .....	36
Built-under or built-in appliance installation ..	37
Removing the transport bolts .....	38
Hose and cable lengths .....	40
Connecting the water .....	41
Aligning the washing machine .....	42
Connecting the power .....	43
Transport, e.g. when moving .....	44
Index .....	45

---

## Installation Instructions

---

## Appendix

This instruction describes various models. Differences are indicated in the appropriate places.

Please read this instruction manual and all other information accompanying the washing machine before operating the appliance.

Please retain all documents for future reference or for a subsequent appliance owner.

---

# Safety Instructions

## General

Your washing machine is intended:

- For domestic use only.
- For washing machine-washable fabrics in washing lye.
- For operation using cold tap water and conventional laundry detergents and additives that are suitable for use in washing machines.

## Safety Instructions

Never leave children unattended in the proximity of the washing machine.

Keep domestic pets away from the washing machine.

Do not insert / remove the mains plug with wet or damp hands.

Handle the plug body only when removing the plug from the socket.

Take care when draining hot washing lye.

Do not touch the loading door when washing at high temperatures.

Do not climb onto the washing machine.

Do not lean on the open washing machine door.

### **⚠ Danger of suffocation!**

Keep children away from shipping carton and packaging components. Danger of suffocation from folding cartons and plastic film.

### **⚠ Danger of fatal injury!**

On out-of service appliances, unplug mains plug.

Cut off power cord and discard with mains plug.

To prevent playing children from becoming trapped and endangered, ensure that the door locking mechanism is disabled.

# Control panel

The **Ready in time** is displayed, if the programme is selected,

## Spin speed selector (if required)

For stepless setting of the spin speed; must click in place at **Rinse Hold**.

## Start button

For starting the wash cycle (programme must have been selected).

## Programme selector

For switching the machine on and off and for selecting the programme. Can be rotated in either direction.

The programme selector does not rotate while the programme is running – the programme sequence is electronically controlled.

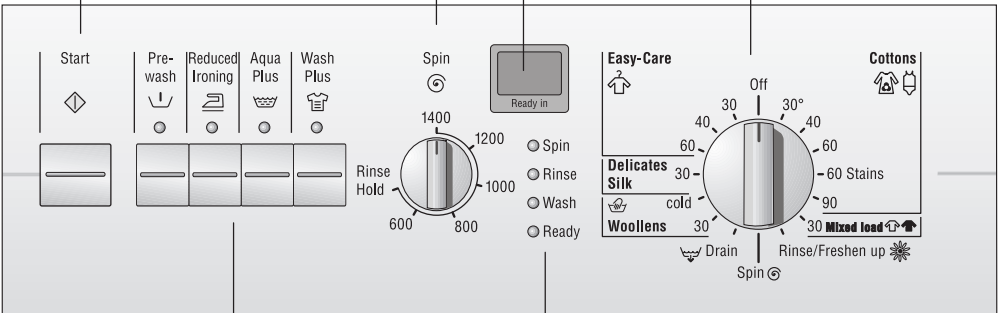

## Buttons for additional options

(in addition to the programme if required)

- Prewash:** actuate Prewash
  - Reduced Ironing:** creases are reduced.
  - Aqua Plus:** extended rinse cycle.
  - Wash Plus:** extended intensive washing.
- Combination of additional options is possible.

The indicator lights of the buttons come on if the additional options are active.

Switch off additional option: press button again.

## Indicator light

**Ready** is on, if the programme is selected,  
**Wash, Rinse, Spin** light up if the **Start** button is pressed and the respective programme segment runs.  
Indicator lights flash: Operation error.

---

# Before using your washing machine for the first time

## Attention

The washing machine must have been installed and connected properly refer to Page 34.

- i** The washing machine was tested before leaving the factory. To remove any water left over from testing procedures, the first washing cycle should be carried out **without** laundry in the machine.
- Turn the tap on.
- Pull out the detergent drawer all the way.
- Pour approx. 1 litre / 1  $\frac{3}{4}$  pt of water into chamber **II** of the detergent dispenser.
- Half fill the measuring beaker with detergent and pour into chamber **II**.
- i** Do not use any special detergents for delicates or woollens (excessive foam).
- Close the detergent drawer.
- Close the washing machine door.
- Set the programme selector to **Cottons 90 °C**.
- Press the **Start** button.  
The programme starts.

The programme has ended when a programme duration of **0** is displayed:

- Turn the programme selector to **Off**.

# Preparing, sorting and loading the washing

## Preparing the washing

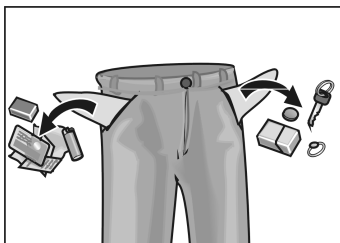

### Attention

Loose debris (e.g. coins, paper clips, needles, nails) can damage items of clothing as well as parts of the washing machine (e.g. drum).

- Empty all pockets on items of clothing.
- Brush sand out of pockets and cuffs/turn-ups.
- Close zips, fasten pillow cases/cushion covers.
- Remove curtain runners or tie up in a net/bag.
- Wash in a net/cushion cover:
  - delicates, e.g. tights, curtains,
  - small laundry items, e.g. socks or handkerchiefs,
  - underwired bras (underwire may become detached during washing and cause damage).
- Trousers, knitwear and knitted textiles, e.g. jersey garments, T-shirts or sweatshirts should be turned inside out.

## Sorting the washing

According to colour and degree of dirt

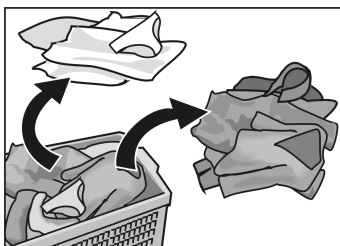

### Attention

Washing may become discoloured. Do not wash new coloured washing with other washing.

White items may become grey. Wash white and coloured items separately.

- i** Observe the treatment symbols on the textile labels (see also programme overview).

## Degrees of dirt

### **lightly soiled**

No visible soiling or stains. Washing has probably absorbed body odour.

### **normally soiled**

Visible soiling and/or a few light stains.

### **very soiled**

Visible soiling and/or stains, e.g. work clothes, e.g. mechanic's overalls, baker's and butcher's clothing.

### **Typical stains**

- Skin grease, cooking oil/fat, sauces, mineral oil, wax (containing fat/oil).
- Tea, coffee, red wine, fruit, vegetables (which can be bleached).
- Blood, egg, milk, starch (containing protein, carbohydrate).
- Soot, earth, sand (pigments), tennis clothing soiled with red clay.

### **Removing stains**

Remove/pretreat stains as soon as possible after they have occurred.

First dab with a soapy solution. Do not rub.

Then select the appropriate programme and wash the item.

Stubborn/dried in stains can sometimes only be removed by washing several times.



## Loading the washing

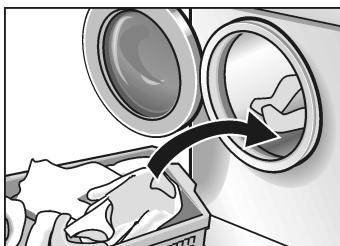

### ⚠ Risk of explosion!

Items of clothing that have been pretreated with solvent-based cleaning agents, e.g. stain remover and dry cleaning spirit, represent an explosion hazard once loaded into the washing machine. Before loading the laundry, rinse thoroughly by hand.

### Attention

Foreign objects in the drum may damage the laundry. Before loading the laundry, check that there is no debris in the drum.

- Open the washing machine door.
- Unfold the sorted items of clothing and place them loosely into the drum. Mix large and small items. Laundry items which vary in size are more evenly distributed during the spin cycle.
- i** Do not exceed recommended loads (see programme overview). Overloading will cause poor wash results and encourage creasing.
- Close the washing machine door. Take care not to trap any items of clothing between the loading door and rubber seal.

---

# Detergents and cleaning products

---

## Dosing detergent

### ⚠ Risk of poisoning!

Keep detergents and additives out of the reach of children.

Dose detergent according to

- the water hardness. You can find out the water hardness from your water utility company.
- the amount of laundry.
- the degree of soiling.
- the specifications of the detergent manufacturer.

Pour liquid detergent into the corresponding dispenser.

### Too little detergent:

The laundry is not washed clean and eventually becomes grey and hard. Greyish-brown dots (grease spots) may stain the laundry. The heating elements are calcifying.

### Too much detergent:

Environmentally incompatible, excessive foam reduces wash agitation causing poor washing and rinsing results.

---

## Adding detergent/cleaning product

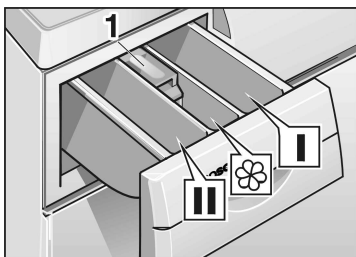

### Dispenser I

Detergent for prewash or starch.

### Dispenser II

Detergent for main wash, water softener, pre-soaking agent, bleach and stain removal product.

### Dispenser ☼

Cleaning product, e.g. fabric softener or fabric conditioner (do not fill above the lower edge of the insert 1).

**i** Concentrated or viscous fabric softener or fabric conditioner must be diluted with a little water before it is poured into the dispenser (prevents the overflow from becoming blocked).

---

# Programmes and functions

---

## Programme selector

Select the desired programme – see also programme overview.

**i** Programmes wash lightly soiled textiles in the shortest possible time. For heavily soiled textiles reduce the load or press the **Wash Plus** button!

## Basic programmes

### **Cottons 30, 40, 60 °C**

For hard-wearing textiles, e.g. made of cotton or linen.

### **Cottons 60 °C Stains**

For stained, heavily soiled textiles, e.g. cotton or linen. Energy and water saving programme. The longer washing time in this 60 °C programme means that the cleaning effects are comparable with those of a 90 °C programme, although the power and water consumption is considerably lower.

### **Cottons 90 °C**

Energy-intensive programme for heat-resistant textiles, e.g. made of cotton or linen.

To protect the waste-water pipes, the hot water is mixed with approx. 7 litres of cold water and cooled before being drained.

### **Easy-Care 30, 40, 60 °C**

For easy-care textiles, e.g. made of cotton, linen, synthetic or blended fabrics.

**i** Also suitable as **short programme**.

### **Mixed load 30 °C**

Time-optimised programme for lightly soiled cotton textiles and easy-care textiles. Different types of washing can be washed together.

Even suitable for washing new textiles before they are worn for the first time.

**i** Wash white and coloured items separately. Do not wash new coloured washing with other washing.

Short washing time.

### **Delicates/Silk 30 °C**

For delicate, washable textiles, e.g. silk, satin, synthetic materials or blended fabrics (e.g. curtains).

Delicates cycle at 30 °C for hand and machine washable silk.

**i** We do not recommend washing these textiles with other rougher textiles.

### **Woolens cold, 30 °C**

For hand and machine washable wool or wool-rich textiles, e.g. cashmere, mohair or angora.

Also suited for hand washable silk.

## **Programme options**

### **Rinse/Freshen up**

Rinse cycle with subsequent spin cycle for rinsing hand-washed items or for starching.

Press **Aqua Plus** button for an additional rinse cycle.

Also suited to “Freshen up” items, that have been tucked away or stored for a period of time, to remove creases caused by folding and storage and to eliminate odours.

Use fabric conditioner for “fresh” smell

**i** Do not use detergent (this is not a wash programme).

Reduced spin speed.

### **Spin**

Spin cycle after a programme with setting **Rinse Hold** or for spinning hand-washed washing with selection of the required speed. Washing water or rinsing water is drained before the spin cycle.

Reduced spin speed.

### **Drain**

Water is drained after a programme with the **Rinse Hold** setting on display panel for gentle treatment of delicate laundry.

# Spin speed selector

## Basic setting

The spin speed selector is pointing up.  
In the **Cottons** programme the fabrics will be spun at the maximum possible spin speed.

In the **Easy-Care, Mixed load, Delicates/Silk** and **Woollens** programmes, a lower spin speed will automatically be used, irrespective of the position of the button – gentle treatment of delicate fabrics.

**i** Between the rinse cycles the washing is given an intermediate spin only (not for **Delicates/Silk**). This improves the rinsing results.

## Maximum spin speeds

Revolutions per minute depending on model			Type of laundry / Programme options
1400	1200	1000	Cottons
800	800	800	Easy-Care
800	800	800	Mixed load
600	600	600	Delicates/Silk
800	800	800	Woollens
1200	800	800	Rinse/Freshen up
1200	800	800	Spin

## Additional option

### Rinse Hold ( No final spin)

For delicate textiles and net curtains.

All programmes can be carried out without the final spin cycle. The laundry is left in the final rinsing water.

“---” appears in the **Ready in** display when programme is ended and the **Rinse** indicator light is on.

Before the washing can be removed, the **Drain** or **Spin** programme must be run by setting the speed selector to the required speed.

---

## Additional option – buttons

### Prewash

For very dirty, hard-wearing laundry, e.g. cotton or linen.

The washing temperature of the prewash is 30 °C.  
Prewash cannot be selected for woollens programme.

**i** If the prewash is cancelled, the detergent solution is pumped out and the programme continues with the main wash cycle.

### Reduced Ironing

Gentler reduced spin cycle with subsequent fluffing.  
After the spin cycle, the laundry is loose in the drum – creasing is reduced.

### Aqua Plus

The water level is increased for the wash and rinse cycles in all programmes except woollens.

An additional rinse cycle is run.

Programme duration is extended accordingly.

Recommended application:

- for particularly intensive rinsing, e.g. for sensitive skin,
- in areas with very soft water.

## Wash Plus

The washing time is extended so that highly soiled washing or 6 kg of Cottons are washed more intensively.

Press the button in addition to the programme for the following combinations of load and degree of soiling:

<b>Amount of laundry</b>	<b>Programme and button Wash Plus</b>	<b>Degree of soiling</b>
6 kg / 13.2 lb	Cottons 30, 40, 60 °C	lightly to normally soiled
	Cottons 60 °C Stains	normally soiled with stains
	Cottons 90 °C	normally soiled
up to 5 kg / 11 lb	Cottons 30, 40, 60 °C	normally to heavily soiled
	Cottons 60 °C Stains	normally to heavily soiled with stains
up to 3 kg / 6.6 lb	Easy-Care 30, 40, 60 °C	normally to heavily soiled
	Mixed load 30 °C	
up to 2 kg / 4.4 lb	Delicates/Silk 30 °C	normally to heavily soiled
	Woolens cold, 30 °C	

See the separate programme table for further information.

# Ready In display

Example of **Easy-Care 40 °C** programme:

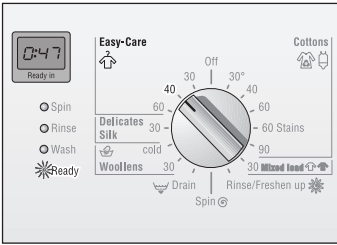

- Turn the programme selector to the desired programme.

The **Ready** indicator light comes on.

The expected **Ready In** (programme duration) is displayed, e.g. **0:47**.

- **Ready In** is displayed in hours and minutes, e.g. 0:47 – 47 minutes  
1:17 – 1 hour and 17 minutes

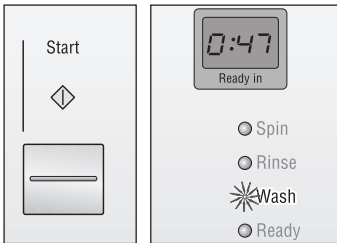

- Press the **Start** button.

The programme starts.

The colon **:** between hours and minutes flashes and the programme duration counts down in minutes.

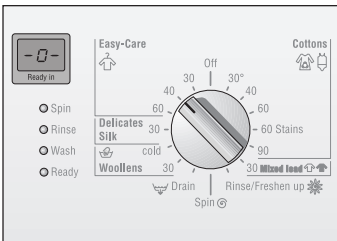

When the programme ends, the displays shows **-0-**.

- At the start of the programme, a projection of the remaining time occurs under the assumption of a full load and a water supply temperature of 15 °C. The actual load is calculated during the first 10 minutes.

The remaining time can become increased or reduced while the programme is running for the following reasons.



**Reductions in time** occur because of:

- small loads.
- reduced heating times, e.g. if the water is very hot.

**Increases in time** occur because of:

- Additional rinse cycle if excessive foam is in the laundry,
- Multiple spinning if the laundry is distributed poorly in the drum,
- Increased heating times, e.g. when the water is too cold,
- Water pressure too low,
- Selection of an additional option, e.g. **Aqua Plus** and/or **Wash Plus** after the programme has started,
- Very absorbent washing extends the heating duration.

# Washing



- Turn on water tap.

Example of **Easy-Care**  
40 °C programme:

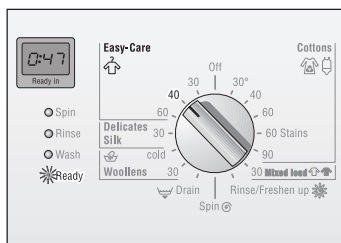

- Turn the programme selector to the desired programme – see also programme overview  
The **Ready** indicator light is on.  
The **Ready In** time is displayed.

Example:

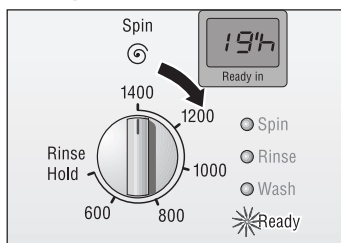

- If required:
  - select the desired spin speed or **Rinse Hold**.

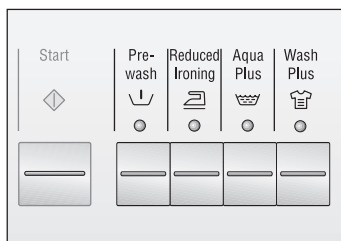

- If required, press the button(s) for additional option(s).  
The indicator light of the selected button is on.

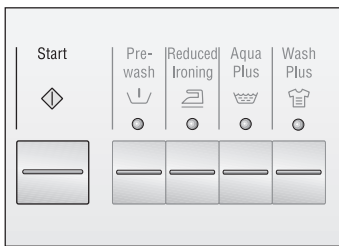

## Changing the programme

- Press the **Start** button.  
The programme starts.

If you have accidentally selected the wrong programme:

- Turn the programme selector to a newly selected programme.  
If Prewash is selected subsequently, set the programme selector to **Off** and reselect the programme
- If required, change the other settings.
- Press the **Start** button.  
The programme starts.
- i** The newly selected programme starts at the programme section at which the previous programme was cancelled, however with the new settings.

## Cancelling the programme

If you would like to terminate a programme and remove the washing:

- Turn the programme selector to **Drain, Spin** or **Rinse/Freshen up**.  
If required, select the desired spin speed (but not setting **Rinse Hold** (without final spin)).
- i** If a programme is interrupted at a high temperature, **Rinse/Freshen up** should be selected to cool down the washing.
- Press the **Start** button.
- Wait until programme ends.
- Turn the programme selector to **Off**.
- Open the washing machine door.
- Remove the washing.
- i** If a programme was interrupted at a high temperature, the washing machine door may remain locked until the appliance has cooled down.

# After washing

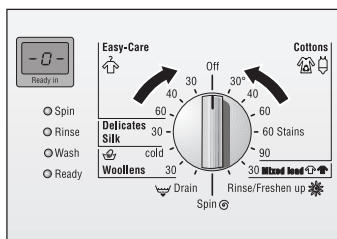

## Setting Rinse Hold (without final spin) selected

the programme duration is on **-0-**,

- Turn the programme selector to **Off**.

or

- i** the programme duration is on "----" and the **Spin** indicator light is on.

- Select an additional programme (**Drain** or **Spin**).
- Press the **Start** button.
- At the end of the additional programme turn the programme selector to **Off**.

- Turn off the water tap.

- Open the washing machine door.

## Removing the washing



If the loading door cannot be opened:

Wait 2 minutes (safety function is active)

or

there is still water in the washing machine if the **Rinse Hold** (Without final spin) option was selected.

Select the **Drain** or **Spin** programme and press the **Start** button.

- Unload the laundry.

### Attention

Remove any foreign objects (e.g. coins, paper clips) from the drum and rubber seal – **risk of rust!**

- Leave the washing machine door and detergent drawer open to allow the interior of the washing machine to dry.

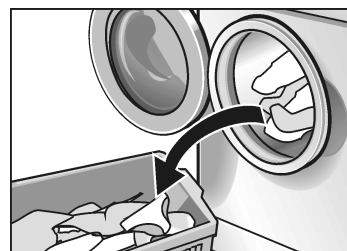

---

# Special applications

---

## Soaking

### Attention

Do not bleach/dye washing in the washing machine.

- Load laundry of the same colour.
- Pour soaking agent into dispenser **II** according to the manufacturer's instructions.
- Set the programme selector to **Cottons 30 °C**.
- Press the **Start** button.  
The programme starts.
- After approx. 10 minutes, turn the programme selector to **Off**. The laundry is left to lie in the water.
- Select a programme according to the required soaking time, the detergent solution is pumped out.

**i** Only little detergent to be dispensed for the main wash.

The laundry must not be treated with fabric softener.

- Insert the washing.
- Dose a quantity of starch for approx. 15 litres / 3.3 gal. of water. Dissolve starch according to the manufacturer's instructions.
- Turn the programme selector to **Rinse/Freshen up**.
- Set the spin speed;  
even setting **Rinse Hold** is possible.
- Press the **Start** button.

As soon as the water runs in:

- Pull out the detergent drawer a little and
- Pour starch solution into dispenser **I**.
- Close the detergent drawer.

If the **Rinse Hold** option was selected, then select **Drain** programme.

---

## Starching

---

# Cleaning and Care

## **⚠ Risk of electric shock!**

First, always disconnect the appliance from the power supply.

Never clean the washing machine with a water jet.

## **⚠ Risk of explosion!**

Never clean the appliance with solvents.

As required:

- Use hot soapy water or a mild, non-abrasive cleaning agent.
- Wipe dry with a soft cloth.

If metal items (e.g. coins, paper clips, needles, nails) left in the drum have caused rust spots:

- Use chlorine-free cleaning agents; comply with the manufacturer's instructions. Never use steel wool.

## **Attention**

Descaling agents contain acids which may corrode the components of the washing machine and discolour the washing.

Provided that you use the correct amount of detergent, it is not necessary to descale the washing machine.

If descaling is nevertheless required, please follow the instructions supplied by the manufacturer of the descaling agent.

---

## Clean housing, fascia and supply lines

---

## Cleaning the drum

---

## Descaling the washing machine

## Cleaning the detergent dispenser



- Pull out the detergent drawer all the way,
- Press down the insert and
- remove the detergent drawer.

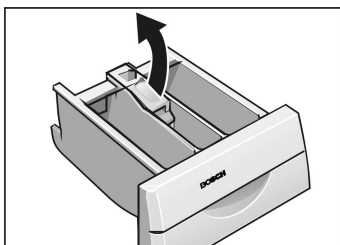

- Lift out the insert.
- Clean the detergent drawer and insert under running water and dry.

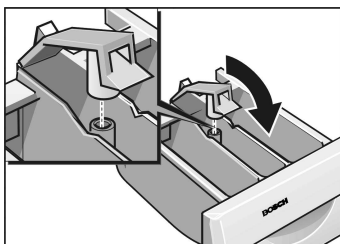

- Attach the insert and lock into position.
- Slide in the detergent drawer.

## Cleaning the drain pump

### Drain the water

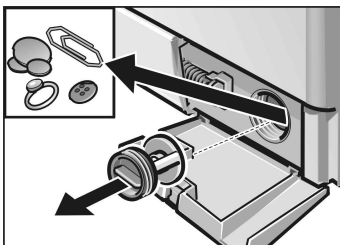
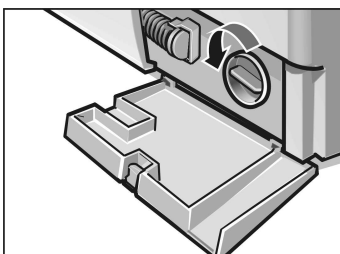
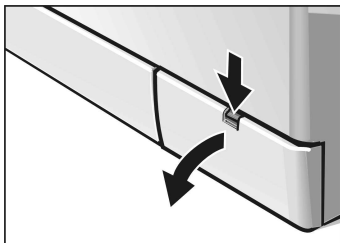

This is necessary if the washing solution has not been completely drained. The pump is blocked by either loose debris or fluff which accumulates if fluff-giving fabrics are washed.

(Up to 20 litres. Have a suitable container ready.)

### ⚠ Risk of scalding!

Allow the hot water to cool down beforehand. Keep children and pets away from the washing machine.

- Turn the programme selector to **Off**.
  - Open service flap and remove it.
  - Remove the drain hose from its holder and pull the hose out of the housing.
  - Pull down the closing cap **carefully** and allow the washing lye to flow into a suitable container.
  - Push up the closing cap and place the drain hose back in its holder.
  - Carefully remove the pump cap.  
A little more residual water will flow out.
  - Remove foreign objects/fluff from inside and clean the interior. The pump impeller wheel must be able to rotate.  
Clean any residual lye or fluff from the thread of the pump cap and pump housing.
  - Insert the pump cover and screw tight.
  - Insert and close the service flap.
- To prevent unused detergent from flowing into the drain during the next wash cycle:
- Pour 1 litre / 1 ¾ pt of water into chamber **II**.
  - Select the **Drain** programme.



## Cleaning water inlet strainers

This is necessary if very little or no water flows into the washing machine.

First release the water pressure in the supply hose:

- Turn off the water tap.
- Turn the programme selector to any programme (except **Spin** and **Drain**).
- Press the **Start** button, and allow the programme to run for approx. 40 seconds.
- Turn the programme selector to **Off**

### Cleaning the strainer at the water tap

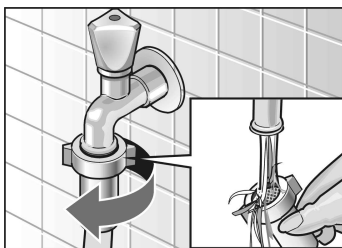

- Disconnect the hose from the water tap.
- Rinse the strainer under flowing water.
- Connect the hose.

### Cleaning the strainer on the washing machine

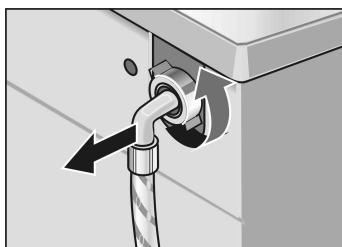

- Disconnect the hose from the back of the washing machine.

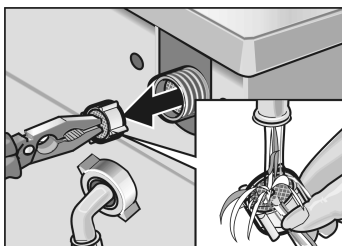

- Pull out the strainer and rinse under running water.
- Insert the strainer and reconnect the hose.
- Turn on the water tap and check whether water is still discharged. If water is still discharged, check that the strainer is attached properly.
- Turn off the water tap.

---

# Help with minor problems

If repairs are needed, and assuming that you cannot eliminate the fault yourself with the aid the following table

- Turn the programme selector to **Off**.
- Disconnect the washing machine from the mains.
- Turn off the tap.
- Call customer service, see Page 32.

**⚠ Risk of electric shock!**

Repairs may be carried out by customer service or authorised technicians only.

---

## Fault displays

Indicator light flashes and, depending on the model, a signal sounds	Possible cause	Remedial action
<b>Wash</b>	Door not closed properly.	Check whether laundry is trapped in door; Close the washing machine door.
	Tap not turned on.	Turn the tap on.
<b>Rinse</b>	Inlet hose kinked or pinched.	Eliminate cause.
	Filters blocked in water inlet hose.	Clean filters, see Page 25.
	Water pressure too low.	Eliminate cause.
<b>Spin</b>	Loose debris is blocking the pump.	Clean the pump, see Page 24.
	Drainage pipe and/or drainage hose blocked.	Clean drainage pipe and/or drainage hose.

<b>Problems</b>	<b>Cause</b>	<b>Remedial action</b>
Washing machine door cannot be opened.	There is still some water in the appliance, <b>Rinse Hold</b> selected.	Select <b>Drain</b> or <b>Spin</b> .
	Safety function is active.	Wait for 2 minutes.
Detergent residue in the detergent drawer.	Damp or lumpy detergent.	Clean and dry the detergent dispenser; see Page 23.
	Difficult-to-dissolve detergent tablets used.	Use the dosing aid for liquid detergent. Before filling dispenser <b>II</b> , crush the tablets in the packet.
Odour in the appliance.	Washing mainly at low temperatures and/or with liquid detergents.	Start <b>Cottons 90 °C</b> programme without washing. Use a standard detergent.
Control lights do not come on.	A fuse has triggered.	Switch on/replace the fuse. If the fault occurs repeatedly, call Customer Service.
	Power failure.	An interrupted programme will be resumed when the power returns. If you wish to unload the laundry, proceed as in <b>Cleaning the drain pump</b> , page 24.
	Plug is loose or not plugged in.	
Programme does not start.	Loading door not closed properly.	Check whether laundry is trapped in door. Close the loading door (a click should be heard).
	<b>Start</b> button not pressed.	Press the <b>Start</b> button.
Water does enter the machine or detergent is not washed away.	Tap not turned on.	Turn the tap on.
	Inlet hose kinked or pinched.	
	Filters blocked in water inlet hose.	Clean the strainers; see from Page 25.
Detergent in chamber <b>I</b> is not washed away.	A programme without Prewash was selected.	Select programme with Prewash.

<b>Problems</b>	<b>Cause</b>	<b>Remedial action</b>
Water not visible in the drum.	Not a fault. The water lies below the visible part of the drum.	
Washing solution is not completely drained.	Pumped blocked by foreign objects.	Clean the pump refer to page 24.
	Fluff-producing laundry was washed. The water drainage pipe or drain hose is blocked.	Clean drainage pipe and/or drainage hose.
Water runs out from under the appliance.	Screw fitting of the inlet hose is leaking.	Tighten the screw-fitting.
	Drainage hose is leaking.	Replace the drain hose.
Foam comes out of the detergent drawer.	Too much detergent or detergent not suitable for use in washing machines used.	Mix 1 tablespoon of fabric softener with ½ litre pt of water and pour into chamber <b>II</b> of the detergent dispenser.
		Reduce detergent dosage for next wash cycle or use detergent which is suitable for use in washing machines.
Vibrations during wash and spin cycles	Transit bolts not removed	Remove the transit bolts; see page 38.
	Appliance feet not secured.	Secure the appliance feet.
The washing has not been spun correctly.	Large laundry items have become entangled and are not evenly distributed in the drum. For safety reasons, the high-speed final spin cycle was automatically cancelled.	Do not put only large items in the drum.
Spin result unsatisfactory.	<b>Reduced Ironing</b> button pressed – for reduced spin speed see page 14.	
	The <b>Rinse/Freshen up</b> or <b>Spin</b> programme selected maximum spin speed: see Page 13.	
Spin cycle actuated several times.	Not a fault. Unbalanced load detection system is attempting to compensate the imbalance by spinning the washing several times.	

<b>Problems</b>	<b>Cause</b>	<b>Remedial action</b>
The programme takes longer than usual.	Not a fault. Imbalance compensation system attempts to balance the laundry by repeated distribution.	Wash large and small items together in order to reduce the imbalance.
	The foam detection feature has activated an additional rinsing cycle to reduce the amount of foam.	Adjust the detergent dosage for the next wash cycle.
Washing result not satisfactory.	Soiling is greater than expected or recommended load has been exceeded.	Select suitable programme and press the <b>Wash Plus</b> button or reduce load.
	Detergent was underdosed.	Dose detergent according to the manufacturer's instructions.
Detergent residue on the washing.	Some phosphate-free detergents contain water-insoluble residue which may appear as light stains on the washing.	Select <b>Rinse/Freshen up</b> immediately or brush out the washing after drying.
Grey residue on the washing.	Soiling caused by ointment, grease or oil.	Select maximum detergent dosage and maximum permitted temperature for the next wash cycle.
Changes in the <b>Ready In</b> while the programme is running	Not a fault. See also explanations under <b>Ready In display</b> , see from page 16.	
Reduction in the remaining time	Not a fault. For small amounts of laundry, a reduction in time of approx. 20 minutes can result, depending on washing programme.	

Problems	Cause	Remedial action
Increase in the remaining time	In the case of excessive foam, the foam detection system has activated an additional rinse cycle and an additional spin cycle to ensure the rinsing result.	Reduce the detergent dosage for the next wash cycle.
	For severe imbalances during spinning, an increase in time of approx. 10 minutes can occur because of repeated distribution of the laundry.	Wash large and small items together in order to reduce the imbalance.
	If very cold water must be heated up, an increase in time up to 20 minutes can result.	
Signal is emitted	Signal for switching buttons on and off is switched on.	Switch off the signal: Press the <b>Start</b> button and set the programme selector to <b>Cottons 30 °C</b> . Hold down the <b>Start</b> button until the signal is emitted. Acoustic signal is switched off.
	Signal for programme status is switched on.	Switch off signal or change volume: Press the <b>Wash Plus</b> button and hold down until the signal is emitted and the volume of the signal changes. Release the button when the required volume is reached. The selected setting is stored.

If the fault recurs, call Customer Service, see Page 32.

# Consumption values

Normal programme	Additional option	Load	Consumption values **		
			Power	Water	Programme duration
Cottons 40 °C	Wash Plus *	6 kg/13.2 lb	0.65 kWh	60 l	2:10 h
Cottons 60 °C	–	5 kg/11 lb	0.95 kWh	60 l	1:17 h
Cottons 60 °C	Aqua Plus	5 kg/11 lb	1,2 kWh	75 l	1:29 h
Cottons 60 °C Stains	Wash Plus *	6 kg/13.2 lb	1.02 kWh	49 l	2:15 h
Cottons 90 °C (the hot washing solution is mixed with approx. 7 litres of cold water before being drained)	Wash Plus	6 kg/13.2 lb	2.1 kWh	67 l	2:10 h
Easy-Care 40 °C	Wash Plus *	3 kg/6.6 lb	0.5 kWh	50 l	1:18 h
Easy-Care 40 °C (Also suitable as short programme)	–	3 kg/6.6 lb	0.5 kWh	38 l	0:47 h
Easy-Care 40 °C	Aqua Plus	3 kg/6.6 lb	0,6 kWh	53 l	0:58 h
Delicates/Silk 30 °C	–	2 kg/4.4 lb	0.3 kWh	42 l	0:35 h
Delicates/Silk 30 °C	Aqua Plus	2 kg/4.4 lb	0,35kWh	57 l	0:45 h
Woollens 30 °C	Wash Plus *	2 kg/4.4 lb	0.2 kWh	35 l	0:50 h

\* Programme setting with **Wash Plus** option for test in accordance or in conformity with EN 60 456 and IEC 60 456.

\*\* Consumption values will differ from the indicated values depending on the water pressure, water hardness, water inlet temperature, ambient temperature, type and quantity of washing and degree of soiling, utilised detergent, fluctuations in the mains voltage and selected additional options.

# Customer service

Each washing machine which leaves our factory is checked carefully to ensure that it functions properly and is in perfect condition. If you have any questions – especially with respect to installing and connecting your washing machine – please do not hesitate to contact our customer service department.

Before you call customer service, please check whether you can eliminate the fault yourself (see from Page 26).

A technician who is called out to give advice will charge you, even if the appliance is still under guarantee.

You can find your nearest customer service in the enclosed address list. Please provide customer service with the product number (E-Nr.) and the production number (FD) of the appliance.

Rating plate

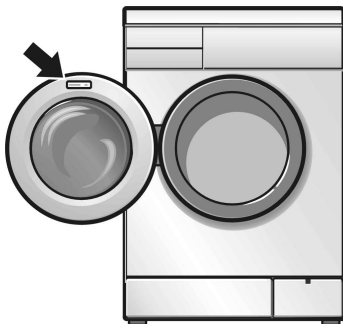

These numbers are shown on the rating plate which can be found on the frame of the open door and also on the identification plate, enclosed by a thick line, on the front of the machine behind the nameplate.

E-Nr. _____	FD _____
-------------	----------

**Product number**

**Production number**

Please note the two numbers in the space provided above.

In specifying the product number and production number of your appliance, you help us in our attempt to prevent unnecessary travelling and the associated extra costs.

Further information and a selection of our products can be found on our Internet page:  
<http://www.bosch-hausgeraete.de>



If you have any problems with your appliance during the manufacturer's guarantee,

Please call:

**08702 413381**

(Customers in **Ireland** should call **018903 22222**)

---

# Installing, connecting and transporting the appliance

---

## Safety instructions

### **⚠ Risk of injury!**

The washing machine is very heavy. Take care when lifting it.

### **Attention**

Frozen hoses may tear/burst. Do not install the washing machine in an area where there is a risk of frost or outdoors.

The washing machine may be damaged. Do not lift the washing machine by its projecting parts (e.g. door).

In addition to the safety information listed here, the local water and electricity supplier may have special requirements.

If in doubt, have the appliance connected by a specialist.

---

## Packaging and old appliances

Unpack the appliance and dispose of the packaging in an environmentally-responsible manner.

This appliance is labelled in accordance with European Directive 2002/96/EC concerning used electrical and electronic appliances (waste electrical and electronic equipment - WEEE).



The guideline determines the framework for the return and recycling of used appliances as applicable throughout the EU.

## Standard accessories

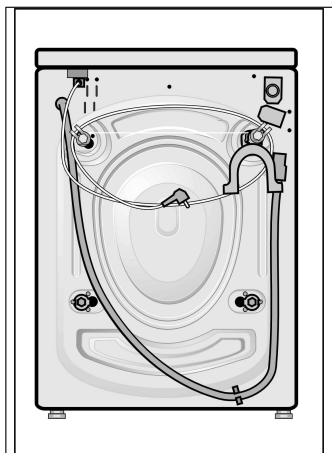
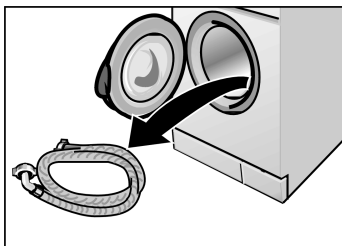

Inside the drum:

- Water-inlet hose.

On the rear of the appliance:

- Water drainage hose.
- Elbow for attaching the drainage hose e.g. to the sink,
- Mains cable with plug.

Moisture in the drum is due to the final inspection which every washing machine undergoes before it leaves the factory.

Depending on the connection situation, the following part is also required:

- 1 hose clip Ø 24–40 mm (DIY store) is also required for connection to a siphon.

The bag contains:

- Covers for holes left by removing the transport bolts.

## Useful tools

The following tools are helpful:

- Box wrench A/F 13 for removing the transportation bolts,
- Spirit level for aligning the washing machine.

---

## Dimensions

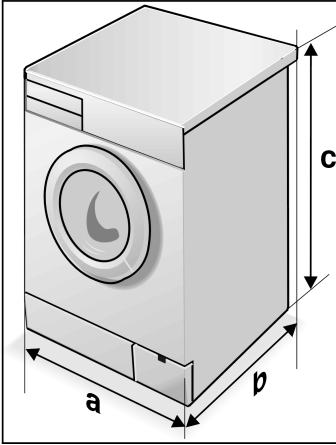

**a** = 600 mm

**b** = 590 mm

**c** = 852 mm

Weight 69–83 kg (depending on appliance)

---

## Installation surface

Appliance stability is important so that the washing machine does not "wander" during the spin cycles.

The installation surface must be solid and level. Soft floor coverings, e.g. carpets or floor coverings with a foam backing are not suitable.

If the washing machine is to be installed on a wooden floor:

- If possible, install the washing machine in a corner.
- Screw a water-resistant wooden board (at least 30 mm thick) to the floor.
- Secure the washing machine feet with fixing brackets\*.

If the washing machine is to be installed on a base:

- Secure the washing machine feet with fixing brackets\*.

\* Holding brackets (set) can be obtained from a specialist store or the Customer Service, order no. WMZ 2200.

---

## Built-under or built-in appliance installation

The appliance must be built under or built in prior to connecting the power supply.

The appliance can be built into or under a kitchen work surface. For this purpose, a recess width of 60 cm is required.

- ❑ The washing machine must only be installed under a one-piece worktop that is permanently attached to the surrounding cabinets.

### Attention

For safety reasons in built-under installation, a metal cover\* must be assembled by a specialist in place of the appliance cover plate.

- \* The metal cover (set) can be obtained from a specialist store or the Customer Service, order no. WMZ 2420.

## Removing the transport bolts

### Caution

The transport bolts must always be removed before using the appliance for the first time and must be retained for any subsequent transport (e.g. when moving).

Before removing the transport bolts:

- Take the hose out of the holder.
- Detach the elbow.
- Release all four transport bolts using the SW 13 wrench until they can be moved freely.
- Completely remove transport bolts by reaching through the open washing machine door and pulling the drum forwards slightly.

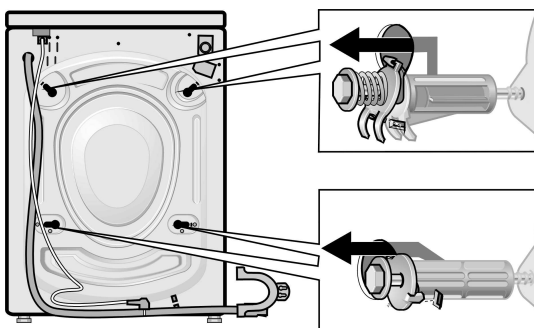

- Insert the covers.

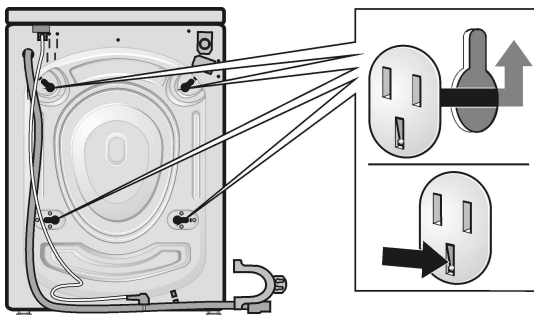

## Storing the transport bolts

Always keep the transport bolts for subsequent transportation of the appliance (e.g. when moving house).

- Store the transport bolts with washer and bush (and spring) attached.

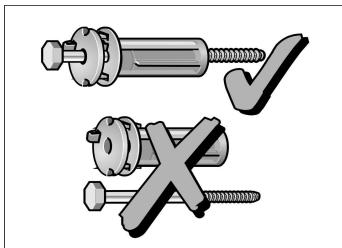

# Hose and cable lengths

## Left-hand connection

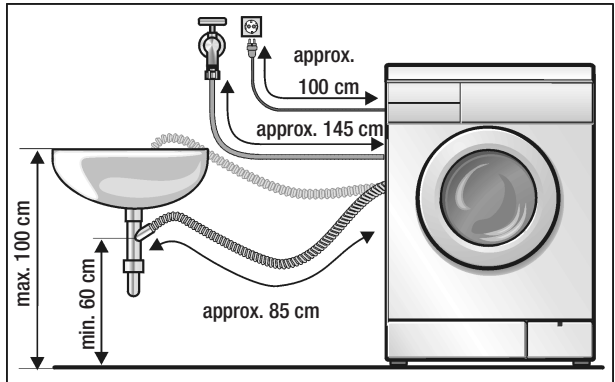

## Right-hand connection

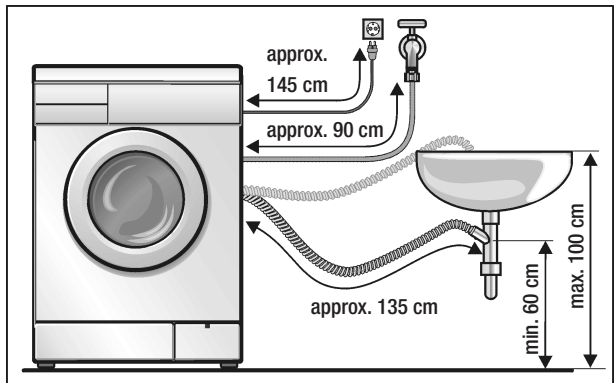

## Other hoses

Available from specialist dealers:

- Connecting kit with plastic hose (approx. 2.50 m), order no. WMZ 2380).
- Extended supply hose (approx. 2.20 m).



# Connecting the water

## Water supply

To prevent leaks or water damage, it is essential to follow the instructions in this chapter!

### Caution

Operate the washing machine with cold drinking water only. Do not connect the appliance to the mixer tap of an unpressurized hot-water boiler.

If in any doubt, have the water connection carried out by an authorized technician.

The water supply hose must not be:

- Bent or squashed.
- Modified or cut through (stability can no longer be guaranteed).

Plastic threads must only be tightened by hand. Do not remove the strainers from the water supply hose.

Observe the water pressure in the supply network:

- The water pressure should be between 1 and 10 bars (when the tap is turned on, at least 8 litres of water is discharged per minute).
- A pressure reducing valve must be installed if the maximum water pressure is exceeded.

Connect the water supply hose.

to the rear panel of the washing machine and ...

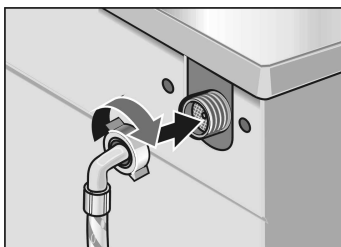

to the tap.

Subsequent to connection:

Turn on the water tap completely, and check connection points for water-tightness.

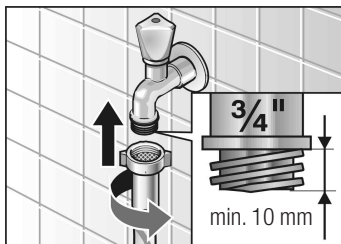

## Water drainage

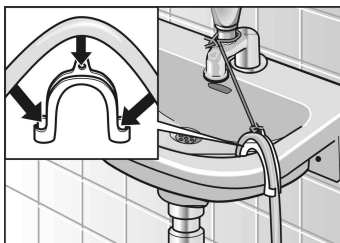
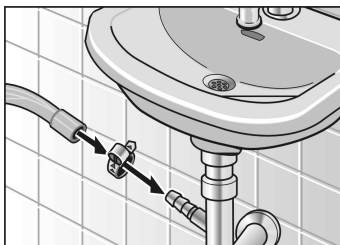

### Caution

Do not bend or pull the water drainage hose.

Height difference between the placement area and drainage point: minimum 60 cm, maximum 100 cm.

Drainage into a siphon:

- ❑ Secure the connection point with a hose band clip of 24–40 mm diameter (from specialist stores).

Drainage into a wash basin:

### Caution

The plug must not block the drain of the wash basin.

- ❑ Secure the water drainage hose so that it does not slide out.
- ❑ When water is being drained, check that the water flow is fast enough.

## Aligning the washing machine

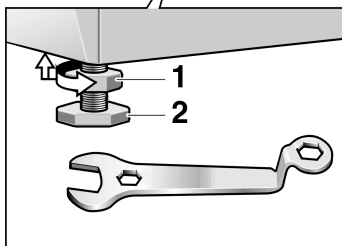
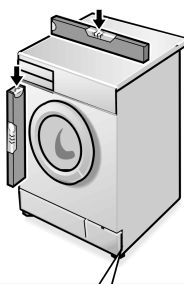

Level the washing machine with the assistance of the four adjustable feet and a spirit level:

- ❑ Loosen the lock nut **1** using the wrench.
- ❑ Adjust the height by rotating the foot **2**.
- ❑ Tighten the lock nut **1** against the housing. Simultaneously hold the foot in place and do not adjust the height.

All four feet must be firmly on the floor. The washing machine must not wobble.

The lock nuts of all four appliance feet must be screwed tightly against the housing!

### Attention

Loud noise generation, vibrations and "wandering" may be due to incorrect alignment!

---

## Connecting the power

### Attention

Connect the washing machine only to an alternating current via a correctly installed earthed socket.

The mains voltage must correspond to the voltage specification on the washing machine (nameplate). Connection specifications as well as the required fuses are stipulated on the appliance nameplate.

Ensure that:

- The mains plug and socket are compatible.
- The cable cross-section is adequate.
- The earthing system has been installed correctly.

The mains cable may be changed (if required) by an electrician only.

Replacement mains cable available from customer service.

Do not use multiple plugs/sockets or extension cables.

In the event that an earth-leakage circuit breaker is to be used, only use types marked with the following symbol: .

Only this symbol can guarantee compliance with all current regulations.

Do not insert/pull out the mains plug with wet hands.

Do not pull out the mains plug by tugging the cable.

## Transport, e.g. when moving

Before transporting the washing machine:

- Turn off the water tap.
- Drain any residual washing solution (refer to Page 24).
- Release the water pressure in the supply hose (refer to Page 25).
- Disconnect the washing machine from the mains.
- Dismantle the supply and drainage hoses.
- Reinstall the transport bolts.

Having transported the appliance and ensured proper installation and connection, allow the **Drain** programme to run through before starting the first wash programme.

## Preparing and inserting the transport bolts

- Remove the covers.
- Preparing the transport bolts:  
Pull the bolt out of the sleeve until the end of the bolt is flush with the end of the sleeve.
- Insert and tighten the transport bolts.  
The lug on the washer must be located in the groove in the rear panel of the housing.

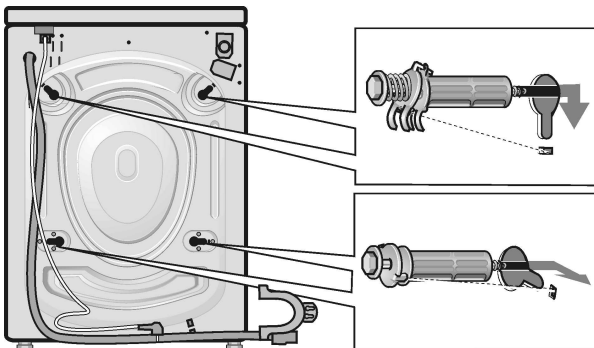

---

# Index

## A

- Adding detergent, 10
- Additional options, 5
  - Aqua Plus, 5, 14
  - Prewash, 5, 14
  - Reduced Ironing, 5, 14
  - Wash Plus, 5, 15
- Additional options – buttons, 14
- Aligning the washing machine, 42

## B

- Basic programmes, 11
- Built-in, 37
- Built-under, 37

## C

- Cancelling active programme, 19
- Changing the programme sequence, 19
- Cleaning and care, 22
  - Control panel, 22
  - Detergent drawer, 23
  - Drain pump, 24
  - Drum, 22
  - Housing, 22
  - Strainers, 25
  - Supply lines, 22
- Closing cap, 24
- Connecting the power, 43
- Connecting the water, 41
- Consumption values, 31
- Control panel, 5
- Cottons, 11
  - Stains, 11
- Cover plate, 37
- Customer service, 32

## D

- Degrees of dirt, 8
- Delicates, 12
- Descaling, 22
- Dimensions, 36
- Display, Ready in, 5
- Dosing detergent, 10
- Drain, 12

## E

- Easy-Care, 11
- End of the programme, 20

## F

- Fault display, 26
- Functions, 11

## H

- Holding bracket, 36
- Hose and-cable lengths, 40

## I

- Indicator lights, 5
  - Ready, 5
  - Rinse, 5
  - Spin, 5
  - Wash, 5
- Insert transportation protection devices, 44
- Installation surface, 36
- Internet, 32

## L

- Loading the washing, 7, 9

## M

- Mixed load, 11

## N

- No final spin, 13

## O

- Old appliances, 34
- Other hoses, 40

## P

- Packaging, 34
- Preparing the washing, 7
- Problems, 26
- Product number, 32
- Production number, 32
- Programme, 11
- Programme duration, 16, 31
- Programme options, 12
- Programme selector, 5, 11
- Pump cap, 24

## R

- Rating plate, 32
- Ready In display, 16
- Removing stains, 8
- Removing the washing, 20
- Rinse/Freshen up, 12

## S



















- Safety instructions, 34
- Service flap, 24
- Silk, 12
- Soaking, 21
- Sorting the washing, 7
- Spin, 12
- Spin speed selector, 5, 13
- Standard accessories, 35
- Starching, 21
- Start button, 5
- Start programme, 18
- Storing the transportation protection devices, 39

## T

- Take out the drain hose., 24
- Tools, 35
- Transporting the washing machine, 44

## W

- Washing, 18
- Woollens, 12

Programmes <sup>1)2)</sup> Type of laundry	Amount of laundry	Degree of soiling	Required button, additional function
<b>Cottons</b>      Hard-wearing textiles, heat-resistant textiles e.g. cotton or linen			
<b>30, 40 <sup>3)</sup>, 60 °C</b>	6 kg	light to normal	Wash Plus
<b>60 °C Stains <sup>3)</sup></b>		normally with stains	Wash Plus
<b>90 °C</b>		normal	Wash Plus
<b>30, 40, 60 °C</b>	up to 5 kg	light	–
<b>30, 40, 60 °C</b>		normal to heavy	Wash Plus
<b>60 °C Stains</b>		normally to heavily with stains	Wash Plus
<b>Easy-Care</b>    Easy-Care textiles e.g. cotton, linen, synthetic materials or blended fabrics (also suitable as a <b>short programme</b> )			
<b>30, 40, 60 °C</b>	up to 3 kg	light	–
<b>30, 40 <sup>3)</sup>, 60 °C</b>		normal to heavy	Wash Plus
<b>Mixed load</b>   For cotton washing and easy-care textiles – different types of washing can be washed together			
<b>30 °C</b>	up to 3 kg	light	–
<b>30 °C</b>		normal to heavy	Wash Plus
<b>Delicates/Silk</b>     Delicate, washable textiles, e.g. silk, satin, synthetic or blended fabrics without wool component (e.g. curtains)			
<b>30 °C</b>	up to 2 kg	light	–
<b>30 °C</b>		normal to heavy	Wash Plus
<b>Woollens</b>      hand and machine washable wool or wool rich textiles, e.g. cashmere, mohair or angora. Also suited for hand washable silk.			
<b>cold, 30 °C</b>	up to 2 kg	light	–
<b>cold, 30 °C <sup>3)</sup></b>		normal to heavy	Wash Plus
<b>Programme options</b>	<b>Rinse/Freshen up, Spin, Drain</b>		

- 1) You can change the programme with the following settings:  
 In the display panel: **Spin speeds** or "----"(no final spin).  
 Additional functions/Buttons: **Prewash, Reduced Ironing, Aqua Plus, Wash Plus.**
- 2) Pour detergent into dispenser **II** (on left) for programme without prewash;  
 distribute detergent between dispensers **I** and **II** for programmes with prewash.
- 3) Programme setting for test in accordance or in conformity with EN 60456 and IEC 60456.

# Quick-reference instructions

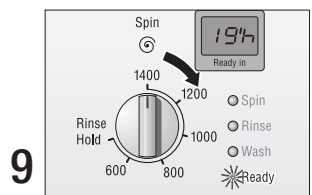
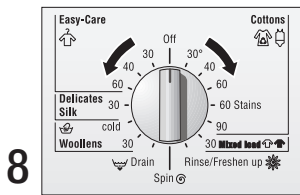
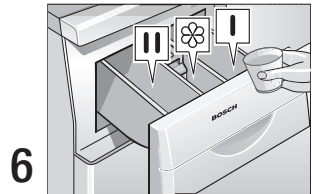
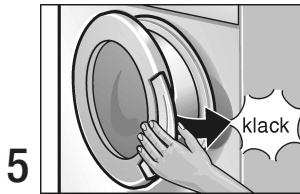
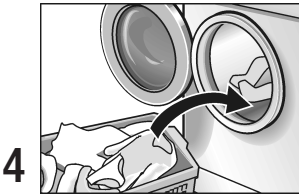
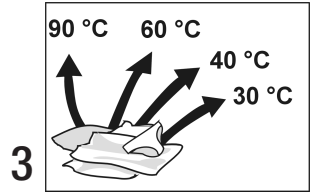
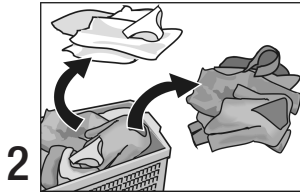
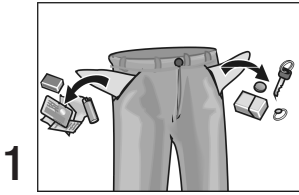

If required:

If required:

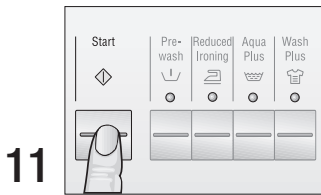

## At the end of the programme:

