



BOSCH



Register your
new device on
MyBosch now and
get free benefits:
[bosch-home.com/
welcome](https://www.bosch-home.com/welcome)

Juicer Mixer Grinder

MJ44

MJ87

[en] Information for Use



<https://digitalguide.bsh-group.com?mat-no=8001299889>



[en] Scan the QR code or visit the website to open the Further Notices for Use. You can find additional information about your appliance or accessory here.

Safety

- Read this instruction manual carefully.
- Keep the instruction manual and the product information safe for future reference or for the next owner.

The appliance is intended to be used by one person.

Only use this appliance:

- with original parts and accessories. Never use these parts and accessories for other appliances. Damage caused by using third-party products is not covered under the warranty.
- for normal processing quantities and for normal processing times for domestic use.
- under supervision.
- in private households and in enclosed spaces in a domestic environment at room temperature.
- up to an altitude of max. 2000 m above sea level.

The appliance must always be disconnected from the mains after each use, whenever it is left unattended, prior to assembly, disassembly or cleaning and in the event of an error.

This appliance can be used by persons with reduced physical, sensory or mental capabilities or a lack of experience and/or knowledge if they have been given supervision or instruction concerning use of the appliance in a safe way and if they understand the hazards involved.

Do not let children play with the appliance.

Cleaning and user maintenance must not be performed by children.

The appliance must not be used by children. Keep children away from the appliance and power cord.

- ▶ Connect and operate the appliance only in accordance with the specifications on the rating plate.
- ▶ Never let the power cord come into contact with hot parts or be dragged over sharp edges.
- ▶ Never operate a damaged appliance.
- ▶ If the appliance or the power cord is damaged, immediately unplug the power cord or switch off the fuse in the fuse box.
- ▶ Repairs to the appliance should only be carried out by trained specialist staff.

en

- ▶ If the power cord of this appliance is damaged, it must be replaced by the manufacturer, or the manufacturer's Customer Service in order to prevent any risk.
- ▶ Never immerse the appliance or the power cord in water or clean in the dishwasher.
- ▶ Never use the appliance on or near hot gas burners, electric hot-plates or similar appliances.
- ▶ If the motor stalls or smoke emanates from the appliance, switch off the appliance and unplug it. Call customer service.
- ▶ Only attach or remove the jar or accessories once the speed selector knob is in the OFF position the drive has stopped and the appliance is unplugged.
- ▶ Never leave the appliance switched on if the power supply is interrupted. The appliance will automatically start up again following the interruption in the power supply.
- ▶ Never operate the appliance without fitting the lid or with an empty jar.
- ▶ Do not open the lid when the appliance is running.
- ▶ Do not add solid ingredients when the appliance is running.
- ▶ Always unplug the appliance before reaching into the jar with your fingers or any other object, e. g. a spatula.
- ▶ Only use the appliance once it is fully assembled.
- ▶ Never place the PBJ socket onto the main unit without the PBJ fitted.
- ▶ After switching off, wait until the drive has come to a complete standstill.
- ▶ Check the appliance, the sieve and the Juicer body for damage before each use.
- ▶ Care should be taken when handling sharp blades, emptying the jar and during cleaning.
- ▶ Never touch the blades or the cutter teeth on the bottom of the sieve with bare hands.
- ▶ Do not use your fingers or a spatula to push the fruit and vegetables into the feeding chute.
- ▶ Only use the pusher to push down ingredients.
- ▶ Do not process hot ingredients.

- ▶ Jars may heat up due to friction so never touch the metal part with bare hands immediately after grinding.

Avoiding material damage

- ▶ Do not process sugar or similar ingredients with the appliance.
- ▶ Do not overload the appliance.
- ▶ Do not use the jar as a storage container.
- ▶ Do not use the appliance on a wet surface.
- ▶ Do not drop the main unit or jar.

Model table

								
MJ4412A1KI	750 W	✓	✓			✓		
MJ4412A1GI	750 W	✓	✓			✓		
MJ4413A1GI	750 W	✓	✓			✓	✓	
MJ4413A2KI	750 W	✓	✓			✓		✓
MJ8720A1KI	1000 W	✓						
MJ8722A1KI	1000 W	✓	✓	✓				
MJ8723A1KI	1000 W	✓	✓	✓			✓	

Overview

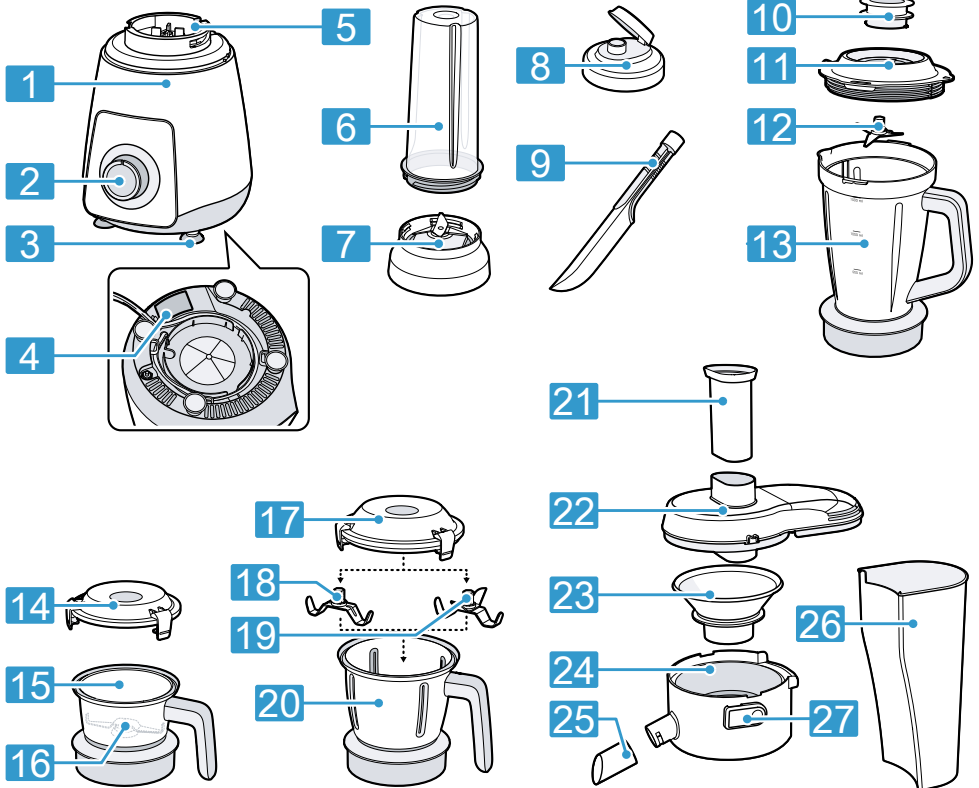

1	Main unit	14	Chutney jar lid
2	Rotary switch	15	Small jar (Chutney jar)
3	Rubber feet	16	Chutney blade
4	Rating plate	17	Medium jar lid
5	Motor Coupler	18	Dry grinding blade
6	Personal blender jar (PBJ)	19	Pounding blade
7	PBJ socket	20	Medium jar (Multipurpose jar)
8	Personal blender jar cap	21	Pusher
9	Spatula	22	Juicer cover
10	Blender jar lid stopper	23	Sieve
11	Blender jar lid	24	Juicer body
12	Blender jar blade	25	Spout cover
13	Blender jar	26	Pulp chamber

27 Juicer lock

Blade overview

Blade	Jar	Application
Chutney blade	Small	Ginger garlic paste, coconut chutney, coriander chutney
Dry grinding blade	Medium	Turmeric, coriander seed, black pepper, cumin, red chilli powder, almonds, rice powder
Pounding blade	Medium	Sambhar masala, garam masala, rasam powder, puliyodharai masala, idli podi
Blender jar blade	Blender	Chikoo milkshake, banana milkshake, soya milk, pomegranate juice, watermelon juice, orange juice, sweet lime juice, coconut milk extraction, tamarind juice
PBJ Blade	PBJ	Smoothie

Jar capacity

When using the jars follow the capacities in the table. Minimum capacity for all the jars is at least up to blade level.

Jar	Size	Rated capacity			
		Dry	Wet	Liquidise	Chutney
Medium jar	1.0 litre	0.5 litre	0.5 litre		
Small jar	0.6 litre	0.2 litre	0.2 litre		0.2 litre
Blender jar	1.5 litre			1.0 litre	
Personal blender jar	0.7 litre			0.46 litre	

Rotary switch

The rotary switch is used to start and stop processing and select the speed.

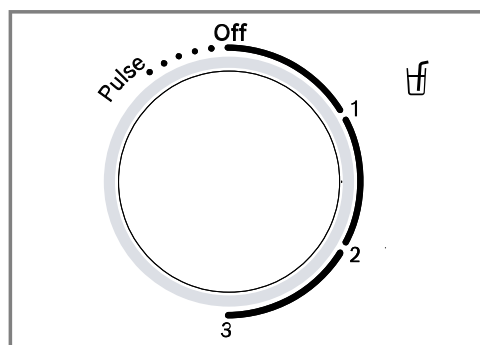

Symbol	Function
Off	Stop processing.
1 	Process ingredients at low speed. Juicer operation has to be done in speed 1.
3	Process ingredients at maximum speed.
Pulse	Process ingredients briefly at low speed until the rotary switch is released. To blend, liquefy and purée.

Notes

- Use position 1-3 for continuous operation. Position 1 is the slowest operating speed. Position 3 is the fastest operating speed.
- The Pulse function is especially suitable for chopping food for chutneys.

Overload protection

The appliance is equipped with an overload protection device. The overload protection device prevents the motor from being damaged by overloading.

Resetting overload protection

Note

In the following cases, the overload protection device will activate and the red button on the underside will pop out:

- If the jar is overfilled with ingredients.
 - If the jar is filled with a very thick paste.
 - If there is an undervoltage on the appliance.
1. Switch off the appliance and remove the excess ingredients.
If the paste is too thick in the jar, add enough water and wait 2 to 3 minutes.
 2. Press the red reset button and start the appliance again.

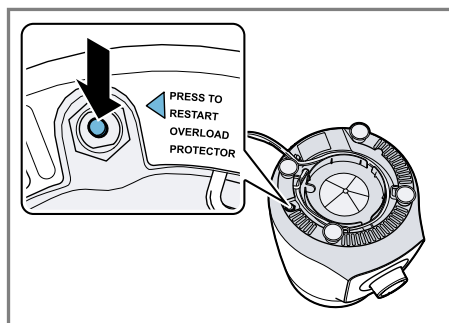

Before using for the first time or using after a long time

Before using the appliance for the first time or using it after a long time, clean all parts that come into contact with food ingredients thoroughly.

Preparing the appliance and parts

- ▶ Never place plastic, paper or cloths under the appliance as they may block the ventilation openings.
1. Place the appliance on a stable, level, clean and flat work surface.
 2. Ensure that the rotary switch is set to Off.
 3. Rotate the motor shaft by hand via the motor coupler on top of the main appliance.
The motor shaft should rotate freely.

Using jars

Preparing food

1. Cut up large items of food into chunks of approx. 2 cm.
2. Allow hot ingredients to cool down before pouring them into the jar.

Place the Jar on the main unit

1. Carefully place the jar on the main unit.
 - Ensure that the jar's latches sit correctly in the notches of the base unit.
2. Rotate the jar clockwise until it locks and use the handle to lock.

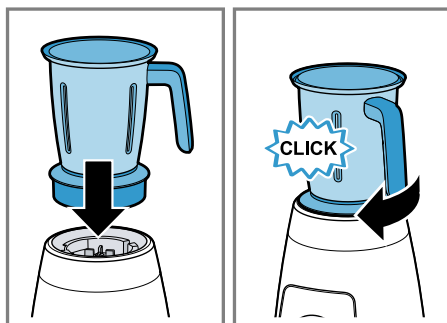

Processing food

Notes

- You may observe some minor oil spillage in the jar and jar sockets during the first two to three operations. This is normal. Clean smaller oil leaks thoroughly with water and dry the jars with a soft cloth.

- Do not fill or empty the jars with your hands. It is safer and more hygienic to use the spatula.
- Do not store food in the jars.
- Do not allow the appliance to run continuously for longer than 5 minutes. Wait 2 minutes before continuing to use the appliance.
- The recommended time for grinding dry ingredients is max. 2 minutes. If you need finer powder, wait 2 minutes and grind again.

1. Fill the jar with the prepared food.
2. Check that the lid seal is positioned correctly.
3. Place the lid on the jar and press down.
4. Hold the lid gently during use.
5. Insert the mains plug.
6. Set the rotary switch to the required position and speed.
7. After use, set the rotary switch to Off and check the contents.
8. Repeat until the desired results are obtained.
9. After switching off the appliance, wait until the blade stops rotating.
10. Pull out the mains plug.
11. Turn the jar anti-clockwise and remove it from the main unit.

Using the personal blender jar

1. Add the food to the PBJ.
Do not exceed the **max** marking on the PBJ.

2. Make sure the PBJ socket is clean and the seal is properly seated matching with the slot.

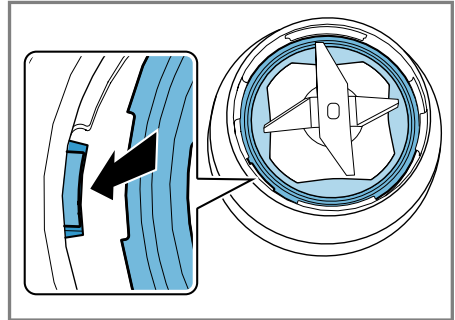

3. Place the PBJ socket on the PBJ and rotate clockwise until they are both securely connected.

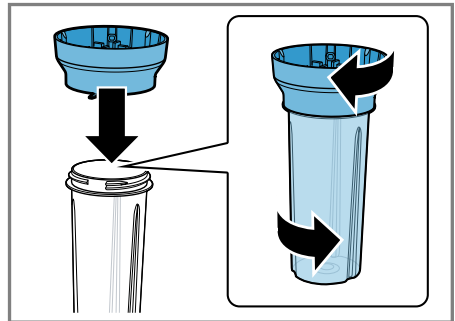

Never place the PBJ socket onto the main unit without the PBJ fitted.

- ✓ The ▼ and 🔒 markings must match up.
4. Turn the PBJ upside down and place it on the main unit.
 5. Turn the PBJ clockwise until it engages.

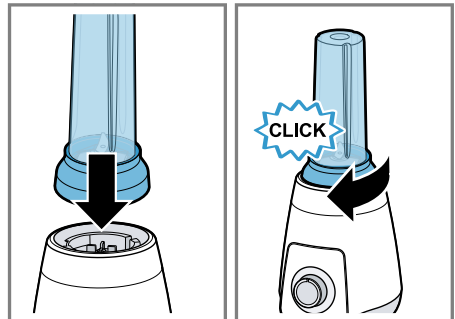

en

- Turn the rotary switch on the main unit. Process the ingredients until you achieve the required result.
- After switching off the appliance, wait until the blade stops rotating.
- Turn the PBJ anti-clockwise and remove it from the main unit.
- Turn the PBJ over and remove the PBJ socket.
- Fit the cap.

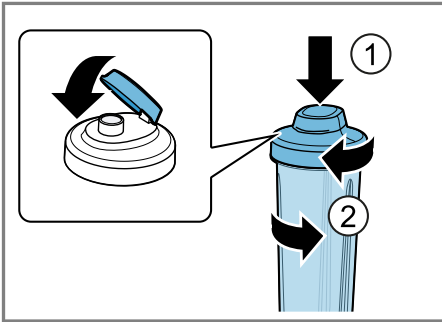

Note: When using the Personal blender jar cap, ensure that the seal is inserted.

Using the juicer

The appliance is suitable for juicing fruit (e.g. apples, pineapples, watermelons) and vegetables (e.g. tomatoes, carrots). Do not process particularly hard, fibrous or starchy fruit and vegetables (e.g. sugar cane, bananas, papayas, avocados, mangos, cheeku, amla, aloe vera, wheatgrass).

Tips

- Do not process unripe fruit/vegetables, otherwise the sieve will become clogged too quickly.
- Do not process any frozen food
- Before processing, remove the hard components (e.g. seeds, stalks and peels), otherwise the sieve may get damaged.
- Juice soft fruit/vegetables (e.g. oranges) before hard fruit/vegetables (e.g. apples).

- Peel fruit/vegetables beforehand if it has thick and hard peel, (e.g. pineapples, melons, oranges, grapefruits and raw beetroot).
- Cut fruit/vegetables into small pieces so that they fit through the feeding chute.
- With watery fruits (e.g. watermelons) it is normal for some juice to come out of the sides of the juicer. This is due to the nature of the fruit.

Assembling the juicer

- Carefully place the juicer body onto the main unit.
 - Ensure that the juicer body's latches sit correctly in the notches of the base unit.
- Turn the juicer body clockwise and click it into place.
- Note:** Do not reach into the cutter teeth on the bottom of the sieve. Hold the sieve with both hands on the side of the frame and place it onto the motor coupler.

Note

It is important to press the sieve down with both hands until it is firmly in place.

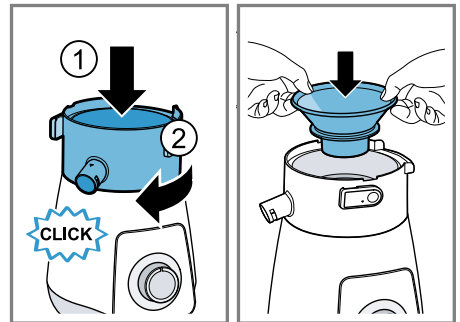

4. Slightly tilt the pulp chamber and clip it into the juicer body from below.

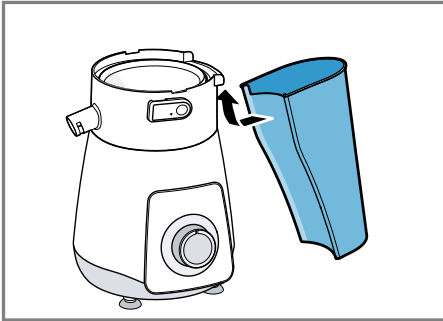

There must be no visible gap between the pulp chamber and the juicer body.

5. Place the juicer cover onto the juicer body. Position the feeding chute above the sieve when you do this.
6. To secure the juicer cover, turn the locks upwards and lock them into place.

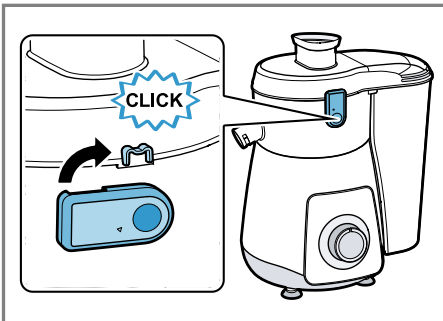

7. Push the spout cover onto the spout. In doing so, align the latch above the spout guide.

8. Turn the spout cover anticlockwise in the guide and click it into place.

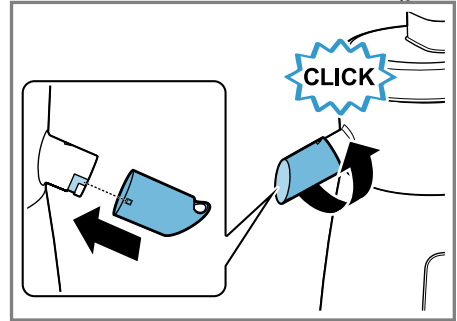

- ✓ The ▼ and ▲ markings must match up.
9. To collect the juice, place a container below the spout.

Using the juicer

Notes

- Do not allow the appliance to run continuously for longer than 5 minutes. Wait 2 minutes before continuing to use the appliance.
- It's normal to feel an initial jerk when turning on the appliance.

1. Insert the mains plug.
2. Turn the rotary switch to setting 1.
3. Place the fruit/vegetables in the feeding chute.

Lightly press on the pusher in order to push the fruit/vegetables through the feeding chute.

4. After switching off the appliance, wait until the motor comes to a standstill.
5. Pull out the mains plug.
6. Turn the spout cover clockwise into the upper position so that no juice can drip out.

Tips

- In case of pulp depositing on the juicer cover, please clean it before further juicing for best results.
- We recommend that you drink the juice immediately after it is prepared.

en

- After approximately three to four glasses of juice, clean the sieve and remove the pulp so that as much juice as possible can be extracted.

Disassembling the juicer







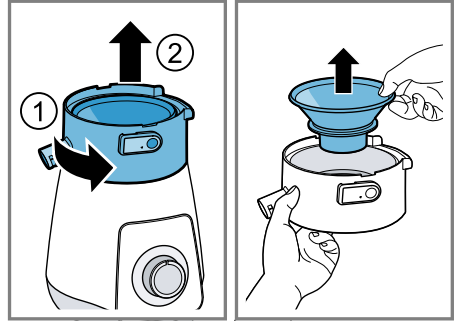

Note: To safely remove the sieve, remove it together with the juicer body.

1. Turn the juicer body anti-clockwise and remove it from the main unit.

2. **Note:** Do not reach into the cutter teeth on the bottom of the sieve. Grip the sieve by the edge of its frame and remove it from the juicer body.

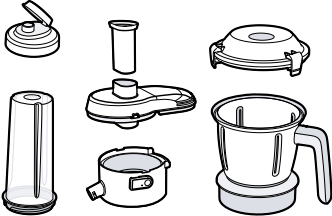

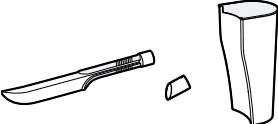
Overview of cleaning

					
	✓	✓	✓	✓	✗
	✗	✗	✗	✓	✗
	✓	✓	✓	✓	✓
	✓	✗	✗	✗	✗

Cleaning the appliance and parts

Clean all parts immediately after use so that residues do not dry on.

Tip: When processing foods such as turmeric and beetroot, plastic parts may become discoloured. This discolouration does not affect their usability.

1. After each use, fill the jar with warm water and a little washing-up liquid.
2. Operate the appliance for one minute to remove residues.
3. Pull out the mains plug.
4. Remove the jar from the appliance and wash by hand.
5. Wipe the outside of the main unit with a soft, damp cloth and dry off.
6. Dry all cleaned parts with a clean, soft cloth.

Note: Always store the jars upside down.

Cleaning the juicer

► Do not use abrasive cloths or cleaning agents.

1. Remove the pulp.
2. **Note:** Do not reach into the cutter teeth on the bottom of the sieve.
Rinse all parts of the juicer under running water, clean with a brush and allow to dry.
Note that the spout cover can be removed.

Checking and replacing the sieve

1. Check the sieve for visible damage and wear.
2. If required, replace the sieve.

en

Note: Replace the sieve approximately every two years if the juicer is used on a daily basis.

A new sieve is available from customer service.

Troubleshooting

Appliance does not switch on.

No power supply.

- ▶ Check mains supply.

Filled beyond capacity.

- ▶ Remove some ingredients, process smaller quantities.

Time taken for blending is very long.

Filled beyond capacity.

- ▶ Remove some ingredients, process smaller quantities.

Appliance overheats.

External heat source too close.

- ▶ Check and remove any heat sources nearby.

Ventilation openings are blocked.

- ▶ Place appliance on a level surface.

Filled beyond capacity.

- ▶ Remove some ingredients, process smaller quantities.

Appliance switches off during use.

Processing quantity is too big or processing time was too long.

- ▶ Reduce the processing quantity.

The overload protection feature has been activated.

- ▶ Press overload protection button.
→ *"Overload protection"*, Page 8

The coupler or parts are removed when the blade is removed.

This is normal and may occur when the blade is replaced.

- ▶ → *"Blade replacement"*, Page 14

The motor speed decreases significantly or the appliance vibrates during the juicing process.

The sieve is blocked or damaged.

1. Switch off the appliance and pull out the mains plug.
2. Check and clean the sieve.
Stop using a sieve if it is damaged!
→ *"Checking and replacing the sieve"*, Page 13

Blade replacement

The Big jar, Medium jar and the Blender jar are equipped with removable blades.

Parts overview

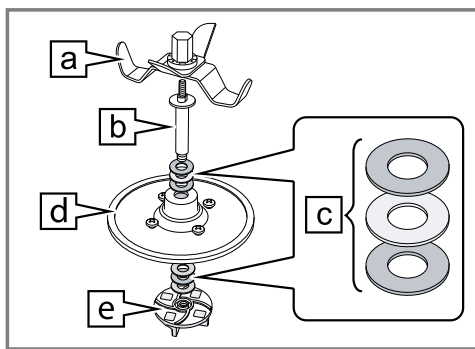

- a** Blade
- b** Axle
- c** Washers above and below the base of the jar.
Sequence of the washers:
 - Fibre washer
 - Metal washer
 - Fibre washer**Note:** Always ensure that the washer sequence is correct when you install the blade.
- d** Jar base
- e** Coupler

Tightening or removing the blade

1. Hold the coupler on the underside of the jar.

- To tighten the blade, use the spatula to rotate the blade nut anticlockwise.

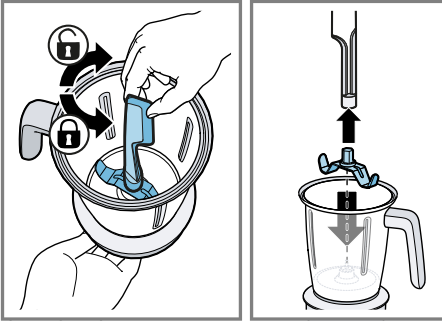

- To remove the blade, use the spatula to turn the blade nut clockwise. It may be the case that the blade remains connected to the axle. Then the coupler and the washers will come off when the blade assembly is taken out of the jar.
- Leave the coupler and all washers to the side and store them safely.

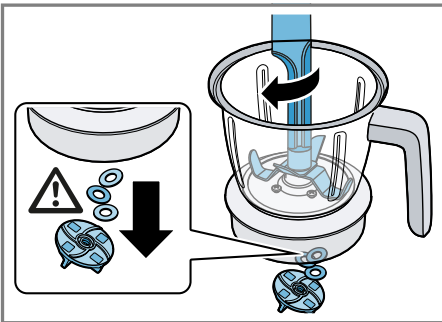

Small parts! Ensure that you do not lose them.

- Remove the blade with axle and the washer from the jar.

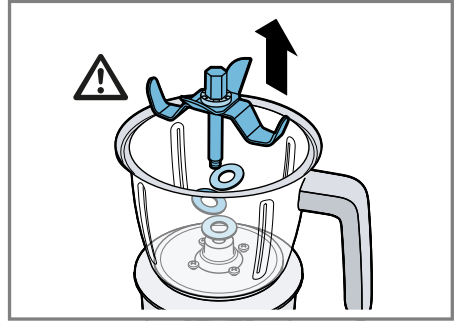

Replacing the blade

- Hold the blade assembly with a cloth.
- Turn the blade nut with the spatula clockwise and untighten it from the axle.

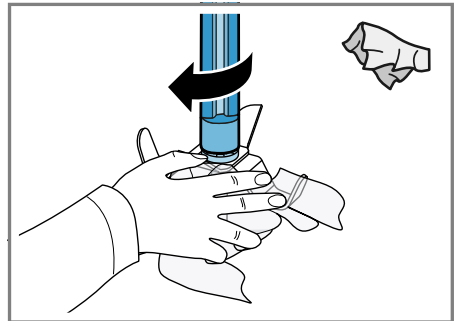

- Remove the blade from the axle.
- Place the selected blade onto the axle and tighten it in an anticlockwise direction using the spatula.

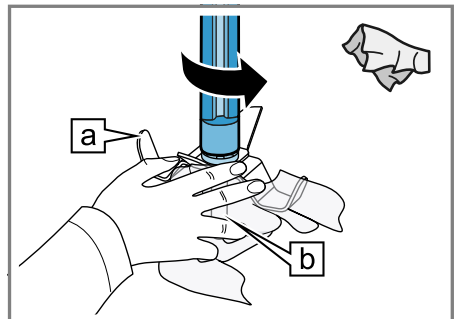

Installing the blade with axle

1. Place the washers onto the axle.
2. Insert the axle with washers into the jar.

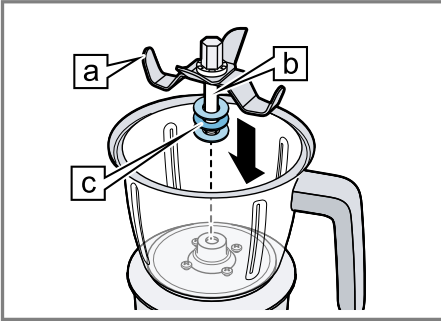

3. Place the washer on the underside of the appliance onto the axle and turn the coupler onto the axle in an anticlockwise direction.

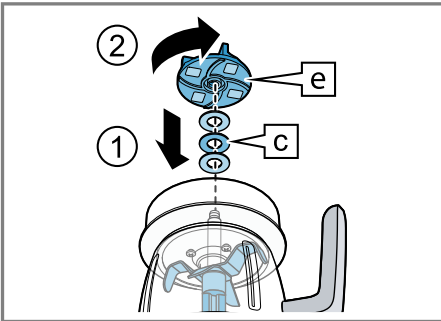

4. Check that all parts are securely connected to each other.

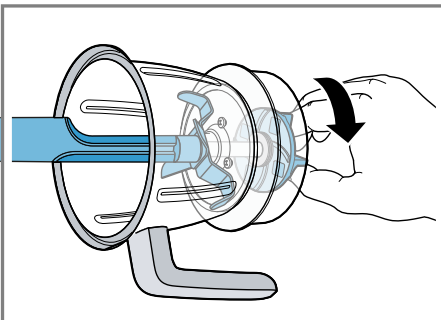

Technical specifications

Voltage and frequency	230 V AC, 50 Hz
Winding wire motor insulation	F class
Rating	750 W 30 minute rating (maximum 6 ON cycles) 1000 W 60 minute rating (maximum 12 ON cycles) 5 min ON and 2 min OFF
Normal load (recipe for 750 W / 1000 W Rating power)	150 g Urad Dal soaked in 340 ml water for 7-8 hours
Seasonal fruit	In winter: Red carrot In summer: Orange
Material of body	ABS
Material of jars	Stainless steel
Blade assembly	Stainless steel
Speed control	3 speed with pulse
Main cord	750 W PVC flexible 2-core cord 1000 W PVC flexible 3-core cord
Country of origin	India

Disposing of old appliance

- Dispose of the appliance in an environmentally friendly manner. Information about current disposal methods are available from your specialist dealer or local authority.



Dispose of packaging in an environmentally-responsible manner. This appliance is certified in accordance with the guidelines on E-waste

(Management) Rules 2022 which govern waste electrical and electronic equipment.

The guideline provide a framework for the return and recycling of used appliances.

Note: This product doesn't contain any of hazardous substances as specified in the e-waste Management and Handling Rules 2022.

Do's

- Please visit our website <https://www.bosch-home.in/metapages/e-waste-management> to find out more details regarding e-waste disposal.
- Keep the product in isolated area, after it becomes non-functional/un-repairable so as to prevent its accidental breakage.
- Consult the authorized service center as to whether the Electronic Equipment can be repaired or not, before discarding.
- Consult the retailer about appliance take back schemes.

Don'ts

- The product should not be opened by the user himself/herself, but only by authorized service personnel.

- The product is not meant for re-sale to any unauthorized agencies/scrap dealers/kabariwalah.
- Don't dispose of the discarded Electronic Equipment in household bins or Municipal bins.
- Don't dump the discarded Electronic Equipment in the open or in any land fill site, as this will result in contamination of the soil and the ground water.
- Do not keep any replaced spare part(s) from the product in exposed area.

Customer Service

Detailed information on the warranty period and terms of warranty in your country is available from our after-sales service, your retailer or on our website.

Helpline no.: 1800-266-1880 (Monday to Saturday – 8 am to 8 pm)

Email ID: service.in@bosch-home.com

Chat with us (WhatsApp):

+91-8451000555



Warranty conditions

Warranty Terms & Conditions:

1. The warranty period for this product will be for 2 years from the date of purchase.
2. The warranty can be availed only by the first purchaser of the appliance and is non-transferable.
3. The warranty covers manufacturing defect in material and workmanship that arises despite normal operation and usage of the appliance as prescribed in the operating manual.
4. In case of the product being tampered with or attempted to be repaired by unauthorised personnel, then the warranty terms will be void and the company shall have no further obligations under warranty. Further, the customer waives all rights against the company which has arisen due to the breach of the warranty terms by the customer.
5. In the event that the company decides to provide a replacement/ refund of the product during this warranty period, customers are mandated to carry the product to the specified service centre/ authorised dealer at their own cost.
6. The warranty coverage is not applicable outside India.
7. In case of replacement, the replaced product will be warranted only for the remaining of the original warranty period
8. The Company shall not have any liability nor deemed to be in default of warranty obligations for any delay or failure in performance of warranty obligations resulting from causes beyond its reasonable control (e.g. strikes, floods, earthquakes etc.) including delay in servicing due to non-availability of product.
9. The Company gives no warranties other than those stated above and specifically excludes any implied warranty of fitness for any particular purpose.
10. In the event of change of address, the new address shall be intimated to the given toll-free number.
11. In case repair cannot be completed onsite, the company reserves the right to carry the appliance to its Authorized Service Center and return the same after repair.

Warranty is not applicable in any of the following cases:

1. The warranty card is not duly filled and does not bear the stamp, date and signature of an Authorised Dealer.
2. The warranty does not cover any consequential or resulting liability, damage or loss to property or life arising directly or indirectly as a result of appliance failure, breakdown, or accident or usage of the appliance not in accordance with the operating manual.
3. The appliance has been subjected to improper use such as not following DFU/ User Manual provided by the company, misused, not cared for, abnormal use, exposure to dampness, excessive heat, excessive humidity and other extreme environmental conditions, corrosion, damage beyond repair, rusting, unauthorised modifications, unauthorised repairs, neglect, accident, alteration, acts of God, spillage of liquid or food particles, faulty electric wiring/ cabling, abnormal voltage/ power supply beyond appliance specifications, damage/ breakage/ non-functioning of appliance due to rodents, rats, cockroaches and ants etc.
4. The warranty does not cover consumables, normal wear & tear parts, plastic, glass and/ or rubber parts, non-operational parts and related accessories.
5. The warranty does not include preventive checks, routine maintenance, cleaning, de-scaling and overhaul.
6. The appliance is used by a commercial establishment or by an individual for commercial purpose.
7. The serial number of the appliance is removed, altered, made illegible/tampered with.
8. Damage to the product or any parts due to transportation or shifting or arising out of improper storage of the appliance at the customer's premises.

Important: Please present this warranty card to our staff at the time of service.**1) Contact the following for availing the support of your Product:**

1-800-266-1880(toll free) Monday – Saturday – 8:00 am to 8:00pm

2) Email: service.in@Bosch-Home.com | Website: www.bosch-home.com/in

WARRANTY CARD

Customer's Name

Address

City	Pin	State
------	-----	-------

Telephone	Mobile
-----------	--------

E-mail	Model/E-Nr
--------	------------

Serial No.

Date of Purchase	Date of Expiry
------------------	----------------

Dealer's Name

Dealer's Signature and Stamp	Customer's Signature
------------------------------	----------------------

Note: Warranty will start from the date of purchase.

Customer Service

Regardless of the nature of your concern, you can always be sure of personal attention from the Bosch Customer Service: on the internet and on the phone.

India, Bhārat, भारत
 BSH Household Appliances Mfg. Pvt. Ltd.
 Arena House, Main Bldg, 2nd Floor, PlotNo. 103,
 Road No. 12, MIDC, Andheri East
 Mumbai 400093
 Toll Free 1800 266 1880*
www.bosch-home.com/in
 *Mon-Sat 8am to 8pm (exclude public holidays)

E-mail: service.in@bosch-home.com



Thank you for buying a Bosch Home Appliance!

Register your new device on MyBosch now and profit directly from:

- **Expert tips & tricks for your appliance**
- **Warranty extension options**
- **Discounts for accessories & spare-parts**
- **Digital manual and all appliance data at hand**
- **Easy access to Bosch Home Appliances Service**

Free and easy registration – also on mobile phones:

www.bosch-home.com/welcome



Looking for help? You'll find it here.

Expert advice for your Bosch home appliances, help with problems or a repair from Bosch experts.

Find out everything about the many ways Bosch can support you:

www.bosch-home.com/service

Contact data of all countries are listed in the attached service directory.

BSH Household Appliances Manufacturing Pvt. Ltd.

Arena house, 2nd floor, Main building,
Plot no 103, Road no 12, MIDC,
Andheri East, Mumbai - 400 093
www.bosch-home.in



8001299888 (050612)

en