





# SELF-REPAIR HINTS

[en]	.....	2
[fr]	.....	14

# Self-repair hints - Cordless handstick vacuum cleaner

 <b>Concerning this document</b> .....	<b>3</b>
1.1 Important information .....	3
1.1.1 Purpose.....	3
1.2 Explanation of symbols .....	3
1.2.1 Danger levels.....	3
1.2.2 Hazard symbols .....	3
1.2.3 Structure of the warnings.....	4
1.2.4 General symbols.....	4
 <b>Safety</b> .....	<b>5</b>
2.1 General Safety instructions .....	5
2.1.1 All domestic appliances .....	5
 <b>Diagrams</b> .....	<b>6</b>
3.1 Connection diagram.....	6
 <b>Tools and aids</b> .....	<b>7</b>
 <b>Repair</b> .....	<b>8</b>
5.1 Removing battery .....	8
5.2 Removing blower motor .....	9
5.3 Removing brush roller.....	13

# **i** Concerning this document

## 1.1 Important information

### 1.1.1 Purpose

These repair hints support the consumer in self-repair. They contain information on how to exchange defined spare parts including warnings, risks and safety measures that need to be followed when carrying out the self-repair.

The proper function and the safety of the appliance can be affected by an improper repair and even serious threats to life or physical condition may arise. We are not liable for damages caused by or occurring during a self-repair insofar as this damage is related to the user's carelessness or failure to follow the self-repair instructions.

For repairs on domestic appliances the approved technical regulations are applied. Any existing additional country-specific requirements and regulations must be observed. In case of doubt please contact our customer service.

## 1.2 Explanation of symbols

### 1.2.1 Danger levels

The warning levels consist of a symbol and a signal word. The signal word indicates the severity of the danger.









Warning level	Meaning
 <b>Danger</b>	Non-observance of the warning message will result in death or serious injuries.
 <b>Warning</b>	Non-observance of the warning message could result in death or serious injuries.
 <b>Caution</b>	Non-observance of the warning message could result in minor injuries.
<b>Notice</b>	Non-observance of the warning message could result in damage to property.

Table 1: Danger levels

### 1.2.2 Hazard symbols

Hazard symbols are symbolic representations which give an indication of the kind of danger.

The following hazard symbols are used in this document:

Hazard symbol	Meaning
	General warning message
	Danger from electrical voltage
	Risk of explosion
	Danger of cuts
	Danger of crushing

## i Concerning this document



Hazard symbol	Meaning
	Danger from hot surfaces
	Danger from strong magnetic field
	Danger from non-ionizing radiation

Table 2: Hazard symbols

### 1.2.3 Structure of the warnings

Warnings in this document have a standardised appearance and a standardised structure.



	<div style="background-color: red; color: white; padding: 2px; text-align: center;"> <b>Danger</b></div> <p><b>Type and source of danger!</b> Possible consequences of ignoring the danger / warning.</p> <ul style="list-style-type: none"> <li>▶ Measures and prohibitions for preventing the danger.</li> </ul>
--	---

The following example shows a warning that warns against electric shock due to live parts. The measure for avoiding the danger is mentioned.

	<div style="background-color: red; color: white; padding: 2px; text-align: center;"> <b>Danger</b></div> <p><b>Risk of electric shock due to live parts!</b> Death by electrocution</p> <ul style="list-style-type: none"> <li>▶ Disconnect appliances from electrical supply at least 60 seconds before starting repairs.</li> </ul>
---	---

### 1.2.4 General symbols

The following general symbols are used in this document:

Gen. symbol	Meaning
	Identification of a special tip (text and/or graphic)
	Identification of a simple tip (only text)
	Identification of a link to a video tutorial





Gen. symbol	Meaning
	Identification of required tools
	Identification of required preconditions
	Identification of a condition (if ..., then ...)
	Identification of a result
[Start]	Identification of a key or button
[00123456]	Identification of a material number
Status	Identification of displayed text / window (in the appliance's display)

Table 3: General symbols

## 2.1 General Safety instructions

### 2.1.1 All domestic appliances

#### **Risk of electric shock due to live parts!**

- Errors by repairs involving electrical components can lead to electrical shock!
- Disconnect the appliance from the mains for at least 60 seconds before starting work.
- After the repair have a safety test according VDE 0701 or country-specific regulations performed.

#### **Risk of injury from sharp edges!**

- Wear protective gloves.

#### **Risk of crushing during repair, maintenance, troubleshooting and service due to heavy and moving components**

- Wear protective shoes.
- Secure heavy components from falling down.
- Do not stick body parts into moving components.

#### **Risk to the appliance's safety / function!**

- Only use original spare parts.

#### **Risk of damage to electrostatically sensitive components (ESDs)!**

- Do not touch the modules, including connections and conductor paths.

## 3.1 Connection diagram

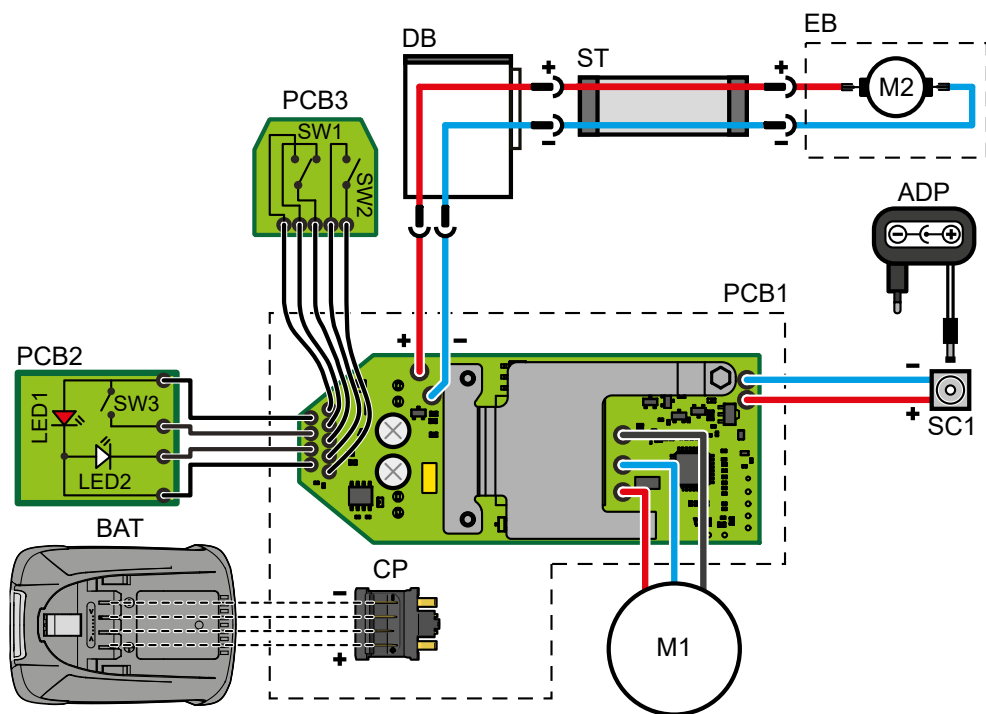



ST Suction tube  
EB Electric brush

Fig. 1: Connection diagram

- M1 Blower motor
- M2 Electric brush motor
- PCB1 Control module
- PCB2 User interface module
- PCB3 Double microswitch module
- CP Contact plates for battery / installed on the back side of control module
- BAT Battery
- ADP Power supply unit
- SC1 Socket / for power supply unit
- BAT Battery
- SW1 Microswitch 1
- SW2 Microswitch 2
- DB Dust box

## Tools and aids

Designation	Details	Images
Torx-Bit TX8 [00342187]	6,3 mm (1/4")	
Slotted screwdriver [00340612]	Blade 5 mm x 0.8 mm x 100 mm	

## 5.1 Removing battery

### Prerequisite:

- ✔ Appliance is switched off.
- ▶ 1. Press battery release button (1).
- ▶ 2. Remove battery to the rear (2).

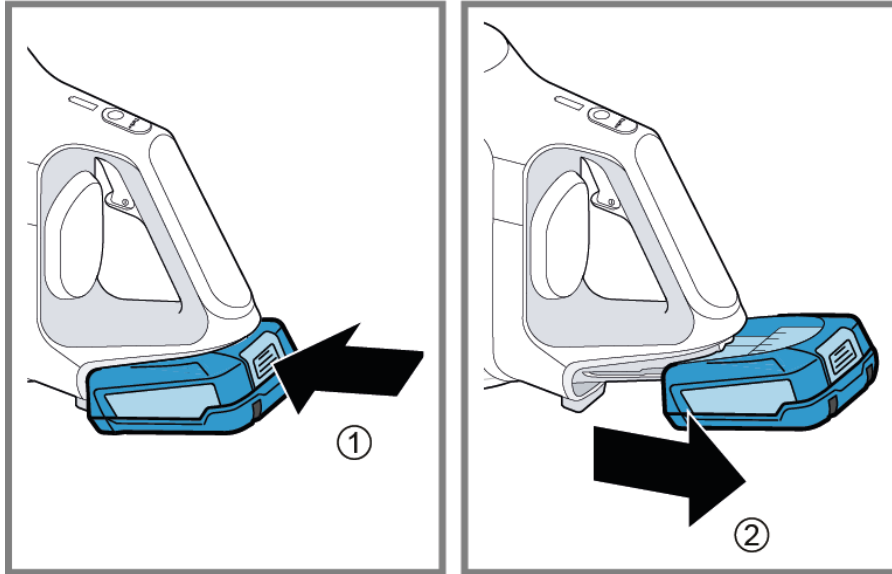



➡ Battery is removed.



## 5.2 Removing blower motor

### Required tools:

-  Screwdriver TX8, for hexalobular recess heads, Reference ISO 10664
-  Slotted screwdriver Blade 5 mm x 0.8 mm x 100 mm [00340612]



### Caution

#### Sharp edges!

Cut injuries

- ▶ Wear protective gloves.





### Notice

#### Electrostatic-sensitive devices!

Fault or breakdown of components by electrostatic charges

- ▶ Before touching and measuring ESDs, use an electrostatic protection system (wristband with earth safe plug).
- ▶ Avoid allowing ESDs to come into contact with plastic materials that are capable of carrying a charge (films, etc.).
- ▶ Hold assemblies, modules and circuit boards in such a way that there is as little contact as possible with conductor strips or connectors.
- ▶ Do not place ESDs too close to monitors or televisions.
- ▶ Use only conductive materials or the original packaging for transportation.

### Prerequisite:

-  Appliance is switched off.
-  Dust box is removed.

1. 1. Press battery release button (1).
2. 2. Remove battery to the rear (2).

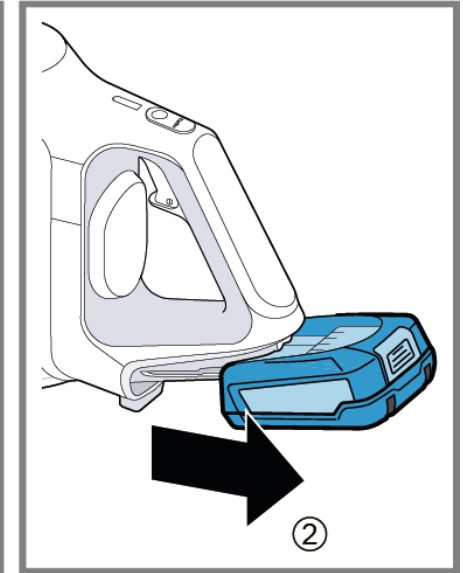
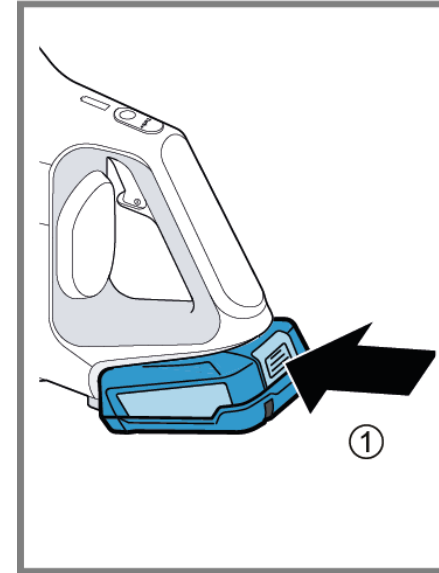

2.



### Notice

#### Risk of damage!

Lacquered or high-gloss surfaces.

- ▶ Act carefully when using tools. Place soft cloth underneath screwdriver blade to protect housing parts!
- ▶ Use soft cloth or towel to protect housing parts from scratches during repair!

## Repair

Remove cap.

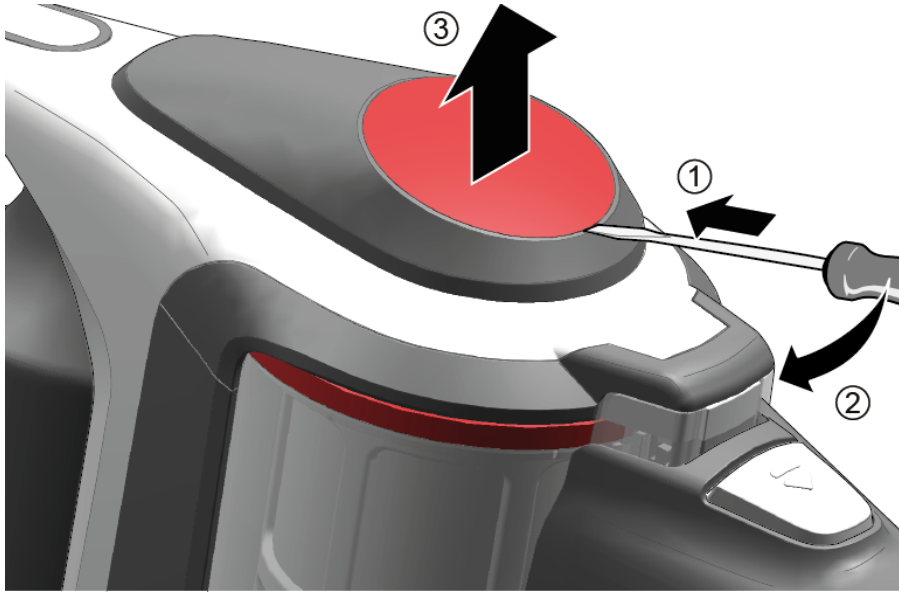

1. Remove the screw (1).
2. Remove top cover (2).

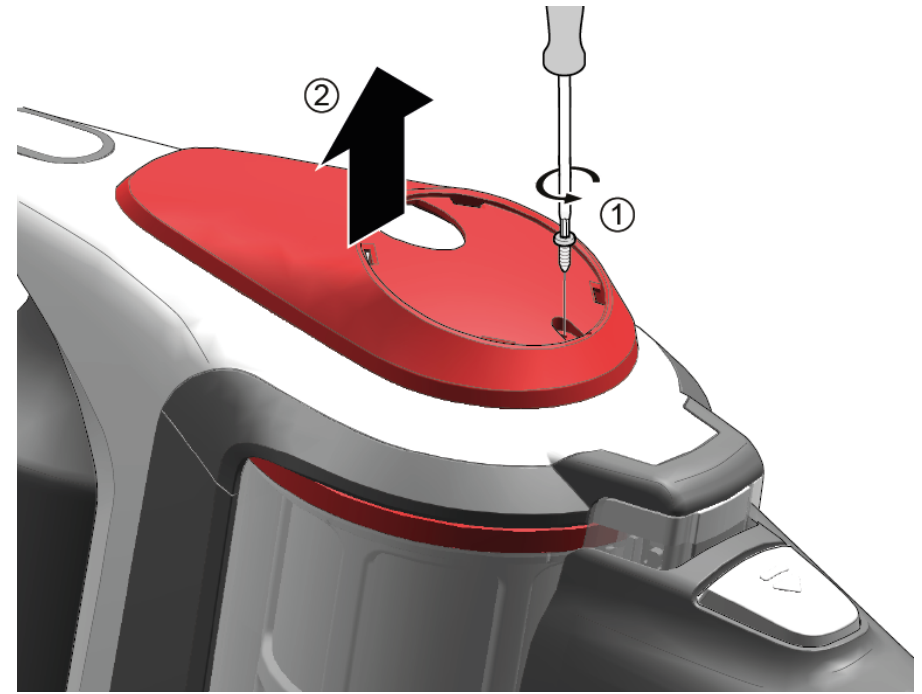

4. 1. Release hooks (1).
2. Remove exhaust filter (2).

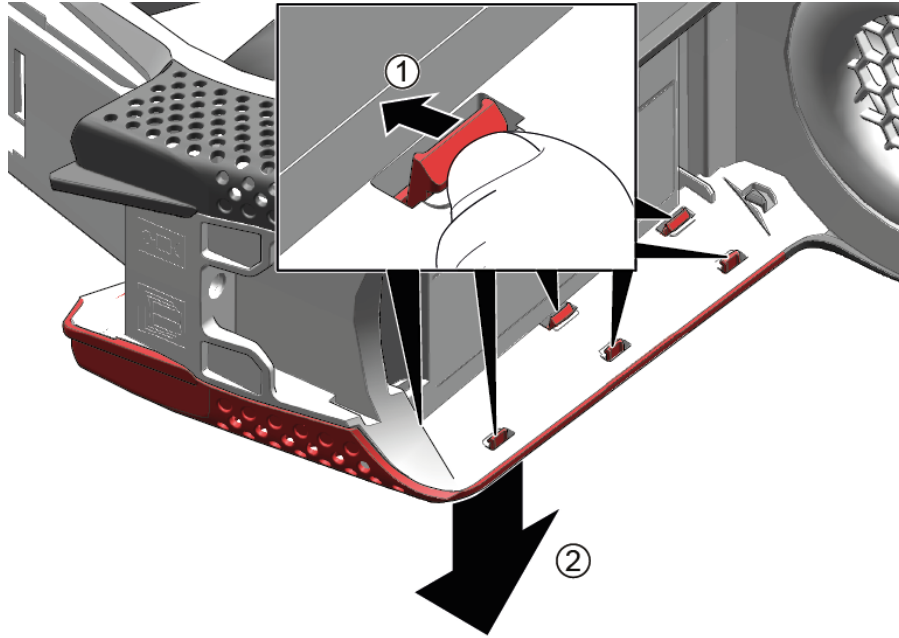

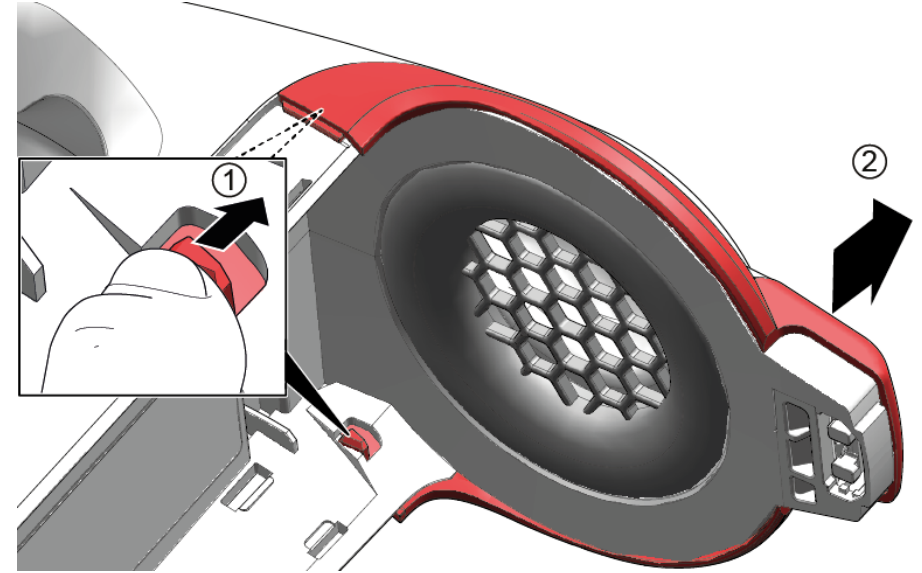

5. 1. Release hooks (1).
2. Remove front frame (2).

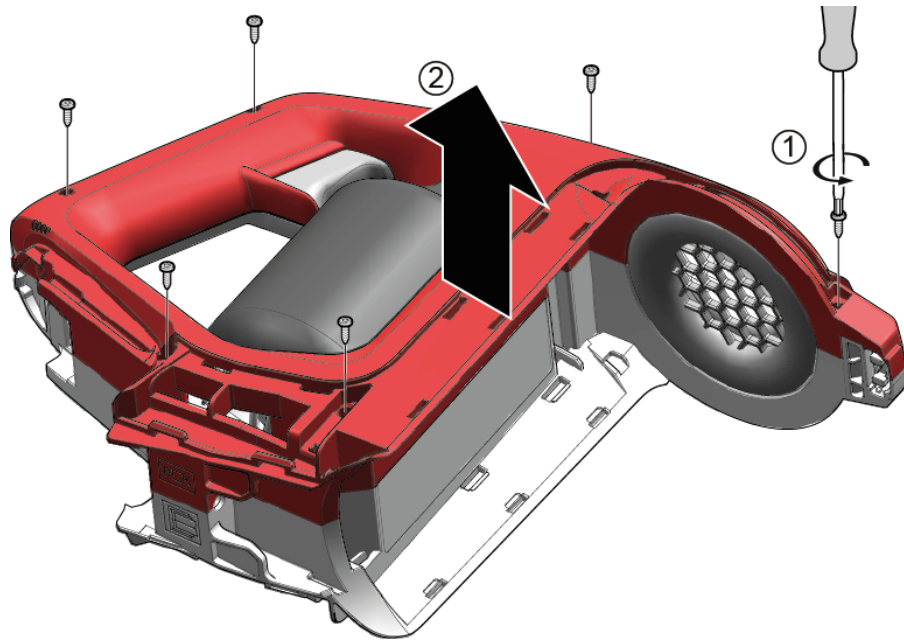

## Repair

6. 1. Remove six screws (1).
2. Remove right side part (2).



7. Take out the air duct including ring adapter.
  8. Disconnect blower motor electrical connection.
  9. Take out blower motor.
  10. Remove blower motor from insulation casing.
-  Blower motor is removed.

## 5.3 Removing brush roller

### Prerequisite:

✔ Appliance is switched off.

1. Press the release button (1).
2. Pull the suction pipe out of the floor nozzle (2).

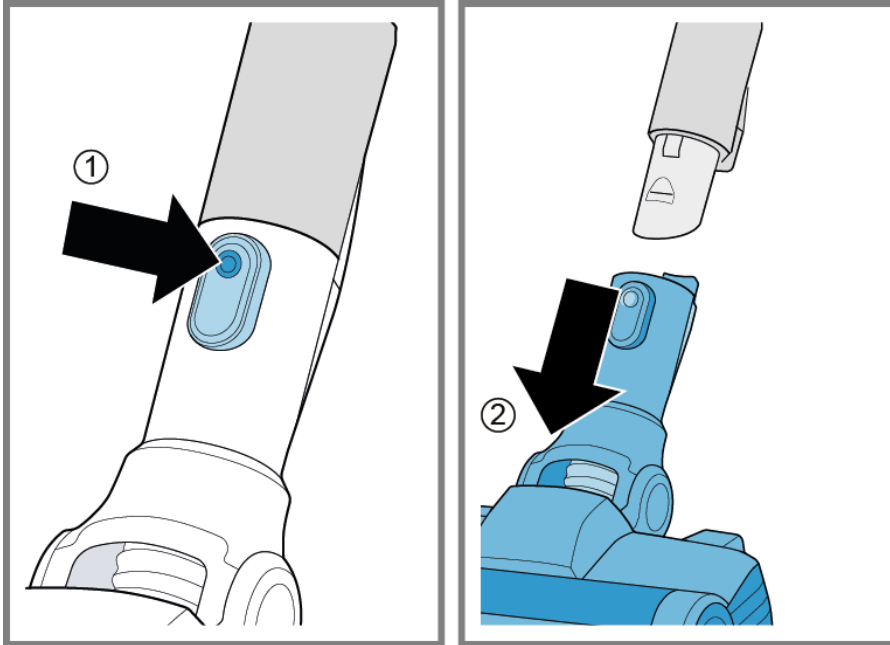



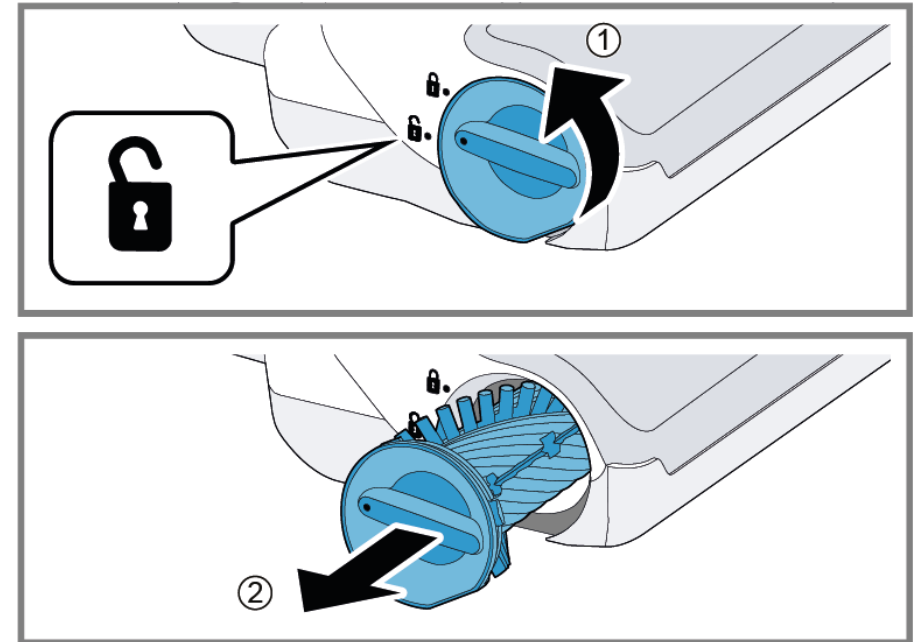

2. 1. Twist the locking mechanism on the side of floor nozzle (1).
2. Pull out the brush roller (2).



➡ Brush roller is removed.

# Conseils de réparation - Aspirateur balai rechargeable

 <b>A propos de ce document</b> .....	<b>15</b>
1.1 Informations importantes.....	15
1.1.1 Objectif.....	15
1.2 Explication des symboles.....	15
1.2.1 Niveaux de risque.....	15
1.2.2 Symboles de danger.....	15
1.2.3 Structure des indications d'avertissement.....	16
1.2.4 Symboles généraux.....	16
 <b>Sécurité</b> .....	<b>17</b>
2.1 Consignes de sécurité générales.....	17
2.1.1 Tous les appareils électroménagers.....	17
 <b>Schémas</b> .....	<b>18</b>
3.1 Schéma de branchement.....	18
 <b>Outils et aides</b> .....	<b>19</b>
 <b>Réparation</b> .....	<b>20</b>
5.1 Retirer la batterie.....	20
5.2 Retirer le moteur du ventilateur.....	21
5.3 Retirer la brosse rotative.....	25

# **i** A propos de ce document

## 1.1 Informations importantes

### 1.1.1 Objectif

Ces conseils de réparation aident le consommateur à résoudre les problèmes par lui-même. Ils contiennent des informations sur la manière d'échanger certaines pièces détachées, ainsi que des avertissements, les risques et les mesures de sécurité à respecter lors de l'auto-réparation.

Toute réparation non conforme peut entraver le bon fonctionnement et la sécurité de l'appareil et entraîner des risques et dangers pour l'utilisateur. Nous ne sommes pas responsables des dommages causés par ou survenant lors de l'auto-réparation, dans la mesure où ces dommages sont liés à la négligence de l'utilisateur ou au non-respect des instructions d'auto-réparation.

Lors de toute réparation sur du matériel électroménager, il convient de se conformer aux réglementations techniques habituelles. Il convient de respecter les exigences et prescriptions nationales. En cas de doute, il faut contacter notre service après-vente.

## 1.2 Explication des symboles

### 1.2.1 Niveaux de risque

Les niveaux de risque se composent d'un symbole et d'un terme d'avertissement. Le mot d'avertissement caractérise la gravité du danger.







Niveau de dangerosité	Signification
 <b>DANGER</b>	Le non respect de la consigne d'avertissement provoque la mort ou des blessures graves.
 <b>AVERTISSEMENT</b>	Le non respect de la consigne d'avertissement peut provoquer la mort ou des blessures graves.
 <b>PRUDENCE</b>	Le non respect de la consigne d'avertissement peut provoquer des blessures légères.
<b>ATTENTION !</b>	Le non respect de la consigne d'avertissement peut provoquer des dégâts matériels.

Tableau 1: Niveaux de risque

### 1.2.2 Symboles de danger

Les symboles de danger sont des représentations figuratives renseignant sur la nature du danger.

Ce document utilise les symboles de danger suivants:

Symbole de danger	Signification
	Consigne d'avertissement générale
	Danger engendré par la tension électrique
	Risque d'explosion
	Risque de blessures par coupure

## **i** A propos de ce document





Symbole de danger	Signification
	Risque de blessures par écrasement
	Danger engendré par des surfaces très chaudes
	Danger engendré par un champ magnétique puissant
	Danger engendré par un rayonnement non ionisant

Tableau 2: Symboles de danger

### 1.2.3 Structure des indications d'avertissement

Les consignes d'avertissement figurant dans ce document ont un aspect uniforme et une structure uniforme.

	<div style="background-color: red; color: white; padding: 2px; text-align: center;"><b>⚠ DANGER</b></div> <p><b>Type et source du danger !</b> Conséquences possibles en cas de non-respect du danger / de l'avertissement.</p> <ul style="list-style-type: none"> <li>▶ Mesures et interdictions pour éviter le danger.</li> </ul>
--	---

L'exemple suivant montre une consigne d'avertissement mettant en garde contre le risque d'électrocution. La mesure permettant d'éviter le danger est nommée.

	<div style="background-color: red; color: white; padding: 2px; text-align: center;"><b>⚠ DANGER</b></div> <p><b>Risque d'électrocution par des pièces conductrices de tension !</b> Mort par électrocution.</p> <ul style="list-style-type: none"> <li>▶ Débrancher l'appareil du secteur minimum 60 secondes avant de démarrer la réparation.</li> </ul>
--	---

### 1.2.4 Symboles généraux

Ce document utilise les symboles généraux suivants:







Symbole général	Signification
	Caractérisation d'une astuce particulière (texte et/ou graphique)
	Caractérisation d'une astuce simple (texte seul)
	Caractérisation d'un lien vers une vidéo
	Caractérisation d'outils nécessaires
	Caractérisation de conditions nécessaires
	Caractérisation d'une condition (si... , alors ...)
	Caractérisation d'un résultat
Start	Caractérisation d'une touche ou surface de commande
[00123456]	Caractérisation d'une référence de pièce
Statut	Caractérisation d'un texte affiché / fenêtre (sur l'afficheur)

Tableau 3: Symboles généraux



## 2.1 Consignes de sécurité générales

### 2.1.1 Tous les appareils électroménagers

#### **Risque d'électrocution en raison de pièces sous tension!**

- Des erreurs lors de réparations impliquant des composants électriques peuvent entraîner une décharge électrique!
- Débrancher l'appareil du secteur minimum 60 secondes avant de démarrer la réparation.
- Après la réparation, effectuer un test de sécurité selon VDE 0701 ou les réglementations spécifiques nationales.

#### **Risque de blessures par coupure sur des bords tranchants!**

- Porter des gants de protection.

#### **Risque de casse durant la réparation, maintenance, dépannage et SAV en raison de composants lourds et mobiles**

- Porter des chaussures de protection.
- Sécuriser les composants lourds contre le risque de chute.
- Ne pas coller les pièces du châssis sur les composants mobiles.

#### **Risque lié à la sécurité / fonction de l'appareil!**

- Utiliser uniquement des pièces détachées d'origine.

#### **Risque d'endommagement des composants sensibles aux décharges électrostatiques!**

- Ne pas toucher les modules, ni leur connexions et pistes conductrices.

## 3.1 Schéma de branchement

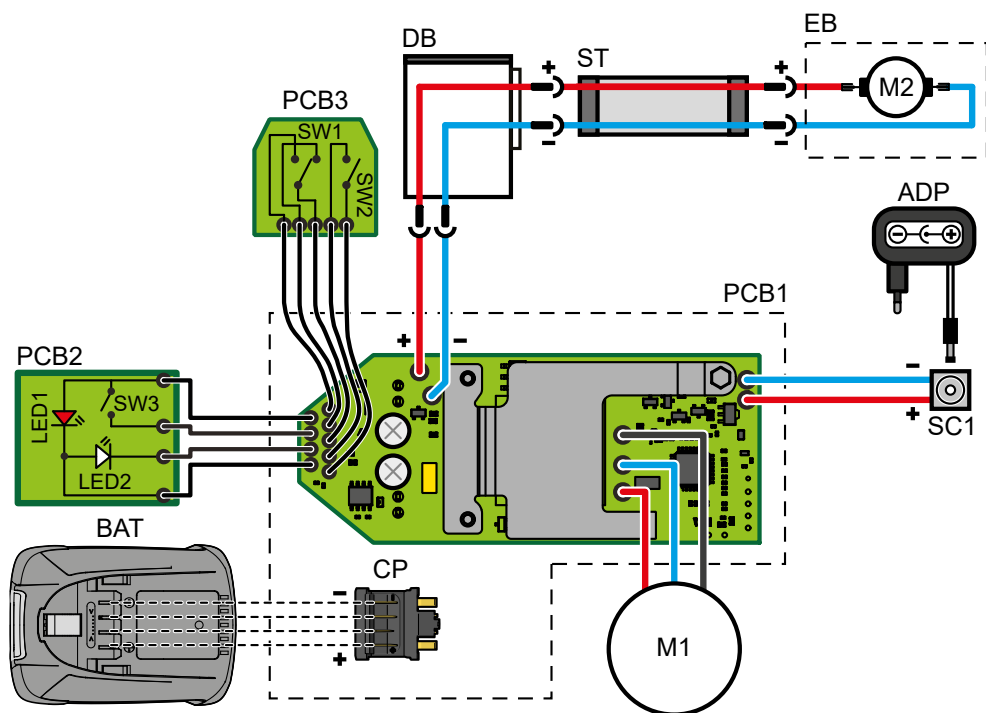



ST Tuyau d'aspiration  
EB Brosse électrique

Fig. 1: Schéma de branchement

- M1 Moteur ventilateur
- M2 Moteur brosse électrique
- PCB1 Module de contrôle
- PCB2 Module interface utilisateur
- PCB3 Module micro-interrupteur double
- CP Plaques de contact pour batterie / montées à l'arrière du module de contrôle
- BAT Batterie
- ADP Unité alimentation électrique
- SC1 Prise / pour unité alimentation électrique
- BAT Batterie
- SW1 Micro-interrupteur 1
- SW2 Micro-interrupteur 2
- DB Bac de poussière

## Outils et aides

Désignation	Détails	Images
Embout Torx TX8 [00342187]	6,3 mm (1/4")	
Tournevis plat [00340612]	Lame 5 mm x 0.8 mm x 100 mm	

## 5.1 Retirer la batterie

### Pré-requis:

- ✔ L'appareil est éteint.
- ▶ 1. Appuyer sur le bouton de déblocage de la batterie (1).
- ▶ 2. Retirer la batterie par l'arrière (2).

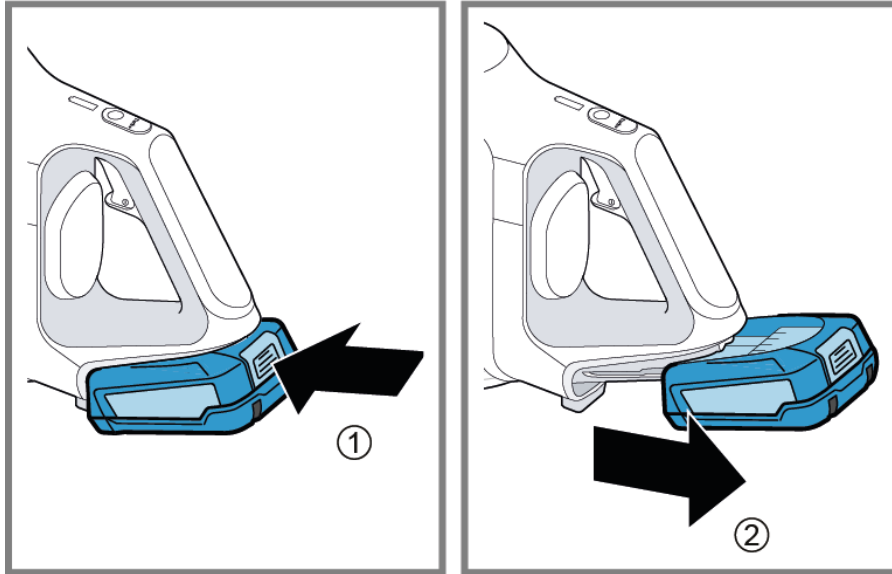

➡ La batterie est retirée.

## 5.2 Retirer le moteur du ventilateur

### Outillage nécessaire:

- 🔧 Tournevis TX8, pour têtes fendues hexalobulaires, Référence ISO 10664
- 🔧 Tournevis plat lame 5 mm x 0.8 mm x 100 mm [00340612]



### ⚠️ PRUDENCE

#### Arêtes vives !

- Blessures par coupure
- ▶ Porter des gants de protection.



### ⚠️ ATTENTION !

#### Composants sensibles aux décharges électrostatiques !

Défaut ou panne de composants en raison de charges électrostatiques.

- ▶ Avant tout contact et mesure de ces composants, utiliser un système de protection électrostatique (ex. bracelet de mise à la terre).
- ▶ Empêcher tout contact entre ces composants et les matériaux plastiques capables de supporter une charge (films, etc.).
- ▶ Maintenir les groupes de composants, modules et platines de sorte qu'il y ait le moins de contact possible avec les bandes conductrices ou connecteurs.
- ▶ Ne pas placer ces composants trop proches de moniteurs ou télévisions.
- ▶ Utiliser pour le transport uniquement des matériaux conducteurs ou l'emballage d'origine.

### Pré-requis:

- ✅ L'appareil est éteint.
- ✅ Le bac de poussière est retiré.

1. Appuyer sur le bouton de déblocage de la batterie (1).
2. Retirer la batterie par l'arrière (2).

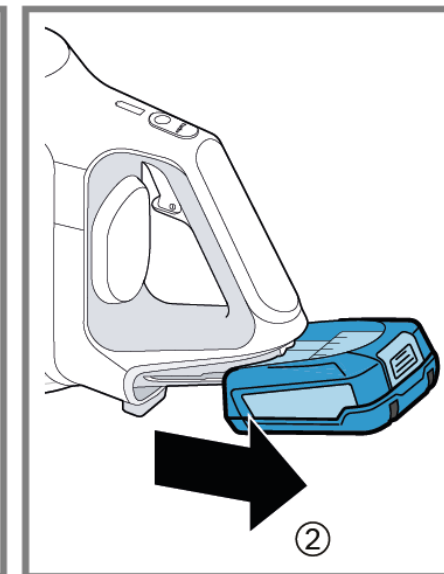
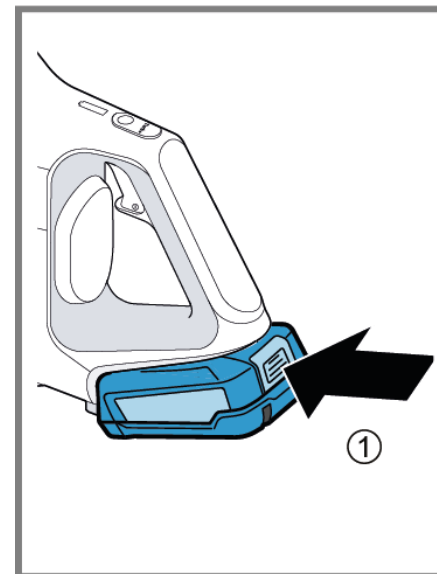

2.



### ⚠️ ATTENTION !

#### Risque de dommage !

Surfaces laquées ou brillantes.

- ▶ Utiliser les outils avec prudence. Placer un tissu doux sous la lame du tournevis pour protéger les pièces du boîtier !
- ▶ Utiliser un tissu ou chiffon doux pour protéger les pièces du boîtier contre le risque de rayures durant la réparation!

## Réparation

Retirer le capuchon.

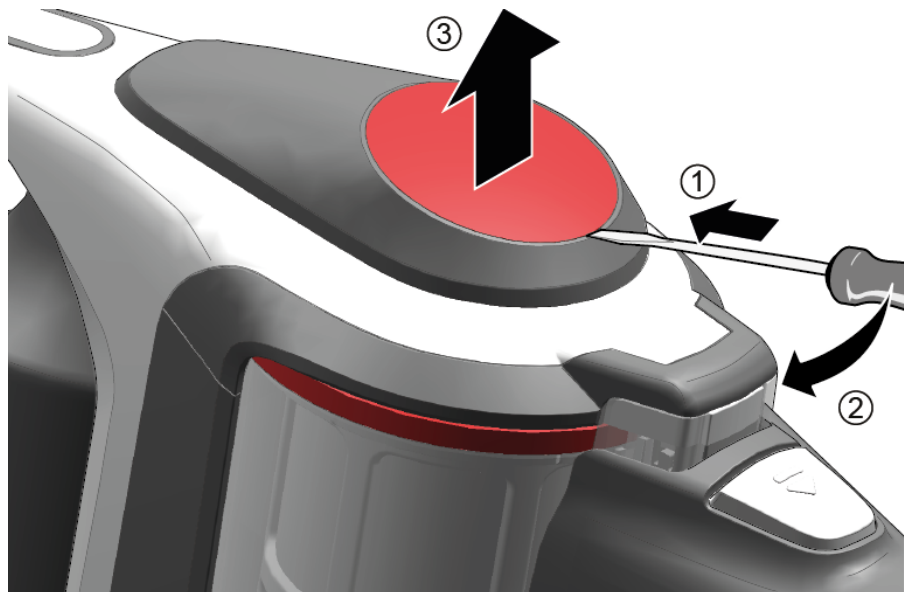

1. Retirer la vis (1).
2. Retirer le cache supérieur (2).

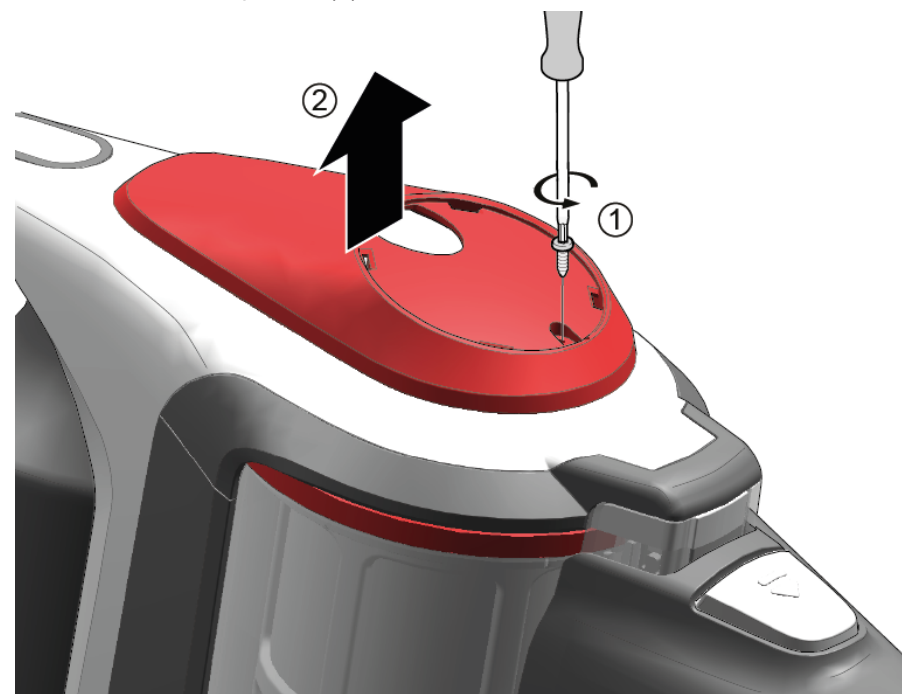

## Réparation

4. 1. Défaire les crochets (1).
2. Retirer le filtre d'évacuation (2).

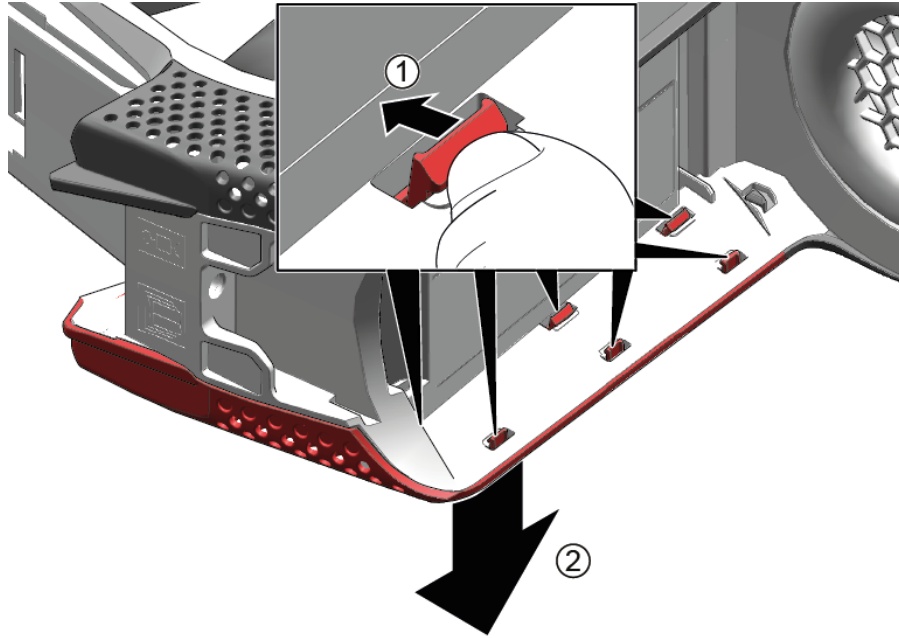

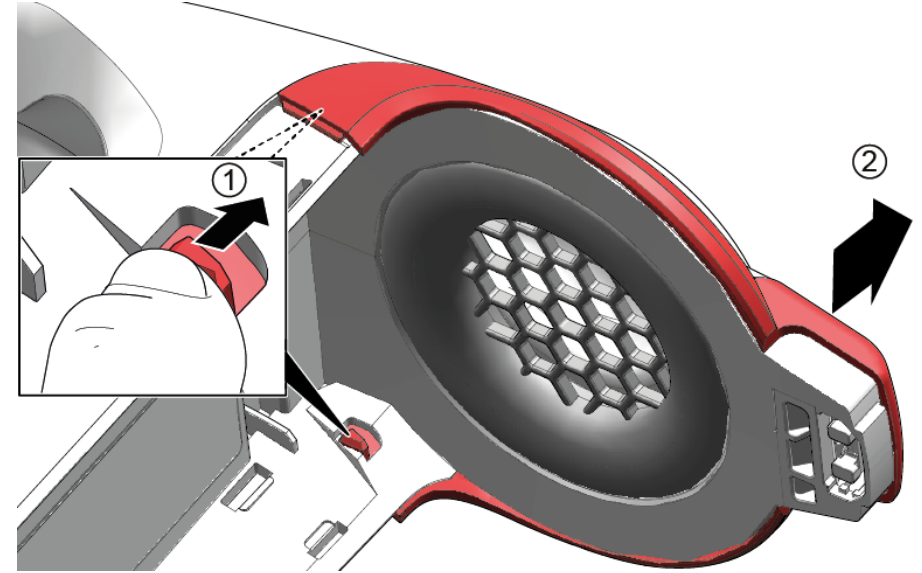

5. 1. Défaire les crochets (1).
2. Retirer le cadre avant (2).

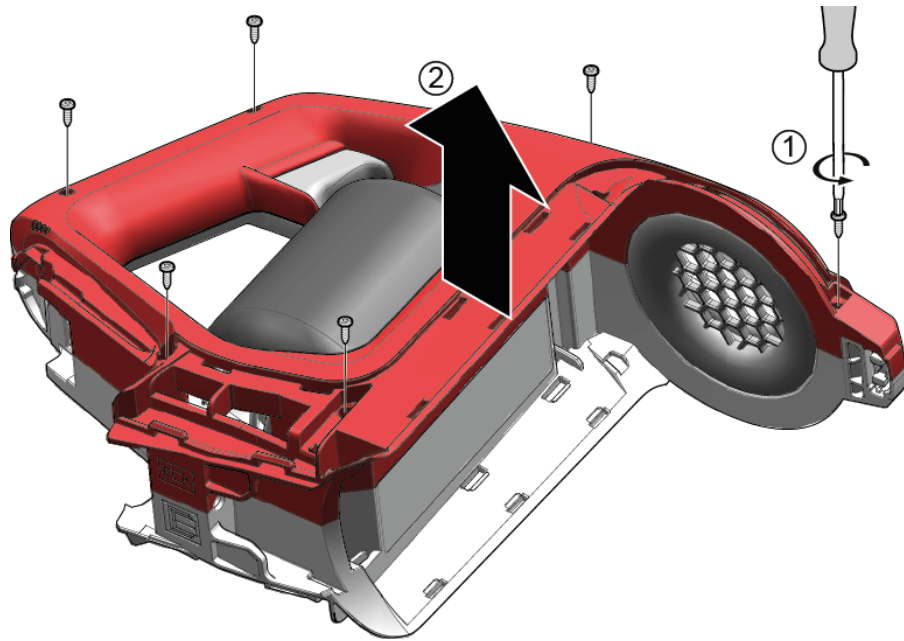

## Réparation

6. 1. Retirer six vis (1).
2. Retirer la pièce latérale droit (2).



7. Sortir le conduit d'air, y compris l'adaptateur de la bague.
  8. Débrancher la connexion électrique du moteur ventilateur.
  9. Retirer le moteur du ventilateur.
  10. Retirer le moteur du ventilateur du boîtier d'isolation.
-  Le moteur du ventilateur est retiré.



## 5.3 Retirer la brosse rotative

### Pré-requis:

✔ L'appareil est éteint.

1. Appuyer sur le bouton de déblocage (1).
2. Sortir le tuyau d'aspiration de la brosse de sol (2).

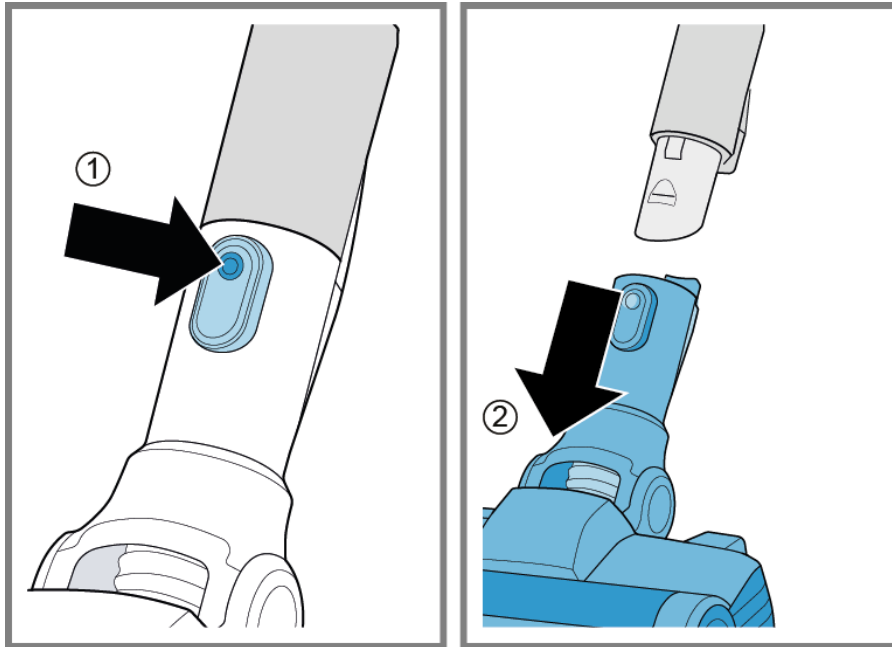

1. Tourner le mécanisme de verrouillage sur le côté de la brosse de sol (1).
2. Retirer la brosse rotative (2).

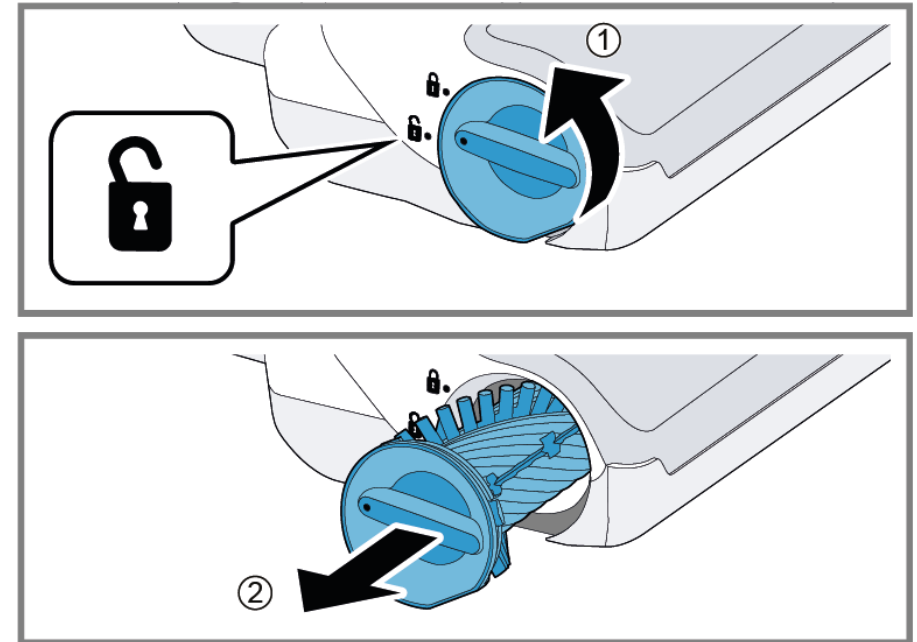

➡ La brosse rotative est retirée.