





# SELF-REPAIR HINTS

|      |       |    |
|------|-------|----|
| [en] | ..... | 2  |
| [fr] | ..... | 14 |

# Self-repair hints - Bagless vacuum cleaner

|  |          |
|--|----------|
|  <b>Concerning this document</b> ..... | <b>3</b> |
| 1.1 Important information .....  | 3        |
| 1.1.1 Purpose.....   | 3        |
| 1.2 Explanation of symbols .....   | 3        |
| 1.2.1 Danger levels.....   | 3        |
| 1.2.2 Hazard symbols .....   | 3        |
| 1.2.3 Structure of the warnings.....   | 4        |
| 1.2.4 General symbols.....   | 4        |
|  <b>Safety</b> .....                   | <b>5</b> |
| 2.1 General Safety instructions .....  | 5        |
| 2.1.1 All domestic appliances .....  | 5        |
|  <b>Diagrams</b> .....                 | <b>6</b> |
| 3.1 Connection diagram.....  | 6        |
|  <b>Tools and aids</b> .....           | <b>7</b> |
|  <b>Repair</b> .....                   | <b>8</b> |
| 5.1 Removing cable rewriter.....   | 8        |
| 5.2 Removing blower motor .....  | 10       |
| 5.3 Removing on / off switch .....   | 12       |

# **i** Concerning this document

## 1.1 Important information

### 1.1.1 Purpose

These repair hints support the consumer in self-repair. They contain information on how to exchange defined spare parts including warnings, risks and safety measures that need to be followed when carrying out the self-repair.

The proper function and the safety of the appliance can be affected by an improper repair and even serious threats to life or physical condition may arise. We are not liable for damages caused by or occurring during a self-repair insofar as this damage is related to the user's carelessness or failure to follow the self-repair instructions.

For repairs on domestic appliances the approved technical regulations are applied. Any existing additional country-specific requirements and regulations must be observed. In case of doubt please contact our customer service.

## 1.2 Explanation of symbols

### 1.2.1 Danger levels

The warning levels consist of a symbol and a signal word. The signal word indicates the severity of the danger.









| Warning level  | Meaning  |
|--|--|
|  <b>Danger</b>  | Non-observance of the warning message will result in death or serious injuries.  |
|  <b>Warning</b> | Non-observance of the warning message could result in death or serious injuries. |
|  <b>Caution</b> | Non-observance of the warning message could result in minor injuries.            |
| <b>Notice</b>  | Non-observance of the warning message could result in damage to property.        |

Table 1: Danger levels

### 1.2.2 Hazard symbols

Hazard symbols are symbolic representations which give an indication of the kind of danger.

The following hazard symbols are used in this document:

| Hazard symbol   | Meaning                        |
|---|--------------------------------|
|   | General warning message        |
|  | Danger from electrical voltage |
|  | Risk of explosion              |
|  | Danger of cuts                 |
|  | Danger of crushing             |

## **i** Concerning this document



| Hazard symbol  | Meaning                            |
|--|------------------------------------|
|  | Danger from hot surfaces           |
|  | Danger from strong magnetic field  |
|  | Danger from non-ionizing radiation |

Table 2: Hazard symbols

### 1.2.3 Structure of the warnings

Warnings in this document have a standardised appearance and a standardised structure.



|  |   |
|--|---|
|  | <div style="background-color: red; color: white; padding: 2px; text-align: center;"> <b>Danger</b></div> <p><b>Type and source of danger!</b><br/>Possible consequences of ignoring the danger / warning.</p> <ul style="list-style-type: none"> <li>▶ Measures and prohibitions for preventing the danger.</li> </ul> |
|--|---|

The following example shows a warning that warns against electric shock due to live parts. The measure for avoiding the danger is mentioned.

|   |   |
|---|---|
|  | <div style="background-color: red; color: white; padding: 2px; text-align: center;"> <b>Danger</b></div> <p><b>Risk of electric shock due to live parts!</b><br/>Death by electrocution</p> <ul style="list-style-type: none"> <li>▶ Disconnect appliances from electrical supply at least 60 seconds before starting repairs.</li> </ul> |
|---|---|

### 1.2.4 General symbols

The following general symbols are used in this document:

| Gen. symbol  | Meaning   |
|--|---|
|  | Identification of a special tip (text and/or graphic) |
|  | Identification of a simple tip (only text)            |
|  | Identification of a link to a video tutorial          |





| Gen. symbol   | Meaning  |
|---|--|
|  | Identification of required tools                                       |
|  | Identification of required preconditions                               |
|  | Identification of a condition (if ..., then ...)                       |
|  | Identification of a result   |
| [Start]   | Identification of a key or button                                      |
| [00123456]  | Identification of a material number                                    |
| Status  | Identification of displayed text / window (in the appliance's display) |

Table 3: General symbols

## 2.1 General Safety instructions

### 2.1.1 All domestic appliances

#### **Risk of electric shock due to live parts!**

- Errors by repairs involving electrical components can lead to electrical shock!
- Disconnect the appliance from the mains for at least 60 seconds before starting work.
- After the repair have a safety test according VDE 0701 or country-specific regulations performed.

#### **Risk of injury from sharp edges!**

- Wear protective gloves.

#### **Risk of crushing during repair, maintenance, troubleshooting and service due to heavy and moving components**

- Wear protective shoes.
- Secure heavy components from falling down.
- Do not stick body parts into moving components.

#### **Risk to the appliance's safety / function!**

- Only use original spare parts.

#### **Risk of damage to electrostatically sensitive components (ESDs)!**

- Do not touch the modules, including connections and conductor paths.

## 3.1 Connection diagram

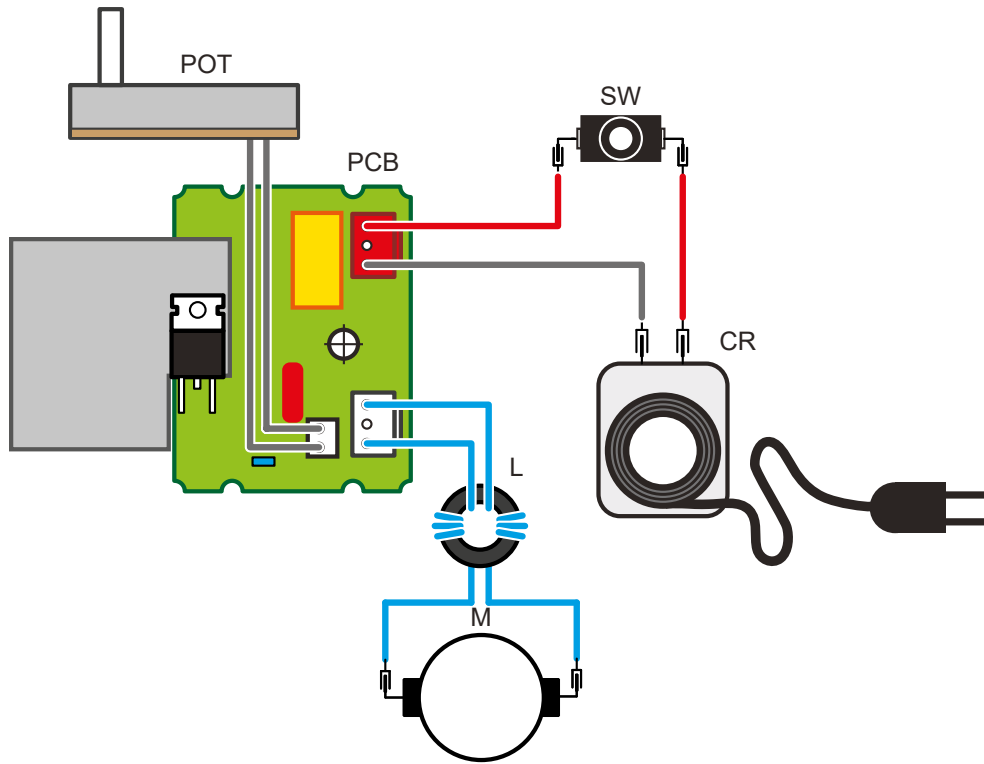

Fig. 1: Connection diagram / for variants with power control

CR Cable rewriter  
 SW On / Off switch  
 M Blower motor  
 PCB Control module  
 POT Slide potentiometer  
 L Ferrite ring

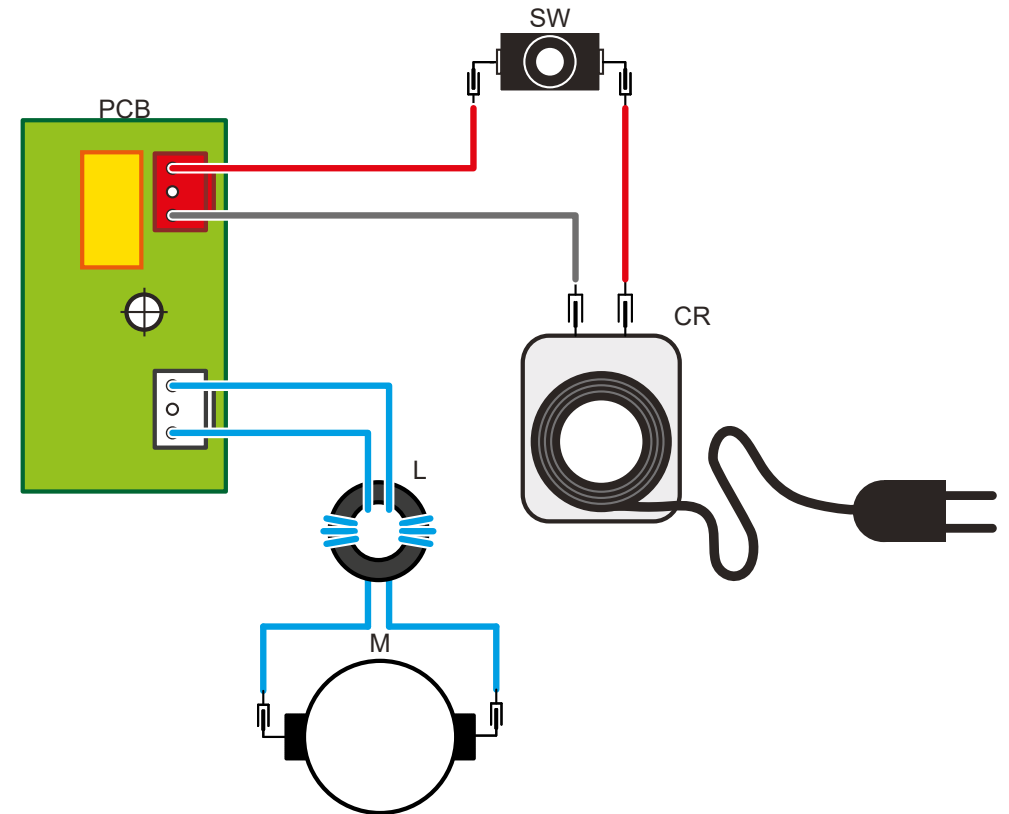



Fig. 2: Connection diagram / for variants w/o power control

CR Cable rewriter  
 SW On / Off switch  
 M Blower motor  
 PCB Control module  
 L Ferrite ring

## Tools and aids

| Designation                       | Details                         | Images  |
|-----------------------------------|---------------------------------|---|
| Phillips screwdriver<br>PH2       |                                 |   |
| Slotted screwdriver<br>[00340612] | Blade 5 mm x 0.8 mm x<br>100 mm |  |

## 5.1 Removing cable rewinder

### Required tools:

- ⌘ Phillips screwdriver PH2
- ⌘ Slotted screwdriver Blade 5 mm x 0.8 mm x 100 mm [00340612]

1.



### Danger

#### Risk of electric shock due to live parts!

Death by electrocution

- ▶ Disconnect appliances from electrical supply at least 60 seconds before starting repairs.



### Caution

#### Sharp edges!

Cut injuries

- ▶ Wear protective gloves.



### Notice

#### Electrostatic-sensitive devices!

Fault or breakdown of components by electrostatic charges

- ▶ Before touching and measuring ESDs, use an electrostatic protection system (wristband with earth safe plug).
- ▶ Avoid allowing ESDs to come into contact with plastic materials that are capable of carrying a charge (films, etc.).
- ▶ Hold assemblies, modules and circuit boards in such a way that there is as little contact as possible with conductor strips or connectors.
- ▶ Do not place ESDs too close to monitors or televisions.
- ▶ Use only conductive materials or the original packaging for transportation.

Disconnect appliance from power supply.

2. 1. Remove six screws (1).
2. Remove top section with attached elements (2).

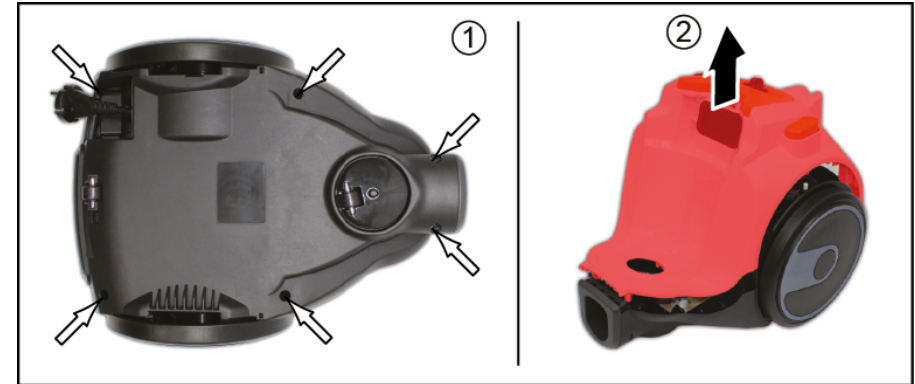

3. 1. Take out cable rewinder.
2. Disconnect electrical connections.

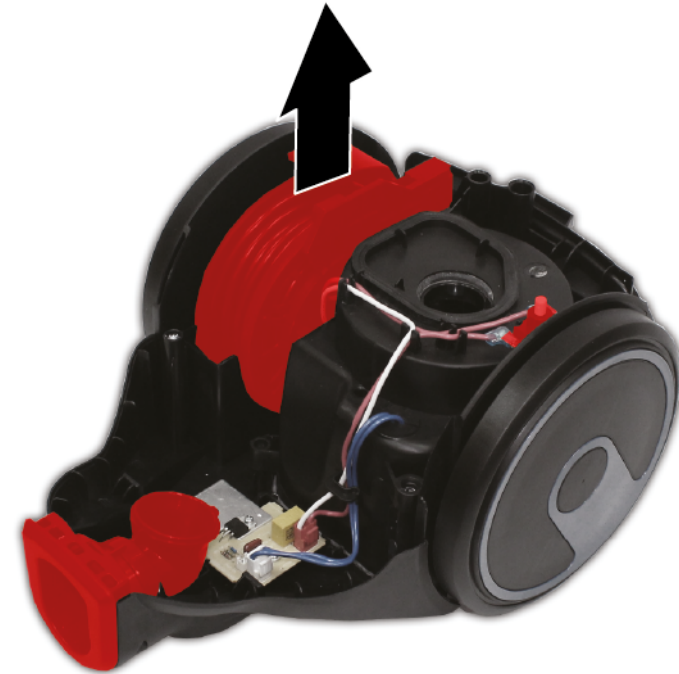



## Repair

4. 1. Release cable rewinder cover.
2. Release power cord.

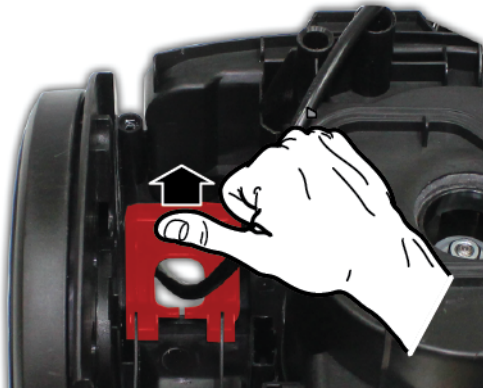

-  Cable rewinder is removed.

## 5.2 Removing blower motor

### Required tools:

- ⌘ Phillips screwdriver PH2
- ⌘ Slotted screwdriver Blade 5 mm x 0.8 mm x 100 mm [00340612]



### Danger

#### Risk of electric shock due to live parts!

Death by electrocution

- ▶ Disconnect appliances from electrical supply at least 60 seconds before starting repairs.



### Caution

#### Sharp edges!

Cut injuries

- ▶ Wear protective gloves.



### Notice

#### Electrostatic-sensitive devices!

Fault or breakdown of components by electrostatic charges

- ▶ Before touching and measuring ESDs, use an electrostatic protection system (wristband with earth safe plug).
- ▶ Avoid allowing ESDs to come into contact with plastic materials that are capable of carrying a charge (films, etc.).
- ▶ Hold assemblies, modules and circuit boards in such a way that there is as little contact as possible with conductor strips or connectors.
- ▶ Do not place ESDs too close to monitors or televisions.
- ▶ Use only conductive materials or the original packaging for transportation.

1. Disconnect appliance from power supply.

2. 1. Remove six screws (1).
2. Remove top section with attached elements (2).

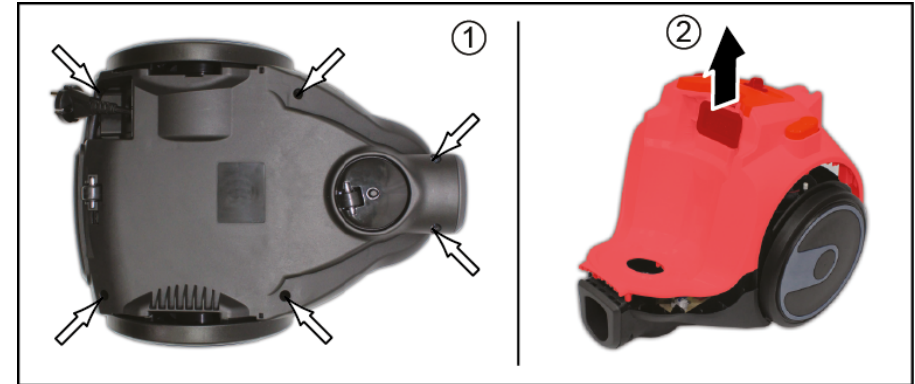

3. Take out cable rewind and disconnect wires.

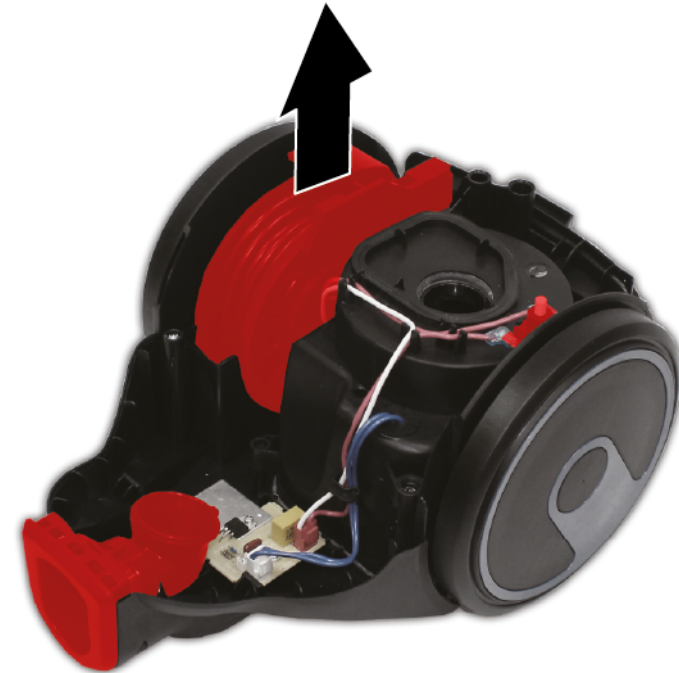

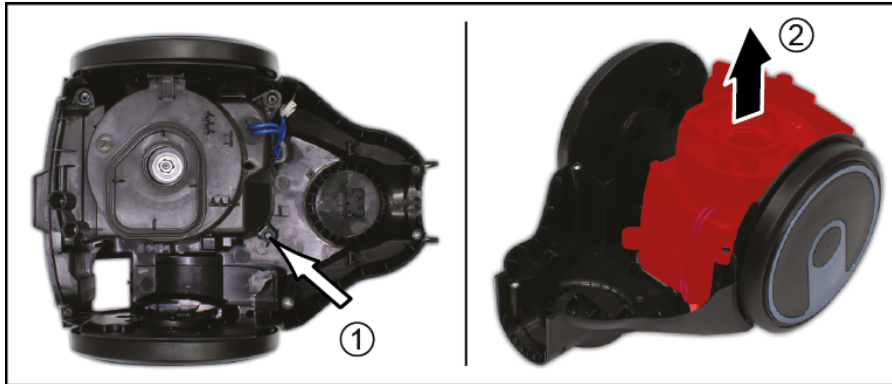

## Repair

4. 1. Remove the screw and disconnect electrical connections (1).
2. Take out cap housing (2).

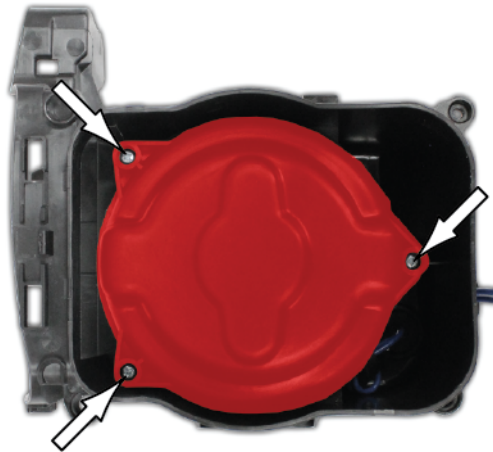

5. 1. Remove three screws.
2. Remove motor cover.



6. Remove sound insulation.
  7. Disconnect electrical connections.
  8. Take out blower motor with dampers.
  9. Separate dampers from blower motor.
-  Blower motor is removed.

## 5.3 Removing on / off switch

### Required tools:

- ⌘ Phillips screwdriver PH2
- ⌘ Slotted screwdriver Blade 5 mm x 0.8 mm x 100 mm [00340612]



### Danger

#### Risk of electric shock due to live parts!

Death by electrocution

- ▶ Disconnect appliances from electrical supply at least 60 seconds before starting repairs.



### Caution

#### Sharp edges!

Cut injuries

- ▶ Wear protective gloves.



### Notice

#### Electrostatic-sensitive devices!

Fault or breakdown of components by electrostatic charges

- ▶ Before touching and measuring ESDs, use an electrostatic protection system (wristband with earth safe plug).
- ▶ Avoid allowing ESDs to come into contact with plastic materials that are capable of carrying a charge (films, etc.).
- ▶ Hold assemblies, modules and circuit boards in such a way that there is as little contact as possible with conductor strips or connectors.
- ▶ Do not place ESDs too close to monitors or televisions.
- ▶ Use only conductive materials or the original packaging for transportation.

1. Disconnect appliance from power supply.

2. 1. Remove six screws (1).
2. Remove top section with attached elements (2).

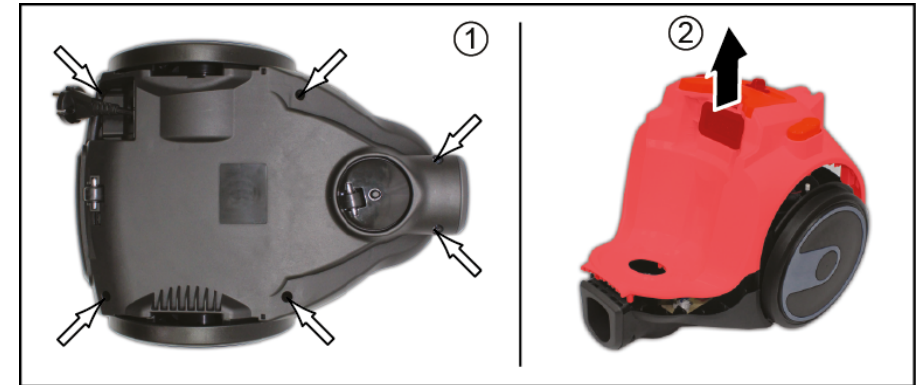



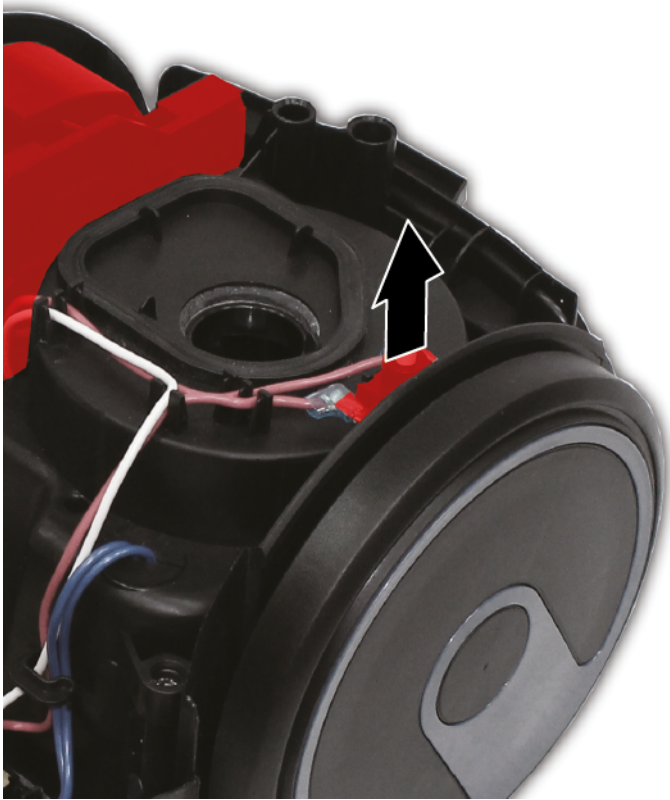

## Repair

3. 1. Disconnect electrical connections.
2. Remove on / off switch.



 On / off switch is removed.

# Conseils de réparation - Aspirateur sans sac

|   |           |
|---|-----------|
|  <b>A propos de ce document</b> ..... | <b>15</b> |
| 1.1 Informations importantes.....   | 15        |
| 1.1.1 Objectif.....   | 15        |
| 1.2 Explication des symboles.....   | 15        |
| 1.2.1 Niveaux de risque.....  | 15        |
| 1.2.2 Symboles de danger.....   | 15        |
| 1.2.3 Structure des indications d'avertissement.....  | 16        |
| 1.2.4 Symboles généraux.....  | 16        |
|  <b>Sécurité</b> .....                | <b>17</b> |
| 2.1 Consignes de sécurité générales.....  | 17        |
| 2.1.1 Tous les appareils électroménagers.....   | 17        |
|  <b>Schémas</b> .....                 | <b>18</b> |
| 3.1 Schéma de branchement.....  | 18        |
|  <b>Outils et aides</b> .....         | <b>19</b> |
|  <b>Réparation</b> .....              | <b>20</b> |
| 5.1 Retirer l'enrouleur de câble.....   | 20        |
| 5.2 Retirer le moteur du ventilateur.....   | 22        |
| 5.3 Retirer l'interrupteur marche/arrêt.....  | 24        |

# **i** A propos de ce document

## 1.1 Informations importantes

### 1.1.1 Objectif

Ces conseils de réparation aident le consommateur à résoudre les problèmes par lui-même. Ils contiennent des informations sur la manière d'échanger certaines pièces détachées, ainsi que des avertissements, les risques et les mesures de sécurité à respecter lors de l'auto-réparation.

Toute réparation non conforme peut entraver le bon fonctionnement et la sécurité de l'appareil et entraîner des risques et dangers pour l'utilisateur. Nous ne sommes pas responsables des dommages causés par ou survenant lors de l'auto-réparation, dans la mesure où ces dommages sont liés à la négligence de l'utilisateur ou au non-respect des instructions d'auto-réparation.

Lors de toute réparation sur du matériel électroménager, il convient de se conformer aux réglementations techniques habituelles. Il convient de respecter les exigences et prescriptions nationales. En cas de doute, il faut contacter notre service après-vente.

## 1.2 Explication des symboles

### 1.2.1 Niveaux de risque

Les niveaux de risque se composent d'un symbole et d'un terme d'avertissement. Le mot d'avertissement caractérise la gravité du danger.







| Niveau de dangerosité  | Signification   |
|--|---|
|  <b>DANGER</b>        | Le non respect de la consigne d'avertissement provoque la mort ou des blessures graves.       |
|  <b>AVERTISSEMENT</b> | Le non respect de la consigne d'avertissement peut provoquer la mort ou des blessures graves. |
|  <b>PRUDENCE</b>      | Le non respect de la consigne d'avertissement peut provoquer des blessures légères.           |
| <b>ATTENTION !</b>   | Le non respect de la consigne d'avertissement peut provoquer des dégâts matériels.            |

Tableau 1: Niveaux de risque

### 1.2.2 Symboles de danger

Les symboles de danger sont des représentations figuratives renseignant sur la nature du danger.

Ce document utilise les symboles de danger suivants:

| Symbole de danger   | Signification                             |
|---|---|
|  | Consigne d'avertissement générale         |
|  | Danger engendré par la tension électrique |
|  | Risque d'explosion                        |
|  | Risque de blessures par coupure           |

## **i** A propos de ce document





| Symbole de danger  | Signification                                    |
|--|--|
|  | Risque de blessures par écrasement               |
|  | Danger engendré par des surfaces très chaudes    |
|  | Danger engendré par un champ magnétique puissant |
|  | Danger engendré par un rayonnement non ionisant  |

Tableau 2: Symboles de danger

### 1.2.3 Structure des indications d'avertissement

Les consignes d'avertissement figurant dans ce document ont un aspect uniforme et une structure uniforme.

|  |   |
|--|---|
|  | <div style="background-color: red; color: white; padding: 2px; text-align: center;"><b>⚠ DANGER</b></div> <p><b>Type et source du danger !</b><br/>Conséquences possibles en cas de non-respect du danger / de l'avertissement.</p> <ul style="list-style-type: none"> <li>▶ Mesures et interdictions pour éviter le danger.</li> </ul> |
|--|---|

L'exemple suivant montre une consigne d'avertissement mettant en garde contre le risque d'électrocution. La mesure permettant d'éviter le danger est nommée.

|  |   |
|--|---|
|  | <div style="background-color: red; color: white; padding: 2px; text-align: center;"><b>⚠ DANGER</b></div> <p><b>Risque d'électrocution par des pièces conductrices de tension !</b><br/>Mort par électrocution.</p> <ul style="list-style-type: none"> <li>▶ Débrancher l'appareil du secteur minimum 60 secondes avant de démarrer la réparation.</li> </ul> |
|--|---|

### 1.2.4 Symboles généraux

Ce document utilise les symboles généraux suivants:







| Symbole général   | Signification   |
|---|---|
|  | Caractérisation d'une astuce particulière (texte et/ou graphique) |
|  | Caractérisation d'une astuce simple (texte seul)                  |
|  | Caractérisation d'un lien vers une vidéo                          |
|  | Caractérisation d'outils nécessaires                              |
|  | Caractérisation de conditions nécessaires                         |
|  | Caractérisation d'une condition (si... , alors ...)               |
|  | Caractérisation d'un résultat                                     |
| Start   | Caractérisation d'une touche ou surface de commande               |
| [00123456]  | Caractérisation d'une référence de pièce                          |
| Statut  | Caractérisation d'un texte affiché / fenêtre (sur l'afficheur)    |

Tableau 3: Symboles généraux



## 2.1 Consignes de sécurité générales

### 2.1.1 Tous les appareils électroménagers

#### **Risque d'électrocution en raison de pièces sous tension!**

- Des erreurs lors de réparations impliquant des composants électriques peuvent entraîner une décharge électrique!
- Débrancher l'appareil du secteur minimum 60 secondes avant de démarrer la réparation.
- Après la réparation, effectuer un test de sécurité selon VDE 0701 ou les réglementations spécifiques nationales.

#### **Risque de blessures par coupure sur des bords tranchants!**

- Porter des gants de protection.

#### **Risque de casse durant la réparation, maintenance, dépannage et SAV en raison de composants lourds et mobiles**

- Porter des chaussures de protection.
- Sécuriser les composants lourds contre le risque de chute.
- Ne pas coller les pièces du châssis sur les composants mobiles.

#### **Risque lié à la sécurité / fonction de l'appareil!**

- Utiliser uniquement des pièces détachées d'origine.

#### **Risque d'endommagement des composants sensibles aux décharges électrostatiques!**

- Ne pas toucher les modules, ni leur connexions et pistes conductrices.

### 3.1 Schéma de branchement

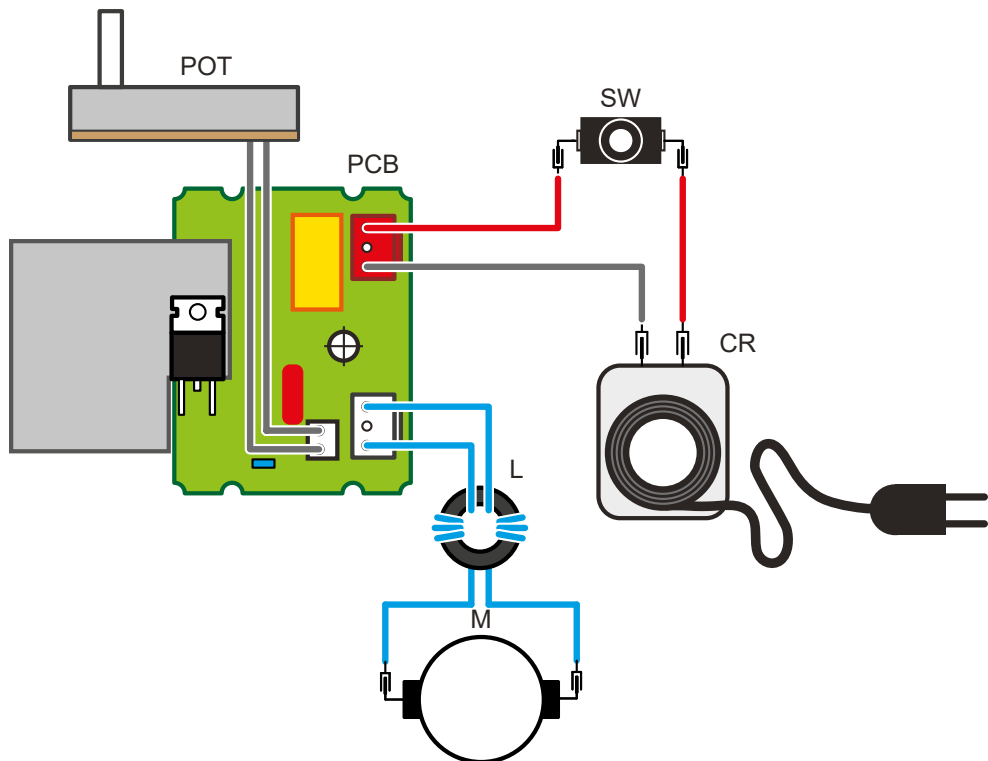

Fig. 1: Diagramme de connexion / pour variantes avec commande de puissance

- CR Enrouleur de câble
- SW Interrupteur M/A
- M Moteur ventilateur
- PCB Module de contrôle
- POT Potentiomètre slide
- L Anneau ferrite

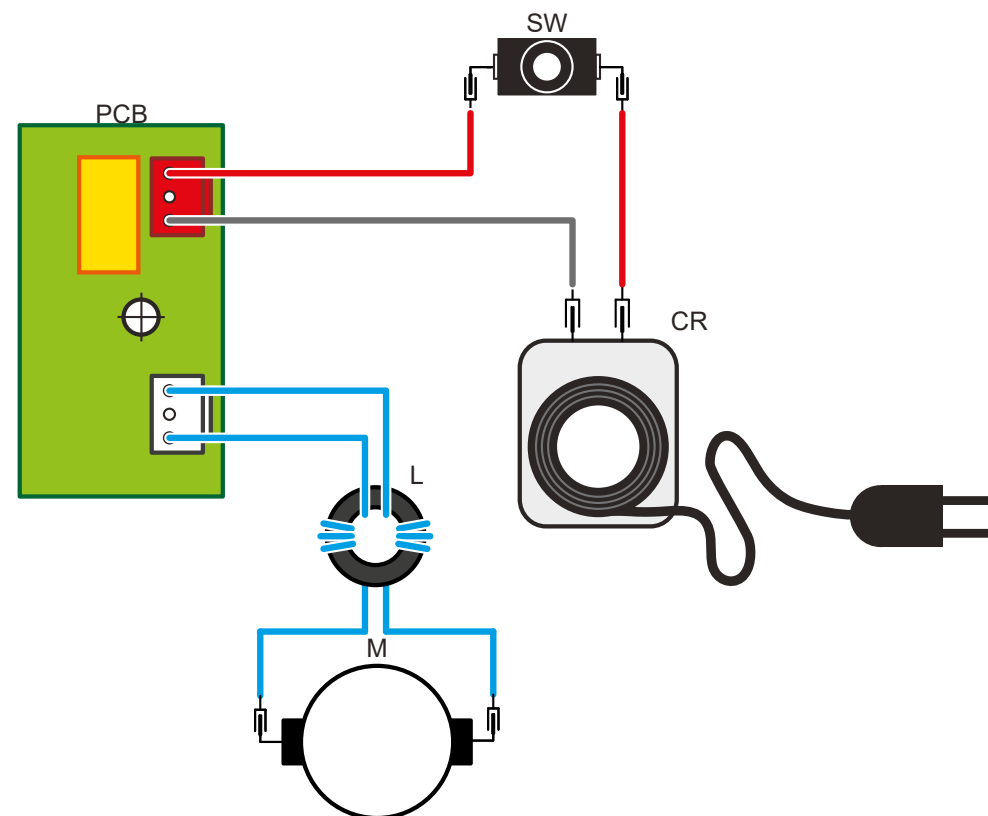



Fig. 2: Schéma de branchement / pour variantes sans commande de puissance

- CR Enrouleur de câble
- SW Interrupteur M/A
- M Moteur ventilateur
- PCB Module de contrôle
- L Anneau ferrite

## Outils et aides

| Désignation               | Détails                     | Images  |
|---------------------------|-----------------------------|---|
| Tournevis Philips PH2     |                             |   |
| Tournevis plat [00340612] | Lame 5 mm x 0.8 mm x 100 mm |  |

## 5.1 Retirer l'enrouleur de câble

### Outillage nécessaire:

- 🔧 Tournevis Philips PH2
- 🔧 Tournevis plat                      Lame 5 mm x 0.8 mm x 100 mm                      [00340612]

1.



### **⚠ DANGER**

**Risque d'électrocution par des pièces conductrices de tension !**  
Mort par électrocution.

- ▶ Débrancher l'appareil du secteur minimum 60 secondes avant de démarrer la réparation.



### **⚠ PRUDENCE**

**Arêtes vives !**  
Blessures par coupure

- ▶ Porter des gants de protection.



### **ATTENTION !**

**Composants sensibles aux décharges électrostatiques !**  
Défaut ou panne de composants en raison de charges électrostatiques.

- ▶ Avant tout contact et mesure de ces composants, utiliser un système de protection électrostatique (ex. bracelet de mise à la terre).
- ▶ Empêcher tout contact entre ces composants et les matériaux plastiques capables de supporter une charge (films, etc.).
- ▶ Maintenir les groupes de composants, modules et platines de sorte qu'il y ait le moins de contact possible avec les bandes conductrices ou connecteurs.
- ▶ Ne pas placer ces composants trop proches de moniteurs ou télévisions.
- ▶ Utiliser pour le transport uniquement des matériaux conducteurs ou l'emballage d'origine.

Débrancher l'appareil du secteur.

2. 1. Retirer six vis (1).
2. Retirer la section supérieure avec les éléments fixés (2).

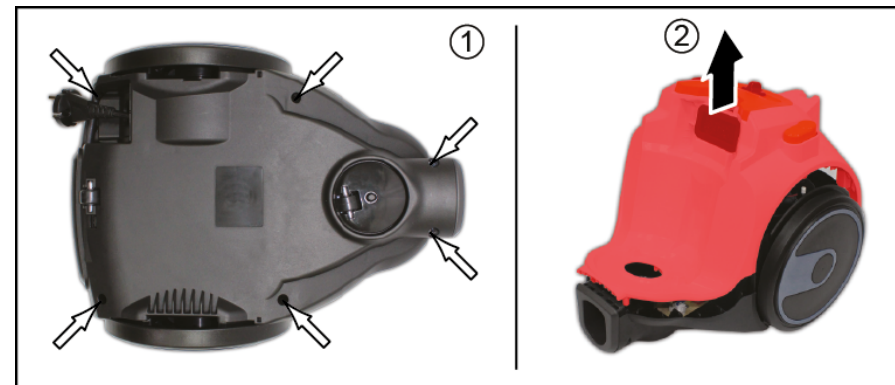

3. 1. Retirer l'enrouleur de câble.
2. Débrancher les connexions électriques.

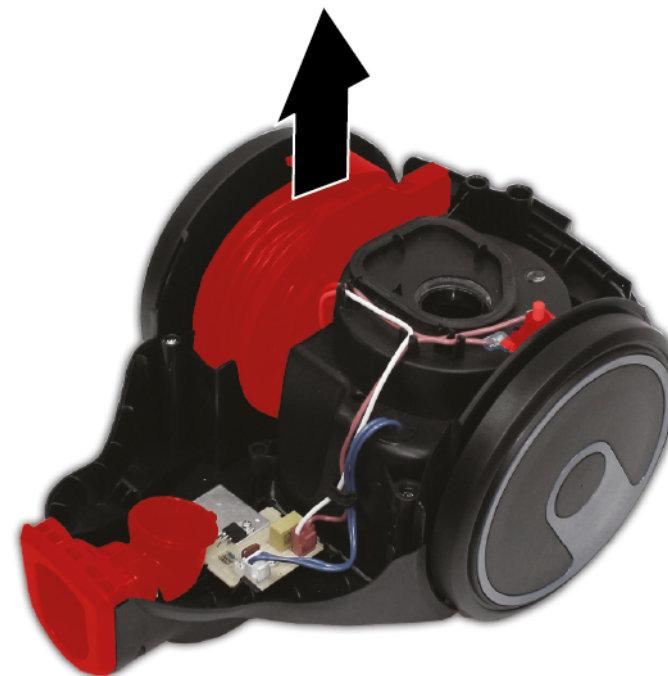

## Réparation

4. 1. Défaire le cache de l'enrouleur de câble.
2. Défaire le cordon d'alimentation.

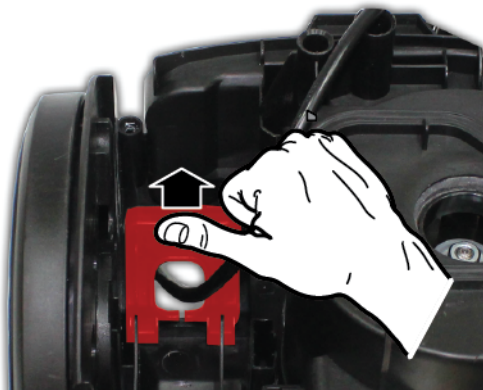

 L'enrouleur de câble est retiré.

## 5.2 Retirer le moteur du ventilateur

### Outillage nécessaire:

- 🔧 Tournevis Philips PH2
- 🔧 Tournevis plat      Lame 5 mm x 0.8 mm x 100 mm      [00340612]



### ⚠️ DANGER

**Risque d'électrocution par des pièces conductrices de tension !**  
Mort par électrocution.

- ▶ Débrancher l'appareil du secteur minimum 60 secondes avant de démarrer la réparation.



### ⚠️ PRUDENCE

**Arêtes vives !**

- Blessures par coupure
- ▶ Porter des gants de protection.



### ⚠️ ATTENTION !

**Composants sensibles aux décharges électrostatiques !**

Défaut ou panne de composants en raison de charges électrostatiques.

- ▶ Avant tout contact et mesure de ces composants, utiliser un système de protection électrostatique (ex. bracelet de mise à la terre).
- ▶ Empêcher tout contact entre ces composants et les matériaux plastiques capables de supporter une charge (films, etc.).
- ▶ Maintenir les groupes de composants, modules et platines de sorte qu'il y ait le moins de contact possible avec les bandes conductrices ou connecteurs.
- ▶ Ne pas placer ces composants trop proches de moniteurs ou télévisions.
- ▶ Utiliser pour le transport uniquement des matériaux conducteurs ou l'emballage d'origine.

1. Débrancher l'appareil du secteur.

2. 1. Retirer six vis (1).
2. Retirer la section supérieure avec les éléments fixés (2).

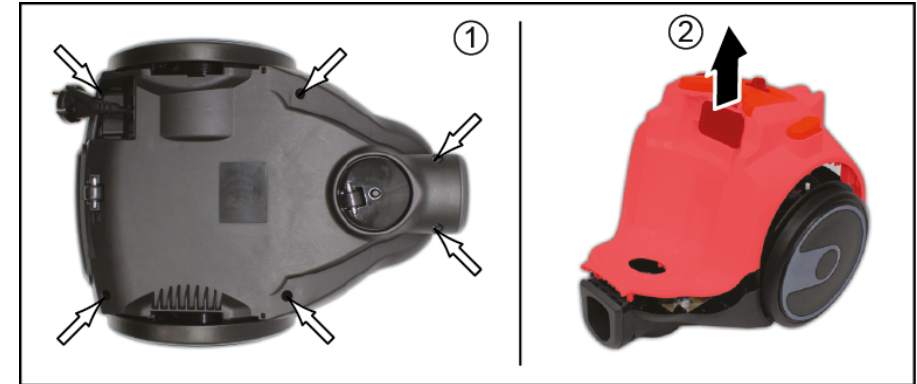

3. Retirer l'enrouleur de câble et débrancher les fils.

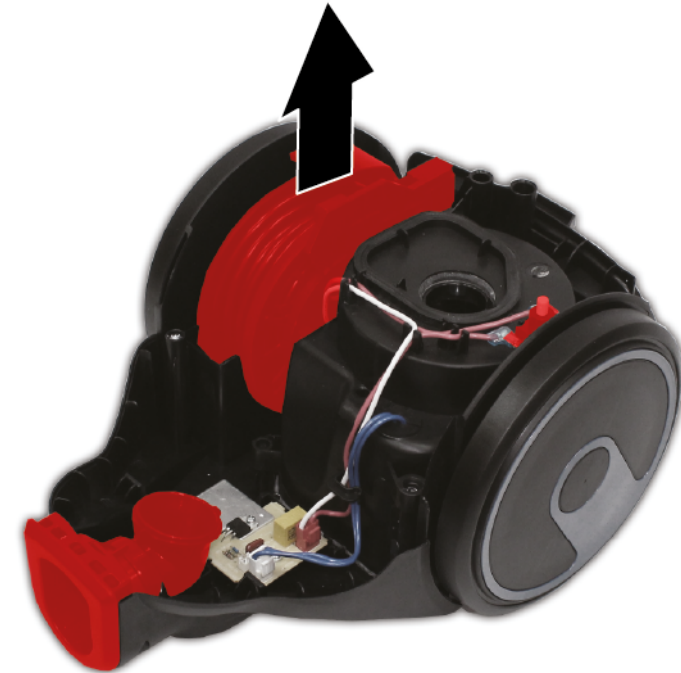

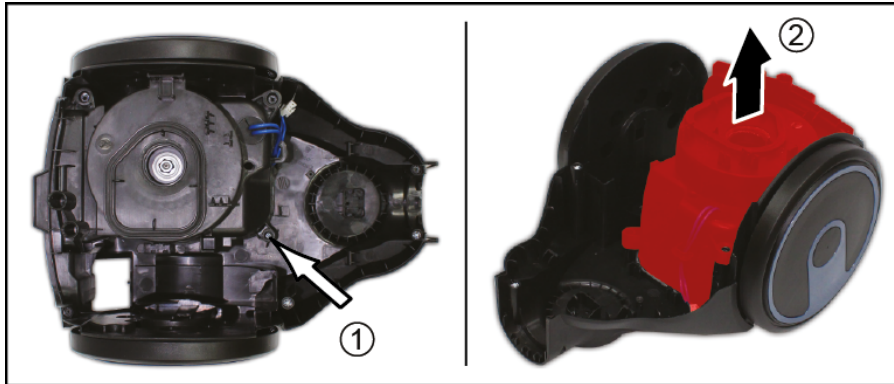

## Réparation

4. 1. Retirer la vis et débrancher les connexions électriques (1).
2. Retirer le boîtier du capuchon (2).

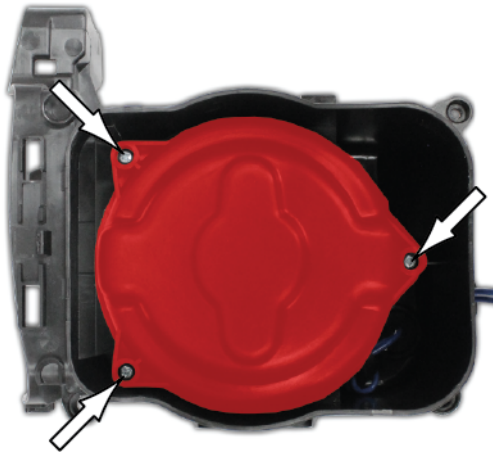

5. 1. Retirer trois vis.
2. Retirer le cache du moteur.



6. Retirer l'isolation acoustique.
  7. Débrancher les connexions électriques.
  8. Retirer le moteur du ventilateur avec les clapets.
  9. Séparer les clapets du moteur du ventilateur.
-  Le moteur du ventilateur est retiré.

## 5.3 Retirer l'interrupteur marche/arrêt

### Outillage nécessaire:

- 🔧 Tournevis Philips PH2
- 🔧 Tournevis plat                      Lame 5 mm x 0.8 mm x 100 mm                      [00340612]



### **DANGER**

#### **Risque d'électrocution par des pièces conductrices de tension !**

Mort par électrocution.

- ▶ Débrancher l'appareil du secteur minimum 60 secondes avant de démarrer la réparation.



### **PRUDENCE**

#### **Arêtes vives !**

Blessures par coupure

- ▶ Porter des gants de protection.



### **ATTENTION !**

#### **Composants sensibles aux décharges électrostatiques !**

Défaut ou panne de composants en raison de charges électrostatiques.

- ▶ Avant tout contact et mesure de ces composants, utiliser un système de protection électrostatique (ex. bracelet de mise à la terre).
- ▶ Empêcher tout contact entre ces composants et les matériaux plastiques capables de supporter une charge (films, etc.).
- ▶ Maintenir les groupes de composants, modules et platines de sorte qu'il y ait le moins de contact possible avec les bandes conductrices ou connecteurs.
- ▶ Ne pas placer ces composants trop proches de moniteurs ou télévisions.
- ▶ Utiliser pour le transport uniquement des matériaux conducteurs ou l'emballage d'origine.

1. Débrancher l'appareil du secteur.

2. 1. Retirer six vis (1).
2. Retirer la section supérieure avec les éléments fixés (2).

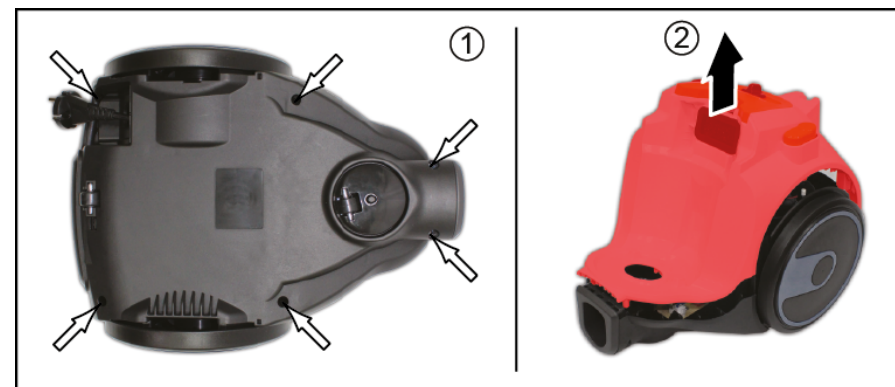



## Réparation

3. 1. Débrancher les connexions électriques.
2. Retirer l'interrupteur marche/arrêt.

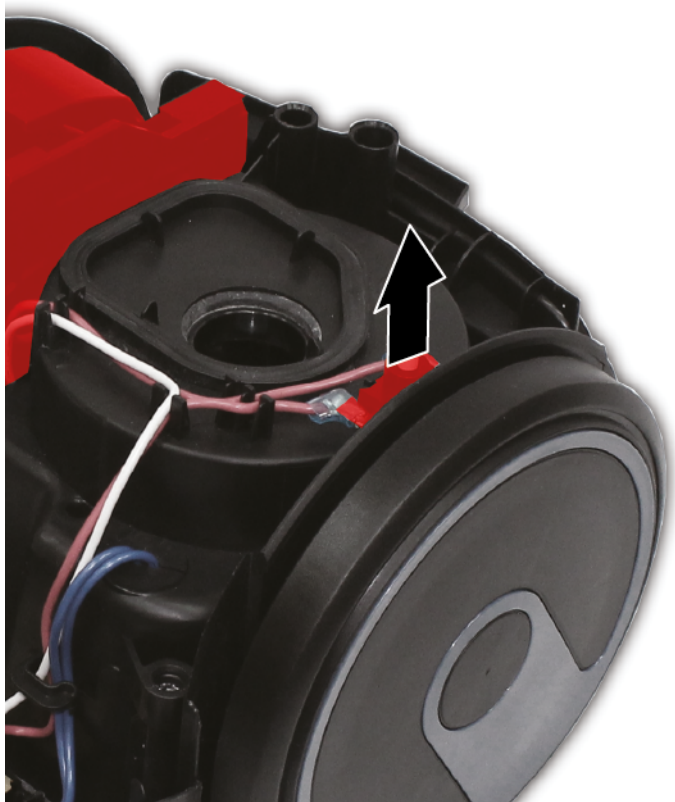

 L'interrupteur marche/arrêt est retiré.