

Register your new device on MyBosch now and get free benefits: [bosch-home.com/welcome](http://bosch-home.com/welcome)



# Mixer Grinder

MGM433..IN MGM434..IN

[en] Instruction manual Mixer Grinder

8001203291 (001217)  
  
 (excluding public holidays)  
 \* Mon-Sat: 8:00 am to 8:00 pm  
[www.bosch-home.com/in](http://www.bosch-home.com/in)  
 Toll Free 1-800-008-266-1880 \*  
 Mumbai 400093  
 MIDC, Andheri East  
 Plot No.103, Road No.12,  
 Arena House, 2nd Floor Main Building,  
 Manufacturing Pvt. Ltd.  
 BSH Household Appliances

## Overview

<b>Main unit</b>  Motor coupler Speed selector knob Rubber feet	<b>PoundingBlade</b>  <b>MaxxJuice extractor (fruit filter) only for MGM434..IN</b> 	<b>Spatula / Tool for fitting and removing blades</b> 	
<b>Big jar</b> 	<b>Medium jar</b> 	<b>Chutney jar</b> 	<b>Blender jar with MaxxJuice extractor (only for MGM434..IN)</b> 
<p><b>Note:</b>  <b>Fitting jar:</b> Place the jar on the top socket of the main unit, ensuring that the locks fit properly in the jar locking grooves of the top socket.  <b>Jar Lid:</b> Ensure that the lid gasket is properly fitted. Place the lid on top of the jar, gently press down and lock the lid onto the jar using the lid lock clamps. Hold the lid gently while operating.  <b>Speed control:</b> Turn the speed selector knob clockwise for speed 1, 2 or 3, as desired. Turn the speed selector knob anti-clockwise for a few seconds and release for momentary operation. Pulse is especially useful for applications such as grinding chutneys, crushing ice, etc.</p>			

2

- Handle the blades carefully, wash them under running water and do not rub with your hands.
- It is normal for the mixer grinder to become a little discoloured, especially when used with ingredients like turmeric. To avoid this, make sure that the ingredients do not come into contact with the mixer grinder body.
- Do not drop the main unit or jars.
- Do not use the jars as storage containers.

## Contents

Overview	2
Safety and important instructions	4
Know your mixer grinder	5
Jar capacity	5
Using the product	6
Safety systems	6
Operating your mixer grinder	7
Cleaning	7
Troubleshooting	8
Blade changing procedure	9
Blade selection	10
Dry grinding applications with PoundingBlade	11

**Congratulations on the purchase of your new Bosch TrueMixx Mixer Grinder. In doing so, you have opted for a modern, high-quality domestic appliance. You can find further information about our products on our web page.**

## Know your mixer grinder

Voltage and frequency	230 V AC, 50 Hz
Class of motor insulation winding wire	F class
Rating	30 minutes rating 5 min ON and 2 min OFF (Maximum 6 ON cycles)
Normal Load (in terms of recipe for 600 W Rating power)	200 g Urad Dal soaked in 450 ml water for 7-8 hours
Material of body	ABS
Material of jars	Stainless steel
Blade assembly	Stainless steel
Speed control	3 speed with pulse
Main cord	PVC flexible 2-core cord
Country of origin	India

## Jar capacity

Jar	Size	Rated Capacity		
		Dry	Wet	Liquidise
Big jar	1.5 litre	-	0.75 litre	1.0 litre
Medium jar	1.0 litre	0.5 litre	-	-
Chutney jar	0.4 litre	0.2 litre	0.2 litre	-
Blender jar	1.5 litre	-	-	1.0 litre

Minimum capacity for all the above jars is at least up to blade level.

5

## Big jar

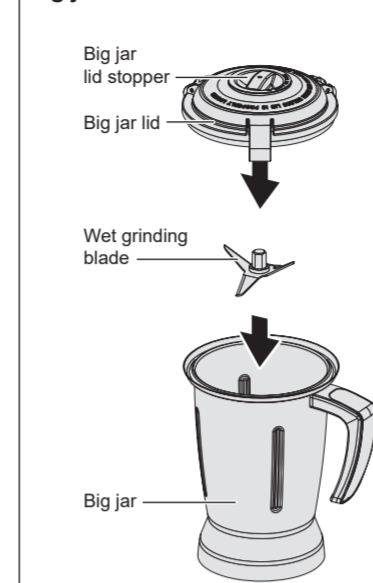

## Chutney jar

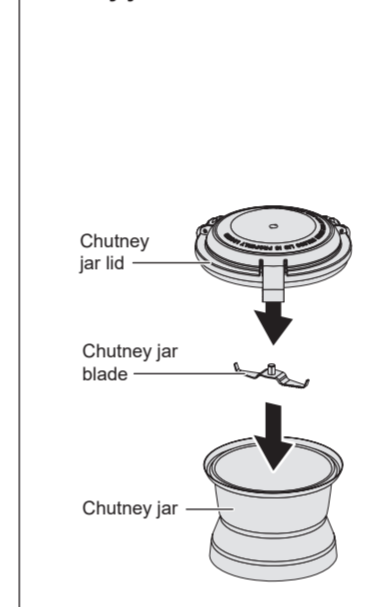

3

## Medium jar

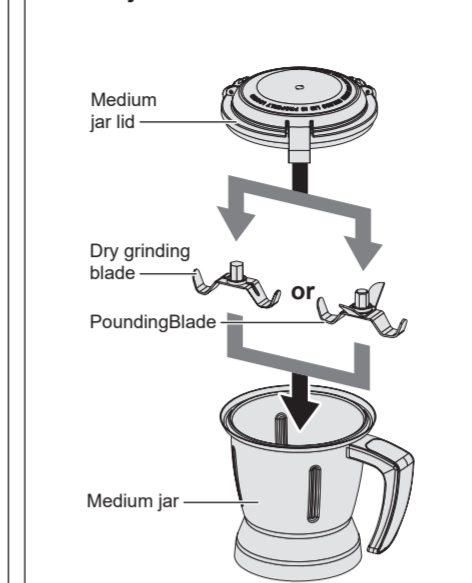

## Blender jar (only for MGM434..IN)

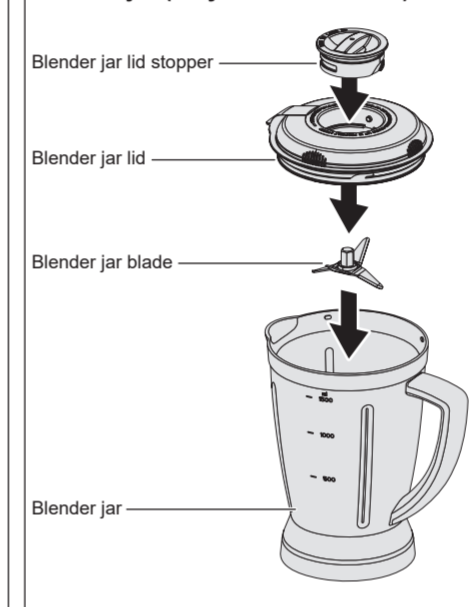

## Safety and important instructions

- Read and follow the instruction manual carefully and keep for later reference! Enclose these instructions when you give this appliance to someone else. If the instructions for correct use of the appliance are not observed, the manufacturer's liability for any resulting damage will be excluded.
- This mixer grinder is strictly for household use and not applicable for non-domestic and/or commercial use.
  - Please only use official Bosch parts and accessories with the Mixer Grinder. Never use these parts and accessories with any other appliances.
  - Check if the voltage indicated on the base of the mixer grinder corresponds to the local electrical mains voltage before you connect the appliance.
  - This appliance can be used by persons with reduced physical, sensory or mental capabilities or lack of experience and/or knowledge if they have been given supervision or instruction concerning use of the appliance in a safe manner and if they understand the hazards involved.
  - Keep children away from the appliance and connecting cable and do not allow them to use the appliance. Do not let children play with the appliance. Cleaning and user maintenance must not be performed by children.
  - Do not use the mixer grinder if the power cord and/or appliance are damaged. Only our customer service may repair the appliance, e.g. by replacing a damaged power cord, in order to avoid hazards.
  - Do not use the mixer grinder on a wet surface.
  - Keep the mixer grinder away from hot gas burners, electric hot plates or similar appliances.
  - The power cord must not come into contact with hot parts or be pulled across sharp edges.
  - Always ensure that speed selector knob is in the OFF position and the appliance unplugged before you remove or attach jars or accessories.
  - Blades should be fitted properly before running the mixer grinder.
  - Do not operate the mixer grinder without locking the dome or lid in place or with an empty jar.
  - Always unplug the mixer grinder before reaching into the jar with your fingers or any other object (such as a spatula).
  - Do not open the lid or dome when the mixer grinder is running.
  - Do not add solid ingredients when the mixer grinder is running.
  - Do not grind hot ingredients or sugar in the mixer grinder.
  - Do not overload the mixer grinder.
  - Do not leave the main unit unattended while in operation.
  - Always unplug the mixer grinder after use, or whenever the appliance is unsupervised or in the event of an error.
  - If the appliance/motor is getting too hot and you can feel hot air coming out of the side vent or bottom, switch off the mixer grinder and restart after 10 minutes.
  - Recommended time for grinding dry ingredients is up to 120 seconds. If you need finer powder please wait for 2 minutes and grind again. Warning – Risk of burns: Jars may heat up due to friction so never touch the metal part with bare hands immediately after grinding & always use the handle provided for moving the jar.
  - Do not run the mixer grinder for more than 5 minutes continuously. Wait for 2 minutes if you need to use it for longer.
  - Switch off the appliance if the motor stalls or smoke emanates from the appliance. If this continues, call the Bosch service center.
  - Never immerse the main unit in water or any other liquid. Do not rinse or wash in a dishwasher.

4

## Using the product

- How to fit/remove blades (big jar, medium jar, blender jar)**  
 Hold the coupler on the underside of the jar and with the spatula, tighten by rotating in an anti-clockwise direction to fit and clockwise to remove until the blade is securely locked/removed.

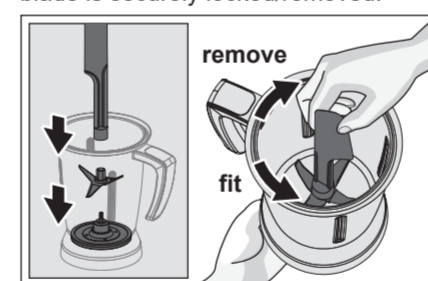

**Note:** If the coupler and/or some other parts are removed during removing the blade, please refer to → "Blade changing procedure" see page 9.

- How to fit jar to main unit**  
 Carefully insert the jar on top of the main unit. Ensure that the lock of the jar fits into the slot of the main unit. Rotate the jar clockwise until it locks and use the handle to lock.

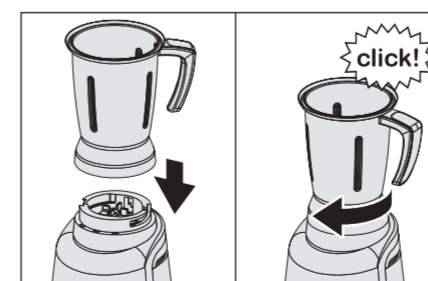

- How to use MaxxJuice extractor (only for MGM434..IN)**  
 For mixing smoothies use the blender jar with the blender jar blade. Put the MaxxJuice extractor in the blender jar as shown and press it gently down.

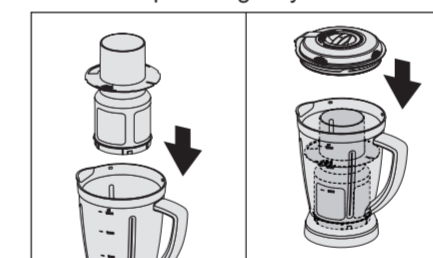

## Safety systems

The Bosch TrueMixx Mixer Grinder is fitted with an overload protector (OFF) mechanism to prevent the motor burning out due to overloading. In case of excess loading with ingredients in the jar, very thick paste or low voltage conditions, your Bosch mixer grinder automatically switches off and the red knob on the bottom of the mixer grinder will spring out. If this happens, switch off your mixer grinder and remove the excess ingredients. Add sufficient water if dealing with thick paste and wait for 2-3 minutes. Press the red reset button and start the mixer grinder again.

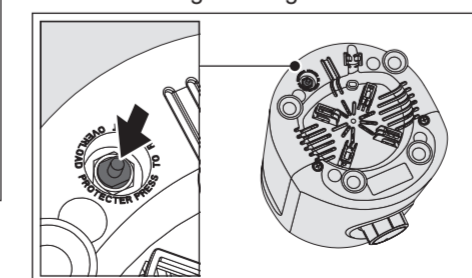

## Operating your mixer grinder

### Before using for the first time / using after a long time

- Before using the mixer grinder for the first time or using it after a long time, thoroughly clean all the parts that come into contact with food ingredients.
- Rotate the motor shaft by hand via the motor coupler, on top of the main unit. The motor shaft should rotate freely.
- Check that the speed selector is in the OFF position.
- Place the main unit on a smooth, stable and clean surface.

### Caution!

Never place plastic, paper or cloth under the mixer grinder as it may block the ventilation holes.

- Connect the main plug to the wall socket. Switch on the main supply and turn the speed selector knob to the required position and speed. After operation, turn the speed selector knob to the OFF position and check. Repeat until the desired results are obtained.
- You may observe some minor oil spillage in the Jars and Jar sockets during first two to three operations. This is normal. Thoroughly clean the minor oil spillages with water and wipe dry with soft cloth.

## Preparation of ingredients

- Important!**  
Cool down any hot ingredients before putting in the jar.
- Cut large ingredients into small pieces approx. 2 cm in size before mixing/grinding.

## Regular use and operation

- For blending/liquidising/puréeing use 'Pulse' on the speed selector knob. This will activate Pulse until you release the button. Use position 1-3 for continuous operation.  
1 = Lowest operating speed  
3 = Highest operating speed  
Hold down the jar lid gently while your mixer grinder is in operation.
- After switching off the mixer grinder, wait until the blade stops rotating completely and only then remove the lid or insert the spatula.

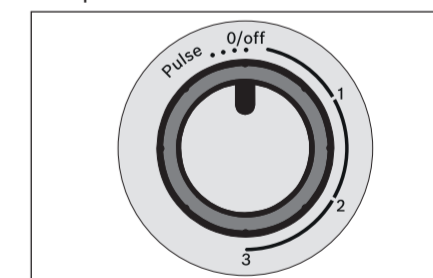

- Before removing the jar from the main unit, ensure that the power supply is disconnected.
- Avoid using your hand to fill or clean jars. It is safer and more hygienic to use the spatula.
- Avoid storing food in the jar.

6

7



## Cleaning

### ⚠ Risk of electric shock!

Never immerse the main unit in water or any other liquid or pour any liquid over it. Never hold under running water and do not clean in the dishwasher.

To keep your Bosch mixer grinder sparkling clean, just follow these steps.

1. First remove the mains plug from the electrical socket.
2. Clean the main unit using a damp/wet cloth. Do not use abrasive cleaning agents.
3. Hold the jar under running water for a minute after each use to remove the residue.

4. Remove the jars after each use and wash in soapy water. Then rinse with clean water.
5. Dry the parts thoroughly with a clean soft cloth.
6. Always keep/store the jars upside down.
7. We recommend you clean your Bosch mixer grinder immediately after use for easier removal of residue.
8. Do not immerse the main unit in water or any other liquid or pour liquid over it.
9. Regularly clean the jars and gaskets after each use for proper hygiene and performance of the Mixer Grinder.
10. After every use of the Mixer Grinder, pour small amounts of hot water into the jars to remove the leftover or sticky substances.

## Troubleshooting

Trouble	Reason	Check
Mixer grinder does not switch on	No power supply.	Check mains supply.
	Overloading with ingredients.	Remove some ingredients, process smaller quantities.
	Overload protection mechanism is activated.	Press the red reset button on the bottom of the mixer grinder.
	Other than above mentioned.	Call Bosch service centre.
Time taken for mixing/blending is very long	Loose blade or wrong blade selection.	Check blade and choose blade as per grinding requirements. Tighten properly with spatula/spanner.
	Overloading of mixer.	Remove some ingredients, process smaller quantities.
	Unit overheating	Check and remove if any heat source nearby. Place the mixer on a level surface.
The coupler and/or some other parts are removed during removing the blade.	External heat source.	Check and remove if any heat source nearby.
	Uneven surface that blocks air vents.	Place the mixer on a level surface.
Overloading with ingredients.	Remove some of the ingredients and add in small quantities.	
	This is normal and may happen during changing the blade.	→ "Blade changing procedure" see page 9.

8

## Rasam powder

### Ingredients

- Coriander seeds – 2 cups (50 g)
- Tur dal – 2/3 cup (50 g)
- Dried red chillies – 6-8
- Black pepper – 1/2 cup (30 g)
- Cumin seeds (jeera) – 3 tsp (15 g)
- Dry-roast the coriander seeds and tur dal in a pre-heated pan on a low/medium heat until the mixture of ingredients turns brown/slightly dark. Then add black pepper, dried red chillies and cumin, one by one, in this order and roast the entire mixture for a bit longer.
- After roasting, allow the ingredients to cool to room temperature.
- Pour the roasted ingredients into the medium jar fitted with the PoundingBlade and grind as per the table below.

Speed	Time
Pulse	-
1	10 seconds
2	10 seconds
3	-
Remarks	Stop and scoop off if ingredients stick to wall of jar

## Idli podi

### Ingredients

- Sesame seeds – 1/2 tsp (2 g)
- Bengal gram (chana dal) – 1/2 cup (100 g)
- Urad dal – 1/2 cup (100 g)
- Dry red chillies – 4-5 nos
- Peeled garlic cloves – 5 nos
- Spring curry leaf – 1 nos
- Asafoetida – 1 pinch
- Salt as per taste
- Dry-roast the above ingredients in a pre-heated pan on a low/medium heat until there is enough aroma from the ingredients.
- After roasting, allow the ingredients to cool to room temperature.
- Pour the roasted ingredients into the medium jar fitted with the PoundingBlade and grind as per the table below.

Speed	Time
Pulse	5 times (for about 1 second each pulse)
1	15 seconds
2	10 seconds
3	-
Remarks	Stop and scoop off if ingredients stick to wall of jar

## Blade changing procedure

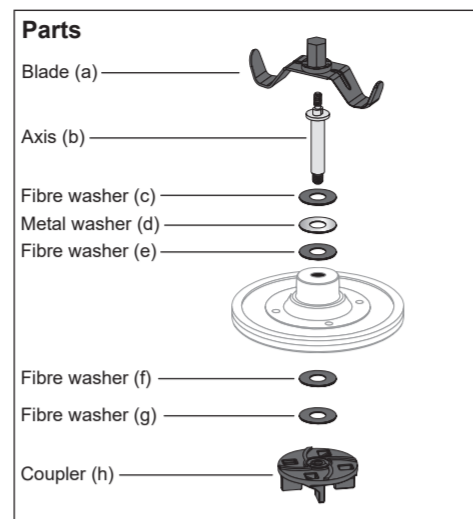

### Removing the blade

1. Hold the coupler on the underside of the jar and using spatula rotate the blade nut in a clockwise direction.

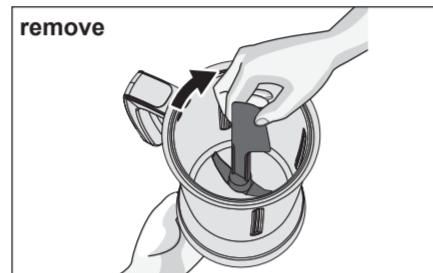

9

## Garam masala

### Ingredients

- Cloves – 16 (9 g)
- Cumin seeds (shahi jeera) – 1 tbsp (27 g)
- Bay leaf – 4-5 (3 g)
- Green cardamom – 1 tsp (5 g)
- Black cardamom – 1/2 tsp (5 g)
- Star anise – 2 tbsp (6 g)
- Mace 8 (3 g)
- Cinnamon – 15-16 leaves (9 g)
- Black pepper – 7 g
- Lichen (pathar ka phool) – 2 g
- Dry-roast the above ingredients in a pre-heated pan on a low/medium heat until there is enough aroma from the ingredients. Add cumin seeds (shahi jeera) and bay leaves at the end.
- After roasting, allow the ingredients to cool to room temperature.
- Pour the roasted ingredients into the Medium Jar fitted with the PoundingBlade and grind as per the table below.

Speed	Time
Pulse	10 times (for about 1 second each pulse)
1	15 seconds
2	-
3	-
Remarks	Stop and scoop off if ingredients stick to wall of jar

**Note:** The timings in all the above recipes are indicative to obtain the desired level of fineness/coarseness close to the traditional grinding method. However, you may adjust the timings as per your requirements.

## Dane ki chutney

### Ingredients

- Peanuts roasted – 120 g
- Red chilli powder – 6 g
- Salt to taste – 3 g
- Cumin seeds – 4 g
- Coriander seed – 5 g
- Oil – 2.5 ml
- Asafoetida powder – 2 pinch (0.5 g)
- Dry-roast the above ingredients in a pre-heated pan on a low/medium heat until there is enough aroma from the ingredients.
- After roasting, allow the ingredients to cool to room temperature.
- Pour all the roasted ingredients (except the peanuts) into the medium jar fitted with the PoundingBlade and grind as per the table below.
- Then add the roasted peanuts to the mixture and grind again as per following table.

Speed	Time
Pulse	3-4 times
Stop	Scoop and mix

**Note:** The timings in all the above recipes are indicative to obtain the desired level of fineness/coarseness close to the traditional grinding method. However, you may adjust the timings as per your requirements.

## Disposal

- Save the environment - dispose your e-waste in an environmentally friendly manner by contacting designated e-waste collection centers. Please check our website <https://www.bosch-home.in/> for more details.

Changes reserved.

2. If the coupler is removed (the blade sticks together with the axis), washers will come off when you take blade assembly out of the jar.

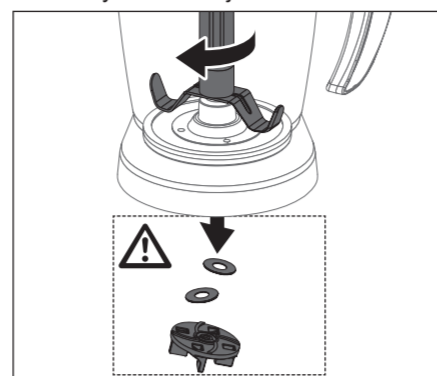

⚠ Small parts – be careful not to lose or forget them.

3. Take the blade assembly out of the jar.

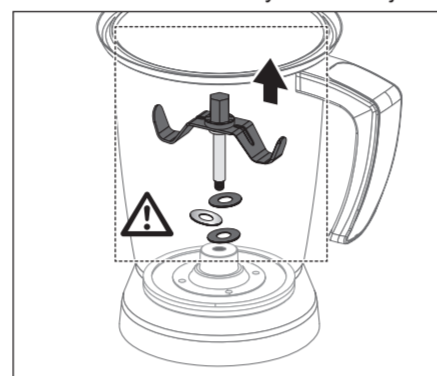

4. Hold the blade assembly with cloth. Using spatula untighten the blade nut (turn in a clockwise direction).

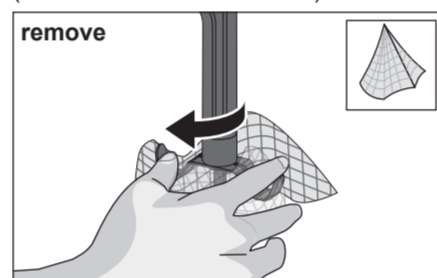

## Fitting the blade

Do this in reverse order as described in Chapter "Removing the blade" (see page 9).

5. Put selected blade onto the axis and tighten the blade nut with the spatula (rotate in anti-clockwise direction).

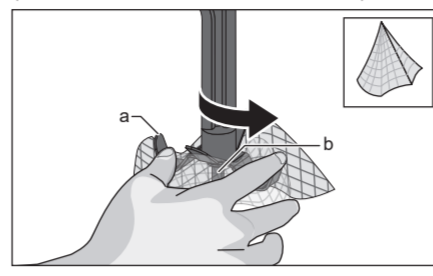

6. Put fibre washer, metal washer and another fibre washer onto the axis. Put the assembly into the jar.

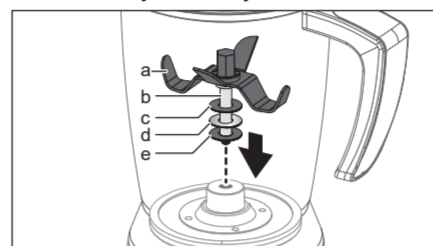

## Blade selection

Your Bosch TrueMixx Mixer Grinder comes with a special PoundingBlade. Use this blade to prepare dry grinding applications for a perfect authentic taste.

Blade	Jar	Application
PoundingBlade	Medium	Sambhar masala, garam masala, rasam powder, puliyodharai masala, idli podi
Dry grinding blade	Medium	Turmeric, coriander seeds, black pepper, cumin, red chilli powder, almonds, rice powder
Wet grinding blade	Big	Idli batter, dosa batter, tomato purée, onion paste (for best results use Dry grinding blade)
Chutney blade	Chutney	Ginger garlic paste, coconut chutney, coriander chutney
Blender jar blade (only for MGM434..IN)	Blender	Chickoo milk shake, banana milk shake, soya milk, pomegranate juice, water melon juice, orange/sweet lime juice, coconut milk extraction, tamarind juice, etc.

10

## WARRANTY

1. This product is warranted by the company (warranty) to be free from defects in materials and workmanship for a period of 2 years from the date of purchase (warranty period)
2. This product is covered under warranty against any manufacturing defect or workmanship for a period of **TWO YEARS** from the date of purchase. Should a defect develop during the warranty period, BOSCH undertakes to repair the appliance FREE OF CHARGE through any of the authorised service centres.
3. Warranty and service: For any information, grievances or queries please contact our customer care helpline: 1-800-266-1880, or write to us at [service.in@bosch-home.com](mailto:service.in@bosch-home.com). The company will register your service request and retain a computer record of your service request. To make a warranty claim, you must provide proof of purchase.
4. CLAIM:
  - a. The claim must be made within the warranty period.
  - b. Bosch will repair or replace any defective parts and correct any problems resulting from poor workmanship free of charge.
  - c. Service to the product shall be carried out at your home or the store, whereby the customer has to take the product to the store where the product was purchased at the purchaser's risk, responsibility and cost.
  - d. While the company will make every effort to carry out the necessary repairs at the earliest opportunity, the company is under no obligation to do so within a stipulated time period. Claims, if any, to this warranty shall in no case exceed the purchase price of the product.
  - e. In case of repairs or replacement of any part(s) of the product, this warranty will thereafter continue and remain in force only for the unexpired period of the warranty.
  - f. Replacement of parts would be purely at the discretion of the company alone. If the entire product is being replaced (subject to the sole discretion of the company), the same model will be replaced, and in the event such model has been discontinued, it shall be replaced with the model of equivalent price at the time of purchase.
5. This warranty shall be rendered null and void if:
  - a. The product is physically damaged
  - b. The product is modified, maintained or repaired by a party not authorised by Bosch.
  - c. The product is installed, maintained and operated in ways other than as recommended by Bosch.
  - d. The product is used for commercial purposes.
  - e. The product is faulty or damaged due to electrical faults external to the product.
  - f. Malfunctions or damage resulting from insects, natural calamities, fire and/or accidents.
  - g. The model number, serial number or warranty stickers have been removed or tampered with.
  - h. In case any spare part or any other part is used in the functioning of the appliance which does not comply with the safety parameters approved by Bosch.
6. Warranty limitations
  - a. The warranty is not transferable from one user/customer to another.
  - b. The Bosch warranty does not entail a warranty of functionality or any obligation to repair or replace a defective product if that defect is a result of physical breakage, improper installation or connections, electrical faults external to the product, misuse or unauthorised modification of the product.

**IMPORTANT NOTE:** This product is designed for sale and use in India only. The applicability of conditions as provided for claiming Warranty, are valid for use in India not outside of India.

## Dry grinding applications with PoundingBlade

Use the PoundingBlade fitted with the medium jar for the following recipes:

### Sambhar masala

- Bengal gram (chana dal) – 4 tbsp (72 g)
- Black gram (urad dal) – 2 tbsp (36 g)
- Coriander seeds – 4 tbsp (27 g)
- Cumin seeds (jeera) – 2 tsp (9g)
- Fenugreek seeds (methi) – 1 tsp (5 g)
- Dry coconut – 8 tbsp (38 g)
- Dry red chillies – 10-15 (10 g)
- Spring curry leaf – 3 leaves
- Dry-roast the above ingredients in a pre-heated pan on a low/medium heat until there is enough aroma from the ingredients.
- After roasting, allow the ingredients to cool to room temperature.
- Pour the roasted ingredients into the medium jar fitted with the PoundingBlade and grind as per the table below.

Speed	Time
Pulse	5 times (for about 1 second each pulse)
1	10 seconds
2	10 seconds
3	-
Remarks	Stop and scoop off if ingredients stick to wall of jar

11

## Customer Service

Regardless of the nature of your concern, you can always be sure of personal attention from the Bosch Customer Service: on the internet and on the phone.

[www.bosch-home.com/in](http://www.bosch-home.com/in)

1-800-266-1880 (toll-free)

E-mail: [service.in@bosch-home.com](mailto:service.in@bosch-home.com)

## WARRANTY CARD



Customer's Name		
Address		
City	Pin	State
Telephone	Mobile	
E-mail	Model/E-Nr	
Serial No.		
Date of Purchase	Date of Expiry	
Dealer's Name		
Dealer's Signature and Stamp		Customer's Signature

**Note:** Warranty will start from the date of purchase.

12

13