



Register your new Bosch now:
www.bosch-home.com/welcome



MCM3...AU
MultiTalent 3



BOSCH



For your safety

Before use, read these instructions carefully in order to become familiar with important safety and operating instructions for this appliance. If the instructions for correct use of the appliance are not observed, the manufacturer's liability for any resulting damage will be excluded.

This appliance is designed for processing normal household quantities in the home or similar quantities in non-industrial applications. Non-industrial applications include e.g. use in employee kitchens in shops, offices, agricultural and other commercial businesses, as well as use by guests in boarding houses, small hotels and similar dwellings.

Use the appliance for processing normal amounts of food for the household; see "Recipe examples" section.

This appliance is suitable for mixing, kneading, beating, cutting and shredding food. Other applications are possible if the accessories approved by the manufacturer are used. It must not be used for processing other objects or substances. Use the appliance with original accessories only. Please keep the operating instructions in a safe place. If passing on the appliance to a third party, always include the operating instructions.

General safety instructions

Risk of electric shock

The appliance must not be used by children.

The appliance and its power cord must be kept away from children.

Appliances can be used by persons with reduced physical, sensory or mental capabilities or lack of experience and knowledge if they have been given supervision or instruction concerning use of the appliance in a safe way and if they understand the hazards involved. Children shall not play with the appliance.

Connect and operate the appliance only in accordance with the specifications on the rating plate. Only use the appliance indoors at room temperature and up to 2000 m above sea level. Do not use the appliance if the power cord and/or appliance are damaged.

Before replacing accessories or additional parts, which move during operation, switch off the appliance and disconnect from the power supply. Always disconnect the appliance from the supply if it is left unattended and before assembling, disassembling or cleaning.

Do not place the power cord over sharp edges or hot surfaces.

To prevent injury, a damaged power cord must be replaced by the manufacturer or his customer service or a similarly qualified person. Only our customer service may repair the appliance.

Safety instructions for this appliance

⚠ Risk of injury

⚠ Risk of electric shock

If the power is interrupted, the appliance remains switched on and restarts when the power is restored.

Never immerse the base unit in liquids or place under running water and do not clean in the dishwasher.

Before rectifying a fault, pull out the mains plug.

⚠ Risk of injury from the rotating tools!

While the appliance is operating, never place fingers in the mixing bowl. Always use the pusher for adding ingredients.

After switching off, the drive continues running for a short time.

Change tools only when the drive is at a standstill.

⚠ Risk of injury from sharp blades/rotating drive!

Never reach into the attached blender jug!

Do not remove/attach the blender jug until the drive has stopped. Do not remove/attach the universal cutter jug until the drive has stopped.

⚠ Risk of injury from sharp blades!

Do not touch blades of the universal blade with bare hands. When not in use, always store the universal blade in the blade guard. Clean them with a brush.

Do not grip the sharp blades or edges of the cutting discs. Grip the discs by the plastic part in the centre only!

Do not place fingers in the feed tube. Only use the pusher when adding more ingredients. Do not touch blades of the blade insert with bare hands. Clean them with a brush.





⚠ Risk of scalding!

If processing hot liquids, steam escapes through the funnel in the lid. Add a max. 0,4 litres of hot or frothing liquid.

⚠ Risk of injury!

Never assemble accessories on the base unit.

Explanation of the symbols on the appliance or accessory

	Caution! Rotating tools. Do not place fingers in the feed tube.
	Lock blade insert in the blender or universal cutter jug.
	Remove blade insert from the blender or universal cutter jug.
	Blade insert with blender/cutting blade
	Blade insert with grinding blade

Congratulations on the purchase of your new Bosch appliance. You can find further information about our products on our website.

Contents

For your safety	3
Overview	5
Operation	6
Cleaning and servicing.....	8
Troubleshooting	9
Storage.....	9
Disposal.....	9
Guarantee	9
Recipes / Ingredients / Processing	10

Overview

The instructions describe different features of the appliance. **Figure 1** shows an overview of the model.

Please fold out the illustrated pages.

Fig. 1

Base unit

1 Rotary switch

0/off = Stop

M = Instantaneous switching at maximum speed, hold switch for required blending duration.

Settings 1–2, Operating speed:

1 = low speed – slow,

2 = high speed – fast.

2 Drive

3 Cord store

4 Bowl

5 Tool holder

6 Tools*

a Universal blade with blade guard

b Kneading hook

c Chopping disc

7 Cutting discs*

a Slicing reversible disc – thick/thin

b Shredding reversible disc – coarse/fine

c Reversible slicing/shredding disc

8 Lid

a Filler opening

b Pusher

Accessories*

9 Blade insert with blender/cutting blade and seal

10 Blade insert with grinding blade and seal

11 Universal cutter jug

12 Blender jug

13 Lid for blender

a Filler opening

b Funnel-shaped stopper

* for some models:

With the universal cutter use the appliance at full power (according to the recipe). You can find the recipe on the illustrated pages (**Fig. 5**).

If the universal cutter is not included with the hand blender, it can be ordered from customer service (order no. 12005833).

Operation

Before operating the appliance and accessories for the first time, clean thoroughly; see "Cleaning and servicing".

Preparation

- Place the base unit on a smooth, clean surface.
- Pull cable out of the base unit to the required length.

Important information

- Use only the rotary switch to switch the appliance on or off.
- Never switch the appliance off by rotating the bowl, the blender or a tool.
- Do not switch the appliance on unless tools or accessories have been completely attached.

Bowl with accessories/tools

⚠ Risk of injury from the rotating tools!

While the appliance is operating, never place fingers in the mixing bowl. Always use the pusher for adding ingredients. After switching off, the drive continues running for a short time. Change tools only when the drive is at a standstill.

Warning!

When working with the bowl, the appliance cannot be switched on until the bowl has been attached and the lid has been attached and screwed on tight.

Universal blade

for cutting, mincing, mixing.



⚠ Risk of injury from sharp blades!

Do not touch blades of the universal blade with bare hands. When not in use, always store the universal blade in the blade guard. Grip the universal blade by the edge of the plastic handle only.

Kneading hook

for kneading dough and mixing-in ingredients that ought not be cut (e.g. raisins and chocolate chips).



Chopping disc

for cream, egg white and mayonnaise.



Fig. 8

- Attach the bowl (arrow on bowl on dot on the appliance) and rotate as far as possible in a clockwise direction () .
- Insert tool holder into the bowl.
- Insert universal blade, whisking disc or kneading hook into the tool holder and release.

Note position of the tools when inserting them! Press tools all the way down.

Warning!

Do not add ingredients until the tools have been inserted.

- Add ingredients.
- Attach lid with pusher (match arrow on lid on dot on bowl) and rotate in a clockwise direction () . Lid lug must be located fully in the slot in the bowl handle.
- Insert the mains plug.
- Set the rotary switch to the desired setting.
- To add more ingredients, set the rotary switch to **0/off** .
- Remove the pusher and add ingredients through the feed tube. Pusher can be used as a measuring cup.

Cutting discs

⚠ Risk of injury from sharp blades!

Do not grip the sharp blades or edges of the cutting discs. Take hold of discs by the edge only! Do not place fingers in the feed tube. Only use the pusher when adding more ingredients.

Slicing reversible disc – thick/thin



for slicing fruit and vegetables. Process at setting 1.

Identification on the reversible slicing disc: "grob" for the thick cutting side, "fein" for the thin cutting side

Warning!

The reversible slicing disc is not suitable for slicing hard cheese, bread, rolls or chocolate. Slice boiled, waxy potatoes only when they are cold.

Shredding reversible disc – coarse/fine



for shredding vegetables, fruit and cheese, except for hard cheese (e.g. Parmesan).

Process at setting 1.

Designation on the reversible shredding disc: “2” for the coarse shredding side “4” for the fine shredding side

Warning!

The reversible shredding disc is not suitable for shredding nuts. Shred soft cheese with the coarse side only at setting 2.

Reversible slicing/shredding disc



for slicing and shredding fruit, vegetables and cheese.

Process at setting 2.

Note: Do not process any hard foods using the slicing/grating reversible disc as this may blunt the blade. Use the slicing reversible disc (thick/thin) for this purpose.

Fig. C

- Attach the bowl (arrow on bowl on dot on the appliance) and rotate as far as possible in a clockwise direction ()
- Insert tool holder into the bowl.

Depending on the required use:

- Place cutting disc on tool holder. Turn required slicing/shredding side face up. Place disc on the disc holder so that the drivers on the tool holder grip the opening in the discs.
- Attach lid with pusher (match arrow on lid to arrow on bowl) and rotate in a clock-wise direction ()
- Lid lug must be located fully in the slot in the bowl handle.
- Insert the mains plug.
- Set the rotary switch to the desired setting.
- Fill with contents which are to be sliced or shredded.
- When adding contents which are to be sliced or shredded, apply only light pressure to the pusher. Remove the pusher and add ingredients through the feed tube.

Warning!

Empty the bowl before it becomes so full that the cutting or grating contents reach the carrier disc.

After using the appliance

- Set the rotary switch to **0/off**.
- Remove mains plug.
- Rotate the lid in an anti-clockwise direction and remove.
- Remove tool:
 - Take tool holder together with universal blade, whisking disc or kneading hook out of the bowl. Remove the tools from the tool holder.
- Take out the cutting discs by the plastic stud in the centre. Take tool holder out of the bowl.
- Rotate bowl anti-clockwise and remove.
- Clean all parts, see “Cleaning and servicing”.

Blender

Blade insert with blender/cutting blade for mixing liquid or semi-solid food, for cutting/chopping raw fruit and vegetables, for puréeing food.

Risk of injury from sharp blades / rotating drive!

Never place fingers in the attached blender! Do not remove/attach the blender until the drive is at a standstill. Do not touch blades of the blade insert with bare hands. Clean them with a brush.

Risk of scalding!

If processing hot liquids, steam escapes through the funnel in the lid. Add a max. 0,4 litres of hot or frothing liquid.

Warning!

Blender may be damaged. Do not process deep-frozen ingredients (except ice cubes). Do not operate blender when empty.



Fig. D

- Place seal on the blade insert. Ensure that the seal is positioned correctly.

Important information

If the seal is damaged or not correctly positioned, liquid may run out.

- Insert blade insert with blender/cutting blade into the blender jug and lock anti-clockwise ()
- Turn blender jug over (blade insert face down).



- Attach the blender jug (match arrow on the jug to the arrow on the appliance ) and rotate as far as possible in a clockwise direction (.
- Add ingredients.
Maximum capacity, liquid = 1.0 litres (frothing or hot liquids max. 0.4 litres).
Optimal processing capacity – solids = 80 g.
- Attach lid and press firmly. Hold lid while working.
- Insert the mains plug.
- Set the rotary switch to the desired setting.
- To add more ingredients, set the rotary switch to **0/off**.
- Remove the lid and add ingredients or
■ remove the funnel and gradually add solid ingredients through the refill opening or
■ pour liquid ingredients through the funnel.

After using the appliance

- Set the rotary switch to **0/off**.
- Remove mains plug.
- Rotate the blender in an anti-clockwise direction and remove.
- Remove lid.
- Loosen blade insert clockwise () and remove from the blender jug.
- Clean all parts, see “Cleaning and servicing”.

Universal cutter

Use (depending on model):

- With the blade insert with blender/cutting blade  for cutting and chopping meat, hard cheese, onions, herbs, garlic, fruit, vegetables.
- With the blade insert with grinding blade  for grinding and cutting fairly small quantities of spices (e.g. pepper, cumin, juniper, cinnamon, dried anise, saffron), grain (e.g. wheat, millet, linseeds), coffee and sugar.

Risk of injury from sharp blades / rotating drive!

Do not remove/attach the universal cutter until the drive has stopped.

Do not touch blades of the blade insert with bare hands. Clean them with a brush.





Fig. 14 shows guide values for the maximum quantities and processing times when working with the universal cutter.

Fig. 15

- Put down universal cutter jug with the opening face up.
- Add food, which is to be cut, in the jug.
Note **MAX** mark on the jug!
- Place seal on the blade insert. Ensure that the seal is positioned correctly.

Important information

If the seal is damaged or not correctly positioned, liquid may run out.

- Insert blade insert (/ ) into the universal cutter jug and lock anti-clockwise (.
- Turn universal cutter over (blade insert face down).
- Attach the universal cutter (arrow on jug on dot on the appliance ) and rotate all the way clockwise (.
- Insert the mains plug.
- Set the rotary switch to the desired setting.

Note: The longer the appliance remains switched on, the finer the ingredients are cut. Recommendations on using the accessories can be found in the section “Recipes/Ingredients/Processing”.

After using the appliance

- Set the rotary switch to **0/off**.
- Remove mains plug.
- Rotate universal cutter anti-clockwise and remove.
- Turn universal cutter over (blade insert face up).
- Loosen blade insert clockwise () and remove from the universal cutter jug.
- Empty jug.
- Clean all parts, see “Cleaning and servicing”.

Cleaning and servicing

The appliance requires no maintenance. Thorough cleaning protects the appliance from damage and keeps it functional. An overview of cleaning the individual parts can be found in **Fig. 16**.

⚠ Risk of electric shock

Never immerse the base unit in water or place under running water.

Warning!

Surfaces may be damaged. Do not use abrasive cleaning agents.

Note: If processing e.g. carrots and red cabbage, the plastic parts will become discoloured by a red film which can be removed with a few drops of cooking oil.

Cleaning the base unit

- Remove mains plug.
- Wipe the base unit with a damp cloth. If required, use a little detergent.
- Then dry the base unit.

Cleaning the bowl and accessories

⚠ Risk of injury from sharp blades!

Do not touch blades of the universal blade with bare hands. Clean them with a brush. Do not grip the sharp blades or edges of the cutting discs. Take hold of discs by the edge only!

All parts are dishwasher-proof. Do not wedge plastic parts in the dishwasher as they could warp.

Cleaning the blender / universal cutter

⚠ Risk of injury from sharp blades!

Do not touch blades of the blade insert with bare hands. When not in use, always store the universal blade in the blade guard. Clean them with a brush.

The blender jug (without blade insert), lid and funnel are dishwasher-proof. Do not clean the blade insert in the dishwasher, but under running water (do not soak in water). Remove seal for cleaning.

Troubleshooting

⚠ Risk of injury!

Before rectifying a fault, pull out the mains plug.

Fault:

Appliance does not start or appliance switches off during operation.

Possible cause:

Bowl or lid or the accessory has not been attached correctly or has become detached.

Remedial action:

- Set the rotary switch to **0/off**.
- Correctly attach bowl/lid or accessory and screw on all the way.
- Switch the appliance on again.

Important information

If the fault cannot be eliminated, please contact customer service (see customer service addresses at the end of this booklet).

Storage

Fig. 11

The tools can be stored in the bowl to save space.

Disposal











Dispose of packaging in an environmentally-friendly manner. This appliance is labelled in accordance with European Directive 2012/19/EU concerning used electrical and electronic appliances (waste electrical and electronic equipment – WEEE). The guideline determines the framework for the return and recycling of used appliances as applicable throughout the EU. Please ask your specialist retailer about current disposal facilities.

Guarantee

The guarantee conditions for this appliance are as defined by our representative in the country in which it is sold. Details regarding these conditions can be obtained from the dealer from whom the appliance was purchased. The bill of sale or receipt must be produced when making any claim under the terms of this guarantee.

Changes reserved.

Recipes / Ingredients / Processing

Tool	Speed	Time	Recipes / Ingredients / Processing
 or 	low	approx. 1-2 min	Yeast dough – Max. 500 g flour – 25 g yeast or 1 packet of dried yeast – 220 ml milk (room temperature) – 1 egg – 1 pinch of salt – 80 g sugar – 60 g butter – Grated rind of half a lemon ■ Add all ingredients (except the milk) to the bowl. ■ Set rotary switch to a low speed for 10 seconds. ■ Add milk and stir at low speed for about 1½ minutes. Ingredients should be at the same temperature. When the dough has a smooth appearance, place in a warm location.
	M		Onions, garlic – from 1 onion, quartered, up to 300 g – from 1 clove of garlic up to 300 g ■ Process the onion/garlic until it has been chopped to the required size.
	high		Hard cheese (e.g. parmesan) – 10 g to 200 g ■ Cut the cheese into cubes. ■ Process until it has been chopped to the required size.
	high		Chocolate – 50 g to 200 g ■ Cut or break the chocolate into pieces. ■ Process until it has been chopped to the required size.
	high		Parsley – 10 g to 50 g ■ Process the parsley until it has been chopped to the required size.
	high		Meat, liver (for mince, steak tartare, etc.) – 50 g to 500 g ■ Remove bones, gristle and sinews. Dice the meat. Making sausage meat, stuffing and pâté: ■ Put meat (beef, pork, veal, poultry, or even fish, etc.) together with other ingredients and spices into the bowl and mix into a dough.
	high	approx. 1.5 min – 2 min	Strawberry sorbet – 250 g frozen strawberries – 100 g icing sugar – 180 ml cream ■ Put all ingredients in the bowl. Switch on immediately, otherwise the mixture will go lumpy. Mix until a creamy sorbet forms.







Tool	Speed	Time	Recipes / Ingredients / Processing
	low		Beaten egg white – 2 to 6 egg whites ■ Beat at a low speed.
	high		Whipped cream – 200 g to 400 g ■ Whisk at high speed.
	low/ high		Mayonnaise – 1 egg – 1 tsp. mustard – 150-200 ml oil – 1 tbs. lemon juice or vinegar – 1 pinch of salt – 1 pinch of sugar Ingredients should be at the same temperature. ■ Mix all ingredients (except oil) for several seconds at setting 1. ■ Switch appliance to setting 2, slowly pour oil through the feed tube and mix until the mixture emulsifies. Eat the mayonnaise immediately, do not store.
	high/M		Nuts, almonds – 50 g to 200 g ■ Remove shells completely, otherwise the blender blade will be blunted. ■ Process the onion/garlic until it has been chopped to the required size.
	high/M		Puréeing fruit or vegetables – Apple sauce, spinach, carrot and tomato purée; raw or cooked ■ Put ingredients and spices into the blender and purée.
	high		Chocolate-milk – 80 g–100 g cooled chocolate – approx. 400 ml hot milk ■ Chop up the chocolate in the blender, add the hot milk and mix briefly.
	M		Honey and hazel nut spread – 15 g hazelnuts – 110 g blossom honey (room temperature) ■ Put the nuts in the universal cutter jug and cut with the blender/cutting blade for 20 seconds on setting M. ■ Remove the universal cutter jug, turn it over and take out the blade insert. ■ Add the honey. Close the universal cutter jug again with the blade and put on the base unit. ■ Wait until all the honey has run down over the blade. Then mix everything for 5 seconds on setting M.



Fig. F shows guide values for the maximum quantities and processing times when working with the universal cutter jug and the blade inserts.

Kundendienst – Customer Service

DE Deutschland, Germany

BSH Hausgeräte Service GmbH
Zentralwerkstatt für kleine Hausgeräte
Trautskirchener Strasse 6-8
90431 Nürnberg

Online Auftragsstatus, Filterbeutel-
Konfigurator und viele weitere
Infos unter:
www.bosch-home.com

Reparaturservice, Ersatzteile &
Zubehör, Produkt-Informationen:
Tel.: 0911 70 440 040

<mailto:cp-servicecenter@bshg.com>
Wir sind an 365 Tagen rund um die Uhr
erreichbar.

AE United Arab Emirates, الإمارات العربية المتحدة

BSH Home Appliances FZE
Round About 13,
Plot Nr MO-0532A
Jebel Ali Free Zone – Dubai
Tel.: 04 881 4401
<mailto:service.uae@bshg.com>
www.bosch-home.com/ae

AL Republika e Shqiperise, Albania

ELEKTRO-SERVIS sh.p.k
Rr. Shkelqim Fusha, Selite,
Pallati "Matrix Konstruktion",
Kati 0 dhe +1
1023 Tirane
Tel.: 4 2278 130, -131
Fax: 4 2278 130
<mailto:info@elektro-servis.com>

EXPERT SERVIS
Rruga e Kavajes,
Kulla B Nr 223/1 Kati I
1023 Tirane
Tel.: 4 480 6061
Tel.: 4 227 4941
Fax: 4 227 0448
Cel: +355 069 60 45555
<mailto:info@expert-servis.al>

AT Österreich, Austria

BSH Hausgeräte Gesellschaft mbH
Werkkundendienst für Hausgeräte
Quellenstrasse 2a
1100 Wien

Online Reparaturannahme,
Ersatzteile und Zubehör und viele
weitere Infos unter:
www.bosch-home.at
Reparaturservice, Ersatzteile & Zubehör,
Produktinformationen
Tel.: 0810 550 511
<mailto:vie-stoerungsannahme@bshg.com>
Wir sind an 365 Tagen rund um die Uhr für
Sie erreichbar.

AU Australia

BSH Home Appliances Pty. Ltd.
Gate 1, 1555 Centre Road
Clayton, Victoria 3168
Tel.: 1300 369 744*
Fax: 1300 306 818
<mailto:aftersales.au@bshg.com>
www.bosch-home.com.au
*Mo-Fr: 24 hours

BA Bosna i Hercegovina, Bosnia-Herzegovina

"HIGH" d.o.o.
Gradačacka 29b
71000 Sarajevo
Tel.: 061 10 09 05
Fax: 033 21 35 13
mailto:bosch_siemens_sarajevo@yahoo.com

BE Belgique, België, Belgium

BSH Home Appliances S.A.
Avenue du Laerbeek 74
Laarbeeklaan 74
1090 Bruxelles – Brussel
Tel.: 070 222 141
Fax: 024 757 291
<mailto:bru-repairs@bshg.com>
www.bosch-home.be

BG Bulgaria

BSH Domakinski Uredi Bulgaria EOOD
115K Tsarigradsko Chausse Blvd.
European Trade Center Building, 5th floor
1784 Sofia
Tel.: 0700 208 17
Fax: 02 878 79 72
<mailto:informacia.servis-bg@bshg.com>
www.bosch.home.bg

BH Bahrain, مملكة البحرين

Khalaifat Est.
P.O. Box 5111
Manama
Tel.: 01 7400 553
<mailto:service@khalaifat.com>

BY Belarus, Беларусь

ООО "БСХ Бытовая техника"
ten.: 495 737 2961
<mailto:mok-kdhl@bshg.com>

CH Schweiz, Suisse, Svizzera, Switzerland

BSH Hausgeräte AG
Werkkundendienst für Hausgeräte
Fahrweidstrasse 80
8954 Geroldswil
<mailto:ch-info.hausgeraete@bshg.com>

Service Tel.: 0848 840 040
Service Fax: 0848 840 041
<mailto:ch-reparatur@bshg.com>
Ersatzteile Tel.: 0848 880 080
Ersatzteile Fax: 0848 880 081
<mailto:ch-ersatzteil@bshg.com>
www.bosch-home.com

CY Cyprus, Κύπρος

BSH Ikiakes Syskeves-Service
39, Arh. Makaanriou III Str.
2407 Egomi/Nikosia (Lefkosia)
Tel.: 7777 8007
Fax: 022 658 128
<mailto:bsh.service.cyprus@cytanet.com.cy>

CZ Česká Republika, Czech Republic

BSH domácí spotřebiče s.r.o.
Firemní servis domácích spotřebičů
Pekařská 10b
155 00 Praha 5
Tel.: 0251 095 546
Fax: 0251 095 549
www.bosch-home.com/cz

DK Danmark, Denmark

BSH Hvidevarer A/S
Telegrafvej 4
2750 Ballerup
Tel.: 44 89 89 85
Fax: 44 89 89 86
<mailto:BSH-Service-DK@BSHG.com>
www.bosch-home.dk

EE Eesti, Estonia

SIMSON OÜ
Türi tn.5
11313 Tallinn
Tel.: 0627 8730
Fax: 0627 8733
<mailto:servicenet@servicenet.ee>
www.simson.ee

Renerki Kaubanduse OÜ
Tammisaare tee 134B (Euronicsi kaupluses)
12918 Tallinn
Tel.: 0651 2222
Fax: 0516 7171
<mailto:klienditeenindus@renerk.ee>
www.renerk.ee

Eliser OÜ

Mustamäe tee 24
10621 Tallinn
Tel.: 0665 0090
<mailto:hooldus@eliser.ee>
www.kodumasinat-remont.ee

ES España, Spain

BSH Electrodomésticos España S.A.
Servicio Oficial del Fabricante
Parque Empresarial PLAZA,
C/ Manfredonia, 6
50197 Zaragoza
Tel.: 902 245 255 o 976 305 713
Fax: 976 578 425
<mailto:CAU-Bosch@bshg.com>
www.bosch-home.es

FI Suomi, Finland

BSH Kodinkoneet Oy
Itälahdenkatu 18 A, PL 123
00201 Helsinki
Tel.: 0207 510 700
Fax: 0207 510 780
<mailto:Bosch-Service-FI@bshg.com>
www.bosch-home.fi
Lankapuhelimesta 8,28 snt/puhelu
+ 7 snt/min (alv 24%)
Matkapuhelimesta 8,28 snt/puhelu
+ 17 snt/min (alv 24%)

FR France

BSH Electroménager S.A.S.
50 rue Ardoin – CS 50037
93406 SAINT-OUEN cedex
Service interventions à domicile:
01 40 10 11 00
Service Consommateurs:

0 892 698 010 

<mailto:soa-bosch-conso@bshg.com>
Service Pièces Détachées et
Accessoires:

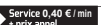
0 892 698 009 

www.bosch-home.fr

GB Great Britain

BSH Home Appliances Ltd.
Grand Union House
Old Wolverton Road
Wolverton
Milton Keynes MK12 5PT
To arrange an engineer visit, to order spare parts and accessories or for product advice please visit www.bosch-home.co.uk or call Tel.: 0344 892 8979*

*Calls are charged at the basic rate, please check with your telephone service provider for exact charges

GR Greece, Ελλάδα

BSH Ikiakes Siskeves A.B.E.
Central Branch Service
17 km E.O. Athinon-Lamias & Potamou 20
14564 Kifisia
Πανελλήνιο τηλέφωνο: 181 82 (Αστική χρέωση)
mailto:nkf-CustomerService@bshg.com
www.bosch-home.gr

HK Hong Kong, 香港

BSH Home Appliances Limited
Unit 1 & 2, 3rd Floor,
North Block, Skyway House,
3 Sham Mong Road
Tai Kok Tsui, Kowloon
Hong Kong
Tel.: 2565 6151
Fax: 2565 6681
mailto:bosch.hk.service@bshg.com
www.bosch-home.cn

HR Hrvatska, Croatia

BSH kućni uređaji d.o.o.
Kneza Branimira 22
10000 Zagreb
Tel.: 01 552 08 88
Fax: 01 640 36 03
mailto:informacije.servis-hr@bshg.com
www.bosch-home.com/hr

HU Magyarország, Hungary

BSH Háztartási Készülék
Kereskedelm Kft.
Árpád fejedelem útja 26-28
1023 Budapest
Call Center: +36 80-200-201
mailto:BSH-szerviz@bshg.com
www.bosch-home.com/hu

IE Republic of Ireland

BSH Home Appliances Ltd.
Unit F4, Ballymount Drive
Ballymount Industrial Estate
Walkinstown
Dublin 12
Service Requests, Spares and Accessories
Tel.: 01450 2655*
Fax: 01450 2520
www.bosch-home.co.uk
*0.03 € per minute at peak.
Off peak 0.0088 € per minute.

IL Israel, ישראל

C/S/B/ Home Appliance Ltd.
1, Hamasger St.
North Industrial Park
Lod, 7129801
Tel.: 08 9777 222
Fax: 08 9777 245
mailto:csb-serv@csb-ltd.co.il
www.bosch-home.co.il

IN India, Bhārat, भारत

BSH Household Appliances
Mfg. Pvt. Ltd. Arena House, Main Bldg,
2nd Floor,
Plot No. 103, Road No. 12,
MIDC, Andheri East
Mumbai 400 093
Toll Free 1800 266 1880*
www.bosch-home.com/in
* Mo-Sa: 8.00am to 8.00pm
(exclude public holidays)

IS Iceland

Smith & Norland hf.
Noatuni 4
105 Reykjavik
Tel.: 0520 3000
Fax: 0520 3011
www.sminor.is

IT Italia, Italy

BSH Elettrodomestici S.p.A.
Via. M. Nizzoli 1
20147 Milano (MI)
Numero verde 800 829 120
mailto:info.it@bosch-home.com
www.bosch-home.com/it

KZ Kazakhstan, Қазақстан

IP Turebekov Yerzhan
Nurmanovich
Jangeldina str. 15
Shimkent 160018
Tel.: 0252 31 00 06
mailto:evrika_kz@mail.ru

LB Lebanon, لبنان

Teheni, Hana & Co.
Boulevard Dora 4043 Beyrouth
P.O. Box 90449
Jdeideh, 1202 2040
Tel.: 01 255 211
mailto:Info@Teheni-Hana.com

LT Lietuva, Lithuania

Senuku prekybos centras UAB
Jonavos g. 62
44192 Kaunas
Tel.: 0372 12146
Fax: 0372 12165
www.senukai.lt
UAB "AG Service"
R. Kalantos g. 32
52494 Kaunas
Tel.: 0700 556 55
Fax: 037 331 363
mailto:servisas@agservice.lt
www.agservice.lt
Baltic Continent Ltd.
Lukšio g. 23
09132 Vilnius
Tel.: 05 274 1788
Fax: 05 274 1722
mailto:info@balticcontinent.lt
www.balticcontinent.lt

LU Luxembourg

BSH électroménagers S.A.
13-15, ZI Breedeweues
1259 Senningerberg
Tel.: 26349 300
Fax: 26349 315
Reparaturen: lux-repair@bshg.com
Ersatzteile: lux-spare@bshg.com
www.bosch-home.com/lu

LV Latvija, Latvia

SIA "General Serviss"
Bulju iela 70c
1067 Rīga
Tel.: 06742 52 32
mailto:info@serviscentrs.lv
www.serviscentrs.lv

Elkor Serviss
Brīvības gatve 201
1039 Rīga
Tel.: 067 070 520; -36
Fax: 067 070 524
mailto:info@elkorserviss.lv
www.elkorserviss.lv

Sia Elektronika-Serviss
Tadaikū iela 4
1004 Rīga
Tel.: 067 717 060
Fax: 067 601 235
mailto:serviss@elektronika.lv
www.elektronika.lv

MD Moldova

S.R.L. "Rialto-Studio"
ул. Цицєва 98
2012 Кишинєв
тел./ факс: 022 23 81 80
mailto:bosch-md@mail.ru

ME Crna Gora, Montenegro

Elektronika komerc
Ul. Slobode 17
84000 Bijelo Polje
Tel./Fax: 050 432 575
Mobil: 069 324 812
mailto:ekobosch.servis@t-com.me

MK Macedonia, Македонија

GORENEC
Jane Sandanoski 69 lok. 3
1000 Skopje
Tel.: 022 454 600
Mobil: 070 697 463
mailto:gorenece@yahoo.com

MT Malta

Oxford House Ltd.
Notabile Road
Mriehel BKR 14
Tel.: 021 442 334
Fax: 021 488 656
www.oxfordhouse.com.mt

MV Raajjeyge Jumhooriyyaa, Maldives

Lintel Investments
Ma. Maadheli, Majeedhee Magu
Malé
Tel.: 0331 0742
mailto:mohamed.zuhuree@
intel.com.mv

NL Nederlande, Netherlands

BSH Huishoudapparaten B.V.
Taurusavenue 36
2132 LS Hoofddorp
Storingsmelding:
Tel.: 088 424 4010
Fax: 088 424 4845
mailto:bosch-contactcenter@
bshg.com

Onderdelenverkoop:
Tel.: 088 424 4010
Fax: 088 424 4801
mailto:bosch-onderdelen@bshg.com
www.bosch-home.nl

NO Norge, Norway

BSH Husholdningsapparater A/S
Grensesvingen 9
0661 Oslo
Tel.: 22 66 06 00
Fax: 22 66 05 50
mailto:Bosch-Service-NO@bshg.com
www.bosch-home.no

NZ New Zealand

BSH Home Appliances Ltd.
Unit F 2, 4 Orbit Drive
Mairangi Bay
Auckland 0632
Tel.: 0800 245 700*
Fax: 0800 256 535
mailto:aftersales.nz@bshg.com
www.bosch-home.co.nz
* Mo-Fr: 8.30am to 4.00pm
(exclude public holidays)

PL Polska, Poland

BSH Sprzęt Gospodarstwa
Domowego sp. z o.o.
Al. Jerozolimskie 183
02-222 Warszawa
Centrala Serwisu
Tel.: 801 191 534
Fax: 022 572 7709
mailto:Serwis.Fabryczny@bshg.com
www.bosch-home.pl

PT Portugal

BSHP Electrodomésticos,
Sociedade Unipessoal, Lda.
Rua Alto do Montijo, nº 15
2790-012 Carnaxide
Tel.: 214 250 730
Fax: 214 250 701
mailto:bosch.electrodomesticos.pt@
bshg.com
www.bosch-home.pt

RO România, Romania

BSH Electrocasnice srl.
Sos. Bucuresti-Ploiesti,
nr. 19-21, sect. 1
13682 Bucuresti
Tel.: 021 203 9748
Fax: 021 203 9733
mailto:service.romania@bshg.com
www.bosch-home.ro

RU Russia, Россия

ООО "БСХ Бытовая техника"
Сервис от производителя
Малая Калужская 19/1
119071 Москва
тел.: 495 737 2961
mailto:mok-kdhl@bshg.com
www.bosch-home.com

SA Kingdom Saudi Arabia,

المملكة العربية السعودية
Abdul Latif Jameel Electronics
and Airconditioning Co. Ltd.
BOSCH Service centre,
Kilo 5 Old Makkah Road
(Next to Toyota), Jamiah Dist.
P.O.Box 7997
Jeddah 21472
Tel.: 800 127 9999
mailto:palakkain@alj.com
www.aljelectronics.com.sa

SE Sverige, Sweden

BSH Home Appliances AB
Landsvägen 32
169 29 Solna
Tel.: 0771 11 22 77 local rate
mailto:Bosch-Service-SE@bshg.com
www.bosch-home.se

SG Singapore, 新加坡

BSH Home Appliances Pte. Ltd.
Block 4012, Ang Mo Kio Avenue 10
#01-01 Techplace 1
Singapore 569628
Tel.: 6751 5000*
Fax: 6751 5005
mailto:bshsgp.service@bshg.com
www.bosch-home.com.sg
* Mo-Fr: 8.30am to 7.00pm, Sa: 8.30am to 5.30pm
(exclude public holidays)

SI Slovenija, Slovenia

BSH Hišni aparati d.o.o.
Litostrojska 48
1000 Ljubljana
Tel.: 01 583 07 00
Fax: 01 583 08 89
mailto:informacije.servis@bshg.com
www.bosch-home.com/si

SK Slovensko, Slovakia

BSH domácí spotřebiče s.r.o.
Organizačná zložka Bratislava
Galvaniho 17/C
821 04 Bratislava
Tel.: 02 44 45 20 41
mailto:opravy@bshg.com
www.bosch-home.com/sk

TR Türkiye, Turkey

BSH Ev Aletleri Sanayi
ve Ticaret A.Ş.
Fatih Sultan Mehmet Mahallesi
Balkan Caddesi No: 51
34771 Ümraniye, İstanbul
Tel.: 0 216 444 6333*
Fax: 0 216 528 9188*
mailto:careline.turkey@bshg.com
www.bosch-home.com/tr
* Çağrı merkezini sabit hatlardan
aramanın bedeli şehir içi ücretlendirmede,
Çep telefonlarından ise kullanılan
tarifeye göre değişiklik göstermektedir

TW Taiwan, 台灣

我們期望您不斷的鼓勵與指導，
任何諮詢或服務需求，
歡迎洽詢客服專線
BSH Home Appliances Private Limited
台北市內湖區洲子街80號11樓
11F., No.80, Zhouzi St., Neihu Dist.
Taipei City 11493
Tel.: 0800 368 888
Fax: 02 2627 9788
mailto:bshstzn-service@bshg.com
www.bosch-home.com.tw

UA Ukraine, Україна

ТОВ "БСХ Побутова Техніка"
тел.: 044 490 2095
mailto:bsh-service.ua@bshg.com
www.bosch-home.com.ua

XK Kosovo

Service-General SH.P.K.
Rruga Mag Prishtine-Ferizaj
70000 Ferizaj
Tel.: 0290 321 434
Tel.: 0290 330 723
mailto:a_service@
gama-electronics.com

XS Srbija, Serbia

BSH Kućni aparati d.o.o.
11070 Novi Beograd
Tel.: 011 353 70 08
Fax: 011 205 23 89
mailto:informacije.servis-sr@
bshg.com
www.bosch-home.rs

ZA South Africa

BSH Home Appliances (Pty) Ltd.
15th Road Randjespark
Private Bag X36, Randjespark
1685 Midrand – Johannesburg
Tel.: 086 002 6724
Fax: 086 617 1780
mailto:applianceserviceza@bshg.com
www.bosch-home.com/za

 Beratung und Reparaturauftrag bei Störungen

DE 0911 70 440 040

AT 0810 550 511

CH 0848 840 040

Die Kontaktdaten aller Länder finden Sie im beiliegenden Kundendienst-Verzeichnis.

Robert Bosch Hausgeräte GmbH

Carl-Wery-Straße 34

81739 München, GERMANY

www.bosch-home.com



8001076888

970614

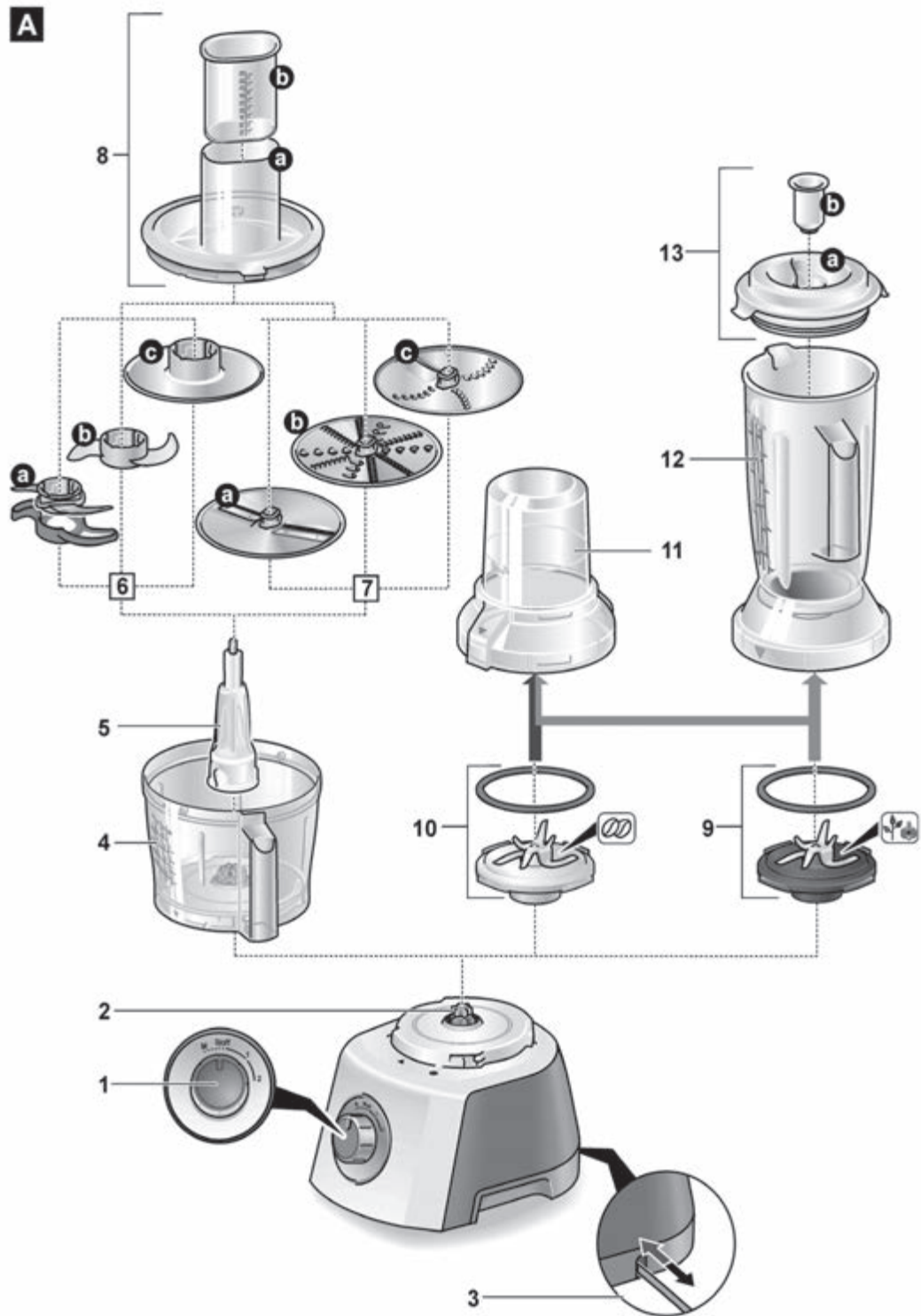
A

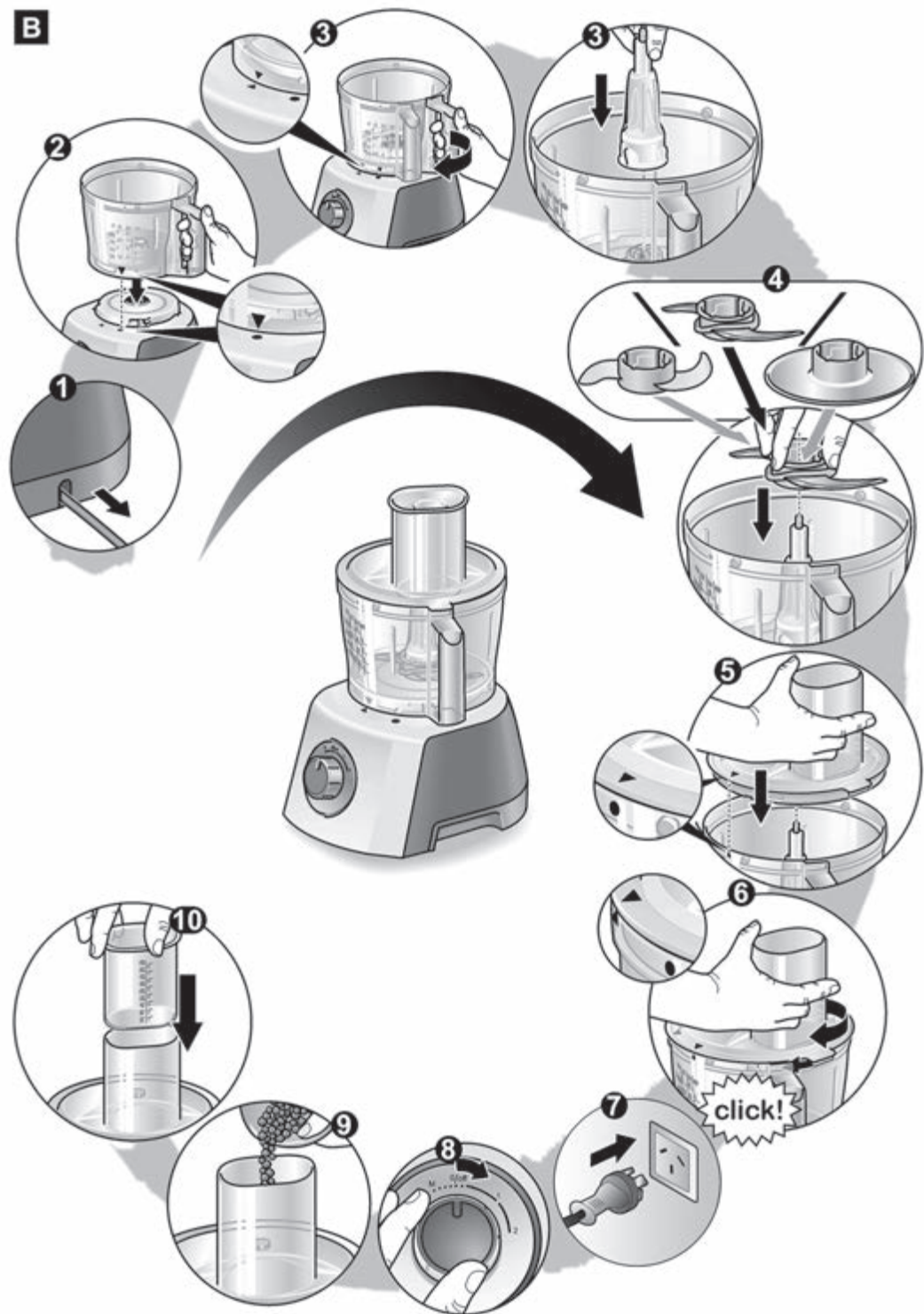

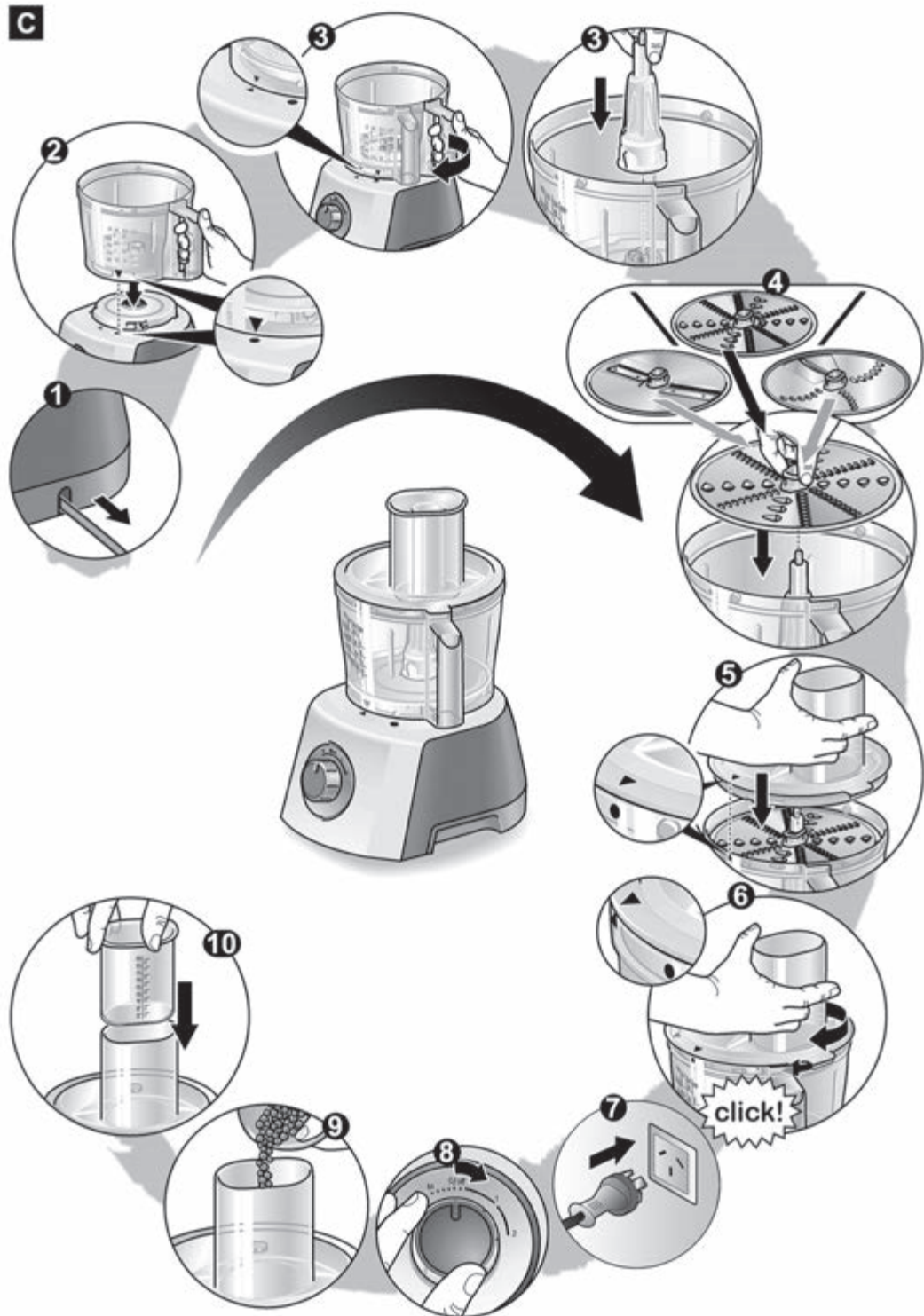

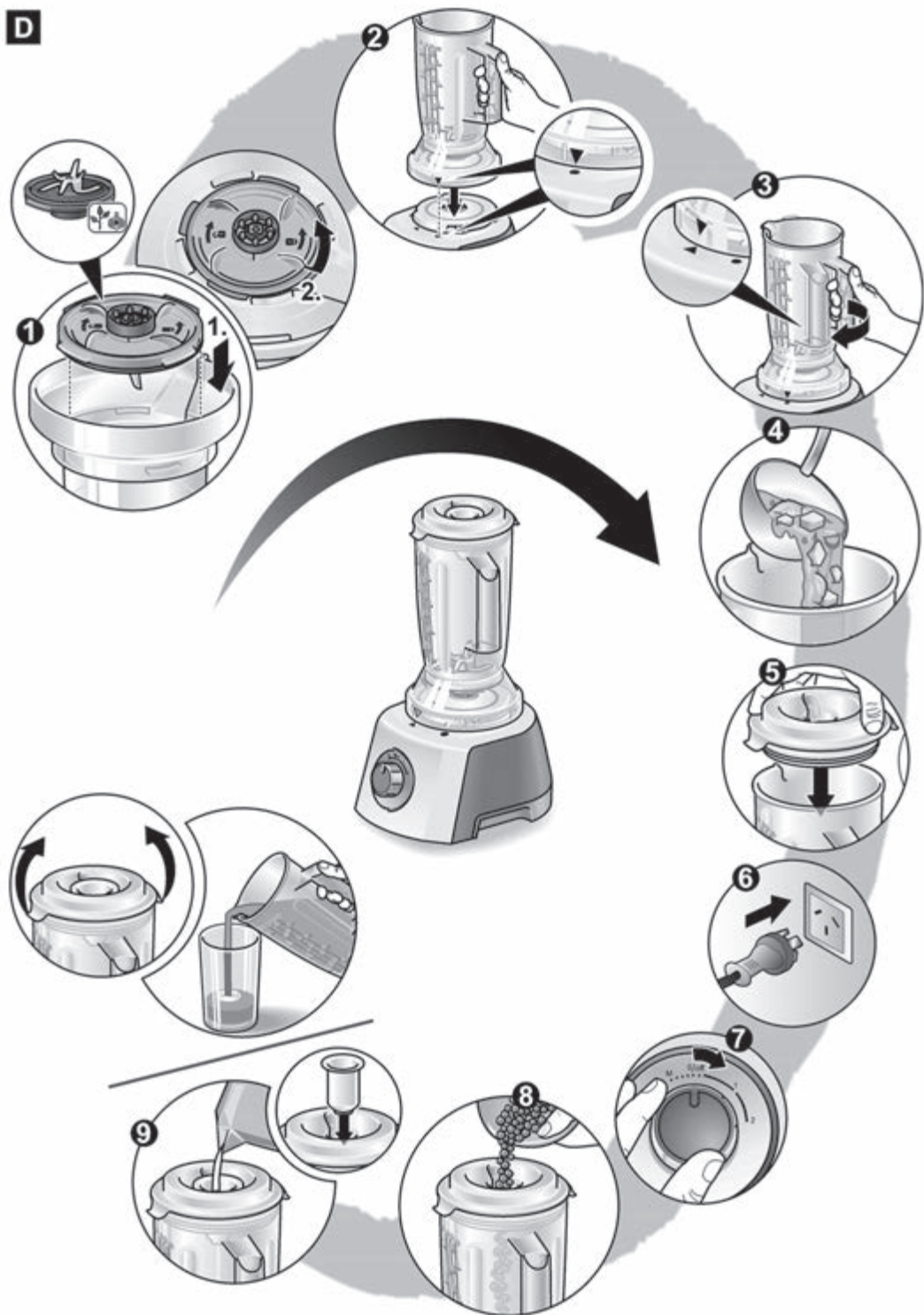

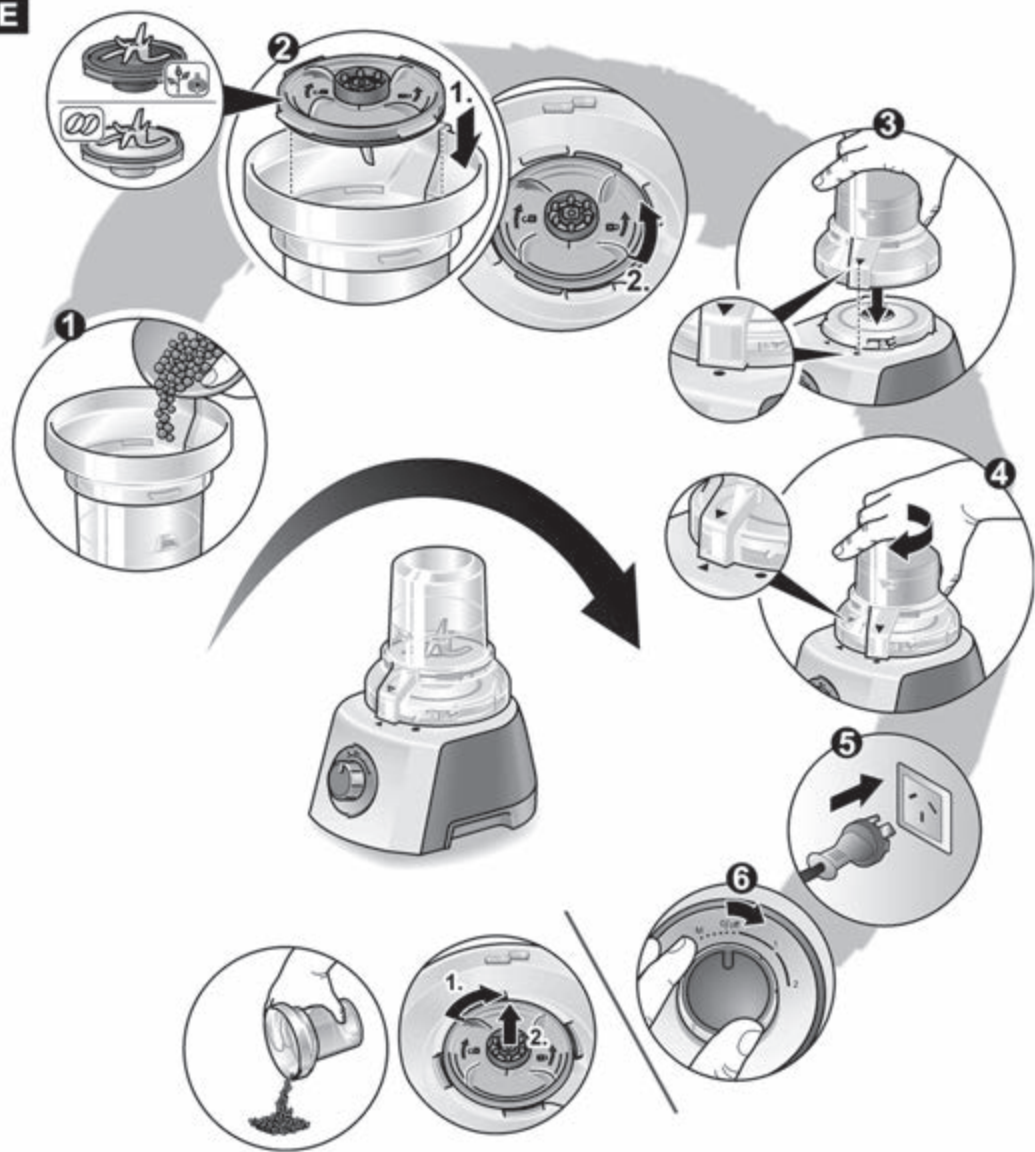







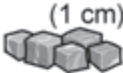
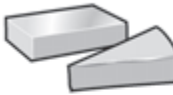
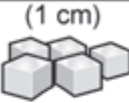

B

C

D







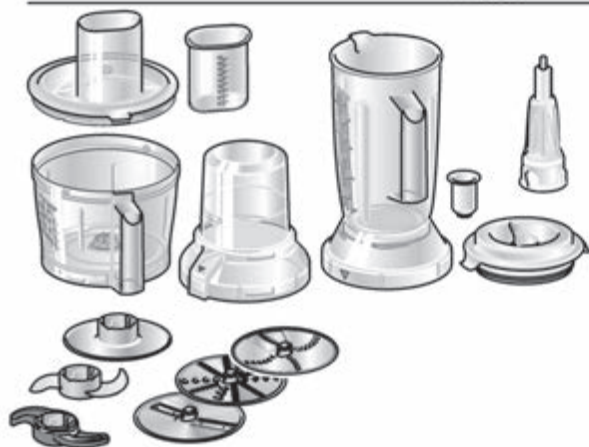
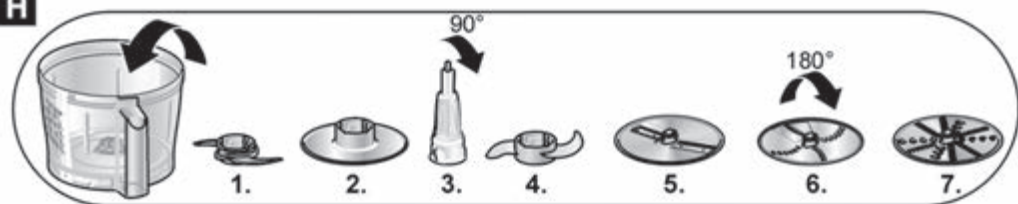

E





F

							 M=1 sec
	 (1 cm)		X	100 g	10–20 s		2
	 (1 cm)		X	100 g	5–15 s		2
			X	50 g			(1–3)xM
			X	15x			(2–5)xM
			X	10 g			(2–5)xM
		X		60 g	40–60 s		2
		X		50 g			(5–10)xM
		X		100 g	40–60 s		2
		X		50 g	40–60 s		2

G**H**

I

								
MCM3501MAU	✓	✓	✓	✓	✓	✓	✓	

					
MCM3501MAU	✓	✓	✓	✓	