



Register your new Bosch now:
www.bosch-home.com/welcome



Built-in oven
HBN559.1Z



BOSCH

[en] Instruction manual

Table of contents

Important safety information	3	Malfunction table.....	13
Causes of damage.....	5	Error messages.....	13
Your new oven	5	Replacing the bulb in the oven ceiling light.....	14
Control panel.....	5	Glass cover.....	14
Function selector.....	6	After-sales service	14
Control buttons and display panel.....	6	E number and FD number.....	14
Temperature selector.....	6	Energy and environment tips	14
Cooking compartment.....	6	Saving energy.....	14
Your accessories	7	Environmentally-friendly disposal.....	14
Inserting the accessories.....	7	Measures to be noted during transport.....	15
Optional accessories.....	7	Tested for you in our cooking studio	15
Before using the oven for the first time	8	Cakes and pastries.....	15
Setting the time.....	8	Baking tips.....	16
Heating up the oven.....	8	Meat, poultry, fish.....	17
Cleaning the accessories.....	8	Tips for roasting and grilling.....	19
Programming the oven	8	Bakes, gratins, toast with toppings.....	19
Types of heating and temperature.....	8	Preprepared products.....	19
Rapid heating.....	8	Special dishes.....	20
Setting the time functions	9	Defrosting.....	20
Timer.....	9	Drying.....	20
Cooking time.....	9	Preserving.....	20
End time.....	10	Acrylamide in foodstuffs	21
Time.....	10	Test dishes	22
Childproof lock	10	Baking.....	22
Changing the basic settings	11	Grilling.....	22
Care and cleaning	11		
Cleaning agents.....	11		
Cleaning the self-cleaning surfaces in the oven.....	12		
Detaching and attaching the oven door.....	12		
Removing and refitting the door panels.....	13		
Troubleshooting	13		

Additional information on products, accessories, replacement parts and services can be found at www.bosch-home.com and in the online shop www.bosch-eshop.com

Important safety information

Read these instructions carefully. Only then will you be able to operate your appliance safely and correctly. Retain the instruction manual and installation instructions for future use or for subsequent owners.

This appliance is only intended to be fully fitted in a kitchen. Observe the special installation instructions.

Check the appliance for damage after unpacking it. Do not connect the appliance if it has been damaged in transport.

Only a licensed professional may connect appliances without plugs. Damage caused by incorrect connection is not covered under warranty.

This appliance is intended for domestic use only. The appliance must only be used for the preparation of food and drink. The

appliance must be supervised during operation. Only use this appliance indoors.

This appliance is intended for use up to a maximum height of 2000 metres above sea level.

This appliance may be used by children over the age of 8 years old and by persons with reduced physical, sensory or mental capabilities or by persons with a lack of experience or knowledge if they are supervised or are instructed by a person responsible for their safety how to use the appliance safely and have understood the associated hazards.

Children must not play with, on, or around the appliance. Children must not clean the appliance or carry out general maintenance unless they are at least 8 years old and are being supervised.

Keep children below the age of 8 years old at a safe distance from the appliance and power cable.

Always slide accessories into the cooking compartment correctly. See "*Description of accessories*" in the instruction manual.

Risk of fire!

- Combustible items stored in the cooking compartment may catch fire. Never store combustible items in the cooking compartment. Never open the appliance door if there is smoke inside. Switch off the appliance and unplug it from the mains or switch off the circuit breaker in the fuse box.
- A draught is created when the appliance door is opened. Greaseproof paper may come into contact with the heating element and catch fire. Do not place greaseproof paper loosely over accessories during preheating. Always weight down the greaseproof paper with a dish or a baking tin. Only cover the surface required with greaseproof paper. Greaseproof paper must not protrude over the accessories.

Risk of burns!

- The appliance becomes very hot. Never touch the interior surfaces of the cooking compartment or the heating elements. Always allow the appliance to cool down. Keep children at a safe distance.
- Accessories and ovenware become very hot. Always use oven gloves to remove accessories or ovenware from the cooking compartment.
- Alcoholic vapours may catch fire in the hot cooking compartment. Never prepare food containing large quantities of drinks with a high alcohol content. Only use small quantities of drinks with a high alcohol content. Open the appliance door with care.

Risk of scalding!

- The accessible parts become hot during operation. Never touch the hot parts. Keep children at a safe distance.
- When you open the appliance door, hot steam may escape. Open the appliance door with care. Keep children at a safe distance.
- Water in a hot cooking compartment may create hot steam. Never pour water into the hot cooking compartment.

Risk of injury!

Scratched glass in the appliance door may develop into a crack. Do not use a glass scraper, sharp or abrasive cleaning aids or detergents.

Risk of electric shock!

- Incorrect repairs are dangerous. Repairs may only be carried out by one of our trained after-sales engineers. If the appliance is faulty, unplug the mains plug or switch off the fuse in the fuse box. Contact the after-sales service.
- The cable insulation on electrical appliances may melt when touching hot parts of the appliance. Never bring electrical appliance cables into contact with hot parts of the appliance.
- Do not use any high-pressure cleaners or steam cleaners, which can result in an electric shock.
- When replacing the cooking compartment bulb, the bulb socket contacts are live. Before replacing the bulb, unplug the appliance from the mains or switch off the circuit breaker in the fuse box.
- A defective appliance may cause electric shock. Never switch on a defective appliance. Unplug the appliance from the mains or switch off the circuit breaker in the fuse box. Contact the after-sales service.

Risk of fire!

- Loose food residues, grease and meat juices may catch fire during the Self-cleaning cycle. Remove coarse dirt from the cooking compartment and from the accessories before every Self-cleaning cycle.
- The appliance will become very hot on the outside during the Self-cleaning cycle. Never hang combustible objects, e.g. tea towels, on the door handle. Do not place anything against the front of the oven. Keep children at a safe distance.

Risk of burns!

- The cooking compartment will become very hot during the Self-cleaning cycle. Never open the appliance door or move the locking latch by hand. Allow the appliance to cool down. Keep children at a safe distance.

-  The appliance will become very hot on the outside during the Self-cleaning cycle. Never touch the appliance door. Allow the appliance to cool down. Keep children at a safe distance.

Causes of damage

Caution!

- Accessories, foil, greaseproof paper or ovenware on the cooking compartment floor: do not place accessories on the cooking compartment floor. Do not cover the cooking compartment floor with any sort of foil or greaseproof paper. Do not place ovenware on the cooking compartment floor if a temperature of over 50 °C has been set. This will cause heat to accumulate. The baking and roasting times will no longer be correct and the enamel will be damaged.
- Water in a hot cooking compartment: do not pour water into the cooking compartment when it is hot. This will cause steam. The temperature change can cause damage to the enamel.
- Moist food: do not store moist food in the cooking compartment when it is closed for prolonged periods This will damage the enamel.
- Fruit juice: when baking particularly juicy fruit pies, do not pack the baking tray too generously. Fruit juice dripping from

the baking tray leaves stains that cannot be removed. If possible, use the deeper universal pan.

- Cooling with the appliance door open: only allow the cooking compartment to cool when it is closed. Even if the appliance door is only open a little, front panels of adjacent units could be damaged over time.
- Very dirty door seal: If the door seal is very dirty, the appliance door will no longer close properly when the appliance is in use. The fronts of adjacent units could be damaged. Always keep the door seal clean.
- Appliance door as a seat, shelf or worktop: Do not sit on the appliance door, or place or hang anything on it. Do not place any cookware or accessories on the appliance door.
- Inserting accessories: depending on the appliance model, accessories can scratch the door panel when closing the appliance door. Always insert the accessories into the cooking compartment as far as they will go.
- Carrying the appliance: do not carry or hold the appliance by the door handle. The door handle cannot support the weight of the appliance and could break.

Your new oven

Here you will learn about your new oven. The control panel and the individual operating controls are explained. You will find information on the cooking compartment and the accessories.

Control panel

Here you can see an overview of the control panel. The design depends on the respective appliance model.

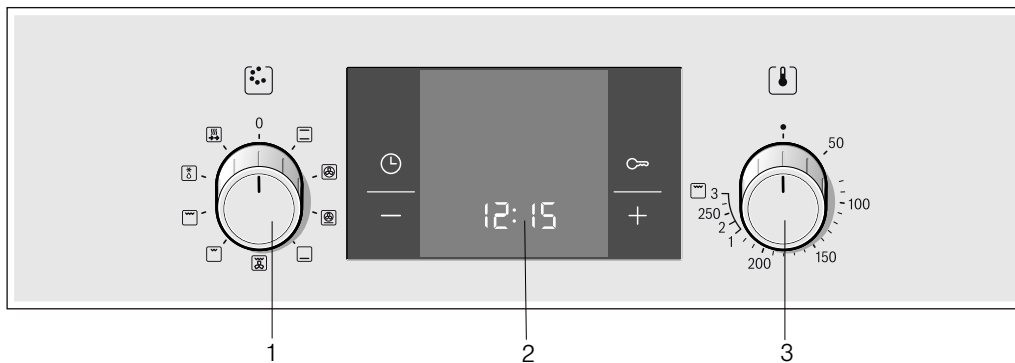

Explanations

1	Function selector
2	Operating switches and display panel
3	Temperature selector

Control knobs

The control knobs can be pushed in and remain pressed down when they are in the "out" position. Press down on the control knob again to release it back up.

Function selector

With the function selector knob you can set the heating mode for the oven. The function selector knob can be rotated to the right or to the left.

When the required type of heating is set, the oven light lights up.

Settings	Function
0 Off	The oven is switched off.
Top/bottom heating	Baking, roasting or grilling is possible on a single level only. This setting is well-suited for cakes and pizza in tins or on the baking tray, and for lean joints of beef, veal and game. Heat is emitted evenly from the top and bottom.
3D hot air*	You can bake cakes, pizza, biscuits, muffins and puff pastry on two levels at the same time. A fan with a ring heating element on the back panel of the oven ensures that the heated air is distributed evenly.
Pizza setting	For the quick preparation of frozen meals without preheating, e.g. pizza, chips or strudel. The lower heating elements and the round heating elements in the back wall must heat up.
Bottom heating	You can use Bottom heating for the final baking stage and for browning meals from the bottom. The heat is emitted from below.
Hot air grilling	Hot air grilling is particularly suitable for grilling fish, poultry and larger pieces of meat. The grill element and fan switch on and off alternately. The fan distributes the heated air around the food.
Radiant grill, small area	This type of heating is suitable for grilling small quantities of steak, sausages, fish, and toast. The centre part of the grill element is heated.
Radiant grilling, large area	Can be used to grill a large number of beef steaks, sausages and fish, or to toast bread. The whole area below the grill heating element becomes hot.
Defrosting	Example: meat, poultry, bread and tarts. The fan distributes the heated air around the food.
Rapid heating	For rapidly heating dishes.

* Type of heating in accordance with energy efficiency class EN50304.

Control buttons and display panel

The buttons are used to set different additional functions. The set values are shown on the display panel.

Button	Use
Time functions	Select the timer , the cooking time , the end time and the time .
Childproof lock	Blocks and unblocks the control panel.
Minus	Reduces programmed values.
Plus	Increases programmed values.

On the display panel, the brackets [] indicate the symbol for the time function selected.

Buttons

The sensors are located under the individual buttons. They must not be pressed too firmly. Only touch the corresponding symbol.

Temperature selector

Use the temperature selector to set the temperature and the grill setting.

Positions	Function
Zero position	Oven not hot.
50-270 Temperature range	Temperature in °C.
1, 2, 3 Grill settings	Grill settings for the Grill, small area and Grill, large area. Setting 1 = low Setting 2 = medium Setting 3 = high

While the oven is heating up, the temperature symbol lights up in the display. If heating is interrupted, the symbol goes out. For some settings, it does not light up.

Grill settings

With Radiant grilling, use the temperature selector to set a grill setting.

Cooking compartment

The oven light is located in the cooking compartment. A cooling fan protects the oven from overheating.

Oven light

During oven operation, the oven light is on. By turning the function selector to any position, the oven light can also be switched on without the oven heating up.

Cooling fan

The cooling fan switches on and off as required. The hot air escapes above the door.

So that the cooking compartment cools down more quickly after operation, the cooling fan continues to run for a certain period afterwards.

Caution!

do not cover the ventilation slots. Otherwise the oven will overheat.

Your accessories

The accessories supplied with your appliance are suitable for making many meals. Ensure that you always insert the accessories into the cooking compartment the right way round.

There is also a selection of optional accessories, with which you can improve on some of your favourite dishes, or simply to make working with your oven more convenient.

Inserting the accessories

The accessories can be inserted in the oven at 4 different levels. Always insert the accessories as far as they can go to ensure that they do not touch the door glass.

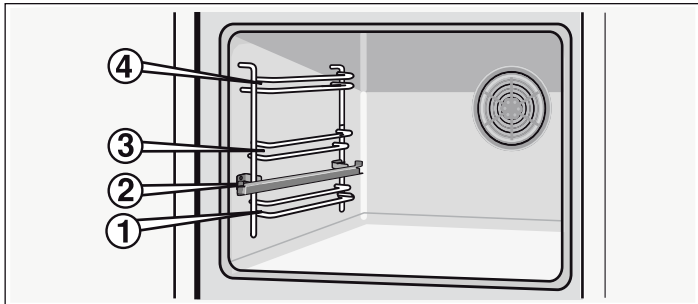

When the accessories are pulled approximately halfway out, they lock into position. This allows meals to be taken out easily.

When placing the accessories in the oven, check that the indentation is at the back. They can only lock correctly in place in this position.

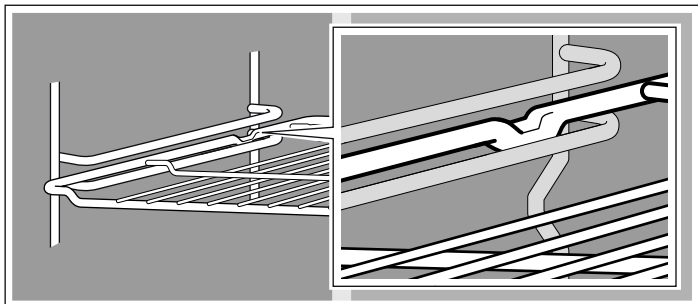

With the pull-out rails on level 2, you can pull the accessories out.

Depending on the appliance version, if the rails are completely pulled out, they must be pushed back in again. This makes it

easier for you to insert the accessories. To open the locking device, press lightly on the rails and move them into the oven.

Note: Heat may cause the accessories to deform. As soon as the accessories cool down, they regain their original shape. Their function is not impaired.

Hold the baking tray securely on the sides with both hands and push it parallel into the frame. Avoid movements to the right or left when pushing the baking tray in. Otherwise, it will be difficult to push the tray in and the enamelled surfaces could be damaged.

You can buy accessories from the after-sales service, from specialist retailers or online. Please specify the HEZ number.



Wire rack

For ovenware, cake tins, joints, grilled items and frozen meals.

Insert the wire rack with the open side facing the oven door and the curvature pointing downwards.



Enamel baking tray

For cakes and biscuits.

Slide in the baking tray with the sloping edge facing the oven door.



Universal pan

For moist cakes, pastries, frozen meals and large roasts. It can also be used to catch dripping fat when you are grilling directly on the wire rack.

Slide in the universal pan with the sloping edge facing the oven door.

Optional accessories

You can buy optional accessories from your after-sales service or from specialist retailers. You will find a variety of suitable products for your oven in our brochures and on the Internet. The availability of optional accessories and the options for ordering them on the internet vary depending on the country. Information regarding this can be found in the sales documents.

Not every optional accessory is suitable for every appliance. When purchasing, always quote the complete identification number (E no.) of your appliance.

Optional accessories	HEZ number	Function
Wire rack	HEZ 434000	For ovenware, cake tins, roasts, grilling and frozen meals.
Aluminium baking tray	HEZ 430001	For cakes and biscuits. Place the baking tray in the oven with the sloping edge towards the oven door.
Enamel baking tray	HEZ 431001	For cakes and biscuits. Place the baking tray in the oven with the sloping edge towards the oven door.
Universal pan	HEZ 432001	For moist cakes, pastries, frozen meals and large roasts. Can also be used under the wire rack to catch fat or meat juices. Place the universal pan in the oven with the sloping edge towards the oven door.

Oven door - Additional safety precautions

During long cooking times, the oven door may become very hot.

If you have small children, extra supervision is required during oven operation.

In addition, there is a safety device which prevents direct contact with the oven door. This optional accessory (440651) is available from the after-sales service.

Before using the oven for the first time

In this section, you can find out what you must do before using your oven to prepare food for the first time. First read the section on *Safety information*.

Setting the time

Once the oven has been connected, the \odot symbol and four zeros are shown flashing on the display panel. Set the time.

1. Press the \odot button.

The display shows the time **12:00**.

2. Set the time with the buttons **+** or **-**.

The programmed time is displayed after a few seconds.

Heating up the oven

To remove the new cooker smell, heat up the oven when it is empty and closed. An hour of Top/bottom heating \square at 240 °C is ideal for this purpose. Ensure that no packaging remnants have been left in the cooking compartment.

Keep the kitchen ventilated the whole time the oven is on.

1. Use the function selector to set Top/bottom heating \square .
2. Set the temperature selector to 240 °C.

After an hour, switch off the oven. To do so, turn the function selector to the off position.

Cleaning the accessories

Before you use the accessories for the first time, clean them thoroughly with hot soapy water and a soft dish cloth.

Programming the oven

There are different ways to programme the oven. Programming the type of heating, temperature or grill power. The oven can be programmed with the cooking time (duration) and the end time for each dish. For more information, see the chapter *Setting the time functions*.

Types of heating and temperature

Example in the picture: Top/bottom heating, 190 °C.

1. Use the function selector to select the required type of heating.

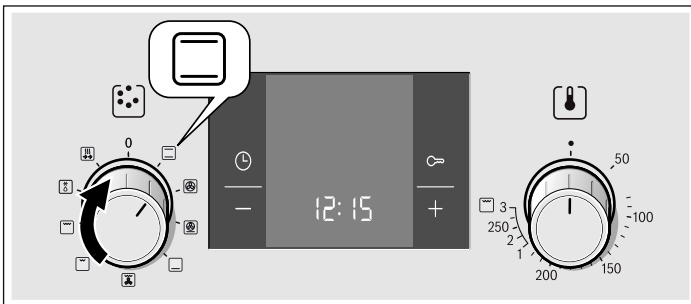

2. Use the temperature selector to set the temperature or the grill setting.

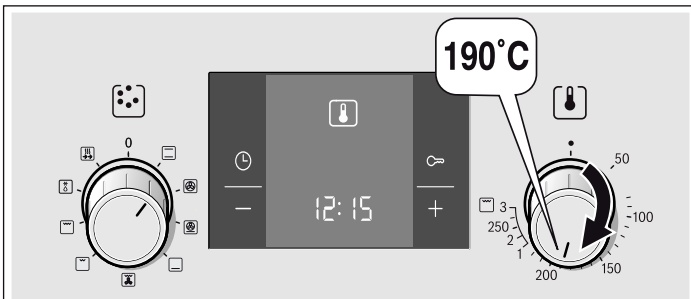

The oven heats up.

Switch off the oven

Turn the function selector to the off position.

Changing the settings

You can change the type of heating, temperature and grill setting as required.

Rapid heating

With rapid heating, the oven reaches the temperature selected more quickly.

Only use rapid heating when temperatures above 100 °C are selected.

Only place the food in the oven after rapid heating has finished, so as to ensure even cooking.

1. Move the function selector to the \square position.
2. Use the temperature selector to set the temperature.

The oven starts after a few seconds. The indicator lamp above the temperature selector lights up.

The rapid heating process is complete

The indicator light above the temperature selector goes out. Place your dish in the oven and select the desired type of heating.

Cancelling rapid heating

Turn the function selector to the off position. The oven switches off.

Setting the time functions

This oven has various time functions. The  sensor activates the menu and moves through the different functions. The time symbols remain lit up while settings are programmed. The square brackets [] indicate the time function selected. You can modify an already programmed time function directly with the sensors **+** or **-**, provided the time symbol is situated between square brackets [].

Timer

The timer works independently of the oven. The timer has its own beep. This can be used to distinguish whether the time set for the timer or the automatic oven shut-off have finished (cooking time).

1. Press the button once .

The time symbols light up on the display panel, the square brackets are next to .

2. Set the timer using the **+** or **-** buttons.

Value suggested for the **+** button = 10 minutes.

Value suggested for the **-** button = 5 minutes.

The programmed time is shown after a few seconds. The time set for the timer starts to count down. The symbol  lights up on the display panel and the timer's progress is shown. The other time symbols switch off.

The time set for the timer has elapsed

A beep will sound. The display panel will show **00:00**. Switch off the timer using the  button.

Changing the time on the timer.





Change the time set for the timer using the **+** or **-** buttons. The new time is shown after a few seconds.

Cancelling the timer

Resetting the timer to **00:00** with the button **-**. The new time is shown after a few seconds. The timer switches off.

Viewing the time settings

If several time functions are programmed, the corresponding symbols light up on the display panel. The symbol for the time function in the foreground is in brackets.

To view the timer , the cooking time , the end time  or the actual time , press the  sensor repeatedly until the brackets are around the required symbol. The corresponding value will be shown for a few seconds on the display panel.

Cooking time

The oven allows you to set the cooking time for each type of food. The oven switches off automatically when the cooking time has finished. This avoids interrupting other tasks to switch the oven off or exceeding the cooking time by mistake.

Example in the picture: cooking time: 45 minutes.

1. Select the type of heating using the function control knob.
2. Select the temperature or grill power level with the temperature control knob.

3. Press the  button twice.

The display panel will show **00:00**. The time symbols light up, the square brackets are next to .

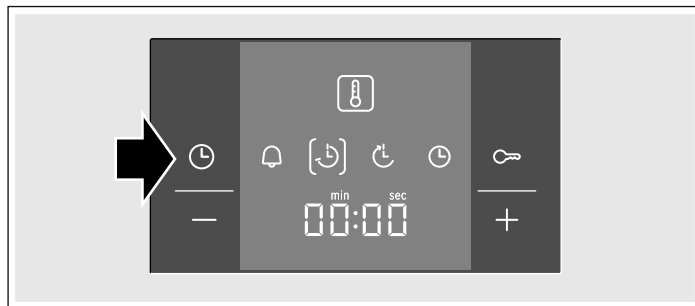

4. Set the cooking time with the **+** or **-** buttons.



Value suggested for the **+** button = 30 minutes

Value suggested for the **-** button = 10 minutes



The oven will switch on after a few seconds. The display panel shows the cooking time elapsed and the  symbol comes on. The other time symbols switch off.

The cooking time has finished

A beep will sound. The oven will stop heating. The display panel will show **00:00**. Press the  button. Programme a new cooking time with the **+** or **-** buttons. Or press the  button twice and turn the function control knob to the zero setting. The oven is off.

Changing the cooking time





Change the cooking time with the **+** or **-** buttons. The new time is shown after a few seconds. If the timer has been programmed, first press the  button.

Cancelling the cooking time

Reset the cooking time to **00:00** with the button **-**. The new time is shown after a few seconds. The time has been cancelled. If the timer has been programmed, first press the  button.

Viewing the time settings

If several time functions are programmed, the corresponding symbols light up on the display panel. The symbol for the time function in the foreground is in brackets.



To view the timer , the cooking time , the end time  or the actual time , press the  sensor repeatedly until the brackets are around the required symbol. The corresponding value will be shown for a few seconds on the display panel.

End time

The oven allows you to set the time when you want the food ready. The oven switches on automatically and switches off at the set time. For example, the food may be placed in the oven in the morning and the oven set so that it is ready at midday.

Ensure that the food will not go off if it is in the oven for too long.

Example in the picture: It is now 10:30 am, the cooking time is 45 minutes and the oven should switch off at 12:30 pm.



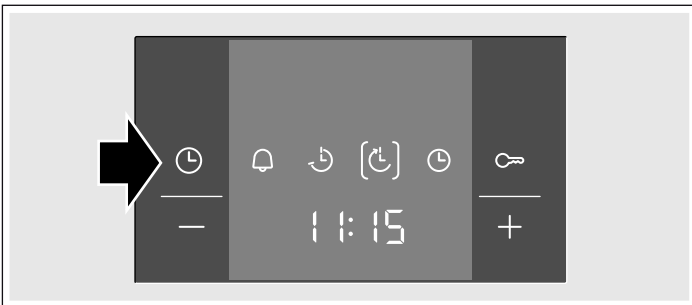

1. Set the function control knob.
2. Set the temperature control knob.
3. Press the  button twice.
4. Set the cooking time with the **+** or **-** buttons.
5. Press the  button.

The square brackets are shown next to . The time the dish will be ready is displayed.





6. Delay the end time using the **+** or **-** buttons.



The oven displays the programmed time after a few seconds and is set to standby. The time when the dish will be ready is displayed and the end time  symbol will be shown in square brackets. The symbols  and  turn off. When the oven is turned on, cooking time progress is shown and the symbol  appears in square brackets. The symbol  is turned off.

The cooking time has finished

A beep will sound. The oven will stop heating. The display panel will show **00:00**. Press the  button. Programme a new cooking time with the **+** or **-** buttons. Or press the  button twice and turn the function control knob to the zero setting. The oven is off.

Changing the end time





Change the end time using the buttons **+** or **-**. The new time is shown after a few seconds. If the timer has been programmed, first press the  button twice. Do not change the end time if the cooking time has already started to count down. The final result may not be the same.

Cancelling the end time

Reset the end time to the current time by pressing **-**. The new time is shown after a few seconds. The oven switches on. If the timer has been programmed, first press the  button twice.

Viewing the time settings

If several time functions are programmed, the corresponding symbols light up on the display panel. The symbol for the time function in the foreground is in brackets.

To view the timer , the cooking time , the end time  or the actual time , press the  sensor repeatedly until the brackets are around the required symbol. The corresponding value will be shown for a few seconds on the display panel.

Time

Once the oven has been connected or after a power cut, a flashing  symbol and four zeros are shown on the display panel. Set the time.

1. Press the  button.

The display panel displays the time **12:00**.

2. Set the time with the buttons **+** or **-**.

The programmed time is displayed after a few seconds.

Changing the time

No other time function can be programmed.

1. Press the  button four times.

The time symbols light up on the display panel, the brackets are located next to .

2. Adjust the time with the buttons **+** or **-**.

The programmed time is displayed after a few seconds.

Hiding the clock

You can hide the clock. For more information, please refer to the section *Changing the basic settings*.

Childproof lock

The oven includes a childproof lock to prevent it being turned on accidentally.

The oven does not react to any setting. The timer and time can be programmed when the childproof lock is on.

When the heating type and temperature or grill level are programmed, the childproof lock turns off the heating.

Activating the childproof lock

No cooking time or end time should already be set.

Press the  button for approximately four seconds.

The display panel shows the symbol . The childproof lock is now activated.

Turning off the childproof lock

Press the  button for approximately four seconds.

The  symbol in the display panel goes off. The childproof lock is now deactivated.

Changing the basic settings

This oven has different basic settings. The settings can be adapted to the user's own needs.

Basic settings	Selection 1	Selection 2	Selection 3
☰ / Time indicator	always*	only with the button ⊖	-
☰ 2 Duration of signal after the cooking time or the time set on the timer has elapsed	approx. 10 sec	approx. 2 min.*	approx. 5 min
☰ 3 Time until a setting is applied	approx. 2 sec	approx. 5 sec.*	approx. 10 sec.

* Default setting

No other time function can be programmed.

1. Press the ⊖ button for approximately 4 seconds.

The display panel will show the current basic setting for the time, e.g. ☰ / for the Selection 1.

2. Set the basic setting using the buttons + or -.

3. Confirm with the ⊖ button.

The display panel shows the following basic setting. Using the button ⊖ select the levels and using the buttons + or - make the setting.

4. Press the ⊖ button for approximately 4 seconds.

All basic settings have been applied.

The basic settings can be changed again at any time.

Care and cleaning

With good care and cleaning, your oven will remain clean and fully-functioning for a long time to come. Here we will explain how to maintain and clean your oven correctly.

Notes

- Slight differences in the colours on the front of the oven are caused by the use of different materials, such as glass, plastic and metal.
- Shadows on the door panel which look like streaks, are caused by reflections made by the oven light.
- Enamel is baked on at very high temperatures. This can cause some slight colour variations. This is normal and does not affect their function. The edges of thin trays cannot be completely enamelled. As a result, these edges can be rough. This will not impair the anti-corrosion protection.

Cleaning agents

Damage to the various different surfaces caused by using the wrong cleaning agent can be avoided by observing the following instructions.

When cleaning the oven do not use

- sharp or abrasive cleaning agents,
- cleaning agent with a high alcohol content,
- scouring pads,
- high-pressure cleaners or steam jets.
- Do not clean individual parts in the dishwasher.

Wash new sponges thoroughly before first use.

Control panel Hot soapy water: Clean with a dish cloth and dry with a soft cloth. Do not use glass cleaner or glass scrapers for cleaning.

Stainless-steel surfaces Clean with warm soapy water and a soft cloth. On stainless-steel surfaces, always wipe parallel to the natural grain. Otherwise, you may scratch the surface. Dry with a soft cloth. Remove flecks of limescale, grease, starch and albumin (e.g. egg white) immediately. Do not use any abrasive materials, scouring sponges or rough cleaning cloths. Polish the stainless steel fronts using special care products. Observe the manufacturer's instructions. Special stainless-steel cleaning agents are available from the after-sales service or from specialist retailers.

Enamel surfaces and lacquered surfaces Wipe with warm soapy water and a cloth. Dry with a soft cloth.

Rotary knobs Wipe with warm soapy water and a cloth. Dry with a soft cloth.

Glass panel Clean using glass cleaner. Do not use any abrasive cleaning agents or sharp metal objects. These may scratch and damage the surface of the glass panel.

Seal Wipe with a warm, damp cloth. Dry with a soft cloth.

Oven floor, ceiling and side panels Warm soapy water or a vinegar solution. If there are heavy deposits of dirt, only use oven cleaner on cooled surfaces. Never apply to the back panel.

Glass cover for the oven light Wipe with warm soapy water and a cloth. Dry with a soft cloth.

Equipment Soak in warm soapy water. Clean with a brush or sponge.

Aluminium baking tray (optional) Do not clean in the dishwasher. Never use oven cleaner. To prevent scratches, never touch the metal surfaces with a knife or a similar sharp object. Clean horizontally with some washing-up liquid and a damp glass cleaning cloth or a microfibre cloth – do not press too hard. Dry with a soft cloth. Do not use any abrasive materials, scouring sponges or rough cleaning cloths. Dry with a soft cloth. Do not use any abrasive materials, scouring sponges or rough cleaning cloths. Otherwise, you may scratch the surface



Childproof lock (optional) If a childproof lock has been fitted on the oven door, it must be removed before cleaning. Soak all plastic parts in warm soapy water and clean with a sponge. Dry with a soft cloth. If it is very dirty, the childproof lock will not work properly.

Hob Refer to the hob instruction manual for information about care and cleaning.

Cleaning the self-cleaning surfaces in the oven

The rear panel is coated with a self-cleaning ceramic layer. This coating absorbs and dispels splashes from baking and roasting while the oven is in operation. You will obtain a better result, the higher the temperature and the longer the oven is in operation.

If soiling is still visible after several uses, proceed as follows:

1. First, clean the enamel surfaces in the oven.
2. Then set  3D hot air or  top and bottom heating.
3. Heat the empty oven for approx. 2 hours at maximum temperature.

The ceramic coating is regenerated. Brownish and black residues can then be removed with water and a soft sponge.

Slight colour variations of the coating have no effect on the self-cleaning function.

Caution!

- Never use abrasive cleaners. This could scratch or damage the highly porous surface coating.
- Do not use oven cleaner on self-cleaning surfaces. If oven cleaner is accidentally applied to these surfaces, wipe it away immediately with a sponge and plenty of water.

Detaching and attaching the oven door

For cleaning purposes and to remove the door panels, you can detach the oven door.

The oven door hinges each have a locking lever. When the locking levers are closed (figure A), the oven door is secured in place. It cannot be detached. When the locking levers are open in order to detach the oven door (Fig. B), the hinges are locked. They cannot snap shut.

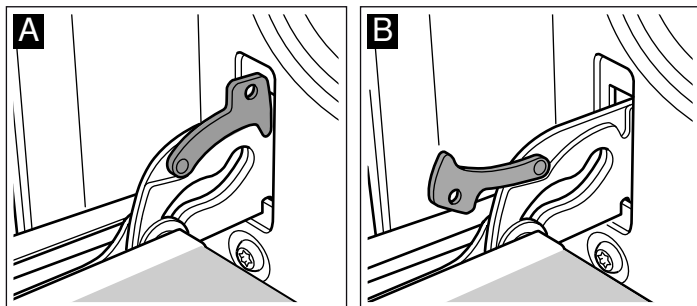

⚠ Risk of injury!

Whenever the hinges are not locked, they snap shut with great force. Ensure that the locking levers are always fully closed or, when detaching the oven door, fully open.

Detaching the door

1. Open the oven door fully.
2. Fold up the two locking levers on the left and right (figure A).
3. Close the oven door as far as the limit stop. With both hands, grip the door on the left and right-hand sides. Close the door a little further and pull it out (figure B).

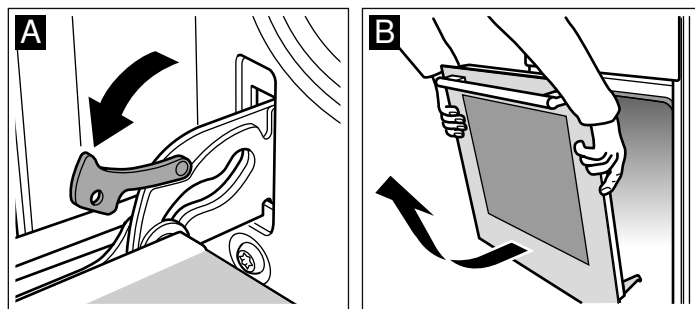

Attaching the door

Reattach the oven door in the reverse sequence to removal.

1. When attaching the oven door, ensure that both hinges are inserted straight into the opening (figure A).
2. The notch on the hinge must engage on both sides (figure B).

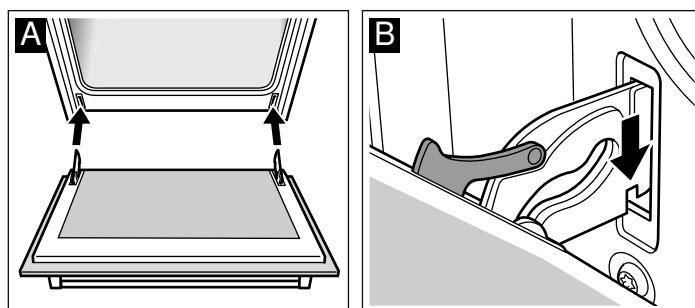

3. Fold back both locking levers (figure C). Close the oven door.

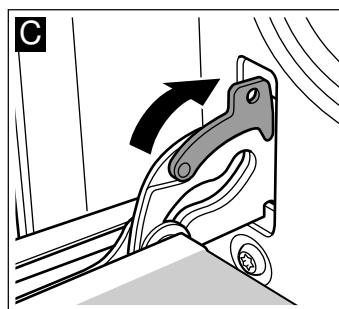

⚠ Risk of injury!

If the oven door falls out accidentally or a hinge snaps shut, do not reach into the hinge. Call the after-sales service.

Removing and refitting the door panels

The glass panels can be removed from the oven door to allow more thorough cleaning.

Removal

1. Removing the oven door See the section *Removing the oven door*. Lay the oven door on a cloth with the handle facing downwards.
2. Remove the cover from the top of the oven door. To do this, press with your fingers on the left and right-hand side. Pull out the cover (Fig. A).
3. Raise the top panel and pull it out (Fig. B).

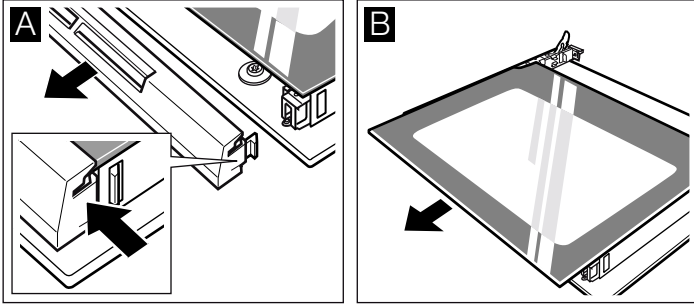

Clean the panels with glass cleaner and a soft cloth.

⚠ Risk of injury!

Scratched glass in the appliance door may develop into a crack. Do not use a glass scraper, sharp or abrasive cleaning aids or detergents.

Fitting

1. Hold the top glass panel firmly by the sides and slide it in towards the back at an angle. The panel must be inserted into the openings on the lower side. The smooth surface must face outwards, while the roughened side must be on the inside. (Fig. A).

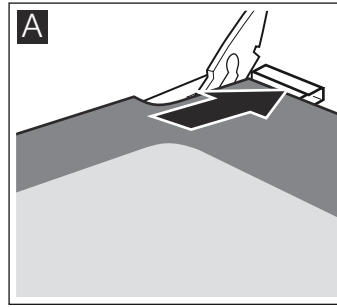

2. Place the cover on the top of the oven door and press in place. Make sure that the grooves along the sides lock into position.
3. Refitting the oven door See the section *Refitting the oven door*.

Do not use the oven again until the panels have been correctly fitted.

Troubleshooting

Malfunctions often have simple explanations. Refer to the table before calling the after-sales service as you may be able to remedy the fault yourself.

Malfunction table

If a dish doesn't turn out as well as you had hoped, refer to the section *Tested for you in our cooking studio*, where you will find plenty of cooking tips and tricks.

⚠ Risk of electric shock!

Incorrect repairs are dangerous. Repairs may only be carried out by one of our trained after-sales engineers.

Problem	Possible cause	Remedy/information
The oven does not work.	The circuit breaker is defective.	Look in the fuse box and check that the circuit breaker is in working order.
	Power cut	Check whether the kitchen light or other kitchen appliances are working.
The clock display flashes.	Power cut	Reset the clock.
The oven does not heat up.	There is dust on the contacts.	Turn the control knobs back and forth several times.

Caution!

If the supply cord is damaged, it must be replaced by the manufacturer, its service agent or similarly qualified persons in order to avoid a hazard.

Error messages

When the display panel shows an error message with **E**, press the **⊖** button. The message will disappear. The set time function will be deleted. If the error message does not disappear, call the Technical Assistance Service.

The following error messages can be solved by the user.

Error message	Possible cause	Solution/advice
E011	A button has been pressed for too long or has got stuck.	Press all of the buttons one by one. Check if any button is stuck, covered or dirty.

⚠ Risk of electric shock.!

Incorrect repairs can be dangerous. Repairs may only be carried out by qualified personnel from the Technical Assistance Service.

Replacing the bulb in the oven ceiling light

If the bulb in the oven light fails, it must be replaced. Heat-resistant, 40 watt spare bulbs can be obtained from our after-sales service or a specialist retailer. Only use these bulbs.

Risk of electric shock!

Switch off the circuit breaker in the fuse box.

1. Place a tea towel in the oven when it is cold to prevent damage.
2. Unscrew the glass cover by turning it anti-clockwise.

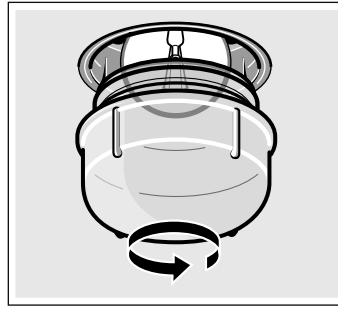

3. Replace the bulb with one of the same type.
4. Screw the glass cover back in.
5. Remove the tea towel and switch on the circuit breaker.

Glass cover

You must replace a damaged glass cover. Suitable glass covers may be obtained from the after-sales service. Please specify the E number and FD number of your appliance.

After-sales service

Our after-sales service is there for you if your appliance needs to be repaired. We will always find the right solution in order to avoid unnecessary visits from a service technician.

E number and FD number

When calling us, please give the product number (E no.) and the production number (FD no.) so that we can provide you with the correct advice. The rating plate containing these numbers is found on the side of the oven door. To save time, you can make a note of the number of your appliance and the telephone number of the after-sales service in the space below, should it be required.

E no.	FD no.

After-sales service

Please note that there will be a fee for a visit by a service technician in the event of a malfunction, even during the warranty period.

Please find the contact data of all countries in the enclosed customer service list.

To book an engineer visit and product advice

GB 0344 892 8979

Calls charged at local or mobile rate.

IE 01450 2655

0.03 € per minute at peak. Off peak 0.0088 € per minute.

Rely on the professionalism of the manufacturer. You can therefore be sure that the repair is carried out by trained service technicians who carry original spare parts for your appliances.

Energy and environment tips

Here you can find tips on how to save energy when baking and roasting and how to dispose of your appliance properly.

Saving energy

- Only preheat the oven if this is specified in the recipe or in the operating instruction tables.
- Use dark, black lacquered or enamelled baking tins. They absorb the heat particularly well.
- Open the oven door as infrequently as possible while you are cooking, baking or roasting.
- It is best to bake several cakes one after the other. The oven is still warm. This reduces the baking time for the second cake. You can also place two loaf tins next to each other.
- For longer cooking times, you can switch the oven off 10 minutes before the end of the cooking time and use the residual heat to finish cooking.

Environmentally-friendly disposal

Dispose of packaging in an environmentally-friendly manner.



This appliance is labelled in accordance with European Directive 2012/19/EU concerning used electrical and electronic appliances (waste electrical and electronic equipment - WEEE). The guideline determines the framework for the return and recycling of used appliances as applicable throughout the EU.

Measures to be noted during transport

Secure all mobile parts in and on the appliance using an adhesive tape that can be removed without leaving any traces. Push all accessories (e.g. baking tray) into the corresponding slots with cardboard at the edges, in order to avoid damaging the appliance. Place cardboard or similar between the front and rear side to prevent knocks against the inside of the door glass. Secure the oven door to the side walls of the appliance using adhesive tape.

Keep the original appliance packaging. Only transport the appliance in the original packaging. Observe the transport arrows on the packaging.

If the original packaging is no longer available

pack the appliance in protective packaging to guarantee sufficient protection against any transport damage.

Transport the appliance in an upright position. Do not hold the appliance by the door handle or the connections on the rear, as these could be damaged. Do not place any heavy objects on the appliance.

Tested for you in our cooking studio

Here you will find a selection of dishes and the ideal settings for them. We will show you which type of heating and which temperature are best suited for your dish. You can find information about suitable accessories and the height at which they should be inserted. There are also tips about cookware and preparation methods.

Notes

- The values in the table always apply to dishes placed into the cooking compartment when it is cold and empty.
Only preheat the appliance if the table specifies that you should do so. Do not line the accessories with greaseproof paper until after they have been preheated.
- The times specified in the tables are guidelines only. They will depend on the quality and composition of the food.
- Use the accessories supplied. Additional accessories may be obtained as special accessories from specialist retailers or from the after-sales service.
Before using the oven, remove any unnecessary accessories and ovenware from the cooking compartment.
- Always use oven gloves when taking hot accessories or ovenware out of the cooking compartment.

Cakes and pastries

Baking on one level

When baking cakes and tarts, the best results can be achieved using  Top/bottom heating.

When baking with  3D Hot air, use the following shelf positions for the accessories:

- Cake in a cake tin: Shelf position 2
- Cake on a baking tray: Shelf position 3

Baking and roasting on two or more levels

Use  3D hot air.

Shelf positions for baking and roasting on 2 levels:

- Universal pan: Shelf position 3
- Baking tray: Shelf position 1

Dishes that are put in the oven at the same time do not have to be ready at the same time.

The tables contain a selection of dishes.

Baking tins

It is best to use dark-coloured metal baking tins.

Baking times are increased when light-coloured baking tins made of thin metal or glass dishes are used, and cakes do not brown so evenly.









If you wish to use silicone baking tins, use the information and recipes provided by the manufacturer as a guide. Silicone baking tins are often smaller than normal tins. The amount of mixture and recipe instructions may differ.

Tables

The tables show the ideal type of heating for the various cakes and pastries. The temperature and baking time depend on the amount and composition of the mixture. This is why temperature ranges are given in the tables. You should try the lower temperature first, since a lower temperature results in more even browning. You can increase the temperature next time if necessary.

If you preheat the oven, the baking time is shortened by 5 to 10 minutes.

Additional information can be found in the *Baking tips* section following the tables.

Cake in a mould	Tin	Level	Type of heating	Temperature, °C	Cooking time in minutes
Sponge cake, simple	Fruit loaf tin	2		160-180	55-65
Sponge cake, delicate (e.g. sand cake)	Fruit loaf tin	2		155-175	65-75
Shortcrust pastry base with crust	Springform cake tin	1		160-180	30-40
Sponge flan base	Flan-base cake tin	2		160-180	25-35
Sponge cake	Springform cake tin	2		160-180	30-40
Fruit tart or cheesecake, shortcrust pastry*	Dark springform cake tin	1		170-190	70-90
Delicate fruit flan, sponge	Springform cake tin	2		150-170	55-65
Savoury cakes* (e.g. quiche/onion tart)	Springform cake tin	1		180-200	50-60

* Allow cakes to cool in the appliance for approx. 20 minutes.

Cakes on trays	Accessories	Level	Type of heating	Temperature in °C	Cooking time in minutes
Sponge mixture or yeast dough with dry topping	Universal pan	3	☐	160-180	25-35
	Enamel baking tray + universal pan*	1+3	☒	150-170	40-50
Sponge mixture or yeast dough with fresh fruit	Universal pan	3	☐	140-160	40-50
	Enamel baking tray + universal pan*	1+3	☒	130-150	50-60
Sponge roulade (preheat)	Universal pan	2	☐	170-190	15-20
Plaited loaf, 500 g flour	Universal pan	2	☐	160-180	25-35
Stollen, 500 g flour	Universal pan	3	☐	160-180	50-60
Stollen, 1 g flour	Universal pan	3	☐	150-170	90-100
Strudel, sweet	Universal pan	2	☐	180-200	55-65
Pizza	Universal pan	3	☐	180-200	20-30
	Enamel baking tray + universal pan*	1+3	☒	150-170	35-45

* When baking on two levels, always place the universal pan in the upper level.

Bread and bread rolls

Never pour water directly into a hot oven.

If not specified otherwise, always preheat the oven for baking bread.



Bread and bread rolls	Accessories	Level	Type of heating	Temperature, °C	Cooking time in minutes
Yeast bread, 1.2 kg flour	Universal pan:	2	☐	270	8
				190	35-45
Sourdough bread, 1.2 kg flour	Universal pan:	2	☐	270	8
				190	35-45
Bread rolls (e.g. rye rolls)	Universal pan:	2	☐	200-220	20-30

Small baked products	Accessories	Level	Type of heating	Temperature in °C	Cooking time in minutes
Biscuits	Universal pan	3	☐	150-170	10-20
	Enamel baking tray + universal pan*	1+3	☒	130-150	30-40
Meringue	Universal pan	3	☒	70-90	135-145
Cream puffs	Universal pan	2	☐	200-220	30-40
Macaroons	Universal pan	3	☐	110-130	30-40
	Enamel baking tray + universal pan*	1+3	☒	100-120	35-45
Puff pastry	Universal pan	3	☒	190-210	20-30
	Enamel baking tray + universal pan*	1+3	☒	180-200	30-40

* When baking on two levels, always place the universal pan in the upper level.

Baking tips

You wish to bake according to your own recipe.	Use similar items in the baking tables as a guide.
How to establish whether sponge cake is baked through.	Approximately 10 minutes before the end of the baking time specified in the recipe, stick a cocktail stick into the cake at the highest point. If the cocktail stick comes out clean, the cake is ready.
The cake collapses.	Use less fluid next time or set the oven temperature 10 degrees lower. Observe the specified mixing times in the recipe.
The cake has risen in the middle but is lower around the edge.	Do not grease the sides of the springform cake tin. After baking, loosen the cake carefully with a knife.
The cake goes too dark on top.	Place it lower in the oven, select a lower temperature and bake the cake for a little longer.
The cake is too dry.	When it is done, make small holes in the cake using a cocktail stick. Then drizzle fruit juice or an alcoholic beverage over it. Next time, select a temperature 10 degrees higher and reduce the baking time.

The bread or cake (e.g. cheesecake) looks good, but is soggy on the inside (sticky, streaked with water).	Use slightly less fluid next time and bake for slightly longer at a lower temperature. For cakes with a moist topping, bake the base first. Sprinkle it with almonds or bread crumbs and then place the topping on top. Please follow the recipe and baking times.
The cake is unevenly browned.	Select a slightly lower temperature to ensure that the cake is baked more evenly. Bake delicate pastries on one level using  Top/bottom heating. Protruding greaseproof paper can affect the air circulation. For this reason, always cut greaseproof paper to fit the baking tray.
The bottom of a fruit cake is too light.	Place the cake one level lower the next time.
The fruit juice overflows.	Next time, use the deeper universal pan, if you have one.
Small baked items made out of yeast dough stick to one another when baking.	There should be a gap of approx. 2 cm around each item. This gives enough space for the baked items to expand well and turn brown on all sides.
You were baking on several levels. The items on the top baking tray are darker than that on the bottom baking tray.	Always use  3D hot air to bake on more than one level. Baking trays that are placed in the oven at the same time will not necessarily be ready at the same time.
Condensation forms when you bake moist cakes.	Baking may result in the formation of water vapour, which escapes above the door. The steam may settle and form water droplets on the control panel or on the fronts of adjacent units. This is a natural process.

Meat, poultry, fish

Ovenware

You may use any heat-resistant ovenware. The universal pan is suitable for large roasts.

Glass ovenware is the most suitable. Ensure that the lid of the roasting dish fits well and closes properly.

Add a little more liquid when using enamelled roasting dishes.

With roasting dishes made of stainless steel, browning is not so intense and the meat may be somewhat less well cooked. Increase the cooking times.

Information in the tables:

Ovenware without a lid = open

Ovenware with a lid = closed

Always place the ovenware in the centre of the wire rack.

Place hot glass ovenware on a dry mat after cooking. The glass could crack if placed on a cold or wet surface.

Roasting

Add in a little liquid if the meat is lean. Cover the base of the ovenware with approx. ½ cm of liquid.

Add liquid generously for pot roasts. Cover the base of the ovenware with approx. 1 - 2 cm of liquid.

The amount of liquid depends on the type of meat and the material the ovenware is made of. If preparing meat in an enamelled roasting dish, it will need a little more liquid than if cooked in glass ovenware.

Roasting dishes made from stainless steel are not ideal. The meat cooks more slowly and browns less fully. Use a higher temperature and/or a longer cooking time.

Tips for grilling

Always grill with the oven door closed.

Heat the grill for approximately 3 minutes before placing the food to be grilled on the wire rack.

Place the food to be grilled directly on the wire rack. If you are grilling a single piece, the best results are achieved by placing it in the centre of the wire rack. The universal pan should also be inserted at level 1. The meat juices are collected in the pan, keeping the oven cleaner.

Do not insert the baking tray or universal pan at level 4. They may become deformed at high temperatures and damage the cooking compartment when they are removed.

If possible, grill items should be of equal thickness. This will allow them to brown evenly and remain succulent and juicy. Only add salt to steaks once they have been grilled.

Turn grilled items after ⅔ of the specified time.

The grill element switches on and off intermittently. This is normal. The grill setting determines how frequently this occurs.







Meat

Turn pieces of meat halfway through the cooking time.

When the roast is ready, turn off the oven and allow it to rest for an additional 10 minutes. This allows better distribution of the meat juices.

After cooking, wrap sirloin in aluminium foil and leave it to rest for 10 minutes in the oven.

For roast pork with a rind, score the rind in a crossways pattern, then lay the roast in the dish with the rind at the bottom.

Meat	Weight	Accessories and ovenware	Level	Type of heating	Temperature °C, grill setting	Cooking time in minutes	
Beef	Joint of beef	Covered	1.0 kg	2		200-220	120
	1.5 kg		2		190-210	140	
	2.0 kg		2		180-200	160	
Tenderloin, medium rare	1.0 kg	Uncovered	1		210-230	70	
	1.5 kg		1		200-220	80	
Sirloin, medium rare	1.0 kg	Uncovered	1		230-250	50	
Steaks, 3 cm, medium rare		Wire rack + universal pan	4+1		3	15	

Meat	Weight	Accessories and ovenware	Level	Type of heating	Temperature °C, grill setting	Cooking time in minutes
Veal						
Joint of veal	1.0 kg	Uncovered	1		200-220	100
	1.5 kg		1		190-210	120
	2.0 kg		1		180-200	140
Pork						
without rind (e.g. neck)	1.0 kg	Uncovered	1		190-210	120
	1.5 kg		1		180-200	150
	2.0 kg		1		170-190	170
with rind (e.g. shoulder)	1.0 kg	Uncovered	1		180-200	130
	1.5 kg		1		190-210	160
	2.0 kg		1		170-190	190
Smoked pork on the bone	1.0 kg	Covered	1		210-230	80
Lamb						
Leg of lamb, boned, medium	1.5 kg	Uncovered	1		170-190	120
Minced meat						
Meat loaf	approx. 750 g	Uncovered	1		180-200	70
Sausage						
Sausage		Wire rack + universal pan	4+1		3	15

Poultry

The values in the table apply to dishes placed in a cold oven.

The weights indicated in the table are for unstuffed poultry that is ready for roasting.

If you are grilling directly on the wire rack, you should also insert the universal pan at level 1.

When cooking duck or goose, pierce the skin on the underside of the wings to allow the fat to escape.

Place the bird onto the wire rack with the breast side facing downwards. Turn the whole bird when two thirds of the cooking time has elapsed.

Poultry will turn out particularly crispy and brown if you baste it towards the end of the roasting time with butter, salted water or orange juice.

Poultry	Weight	Accessories and ovenware	Level	Type of heating	Temperature °C, grill setting	Cooking time in minutes
Chicken halves, 1-4 pieces	400g each	Wire rack	2		210-230	40-50
Chicken pieces	250 g each	Wire rack	3		210-230	30-40
Chicken, whole, 1-4 pieces	per 1 kg	Wire rack	2		200-220	55-85
Duck, whole	1.7 kg	Wire rack	2		170-190	80-100
Goose, whole	3.0 kg	Wire rack	2		160-180	110-130
Small turkey, whole	3.0 kg	Wire rack	2		180-200	80-100
2 turkey drumsticks	800g each	Wire rack	2		180-200	80-100

Fish

Turn the pieces of fish after $\frac{2}{3}$ of the specified time.

Whole fish do not need to be turned. Place the whole fish in the oven in swimming position with the dorsal fin facing upwards.

To ensure that the fish remains in position, place half a potato or a small, ovenproof container into the stomach cavity.

If you are grilling directly on the wire rack, also insert the universal pan at level 1. The fish juices are collected in the pan and the oven is kept cleaner.

Fish	Weight	Accessories and ovenware	Level	Type of heating	Temperature °C, grill setting	Cooking time in minutes
Fish, whole	300 g each	Wire rack	3		2	20-25
	1.0 kg	Wire rack	2		190-210	40-50
	1.5 kg	Wire rack	2		180-200	60-70
Fish, in slices (e.g. steaks)	300 g each	Wire rack	4		2	20-25

Tips for roasting and grilling







The table does not contain information for the weight of the joint.	Select the next lowest weight from the instructions and extend the time.
How to tell when the roast is ready.	Use a meat thermometer (available from specialist shops) or carry out a "spoon test". Press down on the roast with a spoon. If it feels firm, it is ready. If the spoon can be pressed in, it needs to be cooked for a little longer.
The roast is too dark and the crackling is partly burnt.	Check the shelf height and temperature.
The roast looks good but the juices are burnt.	Next time, use a smaller roasting dish or add more liquid.
The roast looks good but the juices are too clear and watery.	Next time, use a larger roasting dish and use less liquid.
Steam rises from the roast when basted.	This is normal and due to the laws of physics. The majority of the steam escapes through the steam outlet. It may settle and form condensation on the cooler switch panel or on the fronts of adjacent units.

Bakes, gratins, toast with toppings

If you are grilling directly on the wire rack, the universal pan should also be inserted at level 1. This keeps the oven cleaner.

Always place the ovenware on the wire rack.

How well cooked the bake is will depend on the size of the dish and the height of the bake. The figures in the table are only average values.





Dish	Accessories and ovenware	Level	Type of heating	Temperature, °C	Cooking time in minutes
Bakes					
Bake, sweet	Ovenproof dish	2		170-190	50-60
Pasta bake	Ovenproof dish	2		210-230	25-35
Gratin					
Potato gratin made using raw ingredients, Max. 2 cm deep	Ovenproof dish	2		150-170	50-60
Toast					
Toasting bread, 4 slices	Wire rack	4		3	6-7
Toasting bread, 12 slices	Wire rack	4		3	4-5
Toast, with topping, 4 slices	Wire rack	3		3	7-10
Toast, with topping, 12 slices	Wire rack	3		3	5-8

Preprepared products

Observe the instructions on the packaging.

If you line the accessories with greaseproof paper, make sure that the paper is suitable for these temperatures. Make sure the paper is a suitable size for the dish to be cooked.

The cooking result greatly depends on the quality of the food. Pre-browning and irregularities can sometimes even be found on the raw product.

Dish	Accessories	Level	Type of heating	Temperature in °C	Cooking time in minutes
Strudel with fruit filling	Universal pan	3		190-210	45-55
Chips	Universal pan	3		210-230	25-30
Pizza	Wire rack	2		200-220	15-20
Pizza baguette	Wire rack	2		190-210	15-20

Note

The universal pan may warp when cooking frozen dishes. The reason for this is the large temperature differences that the accessory is subjected to. The deformation disappears as early as during the cooking process.



Special dishes

At low temperatures,  3D hot air is equally useful for producing creamy yoghurt as it is for proving light yeast dough.

First, remove accessories, hook-in racks or telescopic shelves from the cooking compartment.

Preparing yoghurt

1. Bring 1 litre of milk (3.5 % fat) to the boil and cool down to 40 °C.
2. Stir in 150 g of yoghurt (at refrigerator temperature).
3. Pour into cups or small screw-top jars and cover with cling film.

Dish	Ovenware		Type of heating	Temperature	Cooking time
Yoghurt	Cups or screw-top jars	on the cooking compartment floor		50 °C Preheat	5 mins
				50 °C	8 hrs
Proving dough	Heat-resistant dish	on the cooking compartment floor		50 °C Preheat	5-10 mins
				Switch off the appliance and place the yeast dough in the cooking compartment	20-30 mins

Defrosting

The defrosting time depends on the amount and type of food. Observe the instructions on the packaging.

Take food out of its packaging and place in suitable ovenware on the wire rack.

Place poultry with the breast side to the plate.

Frozen food

e.g. cream cakes, buttercream cakes, gateaux with chocolate or sugar icing, fruit, chicken, sausage and meat, bread and bread rolls, cakes and other baked items

Accessories	Level	Type of heating	Temperature
Wire rack	2		The temperature selector remains switched off

Drying

With  3D hot air, you can dry foods brilliantly.





Use unblemished fruit and vegetables only and wash them thoroughly.

Drain off the excess water, then dry them.

Line the universal pan and the wire rack with greaseproof or parchment paper.

Turn very juicy fruit or vegetables several times.

Remove fruit and vegetables from the paper as soon as they have dried.

Fruit and herbs	Accessories	Level	Type of heating	Temperature	Cooking time
600 g apple rings	Universal pan + rack	3+1		80 °C	5 hrs (approx.)
800 g pear slices	Universal pan + rack	3+1		80 °C	8 hrs (approx.)
1.5 kg damsons or plums	Universal pan + rack	3+1		80 °C	8-10 hrs (approx.)
200 g herbs, washed	Universal pan + rack	3+1		80 °C	1½ hrs (approx.)

Preserving

For preserving, the jars and rubber seals must be clean and intact. If possible, use jars of the same size. The information in the table is for round, one-litre jars.

Caution!

Do not use jars that are larger or taller than this. The lids could crack.

Only use fruit and vegetables in good condition. Wash them thoroughly.

The times given in the tables are a guide only. The time will depend on the room temperature, number of jars, and the quantity and temperature of the contents. Before you switch off the appliance or change the cooking mode, check whether the contents of the jars are bubbling as they should.

Preparation

1. Fill the jars, but not to the top.
2. Wipe the rims of the jars, as they must be clean.
3. Place a damp rubber seal and a lid on each jar.
4. Seal the jars with the clips.

Place no more than six jars in the cooking compartment.

Making settings

1. Insert the universal pan at level 2. Arrange the jars on it so that they do not touch each other.
2. Pour ½ litre of hot water (approx. 80 °C) into the universal pan.
3. Close the oven door.
4. Set Bottom heating.
5. Set the temperature to between 170 and 180 °C.

Preserving

Fruit

After approx. 40 to 50 minutes, small bubbles begin to form at short intervals. Switch off the oven.

After 25 to 35 minutes of residual heat, remove the preserving jars from the cooking compartment. If they are allowed to cool for longer in the cooking compartment, germs could multiply, promoting acidification of the preserved fruit.

Fruit in one-litre jars	When it starts to bubble	Residual heat
Apples, redcurrants, strawberries	Switch off	approx. 25 minutes
Cherries, apricots, peaches, gooseberries	Switch off	approx. 30 minutes
Apple purée, pears, plums	Switch off	approx. 35 minutes

Vegetables

As soon as bubbles begin to form in the jars, set the temperature back to between 120 and 140 °C. Depending on

the type of vegetable, heat for approx. 35 to 70 minutes. Switch off the oven after this time and use the residual heat.

Vegetables with cold cooking water in one-litre jars	When it starts to bubble	Residual heat
Gherkins	-	approx. 35 minutes
Beetroot	approx. 35 minutes	approx. 30 minutes
Brussels sprouts	approx. 45 minutes	approx. 30 minutes
Beans, kohlrabi, red cabbage	approx. 60 minutes	approx. 30 minutes
Peas	approx. 70 minutes	approx. 30 minutes

Taking out the jars

After preserving, remove the jars from the cooking compartment.

Caution!

Do not place the hot jars on a cold or wet surface. They could suddenly burst.

Acrylamide in foodstuffs

Acrylamide is mainly produced in grain and potato products prepared at high temperatures, such as potato crisps, chips,

toast, bread rolls, bread or fine baked goods (biscuits, gingerbread, cookies).

Tips for keeping acrylamide to a minimum when preparing food

General	<ul style="list-style-type: none">■ Keep cooking times to a minimum.■ Cook meals until they are golden brown, but not too dark.■ Large, thick pieces of food contain less acrylamide.
Baking	With top/bottom heating max. 200 °C. With 3D hot air or hot air max. 180 °C.
Biscuits	With top/bottom heating max. 190 °C. With 3D hot air or hot air max. 170 °C. Egg or egg yolk reduces the production of acrylamide.
Oven chips	Spread evenly over the baking tray, in a single layer. Bake at least 400 g per baking tray so that the chips do not dry out

Test dishes

These tables have been produced for test institutes to facilitate the inspection and testing of the various appliances.

In accordance with EN 50304/EN 60350 (2009) and IEC 60350.

Baking

Baking on 2 levels:

Always insert the universal pan above the baking tray.

Piped cookies (such as Spritz cookies in sugar syrup):

Dishes that are put in the oven at the same time do not have to be ready at the same time.

German apple pie, level 1







Change the position of the dark springform cake tin, slide in diagonally.

German apple pie, level 2

Change the position of the dark springform cake tin.

Cakes in a metal springform cake tin:

Bake on level 1 with  Top/bottom heating Place the springform cake tin on the universal pan instead of on the wire rack.

Dish	Accessories and oven-ware	Level	Type of heating	Temperature in °C	Cooking time in minutes
Viennese whirls	Universal pan	3		150-170	20-30
	Enamel baking tray + universal pan**	1+3		140-160	35-45
Small cakes	Universal pan	3		150-170	25-35
Small cakes, preheat	Enamel baking tray + universal pan**	1+3		140-160	30-40
Hot water sponge cake	Springform cake tin	2		160-180	30-40
German apple pie	Universal pan + 2 springform cake tins, dia. 20 cm***	1		190-210	70-80
	2 wire racks* + 2 springform cake tins, dia. 20 cm***	1+3		170-190	65-75



* Additional wire racks can be ordered as an optional accessory from the after-sales service or specialist retailers.

** When baking on two levels, always place the universal pan in the upper level.

*** Place the cake tins diagonally on the accessories.

Grilling

If you are grilling food directly on the wire rack, the universal pan should also be inserted at level 1. The liquid is then collected, keeping the oven cleaner.

Dish	Accessories and oven-ware	Level	Type of heating	Grill setting	Cooking time in minutes
Browning toast Preheat for 10 mins	Wire rack	4		3	1/2-2
Beefburgers, 12 pieces* No preheating	Wire rack + universal pan	4+1		3	25-30

* Turn over after 2/3 of the cooking time.





Robert Bosch Hausgeräte GmbH

Carl-Wery-Straße 34

81739 München

Germany

www.bosch-home.com



8001058179

01
091296