

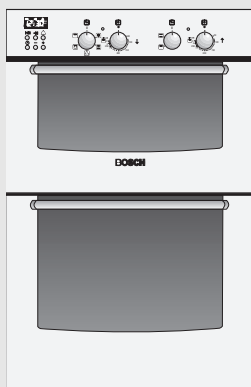

HBN 93 . .



**Installing and
Operating Instructions**



Household Appliances

Table of Contents

	Page		Page
Important Information		Grilling – Main oven	14
<input type="checkbox"/> Appliance safety considerations	2	<input type="checkbox"/> Roasting – Mini oven	15
<input type="checkbox"/> Notes on disposal	3	<input type="checkbox"/> Grilling – Mini oven	15
<input type="checkbox"/> Before connecting your new appliance	3	Cooking Tips and Helpful Hints	16
Before Using Your Appliance for the First Time		Defrosting and Cooking – Main oven	17
<input type="checkbox"/> Preliminary cleaning	3	Cleaning and Care	
<input type="checkbox"/> Initial burn-in	3	<input type="checkbox"/> Important cleaning basics	18
Introducing: Your New Oven		<input type="checkbox"/> Enamel and glass	18
<input type="checkbox"/> Control panel overview	4	<input type="checkbox"/> Stainless steel front	18
<input type="checkbox"/> Accessories	5	<input type="checkbox"/> Oven interior	18
<input type="checkbox"/> Shelf positions	5	<input type="checkbox"/> Cleaning function	18
Electronic Timer		<input type="checkbox"/> Removing/installing the oven door	19
<input type="checkbox"/> Time of day	6	<input type="checkbox"/> Removing shelf railings	19
<input type="checkbox"/> Alarm function	7	Service and Repair Information	20
<input type="checkbox"/> Automatic OFF	8	Trouble-shooting Guide	21
<input type="checkbox"/> Automatic ON and OFF	9	Assembly Instructions	
Baking, Roasting and Grilling		<input type="checkbox"/> For the installer and kitchen expert	22
<input type="checkbox"/> Definition of Oven Features	10	<input type="checkbox"/> Installation of the built-in oven	23
<input type="checkbox"/> Switching the oven ON and OFF	11		
<input type="checkbox"/> Baking – Main oven	12		
<input type="checkbox"/> Roasting – Main oven	13		

Appliance safety considerations

- The appliance should only be used for the preparation of food.
- The surfaces of heating and cooking appliances get hot during operation. The interior oven walls and the heating elements get extremely hot. Always keep children away from the appliance.
- Never leave the appliance unattended when cooking with fat or oil. They can catch fire if overheated.
- Clean the oven regularly. Fatty or oily remnants could ignite when the oven is switched on.
- In the case of a defect, switch off at the mains.
- Do not store combustible items in the oven. They could ignite if the oven is switched on accidentally.
- Do not clean the oven with steam or high-pressure cleaners.
- Make sure that the power cord does not get caught in the hot oven door. The plastic insulation could melt.
- If using hot air , do not place greaseproof paper loosely in the oven (e.g. when heating the oven). The hot-air fan could draw in the paper which may damage the heater and fan.
- Do not insert a baking sheet at the bottom of the oven, or cover it with aluminium foil, because a heat build-up would result. Roasting and baking times would change, and the enamel would be damaged.
- Never pour water directly into the hot oven. Damage to the enamel could result.
- Dripping juices may leave spots on the oven lining. Always place a baking tray below to prevent this from happening.
- Never stand or sit on the open oven door.
- The oven door must close properly. Keep the door sealing surfaces clean.

Notes on disposal

- ❑ Old appliances still have some residual value. An environment-friendly method of disposal will ensure that valuable raw materials can be recovered and used again.
Before you dispose of your old appliance, make sure that it has been rendered inoperable.
- ❑ Your new appliance was protected by suitable packaging while it was on its way to you. All materials used for this purpose are environment-friendly and suitable for recycling. Please make a contribution to protecting the environment by disposing of the packaging appropriately.
Up-to-date information concerning options for disposing of your old appliance and the packaging from the new one can be obtained from your retailer or local government office.

Before connecting your new appliance

- ❑ Before using your new appliance, please read these Instructions for Use carefully. They contain important information concerning your personal safety as well as on use and care of the appliance.
- ❑ The Instructions for Use apply to several versions of this appliance. Accordingly, you may find descriptions of individual features that do not apply to your specific appliance.
- ❑ Please keep the operating and installation instructions in a safe place; this important documentation may also be of use to a possible subsequent owner.
- ❑ Do not use the appliance if it is damaged in any way.
- ❑ Installation and connection of the appliance should be performed according to the instructions and connection diagram provided, and should be entrusted to a competent electrician. In the event of a damage that occurs as a result of improper connection, the warranty will be void.
- ❑ Our appliances meet the applicable safety regulations for electrical appliances. Repairs must only be performed by service engineers trained by the manufacturer. Repairs carried out by incompetent service agents can make the appliance unsafe.

Before Using Your Appliance for the First Time

Preliminary cleaning:

1. Clean the appliance exterior with a soft damp cloth.
2. Clean the oven interior and the accessories with a hot detergent solution.

Initial burn-in

1. Heat the empty oven for approx. 30 minutes.
Select conventional heat at a setting of 240 °C.
During the initial burn-in phase, please open the kitchen windows to dissipate unpleasant odours.

Introducing: Your new Oven

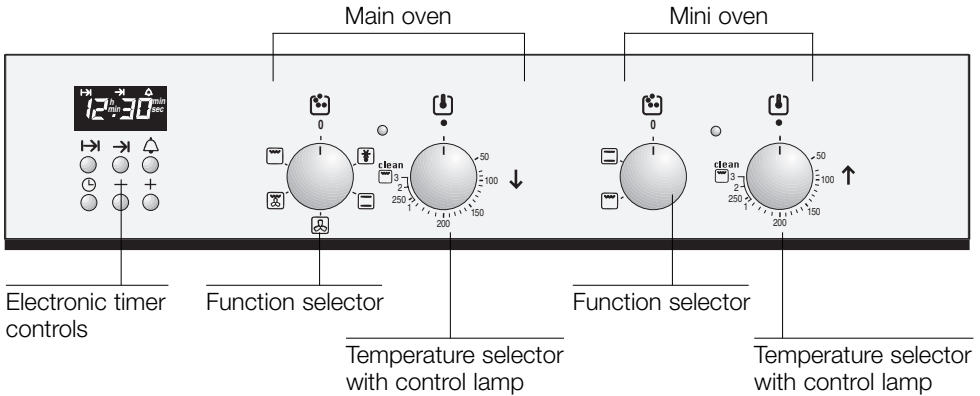

The control panel:

- ❑ The switches are retractable. To engage and disengage, depress the switch, making sure that it is in OFF position.

Main oven

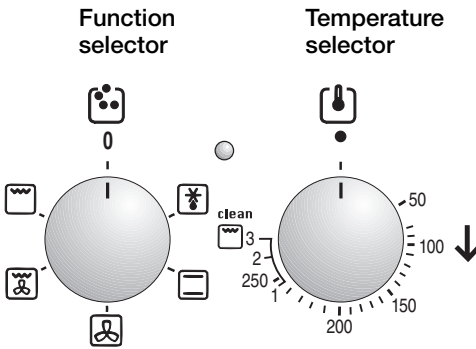

Settings:

- "Defrost" setting
- Conventional (top and bottom heat)
- Hot air
- Hot air grilling
- Radiant grilling

Settings:

- 50–250** temperature in °C
- 1-2-3** temperature for radiant grilling

Mini oven

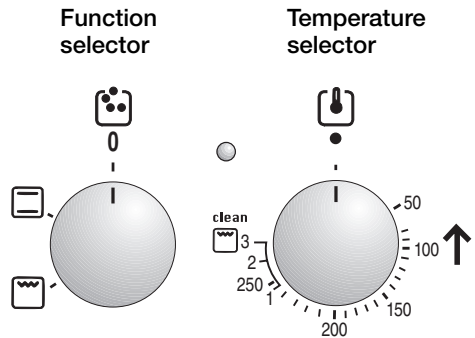

Settings:

- Conventional (top and bottom heat)
- Radiant grilling

Settings:

- 50–250** temperature in °C
- 1-2-3** temperature for radiant grilling

Introducing: Your new Oven

Accessories

Your oven comes with the following accessories:

Universal baking pan / shelf

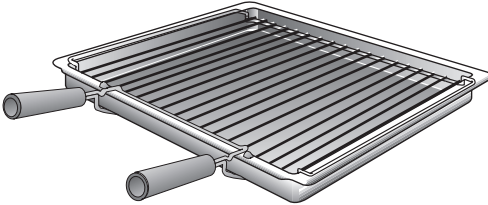

wire shelf

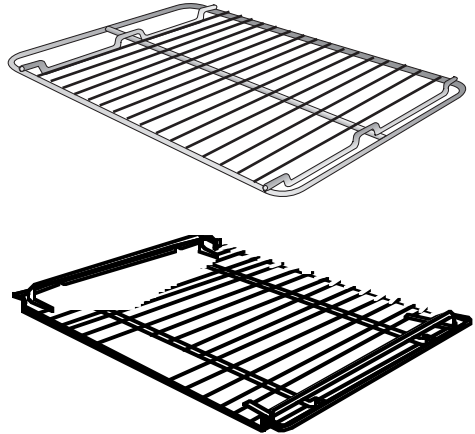

Additional accessories are available from your dealer.

Shelf positions

Your oven features 3 shelf positions. The shelf positions are counted from bottom to top. The numbers are marked in the oven.

Mini oven

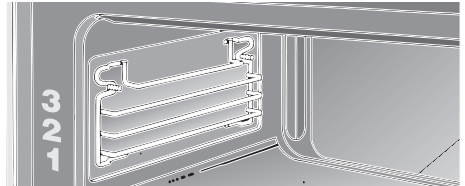

Your oven features 4 shelf positions. The shelf positions are counted from bottom to top. The numbers are marked in the oven.

When using hot air do not use shelf »2«, in order not to block air circulation.

Main oven

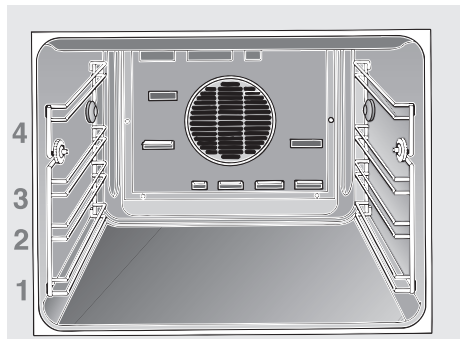

Electronic timer

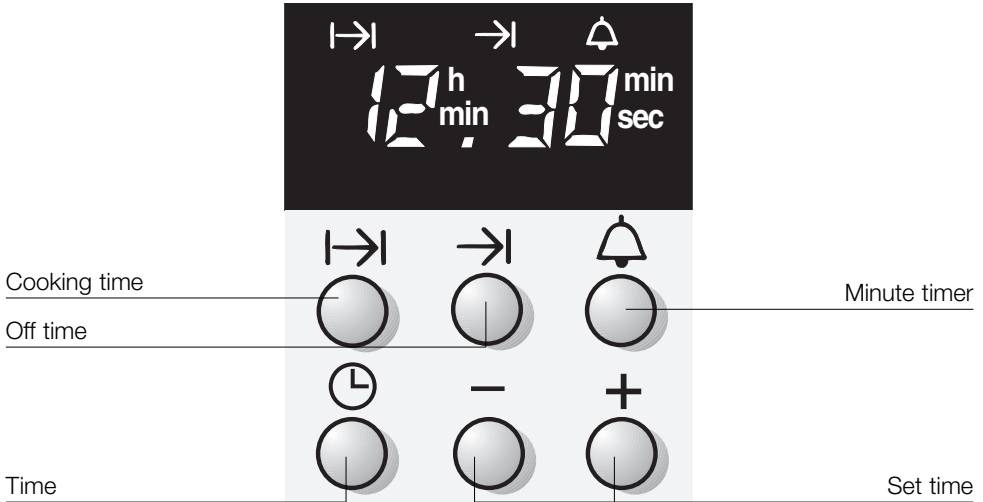

Notes:

- If you keep the button **-** or **+** pressed down, you can set the time in steps of 10 minutes.
- The time of day is not displayed if you have already set the timer, a duration or an end. Should you wish to know the time, simply press the clock button . The time appears in the display for a few seconds.

Time of day

- Before you use your appliance for the first time, it is necessary to set the current time on the electronic timer.
- After connecting to the mains, or after a power failure, the display **0.00** will blink.

Setting the time of day:

1. Press the clock button .
2. Set the current time with the **-** or **+** button. The time will automatically be taken over after a few seconds.

Changing the time (e.g. transition from summer to winter time):

Caution! The time of day cannot be changed whilst a duration or an end is set.

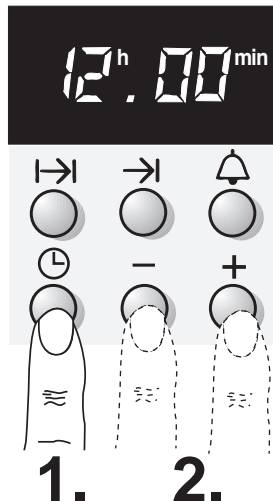

1. Press the clock button .
2. Set the current time with the **-** or **+** button.



The alarm

- ❑ The alarm (timer) can be set at any time.
This applies even if a duration or an end has already been set.
- ❑ The alarm time always counts down visibly in the display.
The alarm also features a special acoustic signal.
This enables you to hear when the alarm time or a selected duration has expired.

Setting procedure:

1. Press the alarm button .
 2. Set the desired alarm time with the - or + button.
- ❑ The selected time is automatically registered after a few seconds. The alarm time begins to count down in the clock display.
 - ❑ **On completion of the selected time**, an acoustic signal sounds and the alarm symbol flashes. It is possible to switch off the signal prematurely by pressing the alarm button .

Correction:

- ❑ Press the alarm button 
Change the time with the - or + button.

Cancelling:

- ❑ Press the alarm button  twice in quick succession.

Setting:

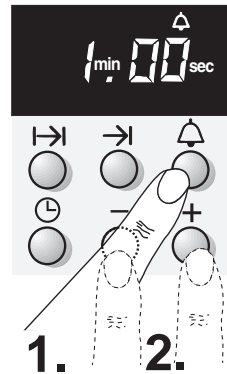

Automatic timer for the main oven

- ❑ You can switch the oven on and off via the electronic clock.

Automatic switch off:

- ❑ If you wish to bake or roast food immediately, it is only necessary to set the cooking time.
 1. Select the heating system and the oven temperature.
 2. Press the time button I→I.
 3. Change the recommended cooking time with the - or + button.
The oven starts after a few seconds.
- ❑ An acoustic signal sounds **when the time expires**. The oven switches off. You may switch off the signal prematurely by pressing the time button I→I.
- ❑ **If the meal is not yet ready**, make a new time setting using the knob.
- ❑ Switch off the function selector **when your meal is ready**.

Correction:

- ❑ The duration can be changed at any time. Press the cooking time button I→I and correct the duration of cooking time with the - or + button.

Cancel:

- ❑ Switch off the function selector.

Notes:

- ❑ The alarm time counts down in the clock display. If you want to know how much longer the meal in the oven will take, simply press the time button I→I. The time remaining is then displayed for a few seconds.
- ❑ You can set any time between 1 minute and 23 hours, 59 minutes.

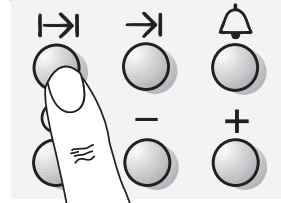

2.

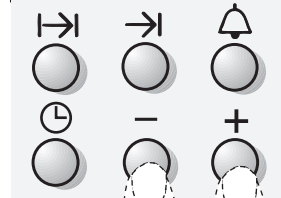

3.

Electronic timer

Automatic switch on and switch off:

Please remember that easily spoiled foods must not be allowed to remain in the oven for too long.

Need to be somewhere else – quickly? Don't worry, the food will still be ready at the right time. That's because the oven switches on and off automatically at the desired times.

1. Select the heating system and the oven temperature.
 2. Press the time button \rightarrow .
 3. Change the recommended cooking time with the - or + button.
 4. Press the end button \rightarrow . The end time appears in the display. This represents the time when the oven will switch off. Change this to a later time.
 5. Set the new end time with the + button.
- The oven switches on and off automatically. The clock display contains the time remaining until the oven switches on. The duration then begins to count down.
 - An acoustic signal sounds **when the time expires**. The oven switches off. You may switch off the signal prematurely by pressing the time button \rightarrow .
 - If the meal is not yet ready**, make a new time setting using the knob.
 - Switch off the function selector **when your meal is ready**.

Correction:

- Before starting the oven, you may change the end time at any juncture. To do this, press the end button \rightarrow . Change the end time with the - or + button.

Cancel:

- Switch off the function selector.

Note:

- The end time will appear for a few seconds if you press the end button \rightarrow .



2.



3.

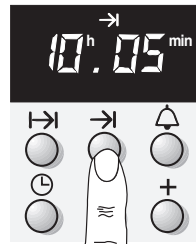

4.



5.

Definition of Oven Features

Mini oven

Radiant grilling _____

The food being cooked is exposed to heat radiation from the heating element at the top of the oven cavity.

Advantages:

- particularly suitable for flat, small cuts of meat, i.e., steaks and sausages, fish, vegetables and toast.

Conventional cooking _____

(top and bottom heat)

The food being cooked is exposed to heat radiation from heating elements located at the top and bottom of the oven cavity.

Cooking is possible on one shelf level only.

Advantages:

- baking rich fruit cake, pizza, quiche.

Main oven

Gentle defrosting _____

Advantages:

Recommended for delicate pastries only (i.e., whipped-cream gateaus).

Conventional cooking _____

(top and bottom heat)

The food being cooked is exposed to heat radiation from heating elements located at the top and bottom of the oven cavity.

Cooking is possible on one shelf level only.

Advantages:

- baking rich fruit cake, pizza, quiche.

Hot air grilling _____

With hot air grilling the fan and the grill elements are activated alternatively.

The heat generated by the grill element is evenly distributed in the oven cavity by the fan. This method of cooking gives an effect similar to spit roasting (rotisserie)

Advantages:

- particularly suitable for pork and poultry when a crisp skin is desired.

Hot air _____

Advantages of hot air:

- low soiling of oven interior
- cooking on up to 3 shelf levels at once is possible
- shorter preheating times
- low oven temperatures
- gentle defrosting
- bread baking

Radiant grilling _____

The food being cooked is exposed to heat radiation from the heating element at the top of the oven cavity.

Advantages:

- particularly suitable for flat, small cuts of meat, i.e., steaks and sausages, fish, vegetables and toast.

Switching the Oven ON and OFF

Mini oven:

Before switching on your oven, you should decide which heating system you wish to use.

Switching the oven ON:

1. Use the function selector to determine the desired system.
 2. Set the temperature control knob to the desired temperature.
- The selected temperature will be controlled automatically.
 - The red oven temperature control lamp illuminates when the oven is first switched on, and extinguishes when the required temperature has been reached.

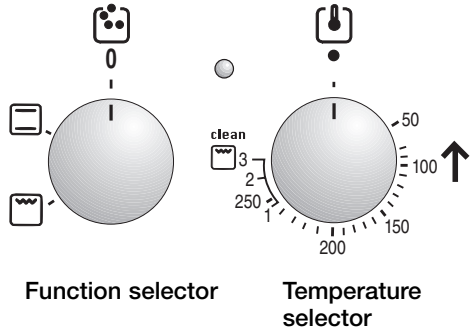

Main oven:

Before switching on your oven, you should decide which heating system you wish to use.

Switching the oven ON:

1. Use the function selector to determine the desired system.
 2. Set the temperature control knob to the desired temperature.
- The selected temperature will be controlled automatically.
 - The red oven temperature control lamp illuminates when the oven is first switched on, and extinguishes when the required temperature has been reached.

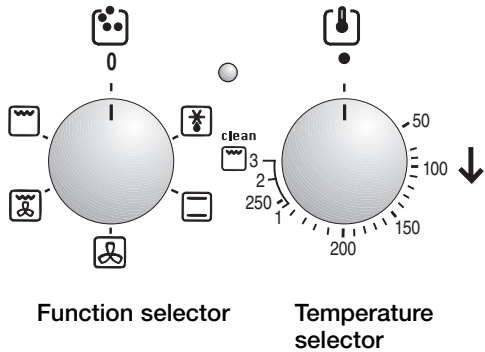

Switching the oven OFF:

To switch the oven OFF, turn both the temperature selector and function selector to the »0« position.

Note: After switching OFF the oven, the fan may continue to run for a short time in order to prevent heat build-up.

Using baking tins

- Always place baking tins in the centre of the wire shelf.**
- The wire shelf may be turned upside down to accommodate different size tins.
- If the cake bottom gets too dark:**
Check the shelf level. Shorten the baking time, and possibly use a lower baking temperature.
- If the cake bottom stays too light:**
Check the shelf level. Increase the baking time, select a lower temperature, or use a dark metal baking tin.
- You can use baking tins of any material and having any colour, as long as they are oven-proof.
- Do not place baking tins or high cakes too close to the rear oven wall.

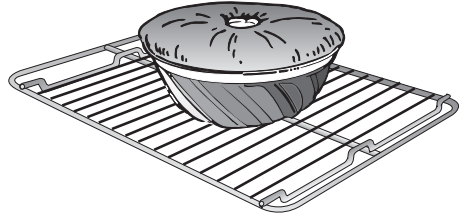

Notes:

- You can influence the degree of browning by changing the temperature setting.
- If a cake collapses after removing it from the oven, use less liquid on your next attempt, consider using a longer baking time, or use a slightly lower temperature setting.

Roasting – Main oven

Roasting with hot air

Notes:

- Meat roasted using the hot air system will brown on all sides and stay moist without adding additional fat.
- Choose cuts of meat that weigh 150 grams (5oz) or more.
- Place the shelf on top of the universal pan.
- Place the meat on the shelf, season if desired.
- Slide the pan and shelf into the oven on the same shelf position.
- No pre-heating is required. Save energy by putting the roast into the cold oven.
- Use a hot air temperature of 160 °C.
- Let the meat rest for 10 minutes after roasting, this will allow the juices to settle and prevent them from running out of the meat when sliced.

Roasting with Conventional heat

- Follow the steps above. With fatty meat 125 – 250 ml (4 – 8floz) of water can be poured into the roasting pan.
- Baste the meat if desired.

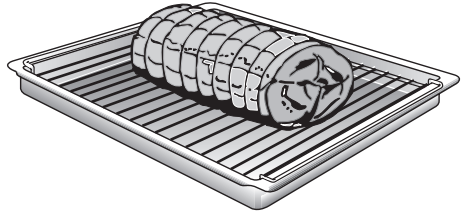

- Place in a cold oven to save energy or pre-heat if desired.

Casseroles or pot-roasting in a covered dish:

- Some meats should be prepared in liquid in a covered casserole. This type of cooking is suitable for less tender cuts of meat.
- Place the casserole on the wire shelf at a suitable shelf position.

Cooking tips:

- Only use ovenproof cookware.
- Extra large Turkeys and joints can be placed directly in the universal pan and not on the wire shelf.
- Cover large Turkeys with foil during cooking. Remove foil during the last hour.

Hot air grilling

Use this method for particularly crispy poultry or pork with crackling.

- Use the shelf and universal pan together. Turn large joints after about half of the total cooking time. Do not place the meat too close to the grill element.
- Some types of food (e.g. fatty meats) will spit during hot air grilling. Therefore, to prevent burning-on of the soil, thorough cleaning of the oven is recommended after each use.

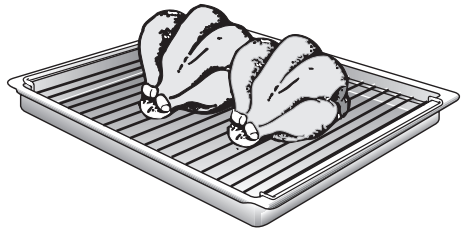

Roasting – Main oven

- ❑ Whole poultry should be turned after approx. two-thirds of the cooking time has elapsed. With duck and goose, pierce the skin under the wings to allow excess fat to drain off.
- ❑ After the end of the selected roasting time and with the oven switched OFF, leave the roast in the closed oven for approx. 10 minutes.

Grilling – Main oven

Radiant grilling

Used for small cuts of meat or poultry.

- ❑ Always use the shelf and universal pan together.
- ❑ Turn the food after approx. two-thirds of the grilling time has elapsed.
- ❑ Lightly brush the wire shelf with oil and baste the food if desired.

- ! **Exercise CAUTION when grilling.**
- **Always keep children away from the oven when it is in use.**

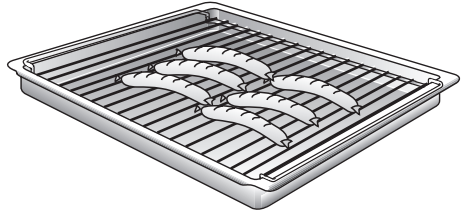

Roasting – Mini oven

Roasting with Conventional heat

- Follow the steps above. With fatty meat 125 – 250 ml (4 – 8floz) of water can be poured into the roasting pan.
- Baste the meat if desired.
- Place in a cold oven to save energy or pre-heat if desired.

Casseroling or pot-roasting in a covered dish:

- Some meats should be prepared in liquid in a covered casserole. This type of cooking is suitable for less tender cuts of meat.
- Place the casserole on the wire shelf at a suitable shelf position.

Cooking tips:

- Only use ovenproof cookware.
- Extra large Turkeys and joints can be placed directly in the universal pan and not on the wire shelf.
- Cover large Turkeys with foil during cooking. Remove foil during the last hour.

Grilling – Mini oven

Radiant grilling

Used for small cuts of meat or poultry.

- Exercise CAUTION when grilling.**
- Always keep children away from the oven when it is in use.**

Notes on grilling:

- Always close the oven door when grilling.
- The grilling temperatures are variable.
- Always use the grill and universal pan together.
- Turn the food after approx. two-thirds of the grilling time has elapsed.
- Lightly brush the wire shelf with oil and baste the food if desired.

- Always place the food to be grilled in the centre of the wire shelf.
- If the heating element switches off automatically, the overheating protection was activated. The element will be reactivated after a short period of time.

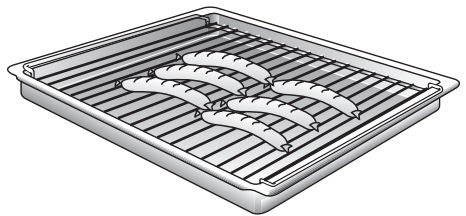

Cooking Tips and Helpful Hints

When cooking conventionally:

- Cakes baked in a tin get too dark at the back.
- The cake gets too dry.
- The inside of the cake remains spongy or doughy, or meat stays raw in the centre.

Ensure that no other pans or trays are in the oven. Lower shelf position. Place tin on wire shelf.

Select a slightly higher oven temperature. Cook for shorter period of time.

Use a slightly lower temperature and cook for a longer time. Reduce the liquid in the cake mixture.

When cooking with hot air:

- Cakes baked in a tin gets too dark at the back.
- Cakes remain doughy and collapse when removed from the oven.
- Uneven browning of small cakes or biscuits.
- With very moist foods steam develops and condenses on the oven door and drips onto the floor.

Avoid blocking the air vents at the rear wall of the oven with the cake tins.

Reduce the temperature for deep cakes. Bake for a longer period of time. Test with a skewer before removing.

Avoid placing trays too close to the back wall. Space food on the tray.

Several brief periods of opening the oven door during baking (1 or 2 times, more frequently with longer roasting times) will aid in venting the water vapour in the oven and reduce condensation.

To save energy:

- Preheat only if expressly required by the recipe.
- Dark baking tins have a higher degree of heat absorption.

- Residual heat:** In the case of longer baking times, you can switch off the oven 5 – 10 minutes before the full baking time has elapsed.

Defrosting and cooking using the hot air cooking option

Important heating system information:

- For defrosting and cooking of frozen or deep-frozen foods, use only the hot-air heating system.
- With all deep-frozen foods, follow the food manufacturers instructions on the packaging.
- If **frozen meat** is placed in the oven, the defrosting time must be added to the required cooking time.
- Always defrost **deep-frozen poultry** before cooking.
- For cooking **deep-frozen fish**, use the same temperatures as for fresh fish.
- Deep-frozen ready-to-eat meals** in aluminium dishes may be placed into the oven several at a time.
- Deep-frozen vegetables** (i.e., when cooking complete meals) should be cooked in a covered pot together with the roast. Use only approximately half of the liquid specified in the recipe. Use fat only for adding flavour.

Gentle defrosting:

Recommended for delicate pastries only (i.e., whipped-cream gateaus).

- Turn the hot air selector switch to the  position. Dependent on size and type of the baked goods, defrost 25 – 45 minutes, take out of the oven and allow to stand 30 – 45 minutes.
- With smaller amounts (pastries), the defrosting time is reduced to 15 – 20 minutes and the subsequent standing time to 10 – 15 minutes.

Standard defrosting of various foods:

Shelf positions:

With 1 baking tray: shelf position **3**

With 2 baking trays: shelf positions **1** and **3**

- All stated times** are approximate guidelines that vary with the shape and volume of deep-frozen products.
- Raw deep-frozen products or foods from a freezer** always defrost at 50 °C. Higher defrosting temperatures may cause the food to dry out.
- Defrost **deep-frozen meals packed in aluminium foil or closed aluminium containers** at a setting of 130 – 140 °C.
- Place deep-frozen meals **packed in plastic bags or plastic containers** in a pot filled with water. Cover the pot and defrost at a setting of 130 – 140 °C.
Attention: Pot handles must be oven-proof.
- Defrost and warm **deep-frozen baked goods** at 100 – 140 °C. Brush bread, rolls or yeast pastry lightly with water to give a better crust.
- Defrost **dry deep-frozen yeast cakes** at 160 – 170 °C for 20 – 30 minutes.
- Defrost **moist deep-frozen yeast cakes** (with fruit topping) at 160 – 170 °C for 30 – 50 minutes after wrapping in aluminium foil to prevent cake from drying out.
- Defrost and toast **deep-frozen toast** (with topping) at 160 – 170 °C for about 20 minutes.
- Defrost and bake **deep-frozen pizzas** at 180 – 190 °C for 15–25 minutes. Place on wire grille covered with greaseproof paper. Please ensure that the greaseproof paper is suitable for use at these temperatures.

Cleaning and Care

Important cleaning basics:

- For cleaning, do not use abrasives, corrosive cleaners, aerosol cleaners or sharp objects.
- Do not scratch off burnt-on food residues, but soak off them with a damp cloth and washing up liquid.
- Oven cleaners must not be used on aluminium or plastic parts.

Stainless steel front:

- When using commercially available Stainless Steel cleaning agents, avoid cleaning any lettering, as this can become damaged!
- Do not use any scouring pads or abrasive cleaners.
- Use commercially available detergents applied with a soft, moistened cloth or a chamois.

Enamel and glass:

- Use hot detergent suds for cleaning.
- Remove the oven door before cleaning the enamel surface.

Oven interior:

- Clean the oven after each use, especially after roasting or grilling. Food remnants burn in when the oven is reheated.
The baked in remnants are very difficult to remove once burnt in.
- You can reduce the degree of soiling by greater use of the circotherm.

 Do not clean the warm oven with any of the cleaning products specifically designed for this purpose.



- When baking very moist cake (e.g. rich fruit cake) that could drip over the top of the tin, place on the roasting pan or your own baking sheet.
- When roasting, ensure that the meat juices do not splash on to the base of the oven.
- Clean the oven before soiling becomes too heavy. Wash out the oven cavity with hot detergent suds. Leave the door open until the interior has dried.

Cleaning function:

- The Cleaning function is a regeneration programme. If the self-cleaning parts in the oven are no longer adequately cleaned, this function regenerates them. They will then be fully functional again.
- Take the accessories and utensils out of the oven.

 Surfaces in the oven which are not self-cleaning must be cleaned manually beforehand. Otherwise, stains will form which will be impossible to remove.

Setting procedure:

- Set function selector to hot air 
Mini oven: Set function selector to conventional  (top and bottom heat).
- Set temperature selector to "clean".
- Press the  button until the symbol flashes.
- Set 1.00 h with the + button.

The setting is accepted after several seconds. The oven switches off after one hour.

Mini oven: Switch off the function selector.

When the oven has cooled down:

- Wipe salt residue off the self-cleaning parts with a damp cloth.

 The surface becomes very hot when the cleaning function starts. Always keep children out of the way.

Cleaning and Care

Manual cleaning steps:

Note: To make cleaning more convenient, the oven offers you the following options:

Removing the oven door:

1. Fully open the oven door.
2. Move the catch levers on the right and left-hand sides to the fully open position.
3. Placing the door at an upward angle toward you, grasp the door with both hands and lift it out of the hinges toward you.

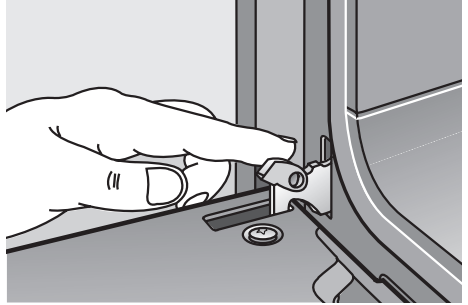

Hanging the oven door:

1. Set both hinges into their respective receptacles on the left and right, and swing the oven door downward.
2. Close the catch levers on the left and right.
3. Close the oven door.

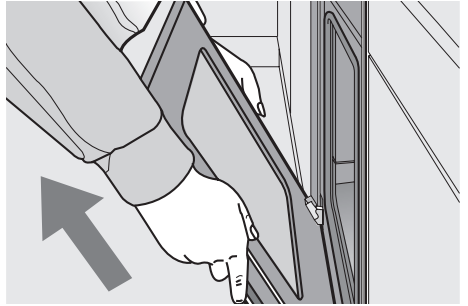

Switching on the oven light

Main and Mini oven:

- Set the function selector to a random position.

Removing the shelf railings

Mini oven:

1. On both left and right sides, remove two milled screws each.
2. Carefully remove the shelf railings.

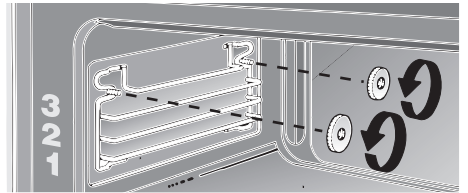

Main oven:

1. On both left and right sides, remove the one milled screws.
2. Carefully remove the suspended grids.

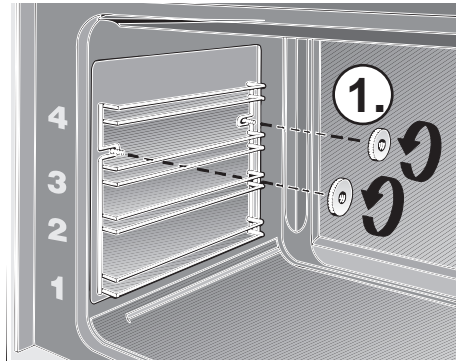

Service and Repair Information

In the event of problems or repairs that you cannot solve or perform yourself, our service company will be happy to help. Check the service directory for the service facility in your area.

You can find this information on the appliance's nameplate. The nameplate is located on the appliance, behind the oven door, on the left bottom edge of the oven.

Replacing the oven light:

Caution: Unplug the appliance or remove the fuse!

Mini oven:

1. To prevent damage, place a tea towel into the cold oven.
2. Remove the glass cover by inserting a knife or similar object between the glass and the frame.
3. Replace the lamp.
 - Type: Incandescent bulb E 14, 230–240 V, 25 W, heat-resistant to 300 °C.
 - You may obtain this bulb from your customer service or from your appliance dealer.

Main oven:

1. To prevent damage, place a tea towel into the cold oven.
2. Unscrew the lamp cover by turning it anti-clockwise.
3. Replace the lamp.
 - Type: Incandescent bulb E 14, 220–240 V, 40 W, heat-resistant to 300 °C.
 - You may obtain this bulb from your customer service or from your appliance dealer.

Replacing the oven door seal:

1. Remove the defective oven door seal by simply unhooking it.
You may obtain the new oven door seal from our customer service.

Caution: Calling customer service because of an operator error can be very costly! In the event of a customer service request, please have the following information handy:

E-Number	FD
----------	----

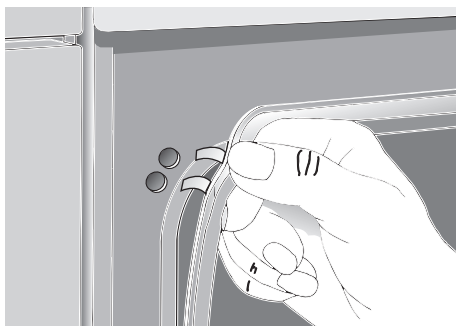
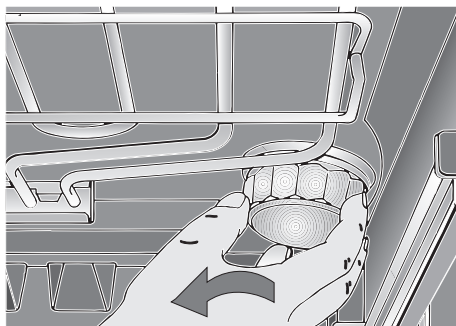
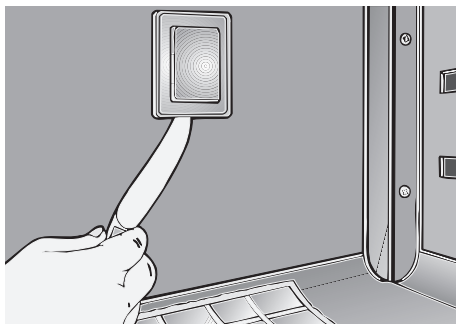

Trouble-shooting Guide

Calling the customer service is not always really necessary. In some cases, you can remedy the situation yourself. The following table may contain some helpful tips.

Important general safety guidelines:

Service or repair work on the electronic components may only be performed by a qualified expert. Without exception, prior to starting such repairs, the appliance must be disconnected from the mains. This may be accomplished by tripping the automatic fuse or by removing the fuse from the fuse box that controls your flat or apartment.

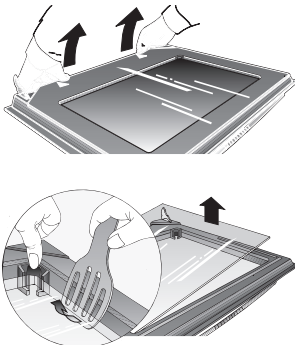
Problem	Possible cause	Remedy
There is a general failure of all electrical functions, i.e., the control lamps have suddenly ceased to function.	Defective fuse.	Check the fuse in the fuse box, and replace if required.
Liquids or thin cake mixes are distributed at a visibly uneven thickness.	The appliance has not been placed or installed plumb-and-level.	Level the appliance using the leveling feet, or check the installation.
The electronic timer display suddenly shows a blinking 0.00.	The power supply was briefly interrupted.	Reset the time of day.
The oven suddenly stop functioning.	The electronic timer is set to an automatic timing cycle.	Set the timer for operation without automatic timing.
The oven door window pane fogs up.	This is a normal condition. It is caused by the occurrence of temperature differences.	Heat the oven at 100 °C for about 5 minutes.
A considerable amount of water condensation occurs in the oven.	This condition is normal with moist cakes or with very large roasts.	During baking or roasting, open the oven briefly several times; wipe up condensation after use.
... if electronically controlled functions fail?	Energy pulses (e.g. lightning flash).	Reset the relevant functions.
... if after prolonged use, the oven window panes are soiled from the inside.	<p>This kind of soiling is normal.</p> 	<p>Remove the oven door and lay front side down on a soft, clean base.</p> <p>Grip the door glass near the hinges, pull up and remove.</p> <p>Doors with 3 panels: Disengage inner door glass at the corner pieces and lift it up using, for example, a pair of frying tongs made of plastic or wood.</p> <p>Installing the cleaned glass: Insert the inner door glass and lock into position. Attach the door glass and lock into position by pressing the glass near the hinges.</p>

For the installer and kitchen expert!

Important installation notes:

- Properly dispose of **packaging materials**.
- Do not use **oven door handle** for transporting or handling the unit during installation.
- WARNING:** Connection and first start of the appliance may only be performed by an authorised specialist.
- Connection must be made using an H05VV-F mains connection cable.
- Rated consumption, rated voltage and type no. of the appliance:**
See appliance nameplate behind the oven door to the left beneath the side edge of the oven.
- The unit's nameplate is located at on the right sidewall of the unit.**
- Electrical safety** of the appliance can be ensured only if the equipment earth in the building installation has been installed according to regulations.
- On the installation side a separating device shall be provided.
Any switch with a contact gap exceeding 3 mm may be considered a separating device.
Other examples are LS switches, fuses and contactors.
- In the case of repairs** interrupt all power connections to the unit.
- The connection diagram** is located on the rear panel of the appliance.

Furniture programmes

Cooker conversion cabinets from virtually all lines of kitchen furniture are suitable for installing the built-in oven. However, the veneers or plastic laminates on the conversion cabinets must be applied with heat-resistant cement (90 C). If plastic laminates or cement are not sufficiently heat-resistant, warping, bubbling or detachment of the finish may result.



Installation of the built-in oven

- ❑ To burn-in the insulation, heat up the oven prior to installing the unit.
- ❑ Push the built-in oven into the housing unit and align the unit until it is in a **level position**.
- ❑ Open the oven door and, using one screw on each side, fasten the built-in oven to the side strips of the housing unit (see illustration).
The two screws (supplied with the built-in oven) must be started slightly outward.
- ❑ Verify that the built-in oven is positioned securely and in a **level position**, and that the required installation dimensions have been maintained.
- ❑ The properly installed appliance must be covered on all sides in such a fashion that not even components with rough insulation are exposed to the touch. The cover must be removable with tools only.

