

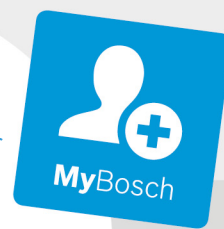

**BOSCH**



**Register** your  
new device on  
MyBosch now and  
get free benefits:  
**[bosch-home.com/  
welcome](https://bosch-home.com/welcome)**









# Gas hob

**PRS9A6D70A**

This cooktop is approved for use with Natural Gas and Universal LPG.  
Leave these instructions with the owner.

USER INSTRUCTIONS  
INSTALLATION INSTRUCTIONS  
MAINTENANCE INSTRUCTIONS

# Table of contents

	<b>Intended use</b> .....	<b>2</b>
	<b>Important safety information</b> .....	<b>3</b>
	What to do if you smell gas .....	4
	<b>Installation and connection</b> .....	<b>5</b>
	Statutory requirements .....	5
	Preparing to install .....	5
	Clearances .....	6
	Installation of cooktop into the kitchen bench .....	6
	Electrical connection .....	6
	Gas connection .....	7
	Converting the cooktop from Nat. Gas to Propane .....	8
	<b>Getting to know your appliance</b> .....	<b>10</b>
	Burner locations .....	10
	Controls and burners .....	10
	Residual heat indicator .....	11
	Accessories .....	11
	<b>Gas burners</b> .....	<b>12</b>
	Switching on manually .....	12
	Automatic ignition .....	12
	Safety system .....	12
	Switching off a burner .....	12
	Warnings .....	12
	<b>Settings table and tips</b> .....	<b>12</b>
	Suitable pans .....	12
	Precautions for use .....	12
	Table of cooking times .....	13
	<b>Cleaning and maintenance</b> .....	<b>16</b>
	Cleaning .....	16
	Maintenance .....	16
	<b>Trouble shooting</b> .....	<b>17</b>
	<b>Customer service</b> .....	<b>18</b>
	Warranty conditions .....	18

## Intended use

Read these instructions carefully. You will only be able to use your appliance safely and effectively when you have read them. These operating and installation instructions should be retained, and passed onto the buyer if the appliance is sold.

### Removal of transit protection

Packaging materials of the product are manufactured from recyclable materials. Do not dispose of the packaging materials together with the domestic or other wastes. Take them to the packaging material collection points designated by the local Authorities.

**The manufacturer is exempt from all responsibility if the requirements of this manual are not complied with.**

The images shown in these instructions are for guidance only.

Do not remove the appliance from its protective packaging until it is installed in the unit. Do not switch on the appliance if it is damaged in any way. Contact our Technical Assistance Service.

Before installing your new hob, ensure that it is being installed according to the installation instructions.

This appliance is not suitable for use in a marine craft, caravan or mobile home.

This appliance must only be used in well ventilated places. It must not be connected to a combustion product removal device.

This appliance is not intended for operation with an external clock timer or a remote control.

This appliance has been designed for home use only, not for commercial or professional use. This appliance is only intended for cooking purposes, not as a heating system. The warranty will only be valid if the appliance is used for the purpose for which it was designed.

This appliance is intended for use up to a maximum height of 2000 metres above sea level.

Do not use lids or hob guards for children which are not recommended by the hob manufacturer. They may cause accidents such as those due to the overheating, ignition or detachment of fragments of materials.

Additional information on products, accessories, replacement parts and services can be found at [www.bosch-home.com](http://www.bosch-home.com) and in the online shop [www.bosch-eshop.com](http://www.bosch-eshop.com)

This appliance is not intended for use by persons (including children) with reduced physical, sensory or mental capabilities, or lack of experience and knowledge, unless they have been given supervision or instruction concerning use of the appliance by a person responsible for their safety. Children should be supervised to ensure that they do not play with the appliance.

**All operations relating to installation, connection, regulation and conversion to other gas types must be performed by an authorised technician, respecting all applicable regulations, standards and the specifications of the local gas and electricity suppliers. Special attention shall be paid to ventilation regulations.**

This appliance leaves the factory set to the gas type that is indicated on the specifications plate. If this needs to be changed, please consult the assembly instructions. It is recommended you contact the Technical Assistance Service to change to another gas type.

Before installing, you need to check that local distribution conditions are compatible with the appliance's adjustment indicated on the specifications plate (gas type and pressure, power, voltage).

**Before you begin, turn off the appliance's electricity and gas supply.**

The supply cable must be attached to the unit to prevent it from touching hot parts of the oven or hob.

Appliances with electrical supply must be earthed.

Cabinets installed above the gas cooktop must have a minimum clearance of 650 mm (24").

The gas pressure regulator supplied with the appliance must be installed in line with the gas pipe. (N.G. only).

For pressure testing in excess of 3.5 kPa (1/2 psig) the appliance and its individual shutoff valve must be disconnected from the gas supply piping system.

Important. When using a very large pot, leave a gap of at least 50 mm (2") to avoid damaging any parts in bench top wood, plastic or other non-heat resistant materials. Never leave oil or hot fat unattended.

DO NOT USE IN FREEZING CONDITIONS.

## Important safety information

**DO NOT MODIFY THIS APPLIANCE.**

**DO NOT USE OR STORE FLAMMABLE MATERIALS IN THE APPLIANCE STORAGE DRAWER OR NEAR THE APPLIANCE.**

**DO NOT SPRAY AEROSOLS IN THE VICINITY OF THIS APPLIANCE WHILE IT IS IN OPERATION.**

**DO NOT USE THIS APPLIANCE AS A SPACE HEATER.**

If the information in this manual is not followed exactly, a fire or explosion may result causing property damage, personal injury or death.

### Warning – Risk of deflagration!

Accumulation of unburned gas in an enclosed area carries a risk of deflagration. Do not subject the appliance to draughts. These might blow out the burners. Carefully read the instructions and warnings on the operation of gas burners.

### Warning – Risk of poisoning!

The kitchen will become hot and humid and combustion products produced when this gas appliance is used. Make sure the kitchen is well ventilated, particularly when the hob is in operation: either keep the natural ventilation apertures open, or install a ventilation system (extractor hood). Intense prolonged use of the appliance may require additional or more effective ventilation: open a window or increase the power of the ventilation system.

### Warning – Risk of burns!

- The burners and their immediate vicinity get very hot. Never touch the hot surfaces. Keep children under 8 years old well away from this appliance.
- If the liquefied gas bottle is not upright, liquefied propane/butane can enter the appliance. Intense darting flames may therefore escape from the burners. Components may become damaged and start to leak over time so that gas escapes uncontrollably. Both can cause burns. Always use liquefied gas bottles in an upright position.
- Grids become very hot during use, take care not to make contact with the grids.

**⚠ Warning – Risk of fire!**

- The cooking process must be supervised. A short cooking process must be supervised without interruption.
- The burners get very hot. Do not rest inflammable objects on the hob. Do not store objects on the hob.
- Do not store or use corrosive chemicals, products which produce fumes, inflammable materials or non-food products below or near this domestic appliance.
- Fat or oil which is overheated can catch fire easily. Never leave fat or oil to heat up unattended. If oil or fats do catch fire, never use water to put the fire out. Put the fire out by covering the pan with a lid and switch off the hotplate.
- Operating a burner with the power set too high will result in very high temperatures being generated. This may cause flammable materials to ignite. The power setting shown in the display may differ from the power setting that has been set using the knob. The power setting is shown in the display purely for additional information. Always set the power setting according to the printing on the knob.

**⚠ Warning – Risk of injury!**

- Cracks or fractures in the glass plate are dangerous. Shut immediately off all burners and any electrical heating element. Unplug the appliance from the mains or switch off the circuit breaker in the fuse box. Shut off the gas supply. Do not touch the appliance surface. Never switch on a faulty appliance. Contact the after-sales service.
- Pans which are damaged, are not the right size, hang over the edge of the hob or are not positioned correctly can cause serious injuries. Follow the advice and warnings provided relating to the cooking pans.
- Incorrect repairs are dangerous. Repairs may only be carried out, and damaged power and gas lines replaced, by an after-sales engineer trained by us. If the appliance is faulty, unplug the mains plug or switch off the fuse in the fuse box. Shut off the gas supply. Contact the after-sales service.
- If a control knob is too stiff to turn or it is loose, it must not be used. Contact our after-sales service immediately to have the control knob repaired or replaced.

**⚠ Warning – Risk of electric shock!**

- Do not clean the appliance using steam cleaners.
- Cracks or fractures in the glass plate could cause electric shocks. Switch off the circuit breaker in the fuse box. Contact the after-sales service.

**What to do if you smell gas**

- Do not try to light the appliance.
- Do not touch any electrical switch; do not use any phone in your building.
- Immediately call your gas supplier from a neighbour's phone. Follow the gas supplier's instructions.
- If you cannot reach your gas supplier, call the fire department.

Installation and service must be performed by an authorised person.

## Installation and connection

### Statutory requirements

This installation must conform with the following:

- Manufacturer's Installation instructions
- Local Gas Fitting Regulations
- Municipal Building Codes
- Refer to AS/NZS 5601.1 for Gas Installations
- S.A.A. Wiring Code
- Local Electrical Regulations
- Any other statutory regulations

### Preparing to install

Refer to AS/NZS 5601.1 for piping size details. These built-in cooktops are intended to be inserted in a benchtop cutout.

Do not stick the cooktop onto the worktop with silicone.

Only an officially authorised technician should connect the appliance.

Before you begin, turn off the gas and electricity supply.

Before connecting the unit, check whether the local connection conditions (type of gas) are compatible with the unit's setting. Observe any special conditions imposed by local suppliers (utilities). The specifications of this cooktop are stated on the data label located on the bottom of the cooktop base.

A duplicate data label is supplied for adhesion to an accessible location near the hotplate if the data label on the base of the hotplate cannot be accessed when the hotplate is installed.

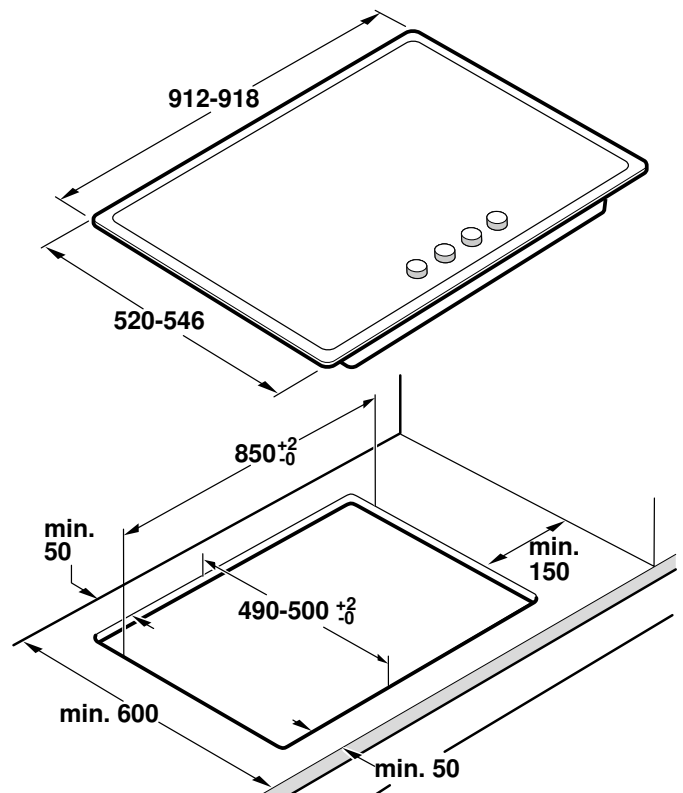
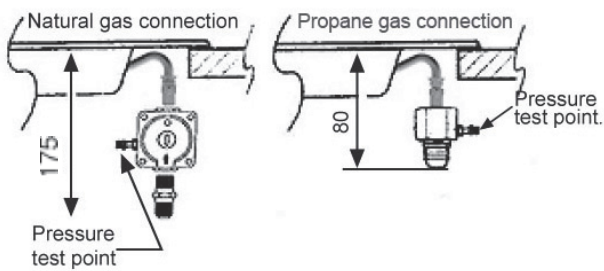

## Clearances

A range hood fitted above the top must be installed according to the installation instructions for the range hood. A minimum distance of 650 mm is required for a range hood and 750 mm for an exhaust fan.

Any adjoining wall surface situated within 200 mm from the edge of any hob burner must be a suitable non-combustible material for a height of 150 mm for the entire length of the hob. Any combustible construction above the hotplate must be at least 650 mm above the top of the burner and no construction shall be within 450 mm above the top of the burner.

Height of the pan support above the bench top surface: up to 60 mm.

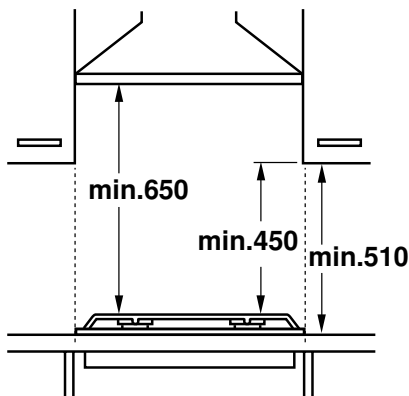

A minimum depth of 50 mm from the top of the worktop surface must be provided for the appliance.

If the base of the hotplate can be touched, a protecting shield must be fitted.

- The shield must be at least 10 mm from the lowest part of the hotplate and must be capable of withstanding the appliance temperatures. Minimum thickness of benchtop is 30 mm.
- The shield material must be mdf or similar with minimum thickness of 12 mm.
- The shield overall dimensions must be 560 mm wide x 480 mm deep.
- Provide cut-out in right hand rear of shield of 80 mm wide x 80 mm deep to provide for gas regulator / LP connection fitting.

After installation of the shield the clearance around the top and sides of shield will allow adequate ventilation. Ensure the side and top clearances are not obstructed.

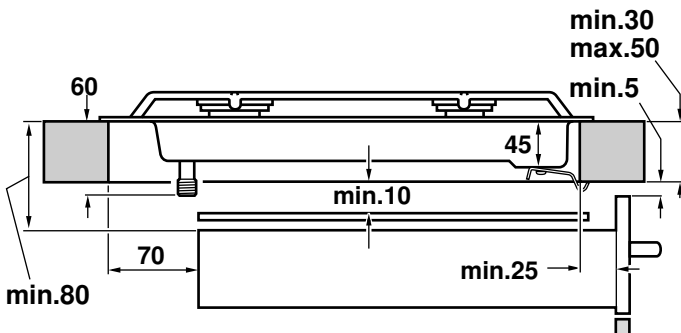

If an oven is positioned below the cooktop the barrier does not need to be fitted, but a space of 35 mm must be maintained between the underside of the cooktop and the top of the oven.

## Installation of cooktop into the kitchen bench

Side clearances: If the distance measured from the periphery of the nearest burner to any vertical surface is less than 200 mm, the surface shall be protected in accordance with clauses 6.10.1.2 of AS/NZS 5601.1.

Make an appropriate size cut in the work surface.

Seal all work surfaces made of wood with special sealer/glue to protect it against moisture damage.

**Note:** Wear protective gloves to fit the hob.

The clips and adhesive seal (underside of the hob) are factory-fitted: Do not remove these under any circumstances: The adhesive seal prevents water seepage.

Securing the appliance to the fitted unit:

1. Turn the hob into the correct position.
2. Loosen the screws on the brackets so they can turn freely. You do not need to fully undo the screws on the brackets.
3. Insert the appliance evenly into the cut-out.
4. Turn the brackets and tightly screw them in. The screws for the brackets must be vertical to the base of the housing.  
The position of the brackets depends on the worktop thickness.

Do not stick the hob onto the worktop with silicone.

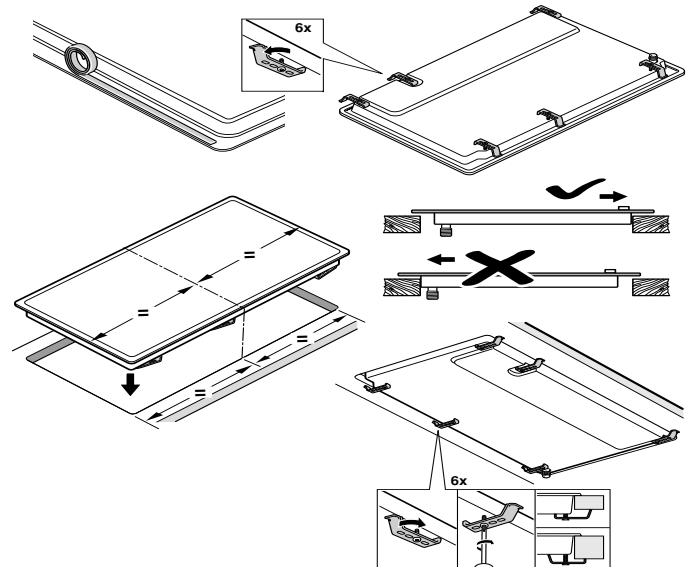

## Electrical connection

An electrical 10 amp socket needs to be within 1 m of the hotplate to allow electrical connection. The socket must remain accessible after installation of the appliance.

Important notes:

- This appliance is connected to the mains (240 VAC) by means of the connecting lead which must be fixed to the kitchen unit to prevent it from coming into contact with hot parts of the cooktop (or an oven installed underneath) and remain accessible after installation of the cooktop.

When making this connection make sure that the lead cannot come into contact with hot parts of the cooktop.

- This appliance must be earthed. When connecting the cooktop ensure that the earth wire is connected first and that all wires are connected to the correct terminals.

220V - 240V ~

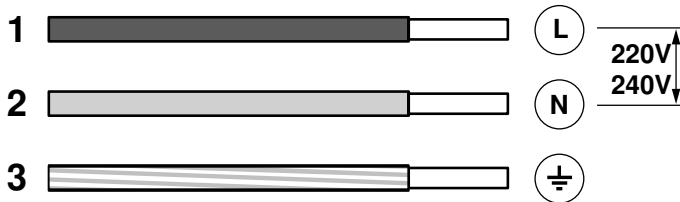

**Wiring diagram**

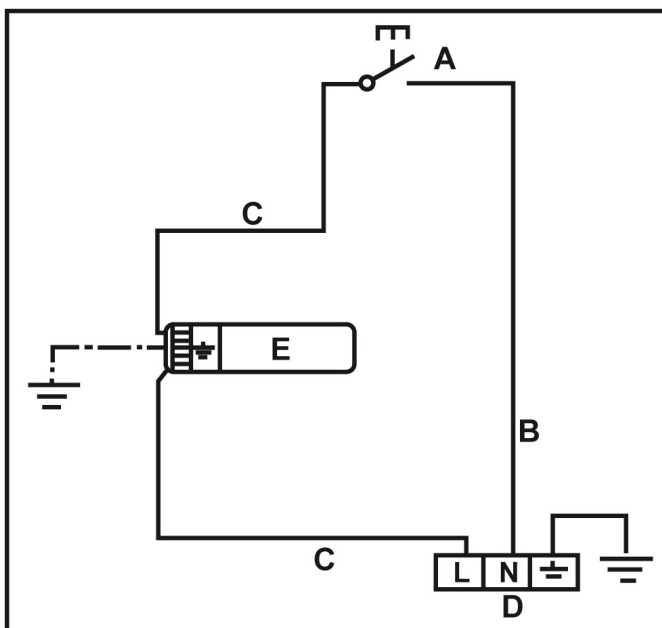

- A** Switch
- B** Blue wire
- C** Brown wire
- D** Terminal
- E** Ignition module

**Gas connection**

During the planning stage, consider the position of supply connections.

The cooktop must be connected to the gas supply with upstream connection of an isolation valve in accordance with the respectively valid regulations. We recommend that the isolation valve be fitted prior to the cooktop to enable isolation of cooktop from gas supply. The valve must be easily accessible at all times.

To find out the factory set gas type, see bottom of cooktop next to gas connection.

Remove plastic cap from gas supply line prior to installation.

Fit regulator (N.G.) or a test point (Propane) directly to the R 1/2" connection.

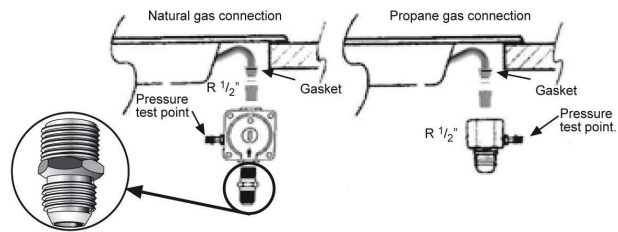

Direction of gas flow is indicated on the rear of the regulator.

Position of the inlet connection:

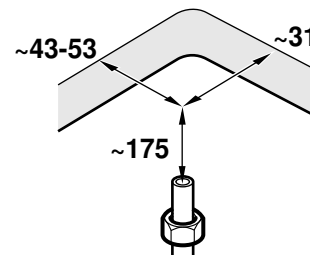

Use pipe compound or thread sealant, properly threaded pipes and careful assembly procedure so that there is no cross threading, etc., which might cause damage or leakage.

Make sure that all connections performed are free of leakage. The manufacturer does not accept any liability for leakage on connections performed by the installer or if the L-tube is moved or twisted.

There are two ways to carry out the connection to the main gas line:

- The hotplate can be connected with rigid pipe as specified in AS/NZS 5601.1
- Flexible Hose: If installing with a hose assembly, it must comply with AS/NZS 1869, 10 mm ID, class B or D, no more than 1.2 m long and installed in accordance with AS/NZS 5601.1. Ensure that the hose does not contact the hot surfaces of the hotplate, oven, dishwasher or any other appliance that may be installed underneath or next to the hotplate. The hose should not be subjected to abrasion, kinking or permanent deformation and should be able to be inspected along its entire length with the cooktop in the installed position. Unions compatible with the hose fittings must be used and all connections tested for gas leaks.

The supply connection point shall be accessible with the appliance installed.

**WARNING:** Ensure that the hose assembly is restrained from accidental contact with the flue outlet of an underbench oven.

### Before Leaving

Check all connections for gas leaks with soap and water. DO NOT use a naked flame for detecting leaks. Ignite all burners both individually and concurrently to ensure correct operation of gas valves, burners and ignition. Turn gas taps to low flame position and observe stability of the flame for each burner individually and all together. Adhere the duplicate data plate to an accessible location near the hotplate. When satisfied with the hotplate, please instruct the user on the correct method of operation. In case the appliance fails to operate correctly after all checks have been carried out, refer to the authorised service provider in your area.

It should be expressly noted that we cannot accept any liability for direct or indirect damage caused by wrong connection, leakage or improper installation. When being repaired, the appliance must always be disconnected from the mains supply; if required, notify our customer service.

### Converting the cooktop from Nat. Gas to Propane

All work involved in installation, setting and adaptation to a different gas type must be carried out by a licensed gas fitter and must comply with current regulations and the conditions laid down by the local gas company.

Before conversion the cooktop must be disconnected from the electricity and gas valves must be turned to the OFF position.

**Important:** After finishing, stick the sticker, indicating the new gas type, close to the specifications plate.

### Replacing the injectors

Request change-over injectors from our customer service department (refer injector chart below for sizes).

	Natural Gas		Propane	
	Hourly Gas Consumption (MJ)	Injector mark	Hourly Gas Consumption (MJ)	Injector mark
Economy burner	4,8	97	3,5	53
Standard-output burner	8.1	130	6	70
High-output burner	11.6	157	8.5	83
Wok burner (inner)	22	65	20	47
Wok burner (outer)		215		115
Distance Z	11		11	

### Replacing the nozzles of high-output, standard-output and economy burners

1. Remove the pan supports, burner caps and diffusers.
2. Change the nozzles using the spanner (code 424699) provided by our Technical Assistance Service, taking special care to ensure that the nozzle does not fall when it is removed from or fitted to the burner. Ensure that it is completely tightened in order to guarantee the seal.

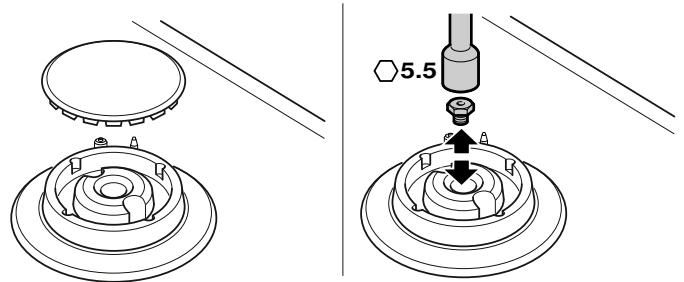

Primary air adjustment is not necessary with these burners.

### Replacing the nozzles on dual-flame burners

Before you can replace the nozzles, you will need to remove the glass plate with the cut-out profiles for the appliance. The glass plate with the cut-out profiles is connected to the rest of the hob by means of a clip system.

### Removing the glass plate with the cut-out profiles:

1. Remove all wire racks, burner caps, burner rings, control elements and burner cups.
2. Undo the screws on the burners.

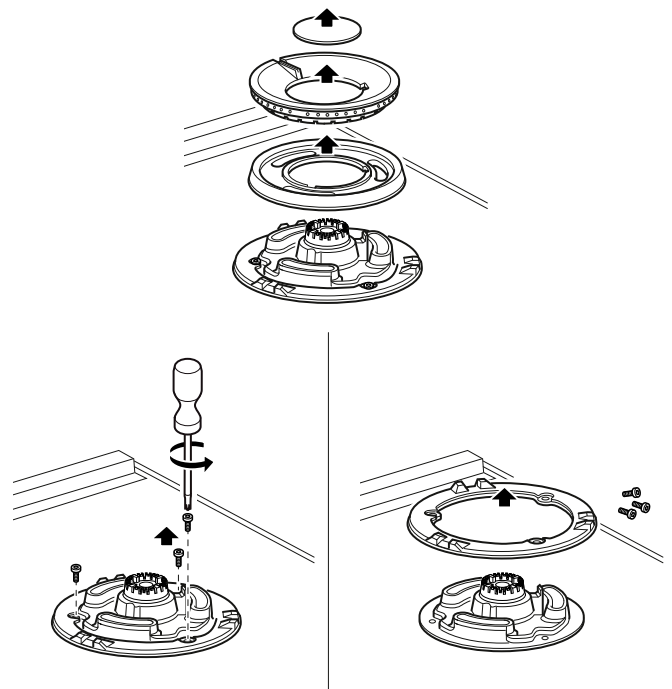

3. To do this, use the removal lever, which is available from our after-sales service (code 483196). Use the lever to release the front clip fastener at the point shown in figure, depending on the hob model.



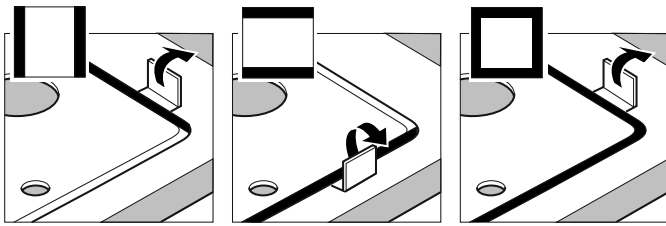

**Caution!**

Only use the lever on the edges of the glass that have a cut-out profile or a frame.

- Carefully lift the glass plate with the cut-out profiles to release the rear clip fastener.

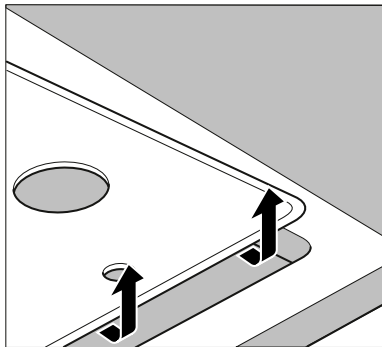

**Replacing the outer flame nozzle (fig. 9a):**

- Undo the fastening screw L1 and pull the sleeve L2 back to provide easy access to the main nozzle (fig. a1).
- Turn the outer flame nozzle anti-clockwise to remove it (fig. a2-a3).
- Screw in the new outer flame nozzle (fig. a3-a4). See table I.
- Set the spacing of the adjustment sleeve for the air supply L2 to dimension Z, as shown in the table (fig. a5).
- Tighten the fastening screw L1 (fig. a6).

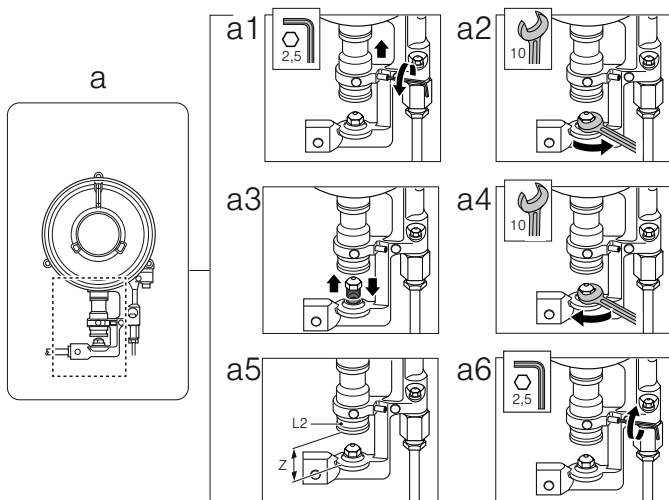

**Replacing the inner flame nozzle (fig. 9b):**

- Unscrew part M3 from part M2, which is threaded. To do this, counterhold the threaded part (fig. b1).
- Remove the sleeve from part M2 (fig. b2).
- Remove unit M2-M4 from part M1 (fig. b3-b4).
- Remove the inner flame nozzle M4 from part M2 (fig b5-b6).

- Screw in the new inner flame nozzle properly (fig. b6-b7). See table.

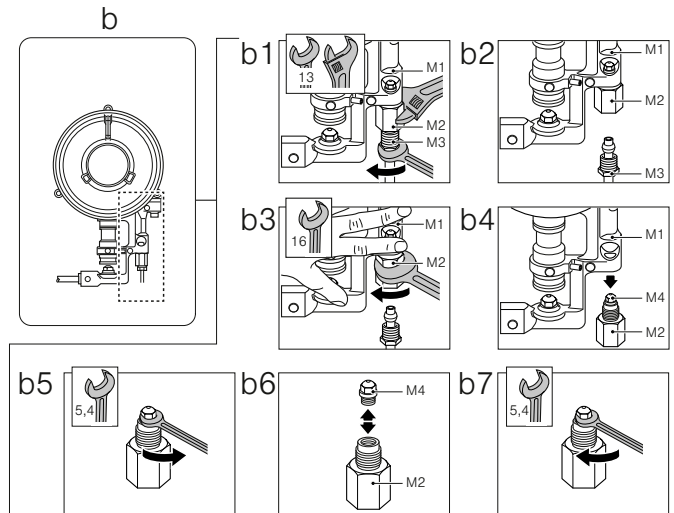

**Installing the appliance**

To fit the components, work backwards through the instructions for removing them.

**Adjusting the gas valves**

The gas hob cover and the plug-in board must be removed before you can adjust the gas valves.

**Removing the cover**

Remove the glass plate with the cut-out profiles as described in the section entitled *Removing the glass plate with the cut-out profiles*.

**Removing the plug-in board**

The plug-in board is secured to the holder by fastening pins at the sides and in the middle. Carefully press on the plug-in board without damaging it. If one of the pins breaks, the entire holder must be replaced.

Proceed as follows:

- Release the pins on one side.
- Release the middle pins. To do this, press down on either side with your fingers.
- Release the pins on the other side and remove the plug-in board.

**Caution!**

Handle the plug-in board with care. Use anti-static protection, or handle the plug-in board by its edges. Never touch the surfaces with components or tracks.

- Remove the cylindrical parts and springs from the gas valve stem.

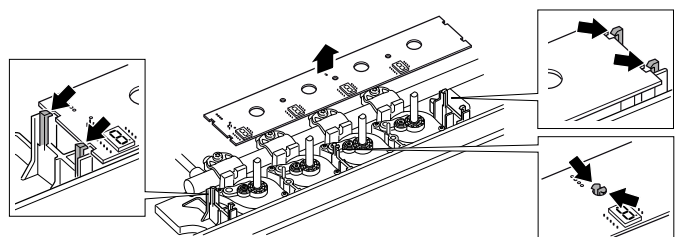

**Adjusting the bypass**

If necessary, use a Torx screwdriver to adjust the bypass screws (M):

- A:** For Propane the bypass screws must be tightened properly.

**B:** For Natural Gas the bypass screws must finish flush with the fitting.

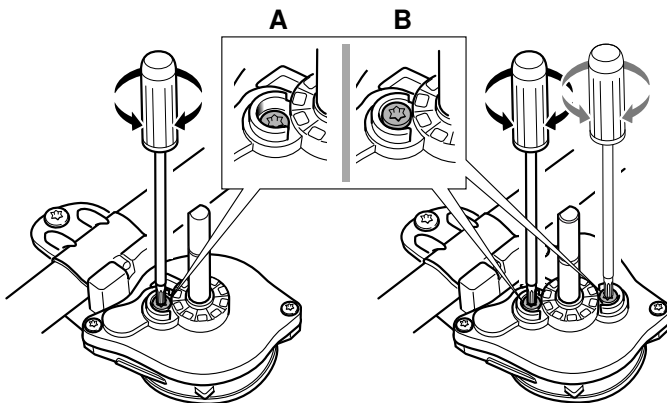

Make sure that the flame does not go out and that there are no flashbacks when you turn the control knob between the highest and lowest setting.

Fitting the plug-in board and cover:

Work backwards through the instructions for removing the plug-in board and cover.

Calibrating the electronics

As soon as the new appliance has been installed, calibrate the electronics in accordance with the figure.

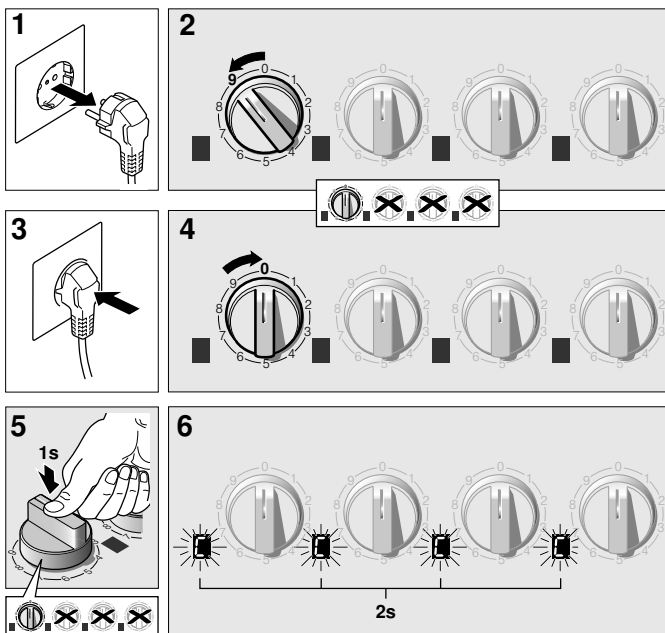

Never remove the gas valve shaft. In the event of damage, the gas valve must be completely replaced.

## Getting to know your appliance

### Burner locations

PRS9A6D70A

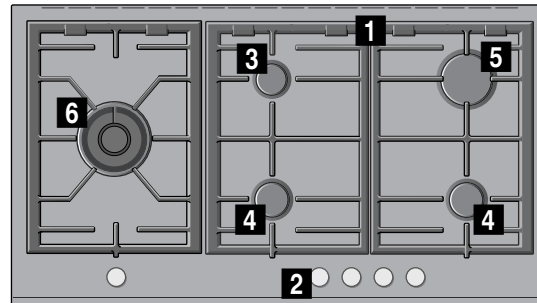

- 1** Pan supports
- 2** Control knobs
- 3** Economy burner with an output of up to 1.1 kW
- 4** Standard-output burner with an output of up to 1.9 kW
- 5** High-output burner with an output of up to 2.8 kW
- 6** Dual-wok burner with an output of up to 6.1 kW

### Controls and burners

Each control knob is marked with the burner it controls. You can use the control knobs to set the output required in each case to various positions between the maximum and the minimum settings. Never try to switch directly from position 0 to position 1 or from position 1 to position 0.

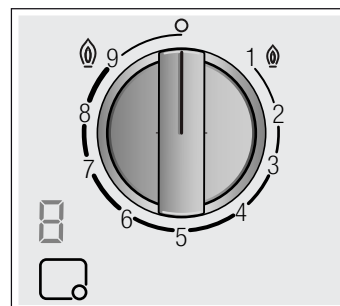

#### Indicators

	Burner controlled by control knob
	Switched-off burner
	Highest power setting and electric ignition
	Lowest power setting

#### Displays

	Electric ignition
	Heat settings
	Switched-off burner
	Residual heat

For dual-wok burners, the inner and outer flames can be controlled separately. The available power levels are as follows:

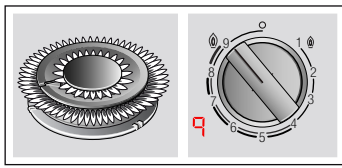

Inner and outer flame on full power.

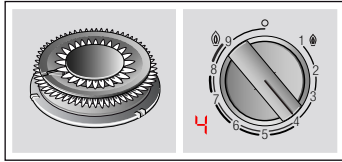

Outer flame on low power, inner flame on full power.

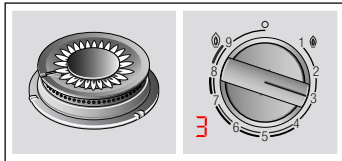

Inner flame on full power.

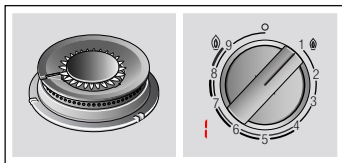

Inner flame on low power.

It is essential to ensure that all the burner parts and pan supports are correctly installed for the appliance to work correctly. Do not swap the burner caps around.

Always remove the pan supports carefully. When moving a pan support, the pan supports next to it may also move.

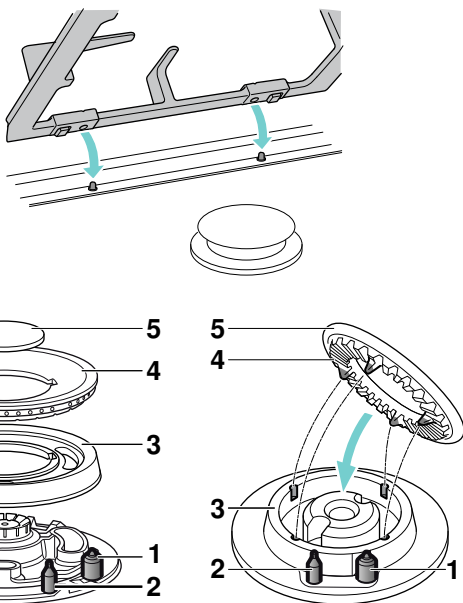

#### Burner parts

1	Ignition plug
2	Thermocouple
3	Burner ring
4	Burner cup
5	Burner cap

## Residual heat indicator

Every burner on the hob has a residual heat indicator that indicates whether it is hot or warm.

If **H** appears in the display the burner is still hot. As the burner cools down further, the display changes to **h**. The display remains lit until the burner has cooled sufficiently. Do not touch the respective burner if this indicator is lit.

## Accessories

Depending on the model, the hob may include the following accessories. These can also be acquired from the Technical Assistance Service.

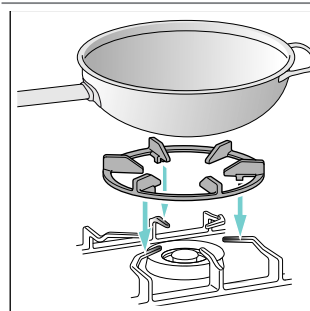

#### Additional wok grid

Only suitable for use on wok burners. Use cookware with a rounded base.

To extend the service life of the appliance, we recommend using the additional wok grid.

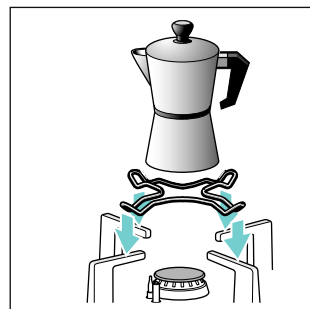

#### Additional espresso maker grid

Only suitable for use on the smallest burner. Use cookware with a diameter of less than 12 cm.

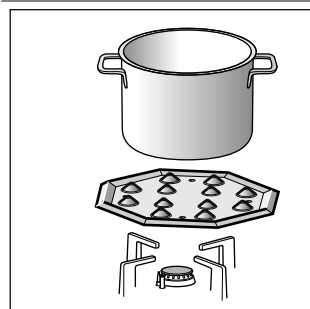

#### Simmer plate

This accessory part is only suitable for simmering. It can be used with the economy burner or the standard-output burner. If your hob has several standard-output burners, we recommend placing the simmer plate on the rear or front-right standard-output burner.

Place the accessory component with the projections facing upwards on the holder; never place it directly on the burner.

#### Code

HEZ298114 Additional espresso maker grid

HEZ298105 Simmer Plate

The manufacturer accepts no liability if these accessories are not used or are used incorrectly.

## Gas burners

### Switching on manually

1. Press the control knob for the selected burner and turn it anticlockwise to the highest power setting.
2. Hold an igniter or a naked flame (such as a lighter or a match) against the burner.

### Automatic ignition

If the hob has automatic ignition (ignition plugs):

1. Press the control knob for the selected burner and turn it anticlockwise to the highest power level. While the control knob is held down, all the burners will generate sparks and the  symbol will appear on the display. The flame ignites. Wait a few seconds.
2. Release the control knob.
3. Turn the control knob to the required position.

If the burner does not ignite, switch it off and repeat the steps described above. This time, hold the control knob down for longer (up to 10 seconds).

#### Warning – Risk of deflagration!

If the flame does not ignite after 10 seconds, switch off the burner and open a window or the door to the room. Wait at least one minute before switching the burner on again.

**Note:** It is important to keep the appliance clean. If the ignition plugs are dirty, this may cause ignition problems. Clean the ignition plugs regularly with a small, non-metallic brush. Take care to prevent the ignition plugs from suffering any heavy knocks.

### Safety system

Your hob is equipped with a safety system (thermocouple) that cuts off the gas when the burners are accidentally switched off.

To ensure that this device is active:

1. Switch on the burner as usual.
2. Without releasing the control knob, press and hold it down firmly for 4 seconds after lighting the flame.

### Switching off a burner

Turn the control knob clockwise to position 0. The  symbol will appear in the display and the residual heat indicator will appear after a few seconds.

A few seconds after the burner is switched off, a sound (thud) will be produced. This is not a fault - this means that the safety device is no longer operating.

### Warnings

It is normal to hear a soft whistling noise while the burner is operating.

When first used, it is normal for the burner to give off odours. This does not pose any risk and does not indicate a malfunction. They will disappear in time.

An orange-coloured flame is normal. This is caused by the presence of dust in the atmosphere, spilt liquids, etc.

In the event of the burner flames being accidentally extinguished, turn off the burner control and do not attempt to re-ignite the burner for at least one minute.

## Settings table and tips

### Suitable pans

Burner	Minimum diameter of the cookware base	Maximum diameter of the cookware base
Wok burner	22 cm	30 cm
High-output burner	20 cm	26 cm
Standard-output burner	14 cm	22 cm
Economy burner	12 cm	16 cm

The cookware must not overhang the edge of the hob.

You should only use cookware with a domed base if your cooktop features a wok burner and the additional wok grid. The additional wok grid must be correctly positioned.

### Precautions for use

The following advice is intended to help you save energy and prevent pan damage:

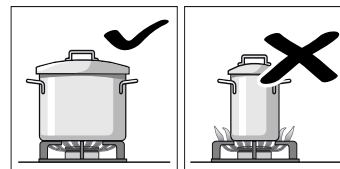

Use pans which are the right size for each burner. Do not use small pans on large burners. The flame must not touch the sides of the pan.

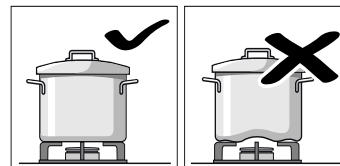

Do not use damaged pans, which do not sit evenly on the hob. Pans may tip over. Only use pans with a thick, flat base.

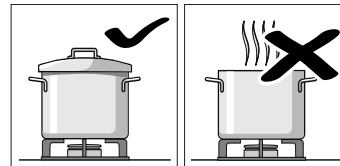

Do not cook without using a lid and make sure the lid is properly fitted. This wastes energy.

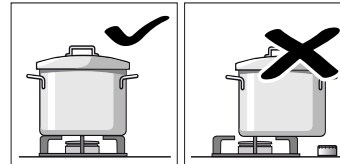

Always centre the pan over the burner, not to one side. Otherwise it could tip over. Do not place large pans on the burners near the control knobs. These may be damaged by the very high temperatures.

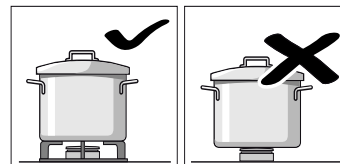

Place the pans on the pan supports, never directly on the burner. Make sure that the pan supports and burner caps are correctly positioned before using the appliance.

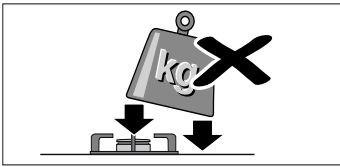

Pans should be placed on the hob carefully. Do not strike the hob and do not place excessive weight on it.



Do not place anything, eg. flame tamer, asbestos mat, between pan and pan support as serious damage to the appliance may result.



Do not remove the pan support and enclose the burner with a wok stand as this will concentrate and deflect heat onto the hotplate.



Do not use large pots or heavy weights which can bend the pan support or deflect flame onto the hotplate.

### Table of cooking times

The table below lists the optimal heat settings and cooking times for various types of food. The information given applies when cooking four portions.

The cooking times and heat settings may vary depending on the type of food, its weight and quality, on the type of gas used, and on the material from which the cookware is made. To prepare this dish, stainless steel cookware was mainly used.

Always use cookware that is the right size and place it in the centre of the burner. You can find information about the diameter of the cookware under → "Suitable pans"

### Information on the table

Each type of food can be prepared in one or two steps. Each step contains information about the following:

- Cooking method
- Heat setting
- Cooking time in minutes

### Cooking methods featured in the table

- Bringing to the boil
- Continuing cooking
- Building up pressure in the pressure cooker
- Maintaining pressure in the pressure cooker
- Frying on high heat
- Frying gently
- Melting, liquefying
- \* Without lid
- \*\* Stirring constantly

**Note:** The symbols do not appear on the appliance. They are used here to represent the various cooking methods.

Information on how to cook food on the different burners is displayed. We recommend using the first

burner that was mentioned. The model overview describes all of the burners on the hob.

Example:

Meal Burner	Total time in min.	Step 1			Step 2		
<b>Soups, creamy soups</b>							
Fish soup							
High-output burner	12-17		8	7-9		1	5-8
Standard-output burner	17-22		8	11-13		1	6-9
Wok burner	10-15		9	4-6		4	6-9

This example shows the preparation of fish soup using the high-output burner, the standard-output burner and the wok burner.

When using the high-output burner (recommended option), the total cooking time is between 12 and 17 minutes.

- Step 1: Bring to the boil. Set heat setting 8 for 7-9 minutes.
- Step 2: Continue boiling. Switch to heat setting 1 for 5-8 minutes.

This information also applies for the other suggested burners.



















Meal Burner	Total time in min.	Step 1			Step 2		
<b>Soups, creamy soups</b>							
Fish soup							
High-output burner	12-17		8	7-9		1	5-8
Standard-output burner	17-22		8	11-13		1	6-9
Wok burner	10-15		9	4-6		4	6-9
Cream of pumpkin, borscht							
High-output burner	30-35		9	10-12		5	20-23
Standard-output burner	45-50		9	15-17		6	30-33
Wok burner	25-30		9	7-9		4	18-21
Minestrone (vegetable soup)							
High-output burner	47-52		9	10-12		5	37-40
Standard-output burner	57-62		9	10-12		6	47-50
Wok burner	45-50		7	8-10		4	37-40

### Pasta and rice















Spaghetti							
High-output burner	18-22	*	9	8-10		6	10-12

Meal Burner	Total time in min.	Step 1			Step 2		
Standard-output burner	20-24	*	9	10-12		7	10-12
Wok burner	18-22	*	8	8-10		6	10-12
<b>Rice</b>							
High-output burner	17-22		9	5-7		2	12-15
Standard-output burner	18-23		9	7-9		6	11-14
Wok burner	13-18		8	4-6		4	9-12
<b>Ravioli</b>							
High-output burner	9-14		9	4-6		6	5-8
Standard-output burner	17-22		8	12-14		8	5-8
Wok burner	10-15		8	4-6		8	6-9
<b>Vegetables and pulses</b>							
<b>Boiled potatoes (mashed, potato salad)</b>							
High-output burner	23-28		9	8-10		5	15-18
Standard-output burner	25-30		9	10-12		6	15-18
Wok burner	25-30		7	11-13		5	14-17
<b>Hummus (puréed chickpeas)</b>							
High-output burner	50-55		9	10-12		4	40-43
Standard-output burner	52-57		9	12-14		5	40-43
Wok burner	47-52		7	10-12		5	37-40
<b>Mountain lentils</b>							
High-output burner	40-45		9	8-10		8	32-35
Standard-output burner	50-55		9	18-20		6	32-35
Wok burner	45-50		9	7-9		4	38-41
<b>Vegetables in tempura batter</b>							
High-output burner	12-17	*	7	6-8	*	6	6-9
Standard-output burner	15-20	*	8	8-10	*	7	7-10
Wok burner	10-15	*	7	5-7	*	5	5-8
<b>Sautéed fresh vegetables**</b>							
Wok burner	5-7	*	9	5-7			
High-output burner	6-8	*	9	6-8			
<b>Chips</b>							
Wok burner	12-17	*	7	12-17			
High-output burner	15-20	*	9	15-20			





Meal Burner	Total time in min.	Step 1			Step 2		
Standard-output burner	25-30	*	9	25-30			
<b>Eggs</b>							
<b>Shakshuka, menemen</b>							
Standard-output burner	15-20		9	10-12		4	5-8
High-output burner	13-18		8	7-9		3	6-9
Wok burner	15-20		6	11-13		4	4-7
<b>Omelette (1 portion)</b>							
Standard-output burner	3-5	*	8	3-5			
High-output burner	2-4	*	9	2-4			
Wok burner	2-4	*	5	2-4			
<b>Spanish tortilla</b>							
High-output burner	25-30	*	9	25-30			
Wok burner	18-23	*	7	18-23			
<b>Sauces</b>							
<b>Béchamel sauce**</b>							
Economy burner	10-15	*	6	2-4	*	6	8-11
Standard-output burner	10-15	*	5	2-4	*	5	8-11
Wok burner	3-8	*	5	1-2	*	5	2-6
<b>Blue cheese sauce**</b>							
Economy burner	4-6	*	7	4-6			
Standard-output burner	3-5	*	7	3-5			
High-output burner	3-5	*	5	3-5			
<b>Napoli sauce</b>							
Standard-output burner	18-23	*	6	2-4	*	4	16-19
High-output burner	15-20	*	8	1-3	*	6	14-17
Wok burner	12-17	*	7	2-4	*	5	10-13
<b>Carbonara sauce</b>							
Standard-output burner	10-15	*	6	5-7	*	3	5-8
High-output burner	8-13	*	5	4-6	*	3	4-7
Economy burner	10-15	*	9	5-7	*	5	5-8
<b>Fish</b>							
<b>Breaded hake</b>							
High-output burner	5-10	*	8	5-10			











































Meal Burner	Total time in min.	Step 1			Step 2		
							
Standard-output burner	8-13	 *	9	8-13			
Wok burner	4-9	 *	9	1-3	 *	4	3-6
<b>Baked salmon</b>							
High-output burner	5-10	 *	7	2-4		1	3-6
Standard-output burner	5-10	 *	8	2-4		1	3-6
Wok burner	7-12	 *	6	2-4		1	5-8
<b>Mussels</b>							
High-output burner	5-7		9	5-7			
Wok burner	4-6		9	4-6			
Standard-output burner	10-12		9	10-12			













**Meat**

<b>Duck breast (1 portion)</b>							
Standard-output burner	6-8	 *	7	6-8			
High-output burner	9-11	 *	7	9-11			
Wok burner	6-8	 *	5	6-8			
<b>Fillet of beef Stroganoff</b>							
High-output burner	8-13	 *	9	8-13			
Wok burner	5-10	 *	7	5-10			
Standard-output burner	12-17	 *	9	12-17			
<b>Chicken escalope (8 chicken breast fillets)</b>							
High-output burner	7-12	 *	9	2-4	 *	6	5-8
Wok burner	7-12	 *	9	2-4	 *	5	5-8
Standard-output burner	7-12	 *	9	7-12			
<b>Minced meat</b>							
High-output burner	15-20	 *	8	15-20			
Standard-output burner	20-25	 *	9	20-25			
Wok burner	15-20	 *	6	15-20			

**Convenience products**

Frozen croquettes (16 pcs)		Frozen fish fingers (12 pcs)	
High-output burner	6-10		8 6-10
Standard-output burner	8-12		8 8-12
Wok burner	6-10		9 3-5  4 3-5

Meal Burner	Total time in min.	Step 1			Step 2		
							
<b>Small sausages (12 pcs)</b>							
High-output burner	5-10		9	1-3		7	4-7
Standard-output burner	7-12		9	7-12			
Wok burner	5-10		9	1-3		5	4-7
<b>Boiled sausages (12 pcs)</b>							
Standard-output burner	8-13		9	8-13			
Wok burner	9-14		4	9-14			
High-output burner	7-12		7	7-12			
<b>Beefburger (4 pcs., 1 cm thick, 110 g)</b>							
High-output burner	4-9	 *	9	1-3	 *	7	3-6
Wok burner	4-9	 *	7	1-3	 *	6	3-6
Standard-output burner	5-10	 *	9	1-3	 *	8	4-7
<b>Heat baked beans and keep them warm (use the simmer plate)</b>							
Standard-output burner	20-22		6	5-7		1	15
<b>Pizza (20 cm)</b>							
Wok burner	4-8		4	4-8			
High-output burner	16-20		1	16-20			
Standard-output burner	20-25		1	20-25			
<b>Desserts</b>							
<b>Rice pudding in accordance with DIN 3360-12* (use the simmer plate)</b>							
Standard-output burner	62-67		8	27-32		2	35
<b>Rice pudding**</b>							
Standard-output burner	30-35	 *	8	9-11	 *	4	21-24
Economy burner	40-45	 *	9	12-14	 *	2	28-31
Wok burner	23-28	 *	6	8-10	 *	4	15-18
<b>Melt chocolate in accordance with EN 60350-2 (use the simmer plate)</b>							
Economy burner	34-38	 *	1	34-38			
Standard-output burner	20-24	 *	1	20-24			
<b>Pancakes (8 pcs)</b>							
Standard-output burner	17-22	 *	8	3-5	 *	5	50 s/ side
High-output burner	20-25	 *	6	4-6	 *	4	60 s/ side
<b>Bread pudding (in the bain marie)</b>							
High-output burner	25-30		9	10-12		6	15-18
Wok burner	23-28		9	8-10		7	15-18

Meal Burner	Total time in min.	Step 1		Step 2			
							
Standard-output burner	27-32		9	10-12		7	17-20
Custard**							
High-output burner	3-8	 *	5	3-8			
Standard-output burner	8-13	 *	5	8-13			
Wok burner	3-8	 *	3	3-8			
Sponge (in the bain marie)							
High-output burner	35-40		9	35-40			
Wok burner	40-45		9	40-45			
Standard-output burner	45-50		9	45-50			

### Cooking tips

- Use a pressure cooker to cook creamy soups and pulses. This significantly reduces the cooking time. If you are using a pressure cooker, follow the manufacturer's instructions. Add all of the ingredients at the start.
- Always use a lid when cooking potatoes and rice. This significantly reduces the cooking time. The water must be boiling before you add pasta, rice or potatoes. Then adjust the heat setting to continue boiling.
- For pan-cooked dishes, heat the oil up first. As soon as you have started the frying, keep the pan at a constant temperature by adjusting the heating setting as required. When preparing several portions, wait until the relevant temperature has been reached again. Turn the food regularly.
- When cooking soups, cream, lentils or chickpeas, add all of the ingredients to the cookware at the same time.

## Cleaning and maintenance

### Cleaning

Once the appliance is cool, use a sponge to clean it with soap and water.

After each use, clean the surface of the respective burner parts once they have cooled down. If any residue is left (baked-on food, drops of grease etc.), however little, it will become stuck to the surface and more difficult to remove later. The holes and grooves must be clean for the flame to ignite properly.

The movement of some pans may leave metal residue on the pan supports.

Clean the burners and pan supports using soapy water and scrub with a non-wire brush.

Alternatively, the pan supports can be put in the dishwasher. Use the dishwasher manufacturer's recommended detergent. If the pan supports are very dirty, they should be cleaned previously.

Do not put the burner caps in the dishwasher.

If the pan supports are fitted with rubber rests, ensure that these are also cleaned. The rests may come loose and the pan support may scratch the hob.

Always dry the burners and pan supports completely. Water droplets or damp patches on the hob at the start of cooking may damage the enamel.

After cleaning and drying the burners, make sure the burner caps are correctly positioned on the diffuser.

### Caution!

- Do not remove the control knobs when cleaning the appliance. The appliance may be damaged if moisture finds its way inside.
- Do not use steam cleaners. This could damage the hob.
- Never use abrasive products, steel scourers, sharp implements, knives, etc. to remove bits of hardened food from the hob.
- Do not use knives, scrapers or similar implements to clean the point where the glass meets the burner trims, the metal frames or the glass/aluminium panels, if fitted.
- Do not put the burner components in the dishwasher.

### Maintenance

Always clean off any liquid as soon as it is spilt. This will prevent food remains from sticking to the hob surface and you will save yourself any unnecessary effort.

Never slide pans across the glass surface, as you may scratch it. In addition, try not to drop heavy or sharp objects on the glass. Never strike any part of the hob.

Grains of sand that may come from cleaning fruits and vegetables will scratch the glass surface.

Melted sugar, or foods which contain a lot of sugar which may have spilt, should be cleaned off the hob immediately, using the glass scraper.



## Trouble shooting

DO NOT MODIFY THIS APPLIANCE.

Only authorized personnel from the Service Centre are qualified to work on the appliance.

Sometimes certain faults detected can be easily resolved. Before calling the Technical Assistance Service, bear in mind the following advice:

Fault	Possible cause	Remedial action
Electrical operation is generally impaired.	Defective circuit breaker.	Check inside the fuse box to see if any of the fuses are damaged. Replace if necessary.
	The circuit breaker or one of the residual-current circuit breakers has been triggered.	Check the control panel to see if the automatic circuit breaker or a fault current switch has failed.
Automatic ignition is not working.	There may be remnants of food or cleaning agent residues trapped between the ignition plugs and the burners.	The spaces in between the ignition plugs and the burners must be clean.
	The burners are wet.	Carefully dry the burner caps.
	The burner caps have not been fitted correctly.	Make sure that the caps have been fitted correctly.
	The appliance is not earthed or has not been connected correctly, or the earth cable is damaged.	Contact an electrician.
Automatic ignition is not working and the <b>F1</b> or <b>F2</b> symbol appears in the display.	The electronics have overheated.	Switch the burners off or use only the lowest heat setting until the electronics have cooled down sufficiently.
The burner flame is uneven.	The burner parts have not been fitted correctly.	Fit the burner parts to the relative burner correctly.
	The burner slots are dirty.	Clean the burner slots.
The gas does not appear to be flowing correctly or there is no gas being produced at all.	The gas supply has been shut off by the intermediate valves.	Open the intermediate valves.
	If gas is supplied by a gas cylinder, check that this is not empty.	Replace the gas cylinder.
There is a smell of gas in the kitchen.	The gas tap is open.	Close the gas tap.
	The gas cylinder has not been connected correctly.	Make sure that the gas cylinder has been connected correctly.
	Gas may be leaking.	Close the central tap in the gas line, ventilate the room and immediately call an authorised installer, who can inspect the gas system and issue an installation certificate. Do not use the appliance until you are sure that gas is not leaking from the system or the appliance.
The burner switches off as soon as the control knob is released.	The control knob was not held down for long enough.	If the burner is switched on, hold the control knob down for a few seconds longer.
	The burner slots are dirty.	Clean the burner slots.
<b>F3, F4, F5, F6, F7, F8, F9</b> appear in the display.	Electronics fault.	Disconnect the hob from the power supply. Wait a few seconds and then reconnect it. If the indicator remains lit, contact the after-sales service.
The heat setting indicator in the display continually deviates from the heat setting that was selected using the control knob.	Incorrect calibration of the electronics.	Carry out the calibration in accordance with the installation instructions.

Any of the following are considered to be abnormal operation and may require servicing:

- Yellow tipping of the cooktop burner flame.
- Sooting up of cooking utensils.
- Burners not lighting properly.

Gas valves, which are difficult to turn in case the appliance fails to operate correctly, contact the authorised service provider in your area.



## Customer service

---

When contacting our customer service, please provide the product number (E-Nr.) and production number (FD) of the appliance. This information is given on the specifications plate located on the lower section of the hob and on the label in the user manual.

After-sales contact details for all countries can be found in the attached after-sales service directory.

### Warranty conditions

In the unlikely event that the appliance is damaged or does not meet your expectations in terms of quality, please inform us as soon as possible. For the warranty to be valid, the appliance must not have been tampered with, or used inappropriately.

The applicable warranty conditions are those set out by the company's representative office in the country of purchase. Detailed information is available from retail outlets. Proof of purchase must be presented to obtain the benefits of the warranty.

We reserve the right to introduce changes.





## Thank you for buying a Bosch Home Appliance!

Register your new device on MyBosch now and profit directly from:

- **Expert tips & tricks for your appliance**
- **Warranty extension options**
- **Discounts for accessories & spare-parts**
- **Digital manual and all appliance data at hand**
- **Easy access to Bosch Home Appliances Service**

Free and easy registration – also on mobile phones:

[www.bosch-home.com/welcome](http://www.bosch-home.com/welcome)

**BOSCH**  
HOME APPLIANCES  
**SERVICE**

## Looking for help? You'll find it here.

Expert advice for your Bosch home appliances, help with problems or a repair from Bosch experts.

Find out everything about the many ways Bosch can support you:

[www.bosch-home.com/service](http://www.bosch-home.com/service)

Contact data of all countries are listed in the attached service directory.

### **BSH Hausgeräte GmbH**

Carl-Wery-Straße 34  
81739 München, GERMANY  
[www.bosch-home.com](http://www.bosch-home.com)

A Bosch Company



**9001607376** (021104)

en