



Register your new Bosch now:
www.bosch-home.com/welcome



Washing machine



BOSCH

en Instruction Manual and Installation Instructions

Your new washing machine

You have chosen a Bosch washing machine.

Please take a few minutes to read and become familiar with the advantages of your washing machine.

To meet the high quality demands required by Bosch, every washing machine that leaves our factory is carefully checked to ensure that it functions correctly and is in perfect condition.

For more information on our products, accessories, replacement parts and services, see our website www.bosch-home.com or contact our after-sales service centres.

If the operating and installation instructions describe different models, any differences will be pointed out at the relevant points in the text.



Read these operating and installation instructions before switching on the washing machine.

Display rules

Warning!

This combination of symbol and signal word indicates a possibly dangerous situation. Not heeding the warning can cause death or injuries.

Caution!

This signal word indicates a possibly dangerous situation. Not heeding the caution can cause property and/or environmental damage.

Note/tip

Information about the optimum use of the appliance/any other useful information.

1. 2. 3. / a) b) c)

The steps are represented by numbers or letters.

■ / -

Lists are represented by a small box or a dash.

Contents

 Intended use	4	Dyeing/bleaching	22
 Safety instructions	4	Soaking	22
Children/people/pets	4	 Detergent	22
Installation	6	Correct selection of detergent	22
Operation	8	Saving energy and detergent	23
Cleaning/Maintenance	9	 Programme default settings	23
 Environmental protection	11	°C Temperature	23
Packaging/used appliance	11	⊖ Spin speed	23
Tips on economical use	11	⌚ Ready in	24
 Positioning and connecting	11	 Additional programme settings 24	
Included with the appliance	11	⬆ Water Plus	24
Installation	12	🪦 Rinse Plus	24
Secure installation	12	 Operating the appliance	24
Installation surface	12	Preparing the washing machine	25
Installation on a base or a wooden joist floor	12	Select programme/switch on the appliance	25
Installing the appliance in a kitchenette	12	Change the programme default settings	25
Removing the transport locks	13	Select additional programme settings	25
Hose and cable lengths	13	Placing laundry into the drum	25
Water connection	14	Measure and add detergent and care products	26
Water inlet	14	Start the programme	27
Water outlet	15	Childproof lock	27
Levelling	16	Adding laundry	28
Electrical connection	16	Changing the programme	28
Before washing for the first time	17	Cancel the programme	28
Transportation	17	Programme end during ---- Rinse Stop	28
 Main points in brief	18	Programme end	28
 Getting to know the appliance 19		Removing laundry/switching off the appliance	28
Washing machine	19	 Sensors	29
Control panel	20	Automatic load sensing	29
Display panel	20	Unbalanced load detection system	29
 Laundry	21	 Cleaning and maintenance	29
Prepare the laundry	21	Machine housing/control panel	29
Sorting laundry	21	Drum	29
Starching	22		

Descaling. 30
Detergent drawer and housing 30
Detergent solution pump blocked . . 30
The drain hose at the siphon
is blocked 31
Filter in the water supply blocked . . 31

 **Faults and what
to do about them. 32**
Emergency release 32
Information on the display panel . . . 33
Faults and what to do about them. . 33

 **After-sales service 35**

 **Technical data. 35**

 **Intended use**

- This appliance is intended for private domestic use only.
- Do not install or operate this appliance anywhere that is liable to experience frost and/or outdoor conditions. There is a risk that the appliance will be damaged if residual water in it freezes. If hoses freeze up, they may crack/burst.
- This appliance must only be used for washing domestic laundry, consisting of machine-washable items and hand-washable woollens (see label on item). Using the appliance for any other purpose is outside of the scope of its intended application and is forbidden.
- This appliance is suitable for operation with mains water and commercially available detergents and care products (must be suitable for use in washing machines).
- This appliance is intended for use up to a maximum height of 4000 metres above sea level.

Before you switch on the appliance:

Check that there is no visible damage to the appliance. Do not operate the appliance if it is damaged. Should you have any problems, please contact your specialist dealer or our customer service.

Read and follow the operating and installation instructions and all other information provided with this appliance.

Retain the documents for subsequent use or for subsequent owners.

 **Safety instructions**

The following safety information and warnings are provided to protect you from injury and to prevent material damage to your surroundings.

It is nevertheless important to take the necessary precautions and to proceed with care when installing, maintaining, cleaning and operating the appliance.

Children/people/pets

 **Warning
Risk of death!**

Children and other people who are unable to assess the risks involved when using the appliance may injure themselves or may find themselves in life-threatening situations. Therefore please note:

- The appliance may be used by children over the age of 8 years and by persons with reduced physical, sensory or mental capacity or by persons with a lack of experience or knowledge as long as they are supervised or have received instruction on how to use the appliance safely and they have understood the potential risks of using the appliance.
- Children must not play with this appliance.
- Do not allow children to clean or maintain this appliance unsupervised.
- Keep children under 3 years and pets away from this appliance.
- Do not leave the appliance unattended when children or other people who are unable to assess the risks are in the vicinity.

 Warning
Risk of death!

Children may lock themselves inside appliances and find themselves in a life-threatening situation.

- Do not position the appliance behind a door, as this may obstruct the appliance door or prevent it from opening completely.

- Once an appliance has reached the end of its life, pull the mains plug from the socket **before** severing the mains cable, and then destroy the lock on the appliance door.

 Warning
Risk of suffocation!

If allowed to play with the packaging/plastic film or packing components, children may become caught in these or pull them over their heads and suffocate.

Keep packaging, plastic film and packing components away from children.

 Warning
Risk of poisoning!

Detergents and care products may result in poisoning if consumed.

If accidentally swallowed, seek medical advice. Keep detergents and care products out of the reach of children.

 Warning
Risk of burns!

When washing at high temperatures, the glass in the appliance door becomes hot. Stop children from touching the appliance door when it is hot.

⚠ Warning

Eye/skin irritation!

Contact with detergents or care products may cause eye/skin irritation.

Rinse eyes/skin thoroughly if they/it come(s) into contact with detergents or care products. Keep detergents and care products out of the reach of children.

Installation

⚠ Warning

**Risk of electric shock/fire/
material damage/damage to
the appliance!**

If the appliance is not installed properly, this may lead to a dangerous situation. Ensure the following:

- The mains voltage on your power socket must match the rated voltage specified on the appliance (identification plate). The connected loads and the required fuse protection are specified on the identification plate.
- The appliance must only be connected to alternating voltage via a protective contact socket that has been correctly installed. This plug socket must be freely accessible at all times.

- The mains plug and the protective contact socket must match and the earthing system must be correctly installed.
- The installation must have an adequate cross section.
- The mains plug must be freely accessible at all times. If this is not possible, in order to comply with the relevant safety regulations, a switch (2-pole switch-off) must be built into the permanent installation in accordance with electrical installation regulations.
- If using a residual current circuit breaker, only use one that bears the following mark: . The presence of this mark is the only way to be sure that it fulfils all the applicable regulations.

⚠ Warning

**Risk of electric shock/fire/
material damage/damage to
the appliance!**

If the appliance's mains cable is altered or damaged, this may result in electric shock, short circuiting or fire due to overheating.

The mains cable must not be kinked, crushed or altered, and must not come into contact with any heat sources.

⚠ Warning**Risk of fire/material damage/
damage to the appliance!**

The use of extension cords or power strips may result in fire due to overheating or short circuiting.

Connect the appliance directly to an earthed socket that has been correctly installed. Do not use extension cords, power strips or multi-way couplers.

⚠ Warning**Risk of injury/material
damage/damage to the
appliance!**

- The appliance may vibrate or move when in operation, potentially resulting in injury or material damage. Place the appliance on a clean, even, solid surface and, using a spirit level to guide you, level it with the screw-in feet.
- If you take hold of any of the appliance's protruding parts (e.g. the appliance door) in order to lift or move it, these parts may break off and cause injury. Do not take hold of any of the appliance's protruding parts in order to move the appliance.

⚠ Warning**Risk of injury!**

- The appliance is very heavy. Lifting it may result in injury. Do not lift the appliance on your own.
- The appliance has sharp edges on which you could cut your hands. Do not take hold of the appliance by its sharp edges. Wear protective gloves to lift it.
- If the hoses and mains cables are not correctly routed, they may constitute a tripping hazard, which may result in injury. Route hoses and cables such that they do not constitute a tripping hazard.

Caution!**Material damage/damage to
the appliance**

- If the water pressure is too high or too low, the appliance may not be able to operate properly, and it may also result in material damage or damage to the appliance. Make sure that the water pressure in the water supply facility is at least 100 kPa (1 bar), and does not exceed 1000 kPa (10 bar).

- If the water hoses are altered or damaged, this may result in material damage or damage to the appliance. The water hoses must not be kinked, crushed, altered or severed.
- The use of hoses supplied by other brands to connect to the water supply may result in material damage or damage to the appliance. Use the hoses supplied with the appliance or genuine spare part hoses only.
- The appliance is secured for transportation by transport locking devices. If the transport locking devices are not removed before the appliance is operated, this may result in damage to the appliance.
It is important to completely remove all transport locking devices before using the appliance for the first time. Make sure that you retain these transport locking devices separately. It is important to refit the transport locking devices if the appliance is to be transported, in order to prevent the appliance from being damaged in transit.

Operation

Warning

Risk of explosions/fire!

Laundry that has been pretreated with cleaning agents that contain solvents, e.g. stain remover/cleaning solvent, may cause an explosion in the drum. Rinse the laundry thoroughly with water before washing it in the machine.

Warning

Risk of poisoning!

Poisonous fumes may be given off by cleaning agents that contain solvents, e.g. cleaning solvent.

Do not use cleaning agents that contain solvents.

Warning

Risk of injury!

- If you support your weight/sit on the appliance door when it is open, the appliance may tip over, which may result in injury.

Do not support your weight on the appliance door when it is open.

- If you climb onto the appliance, the worktop may break, which may result in injury.

Do not climb onto the appliance.

- If you reach into the drum while it is still rotating, you risk injuring your hands. Wait until the drum has stopped rotating.

 **Warning**
Risk of scalding!

When washing at high temperatures, there is a risk of scalding if you come into contact with hot detergent solution (e.g. when draining hot detergent solution into a washbasin).

Do not reach into the hot detergent solution.

 **Warning**
Eye/skin irritation!

Detergent and care products may spray out if the detergent drawer is opened while the appliance is in operation. Rinse eyes/skin thoroughly if they/it come(s) into contact with detergents or care products. If accidentally swallowed, seek medical advice.

Caution!
Material damage/damage to the appliance

- If the amount of laundry in the appliance exceeds its maximum load capacity, it may not be able to operate properly, or this may result in material damage or damage to the appliance. Do not exceed the maximum load capacity of dry laundry. Make sure you comply with the maximum load capacities specified for each of the programs → Supplementary sheet for the operating and installation instructions.
- If you pour the wrong quantity of detergent or cleaning agent into the appliance, this may result in material damage or damage to the appliance. Use detergents/care products/cleaning agents and softeners in accordance with the manufacturers' instructions.

Cleaning/Maintenance

 **Warning**
Risk of death!

The appliance is powered by electricity. There is a risk of electric shock if you come into contact with live components. Therefore please note:

- Switch off the appliance. Disconnect the appliance from the power supply (pull out the plug).
- Never take hold of the mains plug with wet hands.
- When removing the mains plug from the socket, always take hold of the plug itself and never the mains cable, otherwise this may damage the mains cable.
- Do not make any technical modifications to the appliance or its features.
- Repairs and any other work on the appliance must only be conducted by our customer service or by an electrician. The same applies for replacing the mains cable (when necessary).
- Spare mains cables can be ordered from our customer service.



Warning
Risk of poisoning!

Poisonous fumes may be given off by cleaning agents that contain solvents, e.g. cleaning solvent.

Do not use cleaning agents that contain solvents.



Warning
Risk of electric shock/material damage/damage to the appliance!

If moisture penetrates the appliance, this may cause it to short circuit.

Do not use a pressure washer, steam cleaner, hose or spray gun to clean your appliance.



Warning
Risk of injury/material damage/damage to the appliance!

The use of spare parts and accessories supplied by other brands is dangerous and may result in injury, material damage or damage to the appliance. For safety reasons, use genuine spare parts and accessories only.

Caution!

Material damage/damage to the appliance

Cleaning agents and agents for pretreating laundry (e.g. stain removers, prewash sprays, etc.) may cause damage if they come into contact with the surfaces of the appliance.

Therefore please note:

- Do not allow these agents to come into contact with the surfaces of the appliance.
- Clean the appliance with nothing but water and a soft, damp cloth.
- Remove any detergent, spray or other residues immediately.



Environmental protection

Packaging/used appliance



Dispose of packaging in an environmentally friendly manner.

This appliance is designated according to European Directive 2012/19/EC, which governs waste electrical and electronic equipment (WEEE).

The directive provides a framework for the collection and recycling of old appliances, which is valid across the EU.

Tips on economical use

- Always fill the appliance with the maximum amount of laundry for each programme.
Programme overview → Supplementary sheet for the installation and operating instructions
- Wash normally soiled laundry without prewash.
- Refer to the care labels on the textiles for the selectable temperature. The temperatures in the machine may deviate from this for an optimum mix of energy-saving and washing results.
- If the laundry will be dried in a dryer, select the spin speed according to the dryer manufacturer's instructions.



Positioning and connecting

Included with the appliance

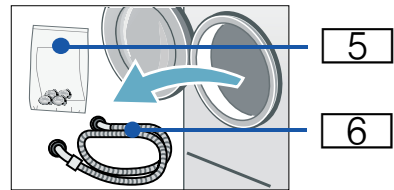
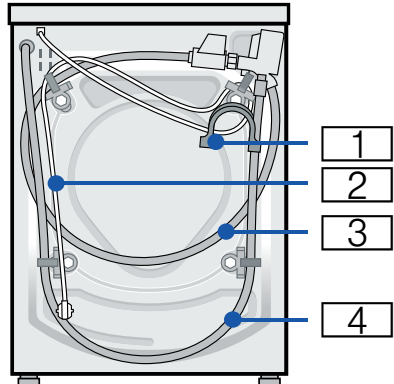

- 1** Elbow for securing the water drain hose*
 - 2** Mains cable
 - 3** Water supply hose on AquaStop/
AquaSecure models
 - 4** Water drain hose
 - 5** Bag*:
 - Installation and operating instructions
 - After-sales service location directory*
 - Warranty*
 - Cover caps for openings after the transportation safety devices have been removed
 - Spanner*
 - 6** Water supply hose on standard models
- * depending on the model

en Positioning and connecting

Notes

- Check the machine for transport damage. Never use a damaged machine. If you have any complaints, contact the retailer from whom you purchased the appliance, or our after-sales service.
- Moisture in the drum is due to the final inspection.

In addition, a hose clamp (24 – 40 mm diameter, available from specialist retailers) is required to connect the water drain hose to a siphon.

Useful tools

- Spirit level for aligning
- Wrench with:
 - WAF13 for loosening the transportation safety devices and
 - WAF17 for aligning the appliance feet

Installation

Note: Moisture in the drum is due to the final inspection.

Secure installation

Warning **Risk of injury!**

- The washing machine is very heavy. Be careful when lifting/transporting the washing machine; wear protective gloves.
- If the washing machine is lifted by protruding components (e.g. the washing machine door), the components may break off and cause injuries. Do not lift the washing machine by protruding parts.
- If the hose and mains cables are not laid properly, there is a risk of tripping and injury. Lay hoses and cables in such a way that there is no risk of tripping.

Caution!

Damage to the appliance

- Frozen hoses may crack/burst. Do not install the washing machine in areas exposed to frost and/or outdoors.

Note: If in doubt, have the appliance connected by a technician.

Installation surface

Note: The washing machine must be stable so that it does not move around.

- The installation surface must be firm and level.
- Soft floors/floor coverings are not suitable.

Installation on a base or a wooden joist floor

Caution!

Damage to the appliance

The washing machine may “wander” and tip/topple from the base during the Spin cycle.

Always secure the washing machine feet with fixing brackets.

Order no. WMZ2200, WX975600, Z7080X0

Note: On wooden joist floors, install the washing machine:

- In a corner, if possible,
- On a water-resistant wooden board (min. 30 mm thick) which is screwed tightly to the floor.

Installing the appliance in a kitchenette

Warning **Risk of death!**

There is a risk of electric shock if live components are touched.

Disconnect the appliance from the power supply.

Notes

- A recess width of 60 cm is required.
- Only install the washing machine underneath a continuous worktop that is securely connected to adjacent cabinets.

Warning**Risk of electric shock!**

If you remove the appliance covering plate for installation underneath the worktop or in a unit, you must always replace it with a metal cover*.

* Order no. WMZ2420, WZ10190

Removing the transport locks**Caution!****Damage to the appliance**

- The machine is secured for transportation using transport locks. If the transport locks are not removed, the machine may become damaged when it is operated. Before using the appliance for the first time, make sure that you completely remove all four transport locks. Keep the locks in a safe place.
- To prevent transport damage from occurring if the appliance is moved at a later date, you must refit the transport locks before transporting the appliance.

Note: Keep the screws and sleeves screwed together in a safe place.

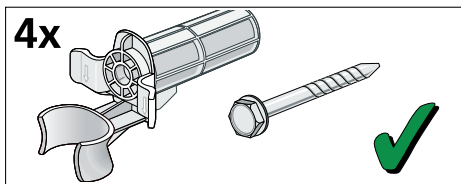

1. Take the hoses out of the holders.

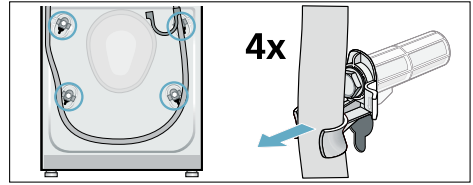

2. Remove the mains cable from the holders. Unscrew and remove all four transport lock screws. Remove the sleeves.

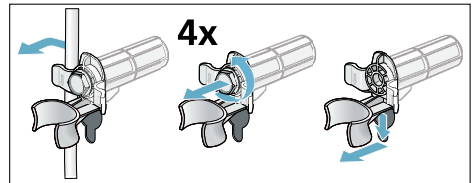

3. Fit the covers. Lock the covers firmly in place by applying pressure to the snap-in hooks.

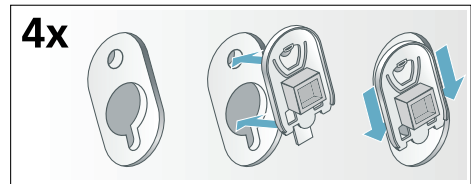
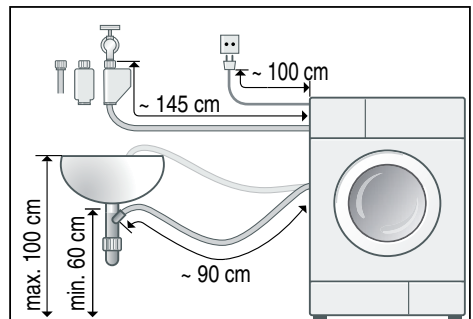
**Hose and cable lengths****Left-hand connection**

Right-hand connection

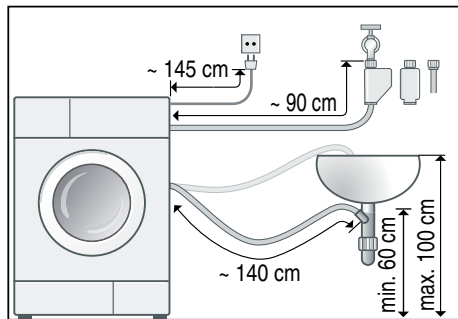

Tip:

The following are available from specialist retailers/our after-sales service:

- Extension for the AquaStop and cold water supply hose (approx. 2.50 m). Order no. WMZ2380, WZ10130, Z7070X0
- A longer supply hose (approx. 2.20 m) for standard models. Individual component number for the after-sales service: 00353925

Water connection



Warning Risk of death!

There is a risk of electric shock if live components are touched.

Do not immerse the AquaStop safety valve in water (it contains an electric valve).

Caution!

Water damage

The connection points for the water supply hose and water drain hose are under high water pressure. To prevent leaks and water damage, you must follow the instructions in this section.

Observe the following when connecting the machine:

Notes

- In addition to the information listed here, the local water and electricity supplier may have special requirements.
- Only operate the washing machine using cold mains water.
- Do not connect the washing machine to the mixer tap of an unpressurised hot-water boiler.
- Do not use a used supply hose. Only use the supply hose supplied or one that was purchased from an authorised specialist retailer.
- If in doubt, have the appliance connected by a technician.

Water inlet

Notes

- Do not bend, squash, modify or cut through the water supply hose (otherwise its strength is no longer guaranteed).
- Only tighten the screw connection by hand. If the screw connections are tightened too much with a tool (pliers), the thread may be damaged.

Optimum water pressure in the supply network

At least 100 kPa (1 bar)

Maximum 1000 kPa (10 bar)

- When the tap is open, the water flow rate is at least 8 l/min.
- If the water pressure is higher than this, a pressure-reducing valve must be installed.

Connection

Connect the water supply hose to the tap ($\frac{3}{4}$ " = 26.4 mm) and to the appliance (not necessary for AquaStop models as this is permanently installed):

■ Standard model

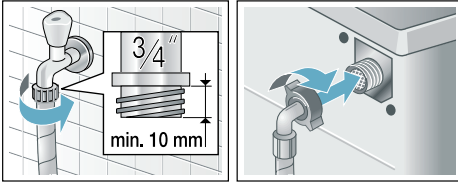

■ AquaSecure model

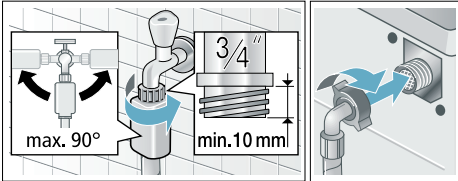

■ AquaStop model

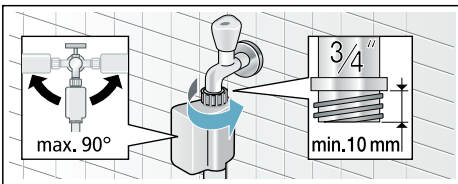

Carefully turn the tap on, and check that the connection points are not leaking.

Note: The screw connection is under mains water pressure.

Water outlet

Caution! Water damage

If the drain hose slips out of the washbasin or the connection point during draining due to high water pressure, any escaping water may cause water damage. Secure the drain hose so that it cannot slip out.

Notes

- Do not kink the water drain hose or stretch it lengthways.
- Height difference between the installation surface and the drain:
Min. 60 cm, max. 100 cm

You can lay the water outlet hose as follows:

■ Drainage into a washbasin

⚠ Warning Risk of scalding!

When washing at high temperatures, there is a risk of scalding if you come into contact with hot detergent solution (e.g. when draining hot detergent solution into a wash basin).

Do not reach into the hot detergent solution.

Caution!

Damage to the appliance/fabrics

If the end of the drain hose is immersed in the drained water, water may be sucked back into the appliance and may damage the appliance/fabrics.

Make sure that:

- The plug does not block drainage from the wash basin.
- The end of the drain hose is not immersed in the drained water.
- The water drains away quickly enough.

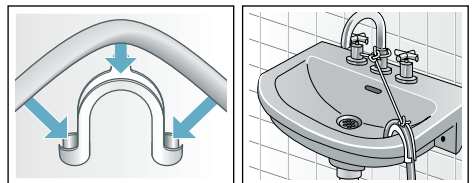

■ Drainage into a siphon

The connection point must be secured using a hose clamp with a diameter of 24 – 40 mm (available from specialist retailers).

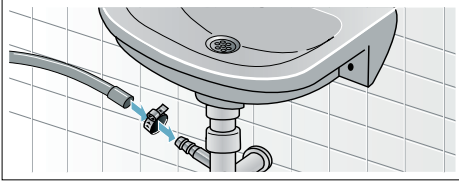

Levelling

Align the appliance using a spirit level.

Incorrect alignment may result in loud noises, vibrations and machine "movement".

1. Loosen the lock nuts using a spanner, turning it in a clockwise direction.
2. Check the alignment of the washing machine with a spirit level, and adjust it if necessary. Change the height by turning the appliance feet. All four appliance feet must stand firmly on the ground.
3. Tighten the lock nut against the housing.
In doing so, hold the foot tight and do not adjust its height.
The lock nuts on all four appliance feet must be screwed tightly against the housing.

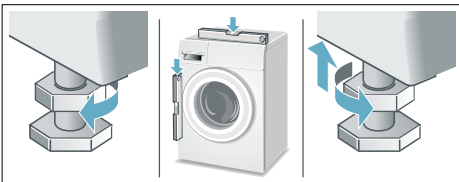

Electrical connection

⚠ Warning Risk of death!

There is a risk of electric shock if live components are touched.

- Never touch or hold the mains plug with wet hands.
- Only pull out the mains cable by the plug and never by the cable, as this could damage it.
- Never unplug the mains plug during operation.

Observe the following information and ensure that:

Notes

- The mains voltage and voltage indicated on the washing machine (rating plate) are the same. The connected load and fuse required are specified on the rating plate.
- The washing machine is only connected to an alternating current supply via a properly installed earthed socket.
- The mains plug fits the socket.
- The cable cross-section is adequate.
- The earthing system is properly installed.
- If the mains cable needs replacing, only a qualified electrician may do it. Replacement mains cables are available from the after-sales service.
- Do not use multiple plugs/couplings or extension cables.
- If an earth-leakage circuit breaker is used, only a type which displays this  symbol can be fitted. Only this symbol guarantees compliance with the currently applicable regulations.
- The mains plug can be accessed at all times.
- Do not bend, squash, modify, cut through, or bring the mains cable into contact with heat sources.

Before washing for the first time

The washing machine was thoroughly tested before leaving the factory. In order to remove any water which may be left over from the test, run the first washing cycle **without** any laundry.

Notes

- The washing machine **must be correctly installed and connected** (from → *Page 11*).
 - Never use a damaged machine. Inform the after-sales service. → *Page 35*
1. Check the washing machine.
 2. Connect the mains plug.
 3. Turn on the tap.
 4. Switch on the appliance.
 5. Close the washing machine door (do not load any laundry).
 6. Select the **Cottons 90 °C** programme.
 7. Open the detergent drawer.
 8. Pour approximately 1 litre of water into compartment **II**.
 9. Add standard detergent to compartment **II** according to manufacturer's instructions for light soiling.
- Note:** To prevent foaming, only use half the recommended amount of detergent. Do not use detergents designed for woollens or delicates.
10. Close the detergent drawer.
 11. Press the **Start button**.
 12. Switch off the appliance when the programme has finished.

Your washing machine is now ready to use.

Transportation

e.g. when moving home

Preparatory work:

1. Turn off the water tap.
2. Reduce the water pressure in the supply hose.
3. Drain the remaining detergent solution.
4. Disconnect the washing machine from the mains.
5. Remove the hoses.

Installing the transport locks:

1. Remove the covers and keep them in a safe place.
Use a screwdriver if necessary.

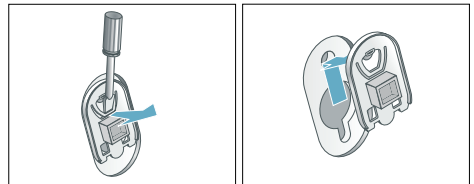

2. Insert all four sleeves.
Clip the mains cable securely in the holders. Insert and tighten the screws.

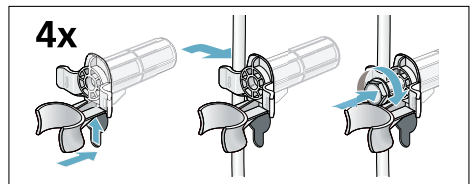







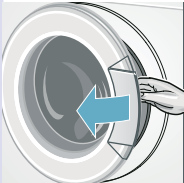
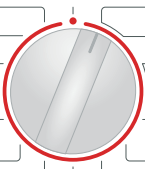

Before switching on the appliance again:

Notes

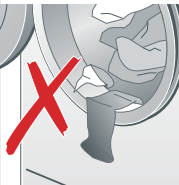
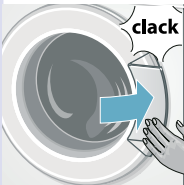
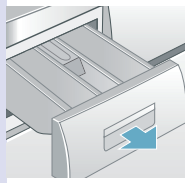
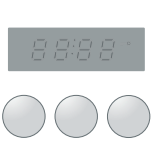
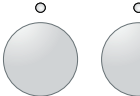
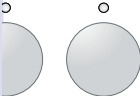
- The transport locks **must be removed**.
- To prevent unused detergent from flowing straight into the drain during the next wash: Pour approx. 1 litre of water into compartment **II** and start the **Empty** programme.

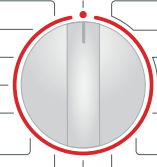
Main points in brief

1				
	Connect the mains plug.	Turn on the tap (for models without the AquaStop feature).	Sort the laundry.	Open the washing machine door.
2				
	Select a programme.	Load the laundry.	Do not trap any items of laundry.	Close the washing machine door.
3				
	Add detergent.	Change the programme default settings, if necessary.	Select additional settings, if necessary.	Start the programme.
4				
	Programme end	Open the loading door and remove the laundry.	Turn the programme selector to ●.	Turn off the tap (for models without AquaStop).

Getting to know the appliance

Washing machine

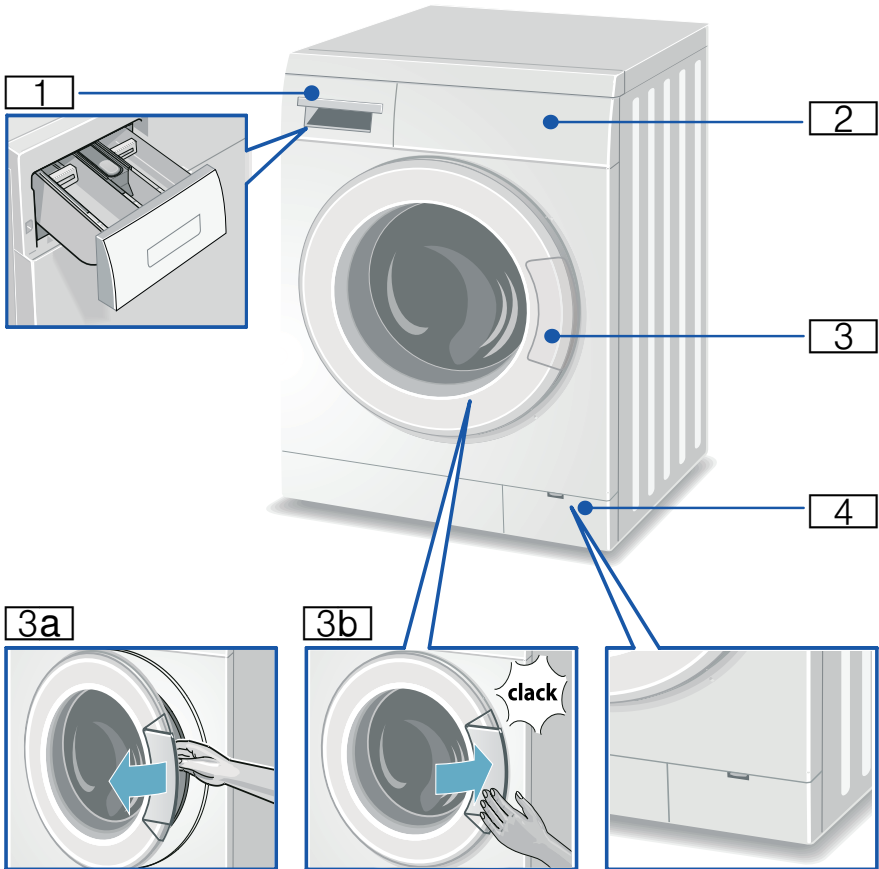

- 1** Detergent drawer → *Page 20*
- 2** Control/display panel → *Page 20*
- 3** Door with door handle
- 3a** Open the loading door
- 3b** Close the loading door
- 4** Service flap

Control panel

You can find possible programme default settings and additional programme settings in the overview; these differ depending on the model.

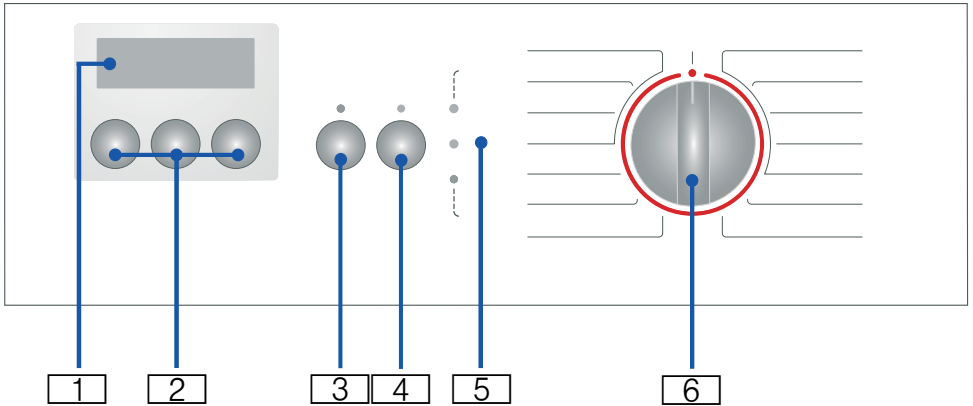

- 1** **Display panel** for settings and information
- 2** **Programme default settings** can be changed
Overview of all programme default settings
- 3** **Start button** for starting, interrupting, (e.g. adding laundry) and cancelling a programme
- 4** **additional programme settings** can be selected (depending on the model),
Overview of all additional programme settings
- 5** **Status indicators**
Programme status indicators:
→ **Ready**
⊖ **Spin**
🧺 **Rinse**
👤 **Wash/Active**
↳ **Ready**
- 6** **Programme selector** for selecting the programme and for switching the washing machine on and off

Display panel

Note: The table shows possible setting

Setting options and information for the selected programme (* depending on model)		
Cold - 90 °C	Temperature	in °C (degrees Celsius); Cold = cold
---- ...1400* ⊖	Spin speed	in rpm (revolutions per minute); ---- = Without final spin
0 : 00	programme time	Depends on the programme selection in h:min (hours:minutes)
1 - 24 h	"Ready in" time	Programme ends after ... h (h = hours)
🔒	childproof lock	→ Page 27



Laundry

Prepare the laundry

Caution!

Damage to the appliance/fabrics

Foreign objects (e.g. coins, paperclips, needles, nails) may damage the laundry or components in the washing machine.

You should therefore note the following tips when preparing your laundry:

- Empty any pockets.

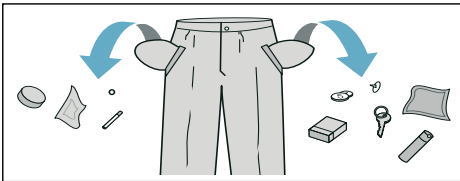

- Look out for metal items (paperclips, etc.) and remove them.
- Wash delicates in a laundry bag (tights, underwired bras, etc.).
- Close any zips; button up any cover buttons.
- Brush sand out of pockets and collars.
- Remove curtain fittings or place curtains in a laundry bag.

Sorting laundry

Sort your laundry according to the care instructions and manufacturer's information on the care labels, depending on:

- Type of fabric/fibre.
- Colour:
 - Note:** Laundry can discolour or not be cleaned correctly. Wash white and coloured items separately. Wash new coloured items separately the first time you wash them.

- Soiling:
 - Wash laundry with the same level of soiling together.
 - Examples of levels of soiling:
 - **Light:** Do not prewash; if required, select a programme for **SpeedPerfect**
 - **Normal**
 - **Heavy:** Load less laundry, select a programme with prewash
 - **Stains:** Remove/pretreat stains while they are fresh. Firstly, dab with soapy water; do not rub. Then wash the items of laundry with the appropriate programme. Stubborn or dried-in stains can sometimes only be removed by washing several times.
- Symbols on the care labels:
 - The numbers in the symbols indicate the maximum washing temperature that may be used.
 - : Suitable for a normal washing process; e.g. the Cottons programme.
 - : A gentle washing process is required; e.g. the Easy-Care programme.
 - : An especially gentle washing process is required; e.g. the Delicates/Silk programme
 - : Suitable for washing by hand; e.g. the /Wool programme.
 - : Do not wash the laundry in the machine.

Starching

Note: Laundry should not be treated with fabric softener.

Starching is possible in all wash programmes if liquid starch is used. Measure starch into compartment  in accordance with the manufacturer's instructions (clean first if necessary).

Dyeing/bleaching

Dye should only be used in normal household quantities. Salt may damage stainless steel. Always follow the dye manufacturer's instructions.

Do **not** use the washing machine to bleach clothes.

Soaking

1. Pour soaking agent/detergent into compartment **II** in accordance with the manufacturer's instructions.
2. Turn the programme selector to the **Cottons 30 °C** programme.
3. Press the **Start button** to start the programme.
4. After approx. 10 minutes, press the **Start button** again to pause the programme.
5. After the required soaking time, press the **Start button** again if the programme is to be continued or changed.

Notes

- Load laundry of the same colour.
- No additional detergent is required; the soaking solution is used for washing.

Detergent

Correct selection of detergent

The care label is crucial to ensure correct detergent selection, temperature and laundry treatment. → See also www.sartex.ch

Visit www.cleanright.eu to find further information on detergents, care products and cleaning agents for domestic use.

- **Standard detergent with optical brighteners**
Suitable for heat-resistant white laundry made from linen or cotton
Select the Cottons programme, cold – max. 90 °C.
- **Detergent for colours without bleach or optical brighteners**
Suitable for coloured laundry made from linen or cotton
Select the Cottons programme, cold – max. 60 °C.
- **Detergent for colours/delicates without optical brighteners**
Suitable for coloured laundry made from easy-care fibres or synthetic fibres
Select the Easy-Care programme, cold - max. 60 °C.
- **Detergent for delicates**
Suitable for delicate, fine fabrics, silk or viscose
Select the Delicates/Silk programme, cold – max. 40 °C.
- **Detergent for woollens**
Suitable for woollen fabrics
Select the Wool programme, cold – max. 40 °C.

Saving energy and detergent

For light and normal soiling, you can save energy (by lowering the washing temperature), and detergent.

Saving	Soiling/note
<p>Reduced temperature and detergent quantity as per the recommended dosage</p>  <p>Temperature as per the care label, and detergent quantity as per the recommended dosage for heavy soiling</p>	<p>Light No visible dirt or stains. Clothing has absorbed body odours, e.g.:</p> <ul style="list-style-type: none"> ■ Light summer/sports clothing (worn for a few hours) ■ T-shirts, shirts, blouses (worn for up to one day) ■ Guest bed linen and hand towels (used for one day)
	<p>Normal Visible dirt or a few light stains, e.g.:</p> <ul style="list-style-type: none"> ■ T-shirts, shirts, blouses (sweat-soaked, worn a few times) ■ Towels, bedding (used for up to one week)
	<p>Heavy Dirt and/or stains clearly visible, e.g. tea towels, baby items, work clothing</p>

Note: When measuring the amount of all detergents/additives/care products and cleaning agents, please always check the manufacturer's instructions and information. → *Page 27*

P+ Programme default settings

Note: You can find possible programme default settings in the overview; these differ depending on the model.

The programme default settings for all programmes are preset at the factory and are displayed in the display panel after the programme is selected.

°C Temperature

(⌘ Temp. °C)

Depending on the programme progress, you can change the preset washing temperature (in °C) before and during the programme.

Press the temperature button repeatedly until the required temperature is displayed in the display panel.

The maximum temperature that can be set depends on the programme that has been selected.

Programme overview → Supplementary sheet for the installation and operating instructions

⦿ Spin speed

(Spin, rpm, ⦿)

Depending on the programme progress, you can change the spin speed (in rpm; revolutions per minute) before and during the programme.

To do this, press the Spin Speed button repeatedly until the required spin speed is displayed in the display panel.

The maximum speed that can be selected depends on the model and programme that has been selected.

--- **Rinse Stop** setting (without final spin). The laundry remains in the water after the last rinse cycle.

You can select --- **Rinse Stop** (without final spin) to prevent creasing if the laundry is not taken out of the washing machine immediately after the programme has ended.

Programme overview →
Supplementary sheet for the installation and operating instructions

Ready in

(Finished in, , , )

The respective programme length is displayed by selecting the programme.

The length of the programme is automatically adjusted when the programme is running. Changes to the programme default settings or additional programme settings also change the programme length.

Before starting the programme, the programme end ("Ready in" time) can be preselected in increments of one hour (h = hours) up to a maximum of 24 hours.

1. Select the required programme.

Note: The programme duration is displayed in the display panel.

2. Press the **Ready in** button repeatedly until the required number of hours is displayed in the display panel.

3. Press the **Start button**.

The set "Ready in" time is now active. The selected programme starts automatically and ends after the selected number of hours.

After the programme has started, the programme duration, e.g. 2:30 (hours:minutes), is displayed in the display panel.

Note: The programme length is included in the selected "Ready in" time.

Additional programme settings

Note: You can find possible additional programme settings in the overview; these differ depending on the model.

Water Plus

( **Extra Water, Water Plus, Aqua Plus**)

Increased water level and additional rinse cycle, extended washing time. For areas with very soft water or for further enhancing the rinsing result.

Rinse Plus

( **Extra Rinse, Rinse Plus**)

Additional rinse cycle. For areas with very soft water or for further enhancing the rinsing result.

Operating the appliance

Note: Correctly install and connect the washing machine. From
→ Page 11

Before the first wash, run a wash
without any laundry. → Page 17

Preparing the washing machine

Notes

- Never switch on a damaged washing machine.
 - Inform the after-sales service.
→ Page 35
1. Connect the mains plug.
 2. Turn on the tap.
 3. Open the washing machine door.
 4. Check that the drum is completely drained. Drain if necessary.

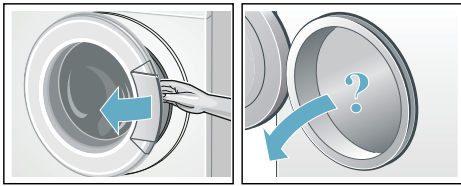

Select programme/switch on the appliance

Note: If you have activated the childproof lock, you must first deactivate it before you can set a programme. → "Childproof lock" on page 27

Use the programme selector to select the programme you require. The programme selector can be rotated in either direction.

The display alternately shows the programme length and the maximum load (when the door is open).

Change the programme default settings

You can use the displayed programme default settings or adjust them.

To do this, repeatedly press the corresponding button until the required setting is displayed. Then press the Start button to start the programme.

The settings are activated without needing to be confirmed.

They are not saved after the appliance is switched off.

Programme default settings → Page 23

Programme overview from → Supplementary sheet for the installation and operating instructions

Select additional programme settings

By selecting additional settings, you can better adapt the washing process to your items of laundry.

The settings can be selected or deselected depending on the progress of the programme.

The button indicator lamps light up if a setting is activated.

The settings are not saved when the appliance is switched off.

Additional settings → Page 24

Programme overview from → Supplementary sheet for the installation and operating instructions

Placing laundry into the drum

Warning **Risk of death!**

Items of laundry pretreated with cleaning agents that contain solvents, e.g. stain remover/cleaning solvent, may cause an explosion after being loaded into the washing machine. Hand-rinse these items of laundry thoroughly beforehand.

Notes

- Mix items of laundry of varying sizes. Laundry items of different sizes distribute themselves better during the spin cycle. Individual laundry items may cause an unbalanced load.

- Observe the maximum indicated load. Overfilling adversely affects the washing result and encourages creasing.
- 1. Unfold pre-sorted items of laundry before placing them in the washing drum.
- 2. Make sure that no items of laundry are trapped between the washing machine door and the rubber seal, and close the door.

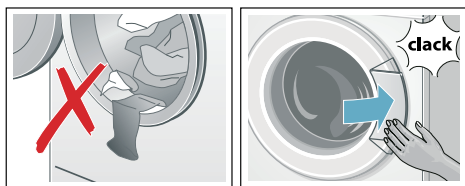

The indicator light on the Start button flashes, and the default settings for the programme appear continuously on the display panel. Changes may be made to the default settings.

Measure and add detergent and care products

Caution!

Damage to the appliance

Cleaning agents and agents for pre-treating laundry (e.g. stain removers, prewash sprays, etc.) may cause damage if they come into contact with the surfaces of the washing machine. Do not allow these agents to come into contact with the surfaces of the washing machine. If necessary, immediately wipe away spray residue and other residues/droplets with a damp cloth.

Measuring

Measure the detergents and care products according to:

- Water hardness (ask your water supply company)
- The manufacturer's instructions on the packaging
- The amount of laundry
- Soiling → *Page 23*

Filling

Warning **Eye/skin irritation!**

Detergent and care products may run out if the detergent drawer is opened while the machine is in operation. Open the drawer carefully.

Rinse eyes/skin thoroughly if they come into contact with detergents or care products.

If swallowed accidentally, seek medical advice.

Notes

- When measuring the amount of all detergents, additives, care products and cleaning agents, always follow the manufacturer's instructions.
- Dilute viscous fabric softener and fabric conditioner with a little water. This will prevent blockages.
- Pour liquid detergent into corresponding dispenser and place in the drum.

Pour the detergent and care products into the appropriate compartments:

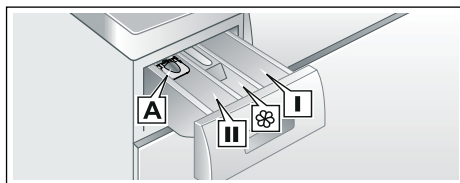

Measuring aid* A	For liquid detergent
Compartment II	Detergent for the main wash, water softener, bleach, stain remover
Dispenser ☼	Softener, starch, Do not exceed the "max" mark
Compartment I	Detergent for prewash

1. Pull out the detergent drawer as far as possible.
2. Add detergent and/or care products.
3. Close the detergent drawer.

Measuring aid* for liquid detergent

*depending on the model

For measuring the liquid detergent, position the measuring aid as follows:

1. Pull out the detergent drawer. Press down the insert and fully remove the drawer.
2. Slide the measuring aid forward, fold it down and click it into place.
3. Reinsert the drawer.

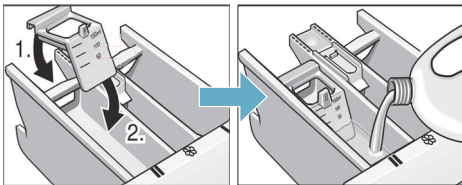

Note: Do not use the measuring aid for gel detergents and washing powder, or for programmes with prewash, or when the "Ready in" time has been selected.

For models without a measuring aid, pour the liquid detergent into the appropriate dispenser and place it in the drum.

Start the programme

Press the **Start button**. The indicator light lights up and the programme starts.

The display panel shows the Ready in time while the programme is running or the programme length once the wash cycle has started. The programme sequence lamps inform you about the progress of the programme.



→ Page 20

Note: Press the  symbol (childproof lock) to stop the programme from being inadvertently adjusted.

Childproof lock

To prevent the set functions of the washing machine from being accidentally changed, activate the childproof lock when the programme has started.

To **activate/deactivate** the childproof lock, press and hold the **Start button** for approx. five seconds. The  symbol appears on the display panel.

-  lights up: The childproof lock is active.
-  flashes: The childproof lock is active and the programme selector has been adjusted. To prevent the programme from stopping, turn the programme selector back to the original programme. The symbol lights up again.

Note: The childproof lock remains active after the program has ended and the appliance is switched off. You must always deactivate the childproof lock if you want to start a new programme.

Adding laundry

After starting the programme, you can add or remove laundry:

1. Press the **Start button** to cancel the programme.
The Start button indicator lamp flashes and the machine checks whether it is possible to add laundry.
Note: Do not leave the washing machine door open for too long when adding laundry, as water from the laundry may leak out.
2. To continue the programme, press the **Start button** again.

Changing the programme

If you have started the wrong programme by mistake, you can change it as follows:

1. Press the **Start button** to cancel the programme.
2. Select a different programme.
3. Press the **Start button** again. The new programme starts from the beginning.

Cancel the programme

1. Press the **Start button** to cancel the programme.
2. To cool the laundry: Select the **Rinse** programme.
3. Press the **Start button** again. The Rinse programme starts.

After the programme has ended, you can remove the laundry.

Programme end during - - - - Rinse Stop

The - - - - **Rinse Stop** symbol (without final spin) symbol appears in the display panel, and the Start button indicator lamp flashes.

To end the programme:

1. Select the **Spin** or **Empty** programme.
2. Press the **Start** button.

Programme end

The **End** symbol appears in the display panel, and the Start button indicator lamp flashes.

If the  **Wash/Active** indicator light also flashes, the washing machine has detected too much foam during the wash programme and automatically switches on a rinse cycle to remove the foam.

Note: Add less detergent to the next washing cycle with the same load.

Removing laundry/switching off the appliance

1. Open the washing machine door and remove the laundry.
Note: If you cannot open the washing machine door, the appliance is still locked. Wait until the programme has ended.
2. Set the programme selector to the **Off** position. The appliance is switched off.
3. Turn off the tap.
Note: Not required for AquaStop models.
Scope of delivery → *Page 11*

Notes

- Do not leave any items of laundry in the drum. They may shrink in the next wash or discolour another item.
- Remove any foreign objects from the drum and the rubber seal – risk of rusting.

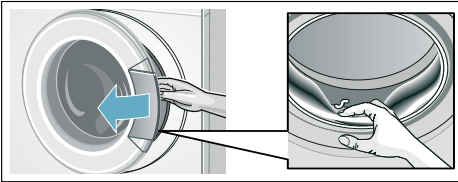

- Leave the washing machine door and detergent drawer open so that any residual water can evaporate.
- Always remove the laundry.
- Always wait until the programme has ended, as the appliance could still be locked.

Sensors

Automatic load sensing

The automatic load sensing function optimally adjusts the water consumption to each programme depending on the type of fabric and the load.

Unbalanced load detection system

The automatic unbalanced load detection system detects imbalances and ensures even distribution of the laundry by repeatedly starting and stopping drum spinning.

If the laundry is extremely unevenly distributed, the speed is reduced or the spin cycle is not performed for safety reasons.

Note: Place large and small items of laundry in the drum (from → *Page 33*).

Cleaning and maintenance

Warning **Risk of death!**

There is a risk of electric shock if live components are touched. Switch off the appliance and pull out the mains plug.

Warning **Risk of poisoning!**

Toxic vapours can be produced from cleaning agents that contain solvents, e.g. cleaning solvent. Do not use cleaning agents that contain solvents.

Caution! **Damage to the appliance**

Cleaning agents that contain solvents, e.g. cleaning solvent, can damage surfaces and components in the machine. Do not use cleaning agents that contain solvents.

Machine housing/control panel

- Wipe the housing and the control panel with a soft, damp cloth.
- Do not use any abrasive cloths, scourers or cleaning agents (stainless-steel cleaners).
- Remove the detergent residue immediately.
- Cleaning with a water jet is prohibited.

Drum

Wipe the inside of the rubber seal dry with a cloth. Leave the washing machine door open so that the drum can dry. Use chlorine-free cleaning agents; do not use steel wool.

Note: In order to keep the washing machine clean, run it through on the **Cottons 90 °C** programme on a regular basis.

Descaling

Note: Make sure that there is no laundry in the machine.

Descaling should not be necessary if the detergent is measured out correctly. However, if it is required, follow the manufacturer's instructions for the descaling agent. Suitable descalers can be obtained via our website or from our after-sales service. → *Page 35*

Detergent drawer and housing

If there is detergent or fabric softener residue:

1. Pull out the detergent drawer. Press down the insert and fully remove the drawer from the housing.
2. To remove the insert: Push the insert upwards from below with your finger.

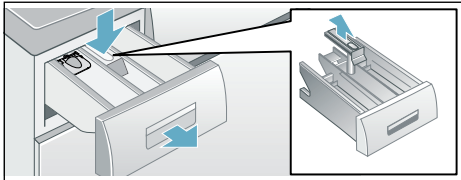

3. Clean the detergent dispenser tray and insert with water and a brush, and dry. Also remove any detergent or fabric softener residue in the housing.
4. Fit the insert and lock it in place (push the cylinder onto the guide pin).
5. Push in the detergent drawer.

Note: Leave the detergent drawer open so that any residual water can evaporate.

Detergent solution pump blocked

Warning **Risk of scalding!**

When washing at high temperatures, the detergent solution becomes hot. If you come into contact with the hot detergent solution, you may be scalded. Allow the detergent solution to cool down.

1. Turn off the water tap so that no more water can flow in and has to be drained via the detergent solution pump.
2. Switch off the appliance. Pull out the mains plug.
3. Open and remove the service flap.

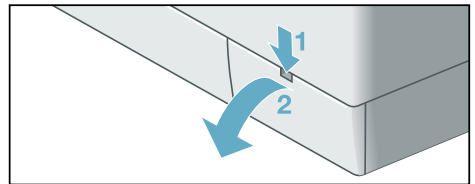

4. For models:
 - **With a drainage hose:** Remove the drainage hose from its holder and remove the sealing cap. Allow the detergent solution to flow out into a suitable container. Replace the sealing cap on the drainage hose, and place the drainage hose back in its holder.

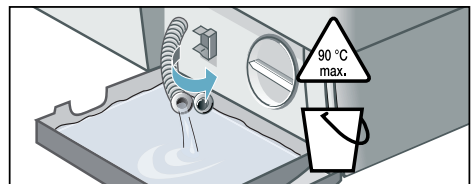

- **Without a drainage hose::**
Carefully unscrew the pump cover until the detergent solution begins to flow out.
When the service flap is half full, close the pump cover and drain the service flap.
Repeat the above steps until all the detergent solution has completely drained out.

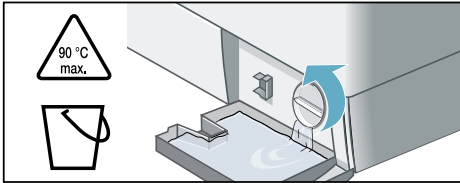

5. Carefully unscrew the pump cover; residual water may leak out. Clean the interior, pump-cover thread and pump housing. The impeller in the detergent solution pump must be able to rotate. Refit and screw on the pump cover. The handle must be in a vertical position.

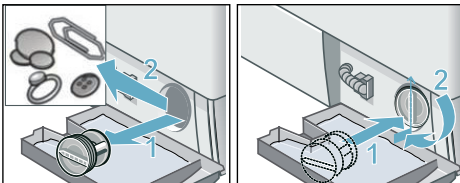

6. Put the service flap back on, lock it into place and close it.

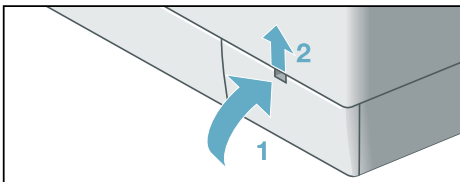

Note: To prevent unused detergent from flowing straight into the drain during the next wash: Pour 1 litre of water into compartment **II** and start the **Empty** programme.

The drain hose at the siphon is blocked

1. Switch off the appliance. Pull out the mains plug.
2. Loosen the hose clamp. Carefully remove the drain hose; residual water may leak out.
3. Clean the drain hose and siphon connecting piece.

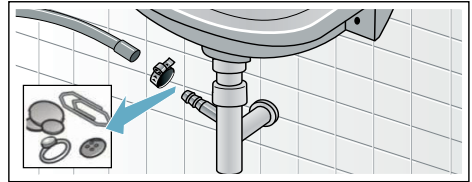

4. Re-attach the drain hose and secure the connection point using the hose clamp.

Filter in the water supply blocked

Warning
Risk of electric shock!

Do not immerse the AquaStop safety valve in water (it contains an electric valve).

First, reduce the water pressure in the supply hose:

1. Turn off the tap.
2. Select any programme (except **Rinse/Spin/Empty**).
3. Press the **Start button**. Allow the programme to run for approximately 40 seconds.
4. Set the programme selector to the **Off** position. Pull out the mains plug.

en Faults and what to do about them.

5. Clean the filter on the tap:
Disconnect the hose from the tap.
Clean the filter with a small brush.

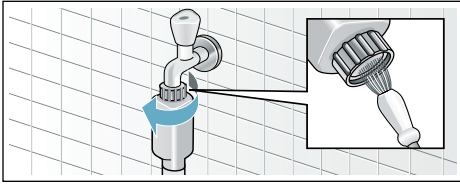

6. For standard and AquaSecure models, clean the filter on the rear of the appliance:
Disconnect the hose from the rear of the appliance,
Use pliers to remove the filter and then clean it.

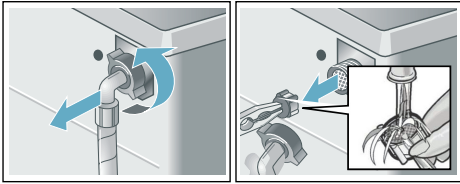

7. Connect the hose and check for leaks.

Faults and what to do about them.

Emergency release

E.g. in the event of a power cut
The programme continues when the power supply is restored.

However, if the laundry has to be removed, the washing machine door can be opened as follows:

Warning **Risk of scalding!**

When you are washing at high temperatures, there is a risk of scalding

if you come into contact with hot detergent solution and laundry.
If possible, leave it to cool down first.

Warning **Risk of injury!**

Reaching into the drum while it is still turning may cause hand injuries.
Do not reach into the drum when it is turning.
Wait until the drum has stopped turning.

Caution! **Water damage**

Any escaping water may cause water damage.
Do not open the washing machine door if water can be seen through the glass.

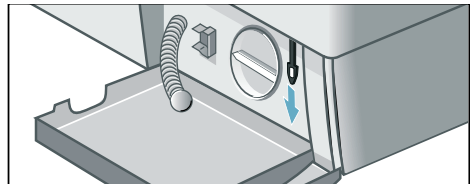

1. Switch off the appliance. Pull out the mains plug.
2. Drain the detergent solution
3. Use a tool to pull the emergency release downwards and then release.
The washing machine door can then be opened.



Information on the display panel

Display	Cause/remedy
E3	<ul style="list-style-type: none"> Close the washing machine door properly; washing may be trapped.
E5	<ul style="list-style-type: none"> Turn the tap on fully. → <i>Page 14</i> Supply hose kinked/jammed. The water pressure is too low. Clean the filter. → <i>Page 31</i>
E6	<ul style="list-style-type: none"> Detergent solution pump blocked. Clean the drain pump. → <i>Page 30</i> The drain hose/drain pipe is blocked. Clean the drain hose at the siphon. → <i>Page 31</i>
E2	<ul style="list-style-type: none"> Motor fault. Call the after-sales service. → <i>Page 35</i>
	<ul style="list-style-type: none"> Childproof lock is active; deactivate it. → <i>Page 27</i>
Other displays	<ul style="list-style-type: none"> Switch off the appliance, wait for five seconds and then switch it on again. If the display appears again, call the after-sales service. → <i>Page 35</i>

Faults and what to do about them.

Faults	Cause/remedy
Water is running out.	<ul style="list-style-type: none"> Attach the drain hose correctly or replace it. → <i>Page 15</i> Tighten the threaded joint on the inlet hose. → <i>Page 14</i>
Water not flowing in. Detergent is not being dispensed.	<ul style="list-style-type: none"> Has the Start button been pressed? Is the tap turned on? → <i>Page 14</i> Could the filter be clogged? Clean the filter. → <i>Page 31</i> Is the inlet hose kinked or trapped?
The door cannot be opened.	<ul style="list-style-type: none"> The safety function is activated. Stop programme? → <i>Page 28</i> Is  (childproof lock) activated? Deactivate. → <i>Page 27</i> ---- Rinse Stop (without final spin) selected? Can the door only be opened by the emergency release? → <i>Page 32</i>
Programme does not start.	<ul style="list-style-type: none"> Has the Start button been pressed to pause the programme, or has the Ready in time been selected? Is the door closed?  (childproof lock) activated? Deactivate. → <i>Page 27</i>
The water is not draining.	<ul style="list-style-type: none"> ---- Rinse Stop (without final spin) selected? Clean the drain pump. → <i>Page 30</i> Clean the drain pipe and/or the drain hose. → <i>Page 31</i>
Water is not visible in the drum.	<ul style="list-style-type: none"> Not a fault – the water is below the visible area.
The spin result is not satisfactory. Laundry wet/too damp.	<ul style="list-style-type: none"> Not a fault – the unbalanced load detection system has interrupted the spin because the laundry is unevenly distributed. Distribute small and large items of washing in the drum. Programme for  Easy-Iron selected? Is the selected speed too low?

en Faults and what to do about them.

Faults	Cause/remedy
The spin cycle runs several times.	<ul style="list-style-type: none"> ■ Not a fault – the unbalanced load detection system is adjusting an imbalance.
The programme is taking longer than usual.	<ul style="list-style-type: none"> ■ Not a fault – the unbalanced load detection system is adjusting an imbalance by repeatedly distributing the laundry. ■ Not a fault; the foam detection system is active – a rinse cycle has been switched on.
The length of the programme changes during the wash cycle.	<ul style="list-style-type: none"> ■ Not a fault – the programme sequence is optimised for the specific washing process. This may change the length of the programme shown in the display panel.
Residual water in the care product dispenser.	<ul style="list-style-type: none"> ■ Not a fault – the effectiveness of the care product is not affected. ■ If necessary, clean the insert and detergent drawer. → <i>Page 30</i>
There are odours or greasy deposits in the washing machine.	<ul style="list-style-type: none"> ■ Run the Cottons 90 °C programme without any laundry. Use standard detergent for this.
 Wash/Active indicator light flashes. Foam may also be leaking from the detergent drawer.	<ul style="list-style-type: none"> ■ Have you used too much detergent? Mix one tablespoon of fabric softener with 1/2 litre of water and pour into compartment II (not for outdoor fabrics or those made with down). Use less detergent in the next washing cycle.
Loud noises, vibrations and machine "movement" during the spin cycle.	<ul style="list-style-type: none"> ■ Appliance aligned? Align the appliance. → <i>Page 16</i> ■ Are the appliance feet secured? Secure the appliance's feet. → <i>Page 16</i> ■ Have the transport braces been removed? Removing the transportation bolts. → <i>Page 13</i>
Noises during spin and drain cycles.	<ul style="list-style-type: none"> ■ Clean the detergent solution pump → <i>Page 30</i>
The display panel/indicator lamps do not work while the appliance is running.	<ul style="list-style-type: none"> ■ Power failure? ■ Have the fuses blown? Switch on/replace the fuses. ■ If the fault occurs repeatedly, call the after-sales service. → <i>Page 35</i>
There is detergent residue on the laundry.	<ul style="list-style-type: none"> ■ Some phosphate-free detergents contain water-insoluble residue. ■ Select the Rinse programme or brush the laundry after washing.
If you cannot rectify a fault yourself (after switching the machine off and on again) or a repair is required:	
<ul style="list-style-type: none"> ■ Set the programme selector to the Off position. The appliance is switched off. ■ Unplug the mains plug from the socket. ■ Turn off the tap and call the after-sales service.. → <i>Page 35</i> 	



After-sales service

If you cannot rectify the fault yourself (Faults – what to do? → *Page 33*), please contact customer services. → Cover page

We will always find an appropriate solution to avoid unnecessary visits by engineers.

Please provide the after-sales service with the product number (E no.) and the production number (FD) of the appliance.

E-Nr. _____	FD _____
Product number	Production number

You can find this information (* depending on the model):

On the inside of the washing machine door*/in the opened service flap* and on the rear of the appliance.

Trust the expertise of the manufacturer.

Contact us. By doing so, you can be sure that the repairs are carried out by trained service personnel using genuine spare parts.



Technical data

Dimensions:

850 x 600 x 550 mm
(height x width x depth)

Weight:

68 - 75 kg (depending on model)

Mains connection:

Mains voltage 220 - 240 V/50 Hz

Nominal current 10 A

Nominal power 2000 – 2300 W

Water pressure:

100 - 1000 kPa (1 - 10 bar)

Power consumption when switched off:

0.20 W

Power consumption when ready for use (left-on mode):

1.90 W

Aqua-Stop warranty

Only for appliances with Aqua-Stop

In addition to warranty claims against the vendor based on the purchase agreement and to our appliance warranty, we will provide compensation under the following conditions:

1. If water damage is caused due to a fault in our Aqua-Stop system, we will compensate domestic customers for the damage caused.
2. The liability guarantee is valid for the service life of the appliance.
3. It is a prerequisite of all warranty claims that the appliance with Aqua-Stop must have been installed and connected correctly in accordance with our instructions; this also includes a correctly fitted Aqua-Stop extension (genuine accessories).

Our warranty does not cover defective feed lines or fittings leading to the Aqua-Stop connection at the tap.

4. Appliances with Aqua-Stop do not need to be supervised during operation, nor secured afterwards by turning off the tap.
The tap only needs to be turned off if you are away from home for a long period, e.g. for several weeks' holiday.



Advice and repair order in the event of faults

GB 0344 892 8979 (Calls charged at local or mobile rate.)

IE 01450 2655 (0.03 € per minute at peak. Off peak 0.0088 € per minute.)

You can find the contact information for all countries in the attached after-sales service directory.

Robert Bosch Hausgeräte GmbH
Carl-Wery-Straße 34
81739 München, GERMANY



9001255797 (9902)