

|                                       |                                 |                                      |
|---------------------------------------|---------------------------------|--------------------------------------|
| <b>de</b> Montageanleitung            | <b>ru</b> Инструкция по монтажу | <b>bs</b> Uputa za montažu           |
| <b>en</b> Installation instructions   | <b>cs</b> Montážní návod        | <b>fa</b> راهنمایی مونتاژ            |
| <b>fr</b> Notice de montage           | <b>pl</b> Instrukcja montażu    | <b>ar</b> تعليمات التركيب            |
| <b>nl</b> Montagevoorschrift          | <b>hu</b> Szerelési utasítás    | <b>ko</b> 설치 설명서                     |
| <b>it</b> Istruzioni per il montaggio | <b>hr</b> Uputa za montažu      | <b>zh</b> 安装说明                       |
| <b>el</b> Οδηγίες τοποθέτησης         | <b>mk</b> Упатство за монтажа   | <b>uk</b> Інструкція з монтажу       |
| <b>es</b> Instrucciones de montaje    | <b>sl</b> Navodilo za montažo   | <b>ro</b> Instrucțiunea de montaj    |
| <b>pt</b> Instruções de montagem      | <b>sr</b> Uputstvo za montažu   | <b>bg</b> Упътване за монтаж         |
| <b>sv</b> Monteringsanvisning         | <b>et</b> Monteerimisjuhend     | <b>ja</b> インストールに関する指示               |
| <b>no</b> Monteringsanvisning         | <b>lt</b> Montavimo instrukcija | <b>he</b> הוראות התקנה               |
| <b>fi</b> Asennusohje                 | <b>lv</b> Montāžas pamācība     | <b>id</b> Instruksi Pemasangan       |
| <b>da</b> Monteringsvejledning        | <b>sk</b> Návod na montáž       | <b>kk</b> Іске қосу туралы нұсқаулар |
| <b>tr</b> Montaj kılavuzu             | <b>sq</b> Udhëzues për montim   |                                      |

|  |  |
|--|--|
| <b>de</b> *) über Kundendienst erhältlich  | <b>sl</b> *) Lahko nabavite v servisni službi                |
| <b>en</b> *) Available from customer service   | <b>sr</b> *) Može se nabaviti preko servisne službe          |
| <b>fr</b> *) Disponible par le biais du service après-vente                                    | <b>et</b> *) küsige klienditeeninduselt                      |
| <b>nl</b> *) Tegen meerprijs bij de Servicedienst verkrijgbaar                                 | <b>lt</b> *) Ją galima gauti klientų aptarnavimo servise     |
| <b>it</b> *) Disponibili presso il servizio assistenza clienti                                 | <b>lv</b> *) Var saņemt servisa dienestā                     |
| <b>el</b> *) Διατίθενται από την υπηρεσία τεχνικής εξυπηρέτησης πελατών                        | <b>sk</b> *) Dostanete v službe zákazníkom                   |
| <b>es</b> *) Se puede adquirir a través del Servicio de Asistencia Técnica Oficial de la marca | <b>sq</b> *) Sigurohet nëpërmjet servisit                    |
| <b>pt</b> *) Pode ser adquirido nos nossos Serviços Técnicos                                   | <b>bs</b> *) Može se dobiti preko servisne službe            |
| <b>sv</b> *) kan fås via Service   | <b>fa</b> *) از مرکز خدمات پس از فروش تهیه فرمائید           |
| <b>no</b> *) fåes hos kundeservice   | <b>ar</b> *) يمكن طلبها من مراكز خدمة العملاء                |
| <b>fi</b> *) Saatavissa huoltopalvelusta   | <b>ko</b> *) 고객센터 서비스 센터에서 구입 가능                             |
| <b>da</b> *) Kan købes hos serviceafdelingen   | <b>zh</b> *) 可通过售后服务部门购得                                     |
| <b>tr</b> *) Yetkili servis üzerinden alınabilir   | <b>uk</b> *) Можна отримати через сервісну службу            |
| <b>ru</b> *) Можно получить в сервисном центре   | <b>ro</b> *) Se obține de la serviciul pentru clienți        |
| <b>cs</b> *) K dispozici přes servisní službu  | <b>bg</b> *) може да се намери в специализираните сервиси    |
| <b>pl</b> *) Do uzyskania w punkcie serwisowym   | <b>ja</b> *) 顧客サービスから利用可能                                    |
| <b>hu</b> *) A vevőszolgáltatón keresztül kapható  | <b>he</b> *) להשיג בתחנת שירות הלקוחות                       |
| <b>hr</b> *) može dobiti kod službe održavanja   | <b>id</b> *) bisa didapatkan melalui Customer Service        |
| <b>mk</b> *) се добива преку службата за купувачи  | <b>kk</b> *) Сервис қызмет көрсету орталығында алуына жатады |

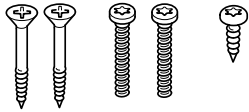

Ø4X36 Ø4X30 Ø4X13



Ø4X13

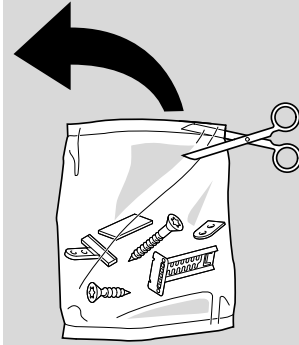
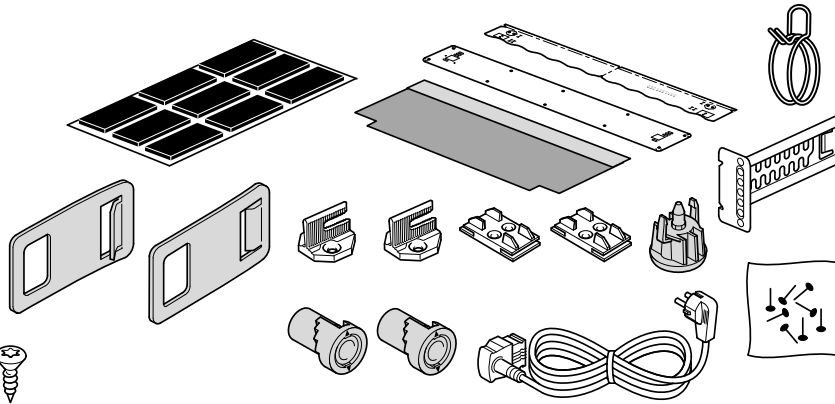

Torx  
T 20 Torx  
T 15

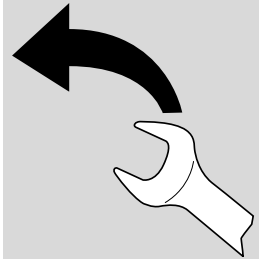
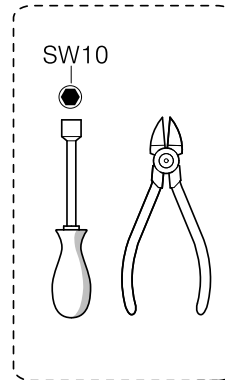
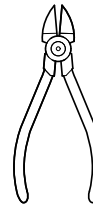
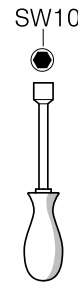
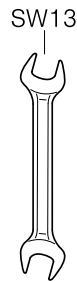
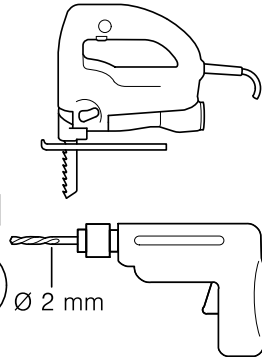
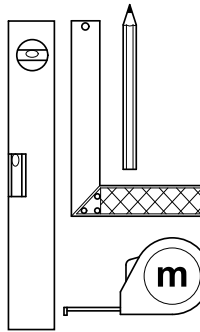
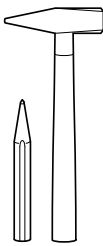
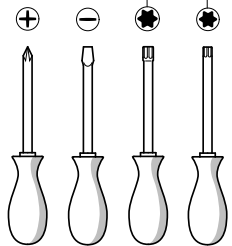

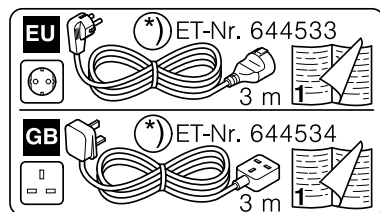
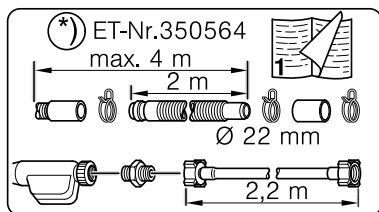
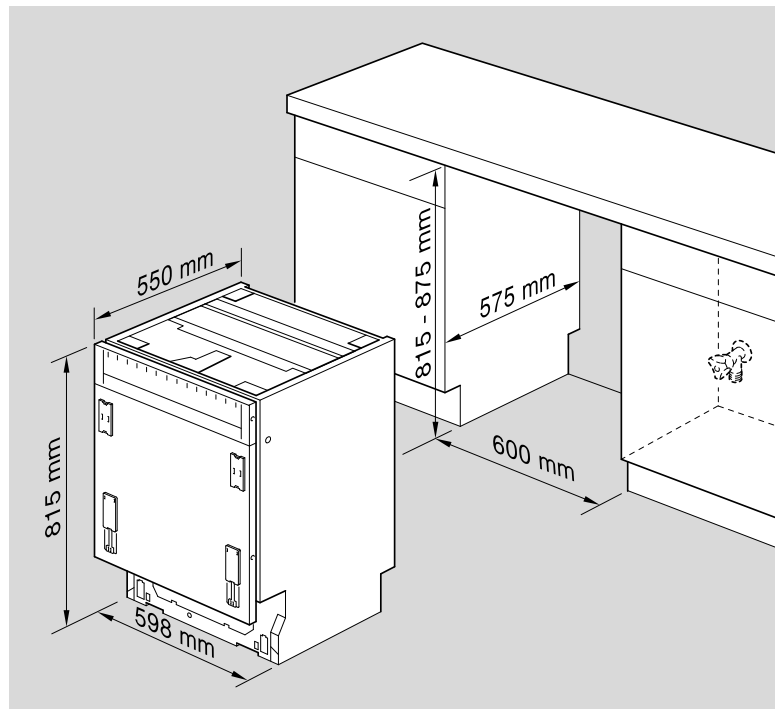
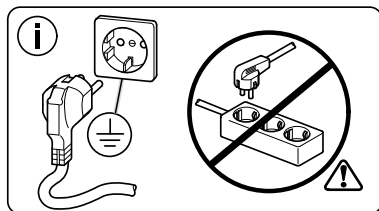
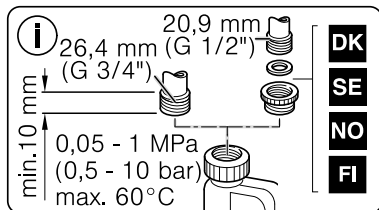
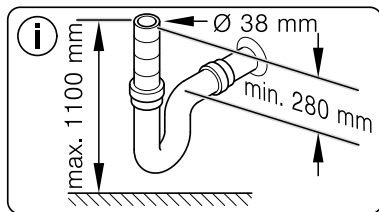

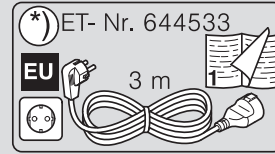
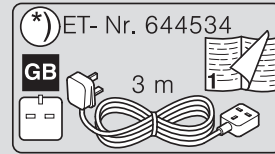
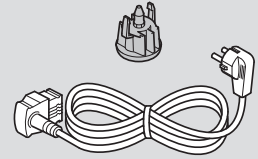
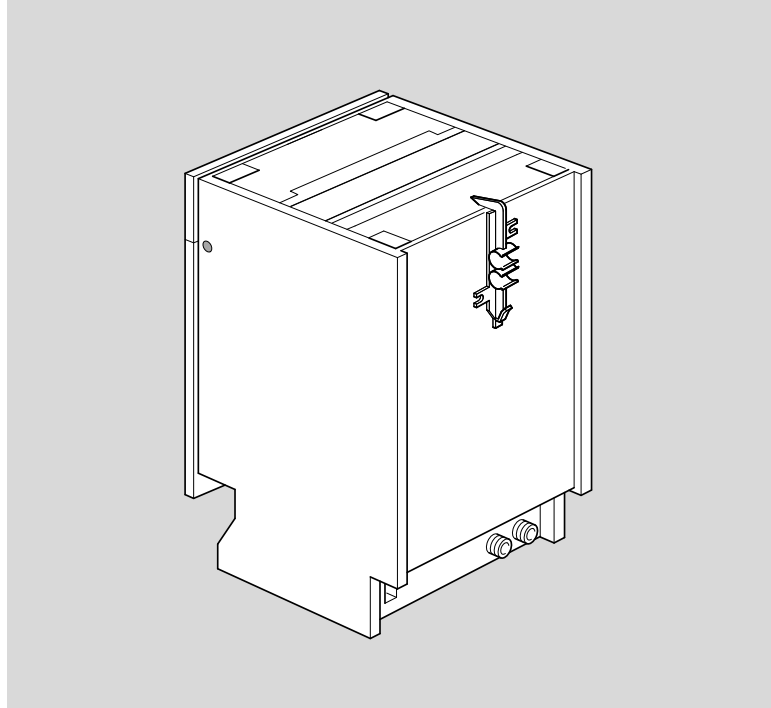
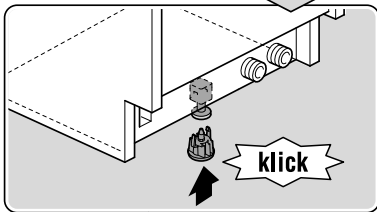
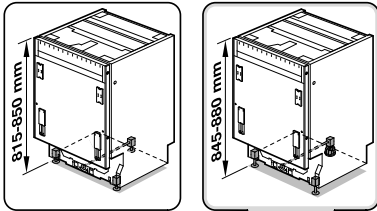
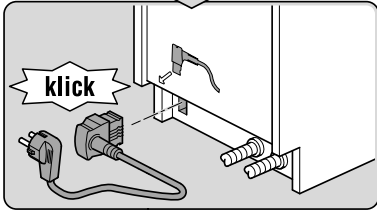
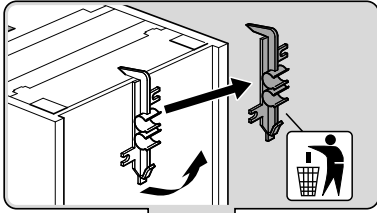

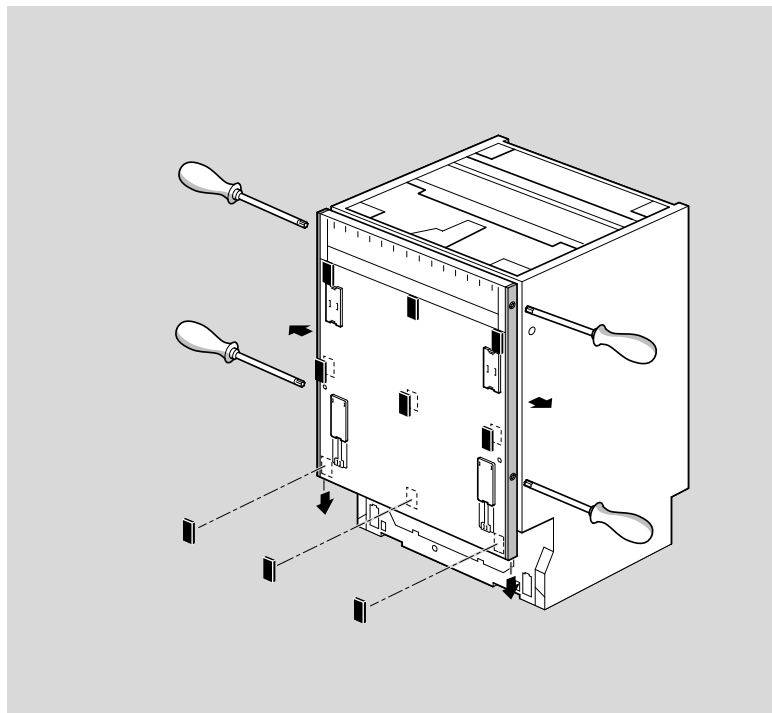
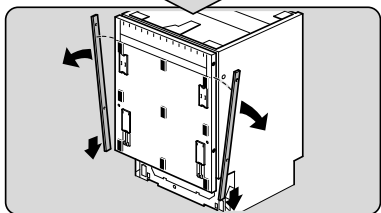
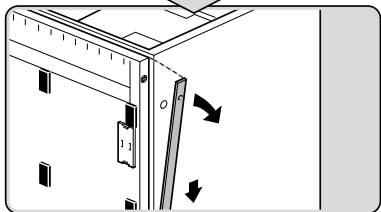
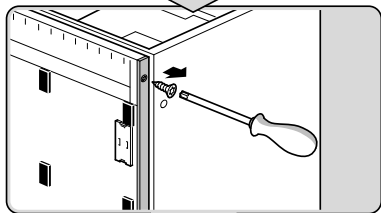
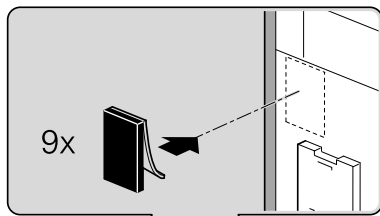

Torx  
T 15



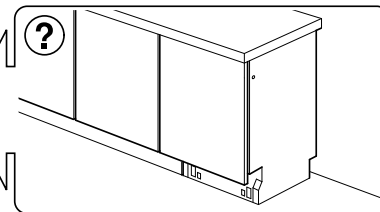
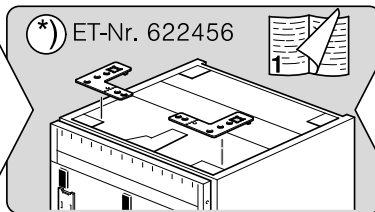
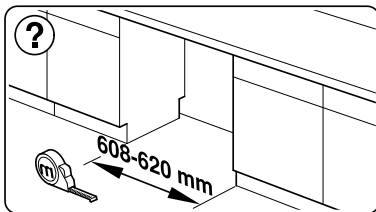
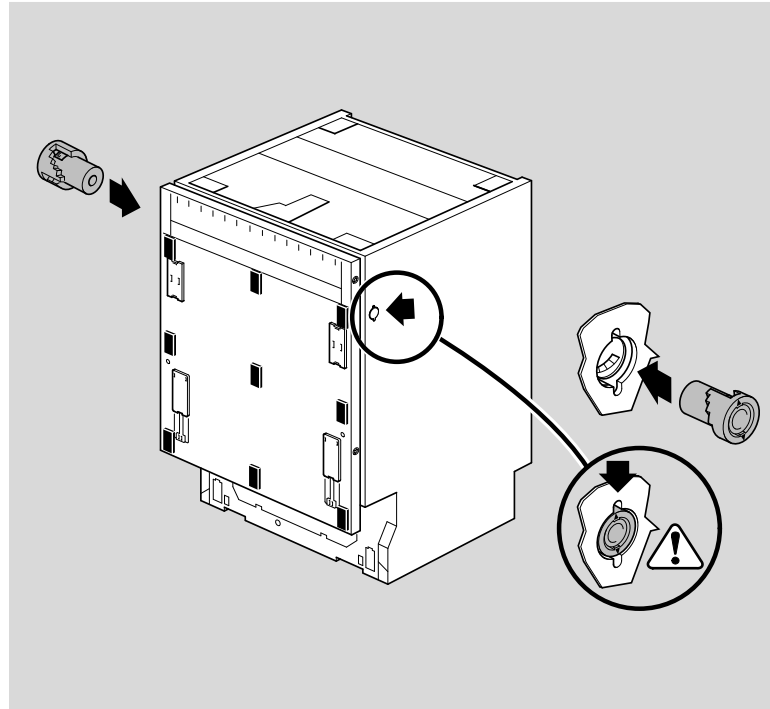
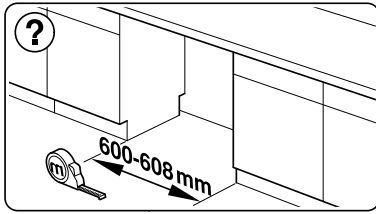

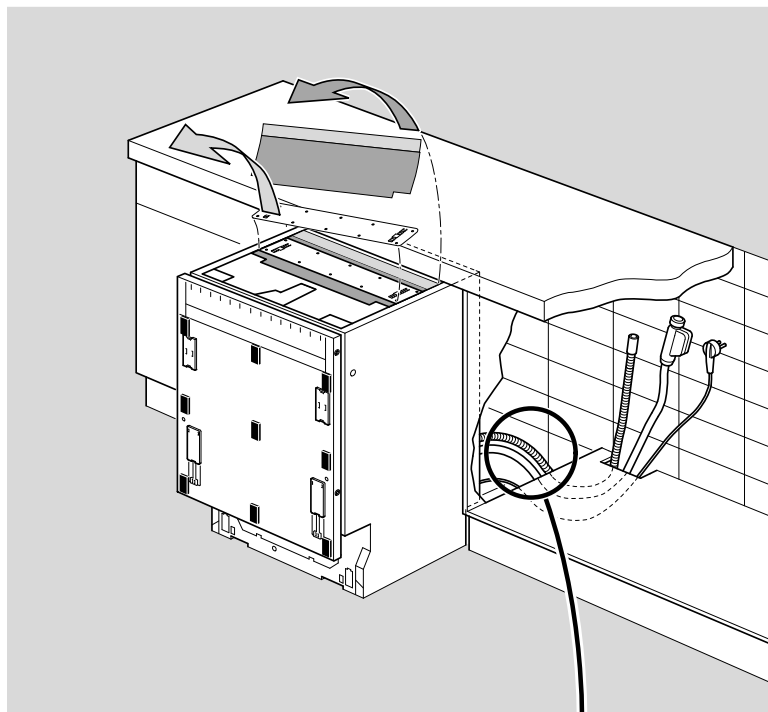
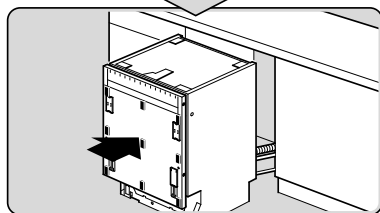
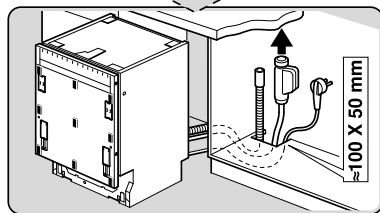
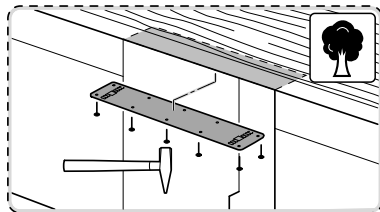
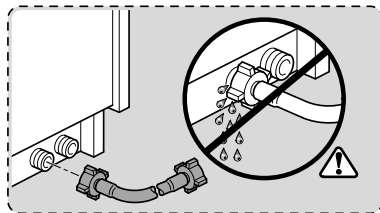

**nicht einklemmen**  
**do not pinch**  
**ne pas coincer**  
**No doblar**

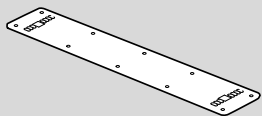
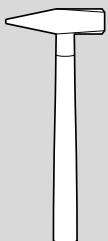
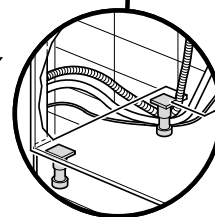

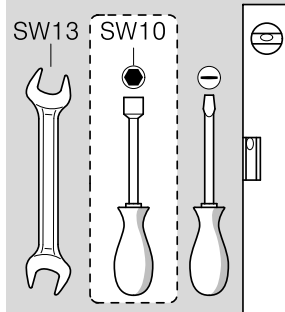
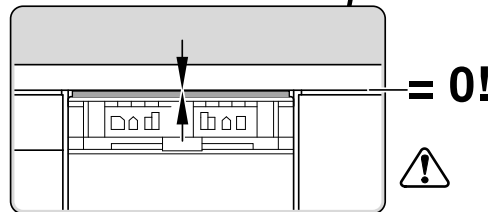
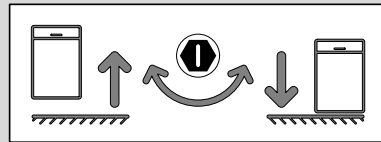
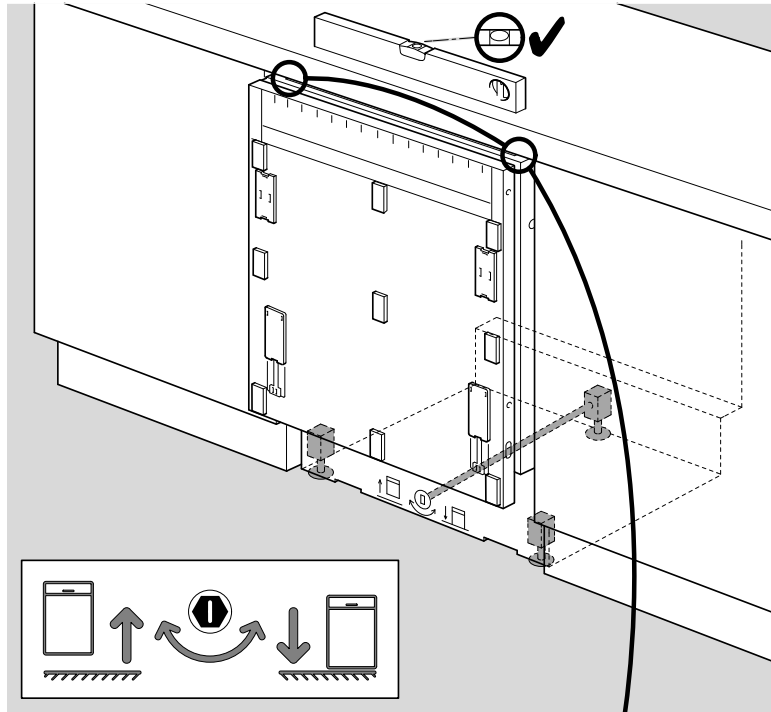
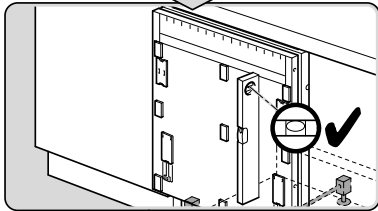
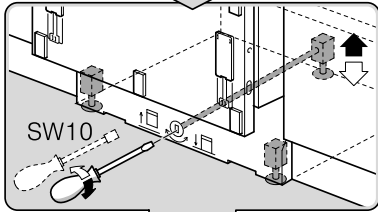
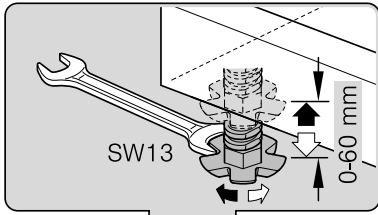



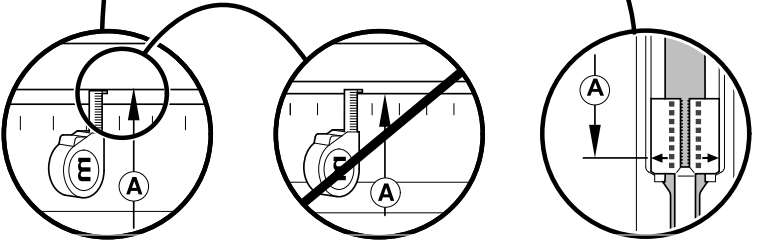
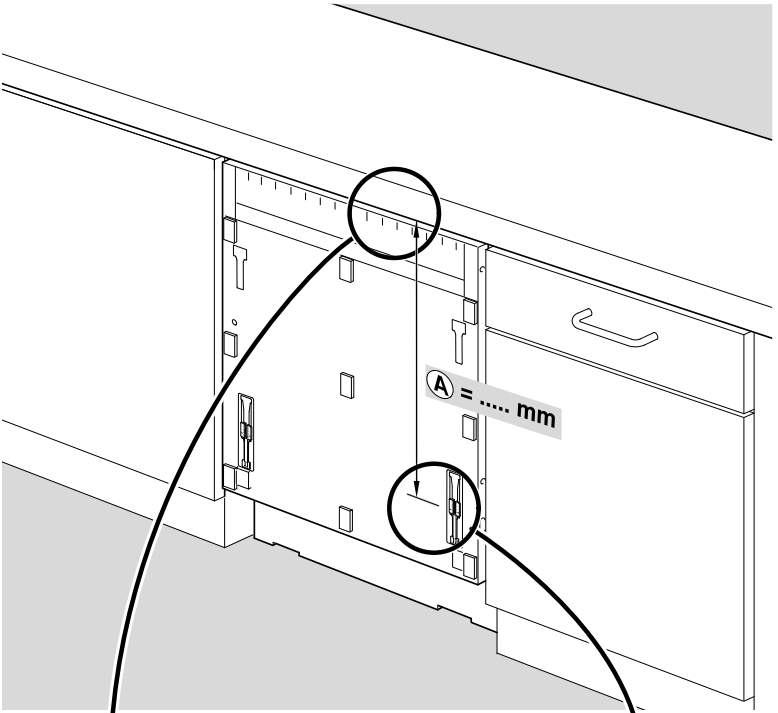
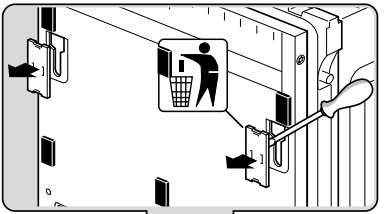

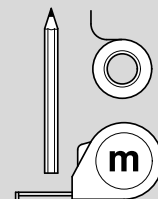
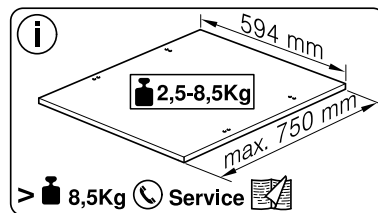
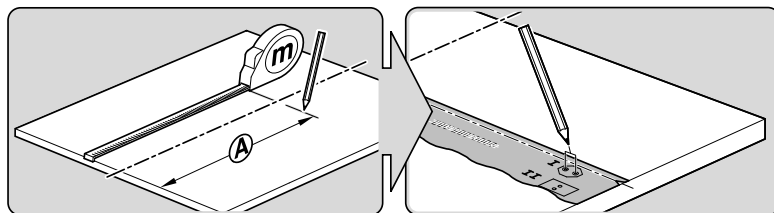
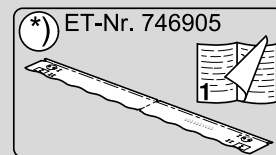
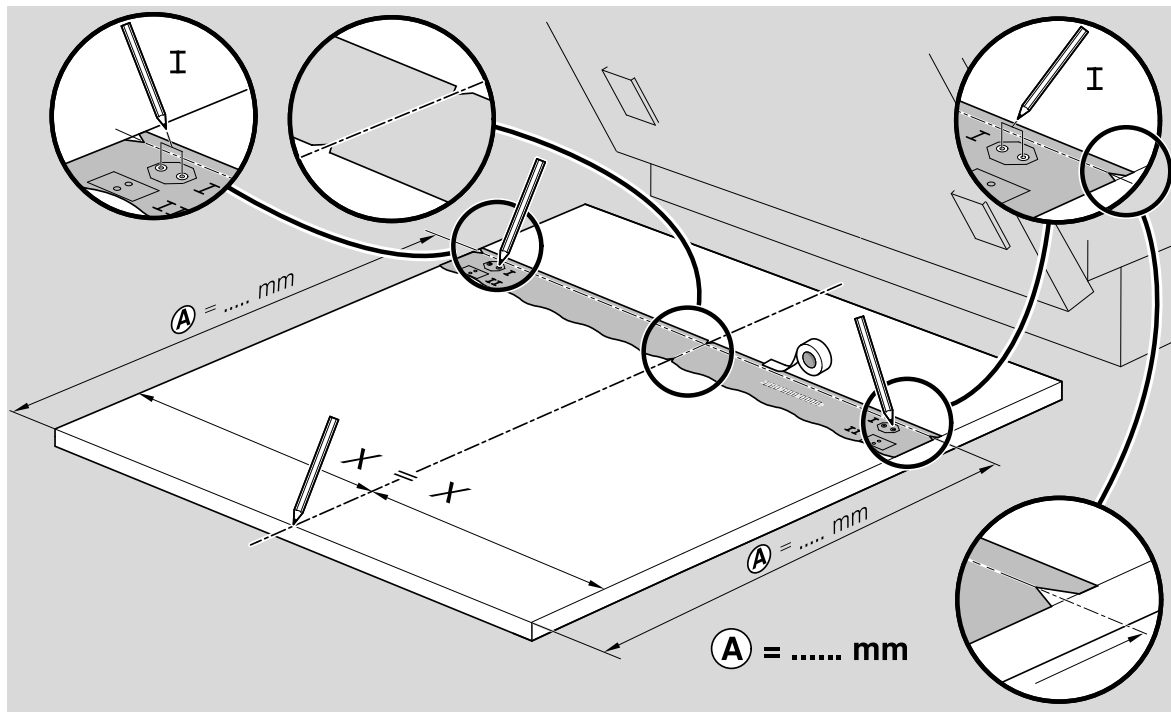

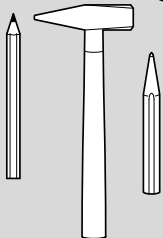
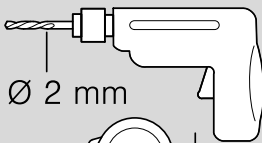
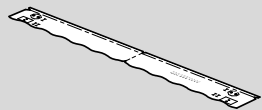
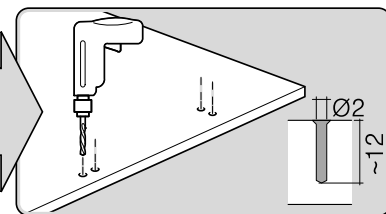
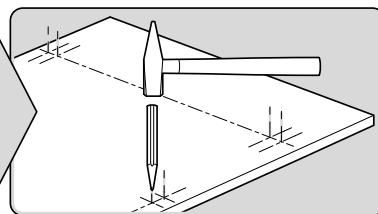
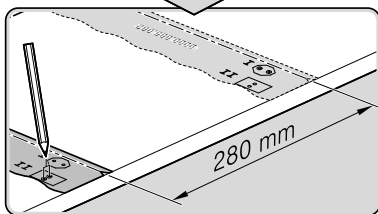
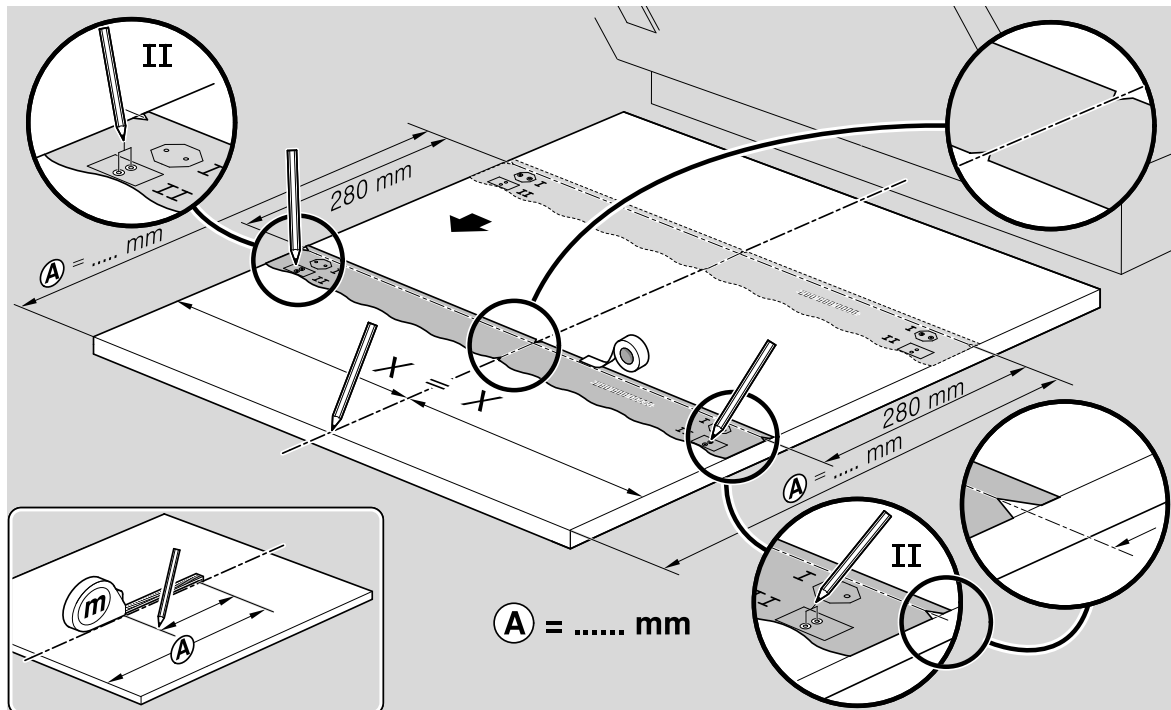

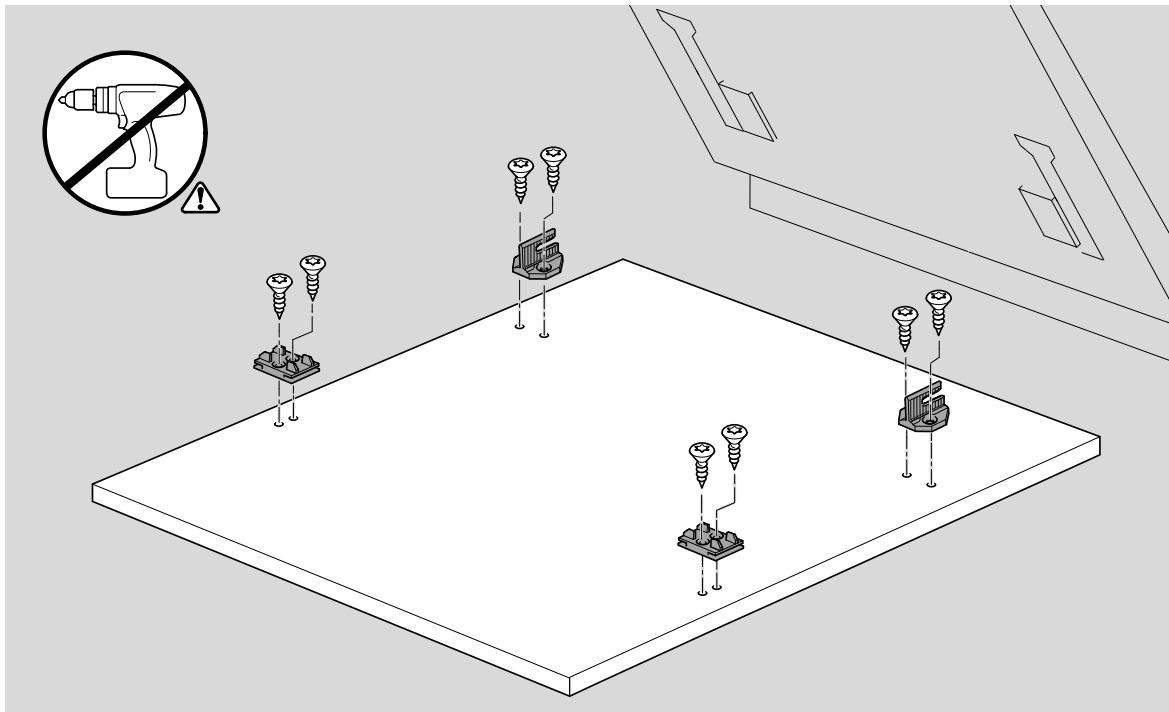

Ø4X13

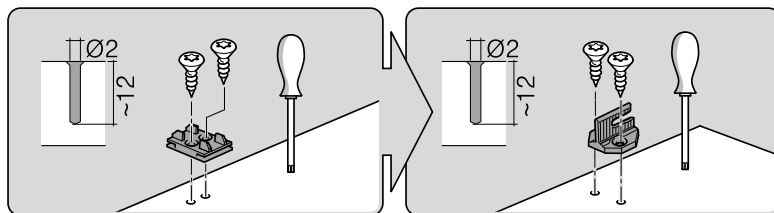
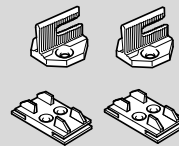
Torx  
T 20

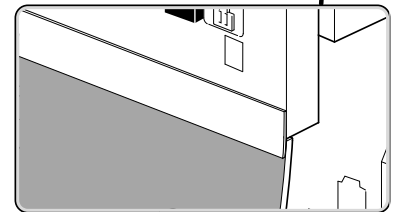
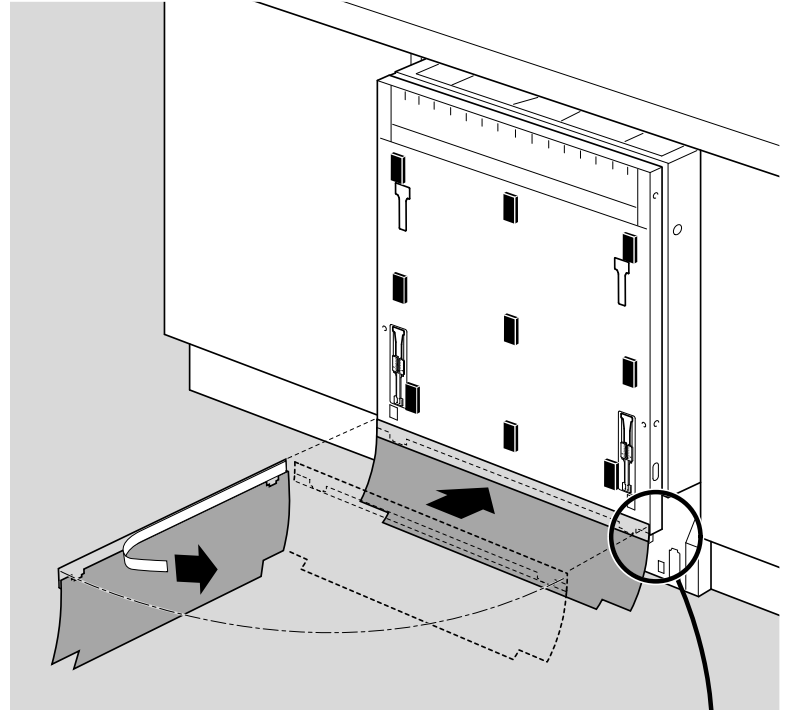
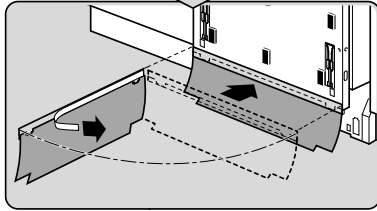
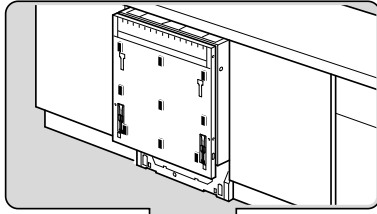

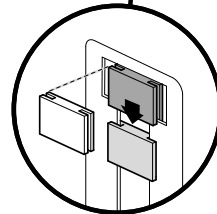
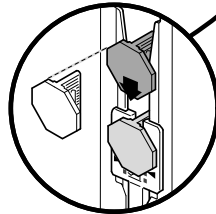
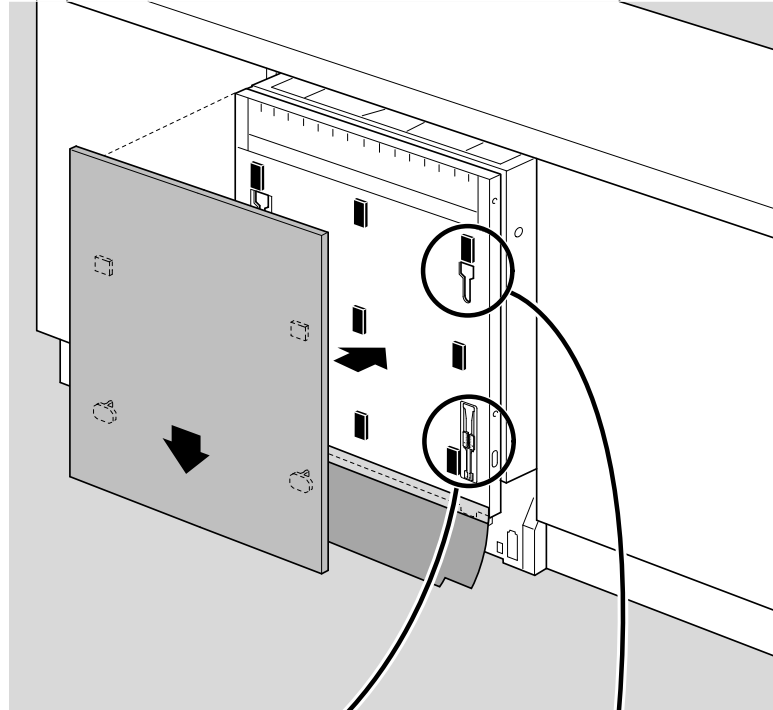
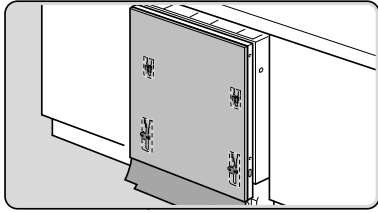

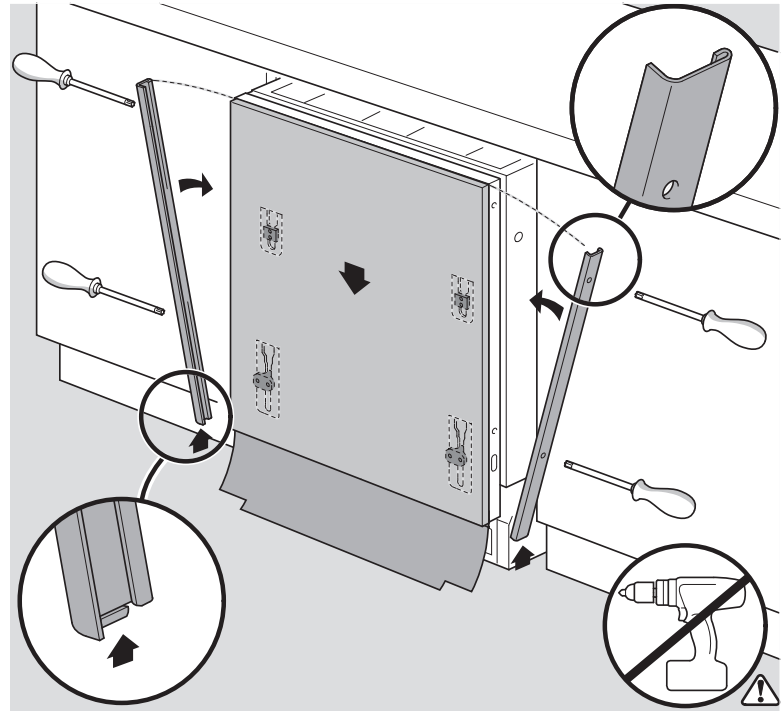
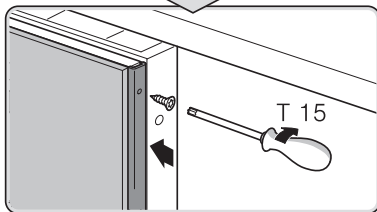
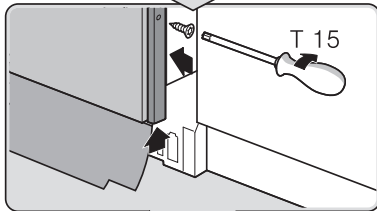
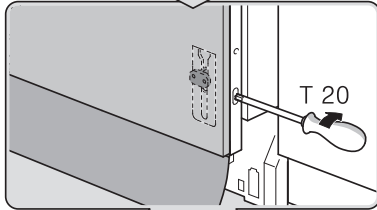
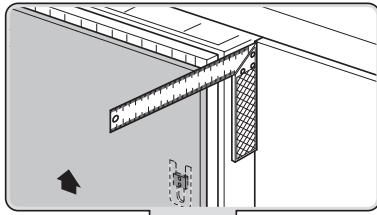

Torx  
T 15

Torx  
T 20

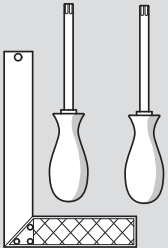

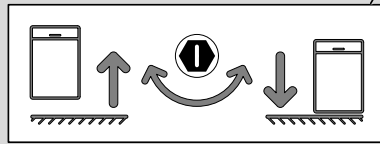
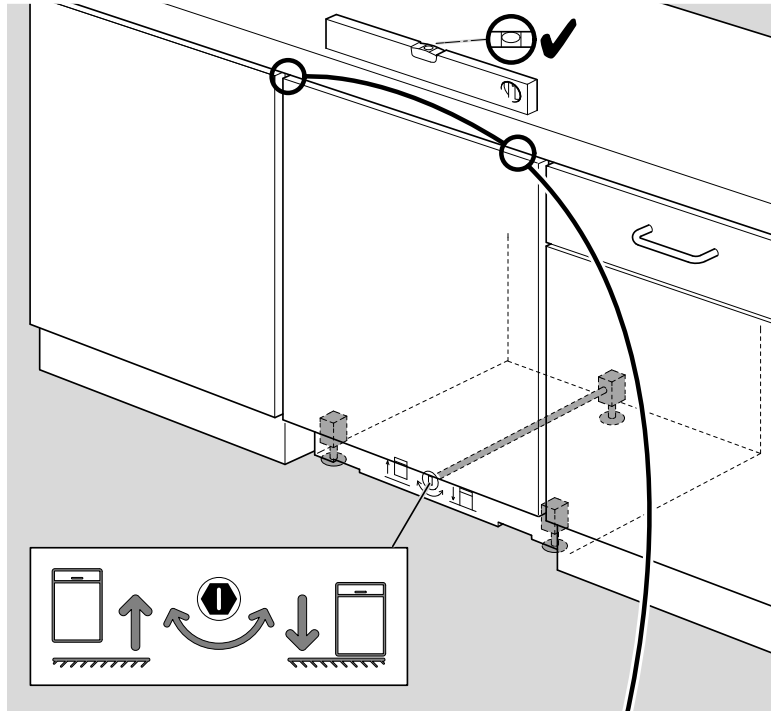
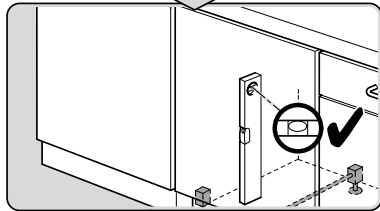
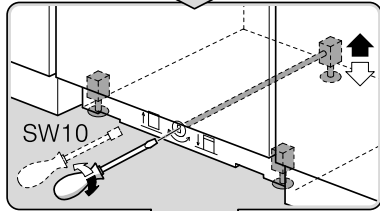
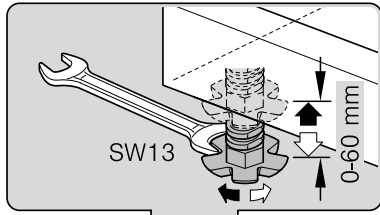

verspannen  
brace  
calar verticalement  
Enrasar

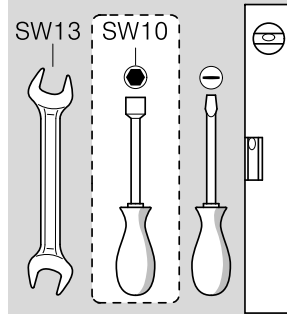
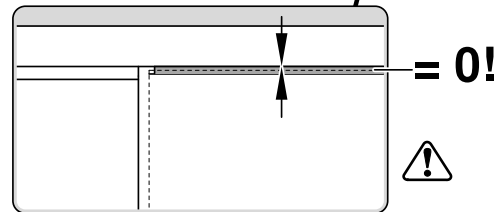





Ø4X30

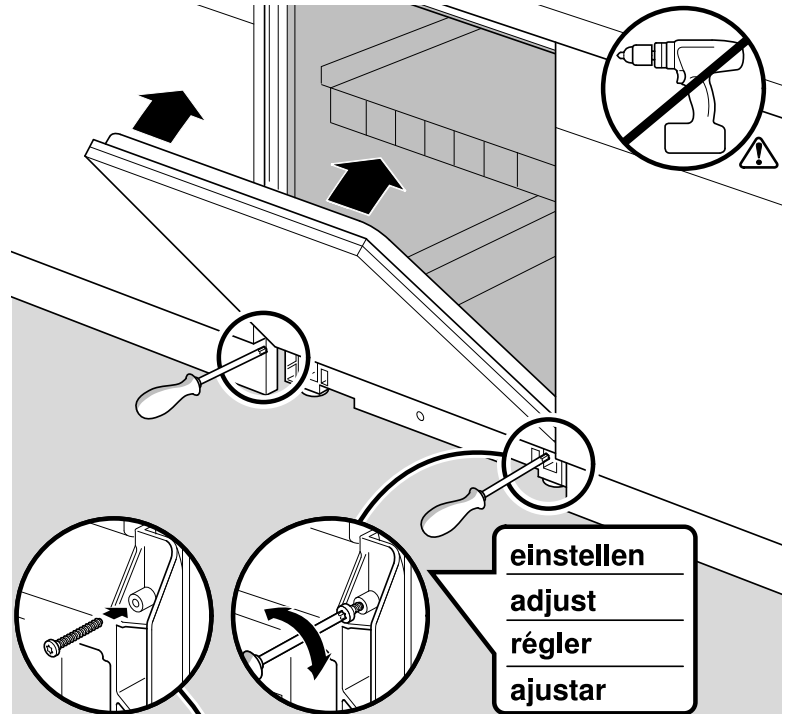
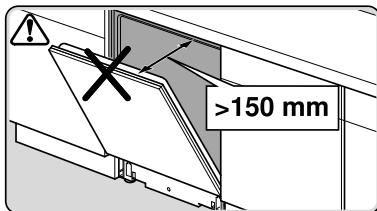
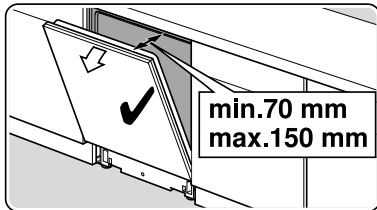
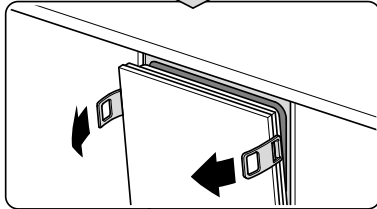
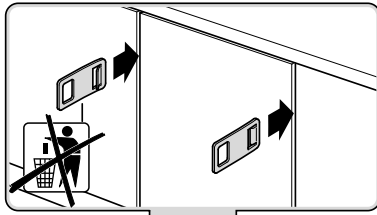

Torx  
T 20

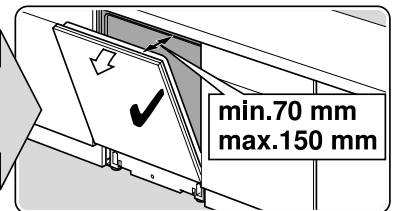
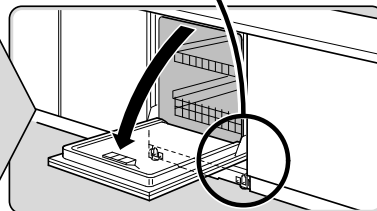

einstellen  
adjust  
régler  
ajustar

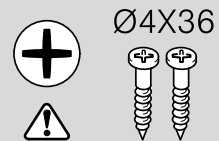
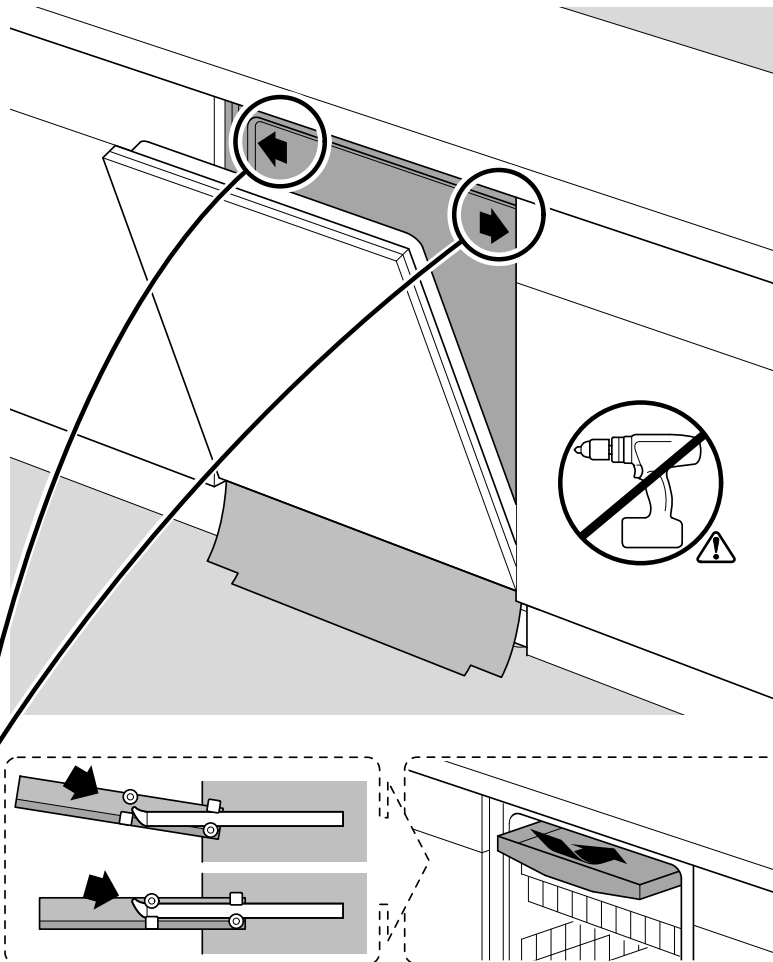
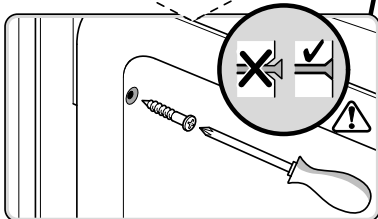
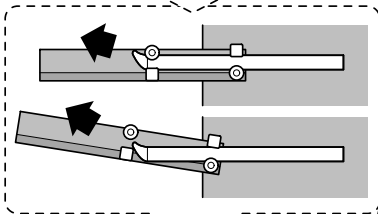
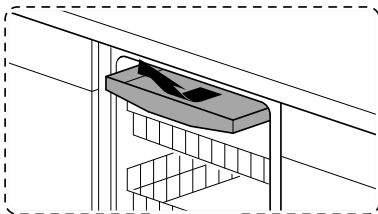
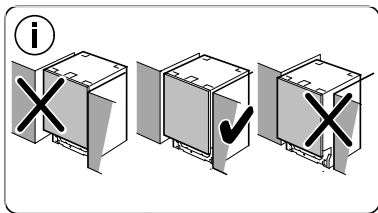

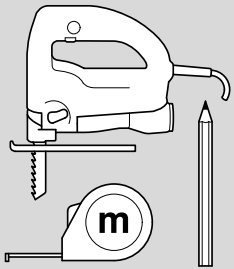
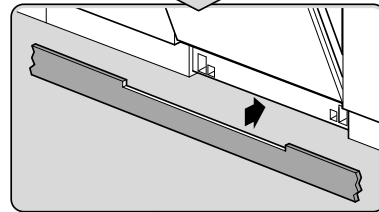
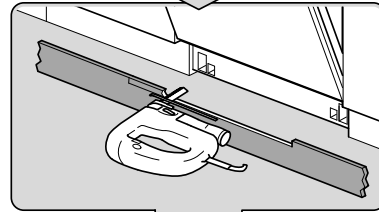
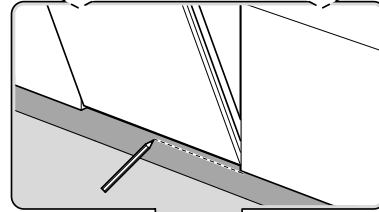
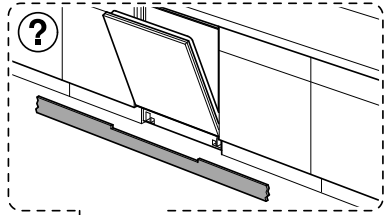
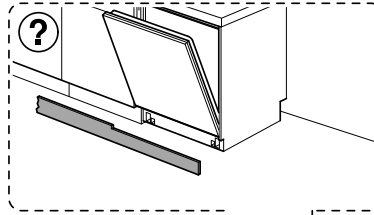
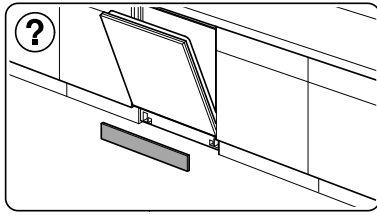

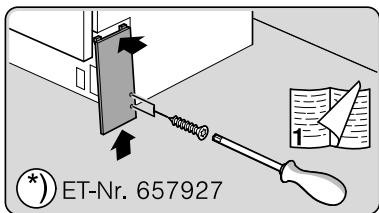
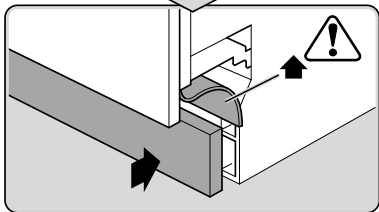
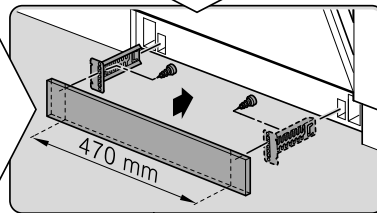
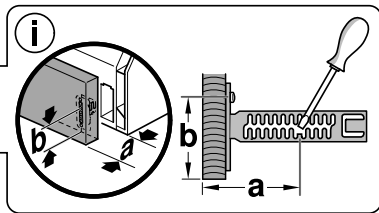
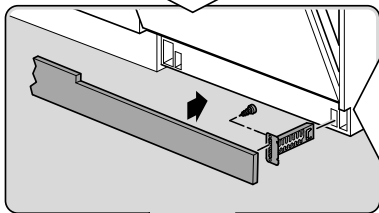
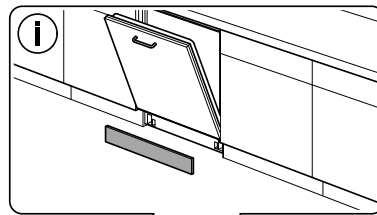
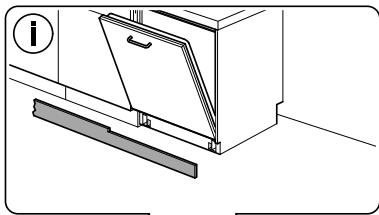

Ø4X13

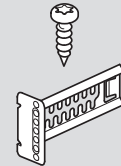

(\*) ET-Nr. 612653

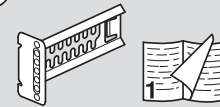

(\*) ET-Nr. 657927

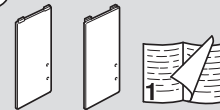

Torx  
T 20



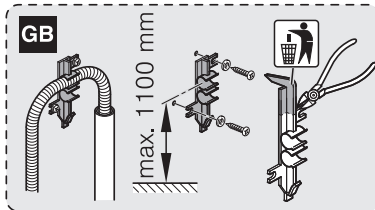
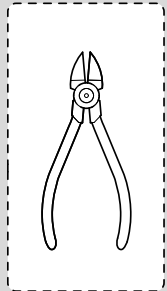
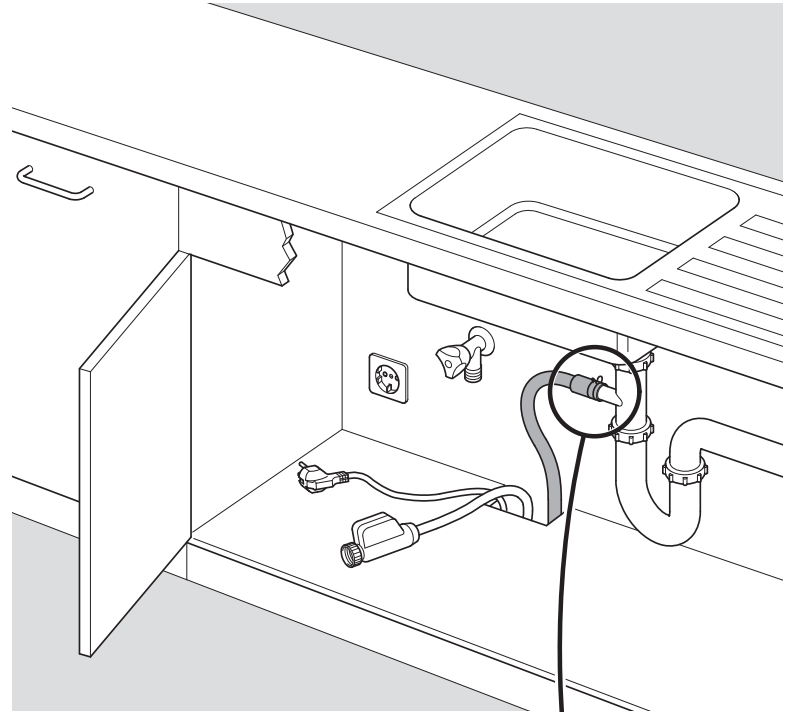
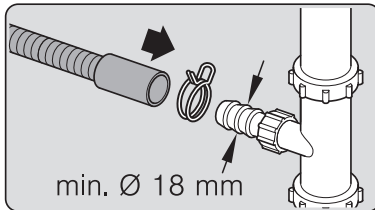
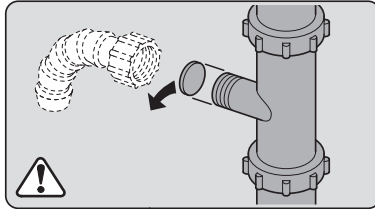
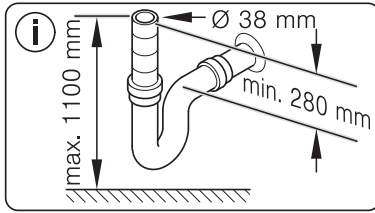

**Dichtheit prüfen**  
**Check for leaks**  
**Verifiez l'étanchéité**  
**Verificar la estanqueidad**

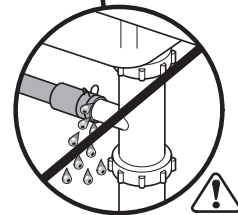



**max. 10 Nm**

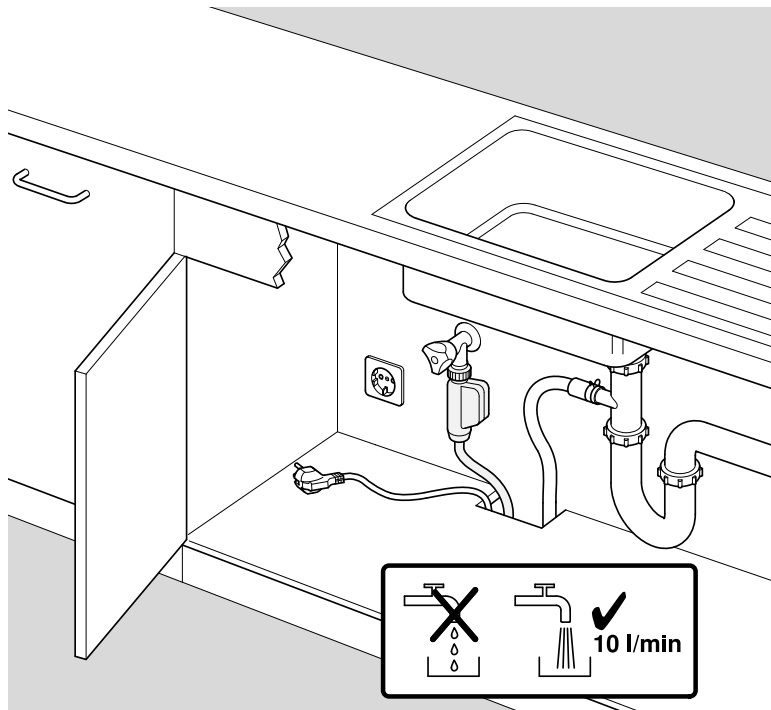

Dichtheit prüfen  
 Check for leaks  
 Verifiez l'étanchéité  
 Verificar la estanqueidad



