



Register your new Bosch now:
www.bosch-home.com/welcome







**Hob
PXY8..D...**



BOSCH

[en] Instruction manual



		g^*	b^*
A / B		2.200 W	3.700 W
		3.300 W	3.700 W
		2.600 W	3.700 W
		3.300 W	3.700 W

*  IEC 60335-2-6

Table of contents

 Intended use	4	 Keep warm function	19
 Important safety information	5	Activating	19
 Causes of damage	6	Deactivating	19
Overview	6	 Transferring settings	20
 Environmental protection	7	Activation	20
Energy-saving advice	7	 Cooking assist functions	21
Environmentally-friendly disposal	7	Cooking assistant function types	21
 Induction cooking	7	Suitable cookware	22
Advantages of induction cooking	7	Sensors and special accessories	22
Cookware	7	Functions and heat settings	22
 Getting to know your appliance	9	Recommended dishes	26
The control panel	9	Preparing and maintaining the wireless temperature sensor	30
The hotplates	10	Declaration of Conformity	32
Residual heat indicator	10	 Childproof lock	32
 Operating the appliance	11	Activating and deactivating the childproof lock	32
Switching the hob on and off	11	Childproof lock	32
Setting a hotplate	11	 Wipe protection	33
Chef's recommendations	11	 Automatic safety cut-out	33
 Flex Zone	14	 Basic settings	34
Advice on using cookware	14	To access the basic settings:	35
As two independent hotplates	14	 Energy consumption indicator	36
As a single hotplate	14	 Cookware check	36
 Move function	15	Activation	15
Activation	15	Deactivating	15
Deactivating	15	 Cleaning	37
 FlexPlus Zone	16	Hob	37
Notes regarding cookware	16	Hob surround	37
Activation	16	Wireless temperature sensor	37
Deactivating	16	 Frequently Asked Questions (FAQ)	38
 Time-setting options	17	 Trouble shooting	39
Programming the cooking time	17	 Customer service	40
The kitchen timer	17	E number and FD number	40
Stopwatch function	18	 Test dishes	41
 PowerBoost function	18	Activating	18
Activating	18	Deactivating	18
Deactivating	18	 ShortBoost function	19
 ShortBoost function	19	Recommendations for use	19
Recommendations for use	19	Activating	19
Activating	19	Deactivating	19
Deactivating	19		

Additional information on products, accessories, replacement parts and services can be found at www.bosch-home.com and in the online shop www.bosch-eshop.com

Intended use

Read these instructions carefully. Please keep the instruction and installation manual, as well as the appliance certificate, in a safe place for later use or for subsequent owners.

Check the appliance after removing it from the packaging. If it has suffered any damage in transport, do not connect the appliance, contact the Technical Assistance Service and provide written notification of the damage caused, otherwise you will lose your right to any type of compensation.

This appliance must be installed according to the installation instructions included.

This appliance is intended for private domestic use and the household environment only. The appliance must only be used for the preparation of food and beverages. The cooking process must be supervised. A short cooking process must be supervised without interruption. Only use the appliance in enclosed spaces.

This appliance is intended for use up to a maximum height of 4000 metres above sea level.

Do not use covers. These can cause accidents, due to overheating, catching fire or materials shattering, for example.

Do not use inappropriate child safety shields or hob guards. These can cause accidents.

This appliance is not intended for operation with an external clock timer or a remote control.

This appliance may be used by children over the age of 8 years old and by persons with reduced physical, sensory or mental capabilities or by persons with a lack of experience or knowledge if they are supervised or are instructed by a person responsible for their safety how to use the appliance safely and have understood the associated hazards.

Children must not play with, on, or around the appliance. Children must not clean the appliance or carry out general maintenance unless they are at least 8 years old and are being supervised.

Keep children below the age of 8 years old at a safe distance from the appliance and power cable.

When using the cooking functions, set the hotplate on which you have placed the saucepan with the temperature sensor.

We advise that you exercise caution using or standing near an induction hob while it is in operation, if you wear a pacemaker or a similar medical device. Consult your doctor or the device manufacturer concerning its conformity or any possible incompatibilities,

Important safety information

Warning – Risk of fire!

- Hot oil and fat can ignite very quickly. Never leave hot fat or oil unattended. Never use water to put out burning oil or fat. Switch off the hotplate. Extinguish flames carefully using a lid, fire blanket or something similar.
- The hotplates become very hot. Never place combustible items on the hob. Never place objects on the hob.
- The appliance gets hot. Do not keep combustible objects or aerosol cans in drawers directly underneath the hob.
- The hob switches off automatically and can no longer be operated. It may switch on unintentionally at a later point. Switch off the circuit breaker in the fuse box. Contact the after-sales service.

Warning – Risk of burns!

- The hotplates and surrounding area (particularly the hob surround, if fitted) become very hot. Never touch the hot surfaces. Keep children at a safe distance.
- The hotplate heats up but the display does not work. Switch off the circuit breaker in the fuse box. Contact the after-sales service.
- Metal objects on the hob quickly become very hot. Never place metal objects (such as knives, forks, spoons and lids) on the hob.
- After each use, always turn off the hob at the main switch. Do not wait until the hob turns off automatically after the pan is removed.

Warning – Risk of electric shock!

- Incorrect repairs are dangerous. Repairs may only be carried out and damaged power cables replaced by one of our trained after-sales technicians. If the appliance is defective, unplug the appliance from the mains or switch off the circuit breaker in the fuse box. Contact the after-sales service.
- Do not use any high-pressure cleaners or steam cleaners, which can result in an electric shock.

- A defective appliance may cause electric shock. Never switch on a defective appliance. Unplug the appliance from the mains or switch off the circuit breaker in the fuse box. Contact the after-sales service.
- Cracks or fractures in the glass ceramic may cause electric shocks. Switch off the circuit breaker in the fuse box. Contact the after-sales service.

Warning – Hazard due to magnetism!

The wireless temperature sensor is magnetic. The magnetic elements in it may damage electronic implants, e.g. pacemakers or insulin pumps. People fitted with electronic implants should therefore not carry the temperature sensor in their pockets and always keep it at least 10 cm away from their pacemaker or similar medical device.

Warning – Malfunction risk!

The hob is equipped with a fan in the lower section. If there is a drawer under the hob it should not be used to store small objects or paper, since they could damage the fan or interfere with the cooling if they are sucked into it.

There should be a minimum of 2 cm between the contents of the drawer and fan intake.

Warning – Risk of injury!

- The battery in the wireless temperature sensor may become damaged or explode if it gets too hot. Remove the sensor from the hob after cooking and do not store it near sources of heat.
- The temperature sensor may be very hot when removing it from the saucepan. Wear oven gloves or use a tea towel to remove it.
- When cooking in a bain marie, the hob and cooking container could shatter due to overheating. The cooking container in the bain marie must not directly touch the bottom of the water-filled pot. Only use heat-resistant cookware.
- Saucepans may suddenly jump due to liquid between the pan base and the hotplate. Always keep the hotplate and saucepan bases dry.

Causes of damage

Caution!

- Rough pan bases may scratch the hob.
- Avoid leaving empty pots and pans on the hotplate. Doing so may cause damage.
- Do not place hot pans on the control panel, the indicator area, or the hob frame. Doing so may cause damage.
- Hard or pointed objects dropped on the hob may damage it.
- Aluminium foil and plastic containers will melt if placed on the hotplate while it is hot. The use of laminated sheeting is not recommended on the hob.

Overview

You will find the most frequently caused damage in the following table:

Damage	Cause	Measure
Stains	Boiled over food.	Remove boiled over food immediately with a glass scraper.
	Unsuitable cleaning agent.	Only use cleaning agents that are suitable for this type of hob.
Scratches	Salt, sugar and sand.	Do not use the hob as a work surface or storage space.
	Cookware with rough bases scratch the hob.	Check the cookware.
Discolouration	Unsuitable cleaning agent.	Only use cleaning agents that are suitable for this type of hob.
	Pan abrasion.	Lift pots and pans when moving them.
Chips	Sugar, food with a high sugar content.	Remove boiled over food immediately with a glass scraper.

Environmental protection

In this section, you can find information about saving energy and disposing of the appliance.

Energy-saving advice

- Always use the correct lid for each pan. Cooking without a lid uses a lot more energy. Use a glass lid to provide visibility and avoid having to lift the lid.
- Use pans with flat bases. Bases that are not flat use a lot more energy.
- The diameter of the pan base must match the size of the hotplate. Please note: pan manufacturers usually provide the diameter for the top of the pan, which is usually larger than the diameter of the pan base.
- Use a small pan for small amounts of food. A large pan which is not full uses a lot of energy.
- Use little water when cooking. This saves energy and preserves all the vitamins and minerals in vegetables.
- Select the lowest power level to maintain cooking. If the power level is too high, energy is wasted.

Environmentally-friendly disposal

Dispose of packaging in an environmentally-friendly manner.



This appliance is labelled in accordance with European Directive 2012/19/EU concerning used electrical and electronic appliances (waste electrical and electronic equipment - WEEE). The guideline determines the framework for the return and recycling of used appliances as applicable throughout the EU.

The wireless temperature sensor is battery-powered. Dispose of used batteries in an environmentally responsible manner.

Induction cooking

Advantages of induction cooking

Induction cooking is very different from traditional cooking methods, as heat builds up directly in the item of cookware. This offers numerous advantages:

- Saves time when boiling and frying.
- Saves energy.
- Easier to care for and clean. Spilled food does not burn on as quickly.
- Heat control and safety – the hob increases or decreases the heat supply as soon as the user changes the setting. The induction hotplate stops the heat supply as soon as the cookware is removed from the hotplate, without having to switch it off first.

Cookware

Only use ferromagnetic cookware for induction cooking, such as:

- Cookware made from enamelled steel
- Cookware made from cast iron
- Special induction-compatible cookware made from stainless steel.

To check whether your cookware is suitable for induction cooking, refer to the section on → "Cookware check".

To achieve a good cooking result, the ferromagnetic area on the base of the pan should match the size of the hotplate. If a hotplate does not detect an item of cookware, try placing it on another hotplate with a smaller diameter.

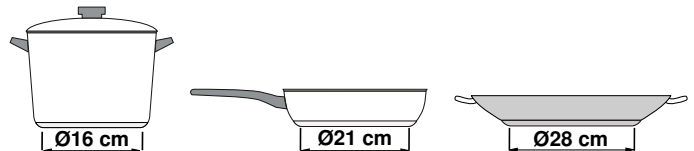

If the only hotplate being used is the flexible cooking zone, larger cookware that is particularly suited to this zone can be used. You can find information on positioning cookware in the section on → "Flex Zone".



Some induction cookware does not have a fully ferromagnetic base:

- If the base of the cookware is only partially ferromagnetic, only the area that is ferromagnetic will heat up. This may mean that heat will not be distributed evenly. The non-ferromagnetic area may not heat up to a sufficient temperature for cooking.

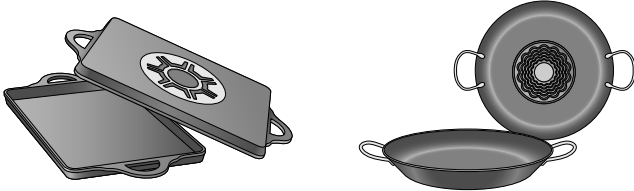

- The ferromagnetic area will also be reduced if the material from which the base of the cookware is made contains aluminium, for example. This may mean that the cookware will not become sufficiently hot or even that it will not be detected.

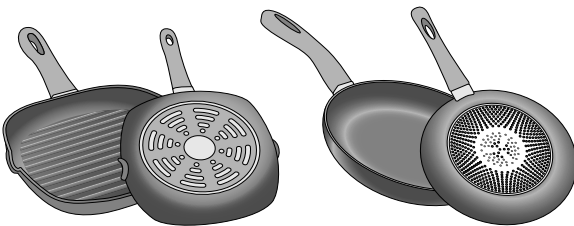

Unsuitable pans

Never use diffuser hobs or pans made from:

- common thin steel
- glass
- earthenware
- copper
- aluminium

Properties of the base of the cookware

The material(s) from which the base of the cookware is made can affect the cooking result. Using pots and pans made from materials that distribute heat evenly through them, such as stainless-steel pans with a three-layer base, saves time and energy.

Use cookware with a flat base; if the base of the cookware is uneven, this may impair the heat supply.



Absence of pan or unsuitable size

If no pan is placed on the selected hotplate, or if it is made of unsuitable material or is not the correct size, the power level displayed on the hotplate indicator will flash. Place a suitable pan on the hotplate to stop the flashing. If this takes more than 90 seconds, the hotplate will switch off automatically.

Empty pans or those with a thin base

Do not heat empty pans, nor use pans with a thin base. The hob is equipped with an internal safety system. However, an empty pan may heat up so quickly that the "automatic switch off" function may not have time to react and the pan may reach very high temperatures. The base of the pan could melt and damage the glass on the hob. In this case, do not touch the pan and switch the hotplate off. If it fails to work after it has cooled down, please contact the Technical Assistance Service.

Pan detection

Each hotplate has a lower limit for pan detection. This depends on the diameter of the ferromagnetic area of the cookware and the material from which its base is made. For this reason, you should always use the hotplate that best matches the diameter of the base of the pan.

Getting to know your appliance

You can find information on the dimensions and power of the hotplates in → *Page 2*

The control panel

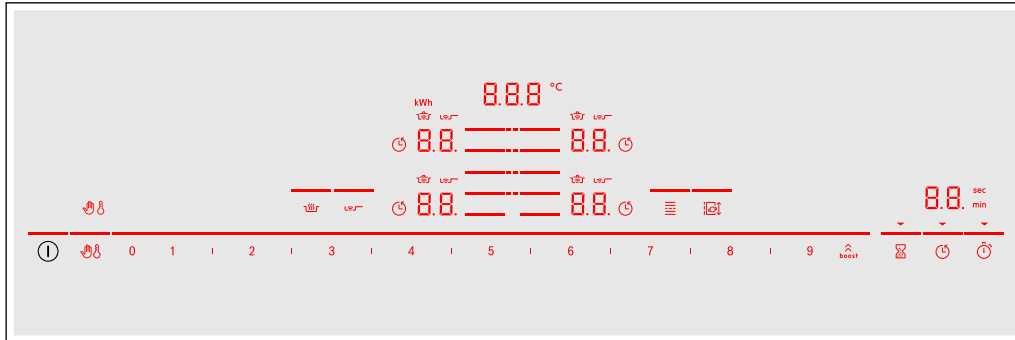

Controls	
①	Main switch
≡	Select a hotplate
0 1 2 1...1 8 1 9	Settings range
boost	PowerBoost and ShortBoost function
👉	Lock control panel for cleaning
🔒	Childproof lock
🔥	Keep warm function
👉	Frying sensor
≡	Flexible cooking zone
👉	Move function
🕒	Kitchen timer
🕒	Timer function
🕒	Kitchen timer

Indicators	
0.0	Operating status
1.9	Heat settings
H/h	Residual heat
00	Timer function
000°C	Temperature for cooking functions
👉	Locking the control panel for cleaning
🔒	Childproof lock
🕒	Setting the cooking time
min/sec	Timer displays
b.	PowerBoost function
Pb.	ShortBoost function
👉	Cooking functions
👉	Frying sensor
⋮	FlexPlus cooking zone
t	Transfer settings
kWh	Energy consumption
Lo	Keep-warm function

Controls



When the hob heats up, the symbols for the controls available at this time light up.

Touching a symbol activates the respective function.

Notes

- The corresponding symbols for the controls light up depending on whether they are available. The displays for the hotplates or the selected functions get brighter.
- Always keep the control panel clean and dry. Moisture can prevent it from working properly.

The hotplates

Hotplate		
	Simple hotplate	Use cookware that is a suitable size.
	Flexible cooking zone	See section → "Flex Zone"
	FlexPlus cooking zone	The FlexPlus cooking zones always switch on in conjunction with the right- or left-hand flexible cooking zone. See section → "FlexPlus Zone"

Only use cookware that is suitable for induction cooking; see section → "Induction cooking"

Residual heat indicator

The hob has a residual heat indicator for each hotplate. This indicates that a hotplate is still hot. Do not touch a hotplate while the residual heat indicator is lit up.

The following are shown depending on the amount of residual heat:

- Display **H**: High temperature
- Display **h**: Low temperature

If you remove the cookware from the hotplate during cooking, the residual heat indicator and the selected heat setting will flash alternately.



When the hotplate is switched off, the residual heat indicator will light up. Even after the hob has been switched off, the residual heat indicator will stay lit for as long as the hotplate is still warm.

Operating the appliance

This chapter explains how to set a hotplate. The table shows heat settings and cooking times for various meals.

Switching the hob on and off

The main switch is used to switch the hob on and off.

To switch on: Touch the  symbol. An audible signal sounds. The symbols for the hotplates and the functions available at this time light up. The  symbol lights up next to the hotplates. The hob is ready to use.

To switch off: Touch the  symbol until the indicators go out. The residual heat indicator remains lit until the hotplates have cooled down sufficiently.

Notes

- The hob switches off automatically if all hotplates have been switched off for more than 20 seconds.
- The selected settings are stored for four seconds after the hob has been switched off. If you switch it on again during this time, the hob will operate using the previously stored settings.

Setting a hotplate

Set the required heat setting using the **1** to **9** symbols.



Heat setting **1** = lowest setting.

Heat setting **9** = highest setting.

Every heat setting has an intermediate setting. This is marked in the control panel with the **I** symbol.

Selecting a hotplate and heat setting

The hob must be switched on.

1. Touch the  symbol for the required hotplate. The  display gets brighter.
2. Then select the required heat setting from the settings range.

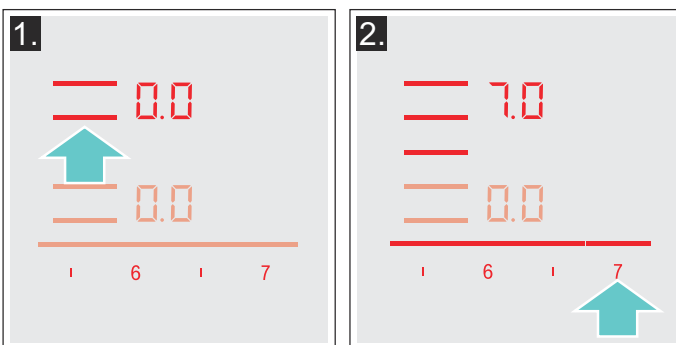

The heat setting is set.

Changing the heat setting

Select the hotplate and then set the required heat setting in the control panel.

Switching off the hotplate

Select the hotplate and set it to  in the settings range. The hotplate switches itself off and the residual heat indicator appears.

Notes

- If no pan has been placed on the hotplate, the selected power level flashes. After a certain time has elapsed, the hotplate switches off.
- If a pan has been placed on the hotplate before switching on the hob, it will be detected within 20 seconds of pressing the main switch and the hotplate will be selected automatically. Once detected, select the power level within the next 20 seconds or the hotplate will switch off. If more than one pan is placed on the hob, only one will be detected when switching it on.

Chef's recommendations

Recommendations

- When heating up puree, cream soups and thick sauces, stir occasionally.
- Set heat setting 8 to 9 for preheating.
- When cooking with the lid on, turn the heat setting down as soon as steam escapes between the lid and the cookware. Steam does not need to escape for a good cooking result.
- After cooking, keep the lid on the cookware until you serve the food.
- To cook with the pressure cooker, observe the manufacturer's instructions.
- Do not cook food for too long, otherwise the nutrients will be lost. The kitchen clock can be used to set the optimum cooking time.
- For a more healthy cooking result, smoking oil should be avoided.
- To brown food, fry small portions in succession.
- Cookware may reach high temperatures while the food is cooking. We recommend that you use oven gloves.
- You can find recommendations for energy-efficient cooking in section → "Environmental protection"

Cooking table

The table shows which heat setting is suitable for each type of food. The cooking time may vary depending on the type, weight, thickness and quality of the food.

	Heat setting	Cooking time (mins)
Melting		
Chocolate coating	1 - 1.5	-
Butter, honey, gelatine	1 - 2	-
Heating and keeping warm		
Stew, e.g. lentil stew	1.5 - 2	-
Milk*	1.5 - 2.5	-
Heating sausages in water*	3 - 4	-
Defrosting and heating		
Spinach, frozen	3 - 4	15 - 25
Goulash, frozen	3 - 4	35 - 45
Poaching, simmering		
Potato dumplings*	4.5 - 5.5	20 - 30
Fish*	4 - 5	10 - 15
White sauces, e.g. Béchamel sauce	1 - 2	3 - 6
Whisked sauces, e.g. sauce béarnaise, hollandaise	3 - 4	8 - 12
Boiling, steaming, braising		
Rice (with double the volume of water)	2.5 - 3.5	15 - 30
Rice pudding***	2 - 3	30 - 40
Unpeeled boiled potatoes	4.5 - 5.5	25 - 35
Boiled potatoes	4.5 - 5.5	15 - 30
Pasta, noodles*	6 - 7	6 - 10
Stew	3.5 - 4.5	120 - 180
Soups	3.5 - 4.5	15 - 60
Vegetables	2.5 - 3.5	10 - 20
Vegetables, frozen	3.5 - 4.5	7 - 20
Cooking in a pressure cooker	4.5 - 5.5	-
Braising		
Roulades	4 - 5	50 - 65
Pot roast	4 - 5	60 - 100
Goulash***	3 - 4	50 - 60

* Without lid

** Turn several times

*** Preheat to heat setting 8 - 8.5

	Heat setting	Cooking time (mins)
Roasting/frying with little oil*		
Escalope, plain or breaded	6-7	6-10
Escalope, frozen	6-7	8-12
Chop, plain or breaded**	6-7	8-12
Steak (3 cm thick)	7-8	8-12
Poultry breast (2 cm thick)**	5-6	10-20
Poultry breast, frozen**	5-6	10-30
Rissoles (3 cm thick)**	4.5-5.5	20-30
Hamburgers (2 cm thick)**	6-7	10-20
Fish and fish fillet, plain	5-6	8-20
Fish and fish fillet, breaded	6-7	8-20
Fish, breaded and frozen, e.g. fish fingers	6-7	8-15
Scampi, prawns	7-8	4-10
Sautéing fresh vegetables and mushrooms	7-8	10-20
Stir-fry, vegetables, meat cut in Asian-style strips	7-8	15-20
Stir fry, frozen	6-7	6-10
Pancakes (baked in succession)	6.5-7.5	-
Omelette (cooked in succession)	3.5-4.5	3-6
Fried eggs	5-6	3-6
Deep-fat frying* (150-200 g per portion in 1-2 l oil, deep-fat fried in portions)		
Frozen products, e.g. chips, chicken nuggets	8-9	-
Croquettes, frozen	7-8	-
Meat, e.g. chicken portions	6-7	-
Fish, breaded or in beer batter	6-7	-
Vegetables, mushrooms, breaded or battered, tempura	6-7	-
Small baked items, e.g. doughnuts, fruit in batter	4-5	-
* Without lid		
** Turn several times		
*** Preheat to heat setting 8 - 8.5		

Flex Zone

You can use the hob as a single hotplate or as two independent hotplates, as required.

It consists of four inductors that work independently of each other. If using the flexible cooking zone, only the area that is covered by cookware is activated.

Advice on using cookware

To ensure that the cookware is detected and heat is distributed evenly, correctly centre the cookware:

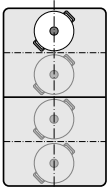
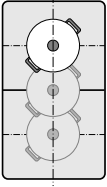
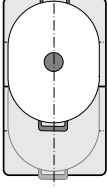
As a single hotplate	
	Diameter smaller than or equal to 13 cm Place the cookware on one of the four positions that can be seen in the illustration.
	Diameter greater than 13 cm Place the cookware on one of the three positions that can be seen in the illustration.
	If the cookware takes up more than one hotplate, place it starting on the upper or lower edge of the flexible cooking zone.

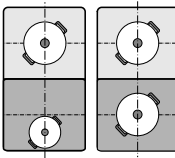
As two independent hotplates	
	The front and rear hotplates each have two inductors and can be used independently of each other. Select the required heat setting for each of the hotplates. Use only one item of cookware on each hotplate.

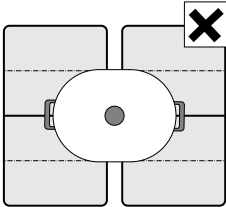
Recommendations	
	If the hob has more than one flexible cooking zone, place the cookware on top so that it covers only one of the flexible cooking zones. Otherwise, the hotplates will not be activated as intended and the cooking result will not be satisfactory.

As two independent hotplates

The flexible cooking zone is used like two independent hotplates.

Activating

See section → "Operating the appliance"

As a single hotplate

Using the entire cooking zone by connecting both hotplates.

Linking the two hotplates

1. Set down the cookware. Select one of the two hotplates assigned to the flexible cooking zone and set the heat setting.
2. Touch the  symbol. The display lights up. The heat setting appears in the display for the lower hotplate.

The flexible cooking zone is activated.

Changing the heat setting

Select one of the two hotplates in the flexible cooking zone and change the heat setting in the settings range.

Adding a new item of cookware

Set the new item of cookware down on the cooker, select one of the two hotplates in the flexible cooking zone and then touch the  symbol twice. The new item of cookware will be detected and the heat setting that was previously selected will be retained.

Note: If the cookware is moved to the hotplate being used or lifted up, the hotplate begins an automatic search and the heat setting selected previously is retained.

Disconnecting the two hotplates

Select one of the two hotplates in the flexible cooking zone and touch the  symbol.

This deactivates the flexible cooking zone. The two hotplates will now function independently.

Notes

- If the hotplate is switched off, and then switched back on again later, the flexible cooking zone is reset to function as two independent hotplates.
- To change the configuration settings for the flexible cooking zone, refer to section → "Basic settings".

Move function

This function activates the entire flexible cooking zone, which is divided into three cooking areas and which has preset heat settings.

Only use one item of cookware. The size of the cooking area depends on the cookware used and whether it is positioned correctly.

Cooking areas

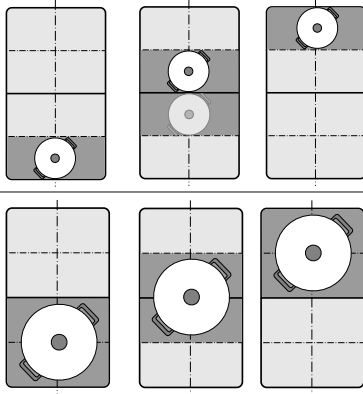

This means that an item of cookware can be moved during the cooking process to another cooking area with another heat setting:

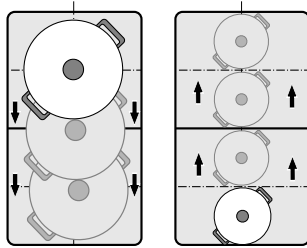

Preset heat settings:

Front area = heat setting **9**

Middle area = heat setting **5**



Rear area = heat setting **1.5**

The preset heat settings can be changed independently of one another. You can find out how to change these in the section on → "Basic settings".

Notes

- If more than one item of cookware is detected on the flexible cooking zone, the function is deactivated.
- If the cookware is moved within the flexible cooking zone or lifted up, the hob automatically starts searching and the heat setting of the area in which the vessel was detected is set.
- You can find information on the size and positioning of the cookware in the section on → "Flex Zone"

Activation

1. Select one of the two hotplates in the flexible cooking zone.
2. Touch the  symbol. The indicator beside the  symbol lights up. The flexible cooking zone is activated as a single hotplate. The heat setting in the area in which the cookware is located lights up in the hotplate display. The function has now been activated.



Changing the heat setting

The heat settings for the individual cooking areas can be changed during the cooking process. Set the cookware down on the cooking area and change the heat setting in the settings range.

Notes

- Only the heat setting in the area in which the cookware is located is changed.
- If the function is deactivated, the heat settings for the three cooking areas are reset to the preset values.

Deactivating

Touch the  symbol. The indicator beside the  symbol goes out.

The function was deactivated.

Note: If one of the cooking areas is set to , the function deactivates after a few seconds.

FlexPlus Zone

The hob has two FlexPlus cooking zones which are located between the two flexible cooking zones and which switch on in conjunction with the right- or left-hand flexible cooking zone. This means that larger cooking vessels can be used and better cooking results can be achieved.

Each FlexPlus cooking zone always switches on in conjunction with the right- or left-hand flexible cooking zone. It is not possible to switch them on independently of one another.

Notes regarding cookware

The cookware should be positioned centrally for good thermal detection and distribution.

The cookware should cover the side hotplate and the FlexPlus cooking zone.

Depending on the size of the cookware, the flexible cooking zone can be activated as two independent hotplates or as one hotplate:

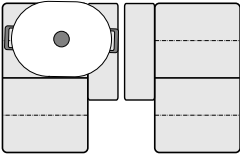
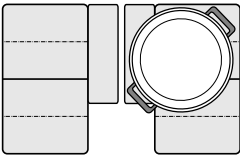
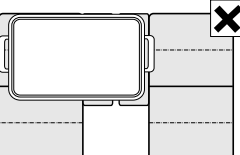
Set down the cookware	
	Elongated cookware: Activate the flexible cooking zone as two independent hotplates or as one hotplate.
	Large round cookware: Activate the flexible cooking zone as a single hotplate.
	The cookware must not cover both FlexPlus cooking zones at the same time.

Activation

1. Set down the cookware on the hotplate and make sure that it also covers the FlexPlus cooking zone.
2. Select the hotplate and the required heat setting. The hotplate and FlexPlus cooking zone indicators light up.

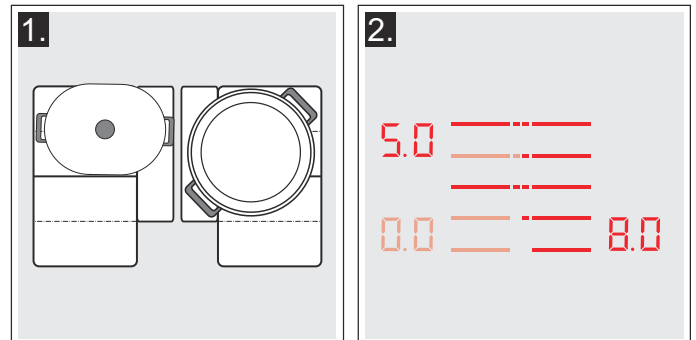

The flexible cooking zone is activated.

Deactivating

Remove the cookware from the hotplate. The displays go out.

This deactivates the FlexPlus cooking zone.

Time-setting options





Your hob has three timer functions:

- Programming the cooking time
- Kitchen timer
- Stopwatch function

Programming the cooking time

The hotplate automatically switches off after the time that is set has elapsed.

Setting procedure:

1. Select the hotplate and the required heat setting.
2. Touch the  symbol. The  symbol and the  indicator light up in the timer display.  lights up in the display for the hotplate.



3. Within the next 10 seconds, set the required cooking time in the settings range.



4. Touch the  symbol to confirm the selected setting.

The cooking time begins to elapse.

Notes

- The same cooking time can be set automatically for all hotplates. The set time for each of the hotplates counts down independently. You can find information on automatically programming the cooking time in section → "Basic settings"
- If the flexible cooking zone is selected as the only hotplate, the set time for the entire cooking zone is the same.
- If the Move function is selected for the combined hotplate, the set time for the three hotplates is the same.

Frying sensor

If a cooking time has been programmed for a hotplate and the frying sensor has been activated, the cooking time will not begin to count down until the selected temperature setting has been reached.

Cooking functions

If a cooking time has been programmed for a hotplate and one of the cooking functions has been activated, the set cooking time will not start to count down until the temperature for the selected area has been reached.



Changing or deleting the time



Select the hotplate and then touch the  symbol.

Change the cooking time in the settings range or set  to delete the programmed cooking time.

Touch the  symbol to confirm the selected setting.

When the time has elapsed

The hotplate switches off, the  display flashes and the hotplate switches to the  heat setting. An audible signal sounds.

 and the  indicator flash in the timer display.

When the  symbol is touched, the indicators go out and the acoustic signal ceases.

Notes





- To set a cooking time of under 10 minutes, always touch **0** before you select the required value.
- If a cooking time was programmed for several hotplates, the time information for the selected hotplate is shown in the timer display.
- Select the relevant hotplate to call up the remaining cooking time.
- You can set a cooking time of up to **99** minutes.

The kitchen timer

You can use the kitchen timer to set a time of up to 99 minutes.

This functions independently from the hotplates and from other settings. This function does not automatically switch off a hotplate.

Setting procedure

1. Touch the  symbol. The  symbol and the  indicator light up in the timer display.
2. Select the required time on the control panel and touch the  symbol to confirm.

After a few seconds, the time begins to elapse.



Changing or deleting the time

Touch the  symbol.

Change the cooking time in the settings range or set  to delete the programmed cooking time.

Touch the  symbol to confirm the selected setting.

When the time has elapsed

An audible signal sounds once the time has elapsed.  and the  symbol flash in the timer display.



The indicators go out after touching the  symbol.

Stopwatch function

The stopwatch function displays the time that has elapsed since activation.

This functions independently from the hotplates and from other settings. This function does not automatically switch off a hotplate.

Activating

Touch the  symbol. The  symbol and the  indicator light up in the timer display.

The cooking time begins to elapse.

Deactivating

Touching the  symbol stops the stopwatch function. The timer displays remain lit.

If you touch the  symbol again, the displays go out.

The function is deactivated.

PowerBoost function

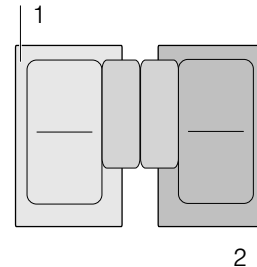

The PowerBoost function enables you to heat up large quantities of water faster than when using heat setting .

This function can always be activated for a hotplate, provided the other hotplate in the same group is not in use (see illustration).





Note: The PowerBoost function can also be activated in the flexible area if the cooking zone is being used as a single hotplate.

Activating

1. Select a hotplate.
2. Touch the  symbol.
The  indicator lights up.
The function is activated.

Deactivating

1. Select a hotplate.
 2. Touch the  symbol.
The  display goes out and the hotplate switches back to heat setting .
- The function is deactivated.

Note: In certain circumstances, the PowerBoost function can switch itself off automatically in order to protect the electronic elements inside the hob.

ShortBoost function

The PowerBoost function enables you to heat cookware faster than when using heat setting 9.

After deactivating the function, select the appropriate heat setting for your food.

This function can always be activated for a hotplate, provided the other hotplate in the same group is not in use (see illustration).

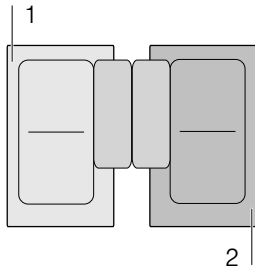



Note: With the flexible cooking zone, the ShortBoost function can be activated even if it is used as the only cooking zone.



Recommendations for use

- Always use cookware that has not been pre-heated.
- Use pots and pans with a flat base. Do not use cookware with a thin base.
- Never leave empty cookware, oil, butter or lard to heat up unattended.
- Do not place a lid on the cookware.
- Place the cookware on the centre of the hotplate. Ensure that the diameter of the base of the cookware corresponds to the size of the hotplate.
- You can find information on the type, size and positioning of the cookware in section → "Induction cooking"

Activating

1. Select a hotplate.
2. Touch the  symbol twice.
The  indicator lights up.
The function is activated.

Deactivating



1. Select a hotplate.
2. Touch the  symbol.
The  display goes out and the hotplate switches back to heat setting 9.
The function is deactivated.

Note: In certain circumstances, the ShortBoost function can switch itself off automatically in order to protect the electronic elements inside the hob.



Keep warm function

This function is suitable for melting chocolate or butter and for keeping food warm.

Activating

1. Select the required heat setting.
2. Within the next 10 seconds, touch the  symbol.
The  indicator lights up.
The function is activated.

Deactivating

1. Select a hotplate.
2. Touch the  symbol.
The  display goes out. The hotplate switches itself off and the residual heat indicator appears.
The function is deactivated.

Transferring settings

This function can be used to transfer the heat setting, the programmed cooking time and the selected cooking function from one hotplate to another.

To transfer the settings, move the cookware from the hotplate which is switched on to another hotplate.

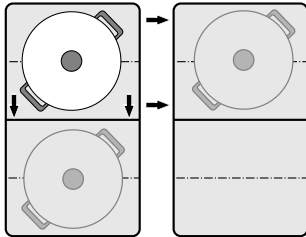

Note: You can find additional information on the positioning of the cookware in the section on → "Flex Zone"

Activation

1. Move the cookware from the hotplate which is switched on to another hotplate.
The heat setting of the original hotplate flashes.
The cookware is detected and the previously selected heat setting and the  symbol flash in the new hotplate display.
2. Select the new hotplate to confirm the settings.
The heat setting of the original hotplate is set to **00**.

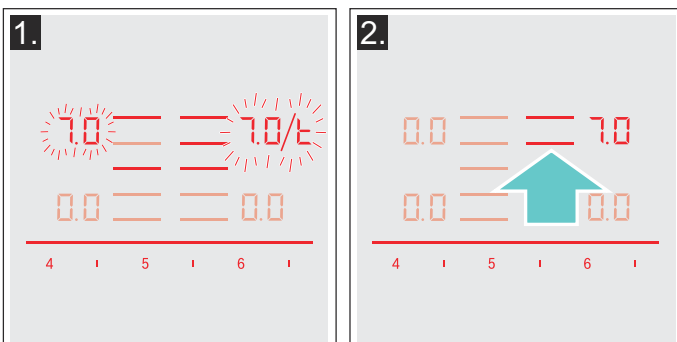

The settings have been transferred to the new hotplate.

Notes

- Move the cookware to a hotplate which is not switched on, which you have not yet preset or on which no other cookware has been placed.
- The PowerBoost or ShortBoost function can then only be moved from left to right or right to left if no hotplate is active.
- If a new item of cookware is set down on another hotplate before the settings have been confirmed, this function is ready for both cooking vessels.
- If several vessels are moved, the function is only ready for the vessel which was last moved.

Cooking assist functions

The cooking assistance functions make cooking easy and always give you excellent results. The recommended temperature settings are suitable for any type of cooking.

They enable you to cook without using excessive heat and promise the perfect cooking and frying results.

Sensors measure the heat of the saucepan or frying pan throughout the cooking process. This ensures that the power is continuously controlled and that the right temperature is maintained.

Food can be added once the selected temperature has been reached. Food will not be overheated and liquids will not boil over.

The hotplates that have a frying sensor are marked with the frying sensor symbol.

The cooking functions are available to all hotplates if a wireless temperature sensor is connected.













In this section, you will find information on:

- Cooking assistant function types
- Suitable cookware
- Sensors and special accessories
- Functions and heat settings
- Recommended dishes
- Preparing and maintaining the wireless temperature sensor

Cooking assistant function types

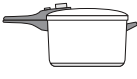
You can use the cooking assistance functions to select the best cooking type for each kind of food.

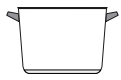
The table shows the various different settings that are available for the cooking assistant functions:

Cooking assistance functions	Temperature settings	Cookware	Availability	Activate
Frying sensor				
Roasting/frying with a small amount of oil	1, 2, 3, 4, 5			
Cooking functions				
Heating/keeping warm	1 / 70 °C		All hotplates	
Poaching	2 / 90 °C		All hotplates	
Cooking	3 / 100 °C		All hotplates	
Cooking in a pressure cooker	4 / 120 °C		All hotplates	
Frying with a large amount of oil in the saucepan*	5 / 170 °C		All hotplates	

*Preheat with the lid on and fry with the lid off.

If the hob does not have a wireless temperature sensor, this can be purchased from specialist retailers or through our technical after-sales service.

Suitable cookware

Select the hotplate the diameter of which most closely matches that of the base of the cookware and place the cookware in the centre of this hotplate.

The cooking functions are not suitable for frying food in a pan like you can with the frying sensor.

There are frying pans that are perfect for using with the frying sensor. These can be purchased from specialist retailers or through our technical after-sales service.

Always quote the relevant reference number:

- HEZ390210 15 cm frying pan.
- HEZ390220 19 cm frying pan.
- HEZ390230 21 cm frying pan.
- HEZ390250 28 cm frying pan. Only recommended for the FlexPlus cooking zone.

These frying pans have a non-stick coating so that you can fry food with a small amount of oil.

Notes

- The frying sensor has been configured specifically for this type and size of frying pan.
- Using a frying pan of a different size or one that is poorly positioned on the flexible cooking zones may result in the frying sensor not being activated. See the section on → "*Flex Zone*".
- Other types of frying pan may overheat and reach a temperature above or below the selected heat setting. Try the lowest heat setting to begin with and change it if necessary.

Any cookware that is suitable for induction cooking can be used with the cooking functions. You can find information on which types of cookware can be used with an induction hob in the section on → "*Induction cooking*".

The cooking assistance functions table lists which cookware is suitable for which functions.

Sensors and special accessories

The sensors measure the heat of the cooking vessel throughout the cooking process. This ensures that the cooking power is controlled with high precision to maintain the right temperature and achieve optimum cooking results.

Your hob has two different temperature measuring systems for achieving the best results:

- Temperature sensors that are located inside the hob and monitor the temperature of the base of the cookware. Suitable for the frying sensor.
- A wireless temperature sensor that transmits the temperature of the cookware to the control panel. Suitable for the cooking functions.

The temperature sensor is essential for using the cooking functions.

If your hob does not have a wireless temperature sensor, this can be purchased from specialist retailers or through our technical after-sales service by quoting the reference number HZ39050.

You can find more information about the temperature sensor in the section on → "*Preparing and maintaining the wireless temperature sensor*"

Functions and heat settings

Frying sensor

You can use the frying sensor when pan-frying food with a small amount of oil.

Hotplates with this function are marked with the frying sensor symbol.

Benefits

- The hotplate only heats up when necessary. This saves energy. Oil and fat will not overheat.
- A signal will sound once the empty frying pan has reached the optimum temperature for adding oil and food.

Notes



- Do not put the lid on the pan as this will prevent the controller from working. You can use a splatter guard to prevent the oil from spitting.
- Use oil or fat that is suitable for frying. If using butter, margarine, cold-pressed olive oil or lard, use temperature setting 1 or 2.
- Never leave a frying pan unattended during heating, regardless of whether or not it contains food.
- If the hotplate is a higher temperature than the cookware or vice versa, the temperature sensor will not be activated correctly.
- Always use the cooking functions when frying with a large amount of oil in the saucepan. "Frying with a large amount of oil in the saucepan", heat setting 5.

Temperature settings

Temperature setting	Suitable for	
1	Very low	Preparing and preserving sauces, sweating vegetables and frying food in extra virgin olive oil, butter or margarine.
2	Low	Frying food using extra virgin olive oil, butter or margarine, e.g. omelettes.
3	Medium - low	Frying fish and Thick food, e.g. meatballs and sausages.
4	Medium - high	Frying steaks, medium or well-done, frozen, breaded and fine foods, e.g. escalope, fresh ragout and vegetables.
5	High	Frying food at high temperatures, e.g. steaks, bloody, potato fritter and Frozen French fries.

Setting procedure

Select the appropriate temperature setting from the table. Place the empty frying pan on the hotplate.

1. Select the hotplate. Touch the  symbol.  lights up in the hotplate display.

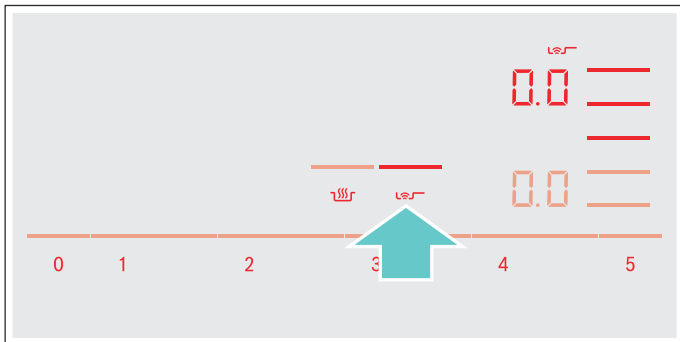

2. Within the next 10 seconds, select the required temperature setting from the settings range.

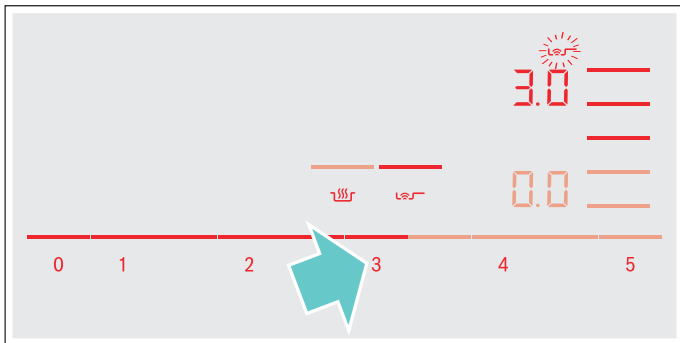

The function has now been activated.

The  temperature symbol flashes until the frying temperature is reached. A signal sounds and the temperature symbol goes out.

3. Once the frying temperature has been reached, add the fat and then the food to the pan.

Note: Turn the food so that it does not burn.

Switching off the frying sensor

Select the hotplate and set it to  in the settings range. The hotplate switches itself off and the residual heat indicator appears.

Cooking functions

You can use these functions to heat, simmer or cook food, or cook it in a pressure cooker or fry it in a saucepan with sufficient oil at a controlled temperature. These cooking functions are available for all hotplates.

Benefits

- The hotplate only heats up when necessary. This saves energy. Oil or fat will not overheat. The temperature is continuously monitored. This prevents the food from spilling over. The temperature does not need to be readjusted.
- A signal will sound once the water or oil has reached the optimum temperature for adding the food. The table shows if a food needs to be added right at the start.

Notes

- Use pots and pans with a flat base. Do not use pots and pans with a thin or domed base.
- Fill the saucepan until its contents are above the silicone patch on the outside of the pan.
- Use the frying sensor when frying with a small amount of oil.
- Position the cookware in such a way that the temperature sensor is pointing towards the outer side of the hob.
- Do not remove the temperature sensor from the saucepan during cooking. Once the cooking process has ended, the functions can be selected for another hotplate.
- Remove the temperature sensor from the saucepan after cooking. Caution: The temperature sensor may be very hot.

Temperature ranges and settings

Cooking functions	Temperature setting	Temperature range	Suitable for
Heating, keeping warm	1/70 °C	60 - 70 °C	E.g. soups, punch
Poaching	2/90 °C	80 - 90 °C	E.g. rice, milk
Cooking	3/100 °C	90 - 100 °C	E.g. pasta, vegetables
Cooking in a pressure cooker	4/120 °C	110 - 120 °C	E.g. chicken, stew.
Frying with a large amount of oil in the saucepan	5/170 °C	170 - 180 °C	E.g. doughnuts, meatballs

Tips for cooking with the cooking functions

- Heating/keep-warm function: Frozen products in portions, e.g. spinach. Place the frozen product in the cookware. Add the quantity of water specified by the manufacturer. Cover the cookware and select the 1/70 °C setting. Stir during cooking.
- Simmering: Thicken food, e.g. sauces. Bring the food to the boil at the recommended temperature. Once the food has thickened, simmer at setting 2/90 °C.
When the signal sounds, keep the food warm at this setting for the required time.
- Boiling: Heat up water with the lid on. It will not boil over. Select temperature setting 3/100 °C.
- Cooking in a pressure cooker function: Follow the manufacturer's recommendations. Continue cooking for the recommended time once the signal has sounded. Select temperature setting 4/120 °C.
- Frying with a large amount of oil in the saucepan function: Heat the oil with the lid on. Once the signal has sounded, take the lid off and add the food. Select temperature setting 5/170 °C.

Notes

- Always cook with the lid on. Exception: "Frying with a large amount of oil in the saucepan", temperature setting 5/170 °C.
- If an audible signal does not sound, make sure that the lid is on the pan.
- Never leave oil unattended during heating. Use oil or fat that is suitable for frying. Do not mix different cooking fats together, e.g. oil and lard. Mixtures of different fats may froth up when hot.
- If you are not satisfied with the cooking result, e.g. when cooking potatoes, next time use less water but keep the recommended temperature setting.

Setting the boiling point

The point at which water starts to boil depends on the height of your home above sea level. You can set the boiling point if water is boiling too strongly or not strongly enough. To do this, proceed as follows:

- Select the basic setting **4**; see the section on → "Basic settings"
- The basic setting is 3 as standard. If your home is between 200 and 400 metres above sea level, there is no need to set the boiling point. If not, choose the correct setting from the following table according to your altitude:

Height	Setting 4
0 - 100 m.	1
100 - 200 m.	2
200 - 400 m.	3*
400 - 600 m.	4
600 - 800 m.	5
800 - 1000 m.	6
1000 - 1200 m.	7
1200 - 1400 m.	8
Above 1400 m.	9
* Basic setting	

Note: Temperature setting 3/100 °C provides efficient cooking even if the water does not bubble very strongly during the heating process. However, if you are not satisfied with the boiling result, you can change the boiling point setting.

Connecting the wireless temperature sensor to the control panel

You will need to connect the wireless temperature sensor to the control panel before using the cooking functions for the first time.

To connect the wireless temperature sensor to the control panel, follow the instructions below:

1. Select the **14** menu; see the section on → "Basic settings"
The hotplate indicator will light up.
2. Select the hotplate and its indicator will light up. A signal will sound. The **14** indicator will light up.
3. Press the **14** symbol on the wireless temperature sensor within 30 seconds.
After a few seconds, the status of the connection between the temperature sensor and the control panel will appear on the hotplate's display.

Status	
0	Connected correctly
1	Not connected correctly: Transmission error.
2	Not connected correctly: Temperature sensor fault.

- The cooking functions are made available once the temperature sensor has been connected to the control panel correctly.
- If there is a fault with the temperature sensor, the connection may not be established correctly for the following reasons:
 - Bluetooth communication error.
 - You did not press the symbol on the temperature sensor within 30 seconds of selecting a hotplate.
 - The battery in the temperature sensor has run out.
 Reset the wireless temperature sensor and follow the connection procedure once again.
- If the temperature sensor and the control panel are not connected correctly due to a transmission error, follow the connection procedure once again. If the display continues to show incorrect connection **1**, contact our technical after-sales service.

Resetting the wireless temperature sensor

1. Touch and hold the **14** symbol for approximately 8-10 seconds.
While you are doing this, the temperature sensor's LED indicator will light up three times. When the LED lights up for the third time, it will start to reset the temperature sensor. At this point, you will need to lift your finger off the symbol.
Once the LED goes out, this means that the wireless temperature sensor has been reset.
2. Repeat the connection procedure from point 2.

Setting procedure

1. Attach the temperature sensor to the saucepan; see the section on → "Preparing and maintaining the wireless temperature sensor"
2. Place a saucepan filled with sufficient liquid on the required hotplate and always put the lid on.
3. Select the hotplate on which you have placed the saucepan with the temperature sensor.
4. Touch the **14** symbol on the temperature sensor. The indicator **14** will light up in the control panel.

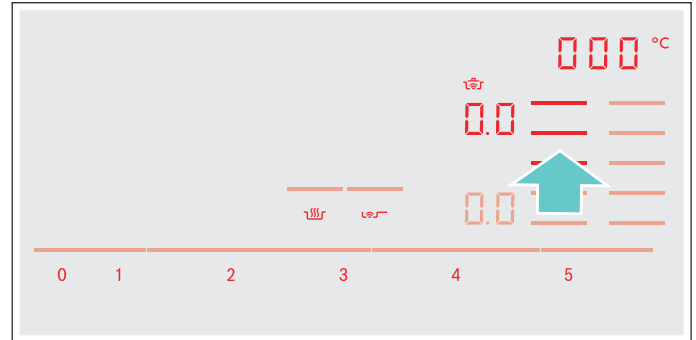

5. Select the right temperature setting from the table.

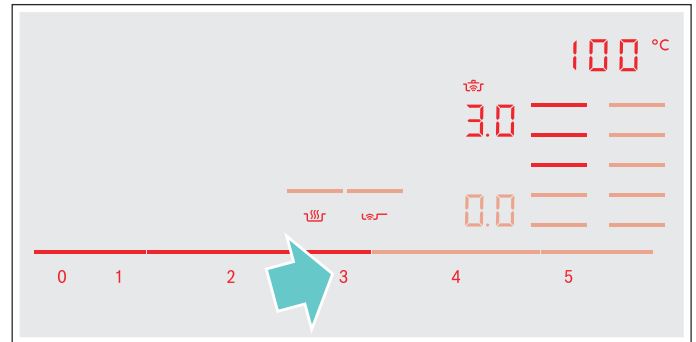

The function has now been activated.

The temperature symbol **14** will flash until the water or oil has reached the right temperature for adding the food. A signal will sound and the temperature symbol will stop flashing.

6. Once the signal has sounded, take the lid off and add the food. Keep the lid on during cooking.
Note: Do not cover the pan when using the "Frying with a large amount of oil in the saucepan" function.

Switching off cooking functions

Select the hotplate and set it to **0.0** on the control panel. The hotplate will switch off and the residual heat indicator will appear.

Note: To re-activate the cooking functions, wait for approximately 10 seconds.

Recommended dishes

The following table shows a selection of dishes and is arranged by food type. The temperature and the cooking time depend on the amount, the condition and the quality of the food.

Meat	Cooking assistance functions	Temperature setting	Total cooking time from signal (mins)
Frying with a small amount of oil function			
Escalope, plain or breaded	Frying sensor	4	6 - 10
Fillet	Frying sensor	4	6 - 10
Chop*	Frying sensor	3	10 - 15
Cordon bleu, Wiener Schnitzel*	Frying sensor	4	10 - 15
Steak, rare (3 cm thick)	Frying sensor	5	6 - 8
Steak, medium or well-done (3 cm thick)	Frying sensor	4	8 - 12
Poultry breast (2 cm thick)*	Frying sensor	3	10 - 20
Sausages, pre-boiled or raw*	Frying sensor	3	8 - 20
Hamburgers, meatballs, stuffed meat roulades*	Frying sensor	3	6 - 30
Meat loaf	Frying sensor	2	6 - 9
Ragoût, gyros	Frying sensor	4	7 - 12
Minced meat	Frying sensor	4	6 - 10
Bacon	Frying sensor	2	5 - 8
Poaching function			
Sausages	Cooking functions	2/90 °C	10 - 20
Cooking function			
Meatballs	Cooking functions	3/100 °C	20 - 30
Stewing poultry	Cooking functions	3/100 °C	60 - 90
Viennese boiled beef	Cooking functions	3/100 °C	60 - 90
Cooking in a pressure cooker function			
Chicken, veal***	Cooking functions	4/120 °C	15 - 25
Frying with a large amount of oil function			
Chicken portions, meatballs**	Cooking functions	5/170 °C	10 - 15

* Turn several times.

** Heat the oil with the lid on. Fry in portions with the lid off (see table for cooking time per portion).

*** Add the food straight away.

Fish	Cooking assistance functions	Temperature setting	Total cooking time from signal (mins)
Frying with a small amount of oil function			
Fried whole fish, e.g. trout	Frying sensor	3	10 - 20
Fish fillet, plain or breaded	Frying sensor	3 - 4	10 - 20
Scampi, prawns	Frying sensor	4	4 - 8
Poaching function			
Steamed fish, e.g. hake	Cooking functions	2/90 °C	15 - 20
Frying with a large amount of oil function			
Fish, beer-battered or breaded	Cooking functions	5/170 °C	10 - 15

* Heat the oil with the lid on. Fry one portion after the other with the lid off (the table shows the time required for each portion).

Egg-based dishes	Cooking assistance functions	Temperature setting	Total cooking time from signal (mins)
Frying with a small amount of oil function			
Crêpes*	Frying sensor	5	-
Omelette*	Frying sensor	2	3 - 6
Fried eggs	Frying sensor	2 - 4	2 - 6
Scrambled eggs	Frying sensor	2	4 - 9
Kaiserschmarrn (shredded pancake)	Frying sensor	3	10 - 15
French toast	Frying sensor	3	4 - 8
Cooking function			
Hard-boiled eggs**	Cooking functions	3/100 °C	5 - 10

* Total time for each portion. Fry one after the other.

** Add the food straight away.

Vegetables and pulses	Cooking assistance functions	Temperature setting	Total cooking time from signal (mins)
Frying with a small amount of oil function			
Garlic, onions	Frying sensor	1 - 2	2 - 10
Courgettes, aubergines	Frying sensor	3	4 - 12
Peppers, green asparagus	Frying sensor	3	4 - 15
Vegetables sautéed in oil, e.g. courgettes, green peppers	Frying sensor	1	10 - 20
Mushrooms	Frying sensor	4	10 - 15
Glazed vegetables	Frying sensor	3	6 - 10
Cooking function			
Fresh vegetables, e.g. broccoli	Cooking functions	3 / 100 °C	10 - 20
Fresh vegetables, e.g. Brussels sprouts	Cooking functions	3 / 100 °C	30 - 40
Chickpeas*	Cooking functions	3 / 100 °C	60 - 90
Peas	Cooking functions	3 / 100 °C	15 - 20
Lentil stew*	Cooking functions	3 / 100 °C	45 - 60
Cooking in a pressure cooker function*			
Vegetables, e.g. green beans	Cooking functions	4 / 120 °C	3 - 6
Chickpeas, beans	Cooking functions	4 / 120 °C	25 - 35
Lentil stew	Cooking functions	4 / 120 °C	10 - 20
Frying with a large amount of oil function			
Vegetables and mushrooms, breaded or beer-battered*	Cooking functions	5 / 170 °C	4 - 8

* Add the food straight away.

** Heat the oil with the lid on. Fry one portion after the other with the lid off (the table shows the time required per portion).

Potatoes	Cooking assistance functions	Temperature setting	Total cooking time from signal (mins)
Frying with a small amount of oil function			
Fried potatoes (made from potatoes boiled in their skins)	Frying sensor	5	6 - 12
Fried potatoes (made from raw potatoes)	Frying sensor	4	15 - 25
Potato rösti*	Frying sensor	5	2.5 - 3.5
Swiss rösti	Frying sensor	1	50 - 55
Glazed potatoes	Frying sensor	3	15 - 20
Poaching function			
Potato dumplings	Cooking functions	2 / 90 °C	30 - 40
Cooking function			
Potatoes**	Cooking functions	3 / 100 °C	30 - 45
Cooking in a pressure cooker function			
Potatoes**	Cooking functions	4 / 120 °C	10 - 20
* Total time for each portion. Fry one after the other.			
** Add the food straight away.			

Pasta and cereals	Cooking assistance functions	Temperature setting	Total cooking time from signal (mins)
Poaching function			
Rice	Cooking functions	2 / 90 °C	25 - 35
Polenta*	Cooking functions	2 / 90 °C	3 - 8
Semolina pudding	Cooking functions	2 / 90 °C	5 - 10
Cooking function			
Noodles	Cooking functions	3 / 100 °C	7 - 10
Stuffed pasta or dumplings	Cooking functions	3 / 100 °C	6 - 15
Cooking in a pressure cooker function			
Rice**	Cooking functions	4 / 120 °C	5 - 8
* Heat up with the lid on; cook with the lid off and stir frequently.			
** Add the food straight away.			

Soups	Cooking assistance functions	Temperature setting	Total cooking time from signal (mins)
Poaching function			
Instant soups, e.g. creamy soups	Cooking functions	2 / 90 °C	10 - 15
Cooking function			
Homemade broths, e.g. meat or vegetable soups**	Cooking functions	3 / 100 °C	60 - 90
Instant soups, e.g. minestrone	Cooking functions	3 / 100 °C	5 - 10
Cooking in a pressure cooker function			
Homemade broths, e.g. vegetable soups**	Cooking functions	4 / 120 °C	3 - 6
* Stir frequently.			
** Add the food straight away.			

Sauces	Cooking assistance functions	Temperature setting	Total cooking time from signal (mins)
Frying with a small amount of oil function			
Tomato sauce with vegetables	Frying sensor	1	25 - 35
Béchamel sauce	Frying sensor	1	10 - 20
Cheese sauce, e.g. Gorgonzola sauce	Frying sensor	1	10 - 20
Reducing sauces, e.g. tomato sauce, bolognese sauce	Frying sensor	1	25 - 35
Sweet sauces, e.g. orange sauce	Frying sensor	1	15 - 25

Desserts	Cooking assistance functions	Temperature setting	Total cooking time from signal (mins)
Poaching function			
Rice pudding*	Cooking functions	2 / 90 °C	40 - 50
Porridge	Cooking functions	2 / 90 °C	10 - 15
Compote**	Cooking functions	3 / 100 °C	15 - 25
Chocolate pudding***	Cooking functions	2 / 90 °C	3 - 5

Frying with a large amount of oil function			
Patisserie, e.g. ring or filled doughnuts****	Cooking functions	5 / 170 °C	5 - 10

* Stir frequently.

** Add the food straight away.

*** Heat up with the lid on; cook with the lid off and stir frequently.

**** Heat the oil with the lid on. Fry one portion after the other with the lid off (the table shows the time required per portion).

Frozen products	Cooking assistance functions	Temperature setting	Total cooking time from signal (mins)
Frying with a small amount of oil function			
Escalope	Frying sensor	4	15 - 20
Cordon bleu*	Frying sensor	4	10 - 30
Poultry breast*	Frying sensor	4	10 - 30
Chicken nuggets	Frying sensor	4	10 - 15
Gyros, kebab	Frying sensor	3	5 - 10
Fish fillet, plain or breaded	Frying sensor	3	10 - 20
Fish fingers	Frying sensor	4	8 - 12
Roast potatoes	Frying sensor	5	4 - 6
Stir fries, e.g. stir-fried vegetables with chicken	Frying sensor	3	6 - 10
Spring rolls	Frying sensor	4	10 - 30
Camembert/cheese	Frying sensor	3	10 - 15
Heating/keep-warm function			
Frozen vegetables in a creamy sauce, e.g. cream of spinach**	Cooking functions	1 / 70 °C	15 - 20
Cooking function			
Frozen vegetables, e.g. green beans**	Cooking functions	3 / 100 °C	15 - 30
Frying with a large amount of oil function			
Frozen chips***	Cooking functions	5 / 170 °C	4 - 8

* Turn several times.

** Add liquid according to the manufacturer's instructions.

*** Heat the oil with the lid on. Fry in portions with the lid off (see table for cooking time per portion).

Further	cooking assistance functions	Temperature setting	Total cooking time from signal (mins)
Frying with a small amount of oil function			
Camembert/cheese	Frying sensor	3	7 - 10
Precooked dry products that require water to be added, e.g. pasta	Frying sensor	1	5 - 10
Croutons	Frying sensor	3	6 - 10
Almonds/nuts/pine nuts	Frying sensor	4	3 - 15
Heating/keep-warm function			
Food in jars and tins, e.g. goulash soup	Cooking functions	1 / 70 °C	10 - 20
Mulled wine**	Cooking functions	1 / 70 °C	-
Poaching function			
Milk**	Cooking functions	2 / 90 °C	-

* Add the food straight away and stir frequently.
 ** Add the food straight away.

Preparing and maintaining the wireless temperature sensor

In this section, you will find information on:

- Adhering the silicone patch
- Using the wireless temperature sensor
- Cleaning
- Changing the battery

Optional accessories, such as the silicone patch and temperature sensor, can be purchased from specialist retailers or through our technical after-sales service. Please quote the relevant reference number when doing this:

00577921	Set of 5 silicone patches
HEZ39050	Temperature sensor and set of 5 silicone patches

Adhering the silicone patch

The silicone patch attaches the temperature sensor to the cookware.

A silicone patch must be adhered when using a saucepan with the cooking functions for the first time.

Proceed as follows:

1. The adhesion point on the saucepan must be free of grease. Clean the saucepan, dry it thoroughly and wipe the adhesion point with a degreasing agent such as spirit.

2. Remove the protective film from the silicone patch. Adhere the silicone patch to the saucepan in the correct place using the enclosed template as a guide.

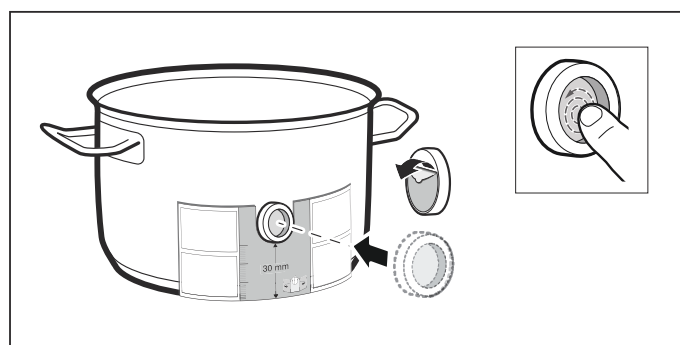

3. Press the silicone patch down, including its inside surface. The adhesive requires 1 hour to fully harden. The cookware must not be used or cleaned during this time.

Notes

- Cookware with the silicone patch must not be left to soak for long periods in soapy water.
- If the silicone patch comes off, attach a new one.

Using the wireless temperature sensor

Attach the temperature sensor to the silicone patch and align it correctly.

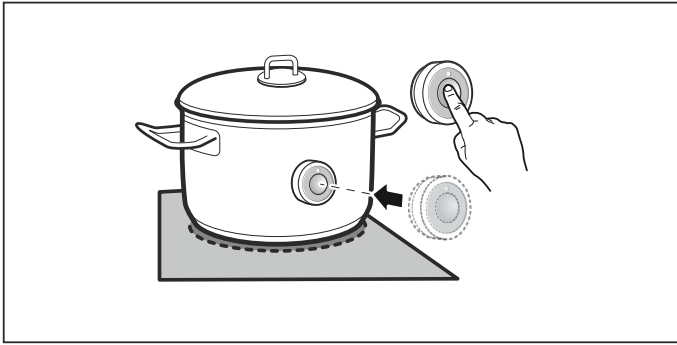

Notes

- Make sure that the silicone patch is completely dry before attaching the temperature sensor.
- Position the cookware in such a way that the temperature sensor is pointing towards the outer side of the hob.
- To prevent overheating, the temperature sensor must not be pointed towards another item of cookware that is hot.
- Remove the temperature sensor from the saucepan after cooking. Store it in a clean, safe place away from sources of heat.

Cleaning

Do not clean the wireless temperature sensor in the dishwasher.

You can find information on cleaning the temperature sensor in the section on → "Cleaning"

Changing the battery

If you press the wireless temperature sensor symbol and the LED does not light up, the battery is flat.

Changing the battery:

1. Remove the silicone cover from the lower section of the casing. Unscrew the screws with a screwdriver.

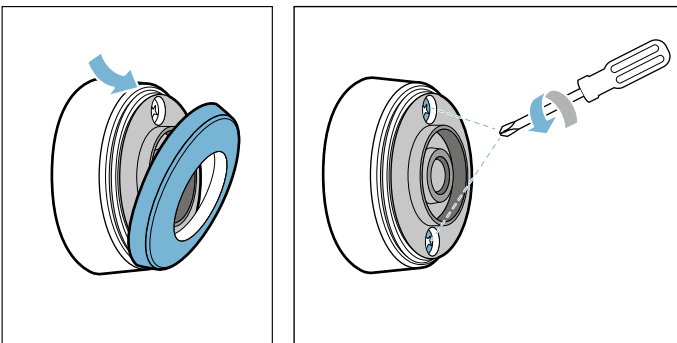

2. Remove the upper section of the casing. Take the old batteries out. Put the new batteries in. Make sure that the polarity is correct.

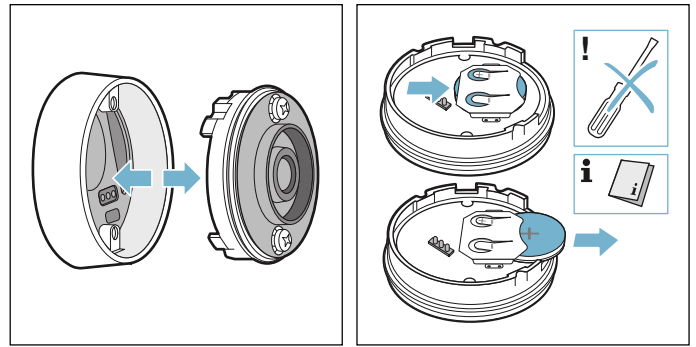

Caution!

Do not use metal objects to remove the battery. Do not touch the contacts.

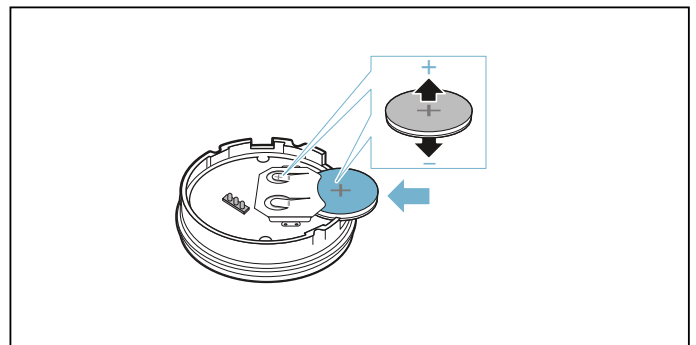

3. Put the upper and lower sections of the casing back together. Make sure that the contact pins are aligned correctly.

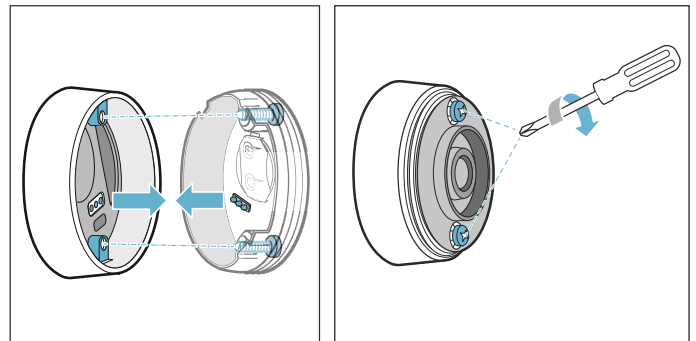

4. Put the silicone cover back on the lower section of the temperature sensor casing.

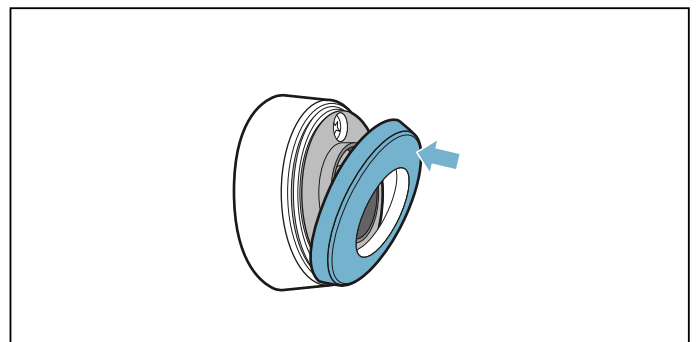

Note: Only use premium-quality CR2032 batteries. These have an especially long service life.

Declaration of Conformity

Robert Bosch Hausgeräte GmbH hereby declares that the appliance with wireless temperature sensor function meets the basic requirements and other relevant provisions of the Directive 1999/5/EG.

A detailed R&TTE Declaration of Conformity can be found online at www.bosch-home.com on the product page for your appliance under "Additional documents".

The logos and the Bluetooth® brand are registered trademarks and property of Bluetooth SIG, Inc. These trademarks are used by Robert Bosch Hausgeräte GmbH under licence. All other trademarks and brand names are owned by the respective companies.



Childproof lock

You can use the childproof lock to prevent children from switching on the hob.

Activating and deactivating the childproof lock

The hob must be switched off.

To activate:

1. Switch on the hob using the main switch.
2. Touch the  symbol for approx. 4 seconds.
The  indicator lights up for 10 seconds.

The hob is locked.

To deactivate:

1. Switch on the hob using the main switch.
2. Touch the  symbol for approx. 4 seconds.

The lock is released.

Childproof lock

With this function, the childproof lock automatically activates when a hob is switched off.

Switching on and off

You can find out how to switch the automatic childproof lock on in the → "*Basic settings*" section

Wipe protection

If you wipe over the control panel while the hob is switched on, settings may be altered. To avoid doing this, you can use the hob's "Lock control panel for cleaning" function.

To switch on: Touch the  symbol. An audible signal sounds. The control panel is locked for 35 seconds. You can now wipe over the surface of the control panel without altering any settings.

To deactivate: The control panel will be unlocked once 35 seconds have elapsed. To release the function early, touch the  symbol.

Notes

- An audible signal sounds 30 seconds after activation. This indicates that the function is about to finish.
- The cleaning lock does not lock the main switch. The hob can be switched off at any time.

Automatic safety cut-out

If a hotplate operates for an extended period and no settings are changed, the automatic safety shut-off is activated.

The hotplate stops heating. **FE** and the residual heat indicator **h** or **H** flash alternately in the hotplate display.

When you touch any symbol, the display switches off. The hotplate can now be set again.

The point at which the safety shut-off becomes active depends on which heat setting has been set (after 1 to 10 hours).

Basic settings

The appliance has various basic settings. You can adapt these to suit your cooking habits.

Display	Function
c 1	Automatic childproof lock 0 Manual*. 1 Automatic. 2 Function deactivated.
c 2	Audible signals 0 Confirmation and fault signals are switched off. 1 Only the fault signal is switched on. 2 Only the confirmation signal is switched on. 3 All signal tones are switched on.*
c 3	Display energy consumption 0 Switched off.* 1 Switched on.
c 4	Set according to height above sea level 1-2 Decreased 3 Basic setting 4-9 Increased
c 5	Automatically programming the cooking time 00 Switched off.* 0 1-99 Time until automatic switch-off.
c 6	Duration of the timer-end signal tone 1 10 seconds.* 2 30 seconds. 3 1 minute.
c 7	Power management function. Limiting the total power of the hob 0 Switched off.* 1 1000 W minimum power. 1. 1500 W. 2 2000 W. ... 9 or 9. Maximum power of the hob.
c 11	Changing the preset heat settings for the Move function -9 Preset heat setting for the front cooking zone. -5 Preset heat setting for the central cooking zone. -1. Preset heat setting for the rear cooking zone.
c 12	Checking cookware and cooking results 0 Not suitable 1 Not perfect 2 Suitable

* Factory settings

Display	Function
c 13	Configuring activation of the flexible cooking zone 0 As two independent hotplates.* 1 As a single hotplate.
c 14	Connecting the wireless temperature sensor to the hob 0 Connected correctly 1 Not connected correctly: Transmission error. 2 Not connected correctly: Temperature sensor fault.
c 0	Restoring the factory settings 0 Individual settings.* 1 Restore factory settings.

* Factory settings

To access the basic settings:

The hob must be off.

1. Switch on the hob.
2. Within ten seconds, touch and hold the  symbol for approximately four seconds. The first four displays provide product information. Touch the settings area to view the individual displays.

Product information	Display screen
After-sales service index (ASSI)	01
Production number	Fd
Production number 1	95.
Production number 2	05

3. Touching the  symbol again takes you to the basic settings. c 1 and 0 light up as a preset in the displays.

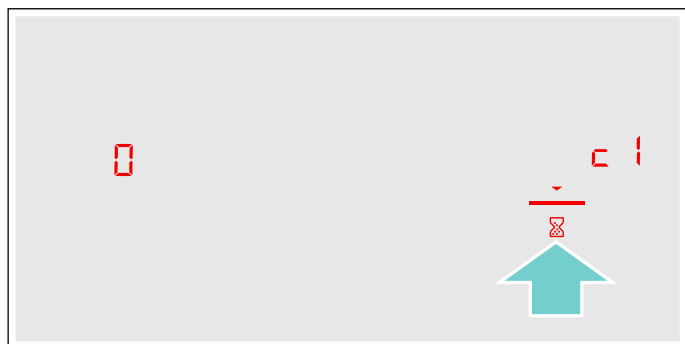

4. Touch the  symbol repeatedly until the required function is displayed.

5. Then select the required setting from the settings area.



6. Touch the  symbol for at least four seconds.

The settings have been saved.

Leaving the basic settings

Turn off the hob with the main switch.

Energy consumption indicator

This function indicates the total amount of energy consumed by this hob the last time it was used for cooking.

Once switched off, the energy consumption in kWh is displayed for 10 seconds.

The picture shows an example with an energy consumption of **1.08 kWh**.

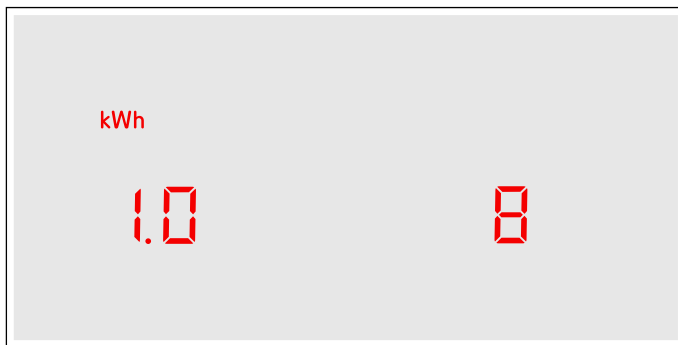

You can find out how to switch this function on in the section on → "Basic settings"

Cookware check

This function can be used to check the speed and quality of the cooking process depending on the cookware.

The result is a reference value and depends on the properties of the cookware and the hotplate being used.

1. With the cookware still cold, fill it with approx. 200 ml of water and place it on the centre of the hotplate with the diameter that most closely matches that of the base of the cookware.
2. Go to the basic settings and select the **C 12** setting.
3. Touch the settings range. **-** will flash on the hotplate display.

The function has now been activated.

After 10 seconds, the result for the quality and speed of the cooking process will appear on the hotplate display.

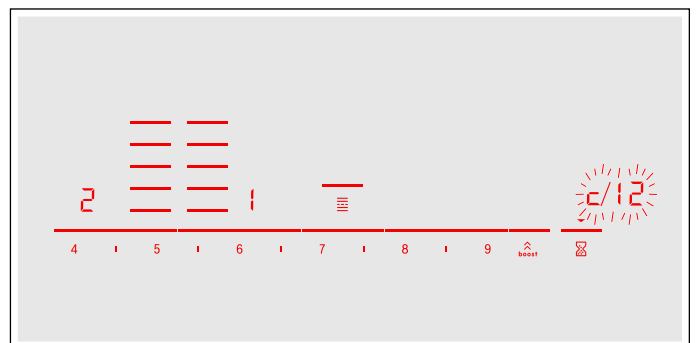

Check the result using the following table:

Result

0	The cookware is not suitable for the hotplate and will therefore not heat up.*
1	The cookware is taking longer to heat up than expected and the cooking process is not going as well as it should.*
2	The cookware is heating up correctly and the cooking process is going well.

* If there is a smaller hotplate available, test the cookware again on the smaller hotplate.

To reactivate this function, touch the settings range.

Notes

- The flexible cooking zone only counts as a single hotplate; place no more than one item of cookware on it.
- If the diameter of the hotplate used is much smaller than the diameter of the cookware, only the middle of the cookware can be expected to heat up. This may result in the cooking results not being as good as expected or being less than satisfactory.
- You can find information on this function in the section on → "Basic settings".
- You can find information on the type, size and positioning of the cookware in the sections on → "Induction cooking" and → "Flex Zone".

Cleaning

Suitable maintenance and cleaning products can be purchased from the after-sales service or in our e-Shop.

Hob

Cleaning

Always clean the hob after cooking. This will prevent food deposits from becoming burned on. Only clean the hob after the residual heat indicator has gone out.

Clean the hob with a damp dish cloth and dry it with a cloth or towel to prevent limescale build-up.

Only use cleaning agents that are suitable for this type of hob. Observe the manufacturer's instructions on the product packaging.

Never use:

- Undiluted washing-up liquid
- Cleaning agents designed for dishwashers
- Abrasive cleaners
- Harsh cleaning agents, such as oven spray and limescale remover
- Scouring pads
- High-pressure cleaners or steam jet cleaners

Stubborn dirt is best removed with a glass scraper, available from retailers. Observe the manufacturer's instructions.

You can obtain a suitable glass scraper from customer services or through our online shop.

Using a special sponge for cleaning glass-ceramic hobs achieves a great cleaning result.

Potential marks

Limescale and water marks	Clean the hob as soon as it has cooled down. You can use a cleaning agent suitable for glass-ceramic hobs.*
Sugar, rice starch or plastic	Clean immediately. Use a glass scraper. Caution: Risk of burns.*

* Then clean with a damp dish cloth and dry with a cloth or towel.

Note: Do not use any cleaning agents while the hob is still hot. This may mark the surface. Make sure that any residue left by cleaning agents is removed.

Hob surround

To prevent damage to the hob surround, observe the following instructions:

- Only use warm soapy water
- Wash new dish cloths thoroughly before use.
- Do not use harsh or abrasive cleaning agents.
- Do not use a glass scraper or sharp objects.

Wireless temperature sensor

Temperature sensor

Clean the temperature sensor with a damp cloth. Never clean it in the dishwasher. Do not immerse it in water or clean it under running water.

Remove the temperature sensor from the saucepan after cooking. Store it in a clean, safe place (such as in its packaging) away from sources of heat.

Silicone patch

Clean and dry before attaching to the temperature sensor. Dishwasher safe.

Note: Cookware with the silicone patch must not be left to soak for long periods in soapy water.

Temperature sensor window

The sensor window must always be clean and dry. Proceed as follows:

- Remove dirt and oil splatters regularly.
- Use a soft cloth or cotton buds and window cleaner for cleaning.

Notes

- Do not use abrasive cleaning agents such as scouring pads, scrubbing brushes or cream cleaners.
- Do not touch the sensor window with your fingers. This may make it dirty or scratch it.

Frequently Asked Questions (FAQ)

Using the appliance

Why can't I switch on the hob and why is the childproof lock symbol lit?

The childproof lock is activated.

You can find information on this function in the section on → "*Childproof lock*"

Why are the displays flashing and why can I hear an audible signal?

Remove any liquid or food remains from the control panel. Remove any objects from the control panel.

You can find instructions on how to deactivate the audible signal in the section on → "*Basic settings*"

Noises

Why I can hear noises while I'm cooking?

Noises may be generated while using the hob depending on the base material of the cookware. These noises are a normal part of induction technology. They do not indicate a defect.

Possible noises:

A low humming noise like the one a transformer makes:

Occurs when cooking at a high heat setting. The noise disappears or becomes quieter when the heat setting is reduced.

Low whistling noise:

Occurs when the cookware is empty. This noise disappears when water or food is added to the cookware.

Crackling:

Occurs when using cookware made from different layers of material or when using cookware of different sizes and different materials at the same time. The loudness of the noise can vary depending on the quantity of food being cooked or the cooking method.

High-pitched whistling noises:

Can occur when two hotplates are used at the highest heat setting at the same time. The whistling noises disappear or become quieter when the heat setting is reduced.

Fan noise:

The hob is equipped with a fan that switches on automatically at high temperatures. The fan may continue to run even after you have switched off the hob if the temperature detected is still too high.

Cookware

Which types of cookware can be used with an induction hob?

You can find information on which types of cookware can be used with an induction hob in the section on → "*Induction cooking*".

Why is the hotplate not heating up and why is the heat setting flashing?

The hotplate on which the cookware is standing is not switched on.

Check that you have switched on the correct hotplate.

The cookware is too small for the hotplate that is switched on or it is not suitable for induction cooking.

Check that the cookware is suitable for induction cooking and that it is placed on the hotplate that best corresponds to its size. You can find information on the type, size and positioning of cookware in the sections on → "*Induction cooking*", → "*Flex Zone*" and → "*Move function*".

Why is it taking so long for the cookware to heat up or why is it not heating up sufficiently despite being on a high heat setting?

The cookware is too small for the hotplate that is switched on or it is not suitable for induction cooking.

Check that the cookware is suitable for induction cooking and that it is placed on the hotplate that best corresponds to its size. You can find information on the type, size and positioning of cookware in the sections on → "*Induction cooking*", → "*Flex Zone*" and → "*Move function*".

Cleaning

How do I clean the hob?

Using a special glass-ceramic cleaning agent produces the best results. We advise against using harsh or abrasive cleaning agents, dishwasher detergent (concentrated) or scouring pads.

You can find more information on cleaning and caring for your hob in the section on → "Cleaning"

? Trouble shooting

Usually, faults are small matters that are easy to eliminate. Please read the information in the table before calling the after-sales service.

Indicator	Possible cause	Remedial action
None	The power supply has been disconnected. The device has not been connected as shown in the circuit diagram. Fault in the electronics.	Use other electrical devices to check whether a short-circuit has occurred in the power supply. Check that the device has been connected as shown in the circuit diagram. If the fault cannot be rectified, inform the technical after-sales service.
The indicators are flashing	The control panel is damp or an object is covering it.	Dry the control panel or remove the object.
The — indicator is flashing in the hotplate displays	A fault has occurred in the electronics.	To acknowledge the fault, briefly cover the control panel with your hand.
<i>F2/E8207</i>	The electronics have overheated and switched off the relevant hotplate.	Wait until the electronics have cooled down sufficiently. Then touch any symbol on the hob.
<i>F4/E8208</i>	The electronics have overheated and all the hotplates have been switched off.	
<i>F5</i> + heat setting and signal	There is a hot saucepan in the control panel area. There is a risk that the electronics will overheat.	Remove the saucepan. The fault indicator will go out shortly afterwards. You can continue cooking.
<i>F5</i> and signal	There is a hot saucepan in the control panel area. The hotplate has been switched off to protect the electronics.	Remove the saucepan. Wait a few seconds. Touch any control. You can continue cooking once the fault indicator has gone out.
<i>F1/F6</i>	The hotplate has overheated and been switched off to protect the work surface.	Wait until the electronics have cooled down sufficiently before switching the hotplate on again.
<i>F0</i>	You cannot activate the transfer settings function	Check the fault indicator by touching any control. You can cook as usual without using the transfer settings function. Contact the technical after-sales service.
<i>F9</i>	You cannot activate the FlexPlus cooking zone	Check the fault indicator by touching any control. You can use the remaining hotplates to cook as usual. Contact the technical after-sales service.
<i>F8</i>	The hotplate has been operating continuously for an extended period.	The automatic safety switch-off function has been activated. See the section on → "Automatic safety cut-out"
<i>E8202</i>	The temperature sensor has overheated and the hotplate has been switched off.	Wait until the temperature sensor has cooled down sufficiently before activating the function again.
<i>E8203</i>	The temperature sensor has overheated and all the hotplates have been switched off.	If you are not using the temperature sensor, remove it from the cookware and store it far away from the other hotplates and sources of heat. Switch the hotplate back on.
<i>E8204</i>	The battery in the temperature sensor is flat.	Change the 3V CR2032 battery. See the section on → "Changing the battery"
<i>E8205</i>	The temperature sensor is disconnected.	Switch the function off and on again.
<i>E8206</i>	The temperature sensor is broken/faulty.	Contact the technical after-sales service.

Do not place hot pans on the control panel.

Indicator	Possible cause	Remedial action
The temperature sensor indicator is not lighting up	The temperature sensor is not reacting and the indicator is not lighting up.	Change the 3V CR2032 battery. See the section on → "Changing the battery" If this does not solve the problem, press and hold the temperature sensor button for 8 minutes and then reconnect the temperature sensor to the hob. If the problem persists, contact the technical after-sales service.
The indicator on the temperature sensor flashes twice.	The battery in the temperature sensor has almost run out. You may be interrupted the next time you cook by the battery running out.	Change the 3V CR2032 battery. See the section on → "Changing the battery"
The indicator on the temperature sensor flashes three times.	The temperature sensor is disconnected.	Press and hold the symbol on the temperature sensor for 8 seconds and then reconnect the temperature sensor to the hob.
E9000 E90 10	The operating voltage is incorrect/outside of the normal operating range.	Contact your electricity supplier.
U400	The hob is not connected properly	Disconnect the hob from the power supply. Check that it has been connected as shown in the circuit diagram.
dE	Demo mode is activated	Disconnect the hob from the power supply. Wait for 30 seconds before reconnecting it. Touch any touch control in the next 3 minutes. Demo mode is now deactivated.

Do not place hot pans on the control panel.

Notes

- If **E** appears in the display, the sensor for the relevant hotplate must be pressed and held in order to read the fault code.
- If the fault code is not listed in the table, disconnect the hob from the power supply, wait 30 seconds and connect it again. If the display appears again, contact technical after-sales and tell them the precise fault code.



Customer service

Our after-sales service is there for you if your appliance needs to be repaired. We will always find an appropriate solution, also in order to avoid after-sales personnel having to make unnecessary visits.

E number and FD number

Please quote the E number (product number) and the FD number (production number) of your appliance when contacting the after-sales service.

The rating plate bearing these numbers can be found:

- On the appliance certificate.
- On the lower section of the hob.

The E-number can also be found on the glass surface of the hob. You can check the customer index (KI) and FD number by going to the basic settings. Look up section → "Basic settings" for this.

Please note that a visit from an after-sales service engineer is not free of charge in the event of misuse of the appliance, even during the warranty period.

Please find the contact data of all countries in the enclosed customer service list.

To book an engineer visit and product advice

GB 0344 892 8979

Calls charged at local or mobile rate.

IE 01450 2655

0.03 € per minute at peak. Off peak 0.0088 € per minute.

Rely on the professionalism of the manufacturer. You can therefore be sure that the repair is carried out by trained service technicians who carry original spare parts for your appliances.

Test dishes

This table has been produced for test institutes to facilitate the testing of our appliances.

The data in the table refers to our Schulte-Ufer cookware accessories (4 piece cookware set for the HEZ 390042 induction hob) with the following measurements:

- Saucepan Ø 16 cm, 1.2 l for hotplates of Ø 14.5 cm
- Pot Ø 16 cm, 1.7 l for hotplates of Ø 14.5 cm
- Pot Ø 22 cm, 4.2 l for hotplates of Ø 18 cm
- Frying pan Ø 24 cm, for hotplates of Ø 18 cm

Test dishes	Cookware	Heat setting	Preheating		Cooking		
			Cooking time (min:sec)	Lid	Heat setting	Lid	
Melting chocolate							
Chocolate coating (e.g. Dr. Oetker brand, dark chocolate 55% cocoa, 150 g)	Saucepan, 16 cm diameter	-	-	-	1.5	No	
Heating and keeping lentil stew warm							
Lentil stew*							
Initial temperature 20 °C							
Amount: 450 g	Cooking pot, 16 cm diameter	9	1:30 (without stirring)	Yes	1.5	Yes	
Amount: 800 g	Saucepan, 22 cm diameter	9	2:30 (without stirring)	Yes	1.5	Yes	
Lentil stew from a tin							
E.g lentils with Erasco sausages.							
Initial temperature 20 °C							
Amount: 500 g	Cooking pot, 16 cm diameter	9	Approx. 1:30 (stir after approx. 1 minute)	Yes	1.5	Yes	
Amount: 1 kg	Saucepan, 22 cm diameter	9	Approx. 2:30 (stir after approx. 1 minute)	Yes	1.5	Yes	
Preparing Béchamel sauce							
Temperature of the milk: 7 °C							
Ingredients: 40 g butter, 40 g flour, 0.5 l milk (3.5% fat content) and a pinch of salt							
1. Melt the butter, stir in the flour and salt, and heat up the mixture.	Saucepan, 16 cm diameter	2	Approx. 6:00	No	-	-	
2 Add the milk to the roux and bring to the boil, stirring continuously.		7	Approx. 6:30	No	-	-	
3. Once the Béchamel sauce comes to the boil, leave it on the hotplate for a further two minutes, stirring continuously.		-	-	-	2	No	

*Recipe in accordance with DIN 44550

**Recipe in accordance with DIN EN 60350-2

Test dishes	Cookware	Heat setting	Preheating		Cooking	
			Cooking time (min:sec)	Lid	Heat setting	Lid
Cooking rice pudding						
Rice pudding, cooked with the lid on Temperature of the milk: 7 °C Heat the milk until it starts to rise up. Set the recommended heat setting and add rice, sugar and salt to the milk. The cooking time, including preheating, is approx. 45 minutes.						
Ingredients: 190 g short-grain rice, 90 g sugar, 750 ml milk (3.5% fat content) and 1 g salt	Cooking pot, 16 cm diameter	8.5	Approx. 5:30	No	3 (stir after 10 minutes)	Yes
Ingredients: 250 g short-grain rice, 120 g sugar, 1 l milk (3.5% fat content) and 1.5 g salt	Saucepan, 22 cm diameter	8.5	Approx. 5:30	No	3 (stir after 10 minutes)	Yes
Rice pudding, cooked without lid Temperature of the milk: 7 °C Add the ingredients to the milk and heat the mixture up while stirring continuously. Once the milk has reached approx. 90 °C, select the recommended heat setting and leave it to simmer on a low heat for approx. 50 minutes.						
Ingredients: 190 g short-grain rice, 90 g sugar, 750 ml milk (3.5% fat content) and 1 g salt	Cooking pot, 16 cm diameter	8.5	Approx. 5:30	No	3	No
Ingredients: 250 g short-grain rice, 120 g sugar, 1 l milk (3.5% fat content) and 1.5 g salt	Saucepan, 22 cm diameter	8.5	Approx. 5:30	No	2.5	No
Cooking rice*						
Water temperature: 20 °C						
Ingredients: 125 g long grain rice, 300 g water and a pinch of salt	Cooking pot, 16 cm diameter	9	Approx. 2:30	Yes	2	Yes
Ingredients: 250 g long grain rice, 600 g water and a pinch of salt	Saucepan, 22 cm diameter	9	Approx. 2:30	Yes	2.5	Yes
Roasting a pork loin						
Initial temperature of the loin: 7 °C						
Amount: 3 pork loins (total weight approx. 300 g, 1 cm thick) and 15 ml sunflower oil	Frying pan, 24 cm diameter	9	Approx. 1:30	No	7	No
Preparing pancakes**						
Amount: 55 ml batter for each pancake	Frying pan, 24 cm diameter	9	Approx. 1:30	No	7	No
Deep-fat frying chips						
Amount: 1.8 l sunflower oil, per portion: 200 g frozen chips (e.g. McCain 123 Original fries)	Saucepan, 22 cm diameter	9	Until the oil temperature reaches 180 °C	No	9	No

*Recipe in accordance with DIN 44550

**Recipe in accordance with DIN EN 60350-2



Robert Bosch Hausgeräte GmbH

Carl-Wery-Straße 34
81739 München, GERMANY

www.bosch-home.com



9001063718
960215(01)