



Register your new Bosch now:  
[www.bosch-home.com/welcome](http://www.bosch-home.com/welcome)



**Oven**  
**HBG6767.1A**





**BOSCH**

[en] Instruction manual



# Table of contents

|  |   |           |   |   |           |
|--|---|-----------|---|---|-----------|
|    | <b>Intended use</b> .....                         | <b>5</b>  |    | <b>Childproof lock</b> .....                                      | <b>20</b> |
|  |   |           |   | Activating and deactivating .....                                 | 20        |
|    | <b>Important safety information</b> .....         | <b>5</b>  |    | <b>Basic settings</b> .....                                       | <b>20</b> |
|  | General information .....                         | 5         |   | Changing the basic settings .....                                 | 20        |
|  | Halogen lamp .....                                | 6         |   | List of basic settings .....                                      | 20        |
|  | Meat thermometer .....                            | 6         |   | Power cut .....   | 21        |
|  | Cleaning function .....                           | 6         |   | Changing the time .....   | 21        |
|    | <b>Causes of damage</b> .....                     | <b>7</b>  |    | <b>Sabbath mode</b> .....   | <b>21</b> |
|  | General information .....                         | 7         |   | Starting Sabbath mode .....                                       | 21        |
|    | <b>Environmental protection</b> .....             | <b>7</b>  |    | <b>Cleaning</b> .....   | <b>22</b> |
|  | Saving energy .....                               | 7         |   | Suitable cleaning agents .....                                    | 22        |
|  | Environmentally-friendly disposal .....           | 7         |   | Keeping the appliance clean .....                                 | 23        |
|    | <b>Getting to know your appliance</b> .....       | <b>8</b>  |    | <b>Cleaning function</b> .....                                    | <b>23</b> |
|  | Control panel .....                               | 8         |   | Prior to initiating the cleaning function .....                   | 23        |
|  | Controls .....                                    | 8         |   | Setting the cleaning function .....                               | 24        |
|  | Display .....                                     | 9         |   | Once the cleaning function has ended .....                        | 24        |
|  | Operating modes .....                             | 9         |    | <b>Rails</b> .....  | <b>25</b> |
|  | Types of heating .....                            | 10        |   | Detaching and refitting the rails .....                           | 25        |
|  | Further information .....                         | 11        |  | <b>Appliance door</b> .....                                       | <b>25</b> |
|  | Cooking compartment functions .....               | 11        |   | Removing and fitting the appliance door .....                     | 25        |
|  | <b>Accessories</b> .....                          | <b>11</b> |   | Removing the door cover .....                                     | 26        |
|  | Accessories included .....                        | 11        |   | Removing and installing the door panels .....                     | 26        |
|  | Inserting accessories .....                       | 11        |  | <b>Trouble shooting</b> .....                                     | <b>28</b> |
|  | Optional accessories .....                        | 12        |   | Rectifying faults yourself .....                                  | 28        |
|  | <b>Before using for the first time</b> .....      | <b>13</b> |   | Maximum operating time .....                                      | 28        |
|  | Initial use .....                                 | 13        |   | Replacing the bulb in the top of the cooking<br>compartment ..... | 29        |
|  | Cleaning the cooking compartment and accessories  | 13        |   | Glass cover .....   | 29        |
|  | <b>Operating the appliance</b> .....              | <b>14</b> |  | <b>Customer service</b> .....                                     | <b>29</b> |
|  | Switching the appliance on and off .....          | 14        |   | E number and FD number .....                                      | 29        |
|  | Starting the operation .....                      | 14        |   |   |           |
|  | Selecting an operating mode .....                 | 15        |   |   |           |
|  | Setting the type of heating and temperature ..... | 15        |   |   |           |
|  | Rapid heating .....                               | 15        |   |   |           |
|  | <b>Time-setting options</b> .....                 | <b>16</b> |   |   |           |
|  | Setting the cooking time .....                    | 16        |   |   |           |
|  | Setting the end time .....                        | 16        |   |   |           |
|  | Setting the timer .....                           | 17        |   |   |           |
|  | <b>Meat thermometer</b> .....                     | <b>18</b> |   |   |           |
|  | Heating types .....                               | 18        |   |   |           |
|  | Inserting the meat probe into the food .....      | 18        |   |   |           |
|  | Setting the core temperature .....                | 19        |   |   |           |
|  | Core temperatures of different foods .....        | 19        |   |   |           |

|  |           |
|--|-----------|
|  <b>Dishes</b> .....                               | <b>30</b> |
| Information on the settings .....  | 30        |
| Meat thermometer .....   | 30        |
| Selecting a dish .....   | 30        |
| Baking sensor .....  | 31        |
| Applying settings for dishes .....   | 31        |
|  <b>Tested for you in our cooking studio</b> ..... | <b>32</b> |
| Do not use silicone moulds .....   | 32        |
| Cakes and small baked items .....  | 32        |
| Bread and rolls .....  | 35        |
| Pizza, quiche and savoury cakes .....  | 37        |
| Bakes and soufflés .....   | 38        |
| Poultry .....  | 39        |
| Meat .....   | 41        |
| Fish .....   | 43        |
| Vegetables and side dishes .....   | 44        |
| Yogurt .....   | 45        |
| Eco types of heating .....   | 45        |
| Acrylamide in foodstuffs .....   | 47        |
| Slow cook .....  | 47        |
| Drying .....   | 48        |
| Preserving .....   | 49        |
| Prove dough .....  | 50        |
| Defrosting .....   | 50        |
| Keeping warm .....   | 50        |
| Test dishes .....  | 51        |

---

Additional information on products, accessories, replacement parts and services can be found at **[www.bosch-home.com](http://www.bosch-home.com)** and in the online shop **[www.bosch-eshop.com](http://www.bosch-eshop.com)**

## Intended use

Read these instructions carefully. Only then will you be able to operate your appliance safely and correctly. Retain the instruction manual and installation instructions for future use or for subsequent owners.

This appliance is only intended to be fully fitted in a kitchen. Observe the special installation instructions.

Check the appliance for damage after unpacking it. Do not connect the appliance if it has been damaged in transport.

Only a licensed professional may connect appliances without plugs. Damage caused by incorrect connection is not covered under warranty.

This appliance is intended for domestic use only. The appliance must only be used for the preparation of food and drink. The appliance must be supervised during operation. Only use this appliance indoors.

This appliance is intended for use up to a maximum height of 4000 metres above sea level.

This appliance may be used by children over the age of 8 years old and by persons with reduced physical, sensory or mental capabilities or by persons with a lack of experience or knowledge if they are supervised or are instructed by a person responsible for their safety how to use the appliance safely and have understood the associated hazards.

Children must not play with, on, or around the appliance. Children must not clean the appliance or carry out general maintenance unless they are at least 8 years old and are being supervised.

Keep children below the age of 8 years old at a safe distance from the appliance and power cable.

Always slide accessories into the cooking compartment the right way round.

→ "Accessories" on page 11

## Important safety information

### General information

#### Warning – Risk of fire!

- Combustible items stored in the cooking compartment may catch fire. Never store combustible items in the cooking compartment. Never open the appliance door if there is smoke inside. Switch off the appliance and unplug it from the mains or switch off the circuit breaker in the fuse box.
- A draught is created when the appliance door is opened. Greaseproof paper may come into contact with the heating element and catch fire. Do not place greaseproof paper loosely over accessories during preheating. Always weight down the greaseproof paper with a dish or a baking tin. Only cover the surface required with greaseproof paper. Greaseproof paper must not protrude over the accessories.

#### Warning – Risk of burns!

- The appliance becomes very hot. Never touch the interior surfaces of the cooking compartment or the heating elements. Always allow the appliance to cool down. Keep children at a safe distance.
- Accessories and ovenware become very hot. Always use oven gloves to remove accessories or ovenware from the cooking compartment.
- Alcoholic vapours may catch fire in the hot cooking compartment. Never prepare food containing large quantities of drinks with a high alcohol content. Only use small quantities of drinks with a high alcohol content. Open the appliance door with care.

#### Warning – Risk of scalding!

- The accessible parts become hot during operation. Never touch the hot parts. Keep children at a safe distance.
- When you open the appliance door, hot steam can escape. Steam may not be visible, depending on its temperature. When opening, do not stand too close to the appliance. Open the appliance door carefully. Keep children away.
- Water in a hot cooking compartment may create hot steam. Never pour water into the hot cooking compartment.

**⚠ Warning – Risk of injury!**

- Scratched glass in the appliance door may develop into a crack. Do not use a glass scraper, sharp or abrasive cleaning aids or detergents.
- The hinges on the appliance door move when opening and closing the door, and you may be trapped. Keep your hands away from the hinges.

**⚠ Warning – Risk of electric shock!**

- Incorrect repairs are dangerous. Repairs may only be carried out and damaged power cables replaced by one of our trained after-sales technicians. If the appliance is defective, unplug the appliance from the mains or switch off the circuit breaker in the fuse box. Contact the after-sales service.
- The cable insulation on electrical appliances may melt when touching hot parts of the appliance. Never bring electrical appliance cables into contact with hot parts of the appliance.
- Do not use any high-pressure cleaners or steam cleaners, which can result in an electric shock.
- A defective appliance may cause electric shock. Never switch on a defective appliance. Unplug the appliance from the mains or switch off the circuit breaker in the fuse box. Contact the after-sales service.

**⚠ Warning – Hazard due to magnetism!**

Permanent magnets are used in the control panel or in the control elements. They may affect electronic implants, e.g. heart pacemakers or insulin pumps. Wearers of electronic implants must stay at least 10 cm away from the control panel.

**Halogen lamp**

**⚠ Warning – Risk of electric shock!**

When replacing the cooking compartment bulb, the bulb socket contacts are live. Before replacing the bulb, unplug the appliance from the mains or switch off the circuit breaker in the fuse box.

**Meat thermometer**

**⚠ Warning – Risk of electric shock!**

The insulation of an incompatible meat thermometer may be damaged. Only use the meat thermometer which is recommended for this appliance.

**Cleaning function**

**⚠ Warning – Risk of fire!**

- Loose food residues, grease and meat juices may catch fire during the cleaning function. Before starting the cleaning function, remove coarse dirt from the cooking compartment and from the accessories.
- The appliance will become very hot on the outside during the cleaning function. Never hang combustible objects, e.g. tea towels, on the door handle. Do not place anything against the front of the appliance. Keep children away from the appliance.

**⚠ Warning – Risk of serious damage to health!**

The appliance will become very hot during the cleaning function. The non-stick coating on baking trays and tins is destroyed and noxious gases are released. Never clean non-stick baking trays and baking tins using the cleaning function. Only clean enamelled accessories using the cleaning function.

**⚠ Warning – Risk of burns!**

- The cooking compartment becomes extremely hot during the cleaning function. Never open the appliance door. Allow the appliance to cool down. Keep children away from the appliance.
- ⚠ The appliance will become very hot on the outside during the cleaning function. Never touch the appliance door. Allow the appliance to cool down. Keep children away from the appliance.

## Causes of damage

### General information

#### Caution!

- Accessories, foil, greaseproof paper or ovenware on the cooking compartment floor: do not place accessories on the cooking compartment floor. Do not cover the cooking compartment floor with any sort of foil or greaseproof paper. Do not place ovenware on the cooking compartment floor if a temperature of over 50 °C has been set. This will cause heat to accumulate. The baking and roasting times will no longer be correct and the enamel will be damaged.
- Aluminium foil: Aluminium foil in the cooking compartment must not come into contact with the door glass. This could cause permanent discolouration of the door glass.
- Silicone pans: Do not use any silicone pans, or any mats, covers or accessories that contain silicone. The oven sensor may be damaged.
- Water in a hot cooking compartment: do not pour water into the cooking compartment when it is hot. This will cause steam. The temperature change can cause damage to the enamel.
- Moisture in the cooking compartment: Over an extended period of time, moisture in the cooking compartment may lead to corrosion. Allow the cooking compartment to dry after use. Do not keep moist food in the closed cooking compartment for extended periods of time. Do not store food in the cooking compartment.
- Cooling with the appliance door open: Following operation at high temperatures, only allow the cooking compartment to cool down with the door closed. Do not trap anything in the appliance door. Even if the door is only left open a crack, the front of nearby furniture may become damaged over time. Only leave the cooking compartment to dry with the door open if a lot of moisture was produced whilst the oven was operating.
- Fruit juice: when baking particularly juicy fruit pies, do not pack the baking tray too generously. Fruit juice dripping from the baking tray leaves stains that cannot be removed. If possible, use the deeper universal pan.
- Extremely dirty seal: If the seal is very dirty, the appliance door will no longer close properly during operation. The fronts of adjacent units could be damaged. Always keep the seal clean.  
→ "Cleaning" on page 22
- Appliance door as a seat, shelf or worktop: Do not sit on the appliance door, or place or hang anything on it. Do not place any cookware or accessories on the appliance door.
- Inserting accessories: depending on the appliance model, accessories can scratch the door panel when closing the appliance door. Always insert the accessories into the cooking compartment as far as they will go.
- Carrying the appliance: do not carry or hold the appliance by the door handle. The door handle cannot support the weight of the appliance and could break.

## Environmental protection

Your new appliance is particularly energy-efficient. Here you can find tips on how to save even more energy when using the appliance, and how to dispose of your appliance properly.

### Saving energy

- Only preheat the appliance if this is specified in the recipe or in the tables in the operating instructions.
- Use dark, black lacquered or enamelled baking tins. They absorb heat particularly well.
- Open the appliance door as infrequently as possible during operation.
- It is best to bake several cakes one after the other. The cooking compartment is still warm. This reduces the baking time for the second cake. You can place two cake tins next to each other in the cooking compartment.
- For longer cooking times, you can switch the appliance off 10 minutes before the end of the cooking time and use the residual heat to finish cooking.

### Environmentally-friendly disposal

Dispose of packaging in an environmentally-friendly manner.



This appliance is labelled in accordance with European Directive 2012/19/EU concerning used electrical and electronic appliances (waste electrical and electronic equipment - WEEE). The guideline determines the framework for the return and recycling of used appliances as applicable throughout the EU.

## Getting to know your appliance

In this chapter, we will explain the displays and controls. You will also find out about the various functions of your appliance.

**Note:** Depending on the appliance model, individual details and colours may differ.

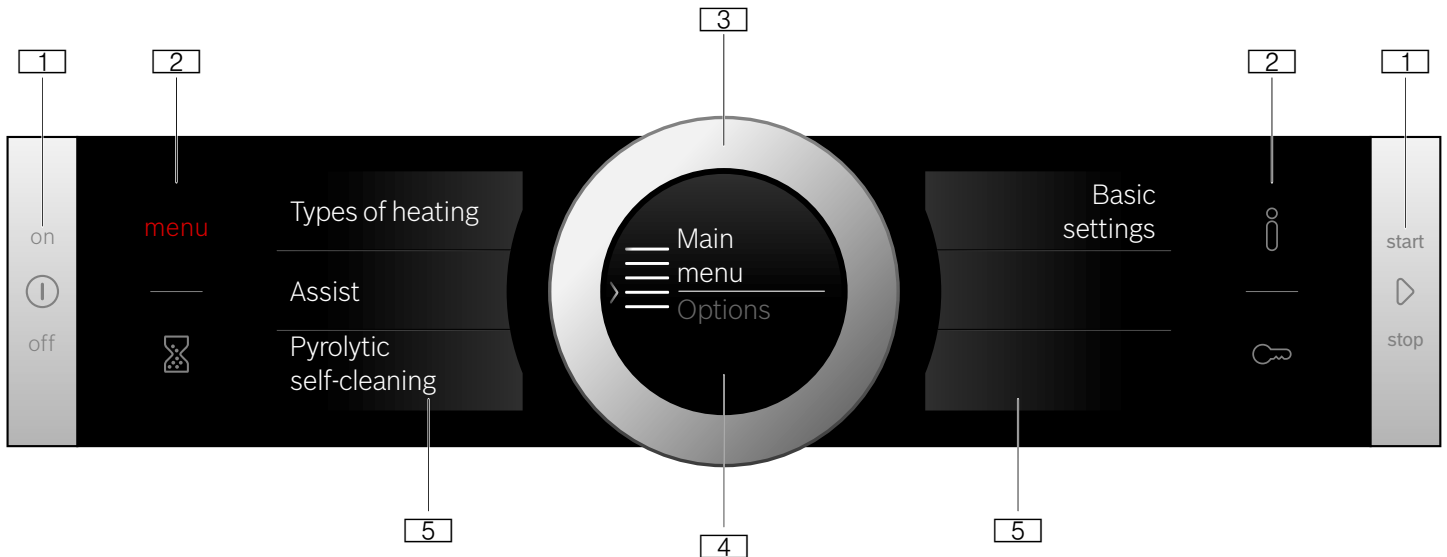

### 1 Buttons

The buttons on the left- and right-hand side of the control panel have a pressure point. Press these buttons to activate them. For appliances that do not have a stainless steel front, these two button touch fields do not have a pressure point.

### 2 Touch fields

There are sensors under the touch fields. Simply touch the respective symbol to select the function.

### 3 Rotary selector

The rotary selector is fitted so that you can turn it indefinitely to the left or right. Press it lightly and move it in the direction required using your finger.

### 4 Display

You can see the current adjustment values, options or notes in the display.

### 5 Touch-screen displays

You can see the current selection options in the touch-screen displays. You can select these here directly by touching the appropriate text field. The text fields change depending on the selection.

## Control panel

In the control panel, you can use the various buttons, touch fields, touch-screen displays and the rotary selector to set the different appliance functions. The current settings are shown on the display.

The overview shows the control panel when the appliance is switched on with the menu display.

## Controls

The individual controls are adapted for the various functions of your appliance. You can set your appliance simply and directly.

### Buttons and touch fields

Here you can find a short explanation of the various buttons and touch fields.

| Symbol              | Meaning         |  |
|---------------------|-----------------|--|
| <b>Buttons</b>      |                 |  |
| ⓘ                   | on/off          | Switching the appliance on and off   |
| ▶                   | Start/Stop      | Starting, pausing or cancelling (hold down for approx. 3 secs) an operation    |
| <b>Touch fields</b> |                 |  |
| ☰                   | Menu            | Opens the "Operating modes" menu   |
| ⌚                   | Timer           | Selects the timer  |
| i                   | Information     | Displays information   |
| 🔒                   | Childproof lock | Activating and deactivating (hold down for approx. 4 secs) the childproof lock |

### Rotary selector

You can use the rotary selector to change the setting values shown on the display.

You can also use the rotary selector to scroll through the selection lists on the touch-screen displays.

In most selection lists, you have to turn the rotary selector in the opposite direction once you reach the beginning or the end of the list.



## Display

The display is structured so that the information can be read at a glance in any situation.

The value that you can currently set is highlighted and displayed in white text. The value in the background is displayed in grey.

|             |  |
|-------------|--|
| Highlighted | The highlighted value can be changed directly without first being selected.<br>After starting an operation, either the temperature or the level is always highlighted. At the same time, the white line is the heating line and gradually turns red. |
| Enlarged    | Whilst you are changing the highlighted value using the rotary selector, only this value is enlarged on the display.   |

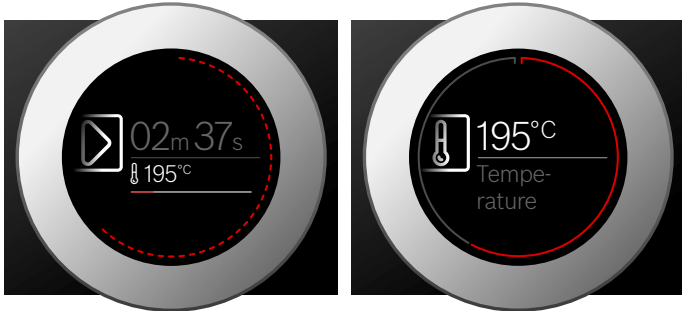

### Display ring

The display ring can be found around the outside of the display.

If you change a value, the display ring shows you where you are in the selection list. Depending on the settings area and length of the selection list, the display ring may be continuous or divided into segments.

During operation, the display ring turns red at second-long intervals. After every full minute, the segments turn red again from the beginning. As the cooking time counts down, one segment disappears every second.

### Temperature display

After the operation has started, the current cooking compartment temperature is displayed graphically on the display.

|                         |   |
|-------------------------|---|
| Heating line            | The white line under the temperature turns red from left to right as the cooking compartment heats up. When you are preheating the appliance, the optimal time to place the food in the cooking compartment is when the line has completely turned red. For set levels, e.g. the grill setting, the heating line turns red immediately. |
| Residual heat indicator | When the appliance is switched off, the display ring shows the residual heat in the cooking compartment. As the residual heat cools down, the display ring becomes darker and disappears completely at some point.  |

**Note:** Due to thermal inertia, the temperature displayed may be slightly different to the actual temperature inside the oven.

## Touch-screen displays

The touch-screen displays are both a display medium and control element at the same time. They show the options that you can select for a function and the current setting. To select a function, simply touch the text field directly.

The function currently selected is identified by a red vertical bar next to it. Its corresponding value is highlighted in white on the display.

The small red arrow next to the text field shows the functions to which you can scroll forwards or backwards.



## Operating modes

Your appliance has various operating modes which make your appliance easier to use.

You can find more precise descriptions of these in the corresponding sections.

You can open the "Operating modes" menu by pressing the **menu** field.













| Operating mode  | Use  |
|---|--|
| Heating types<br>→ "Operating the appliance" on page 14 | There are various finely tuned heating types for the optimal preparation of your food. |
| Assist<br>→ "Dishes" on page 30                         | For many dishes, there are pre-programmed setting values.                              |
| Pyrolytic system<br>→ "Cleaning function" on page 23    | The cleaning function cleans the cooking compartment almost by itself.                 |
| Basic settings<br>→ "Basic settings" on page 20         | You can change your appliance's basic settings to suit your needs.                     |

## Types of heating

To enable you to find the correct type of heating for your dish, we have explained the differences and scopes of application here.

The symbols for each type of heating help you to remember them.

When cooking at very high temperatures, the appliance lowers the temperature slightly after an extended period.

| Heating type   | Temperature  | Use  |
|--|--|--|
|  4D hot air             | 30-275 °C  | For baking and roasting on one or more levels.<br>The fan distributes heat from the ring heating element in the back panel evenly around the cooking compartment.                      |
|  Top/bottom heating     | 30-300 °C  | For traditional baking and roasting on one level. Especially suitable for cakes with moist toppings.<br>Heat is emitted evenly from the top and bottom.                                |
|  Hot air eco            | 30-275 °C  | For gentle cooking of selected dishes on one level without preheating.<br>The fan distributes the heat from the ring heating element in the back panel around the cooking compartment. |
|  Top/bottom heating eco | 30-300 °C  | For gentle cooking of selected dishes.<br>The heat is emitted from above and below.  |
|  Hot air grilling       | 30-300 °C  | For roasting poultry, whole fish and larger pieces of meat.<br>The grill element and the fan switch on and off alternately. The fan circulates the hot air around the food.            |
|  Grill, large area      | Grill settings:<br>1 = low<br>2 = medium<br>3 = high | For grilling flat items for grilling, such as steaks and sausages, for making toast, and for cooking au gratin.<br>The whole area below the grill element becomes hot.                 |
|  Grill, small area    | Grill settings:<br>1 = low<br>2 = medium<br>3 = high | For grilling small amounts of steaks or sausages, for making toast, and for cooking au gratin.<br>The centre area under the grill heating element becomes hot.                         |
|  Pizza setting        | 30-275 °C  | For preparing pizza and dishes which require a lot of heat from underneath.<br>The bottom heating element and the ring heating element in the back panel heat up.                      |
|  Slow cooking         | 70-120 °C  | For gentle and slow cooking of seared, tender pieces of meat in ovenware without a lid.<br>The heat is emitted evenly from the top and bottom at low temperatures.                     |
|  Bottom heating       | 30-250 °C  | For cooking in a bain marie and for the final baking stage.<br>The heat is emitted from below.   |
|  Defrosting           | 30-60 °C   | For gently defrosting frozen food.   |
|  Keeping warm         | 60-100 °C  | For keeping cooked food warm.  |
|  Preheating ovenware  | 30-70 °C   | For preheating ovenware.   |

## Default values

For each heating type, the appliance specifies a default temperature or level. You can accept this value or change it in the appropriate area.

## Further information

In most cases, the appliance provides notes and further information on the action just carried out.

Touch the **i** field. The note is shown in the display for a few seconds. Use the rotary selector to scroll to the end of longer notes.

Some notes are displayed automatically, for example as confirmation, or to provide an instruction or warning.

## Cooking compartment functions

The functions in the cooking compartment make your appliance easier to use. This, for example, enables the cooking compartment to be well lit and a cooling fan to prevent the appliance from overheating.

### Opening the appliance door

If you open the appliance door during an on-going operation, the operation is paused. The operation continues to run when you close the door.

### Interior lighting

When you open the appliance door, the interior lighting switches on. If the door remains open for longer than around 15 minutes, the lighting switches off again.

For most operating modes, the interior lighting switches on as soon as the operation is started. When the operation has finished, the lighting switches off.

**Note:** You can set the interior lighting not to come on during the operation in the basic settings. → "Basic settings" on page 20

### Cooling fan

The cooling fan switches on and off as required. The hot air escapes above the door.

### Caution!

Do not cover the ventilation slots. Otherwise, the appliance may overheat.

So that the cooking compartment cools down more quickly after the operation, the cooling fan continues to run for a certain period afterwards.





**Note:** You can change how long the cooling fan continues to run in the basic settings. → "Basic settings" on page 20

## Accessories

Your appliance is accompanied by a range of accessories. Here, you can find an overview of the accessories included and information on how to use them correctly.

### Accessories included

Your appliance is equipped with the following accessories:

|   |   |
|---|---|
|   | <p><b>Wire rack</b><br/>For ovenware, cake tins and ovenproof dishes.<br/>For roasts, grilled items and frozen meals.</p>   |
|   | <p><b>Universal pan</b><br/>For moist cakes, pastries, frozen meals and large roasts.<br/>It can be used to catch dripping fat when you are grilling directly on the wire rack.</p> |
|   | <p><b>Baking tray</b><br/>For tray bakes and small baked products.</p>  |
|  | <p><b>Meat thermometer</b><br/>Enables precision roasting to your exact requirements.<br/>Its use is described in the relevant section. → "Meat thermometer" on page 18</p>         |

Only use original accessories. They are specially adapted for your appliance.

You can buy accessories from the after-sales service, from specialist retailers or online.

**Note:** The accessories may deform when they become hot. This does not affect their function. Once they have cooled down again, they regain their original shape.

### Inserting accessories

The cooking compartment has five shelf positions. The shelf positions are counted from the bottom up.

In some appliances, the highest shelf position is marked on the cooking compartment with the grill symbol.

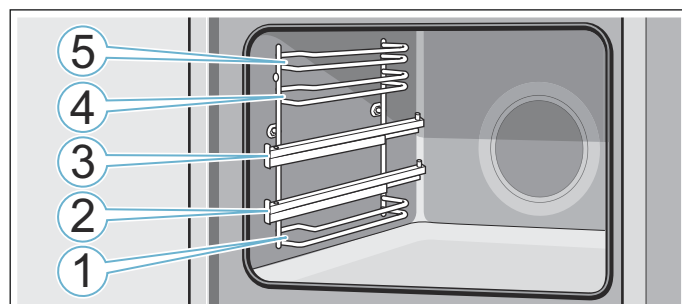

When using shelf positions 1, 4 and 5, always insert the accessory between the two guide bars for a shelf position.

Accessories can be pulled out approximately halfway without tipping. With the pull-out rails at levels 2 and 3, you can pull the accessories out further.

Make sure that the accessory is placed behind the lug **a** on the pull-out rail.

Example in the picture: Universal pan

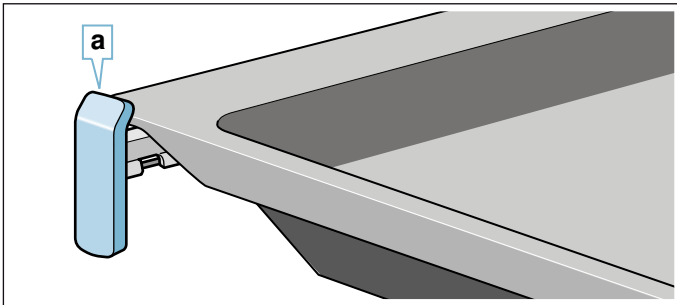

The pull-out rails lock in place when they are fully pulled out. This makes it easy to place the accessories in position. To unlock, push the pull-out rails back into the cooking compartment with a certain amount of force.

#### Notes

- Make sure that you always insert the accessories into the cooking compartment the right way round.
- Always insert accessories fully into the cooking compartment so that they do not touch the appliance door.

#### Locking function

The accessories can be pulled out approximately halfway until they lock in place. The locking function prevents the accessories from tilting when they are pulled out. The accessories must be inserted into the cooking compartment correctly for the tilt protection to work properly.

When inserting the wire rack, ensure that lug **a** is at the rear and is facing downwards. The open side must be facing the appliance door and the outer rail must be facing downwards.

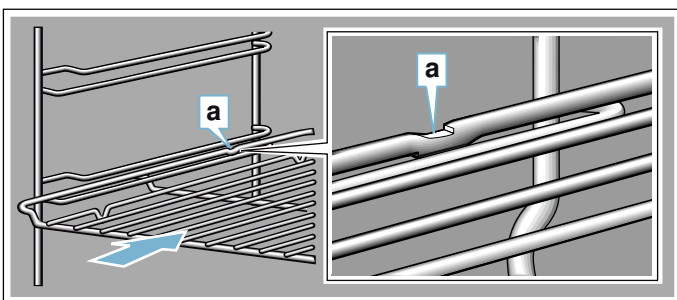

When inserting baking trays, ensure that lug **a** is at the rear and is facing downwards. The sloping edge of the accessory **b** must be facing towards the appliance door.

Example in the picture: Universal pan

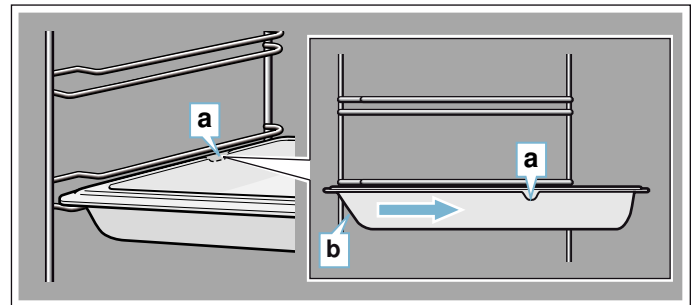

#### Combining accessories

You can insert the wire rack and the universal pan at the same time to catch drops of liquid.

When inserting the wire rack, ensure that both spacers **a** are at the rear edge. When inserting the universal pan, the wire rack is on top of the upper guide rod of the shelf position.

Example in the picture: Universal pan

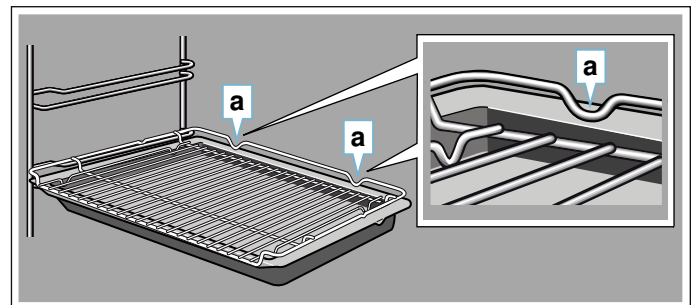

#### Optional accessories

You can buy optional accessories from the after-sales service, from specialist retailers or online. \*You will find a comprehensive range of products for your appliance in our brochures and online.

Both availability and whether it is possible to order online differ between countries. Please see your sales brochures for more details.

**Note:** Not all optional accessories are suitable for every appliance. When purchasing, please always quote the exact identification number (E-no.) of your appliance.  
→ "Customer service" on page 29

## Optional accessories

### Wire rack

For ovenware, cake tins and ovenproof dishes, and for roasts and grilled food.

### Universal pan, Pyrolytic

For moist cakes, pastries, frozen meals and large roasts. It can be used to catch dripping fat when you are grilling directly on the wire rack.

### Baking tray, Pyrolytic

For tray bakes and small baked products.

### Wire insert

For meat, poultry and fish. For inserting into the universal pan to catch dripping fat and meat juices.

### Profi pan

For preparing large quantities.

### Lid for the Profi pan

The lid turns the Profi pan into a Profi roasting dish.

### Pizza tray

For pizzas and large round cakes.

### Grill tray, Pyrolytic

Use for grilling in place of the wire rack or as a splatter guard. Only use in the universal pan.

### Bread-baking stone, Pyrolytic

For home-made bread, bread rolls and pizzas that require a crispy base. The baking stone must be preheated to the recommended temperature.

### Glass roasting dish (5.1 litres)

For stews and bakes. Particularly suitable for the "Meals" operating mode.

### Glass tray

For large roasts, moist cakes and bakes.

### Glass tray

For bakes, vegetable dishes and baked goods.

### Pull-out system, 1 level, Pyrolytic,

The pull-out rails at level 2 allow you to pull the accessories out further without them tipping.

### Pull-out system, 2 levels, Pyrolytic

The pull-out rails at levels 2 and 3 allow you to pull the accessories out further without them tipping.

### Pull-out system, 3 levels, Pyrolytic

The pull-out rails at levels 1, 2 and 3 allow you to pull the accessories out further without them tipping.

### Decorative trims

For concealing the lower shelf of the unit and the base of the appliance.



## Before using for the first time

Before you can use your new appliance, you must make some settings. You must also clean the cooking compartment and accessories.

### Initial use

After connecting the appliance to the power or following a power cut, the settings for initial use are shown on the display. It may take a few seconds for the instruction to appear.

**Note:** You can change these settings at any time in the basic settings. → "Basic settings" on page 20

### Setting the language

The language is the first setting displayed. "German" is the preset language.

1. Turn the rotary selector to set the required language.
2. Touch the next text field to confirm. The next setting appears.

### Setting the time

The time starts at "12:00".

1. Touch the "Clock" text field.
2. Set the time using the rotary selector.
3. Touch the "Complete the settings" text field to confirm.

A message appears on the display to confirm that the initial use has been completed.

## Cleaning the cooking compartment and accessories

Before using the appliance to prepare food for the first time, you must clean the cooking compartment and accessories.

### Cleaning the cooking compartment

To remove the new-appliance smell, heat up the cooking compartment when empty and with the oven door closed.

Ensure that the cooking compartment does not contain any leftover packaging, such as polystyrene pellets. Before heating up the appliance, wipe the smooth surfaces in the cooking compartment with a soft, wet cloth. Keep the kitchen ventilated while the appliance is heating up.

Adjust the settings indicated. You can find out how to set the heating type and the temperature in the next section. → "Operating the appliance" on page 14

### Settings

|              |   |
|--------------|---|
| Heating type | Top/bottom heating <input type="checkbox"/> |
| Temperature  | 240 °C                                      |
| Cooking time | 1 hour                                      |

Switch off the appliance after the indicated cooking time using the ⏻ On/Off button.

After the cooking compartment has cooled down, clean the smooth surfaces with soapy water and a dish cloth.

### Cleaning the accessories

Clean the accessories thoroughly using soapy water and a dish cloth or soft brush.



## Operating the appliance

You have already learnt about the controls and how they work. Now we will explain how to set your appliance. You will learn about what happens when you switch the appliance on and off, and how to select the operating mode.

### Switching the appliance on and off

Before you are able to set the appliance, you must switch it on.

**Note:** The childproof lock and the timer can also be set when the appliance is switched off. Certain displays and notes, such as those relating to the residual heat in the cooking compartment, remain visible on the display after the appliance has been switched off.

Switch off your appliance when you do not need to use it. If no settings are applied for a long time, the appliance switches itself off automatically.

#### Switching on the appliance

Press the ⏻ On/Off button to switch on the appliance. The Bosch logo appears on the display, followed by the selection list for the types of heating.

**Note:** In the basic settings, you can specify which operating mode should appear after the appliance is switched on. → "Basic settings" on page 20

#### Switching off the appliance

Press the ⏻ On/Off button to switch off the appliance. Any functions that may be running are cancelled. The time, or if applicable, the residual heat indicator, appears on the display.

**Note:** You can set whether or not the time should be displayed when the appliance is switched off in the basic settings. → "Basic settings" on page 20

### Starting the operation

You must press the ▶ Start/Stop button to start each operation.

After starting the appliance, the time display is shown on the display along with the settings. The display ring and the heating line also appear.

#### Pausing the operation

You can also interrupt and then continue an operation using the ▶ Start/Stop button.

If you press and hold the ▶ Start/Stop button for approx. 3 seconds, the operation is cancelled and all settings are reset.

**Note:** The fan may continue to run after an operation has been paused or cancelled.

## Selecting an operating mode

Once the appliance is switched on, the default operating mode is displayed.

If you would like to select a different operating mode, you can do so using the menu. You can find detailed descriptions of the individual operating modes in the corresponding sections.

The following always applies:

1. Touch the appropriate text field. The function is highlighted.
2. Turn the rotary selector to change the highlighted selection.
3. If necessary, apply other settings. To do this, touch the appropriate text field and change the value using the rotary selector.
4. Press the ▷ Start/Stop button to start. The appliance starts the operation.

## Setting the type of heating and temperature

If the "Types of heating" operating mode has not been selected, touch the "Types of heating" text field in the menu. The selection list for the types of heating appears on the touch-screen displays.

Example in the picture: Hot air eco  at 195 °C.

1. Touch the text field with the required type of heating. If necessary, scroll through the selection list using the rotary selector.

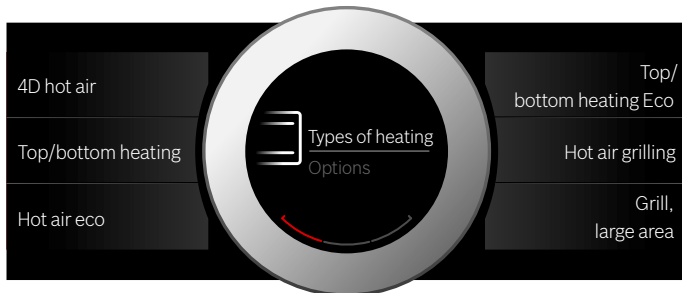

The temperature is highlighted white.

2. Set the temperature using the rotary selector.



3. Press the ▷ Start/Stop button to start. The time on the display shows how long the operation has already been running.



The appliance begins to heat up.

When your dish is ready, switch off the appliance using the Ⓞ On/Off button.

**Note:** You can also set the cooking time and an end time for the operation on the appliance. → "Time-setting options" on page 16

## Changing

After starting the appliance, the temperature is highlighted. When you move the rotary selector, the temperature is changed and applied immediately.



To change the type of heating, first use the ▷ Start/Stop button to interrupt the operation and then touch the "Type of heating" text field. The selection list is displayed. Touch the required type of heating. The corresponding default temperature appears on the display.

**Note:** When you change the type of heating, the other settings are also reset.

## Rapid heating

With Rapid heating, you can shorten the heat-up time for some heating types.

The heating types suitable for Rapid heating are:

-  4D hot air
-  Top/bottom heating

To achieve an even cooking result, do not place your food or accessories into the cooking compartment until "Rapid heating" is complete.

## Applying settings

Ensure you have selected a suitable type of heating and set a temperature of at least 100 °C. Otherwise, rapid heating cannot be activated.

1. Set the type of heating and temperature.
2. Touch the "Rapid heating" text field.

"On" is displayed in the text field. A confirmation message appears on the display.

When rapid heating comes to an end, an audible signal sounds and a message appears on the display. "Off" is displayed in the text field. Place your dish in the cooking compartment.



**Note:** The "Cooking time" time-setting option starts at the same time as rapid heating. Therefore, only set a cooking time when rapid heating has come to an end.

## Cancelling

To cancel the rapid heating, touch the "Rapid heating" text field again. "Off" is displayed in the text field.

## Time-setting options

Your appliance has different time-setting options.

| Time-setting option   | Use  |
|---|--|
|  Cooking time | After the set cooking time has elapsed, the appliance ends the operation automatically.  |
|  End          | Enter a cooking time and the required end time. The appliance starts automatically so that the operation ends at the required time.  |
|  Timer        | The timer functions like an egg timer. It runs independently of the operation and the other time-setting options. After the set time has elapsed, the appliance does not switch on or off automatically. |

You can call up the cooking time and the end time after setting an operation using the touch-screen displays. The timer has a separate field  and can be adjusted at any time.

An audible signal sounds after a cooking time or timed period has elapsed. You can cancel the audible signal early by touching a field or touch-screen display.

**Note:** You can change how long the audible signal sounds for in the basic settings. → "Basic settings" on page 20

### Setting the cooking time

You can set the cooking time for your dish on the appliance. This means that the cooking time is not unintentionally exceeded and you do not need to interrupt other work in order to end the operation.

#### Applying settings

Depending on which direction you turn the rotary selector first, the cooking time starts at a particular default value: Left = 10 minutes, right = 30 minutes.

The cooking time can be set in one-minute increments up to one hour, and then in five-minute increments.

The maximum setting is 23 hours and 59 minutes.

Example in the picture: It is 10:00, cooking time of 45 minutes.

1. Set the operating mode, and temperature or level.
2. Before starting the operation, touch the "Cooking time" text field.  
The cooking time is highlighted white in the display.
3. Turn the rotary selector to set the cooking time.  
The end time is calculated automatically.



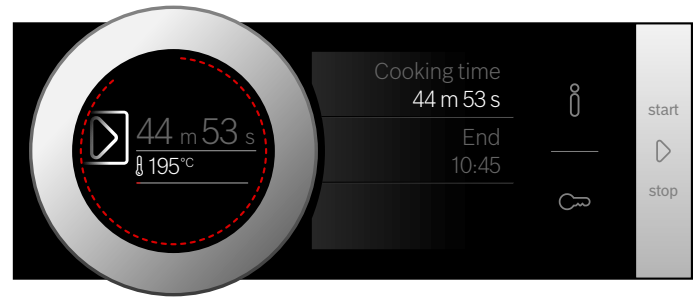

4. Press the  Start/Stop button to start.  
The cooking time counts down.



The appliance begins to heat up.

Once the cooking time has elapsed, an audible signal sounds. The appliance stops heating. The cooking time 00 m 00 s is shown on the display.

You can reset the cooking time using the "Cooking time" text field or you can press the  Start/Stop button to continue the operation without a cooking time.

When your dish is ready, switch the appliance off using the  On/Off button.

### Changing and cancelling

To change the cooking time, touch the "Cooking time" text field. The cooking time is highlighted, and can be changed using the rotary selector. The change is adopted immediately.

If you want to cancel the cooking time, reset the cooking time to zero. After the change has been adopted, operating continues without a cooking time.

### Setting the end time

You can delay the time that the cooking time ends. You can, for example, put your dish in the cooking compartment in the morning and set the cooking time so that it is ready at lunch time.

#### Notes

- Ensure that food is not left in the cooking compartment for too long as it may spoil.
- Do not adjust the end time once the operation has started. The cooking result would no longer be satisfactory.

#### Applying settings

The end of the cooking time can be delayed by a maximum of 23 hours and 59 minutes.

Example in the picture: It is 10:00, the set cooking time is 45 minutes and the dish should be ready at 12:00.

1. Set the operating mode, and temperature or level.
2. Set the cooking time.



- Before starting the operation, touch the "End" text field.  
The projected end time is highlighted white in the display.
- Set a later end time using the rotary selector.



- Press the ▷ Start/Stop button to start.  
The time at which the appliance will start is shown in the display.



The appliance is in standby mode. When the appliance starts, the cooking time counts down on the display.

Once the cooking time has elapsed, an audible signal sounds. The appliance stops heating. The cooking time 00 m 00 s is shown on the display.

You can reset the cooking time using the "Cooking time" text field or you can press the ▷ Start/Stop button to continue the operation without a cooking time.

When your dish is ready, switch the appliance off using the ⏻ On/Off button.

### Changing and cancelling

After starting the appliance, the end time can no longer be changed.

If you want to cancel the cooking time and end time, interrupt the operation by pressing the ▷ Start/Stop button. You can continue the operation without a cooking time or end time.

## Setting the timer

The timer runs alongside other settings. You can set it at any time, even if the appliance is switched off. It has its own audible signal so that you can tell whether it is the timer or a cooking time which has elapsed.

### Adjusting settings

The timer duration always starts at zero minutes.

The higher the value, the greater the time steps when setting the timer.

The maximum setting is 24 hours.

- Touch the ⌘ field.  
The symbol lights up red. On the display, the timer duration is shown in white and in focus.
- Set the timer duration using the rotary selector.
- Press the ⌘ field to start.  
**Note:** After a few seconds, the timer also starts automatically.

The timer duration counts down.

The timer remains visible on the display if the appliance is switched off. When an operation is running, the settings for this operation are shown in the foreground. When you touch the ⌘ field, the timer duration is displayed for a few seconds.

When the timer duration comes to an end, an audible signal sounds and a note appears on the display. The symbol is no longer lit up.

**Tip:** If the set timer duration relates to the appliance operation, use the cooking time. The time is visible in the foreground and the appliance switches off automatically.

### Changing and cancelling

To change the timer duration, touch the ⌘ field. The timer duration is displayed in white and in focus, and can be changed by using the rotary selector.

If you want to cancel the timer, reset the timer duration to zero. Once the change has been applied, the symbol is no longer lit up.







## Meat thermometer

The meat thermometer makes accurate cooking possible. It measures the temperature inside the food. As soon as the set temperature is reached, the appliance switches off automatically.

### Heating types

Not all heating types are suitable for operation with the meat thermometer.

If you have inserted the meat thermometer into the cooking compartment, the following heating types are available.

|  |                        |
|--|------------------------|
|  | 4D hot air             |
|  | Top/bottom heating     |
|  | Hot air eco            |
|  | Top/bottom heating eco |
|  | Hot air grilling       |
|  | Pizza setting          |

### Notes

- The meat thermometer measures the temperature on the inside of the food between 30 °C and 99 °C.
- Use only the meat thermometer supplied. You can purchase it as a spare part from the after-sales service.
- After use, always remove the meat thermometer from the cooking compartment. Never store it inside the cooking compartment.

### Warning – Risk of electric shock!

The insulation of an incompatible meat thermometer may be damaged. Only use the meat thermometer which is recommended for this appliance.

### Cooking compartment temperature

To prevent damage to the meat thermometer, do not set temperatures higher than 250 °C.

The interior temperature set in the cooking compartment must be at least 10 °C higher than the core temperature that has been set.

### Inserting the meat probe into the food

Before placing your food into the cooking compartment, insert the meat probe into the food.

The meat probe has three measuring points. Ensure that the middle measuring point is inserted in the food.

**Meat:** For large pieces of meat, insert the meat probe at an angle from above as far as it will go into the meat. For relatively thin pieces of meat, insert the meat probe from the side at the thickest point.

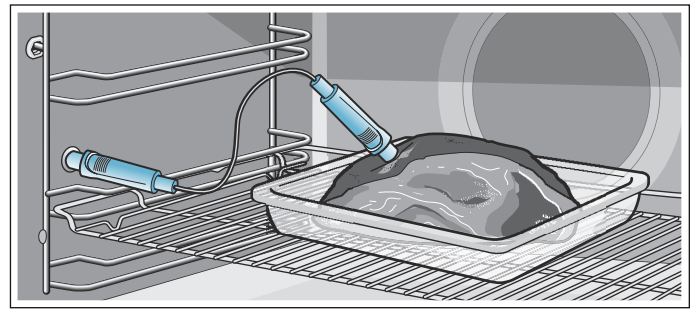

**Poultry:** Insert the meat probe as far as it will go into the thickest point in the breast. Insert the meat probe into the poultry crossways or lengthways depending on its structure. Then turn the poultry and place it on the wire rack breast-side down.

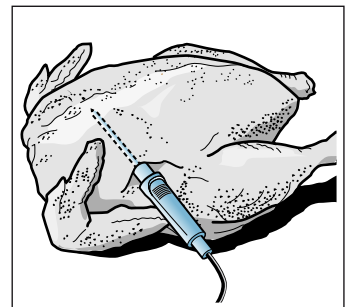
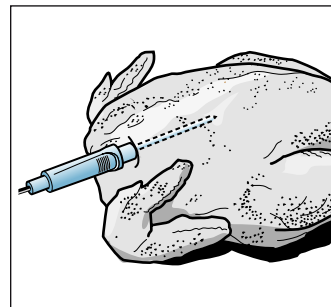

**Fish:** Insert the meat probe behind the head as far as it will go towards the spine. Place the whole fish onto the wire rack and prop it up in the swimming position using half a potato.

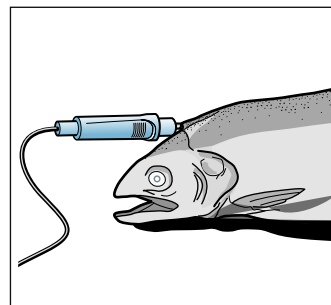

**Turning the food:** If you wish to turn the food, do not remove the meat probe. Once you have turned the food, check that the meat probe is correctly positioned in the food.

If you remove the meat probe while the food is cooking, all settings will be reset and you will have to apply them again.

### Caution!

Ensure that the meat probe's cable does not become trapped.

To prevent the meat probe from being damaged by excessive heat, there must be a gap of a few centimetres between the grill element and the meat probe. The meat may expand during the cooking process.

## Setting the core temperature

The meat thermometer must be inserted into the socket on the left-hand side of the cooking compartment.

1. Touch the text field with the required type of heating. The default cooking compartment temperature is highlighted white in the display.
2. Use the rotary selector to set the cooking compartment temperature.
3. Touch the "Core temperature" text field. The default core temperature is highlighted white in the display.
4. Turn the rotary selector to set the core temperature.
5. Press the  $\triangleright$  Start/Stop button to start. The time on the display shows how long the operation has already been running. The appliance begins to heat up.

The core temperature is highlighted white in the display, with the current temperature on the left-hand side and the set temperature on the right-hand side, e.g. "15|80 °C". The heating line also refers to the core temperature.

Once the food reaches the core temperature, an audible signal sounds. The appliance stops heating. On the display, the current core temperature is equal to the set temperature, e.g. "80|80 °C". The time is paused.

Switch off the appliance using the  $\odot$  On/Off button and remove the meat thermometer from the socket.

### Warning – Risk of burns!

The cooking compartment, accessories and meat thermometer become very hot. Always use oven gloves to remove hot accessories and the meat thermometer from the cooking compartment.

### Changing

After starting the appliance, the core temperature is highlighted. When you move the rotary selector, the core temperature is changed and applied immediately.

If you want to change the cooking compartment temperature, touch the "Temperature" text field beforehand.

To change the type of heating, interrupt the operation beforehand using the  $\triangleright$  Start/Stop button.

**Note:** When you change the type of heating, the other settings are also reset.

### Cancel

If you want to cancel the operation, remove the meat thermometer from the socket and the meat. You can continue the operation without a meat thermometer using the  $\triangleright$  Start/Stop button.

## Core temperatures of different foods

Do not use frozen food. The figures in the table are given as a guide. They depend on the quality and composition of the food.

You can find comprehensive information on the heating mode and temperature at the end of the instruction manual. → "Tested for you in our cooking studio" on page 32

| Food                               | Core temperature in °C |
|------------------------------------|------------------------|
| <b>Poultry</b>                     |                        |
| Chicken                            | 80-85                  |
| Chicken breast                     | 75-80                  |
| Duck                               | 80-85                  |
| Duck breast, medium rare           | 55-60                  |
| Turkey                             | 80-85                  |
| Turkey breast                      | 80-85                  |
| Goose                              | 80-90                  |
| <b>Pork</b>                        |                        |
| Shoulder of pork                   | 85-90                  |
| Fillet of pork, medium rare        | 62-70                  |
| Loin of pork, well done            | 72-80                  |
| <b>Beef</b>                        |                        |
| Tenderloin or sirloin, rare        | 45-52                  |
| Tenderloin or sirloin, medium rare | 55-62                  |
| Tenderloin or sirloin, well done   | 65-75                  |
| <b>Veal</b>                        |                        |
| Joint of veal or shoulder, lean    | 75-80                  |
| Joint of veal, shoulder            | 75-80                  |
| Knuckle of veal                    | 85-90                  |
| <b>Lamb</b>                        |                        |
| Leg of lamb, medium rare           | 60-65                  |
| Leg of lamb, well done             | 70-80                  |
| Saddle of lamb, medium rare        | 55-60                  |
| <b>Fish</b>                        |                        |
| Whole fish                         | 65-70                  |
| Fish fillet                        | 60-65                  |
| <b>Miscellaneous</b>               |                        |
| Meat loaf, all kinds               | 80-90                  |

## Childproof lock

Your appliance is equipped with a childproof lock so that children cannot switch it on accidentally or change any settings.



The control panel is locked and no settings can be made. The appliance can only be switched off using the  On/Off button.

### Activating and deactivating

You can activate and deactivate the childproof lock when the appliance is switched on or off.

In each case, press the  field for approx. 4 seconds.

A confirmation note appears on the display.

The  field lights up red when the appliance is switched on. The  field does not light up when the appliance is switched off.

## Basic settings

There are various settings available to you in order to help use your appliance effectively and simply. You can change these settings as required.

### Changing the basic settings

The appliance must be switched on.

1. Touch the **menu** field.  
The options for selecting an operating mode are displayed.
2. Touch the "Basic settings" text field.  
The settings appear on the touch-screen displays.
3. Touch the text field with the required setting.  
The red bar next to the text field identifies the setting that is currently selected.  
Its corresponding value is shown on the display.
4. Turn the rotary selector to change the value as required.
5. Touch the text field for the next setting.  
Its value is shown on the display and can be changed using the rotary selector.
6. Work through the settings and use the rotary selector to make changes as required.  
To scroll through the settings, touch the "Further settings" text field.
7. Touch the **Menu** field to confirm.  
A query is displayed asking whether the changes should be saved.
8. Touch the "Save" text field.  
A message is shown on the display to confirm that the settings have been saved.

### Canceling

If you do not want to save the settings, touch the **Menu** field and then touch the "Do not save" text field. A message is shown on the display to confirm that the settings have not been saved. Switch off the appliance using the  On/Off button if you do not need to use it.

### List of basic settings

Depending on the features of your appliance, not all basic settings are accessible.

| Setting            | Options  |
|--------------------|--|
| Language           | Additional languages are possible.   |
| Clock              | Clock in 24-hour format  |
| Factory settings   | Restore<br>Do not restore*   |
| Audible signal     | Short cooking time (30 sec.)<br>Medium cooking time (1 min.)*<br>Long cooking time (5 min.)  |
| Volume             | Scale with 5 levels  |
| Button tone        | Switched on<br>Switched off* (tone remains for  On/Off) |
| Display brightness | 5 levels   |

|                              |   |
|------------------------------|---|
| Clock display                | Off<br>Digital*<br>Analogue   |
| Lighting                     | Off during operation<br>On during operation*  |
| Childproof lock              | Button lock only*<br>Door lock and button lock  |
| Operation after switching on | Main menu<br>Types of heating*<br>Assist  |
| Night-time darkening         | Switched off*<br>Switched on  |
| Brand logo                   | Display*<br>Do not display  |
| Fan run-on time              | Recommended*<br>Minimum   |
| Pull-out system              | Not retrofitted* (for rails and single pull-out system)<br>Retrofitted (for double and triple pull-out systems) |
| Sabbath mode                 | Switched on<br>Switched off*  |

\* Factory setting (factory settings may vary depending on the appliance model)

**Note:** Changes to the language, button tone and display brightness settings take effect immediately. All other changes take effect after the settings have been changed.

## Power cut

The changes you make to the settings are saved even after a power cut.

You only have to reset the settings for the initial use following a long-term power cut. The appliance can bridge a short-term power cut.

## Changing the time

If you want to change the time, for example from summer to winter time, you must change the basic setting.

The appliance must be switched on.

1. Touch the **Menu** field.  
The options for selecting an operating mode are displayed.
2. Touch the "Basic settings" text field.  
The settings appear on the touch-screen displays.
3. Touch the "Clock" text field.  
The time appears on the display.
4. Turn the rotary selector to change the time.
5. Touch the **Menu** field to confirm.  
A query is displayed asking whether the changes should be saved.
6. Touch the "Save" text field.  
A message is shown on the display to confirm that the settings have been saved.

## Sabbath mode

With the Sabbath mode, a cooking time of up to 74 hours can be set. You can keep the food in the cooking compartment warm without having to switch the oven on or off.

### Starting Sabbath mode

Before you are able to use the Sabbath mode, you must activate it in the basic settings. → "Basic settings" on page 20

When the basic setting has been changed accordingly, Sabbath mode is listed with the types of heating as the last type of heating.

The appliance heats up with top/bottom heating. You can set a temperature between 85 °C and 140 °C.

The "Types of heating" operating mode must be selected. The selection list for the types of heating appears on the touch-screen displays.

1. Touch the "Sabbath mode" text field.  
The default temperature is highlighted white in the display.
2. Set the required temperature using the rotary selector.
3. Before starting the operation, touch the "Cooking time" text field.  
The default cooking time is highlighted white in the display.
4. Set the required cooking time using the rotary selector.  
**Note:** The end time is calculated automatically but cannot be changed.
5. Press the  Start/Stop button to start.  
The cooking time counts down on the display.

The appliance begins to heat up.



When the cooking time for Sabbath mode has ended, an audible signal sounds. The appliance stops heating. The cooking time 00 m 00 s is shown on the display.

Press the  On/Off button to switch off the appliance.

**Note:** The operation is not interrupted if you open the appliance door.

### Changing and cancelling

After starting the appliance, the settings can no longer be changed.

If you would like to cancel Sabbath mode, switch the appliance off using the  On/Off button. You can no longer pause the operation using the  Start/Stop button.

## Cleaning

With good care and cleaning, your appliance will retain its appearance and remain fully functioning for a long time to come. We will explain here how you should correctly care for and clean your appliance.

### Suitable cleaning agents

To ensure that the different surfaces are not damaged by using the wrong cleaning agent, observe the information in the table. Depending on the appliance model, not all of the areas listed may be on/in your appliance.

#### Caution!

#### Risk of surface damage

Do not use:

- Harsh or abrasive cleaning agents,
- Cleaning agents with a high alcohol content,
- Hard scouring pads or cleaning sponges,
- High-pressure cleaners or steam cleaners,
- Special cleaners for cleaning the appliance while it is hot.

Wash new sponge cloths thoroughly before use.

**Tip:** Highly recommended cleaning and care products can be purchased through the after-sales service. Observe the respective manufacturer's instructions.

#### Warning – Risk of burns!

The appliance becomes very hot. Never touch the interior surfaces of the cooking compartment or the heating elements. Always allow the appliance to cool down. Keep children at a safe distance.

| Area                      | Cleaning   |
|---------------------------|--|
| <b>Appliance exterior</b> |  |
| Stainless steel front     | Hot soapy water:<br>Clean with a dish cloth and then dry with a soft cloth.<br><br>Remove flecks of limescale, grease, starch and albumin (e.g. egg white) immediately. Corrosion can form under such flecks.<br><br>Special stainless steel cleaning products suitable for hot surfaces are available from our after-sales service or from specialist retailers. Apply a very thin layer of the cleaning product with a soft cloth. |
| Plastic                   | Hot soapy water:<br>Clean with a dish cloth and then dry with a soft cloth.<br><br>Do not use glass cleaner or a glass scraper.  |
| Painted surfaces          | Hot soapy water:<br>Clean with a dish cloth and then dry with a soft cloth.  |
| Control panel             | Hot soapy water:<br>Clean with a dish cloth and then dry with a soft cloth.<br><br>Do not use glass cleaner or a glass scraper.  |

|             |  |
|-------------|--|
| Door panels | Hot soapy water:<br>Clean with a dish cloth and then dry with a soft cloth.<br><br>Do not use a glass scraper or a stainless steel scouring pad.   |
| Door handle | Hot soapy water:<br>Clean with a dish cloth and then dry with a soft cloth.<br><br>If descaler comes into contact with the door handle, wipe it off immediately. Otherwise, any stains will not be able to be removed. |

### Appliance interior

|                                       |  |
|---------------------------------------|--|
| Enamelled surfaces                    | Hot soapy water or a vinegar solution:<br>Clean with a dish cloth and then dry with a soft cloth.<br><br>Soften baked-on food residues with a damp cloth and soapy water. Use stainless steel wire wool or oven cleaner to remove stubborn dirt.<br><br>Leave the cooking compartment open to dry after cleaning.<br><br>Using the cleaning function gives the best results. → "Cleaning function" on page 23<br><br><b>Note:</b> Food residues can cause white deposits to form. These are harmless and do not affect how the appliance works.<br>Remove using lemon juice if required. |
| Glass cover for the interior lighting | Hot soapy water:<br>Clean with a dish cloth and then dry with a soft cloth.<br><br>If the cooking compartment is heavily soiled, use oven cleaner.   |
| Stainless steel door cover            | Stainless steel cleaner:<br>Observe the manufacturer's instructions.<br>Do not use stainless steel care products.<br>Remove the door cover for cleaning.   |
| Rails                                 | Hot soapy water:<br>Soak and clean with a dish cloth or brush.   |
| Pull-out system                       | Hot soapy water:<br>Clean with a dish cloth or a brush.<br><br>Do not remove the lubricant while the pull-out rails are pulled out – it is best to clean them when they are pushed in. Do not clean in the dishwasher.   |
| Accessories                           | Hot soapy water:<br>Soak and clean with a dish cloth or brush.<br><br>If there are heavy deposits of dirt, use a stainless steel scouring pad.   |
| Meat thermometer                      | Hot soapy water:<br>Clean with a dish cloth or a brush.<br><br>Do not clean in the dishwasher.   |

**Notes**

- Slight differences in colour on the front of the appliance are caused by the use of different materials, such as glass, plastic and metal.
- Shadows on the door panels, which look like streaks, are caused by reflections made by the interior lighting.
- Enamel is baked on at very high temperatures. This can cause some slight colour variation. This is normal and does not affect operation. The edges of thin trays cannot be completely enamelled. As a result, these edges can be rough. This does not impair the anti-corrosion protection.

**Keeping the appliance clean**

Always keep the appliance clean and remove dirt immediately so that stubborn deposits of dirt do not build up.

**Tips**

- Clean the cooking compartment after each use. This will ensure that dirt cannot be baked on.
- Always remove flecks of limescale, grease, starch and albumin (e.g. egg white) immediately.
- Use the universal pan for baking very moist cakes.
- Use suitable ovenware for roasting, e.g. a roasting dish.

**Cleaning function**

The cooking compartment can be cleaned effortlessly with the "Pyrolytic system" cleaning function. The cooking compartment is heated to an extremely high temperature. This burns off residues from roasting, grilling and baking.

You can choose from three cleaning settings.

| Setting | Cleaning level | Duration                   |
|---------|----------------|----------------------------|
| 1       | Light          | Approx. 1 hour, 15 minutes |
| 2       | Medium         | Approx. 1 hour, 30 minutes |
| 3       | Intensive      | Approx. 2 hours            |

The dirtier the cooking compartment and the longer the dirt has been there, the higher the cleaning setting should be. It is sufficient to clean the cooking compartment every two to three months. If required, you can clean the oven more frequently. A cleaning cycle requires only approx. 2.5 – 4.7 kilowatt hours.

**Notes**

- For safety reasons, the appliance door locks automatically once a certain temperature is reached. It cannot be reopened until the  symbol for the locking mechanism on the display goes out.
- The interior lighting does not come on during the cleaning function.

**Warning**
**Risk of burns!**

- The cooking compartment becomes extremely hot during the cleaning function. Never open the appliance door. Allow the appliance to cool down. Keep children away from the appliance.
-  The appliance will become very hot on the outside during the cleaning function. Never touch the appliance door. Allow the appliance to cool down. Keep children away from the appliance.

**Prior to initiating the cleaning function**

While cleaning is in progress, you can clean an accessory at the same time, e.g. the universal pan or the baking tray. Before cleaning is started, remove the worst dirt. Slide the accessory in at level 2.

Clean the inside of the appliance door and along the surface edges of the cooking compartment in the area around the seal. Do not scrub the seal and do not remove!

**Note:** When using the cleaning function, you can clean the enamel accessory provided at the same time. You cannot clean any of the wire racks when using the cleaning function. The wire racks are not suitable for cleaning using the cleaning function; this will discolour them. Further accessories suitable for cleaning using the cleaning function are listed in the table for special accessories. → "Accessories" on page 11

### **Warning**

#### **Risk of fire!**

- Loose food residues, grease and meat juices may catch fire during the cleaning function. Before starting the cleaning function, remove coarse dirt from the cooking compartment and from the accessories.
- The appliance will become very hot on the outside during the cleaning function. Never hang combustible objects, e.g. tea towels, on the door handle. Do not place anything against the front of the appliance. Keep children away from the appliance.

### **Warning – Risk of serious damage to health!**

The appliance will become very hot during the cleaning function. The non-stick coating on baking trays and tins is destroyed and noxious gases are released. Never clean non-stick baking trays and baking tins using the cleaning function. Only clean enamelled accessories using the cleaning function.

## Setting the cleaning function

Before setting the cleaning function, ensure that you have followed all instructions for preparation.

The duration of each cleaning setting is preset and cannot be changed.

1. Touch the **Menu** field.  
The list of operating modes is displayed.
2. Touch the "Pyrolytic self-cleaning" text field.  
The cleaning setting is highlighted in white in the display.
3. Turn the rotary selector to set the cleaning setting.  
The end time is calculated automatically.
4. Press the  Start/Stop button to start.  
The duration counts down in the display. The heating line does not appear for the cleaning function.

The cleaning function starts.

Ventilate the kitchen when the cleaning function is running.

The appliance door locks shortly after the function starts running. A message and the  symbol appear on the display.

When the cleaning function has ended, an audible signal sounds. The duration 00 m 00 s is shown in the display. Press the  On/Off button to switch off the appliance.

The appliance door cannot be reopened until the  symbol for the locking mechanism goes out.



## Setting a later end time

You can set a later end time. Before starting the appliance, touch the "End" text field and set a later end time using the rotary selector.

The appliance switches to standby after it is started. The end time can no longer be changed.

## Changing and cancelling

After starting the appliance, the cleaning setting can no longer be changed.

If you would like to cancel the cleaning function, switch the appliance off using the  On/Off button. You can no longer pause the operation using the  Start/Stop button.

The appliance door remains locked until the  symbol for the locking mechanism on the display goes out.

## Once the cleaning function has ended

Once the cooking compartment has cooled down, use a damp cloth to wipe off the ash that has been left behind in the cooking compartment, in the accessories on the racks and around the appliance door.

Wipe the pull-out rails with a damp cloth. Then slide the pull-out rails in and out several times. After cleaning, some discolouration may remain on the pull-out rails. This has no effect on performance.

**Note:** Very bad soiling may cause white deposits to remain on the enamel surfaces. This is residue from the food and is harmless. It does not affect performance. You can remove these residues using lemon juice if required.



## Rails

With good care and cleaning, your appliance will retain its appearance and remain fully functional for a long time to come. This will tell you how to remove the shelves and clean them.

### Detaching and refitting the rails

#### **Warning – Risk of burns!**

The rails become very hot. Never touch the hot rails. Always allow the appliance to cool down. Keep children away from the appliance.

#### Detaching the rails

1. Lift the rail slightly at the front **a** and detach it **b** (figure **1**).
2. Then pull the whole rail towards you and take it out (figure **2**).

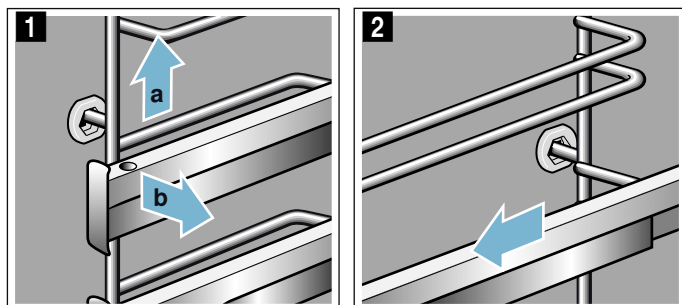

Clean the rails with cleaning agent and a sponge. For stubborn deposits of dirt, use a brush.

#### Attaching the rails

The rails only fit on the right or the left side. The pull-out rails must pull out towards you.

1. First, insert the rail in the middle of the rear socket **a**, until the rail rests against the cooking compartment wall, and push it back **b** (figure **1**).
2. Then insert the rail into the front socket **c**, until the rail also rests against the cooking compartment wall here, and press it downwards **d** (figure **2**).

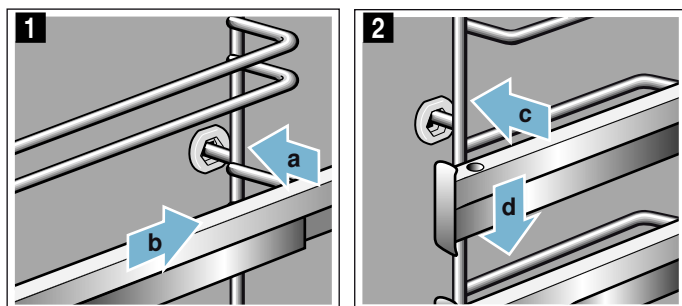

## Appliance door

With good care and cleaning, your appliance will retain its appearance and remain fully functional for a long time to come. This will tell you how to remove the appliance door and clean it.

### Removing and fitting the appliance door

For cleaning purposes and to remove the door panels, you can detach the appliance door.

The appliance door hinges each have a locking lever. When the locking levers are closed (figure **1**), the appliance door is secured in place. It cannot be detached.

When the locking levers are open in order to detach the appliance door (figure **2**), the hinges are locked. They cannot snap shut.

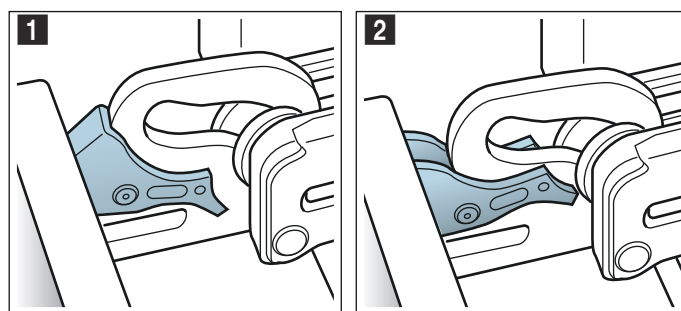

#### **Warning** **Risk of injury!**

- If the hinges are not locked, they can snap shut with great force. Ensure that the locking levers are always fully closed or, when detaching the appliance door, fully open.
- The hinges on the appliance door move when opening and closing the door, and you may be trapped. Keep your hands away from the hinges.

#### Removing the appliance door

1. Open the appliance door fully and push it in the direction of the appliance.
2. Fold up the two locking levers on the left and right (figure **1**).
3. Close the appliance door as far as it goes **a**. With both hands, grip the door on the left- and right-hand side and pull it up and out (figure **2**).

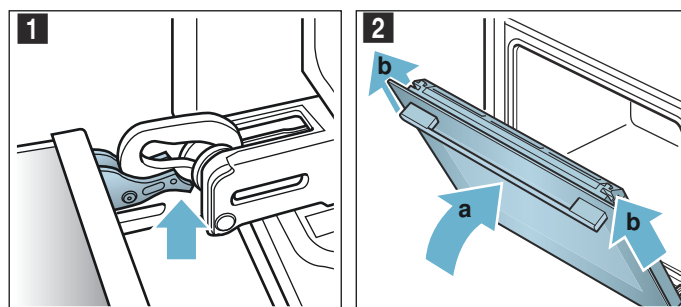

### Fitting the appliance door

Reattach the appliance door in the opposite sequence to removal.

1. When attaching the appliance door, ensure that both hinges are inserted straight into the opening (figure 1).  
Place both hinges at the bottom on the outer panel and use this as a guide.  
Ensure that the hinges are inserted into the correct opening. You must be able to insert them easily and without resistance. If you can feel any resistance, check that the hinges are inserted into the correct opening.

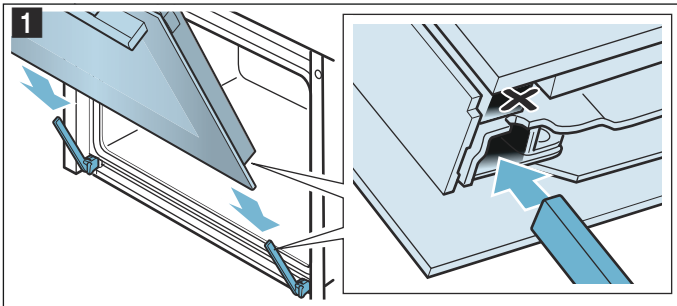

2. Open the appliance door fully. Fold both locking levers closed again (figure 2).

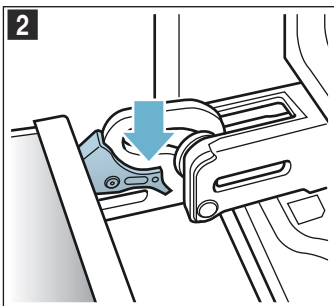

3. Close the cooking compartment door.

### Removing the door cover

The stainless steel inlay in the door cover may become discoloured. To carry out thorough cleaning, you can remove the cover. → "Cleaning" on page 22

1. Open the appliance door slightly.
2. Press on the right and left side of the cover (figure 1).
3. Remove the cover (figure 2).  
Close the appliance door carefully.

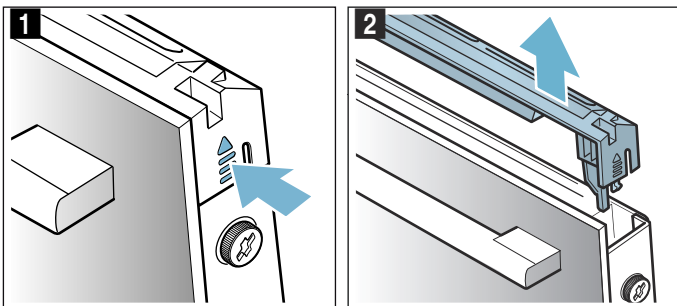

**Note:** Clean the stainless steel inlay in the cover with stainless steel cleaner. Clean the rest of the door cover with soapy water and a soft cloth.

4. Open the appliance door again slightly. Put the cover back in place and press on it until it clicks audibly into place (figure 3).

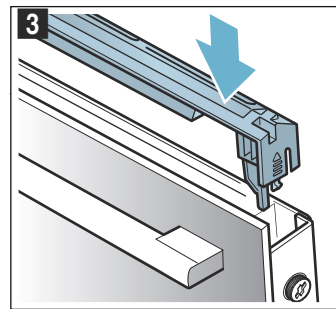

5. Close the appliance door.

### Removing and installing the door panels

To facilitate cleaning, you can remove the glass panels from the appliance door.

#### Removing the door from the appliance

1. Open the appliance door slightly.
2. Press on the right and left side of the cover (figure 1).
3. Remove the cover (figure 2).

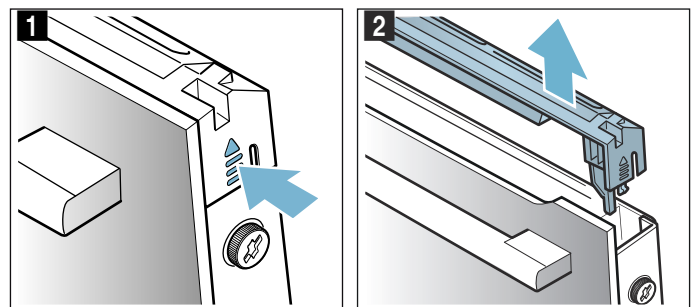

4. Loosen and remove the screws on the left and right of the appliance door (figure 3).
5. Before closing the door again, trap a tea towel which has been folded several times in the door (figure 4).  
Pull out the front panel upwards and lay it on a flat surface with the door handle facing downwards.

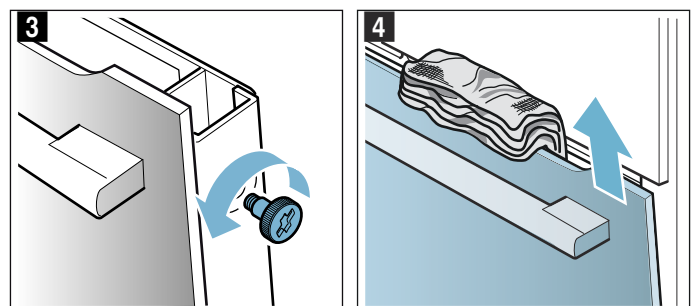

6. Push both retainers on the intermediate panel upwards, but do not remove it (figure 5). Hold the panel with one hand. Remove the panel.

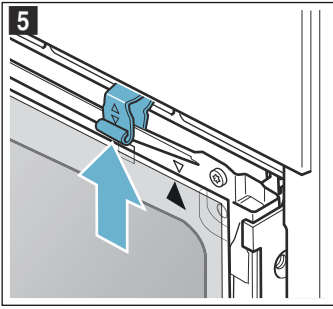

Clean the panels with glass cleaner and a soft cloth.

**⚠ Warning**  
**Risk of injury!**

- Scratched glass in the appliance door may develop into a crack. Do not use a glass scraper, sharp or abrasive cleaning aids or detergents.
- The hinges on the appliance door move when opening and closing the door, and you may be trapped. Keep your hands away from the hinges.

### Fitting the door on the appliance

When fitting the intermediate panel, make sure that the arrow is in the top right of the panel and that it aligns with the arrow on the metal panel.

1. Insert the intermediate panel at the bottom into the retainer and push it in firmly at the top (figure 1).
2. Push both retainers downwards (figure 2).

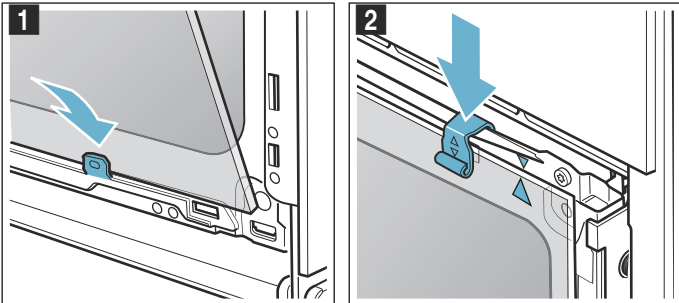

3. Insert the front panel at the bottom into the retainers (figure 3).
4. Close the front panel until both upper hooks are opposite the opening (figure 4).

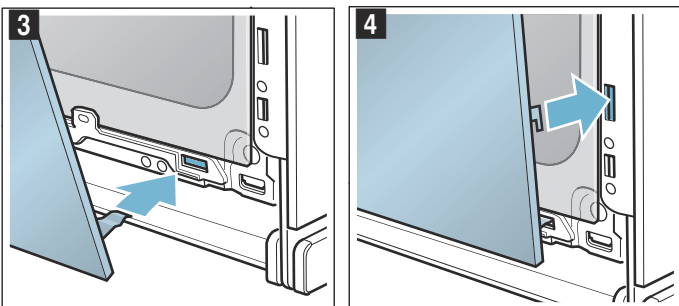

5. Press the front panel at the bottom until it clicks audibly into place (figure 5).
6. Open the appliance door again slightly and remove the tea towel.
7. Screw both screws back in on the left and right.
8. Put the cover back in place and press on it until it clicks audibly into place (figure 6).

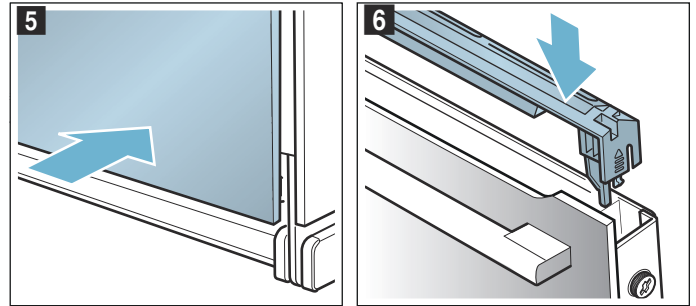

9. Close the appliance door.

**Caution!**

Do not use the cooking compartment again until the panels have been correctly fitted.





## Trouble shooting

If a fault occurs, there is often a simple explanation. Before calling the after-sales service, please refer to the fault table and attempt to correct the fault yourself.

### Rectifying faults yourself

You can often easily rectify technical faults on the appliance yourself.

If a dish does not turn out exactly as you wanted, you can find many tips and instructions for preparation at the end of the operating manual. → "Tested for you in our cooking studio" on page 32

| Fault   | Possible cause  | Notes/remedy   |
|---|---|--|
| The appliance does not work.  | Faulty fuse.  | Check the circuit breaker in the fuse box.   |
|   | Power cut   | Check whether the kitchen light or other kitchen appliances are working.   |
| "Sprache Deutsch" appears on the display.   | Power cut   | Reset the language and the time.   |
| The time does not appear when the appliance is switched off.  | Basic setting is changed.   | Change the basic setting for the clock display.  |
| The appliance door cannot be opened.  | The appliance door is locked with the childproof lock.                      | Deactivate the childproof lock by pressing the  field for approx. 4 seconds. The lock can be switched off in the basic settings.  |
| The appliance door cannot be opened; the  symbol lights up on the display. | The appliance door is locked due to the cleaning function.                  | Wait until the cooking compartment has cooled and the  symbol goes out.   |
| The appliance does not heat up; the  symbol lights up on the display.      | Demo mode is activated in the basic settings.                               | Briefly disconnect the appliance from the mains (switch off the circuit breaker in the fuse box) and then deactivate demo mode in the basic settings within 3 minutes.   |
| The appliance will not start and "Cooking compartment too hot" appears on the display   | The cooking compartment is too hot for the selected dish or type of heating | Allow the cooking compartment to cool down and start again   |
| The rotary selector has fallen out of the support in the control panel.   | The rotary selector has been accidentally disengaged.                       | The rotary selector can be removed. Simply place the rotary selector back in its support in the control panel and push it in so that it engages and can be turned as usual.  |
| The rotary selector can no longer be turned easily.   | There is dirt under the rotary selector.                                    | The rotary selector can be removed. To disengage the rotary selector, simply remove it from the support. Alternatively, press on the outer edge of the rotary selector so that it tips and can be picked up easily.<br>Carefully clean the rotary selector and its support on the appliance using a cloth and soapy water. Dry with a soft cloth. Do not use any sharp or abrasive materials. Do not soak or clean in the dishwasher.<br>Do not remove the rotary selector too often so that the support remains stable. |

### Warning – Risk of electric shock!

Incorrect repairs are dangerous. Repairs may only be carried out and damaged power cables replaced by one of our trained after-sales technicians. If the appliance is defective, unplug the appliance from the mains or switch off the circuit breaker in the fuse box. Contact the after-sales service.

### Error messages on the display

When an error message appears on the display with "D" or "E", e.g. D0111 or E0111, switch the appliance off and on again using the  On/Off button.

If it was a one-off error, the display goes out. If the error message appears again, call the after-sales service and quote the exact error message.

### Maximum operating time

If you do not change the settings on your appliance for several hours, the appliance stops heating up automatically. This prevents unwanted continuous operation.

The respective settings for the operating mode govern when the maximum operating time is reached.

#### Maximum operating time reached

A note appears on the display confirming that the maximum operating time has been reached.

To continue operation, touch any field or turn the rotary selector.

Switch the appliance off using the  On/Off button if you do not need to use it.

**Tip:** Set a cooking time so that the appliance does not switch off when you do not want it to, e.g. with an extremely long preparation time. The appliance heats up until the set cooking time has elapsed.

## Replacing the bulb in the top of the cooking compartment

If the cooking compartment light bulb fails, it must be replaced. Heat-resistant, 40 watt, 230 V halogen bulbs are available from the after-sales service or specialist retailers.

When handling the halogen bulb, use a dry cloth. This will increase the service life of the bulb. Only use these bulbs.

### **⚠ Warning – Risk of electric shock!**

When replacing the cooking compartment bulb, the bulb socket contacts are live. Before replacing the bulb, unplug the appliance from the mains or switch off the circuit breaker in the fuse box.

### **⚠ Warning – Risk of burns!**

The appliance becomes very hot. Never touch the interior surfaces of the cooking compartment or the heating elements. Always allow the appliance to cool down. Keep children at a safe distance.

1. Place a tea towel in the cold cooking compartment to prevent damage.
2. Turn the glass cover anti-clockwise to remove it (figure **1**).
3. Pull out the bulb – do not turn it (figure **2**). Insert the new bulb, making sure that the pins are in the correct position. Push the bulb in firmly.

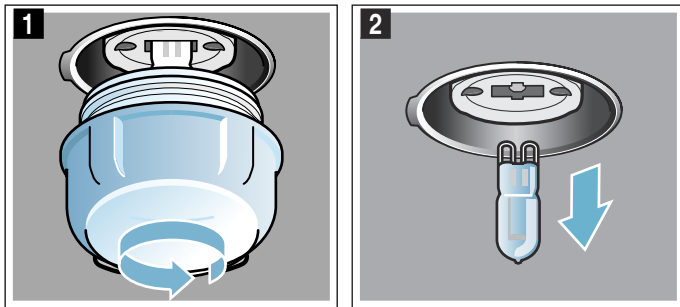

4. Screw the glass cover back in.
5. Remove the tea towel and switch on the circuit breaker.

## Glass cover

If the glass cover of the halogen bulb is damaged, it must be replaced. You can obtain a new glass cover from the after-sales service. Please specify the E number and FD number of your appliance.

## Customer service

Our after-sales service is there for you if your appliance needs to be repaired. We will always find an appropriate solution, also in order to avoid after-sales personnel having to make unnecessary visits.

### E number and FD number

When calling us, please quote the full product number (E no.) and the production number (FD no.) so that we can provide you with the correct advice. The rating plate bearing these numbers can be found when you open the appliance door.

If your appliance operates with steam, you will find the rating plate on the right-hand side behind the panel.

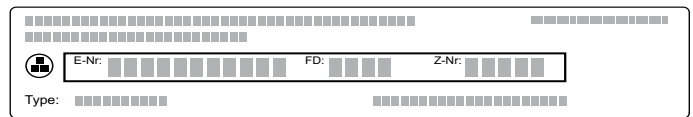

To save time, you can make a note of the numbers for your appliance and the telephone number of the after-sales service in the space below in case you need them.

E no.

FD no.

After-sales service 

Please note that a visit from an after-sales service engineer is not free of charge in the event that the appliance has been misused, even during the warranty period.

Please find the contact data of all countries in the enclosed customer service list.

### To book an engineer visit and product advice

**GB** 0344 892 8979

Calls charged at local or mobile rate.

**IE** 01450 2655

0.03 € per minute at peak. Off peak 0.0088 € per minute.

Rely on the professionalism of the manufacturer. You can therefore be sure that the repair is carried out by trained service technicians who carry original spare parts for your appliances.

## Dishes

You can use the "Assist" operating mode to prepare a wide variety of food. The appliance selects the optimal settings for you.

To achieve good results, the cooking compartment must not be too hot for the type of food you have selected. If it is, a message will appear on the display. Allow the cooking compartment to cool down and start again.

### Information on the settings

- The cooking result depends on the quality of the food and the size and type of cookware. For an optimal cooking result, use food that is in good condition and chilled meat only. For frozen food, use food straight out of the freezer only.
- For some food, a temperature, heating mode and cooking time is suggested. The temperature and the cooking time can be changed according to your requirements.
- For other dishes, you will be asked to enter the weight. Always enter the total weight unless the appliance asks for something different. The appliance will then apply the time and temperature settings for you.  
It is not possible to set weights outside of the intended weight range.
- When roasting dishes for which the appliance will apply the temperature selection for you, temperatures of up to 300 °C can be saved. Therefore, make sure that you use cookware that is sufficiently heat resistant.
- Information is provided, e.g. on cookware, shelf position or the addition of liquid when cooking meat. Some food requires turning or stirring, etc., during cooking. This is shown in the display shortly after operation starts. An audible signal will remind you at the right time.
- Information on the right kind of cookware to use and tips and tricks for the preparation can be found at the end of the instruction manual. → "Tested for you in our cooking studio" on page 32

### Meat thermometer

For some food, you can also use the meat thermometer. Once you have inserted the meat thermometer into the appliance, the food that is suitable for it will be displayed. You can change the interior temperature of the cooking compartment and the core temperature. → "Meat thermometer" on page 18

### Selecting a dish

The dishes are arranged in a uniform structure:

- Category
- Food
- Dish

The following table lists the categories with the corresponding food. One or more dishes are listed beside each food.

| Categories      | Food                                      |
|-----------------|---|
| Cakes, bread    | Cake                                      |
|                 | Small baked items                         |
|                 | Biscuits                                  |
|                 | Bread and rolls                           |
| Bakes, soufflés | Savoury cakes, pizza, quiches             |
|                 | Bake, savoury, fresh, cooked ingredients  |
|                 | Lasagne, fresh                            |
|                 | Potato gratin, raw ingredients, 4 cm deep |
| Frozen products | Bake, sweet, fresh                        |
|                 | Soufflé in individual moulds              |
|                 | Pizza                                     |
|                 | Bread rolls                               |
| Poultry         | Bakes                                     |
|                 | Potato products                           |
|                 | Poultry, fish                             |
| Meat            | Chicken                                   |
|                 | Duck, goose                               |
|                 | Turkey                                    |
|                 | Pork                                      |
|                 | Beef                                      |
| Fish            | Veal                                      |
|                 | Lamb                                      |
| Vegetables      | Game                                      |
|                 | Meat dishes                               |
|                 | Fish                                      |
|                 | Vegetable stew                            |
| Vegetables      | Vegetables au gratin                      |
|                 | Baked potatoes, halved                    |
|                 | Baked potatoes, whole                     |

## Baking sensor

Your appliance is equipped with a baking sensor. This sensor is automatically activated when you select a baked item from any of the following categories in the selection list.

| Category           | Food                         | Dishes                |
|--------------------|------------------------------|-----------------------|
| Cake, bread, pizza | Cake                         | Cakes in tins         |
|                    |                              | Cakes on trays        |
|                    |                              | Pies/tarts            |
|                    | Small baked items            | Puff pastry           |
|                    |                              | Muffins               |
|                    |                              | Leavened cake         |
|                    | Bread/bread rolls            | Bread rolls           |
|                    |                              | Bread                 |
|                    |                              | Flatbread             |
|                    | Savoury cakes, pizza, quiche | Savoury cakes, quiche |
|                    |                              | Pizza                 |
|                    |                              | Tarte flambée         |
| Frozen products    | Potato products              | Potato products       |

The appliance now takes over. The appliance then regulates the baking process completely automatically – you do not need to implement any further settings. Once the food is cooked, the appliance will switch itself off automatically. An audible signal will then sound. The cooking time is roughly the same as that listed in the recipe for your baked item and is not displayed. The oven sensor can only be started from the oven when it is cool.

No other baked goods categories are monitored by the baking sensor. In this case, you will be offered a tried and tested setting with customisation options.

Dark-coloured metal baking tins are suitable. Do not use any silicone bakeware or accessories that contain silicone. Otherwise, the baking sensor will be damaged.

The baking sensor is active while "Do not open door" is shown on the display. Do not open the appliance door; otherwise, the settings will be cancelled. The appliance will continue to heat and you can adjust the suggested time. You must monitor the process yourself.

## Applying settings for dishes

You will be guided through the entire setting process for your chosen food.

Use the rotary selector to scroll through the individual levels.

1. Touch the **Menu** field.  
The list of operating modes is displayed.
2. Touch the "Assist" text field.  
The categories are displayed.
3. Touch the required category.  
The foods in this category are displayed.
4. Touch the required food.  
The individual dishes are displayed.

5. Touch the required dish.  
The settings for this dish appear on the display. For many dishes, you can change the settings to suit your needs.  
For some dishes, you must set the weight instead.  
**Tip:** The "Tip" text field provides you with information about accessories and shelf height.
6. Press the  $\triangleright$  Start/Stop button to start.  
The cooking time counts down in the display.  
The appliance begins to heat up.

Once the cooking time has elapsed, an audible signal sounds. The appliance stops heating up.

When your dish is ready, use the  $\odot$  On/Off button to switch off the appliance.

### Continue cooking

After the cooking time has ended, you can leave some dishes to continue cooking if you are not satisfied with the cooking result.

A query appears on the display, which asks if you want to continue cooking. If you want to continue cooking, touch the "Extend cooking time" text field. A cooking time is suggested, which can be changed. Press the  $\triangleright$  Start/Stop button to start.

**Note:** You can extend the cooking time as often as required.

If you are satisfied with the cooking result, touch the "Finish" text field.

Press the  $\odot$  On/Off button to switch off the appliance.

### Setting a later end time

You can set a later end time for some dishes. Before starting the appliance, touch the "End" text field and set a later end time using the rotary selector.

The appliance switches to standby after it is started. The end time can no longer be changed.

### Changing and cancelling

After starting the appliance, the settings can no longer be changed.

If you would like to cancel the operation, switch the appliance off using the  $\odot$  On/Off button. You can no longer pause the operation using the  $\triangleright$  Start/Stop button.

## Tested for you in our cooking studio

Here, you can find a selection of dishes and the ideal settings for them. We will show you which type of heating and temperature are best suited to your dish. You will get information on suitable cooking accessories and the height at which they should be placed in the oven. You will also get tips about cookware and preparation methods.

**Note:** A lot of steam can build up in the cooking compartment when cooking food. Your appliance is very energy-efficient and radiates very little heat to its surroundings during operation. Due to the high difference in temperature between the appliance interior and the external parts of the appliance, condensation may build up on the door, control panel or adjacent kitchen cabinet panels. This is a normal physical phenomenon. Condensation can be reduced by preheating the oven or opening the door carefully.

### Do not use silicone moulds

For optimal cooking results, we recommend using dark-coloured metal bakeware.

#### Caution!

Do not use silicone bakeware, accessories that contain silicone or film. Otherwise, the baking sensor may be damaged. Even if the oven sensor is not being used, it may still be damaged. Exception: If the appliance comes with a meat probe, this can be used.

### Cakes and small baked items

Your appliance offers you a range of heating types for the preparation of cakes and small baked items. You can find the ideal settings for many dishes in the settings tables.

Also refer to the notes in the section on allowing dough to rise.

Only use original accessories supplied with your appliance. These have been tailored to the cooking compartment and the operating modes of your appliance.

#### Shelf positions

Use the indicated shelf positions.

#### Baking on one level

When baking on one level, use the following shelf positions:

- Tall baked items: Level 2
- Flat baked items: Level 3

If you are using 4D Hot air as the type of heating, you can choose between levels 1, 2, 3 and 4.

#### Baking on several levels

Use 4D hot air. Baked items that are placed into the oven on trays or in baking tins/dishes at the same time will not necessarily be ready at the same time.

Baking on two levels:

- Universal pan: Level 3  
Baking tray: Level 1
- Baking tins/dishes on the wire rack  
First wire rack: Level 3  
Second wire rack: Level 1

Baking on three levels:

- Baking tray: Level 5  
Universal pan: Level 3  
Baking tray: Level 1

Baking on four levels:

- 4 wire racks with greaseproof paper  
First wire rack: Level 5  
Second wire rack: Level 3  
Third wire rack: Level 2  
Fourth wire rack: Level 1

By preparing several dishes at the same time, you can make energy savings of up to 45 per cent. Position baking tins/dishes next to one another or offset and vertically stacked in the cooking compartment.

#### Accessories

Ensure that you always use suitable accessories and that they are placed in the oven the right way around.

#### Wire rack

Insert the wire rack with the open side facing the appliance door and the curved lip pointing downwards. Always place ovenware, tins and dishes on the wire rack.

#### Universal pan or baking tray

Slide the universal pan or the baking tray in carefully as far as the limit stop with the bevelled edge facing the appliance door.

When baking moist cakes or pastries with many toppings, use the universal pan so that any excess liquid does not overflow and make the cooking compartment dirty.

#### Baking tins

Dark- coloured metal baking tins are most suitable.

Tinplate baking tins, ceramic dishes and glass dishes extend baking time and mean that the baked item will not brown evenly. If you wish to bake using these baking tins/dishes and using top/bottom heating, slide in the tin/dish at level 1.

#### Greaseproof paper

Only use greaseproof paper that is suitable for the selected temperature. Always cut greaseproof paper to size.

#### Recommended setting values

The table lists the optimal heating type for various baked items. The temperature and baking time depend on the amount and consistency of the dough/mixture. For this reason, the table specifies setting ranges. Try using the lower values to start with. A lower temperature will result in more even browning. You can use a higher setting next time if necessary.



**Note:** Baking times cannot be reduced by using higher temperatures. Cakes or small baked items would only be cooked on the outside, and would not be fully baked in the middle.



The setting values apply to food that is placed into a cold cooking compartment; by doing this, you can make energy savings of up to 20 per cent. If you preheat the oven, you can reduce the indicated baking times by several minutes.













Preheating is necessary for selected food, and this is indicated in the table. Do not place your food or accessories into the cooking compartment until it has finished preheating.















If you wish to follow one of your own recipes when baking, you should use the setting values listed for similar baked items in the table as reference. Additional information can be found in the baking tips listed after the settings table.

Remove unused accessories from the cooking compartment. This will ensure that you achieve the best possible cooking results and energy savings of up to 20 per cent.

Types of heating used:

-  4D hot air
-  Top/bottom heating
-  Pizza setting

| Dish   | Accessories/cookware         | Shelf position | Heating function  | Temperature in °C | Cooking time in mins. |
|--|------------------------------|----------------|---|-------------------|-----------------------|
| <b>Cakes in tins</b>                                 |                              |                |   |                   |                       |
| Sponge cake, simple                                  | Ring tin/cake tin            | 2              |    | 150-170           | 50-70                 |
| Sponge cake, simple, 2 levels                        | Ring tin/cake tin            | 3+1            |    | 140-160           | 60-80                 |
| Sponge cake, delicate                                | Ring tin/cake tin            | 2              |    | 150-170           | 60-80                 |
| Fruit flan made from sponge mixture, delicate        | Ring/springform cake tin     | 2              |    | 160-180           | 40-60                 |
| Sponge flan base                                     | Flan base tin                | 3              |    | 160-180           | 20-30                 |
| Fruit tart or cheesecake with shortcrust pastry base | Springform cake tin, Ø 26 cm | 2              |    | 170-190           | 60-80                 |
| Swiss flan   | Pizza tray                   | 3              |   | 170-190           | 45-55                 |
| Tart   | Flan-base cake tin, black    | 3              |  | 190-210           | 25-40                 |
| Bundt yeast cake                                     | Ring cake tin                | 2              |  | 150-170           | 50-70                 |
| Yeast cake   | Springform cake tin, Ø 28 cm | 2              |  | 160-170           | 20-30                 |
| Sponge base, 2 eggs                                  | Flan base tin                | 3              |  | 150-170*          | 20-30                 |
| Sponge flan, 3 eggs                                  | Springform cake tin, Ø 26 cm | 2              |  | 160-170*          | 25-35                 |
| Sponge flan, 6 eggs                                  | Springform cake tin, Ø 28 cm | 2              |  | 150-170*          | 30-50                 |

|  |                             |     |   |          |       |
|--|-----------------------------|-----|---|----------|-------|
| <b>Cakes on baking trays</b>               |                             |     |   |          |       |
| Sponge cake with topping                   | Baking tray                 | 3   |  | 160-180  | 20-40 |
| Sponge cake, 2 levels                      | Universal pan + baking tray | 3+1 |  | 140-160  | 30-50 |
| Shortcrust tart with dry topping           | Baking tray                 | 3   |  | 170-190  | 25-35 |
| Shortcrust tart with dry topping, 2 levels | Universal pan + baking tray | 3+1 |  | 160-170  | 35-45 |
| Shortcrust tart with moist topping         | Universal pan               | 3   |  | 160-180  | 55-65 |
| Swiss flan                                 | Universal pan               | 3   |  | 170-190  | 45-55 |
| Yeast cake with dry topping                | Universal pan               | 3   |  | 160-180  | 15-20 |
| Yeast cake with dry topping, 2 levels      | Universal pan + baking tray | 3+1 |  | 150-170  | 20-30 |
| Yeast cake with moist topping              | Universal pan               | 3   |  | 180-200  | 30-40 |
| Yeast cake with moist topping, 2 levels    | Universal pan + baking tray | 3+1 |  | 150-170  | 45-60 |
| Plaited loaf, savarin                      | Baking tray                 | 2   |  | 160-170  | 25-35 |
| Swiss roll                                 | Baking tray                 | 3   |  | 180-200* | 8-15  |
| Stollen with 500 g flour                   | Baking tray                 | 2   |  | 150-170  | 45-60 |
| Strudel, sweet                             | Universal pan               | 2   |  | 170-180  | 50-60 |
| Strudel, frozen                            | Universal pan               | 3   |  | 200-220  | 35-45 |

\* Preheat

\*\* Preheat for 5 mins., do not use quick heat function

| Dish                        | Accessories/cookware         | Shelf position | Heating function | Temperature in °C | Cooking time in mins. |
|-----------------------------|------------------------------|----------------|------------------|-------------------|-----------------------|
| <b>Small baked items</b>    |                              |                |                  |                   |                       |
| Small cakes                 | Baking tray                  | 3              |                  | 160**             | 20-30                 |
| Small cakes                 | Baking tray                  | 3              |                  | 150**             | 25-35                 |
| Small cakes, 2 levels       | Universal pan + baking tray  | 3+1            |                  | 150**             | 25-35                 |
| Small cakes, 3 levels       | Baking trays + universal pan | 5+3+1          |                  | 140**             | 35-45                 |
| Muffins                     | Muffin tray                  | 3              |                  | 170-190           | 15-20                 |
| Muffins, 2 levels           | Muffin trays                 | 3+1            |                  | 160-180*          | 15-30                 |
| Small yeast cakes           | Baking tray                  | 3              |                  | 160-180           | 25-35                 |
| Small yeast cakes, 2 levels | Universal pan + baking tray  | 3+1            |                  | 150-170           | 25-40                 |
| Puff pastry                 | Baking tray                  | 3              |                  | 170-190*          | 20-35                 |
| Puff pastry, 2 levels       | Universal pan + baking tray  | 3+1            |                  | 170-190*          | 20-45                 |
| Puff pastry, 3 levels       | Baking trays + universal pan | 5+3+1          |                  | 170-190*          | 20-45                 |
| Puff pastry, flat, 4 levels | 4 wire racks                 | 5+3+2+1        |                  | 180-200*          | 20-35                 |
| Choux pastry                | Baking tray                  | 3              |                  | 200-220           | 30-40                 |
| Choux pastry, 2 levels      | Universal pan + baking tray  | 3+1            |                  | 190-210           | 35-45                 |
| Danish pastry               | Baking tray                  | 3              |                  | 160-180           | 20-30                 |

|                     |                              |       |  |           |         |
|---------------------|------------------------------|-------|--|-----------|---------|
| <b>Biscuits</b>     |                              |       |  |           |         |
| Viennese whirls     | Baking tray                  | 3     |  | 140-150** | 25-40   |
| Viennese whirls     | Baking tray                  | 3     |  | 140-150** | 25-40   |
| Whirls, 2 levels    | Universal pan + baking tray  | 3+1   |  | 140-150** | 30-40   |
| Whirls, 3 levels    | Baking trays + universal pan | 5+3+1 |  | 130-140** | 35-55   |
| Biscuits            | Baking tray                  | 3     |  | 140-160   | 15-30   |
| Biscuits, 2 levels  | Universal pan + baking tray  | 3+1   |  | 140-160   | 15-30   |
| Biscuits, 3 levels  | Baking trays + universal pan | 5+3+1 |  | 140-160   | 15-30   |
| Meringue            | Baking tray                  | 3     |  | 80-90*    | 120-150 |
| Meringue, 2 levels  | Universal pan + baking tray  | 3+1   |  | 80-90*    | 120-180 |
| Macaroons           | Baking tray                  | 3     |  | 90-110    | 20-40   |
| Macaroons, 2 levels | Universal pan + baking tray  | 3+1   |  | 90-110    | 25-45   |
| Macaroons, 3 levels | Baking trays + universal pan | 5+3+1 |  | 90-110    | 30-45   |

\* Preheat

\*\* Preheat for 5 mins., do not use quick heat function

### Tips on baking

|   |  |
|---|--|
| You want to find out whether the cake is completely cooked in the middle. | Push a cocktail stick into the highest point on the cake. If the cocktail stick comes out clean with no dough residue, the cake is ready.  |
| The cake collapses.   | Next time, use less liquid. Alternatively, set the temperature to be 10 °C lower and extend the baking time. Adhere to the specified ingredients and preparation instructions in the recipe. |
| The cake has risen in the middle but is lower around the edge.            | Only grease the base of the springform cake tin. After baking, loosen the cake carefully with a knife.   |
| The fruit juice overflows.  | Next time, use the universal pan.  |
| Small baked items stick to one another during baking.                     | There should be a gap of approx. 2 cm around each item. This gives enough space for the baked items to expand well and brown on all sides.   |
| The cake is too dry.  | Set the temperature 10 °C higher and shorten the baking time.  |
| The cake is generally too light in colour.                                | If the shelf position and the cookware are correct, then you should increase the temperature if necessary or extend the baking time.   |
| The cake is too light on top, and too dark underneath.                    | Bake the cake one level higher in the oven the next time.  |

|   |   |
|---|---|
| The cake is too dark on top, and too light underneath.  | Bake the cake one level lower in the oven the next time. Select a lower temperature and extend the baking time.   |
| Cakes baked in a tray or tin are too brown at the back.   | Place the baking tray in the middle of the accessories, not directly against the back wall.   |
| The whole cake is too dark.   | Select a lower temperature next time and extend the baking time if necessary.   |
| The cake is unevenly browned.   | Select a slightly lower temperature.<br>Protruding greaseproof paper can affect the air circulation. Always cut greaseproof paper to size.<br>Ensure that the baking tin does not stand directly in front of the openings in the cooking compartment back wall.<br>When baking small items, you should use similar sizes and thicknesses wherever possible. |
| You were baking on several levels. The items on the top baking tray are darker than those on the lower baking tray. | Always select 4D hot air when baking on several levels. Baked items that are placed into the oven on trays or in baking tins/dishes at the same time will not necessarily be ready at the same time.  |
| The cake looks good, but is not cooked properly in the middle.  | Use a lower temperature and bake slightly longer; if necessary, add slightly less liquid. For cakes with a moist topping, bake the base first. Sprinkle it with almonds or breadcrumbs and then place the topping on top.   |
| The cake cannot be turned out of the dish when it is turned upside down.  | Allow the cake to cool down for 5 to 10 minutes after baking. If it still sticks, carefully loosen the cake around the edges again using a knife. Turn the cake tin upside down again and cover it several times with a cold, wet cloth. Next time, grease the baking tin/dish and sprinkle with breadcrumbs.   |

## Bread and rolls

Your appliance offers you a range of heating types for baking bread and rolls. You can find the ideal settings for many dishes in the settings tables.

Also refer to the notes in the section on allowing dough to rise.

Only use original accessories supplied with your appliance. These have been tailored to the cooking compartment and the operating modes of your appliance.

### Shelf positions

Use the indicated shelf positions.

#### Baking on one level

When baking on one level, use the following shelf positions:

- Tall baked items: Level 2
- Flat baked items: Level 3

If you are using 4D Hot air as the type of heating, you can choose between levels 1, 2, 3 and 4.

#### Baking on two levels

Use 4D hot air. Baked items that are placed into the oven on trays or in baking tins/dishes at the same time will not necessarily be ready at the same time.

- Universal pan: Level 3  
Baking tray: Level 1
- Baking tins/dishes on the wire rack  
First wire rack: Level 3  
Second wire rack: Level 1

By preparing several dishes at the same time, you can make energy savings of up to 45 per cent. Position baking tins/dishes next to one another or offset and vertically stacked in the cooking compartment.

### Accessories

Ensure that you always use suitable accessories and that they are placed in the oven the right way around.

### Wire rack

Insert the wire rack with the open side facing the appliance door and the curved lip pointing downwards. Always place ovenware, tins and dishes on the wire rack.

### Universal pan or baking tray

Slide the universal pan or the baking tray in carefully as far as the limit stop with the bevelled edge facing the appliance door.

### Baking tins

Dark- coloured metal baking tins are most suitable.

Tinplate baking tins, ceramic dishes and glass dishes extend baking time and mean that the baked item will not brown evenly. If you wish to bake using these baking tins/dishes and using top/bottom heating, slide in the tin/dish at level 1.

### Greaseproof paper

Only use greaseproof paper that is suitable for the selected temperature. Always cut greaseproof paper to size.

### Frozen products

Do not use frozen products that are heavily frosted. Remove any ice on the food.

Some frozen products may be unevenly pre-baked. Uneven browning may remain even after baking.

### Recommended setting values

The table lists the optimal heating type for various kinds of bread and bread roll. The temperature and baking time depend on the amount and consistency of the dough/mixture. For this reason, the table specifies setting ranges. Try using the lower values to start with. A lower temperature will result in more even browning. You can use a higher setting next time if necessary.

**Note:** Baking times cannot be reduced by using higher temperatures. The bread or bread rolls would only be cooked on the outside, but would not be fully baked in the middle.

The setting values apply to food that is placed into a cold cooking compartment; by doing this, you can make energy savings of up to 20 per cent. If you preheat the oven, you can reduce the indicated baking times by several minutes.

Preheating is necessary for selected food, and this is indicated in the table. Do not place your food or accessories into the cooking compartment until it has finished preheating. Some food turns out best if it is baked in several stages. These foods are indicated in the table.

The setting values for bread dough apply to both dough placed on a baking tray and dough placed in a loaf tin.





If you wish to follow one of your own recipes when baking, you should use the setting values listed for similar baked items in the table as reference.















Remove unused accessories from the cooking compartment. This will ensure that you achieve the best possible cooking results and energy savings of up to 20 per cent.

**Caution!**

Never pour water into the hot cooking compartment or place cookware containing water onto the bottom of the cooking compartment. The change in temperature can cause damage to the enamel.

Types of heating used:

-  4D hot air
-  Top/bottom heating
-  Circulated air grilling
-  Grill, large area
-  Pizza setting

| Dish                                     | Accessories                 | Shelf position | Type of heating   | Temperature in °C | Grill setting | Cooking time in mins. |
|--|-----------------------------|----------------|---|-------------------|---------------|-----------------------|
| <b>Bread</b>                             |                             |                |   |                   |               |                       |
| White bread, 750 g                       | Universal pan or cake tin   | 2              |    | 210-220*          | -             | 10-15                 |
|  |                             |                |   | 180-190           | -             | 25-35                 |
| Multigrain bread, 1.5 kg                 | Universal pan or cake tin   | 2              |    | 210-220*          | -             | 10-15                 |
|  |                             |                |   | 180-190           | -             | 40-50                 |
| Wholemeal bread, 1 kg                    | Universal pan               | 2              |   | 210-220*          | -             | 10-15                 |
|  |                             |                |   | 180-190           | -             | 40-50                 |
| Flatbread                                | Universal pan               | 3              |  | 250-270           | -             | 20-25                 |
| <b>Bread rolls</b>                       |                             |                |   |                   |               |                       |
| Part-cooked rolls or baguette, pre-baked | Universal pan               | 3              |  | 180-200           | -             | 10-15                 |
| Bread rolls, sweet, fresh                | Baking tray                 | 3              |  | 170-190*          | -             | 15-20                 |
| Bread rolls, sweet, fresh, 2 levels      | Universal pan + baking tray | 3+1            |  | 150-170*          | -             | 20-30                 |
| Bread rolls, fresh                       | Baking tray                 | 3              |  | 180-200           | -             | 20-30                 |
| Baguette, pre-baked, chilled             | Universal pan               | 3              |  | 180-200           | -             | 20-30                 |
| <b>Bread rolls, frozen</b>               |                             |                |   |                   |               |                       |
| Part-cooked rolls or baguette, pre-baked | Universal pan               | 3              |  | 180-200           | -             | 10-15                 |
| Lye bread, pieces of dough               | Universal pan               | 3              |  | 180-200           | -             | 20-25                 |
| Croissant, pieces of dough               | Universal pan               | 3              |  | 170-190           | -             | 30-35                 |
| <b>Toast</b>                             |                             |                |   |                   |               |                       |
| Toast with topping, 4 slices             | Wire rack                   | 3              |  | 190-210           | -             | 10-15                 |
| Toast with topping, 12 slices            | Wire rack                   | 3              |  | 230-250           | -             | 10-15                 |
| Toasting bread (do not preheat)          | Wire rack                   | 5              |  | -                 | 3             | 4-6                   |

\* Preheat

## Pizza, quiche and savoury cakes

Your appliance offers you a range of heating types for preparing pizza, quiche and savoury cakes. You can find the ideal settings for many dishes in the settings tables.

Also refer to the notes in the section on allowing dough to rise.

Only use original accessories supplied with your appliance. These have been tailored to the cooking compartment and the operating modes of your appliance.

### Shelf positions

Use the indicated shelf positions.

#### Baking on one level

When baking on one level, use the following shelf positions:

- Tall baked items: Level 2
- Flat baked items: Level 3

If you are using 4D Hot air as the type of heating, you can choose between levels 1, 2, 3 and 4.

#### Baking on several levels

Use 4D hot air. Baked items that are placed into the oven on trays or in baking tins/dishes at the same time will not necessarily be ready at the same time.

Baking on two levels:

- Universal pan: Level 3  
Baking tray: Level 1
- Baking tins/dishes on the wire rack  
First wire rack: Level 3  
Second wire rack: Level 1

Baking on four levels:

- 4 wire racks with greaseproof paper  
First wire rack: Level 5  
Second wire rack: Level 3  
Third wire rack: Level 2  
Fourth wire rack: Level 1

By preparing several dishes at the same time, you can make energy savings of up to 45 per cent. Position baking tins/dishes next to one another or offset and vertically stacked in the cooking compartment.

### Accessories

Ensure that you always use suitable accessories and that they are placed in the oven the right way around.

#### Wire rack

Insert the wire rack with the open side facing the appliance door and the curved lip pointing downwards. Always place ovenware, tins and dishes on the wire rack.

#### Universal pan or baking tray

Slide the universal pan or the baking tray in carefully as far as the limit stop with the bevelled edge facing the appliance door.

Use the universal pan for pizzas with many toppings.

### Baking tins

Dark- coloured metal baking tins are most suitable.

Tinplate baking tins, ceramic dishes and glass dishes extend baking time and mean that the baked item will not brown evenly. If you wish to bake using these baking tins/dishes and using top/bottom heating, slide in the tin/dish at level 1.

### Greaseproof paper

Only use greaseproof paper that is suitable for the selected temperature. Always cut greaseproof paper to size.

### Frozen products

Do not use frozen products that are heavily frosted. Remove any ice on the food.

Some frozen products may be unevenly pre-baked. Uneven browning may remain even after baking.

### Recommended setting values

The table lists the optimal heating type for various types of food. The temperature and baking time depend on the amount and consistency of the dough/mixture. For this reason, the table specifies setting ranges. Try using the lower values to start with. A lower temperature will result in more even browning. You can use a higher setting next time if necessary.

**Note:** Baking times cannot be reduced by using higher temperatures. The food would only be cooked on the outside, but would not be fully baked in the middle.

The setting values apply to food that is placed into a cold cooking compartment; by doing this, you can make energy savings of up to 20 per cent. If you preheat the oven, you can reduce the indicated baking times by several minutes.

Preheating is necessary for selected food, and this is indicated in the table. Do not place your food or accessories into the cooking compartment until it has finished preheating.

If you wish to follow one of your own recipes when baking, you should use the setting values listed for similar baked items in the table as reference.



















Remove unused accessories from the cooking compartment. This will ensure that you achieve the best possible cooking results and energy savings of up to 20 per cent.

Types of heating used:

■  4D hot air

■  Top/bottom heating

■  Pizza setting

| Dish                                 | Accessories                         | Shelf position | Type of heating   | Temperature in °C | Cooking time in mins. |
|--------------------------------------|-------------------------------------|----------------|---|-------------------|-----------------------|
| <b>Pizza</b>                         |                                     |                |   |                   |                       |
| Pizza, fresh                         | Baking tray                         | 3              |    | 200-220           | 25-35                 |
| Pizza, fresh                         | Baking tray                         | 3              |    | 200-220           | 25-35                 |
| Pizza, fresh, 2 levels               | Universal pan + baking tray         | 3+1            |    | 180-200           | 35-45                 |
| Pizza, fresh, thin base              | Pizza tray                          | 2              |    | 220-230           | 20-30                 |
| Pizza, chilled                       | Wire rack                           | 3              |    | 190-210           | 10-15                 |
| <b>Pizza, frozen</b>                 |                                     |                |   |                   |                       |
| Pizza with thin base x 1             | Wire rack                           | 3              |    | 190-210           | 15-20                 |
| Pizza with thin base x 2             | Universal pan + wire rack           | 3+1            |    | 190-210           | 20-25                 |
| Pizza, deep-pan, x 1                 | Wire rack                           | 3              |    | 180-200           | 20-25                 |
| Pizza, deep-pan, x 2                 | Universal pan + wire rack           | 3+1            |    | 190-210           | 20-30                 |
| Pizza baguette                       | Wire rack                           | 3              |    | 200-220           | 15-20                 |
| Mini pizzas                          | Universal pan                       | 3              |    | 180-200           | 15-20                 |
| Mini pizzas, diameter 7 cm, 4 levels | 4 wire racks                        | 5+3+2+1        |    | 180-200*          | 20-30                 |
| <b>Savoury cakes and quiches</b>     |                                     |                |   |                   |                       |
| Savoury cakes in a tin               | Springform cake tin, diameter 28 cm | 2              |    | 170-190           | 55-65                 |
| Quiche                               | Flan-base cake tin, black           | 3              |   | 190-210           | 30-40                 |
| Tarte flambée                        | Universal pan                       | 3              |  | 260-280*          | 10-15                 |
| Pierogi                              | Ovenproof dish                      | 2              |  | 190-200           | 30-45                 |
| Empanada                             | Universal pan                       | 3              |  | 180-190           | 30-45                 |
| Börek                                | Universal pan                       | 1              |  | 200-220*          | 20-30                 |
| * Preheat                            |                                     |                |   |                   |                       |

## Bakes and soufflés

Your appliance offers a range of heating types for preparing bakes and soufflés. You can find the ideal settings for many dishes in the settings tables.

Only use original accessories supplied with your appliance. These have been tailored to the cooking compartment and the operating modes of your appliance.

### Shelf positions

Always use the indicated shelf positions.

You can prepare dishes on one level using a baking tin/dish or the universal pan.

- Baking tins/dishes on the wire rack: Level 2
- Universal pan: Level 3

You can also prepare soufflés in a water bath in the universal pan. To do so, slide the universal pan in at level 2.

By preparing several dishes at the same time, you can make energy savings of up to 45 per cent. Position baking tins/dishes next to one another in the cooking compartment.

## Accessories

Ensure that you always use suitable accessories and that they are placed in the oven the right way around.

### Wire rack

Insert the wire rack with the open side facing the appliance door and the curved lip pointing downwards. Always place ovenware, tins and dishes on the wire rack.

### Universal pan

Slide in the universal pan carefully as far as the limit stop, with the bevelled edge facing the appliance door.

### Cookware

Use wide, shallow cookware for bakes and gratins. In deep, narrow cookware, food requires more time to cook, and the top will be darker.

## Recommended setting values

In the table, you can find the ideal heating type for various bakes and soufflés. The temperature and cooking time are dependent on the quantity of food and the recipe. How well cooked a bake is will depend on the size of the cookware and the depth of the bake. Settings ranges are indicated for this reason. Try using the lower values at first. A lower temperature results in more even browning. You can increase the temperature next time if necessary.

**Note:** Cooking times cannot be reduced by using higher temperatures. Bakes or soufflés would only be cooked on the outside, but would be raw in the middle.

The setting values apply to dishes placed into a cold cooking compartment. By doing so, you can make energy savings of up to 20 per cent. If you preheat the oven, the indicated cooking times will be reduced by several minutes.

If you wish to follow one of your own recipes when cooking, you can use similar dishes in the table as a reference.

| Bakes & soufflés                                    | Accessories/cookware | Shelf position | Type of heating | Temperature in °C | Cooking time in mins. |
|---|----------------------|----------------|-----------------|-------------------|-----------------------|
| Bake, savoury, cooked ingredients                   | Ovenproof dish       | 2              |                 | 200-220           | 30-50                 |
| Bake, sweet   | Ovenproof dish       | 2              |                 | 170-190           | 40-60                 |
| Lasagne, fresh, 1 kg                                | Ovenproof dish       | 2              |                 | 160-180           | 50-60                 |
| Lasagne, frozen, 400 g                              | Wire rack            | 2              |                 | 190-210           | 30-35                 |
| Potato gratin, raw ingredients, 4 cm deep           | Ovenproof dish       | 2              |                 | 160-190           | 50-70                 |
| Potato gratin, raw ingredients, 4 cm deep, 2 levels | Ovenproof dish       | 3+1            |                 | 150-170           | 60-80                 |
| Soufflé   | Ovenproof dish       | 2              |                 | 160-180*          | 35-45                 |
| Soufflé   | Individual moulds    | 2              |                 | 170-190           | 65-75                 |

## Poultry

Your appliance offers you a range of heating types for preparing poultry. You can find the ideal settings for certain dishes in the settings tables.

### Roasting on the wire rack

Roasting on the wire rack is particularly well suited for larger poultry or for multiple pieces at the same time.

Slide the universal pan into the oven at the indicated shelf position with the wire rack attached. Ensure that the wire rack is correctly positioned on the universal pan. → "Accessories" on page 11

Depending on the size and type of the poultry, pour up to ½ litres of water into the universal pan. Any dripping fat will be caught. You can make a sauce from these juices. This will also result in less smoke and ensure that the cooking compartment stays cleaner.

### Roasting in cookware

Only use cookware which is suitable for use in an oven. Check whether the cookware fits in the cooking compartment.

Glass cookware is most suitable. Place hot glass cookware onto a dry mat after cooking. If the surface is damp or cold, the glass may crack.

Shiny roasting dishes made from stainless steel or aluminium reflect heat like a mirror and are therefore not particularly suitable. The poultry cooks slower and does not brown so well. Use a higher temperature and/or a longer cooking time.

Observe the manufacturer's instructions for your roasting cookware.

Remove unused accessories from the cooking compartment. This will achieve the best possible cooking results and energy savings of up to 20 per cent.

Types of heating used:

- 4D hot air
- Top/bottom heating
- Pizza setting

### Uncovered cookware

It is best to use a deep roasting tin/dish for roasting poultry. Place the tin/dish onto the wire rack. If you do not have any suitable cookware, use the universal pan.

### Covered cookware

When cooking with covered cookware, the cooking compartment remains considerably cleaner. Ensure that the lid fits well and closes properly. Place the cookware onto the wire rack.

Very hot steam may escape when opening the lid after cooking. Lift the lid at the rear, so that the hot steam can escape away from you.

Poultry can also become crispy in a covered roasting dish. To do so, use a roasting dish with a glass lid and set a higher temperature.

### Grilling

Keep the appliance door closed when using the grill. Never grill with the appliance door open.

Place the food to be grilled on the wire rack. In addition, slide the universal pan in at least one shelf position lower, with the slanted edge facing the appliance door. Any dripping fat will be caught.

When grilling, try wherever possible to use pieces of food which are of a similar thickness and weight. This will allow them to brown evenly and remain succulent and juicy. Place the food to be grilled directly onto the wire rack.

Use tongs to turn the pieces of food you are grilling. If you pierce the meat with a fork, the juices will run out and it will become dry.

**Notes**

- The grill element switches itself continuously on and off; this is normal. The grill setting determines how frequently this occurs.
- Smoke may be produced when grilling.

**Meat thermometer**

You can cook accurately using a meat thermometer. Read important notes on using the meat thermometer in the corresponding chapter. There, you can find notes on inserting the meat thermometer, the possible heating types and additional information. → "Meat thermometer" on page 18

**Recommended setting values**

In the table, you can find the ideal heating type for the kind of poultry you are cooking. The temperature and cooking time depend on the amount, composition and temperature of the food. Setting ranges are indicated for this reason. Try using the lower values at first. You can increase the temperature next time if necessary.

The setting values are based on the assumption that unstuffed, chilled, ready-to-roast poultry is placed into a cold cooking compartment. By doing so, you can make energy savings of up to 20 per cent. If you preheat the oven, the indicated cooking times will be reduced by several minutes.

In the table, you can find specifications for poultry with default values for the weight. If you wish to cook heavier poultry, use the lower temperature in every case. If cooking multiple pieces, use the weight of the heaviest piece as a reference for determining the cooking time.

The individual pieces should be approximately equal in size.

A general rule: the larger the poultry is, the lower the cooking temperature and the longer the cooking time.

Turn the poultry after approx. 1/2 to 2/3 of the indicated time.





**Note:** Only use greaseproof paper that is suitable for the selected temperature. Always cut greaseproof paper to size.













**Tips**

- For duck or goose, pierce the skin on the underside of the wings. This allows the fat to run out.
- If using duck breast, score the skin. Do not turn duck breasts.
- When you turn poultry, ensure that the breast side or the skin side is underneath at first.
- Poultry will turn out particularly crispy and brown if you baste it towards the end of the roasting time with butter, salted water or orange juice.

Remove unused accessories from the cooking compartment. This will achieve the best possible cooking results and energy savings of up to 20 per cent.

Types of heating used:

-  Top/bottom heating
-  Circulated air grilling
-  Grill, large area
-  Pizza setting

| Dish   | Accessories/cookware | Shelf position | Type of heating   | Temperature in °C | Grill setting | Cooking time in mins. |
|--|----------------------|----------------|---|-------------------|---------------|-----------------------|
| <b>Chicken</b>                               |                      |                |   |                   |               |                       |
| Chicken, 1 kg                                | Wire rack            | 2              |  | 200-220           | -             | 60-70                 |
| Chicken breast fillet, 150 g each (grilling) | Wire rack            | 4              |  | -                 | 3*            | 15-20                 |
| Small chicken portions, 250 g each           | Wire rack            | 3              |  | 220-230           | -             | 30-35                 |
| Chicken goujons, nuggets, frozen             | Universal pan        | 3              |  | 190-210           | -             | 20-25                 |
| Poulard, 1.5 kg                              | Wire rack            | 2              |  | 200-220           | -             | 70-90                 |
| <b>Duck and goose</b>                        |                      |                |   |                   |               |                       |
| Duck, 2 kg                                   | Wire rack            | 1              |  | 180-200           | -             | 90-110                |
| Duck breast, 300 g each                      | Wire rack            | 3              |  | 230-250           | -             | 25-30                 |
| Goose, 3 kg                                  | Wire rack            | 2              |  | 160-180           | -             | 120-150               |
| Goose legs, 350 g each                       | Wire rack            | 2              |  | 210-230           | -             | 40-50                 |
| <b>Turkey</b>                                |                      |                |   |                   |               |                       |
| Small turkey, 2.5 kg                         | Wire rack            | 2              |  | 180-200           | -             | 70-90                 |
| Turkey breast, boned, 1 kg                   | Cookware, covered    | 2              |  | 240-260           | -             | 80-100                |
| Turkey thigh, with bone, 1 kg                | Wire rack            | 2              |  | 180-200           | -             | 80-100                |

\* Preheat for 5 mins



## Meat

Your appliance offers you many heating types for preparing meat. You can find the ideal settings for many dishes in the settings tables.

### Roasting and braising

Baste lean meat with fat as required or cover it with strips of bacon.

Score the rind crosswise. If you turn the joint when cooking, ensure that the rind is underneath at first.

When the joint is ready, turn off the oven and allow it to rest for another 10 minutes in the cooking compartment. This allows the meat juices to be better distributed. Wrap the joint in aluminium foil if necessary. The recommended standing time is not included in the cooking time specified.

### Roasting on the wire rack

On the wire rack, meat will become very crispy on all sides.

Pour up to ½ litres of water into the universal pan, depending on the size and type of the meat. Dripping fat and meat juices will be caught. You can make a sauce using these juices. This will also result in less smoke and ensure that the cooking compartment stays cleaner.

Slide the universal pan into the oven at the indicated shelf position with the wire rack attached. Ensure that the wire rack is correctly positioned on the universal pan. → "Accessories" on page 11

### Roasting and braising in cookware

It is more convenient to roast and braise meat in cookware. You can take the joint out of the cooking compartment more easily in the cookware, and prepare the sauce in the cookware itself.

Only use cookware which is suitable for use in an oven. Check whether the cookware fits in the cooking compartment.

Glass cookware is most suitable. Place hot glass cookware onto a dry mat after cooking. If the surface is damp or cold, the glass may crack.

Add in a little liquid for roasting if the meat is lean. A covering of approx. ½ cm depth should be applied to the base of any glass cookware.

The amount of liquid is dependent on the type of meat, the cookware material and also on whether or not a lid is used. If preparing meat in an enamelled or dark metal roasting dish, it will need a little more liquid than if cooked in glass cookware.

The steam evaporates in the cookware when roasting. Carefully pour in more liquid if required.

Shiny roasting dishes made from stainless steel or aluminium reflect heat like a mirror and are therefore not particularly suitable. The meat cooks more slowly and will not brown so much. Use a higher temperature and/or a longer cooking time.

Observe the manufacturer's instructions for your roasting cookware.

### Uncovered cookware

Use a deep roasting tin/dish for roasting meat. Place the tin/dish onto the wire rack. If you do not have any suitable cookware, use the universal pan.

### Covered cookware

When cooking with covered cookware, the cooking compartment remains considerably cleaner. Ensure that the lid fits well and closes properly. Place the cookware onto the wire rack.

The distance between the meat and the lid must be at least 3 cm. The meat may rise.

Very hot steam may escape when opening the lid after cooking. Lift the lid at the rear, so that the hot steam can escape away from you.

If necessary, braise the meat first by searing it. Add water, wine, vinegar or a similar liquid to the braising liquid. A covering approx. 1-2 cm deep should be applied to the base of the cookware.

The steam evaporates in the cookware when roasting. Carefully pour in more liquid if required.

Meat can also become crispy in a covered roasting dish. To do so, use a roasting dish with a glass lid and set a higher temperature.

### Grilling

Keep the appliance door closed when using the grill. Never grill with the appliance door open.

Place the food to be grilled on the wire rack. In addition, slide the universal pan in at least one shelf position lower, with the slanted edge facing the appliance door. Any dripping fat will be caught.

When grilling, try wherever possible to use pieces of food which are of a similar thickness and weight. This will allow them to brown evenly and remain succulent and juicy. Place the food to be grilled directly onto the wire rack.

Use tongs to turn the pieces of food you are grilling. If you pierce the meat with a fork, the juices will run out and it will become dry.

Do not add salt until after the meat has been grilled. Salt draws water from the meat.

### Notes

- The grill element switches itself continuously on and off; this is normal. The grill setting determines how frequently this occurs.
- Smoke may be produced when grilling.

### Meat thermometer

You can cook accurately using a meat thermometer. Read important notes on using the meat thermometer in the corresponding chapter. There, you can find notes on inserting the meat thermometer, the possible heating types and additional information. → "Meat thermometer" on page 18

### Recommended setting values

You can find the ideal heating type for many meat dishes in the table. Temperature and cooking time depend on the amount, composition and temperature of the food. Settings ranges are indicated for this reason. Try using the lower values at first. You can increase the temperature next time if necessary.

The setting values apply to chilled meat placed into the cold cooking compartment. By doing so, you can make energy savings of up to 20 per cent. If you preheat the oven, you can reduce the indicated cooking times by several minutes.

You can find information on roasts and default values for weights in the table. If you wish to roast a heavy joint of meat, you should definitely use a lower temperature. If roasting several joints, use the weight of the heaviest piece as a basis for determining the cooking time. The individual pieces should be approximately equal in size.



As a general rule: the larger a roasting joint is, the lower the cooking temperature and the longer the cooking time.



















Turn roasting joints and grilled items after approx. ½ to ⅔ of the indicated time.

If you wish to follow one of your own recipes, you should use similar dishes as a reference. You can find additional information in the tips on roasting, braising and grilling attached to the settings table.

Remove unused accessories from the cooking compartment. This will achieve the best possible cooking results and energy savings of up to 20 per cent.

Types of heating used:

-  Top/bottom heating
-  Circulated air grilling
-  Grill, large area

| Dish  | Accessories/cookware | Shelf position | Type of heating   | Temperature in °C | Grill setting | Cooking time in mins. |
|---|----------------------|----------------|---|-------------------|---------------|-----------------------|
| <b>Pork</b>   |                      |                |   |                   |               |                       |
| Joint of pork without rind, e.g. neck, 1.5 kg             | Cookware, uncovered  | 2              |    | 180-190           | -             | 110-130               |
| Joint of pork with rind, e.g. shoulder, 2 kg              | Wire rack            | 2              |    | 190-200           | -             | 130-140               |
| Pork tenderloin steak, 1.5 kg                             | Cookware, uncovered  | 2              |   | 220-230           | -             | 70-80                 |
| Fillet of pork, 400 g                                     | Wire rack            | 3              |  | 220-230           | -             | 20-25                 |
| Smoked pork on the bone, 1 kg (with a little added water) | Cookware, covered    | 2              |  | 210-230           | -             | 70-90                 |
| Pork steaks, 2 cm thick                                   | Wire rack            | 5              |  | -                 | 2             | 16-20                 |
| Pork medallions, 3 cm thick (preheat oven for 5 mins.)    | Wire rack            | 5              |  | -                 | 3*            | 8-12                  |
| <b>Beef</b>   |                      |                |   |                   |               |                       |
| Fillet of beef, medium, 1 kg                              | Wire rack            | 2              |  | 210-220           | -             | 40-50                 |
| Pot-roasted beef, 1.5 kg                                  | Cookware, covered    | 2              |  | 200-220           | -             | 130-160               |
| Sirloin, medium, 1.5 kg                                   | Wire rack            | 2              |  | 220-230           | -             | 60-70                 |
| Steak, 3 cm thick, medium**                               | Wire rack            | 3              |  | -                 | 3             | 15-20                 |
| Burger, 3-4 cm thick                                      | Wire rack            | 4              |  | -                 | 3             | 25-30                 |
| <b>Veal</b>   |                      |                |   |                   |               |                       |
| Joint of veal, 1.5 kg                                     | Cookware, uncovered  | 2              |  | 160-170           | -             | 100-120               |
| Knuckle of veal, 1.5 kg                                   | Cookware, uncovered  | 2              |  | 200-210           | -             | 100-120               |
| <b>Lamb</b>   |                      |                |   |                   |               |                       |
| Leg of lamb, boned, medium, 1.5 kg                        | Cookware, uncovered  | 2              |  | 170-190           | -             | 50-80                 |
| Saddle of lamb on the bone***                             | Wire rack            | 2              |  | 180-190           | -             | 40-50                 |
| Lamb chop   | Wire rack            | 3              |  | -                 | 3             | 12-16                 |
| <b>Sausages</b>   |                      |                |   |                   |               |                       |
| Grilled sausages  | Wire rack            | 4              |  | -                 | 3             | 10-15                 |
| <b>Meat dishes</b>  |                      |                |   |                   |               |                       |
| Meat loaf, 1 kg   | Cookware, uncovered  | 2              |  | 170-180           | -             | 60-70                 |

\* Preheat

\*\* Do not preheat

\*\*\* Do not turn

## Tips on roasting and braising

|   |  |
|---|--|
| The cooking compartment becomes very dirty.   | Prepare your food in an enclosed roasting dish with higher temperature or use the grill tray. You will achieve the best roasting results if you use the grill tray. The grill tray can be bought later as a special accessory. |
| The roast is too dark and the crackling is burned in places, and/or the roast is too dry. | Check the shelf position and temperature. Select a lower temperature the next time and reduce the roasting time if necessary.  |
| The crackling is too thin.  | Increase the temperature or switch on the grill briefly at the end of the roasting time.   |
| The roast looks good but the juices are burnt.  | Next time, use a smaller roasting dish and add more liquid if necessary.   |
| The roast looks good but the juices are too clear and watery.                             | Next time, use a larger roasting dish and add less liquid if necessary.  |
| The meat gets burned during braising.   | The roasting dish and lid must fit together well and close properly.<br>Reduce the temperature and add more liquid when braising if necessary.   |

## Fish

Your appliance offers you a range of heating types for preparing fish. You can find the ideal settings for many dishes in the settings tables.

The whole fish does not have to be turned. Place the whole fish into the cooking compartment in swimming position with the dorsal fin facing upwards. Placing half a potato or a small oven-proof container in the stomach cavity of the fish will provide stability.

You can tell when the fish is cooked because the dorsal fin can be removed easily.

### Roasting and grilling on the wire rack

Place the food to be grilled on the wire rack. In addition, slide the universal pan in at least one shelf position lower, with the slanted edge facing the appliance door.

Pour up to ½ litres of water into the universal pan, depending on the size and type of the fish. Any dripping liquid will be caught. Less smoke is generated and the cooking compartment stays cleaner.

Keep the appliance door closed when using the grill. Never grill with the appliance door open.

When grilling, try wherever possible to use pieces of food which are of a similar thickness and weight. This will allow them to brown evenly and remain succulent and juicy. Place the food to be grilled directly onto the wire rack.

Use tongs to turn the pieces of food you are grilling. If you pierce the fish with a fork, the juices will run out and it will become dry.

### Notes

- The grill element switches itself continuously on and off; this is normal. The grill setting determines how frequently this occurs.
- Smoke may be produced when grilling.

### Roasting and stewing in cookware

Only use cookware which is suitable for use in an oven. Check whether the cookware fits in the cooking compartment.

Glass cookware is most suitable. Place hot glass cookware onto a dry mat after cooking. If the surface is damp or cold, the glass may crack.

Shiny roasting dishes made from stainless steel or aluminium reflect heat like a mirror and are therefore not particularly suitable. The fish cooks more slowly and browns less. Use a higher temperature and/or a longer cooking time.

Observe the manufacturer's instructions for your roasting cookware.

### Uncovered cookware

To cook a whole fish, it is best to use a deep roasting tin/dish. Place the tin/dish onto the wire rack. If you do not have any suitable cookware, use the universal pan.

### Covered cookware

When cooking with covered cookware, the cooking compartment remains considerably cleaner. Ensure that the lid fits well and closes properly. Place the cookware onto the wire rack.

When stewing, add two to three tablespoons of liquid and a little lemon juice or vinegar into the cookware.

Very hot steam may escape when opening the lid after cooking. Lift the lid at the rear, so that the hot steam can escape away from you.

Fish can also become crispy in a covered roasting dish. Here, use a roasting dish with a glass lid and set a higher temperature.

### Meat thermometer

You can cook accurately using a meat thermometer. Read important notes on using the meat thermometer in the corresponding chapter. There, you can find notes on inserting the meat thermometer, the possible heating types and additional information. → *"Meat thermometer" on page 18*

### Recommended setting values

You can find the ideal heating type for your fish dishes in the table. The temperature and cooking time depend on the amount, composition and temperature of the food. Settings ranges are indicated for this reason. Try using lower setting values first. You can use a higher setting next time if necessary.

The setting values are based on the assumption that chilled fish is placed into a cold cooking compartment. By doing so, you can make energy savings of up to 20 per cent. If you preheat the oven, you can reduce the indicated cooking times by several minutes.

en Tested for you in our cooking studio

In the table, you can find information for fish with default values for the weight. If you want to cook a heavier fish, you should definitely use the lower temperature. If cooking several fish, you should use the weight of the heaviest fish as a reference for determining the cooking time. The individual fish should be approximately the same size.



As a general rule: the larger a fish, the lower the cooking temperature and the longer the cooking time.







Turn any fish which is not in swimming position after approx. ½ to ⅔ of the indicated time.

**Note:** Only use greaseproof paper that is suitable for the selected temperature. Always cut greaseproof paper to size.

Remove unused accessories from the cooking compartment. This will achieve the best possible cooking results and energy savings of up to 20 per cent.

Types of heating used:

-  Top/bottom heating
-  Circulated air grilling
-  Grill, large area

| Dish   | Accessories/cookware | Shelf position | Type of heating   | Temperature in °C | Grill setting | Cooking time in mins. |
|--|----------------------|----------------|---|-------------------|---------------|-----------------------|
| <b>Fish</b>  |                      |                |   |                   |               |                       |
| Fish, grilled, whole 300 g, e.g. trout                       | Wire rack            | 2              |    | 170-190           | -             | 20-30                 |
| Fish, grilled, whole 1.5 kg, e.g. salmon                     | Wire rack            | 2              |    | 170-190           | -             | 30-40                 |
| <b>Fish fillets</b>  |                      |                |   |                   |               |                       |
| Fish fillet, plain, grilled                                  | Wire rack            | 4              |    | -                 | 1*            | 15-25                 |
| <b>Fish steaks</b>   |                      |                |   |                   |               |                       |
| Fish steak, 3 cm thick**                                     | Wire rack            | 4              |    | -                 | 3             | 10-20                 |
| <b>Fish, frozen</b>  |                      |                |   |                   |               |                       |
| Fish fillet, plain   | Cookware, covered    | 2              |  | 210-230           | -             | 20-30                 |
| Fish fillet, au gratin                                       | Wire rack            | 2              |  | 200-220           | -             | 45-60                 |
| Fish fingers (turn during cooking)                           | Universal pan        | 3              |  | 200-220           | -             | 20-30                 |
| * Preheat  |                      |                |   |                   |               |                       |
| ** Slide the universal pan in underneath at shelf position 2 |                      |                |   |                   |               |                       |

## Vegetables and side dishes

Here, you can find information for preparing grilled vegetables, potatoes and frozen potato products.

Remove unused accessories from the cooking compartment. This will allow you to achieve ideal cooking results and save energy.

### Shelf positions

Use the indicated shelf positions.

### Cooking on one level

Adhere to the specifications in the table.

### Cooking on two levels

Use 4D hot air. Food on different baking trays placed in the oven at the same time will not necessarily be ready at the same time.

- Universal pan: Level 3
- Baking tray: Level 1

### Accessories

Ensure that you always use suitable accessories and that they are placed in the oven the right way around.

### Wire rack

Insert the wire rack with the open side facing the appliance door and the curved lip pointing downwards.

Always place ovenware, tins and dishes on the wire rack.

### Universal pan or baking tray

Slide the universal pan or the baking tray in carefully as far as the limit stop with the bevelled edge facing the appliance door.

### Greaseproof paper

Only use greaseproof paper that is suitable for the selected temperature. Always cut greaseproof paper to size.

### Recommended setting values



In the table, you can find the ideal heating types for various dishes. The temperature and cooking time depend on the amount and composition of the food. Setting ranges are indicated for this reason. Try using the lower values at first. A lower temperature results in more even browning. You can use a higher setting next time if necessary.







The setting values apply to dishes placed into a cold cooking compartment. If you preheat the oven, the indicated cooking times will be reduced by several minutes.

If you wish to follow one of your own recipes when cooking, you can use similar dishes in the table as a reference.

Types of heating used:

-  4D hot air

-  Grill, large area
-  Pizza setting

| Dish                           | Accessories                 | Shelf position | Type of heating  | Temperature in °C | Grill setting | Cooking time in mins. |
|--------------------------------|-----------------------------|----------------|--|-------------------|---------------|-----------------------|
| <b>Vegetable dishes</b>        |                             |                |  |                   |               |                       |
| Grilled vegetables             | Universal pan               | 5              |  | -                 | 3             | 10-15                 |
| <b>Potatoes</b>                |                             |                |  |                   |               |                       |
| Baked potatoes, halved         | Universal pan               | 3              |  | 160-180           | -             | 45-60                 |
| <b>Potato products, frozen</b> |                             |                |  |                   |               |                       |
| Potato rösti                   | Universal pan               | 3              |  | 200-220           | -             | 25-35                 |
| Potato pockets, filled         | Universal pan               | 3              |  | 190-210           | -             | 20-30                 |
| Croquettes                     | Universal pan               | 3              |  | 200-220           | -             | 25-35                 |
| Chips                          | Universal pan               | 3              |  | 190-210           | -             | 25-35                 |
| Chips, 2 levels                | Universal pan + baking tray | 3+1            |  | 190-210           | -             | 30-40                 |

## Yogurt

You can make your own yogurt using your appliance.

### Preparing yogurt

Remove accessories and shelves from the cooking compartment. The cooking compartment must be empty.

1. Heat 1 litre of milk (3.5 % fat) to 90 °C on the hob and then cool down to 40 °C.  
It is sufficient to heat UHT milk to 40 °C.

2. Stir in 150 g (chilled) yogurt.
3. Pour into cups or small jars and cover with cling film.
4. Place the cups or jars onto the cooking compartment floor and use the settings indicated in the table.
5. After preparation, leave the yogurt to cool in the refrigerator.

Type of heating used:

-  4D hot air

| Dish   | Accessories       | Shelf position            | Type of heating   | Temperature in °C | Cooking time in hours |
|--------|-------------------|---------------------------|---|-------------------|-----------------------|
| Yogurt | Individual moulds | Cooking compartment floor |  | 40-45             | 8-9                   |

## Eco types of heating

Hot air eco and Top/bottom heating eco are intelligent heating types for the gentle preparation of meat, fish and pastries. The appliance optimally controls the supply of energy to the cooking compartment. The food is prepared in phases using residual heat. This means that it remains more succulent and browns less. Energy can be saved, depending on the preparation and food.

Place the food into the empty cooking compartment before it has heated up. Always keep the appliance door closed when cooking.

Remove unused accessories from the cooking compartment. This will allow you to achieve optimum cooking results and save energy.

Only use original accessories supplied with your appliance. These have been tailored to the cooking compartment and the operating modes of your appliance.

The Hot air eco heating type is used to determine the energy efficiency class.

### Accessories

Ensure that you always use suitable accessories and that they are placed in the oven the right way around.

### Wire rack

Insert the wire rack with the open side facing the appliance door and the curved lip pointing downwards. Always place ovenware, tins and dishes on the wire rack.

### Universal pan or baking tray

Slide the universal pan or the baking tray in carefully as far as the limit stop with the bevelled edge facing the appliance door.

### Baking tins and cookware

Dark- coloured metal baking tins are most suitable. These allow you to make energy savings of up to 35 per cent.

Cookware made from stainless steel or aluminium reflects heat like a mirror. Non-reflective cookware made from enamel, heat-resistant glass or coated, die-cast aluminium is more suitable.

Tinplate baking tins, ceramic dishes or glass dishes prolong baking time, and the cake will not brown so evenly.

### Greaseproof paper



Only use greaseproof paper that is suitable for the selected temperature. Always cut greaseproof paper to size.



### Recommended setting values

Here, you can find specifications for various dishes. The temperature and baking time are dependent on the quantity and composition of the dough. Different settings ranges are indicated for this reason. Try using the lower values at first. A lower temperature results in more even browning. If necessary, use a higher setting the next time.

**Note:** Baking times can not be reduced by using higher temperatures. Cakes or baked items would only be cooked on the outside, but would not be cooked completely in the middle.

Types of heating used:

-  Hotair Eco
-  Top/bottom heating Eco

| Dish  | Accessories/cookware                | Shelf position | Type of heating   | Temperature in °C | Cooking time in mins. |
|---|-------------------------------------|----------------|---|-------------------|-----------------------|
| <b>Cakes in tins</b>                          |                                     |                |   |                   |                       |
| Sponge cake in a tin                          | Ring tin/cake tin                   | 2              |    | 140-160           | 60-80                 |
| Sponge flan base                              | Flan base tin                       | 2              |    | 150-170           | 20-30                 |
| Sponge base, 2 eggs                           | Flan base tin                       | 2              |    | 150-170           | 20-30                 |
| Sponge flan, 3 eggs                           | Springform cake tin, diameter 26 cm | 2              |    | 160-170           | 30-45                 |
| Sponge flan, 6 eggs                           | Springform cake tin, diameter 28 cm | 2              |    | 150-160           | 50-60                 |
| Bundt yeast cake                              | Ring cake tin                       | 2              |    | 150-170           | 50-70                 |
| <b>Cakes on baking trays</b>                  |                                     |                |   |                   |                       |
| Sponge cake with dry topping                  | Baking tray                         | 3              |    | 150-170           | 25-40                 |
| Shortcrust tart with dry topping              | Baking tray                         | 3              |    | 170-180           | 25-35                 |
| Swiss roll                                    | Baking tray                         | 3              |    | 180-190           | 15-20                 |
| Plaited loaf, savarin                         | Baking tray                         | 3              |   | 160-170           | 25-35                 |
| Yeast cake with dry topping                   | Baking tray                         | 3              |  | 160-180           | 15-20                 |
| <b>Small baked items</b>                      |                                     |                |   |                   |                       |
| Muffins                                       | Muffin tray                         | 2              |  | 160-180           | 15-25                 |
| Small cakes                                   | Baking tray                         | 3              |  | 150-160           | 25-35                 |
| Puff pastry                                   | Baking tray                         | 3              |  | 170-190           | 20-35                 |
| Choux pastry                                  | Baking tray                         | 3              |  | 200-220           | 35-45                 |
| Biscuits                                      | Baking tray                         | 3              |  | 140-160           | 15-30                 |
| Whirls  | Baking tray                         | 3              |  | 140-150           | 25-35                 |
| Small yeast cakes                             | Baking tray                         | 3              |  | 160-180           | 25-35                 |
| <b>Bread and bread rolls</b>                  |                                     |                |   |                   |                       |
| Multigrain bread, 1.5 kg                      | Cake tin                            | 2              |  | 200-210           | 35-45                 |
| Flatbread                                     | Universal pan                       | 3              |  | 250-275           | 15-20                 |
| Bread rolls, sweet, fresh                     | Baking tray                         | 3              |  | 170-190           | 15-20                 |
| Bread rolls, fresh                            | Baking tray                         | 3              |  | 180-200           | 20-30                 |
| <b>Meat</b>                                   |                                     |                |   |                   |                       |
| Joint of pork without rind, e.g. neck, 1.5 kg | Cookware, uncovered                 | 2              |  | 180-190           | 120-140               |
| Pot-roasted beef, 1.5 kg                      | Cookware, covered                   | 2              |  | 200-220           | 140-160               |
| Joint of veal, 1.5 kg                         | Cookware, uncovered                 | 2              |  | 170-180           | 110-130               |
| <b>Fish</b>                                   |                                     |                |   |                   |                       |
| Fish, braised, whole 300 g, e.g. trout        | Cookware, covered                   | 2              |  | 190-210           | 25-35                 |
| Fish, braised, whole 1.5 kg, e.g. salmon      | Cookware, covered                   | 2              |  | 190-210           | 45-55                 |
| Fish fillet, plain, braised                   | Cookware, covered                   | 2              |  | 190-210           | 15-25                 |

## Acrylamide in foodstuffs

Acrylamide is mainly produced in grain and potato products prepared at high temperatures, such as potato

crisps, chips, sliced bread, bread rolls, bread or fine baked goods (biscuits, gingerbread, spiced biscuit).

### Tips for keeping acrylamide to a minimum

|            |   |
|------------|---|
| General    | <ul style="list-style-type: none"> <li>■ Keep cooking times as short as possible.</li> <li>■ Cook food until it is golden brown, but not too dark.</li> <li>■ Large, thick pieces of food contain less acrylamide.</li> </ul> |
| Baking     | <p>With top/bottom heating at max. 200 °C.<br/>With hot air at max. 180 °C.</p>   |
| Biscuits   | <p>With top/bottom heating at max. 190 °C.<br/>With hot air at max. 170 °C.<br/>Egg or egg yolk reduces the production of acrylamide.</p>   |
| Oven chips | Spread out a single layer evenly on the baking tray. Cook at least 400 g at once on a baking tray so that the chips do not dry out.   |

## Slow cook

Slow cooking is a technique for cooking food over a long period at low temperatures. For this reason, it is also called "low-temperature cooking".

Slow cooking is ideal for all prime cuts (e.g. tender portions of beef, veal, pork, lamb or poultry) which are to be cooked "à point". The meat will remain succulent and tender.

The benefit of this cooking method is that it allows lots of scope for menu planning because slow-cooked meat is easy to keep warm. You do not have to turn the meat when cooking. Keep the appliance door closed in order to maintain an even cooking climate.

Only use fresh, clean and hygienic meat without bones. Carefully remove sinews and fat from around the edge. Fat develops a strong, distinct flavour during slow cooking. You can also use seasoned or marinated meat. Do not use defrosted meat.

Meat can be carved immediately following slow cooking. No standing time is required. Due to the special cooking method, the meat looks pink, but is not raw or undercooked.

**Note:** Delayed-start operation with an end time is not possible for the slow cooking heating type.

## Cookware

Use shallow cookware, e.g. a glass/porcelain serving dish. Place the cookware into the cooking compartment to preheat it.

Always place the uncovered cookware onto the wire rack at level 2.

You can find additional information in the tips on slow cooking attached to the settings table.

Your appliance features the heating type "Slow cook". Only start operation when the cooking compartment has fully cooled down. Allow the cooking compartment to warm up for approx. 15 minutes with the cookware inside.







Sear the meat on the hotplate at a very high heat and for a sufficiently long time on all sides, even on the ends. Place into the preheated cookware right away. Place the cookware containing the meat into the cooking compartment once again and cook slowly.

## Recommended setting values

The slow cooking temperature and cooking time are dependent on the size, thickness and quality of the meat. Different settings ranges are indicated for this reason.

Type of heating used:

-  Slow cooking

| Dish  | Cookware            | Shelf position | Type of heating   | Searing time in mins. | Temperature in °C | Cooking time in mins. |
|---|---------------------|----------------|---|-----------------------|-------------------|-----------------------|
| <b>Poultry</b>                              |                     |                |   |                       |                   |                       |
| Duck breast, 400 g                          | Cookware, uncovered | 2              |  | 6-8                   | 90*               | 45-60                 |
| Chicken breast fillet, 200 g each           | Cookware, uncovered | 2              |  | 5-7                   | 90*               | 30-60                 |
| Turkey breast, boned, 1 kg                  | Cookware, uncovered | 2              |  | 8-10                  | 90*               | 150-210               |
| <b>Pork</b>                                 |                     |                |   |                       |                   |                       |
| Pork tenderloin steak, 5-6 cm thick, 1.5 kg | Cookware, uncovered | 2              |  | 8-10                  | 80*               | 210-240               |
| Pork fillet, whole                          | Cookware, uncovered | 2              |  | 6-8                   | 80*               | 90-120                |
| Pork medallions, 4 cm thick                 | Cookware, uncovered | 2              |  | 5-7                   | 80*               | 90-120                |

\* Preheat

| Dish                                       | Cookware            | Shelf position | Type of heating | Searing time in mins. | Temperature in °C | Cooking time in mins. |
|--|---------------------|----------------|-----------------|-----------------------|-------------------|-----------------------|
| <b>Beef</b>                                |                     |                |                 |                       |                   |                       |
| Joint of beef (rump), 6-7 cm thick, 1.5 kg | Cookware, uncovered | 2              |                 | 8-10                  | 80*               | 210-270               |
| Beef tenderloin, whole, 1 kg               | Cookware, uncovered | 2              |                 | 4-6                   | 80*               | 150-210               |
| Sirloin, 5-6 cm thick                      | Cookware, uncovered | 2              |                 | 6-8                   | 80*               | 210-270               |
| Beef medallions/rump steak, 4 cm thick     | Cookware, uncovered | 2              |                 | 5-7                   | 80*               | 30-60                 |
| <b>Veal</b>                                |                     |                |                 |                       |                   |                       |
| Joint of veal, 4-5 cm thick, 1.5 kg        | Cookware, uncovered | 2              |                 | 8-10                  | 80*               | 210-240               |
| Joint of veal, 10-15 cm thick, 1.5 kg      | Cookware, uncovered | 2              |                 | 8-10                  | 80*               | 210-240               |
| Veal fillet, whole, 800 g                  | Cookware, uncovered | 2              |                 | 5-7                   | 80*               | 120-150               |
| Veal medallions, 4 cm thick                | Cookware, uncovered | 2              |                 | 5-7                   | 80*               | 45-90                 |
| <b>Lamb</b>                                |                     |                |                 |                       |                   |                       |
| Saddles of lamb, boneless, 200 g each      | Cookware, uncovered | 2              |                 | 5-7                   | 80*               | 120-180               |
| Leg of lamb, boned, medium, 1 kg, tied     | Cookware, uncovered | 2              |                 | 6-8                   | 80*               | 180-240               |

\* Preheat

### Tips for slow cooking

|  |   |
|--|---|
| Slow-cooking duck breast.  | Place the cold duck breast into a pan and fry the skin side first. After slow cooking, grill for 3 to 5 minutes until crispy. |
| The slow-cooked meat is not as hot as conventionally roasted meat. | So that the roasted meat does not cool so quickly, warm the plates and serve the sauces very hot.                             |

### Drying

With 4D hot air, you can dry foods with outstanding results. With this type of preserving, flavourings are concentrated by the dehydration.

Only use unblemished fruit, vegetables and herbs and wash them thoroughly. Line the wire rack with greaseproof paper or parchment paper. Drain the excess water from the fruit and dry it.

If necessary, cut it into equal chunks or thin slices. Place unpeeled fruit onto the dish with the sliced surfaces facing upwards. Ensure that neither fruit nor mushrooms overlap on the wire rack.

Grate vegetables and then blanch them. Allow the blanched vegetables to drain off and distribute them evenly on the wire rack.

Dry herbs on the stem. Position the herbs evenly and slightly heaped on the wire rack.

Use the following shelf positions for drying:

- 1 wire rack: Level 3
- 2 wire racks: Level 3+1

Turn very juicy fruit and vegetables several times. After drying, remove the dried products from the paper immediately.

### Recommended setting values

In the table, you can find settings for drying various foodstuffs. The temperature and cooking time are dependent on the type, moisture, ripeness and thickness of the food to be dried. The longer you leave the food to be dried, the better it will be preserved. The thinner the slices are, the quicker the drying process will be and the more aromatic the dried food will remain. Setting ranges are indicated for this reason.

If you wish to dry additional foodstuffs, you should use similar foodstuffs in the table as a reference.

Type of heating used:

- 4D hot air

| Fruit, vegetables and herbs                          | Accessories    | Type of heating | Temperature in °C | Cooking time in hours |
|--|----------------|-----------------|-------------------|-----------------------|
| Pomes (apple rings, 3 mm thick, 200 g per wire rack) | 1-2 wire racks |                 | 80                | 5-9                   |
| Stone fruit (plums)                                  | 1-2 wire racks |                 | 80                | 8-10                  |
| Root vegetables (carrots), grated, blanched          | 1-2 wire racks |                 | 80                | 5-8                   |
| Sliced mushrooms                                     | 1-2 wire racks |                 | 60                | 6-9                   |
| Herbs, washed  | 1-2 wire racks |                 | 60                | 2-6                   |



## Preserving

You can preserve fruit and vegetables using your appliance.

### Warning – Risk of injury!

If the food is preserved incorrectly, the preserving jars may burst. Follow the instructions for preserving.

### Jars

Use only clean and undamaged preserving jars. Only use heat-resistant, clean and undamaged rubber rings. Check clips and clamps in advance.

For each preserving process, only use preserving jars that are the same size and contain the same food. In the cooking compartment, you can preserve the contents of a maximum of six ½, 1 or 1½-litre preserving jars at the same time. Do not use jars that are larger or taller than this. The lids could rupture.

Preserving jars must not touch one another in the cooking compartment during the preserving process.

### Preparing fruit and vegetables

Only use fruit and vegetables that are in good condition. Wash them thoroughly.

Peel, core and chop fruit and vegetables appropriate to their type and fill the preserving jars with them up to approx. 2 cm below the rim.

### Fruit

Fill the preserving jars with the fruit along with a hot, skimmed sugar solution (approx. 400 ml for a 1-litre jar). For one litre of water:

- Approx. 250 g sugar for sweet fruit
- Approx. 500 g sugar for sour fruit

### Vegetables

Fill the jars with the vegetables along with hot, boiled water.

Wipe the rims of the jars, as they must be clean. Place a damp rubber ring and a lid on each jar. Seal the jars

with clamps. Place the jars into the universal pan so that they do not touch each other. Pour 500 ml hot water (approx. 80 °C) into the universal pan. Use the settings indicated in the table.

### Ending the preserving process

#### Fruit

After a short while, small bubbles will form at short intervals. Switch off the appliance once all preserving jars are bubbling. Remove the jars from the cooking compartment after the indicated cooling time.

#### Vegetables

After a short while, small bubbles will form at short intervals. As soon as all preserving jars are bubbling, reduce the temperature to 120 °C and allow the jars to continue to bubble in the closed cooking compartment as indicated in the table. After this time has elapsed, switch off the appliance and make use of the residual heat for several minutes as indicated in the table.





After preserving, remove the jars from the cooking compartment and place them onto a clean cloth. Do not place these hot jars onto a cold or damp surface, as they may crack. Cover the preserving jars to protect them from draughts. Only remove the clamps once the jars are cold.

### Recommended setting values

The indicated times in the settings table are average values for preserving fruit and vegetables. They may be influenced by room temperature, the number of jars, quantity, heat and quality of the jar contents. The specifications are based on 1-litre round jars. Before you switch off the appliance or change the cooking mode, check whether the contents of the jars are bubbling as they should. The bubbling process starts after approx. 30-60 minutes.

Type of heating used:

-  4D hot air

| Preserving                          | Cookware                | Shelf position | Type of heating   | Temperature in °C | Cooking time in mins.            |
|-------------------------------------|-------------------------|----------------|---|-------------------|----------------------------------|
| Vegetables, e.g. carrots            | 1-litre preserving jars | 1              |  | 160-170           | Before it starts bubbling:30-40  |
|                                     |                         |                |   | 120               | When it starts to bubble: 30-40  |
|                                     |                         |                |   | -                 | Residual heat: 30                |
| Vegetables, e.g. cucumbers          | 1-litre preserving jars | 1              |  | 160-170           | Before it starts bubbling: 30-40 |
|                                     |                         |                |   | -                 | Residual heat: 30                |
| Stone fruit, e.g. cherries, damsons | 1-litre preserving jars | 1              |  | 160-170           | Before it starts bubbling:30-40  |
|                                     |                         |                |   | -                 | Residual heat:35                 |
| Pomes, e.g. apples, strawberries    | 1-litre preserving jars | 1              |  | 160-170           | Before it starts bubbling:30-40  |
|                                     |                         |                |   | -                 | Residual heat: 25                |

## Prove dough

You can prove yeast dough in your appliance more quickly than at room temperature. Use the top/bottom heating type. Only start operation when the cooking compartment has fully cooled down.

Always allow yeast dough to prove twice. Observe the specifications in the settings tables for the 1st and 2nd proving processes (dough fermentation and final fermentation).

### Dough fermentation

Use the settings indicated in the table and heat up the appliance. Position the dough bowl on the wire rack.

Do not open the appliance door during the proving process, as moisture will escape. Cover the dough with a damp cloth.

| Dish                        | Accessories/cookware | Shelf position | Type of heating | Step               | Temperature in °C | Cooking time in mins. |
|-----------------------------|----------------------|----------------|-----------------|--------------------|-------------------|-----------------------|
| Yeast dough, light          | Bowl                 | 2              |                 | Dough fermentation | 35-40             | 25-30                 |
|                             | Baking tray          | 2              |                 | Final fermentation | 35-40             | 10-20                 |
| Yeast dough, heavy and rich | Bowl                 | 2              |                 | Dough fermentation | 35-40             | 20-40                 |
|                             | Baking tray          | 2              |                 | Final fermentation | 35-40             | 15-25                 |

## Defrosting

The defrost heating type is suitable for defrosting frozen fruit, vegetables and baked items. Poultry, meat and fish should ideally be defrosted in the refrigerator.

Use the following shelf positions when defrosting:

- 1 wire rack: Level 2
- 2 wire racks: Level 3+1

### Recommended setting values

The times in the table are average values. They are dependent on the quality, freezing temperature (-18 °C) and composition of the food. Time ranges are indicated. Set the shortest time first and then extend the time if necessary.

| Dish                        | Accessories | Shelf position | Type of heating | Temperature in °C | Cooking time in mins. |
|-----------------------------|-------------|----------------|-----------------|-------------------|-----------------------|
| <b>Bread, bread rolls</b>   |             |                |                 |                   |                       |
| Bread & bread rolls general | Baking tray | 2              |                 | 50                | 40-70                 |
| <b>Cake</b>                 |             |                |                 |                   |                       |
| Cake, moist                 | Baking tray | 2              |                 | 50                | 70-90                 |
| Cake, dry                   | Baking tray | 2              |                 | 60                | 60-75                 |

## Keeping warm

You can keep cooked dishes warm using the "Keeping warm" heating type. This will avoid condensation developing, and means you will not have to wipe out the cooking compartment.

### Final fermentation

Place your baked item into the oven at the shelf position indicated in the table.

If you want to preheat the oven, the final fermentation takes place outside the appliance in a warm place.

### Recommended setting values

The temperature and proving time are dependent on the type and quantity of the ingredients. The values in the table are therefore only meant to be average values.

Type of heating used:

- Top/bottom heating

**Tip:** Items which were frozen flat or portioned defrost faster than those frozen in a block.

Remove frozen food from the packaging and place it in suitable cookware onto the wire rack.

Stir the food or turn it once or twice in between. Large pieces of food should be turned several times. Occasionally split the food or remove items which have already defrosted from the cooking compartment.

Leave the defrosted food to rest for another 10 to 30 minutes in the appliance whilst it is switched off, so that the temperature balances out.

Type of heating used:

- Defrosting

Do not keep cooked dishes warm for longer than two hours. Be aware that some dishes may continue cooking whilst being kept warm. Cover the dishes if necessary.

## Test dishes

These tables have been produced for test institutes to facilitate the inspection of the appliance.

In accordance with EN 60350-1:2013 and IEC 60350-1:2011.

### Baking

Baked items that are placed into the oven on trays or in baking tins/dishes at the same time will not necessarily be ready at the same time.

Shelf positions for baking on two levels:

- Universal pan: Level 3  
Baking tray: Level 1
- Baking tins/dishes on the wire rack  
First wire rack: Level 3  
Second wire rack: Level 1

Shelf positions for baking on three levels:

- Baking tray: Level 5
- Universal pan: Level 3
- Baking tray: Level 1

### Apple pie

Apple pie on one level: place dark-coloured springform cake tins diagonally next to each other.

Apple pie on two levels: position dark-coloured springform cake tins above each other so that they are offset.

Cakes in tinplate springform cake tins: bake on one level with top/bottom heating. Place the springform cake tin onto the universal pan instead of onto the wire rack.



### Fatless sponge cake















Fatless sponge cake on two levels: vertically stack springform cake tins in an offset manner on the wire racks.

### Notes

- The setting values apply to dishes placed into a cold cooking compartment.
- Please note the information in the tables about preheating. The setting values are valid without rapid heating-up.
- For baking, use the lower of the indicated temperatures first.

Types of heating used:

-  4D hot air
-  Top/bottom heating
-  Pizza setting



| Dish   | Accessory                            | Shelf position | Type of heating   | Temperature in °C | Cooking time in mins. |
|--|--------------------------------------|----------------|---|-------------------|-----------------------|
| <b>Baking</b>  |                                      |                |   |                   |                       |
| Shortbread   | Baking tray                          | 3              |  | 140-150*          | 25-40                 |
| Shortbread   | Baking tray                          | 3              |  | 140-150*          | 25-40                 |
| Shortbread, 2 levels                                 | Universal pan + baking tray          | 3+1            |  | 140-150*          | 30-40                 |
| Shortbread, 3 levels                                 | Baking trays + universal pan         | 5+3+1          |  | 130-140*          | 35-55                 |
| Small cakes  | Baking tray                          | 3              |  | 160*              | 20-30                 |
| Small cakes  | Baking tray                          | 3              |  | 150*              | 25-35                 |
| Small cakes, 2 levels                                | Universal pan + baking tray          | 3+1            |  | 150*              | 25-35                 |
| Small cakes, 3 levels                                | Baking trays + universal pan         | 5+3+1          |  | 140*              | 35-45                 |
| Fatless sponge cake                                  | Springform cake tin, diameter 26 cm  | 2              |  | 160-170**         | 25-35                 |
| Fatless sponge cake                                  | Springform cake tin, diameter 26 cm  | 2              |  | 160-170**         | 30-40                 |
| Fatless sponge cake, 2 levels                        | Springform cake tin, diameter 26 cm  | 3+1            |  | 150-170**         | 30-50                 |
| Apple pie  | 2 x black plate tins, diameter 20 cm | 2              |  | 170-180           | 60-80                 |
| Apple pie  | 2 x black plate tins, diameter 20 cm | 2              |  | 180-200           | 60-80                 |
| Apple pie, 2 levels                                  | 2 x black plate tins, diameter 20 cm | 3+1            |  | 170-190           | 70-90                 |
| * Preheat for 5 mins, do not use quick heat function |                                      |                |   |                   |                       |
| ** Preheat, do not use quick heat function           |                                      |                |   |                   |                       |

### Grilling

Also slide in the universal pan. The liquid will be caught and the cooking compartment stays cleaner.

Type of heating used:

-  Grill, large area

| Dish                                | Accessories | Shelf position | Type of heating   | Grill setting | Cooking time in mins. |
|-------------------------------------|-------------|----------------|---|---------------|-----------------------|
| <b>Grilling</b>                     |             |                |   |               |                       |
| Toasting bread*                     | Wire rack   | 5              |  | 3             | 4-6                   |
| Beefburger, 12 pieces**             | Wire rack   | 4              |  | 3             | 25-30                 |
| * Do not preheat                    |             |                |   |               |                       |
| ** Turn after 2/3 of the total time |             |                |   |               |                       |



**Robert Bosch Hausgeräte GmbH**

Carl-Wery-Straße 34  
81739 München, GERMANY

**[www.bosch-home.com](http://www.bosch-home.com)**



9001028793  
960929