



Register your new Bosch now:
www.bosch-home.com/welcome



**Free standing cooker
HSB738356A**



BOSCH

[en] Instruction manual

Leave this instructions with the owner

Important safety information	4
Causes of damage	7
Your new appliance	8
The control panel.....	8
Control panel	8
Buttons and display.....	9
The hob.....	9
The oven.....	10
Cooling fan.....	10
Accessories	10
Before using the oven for the first time	11
Setting the clock	11
Baking out the oven	11
Cleaning the burner caps and cups	11
Cleaning the accessories.....	11
Operating the hob	11
Switching on the gas burner.....	11
How to operate your oven	12
Oven lighting.....	12
Operating modes	12
Operating the oven.....	12
Operating the rotary spit.....	12
Setting the time-setting options	13
Timer	13
Cooking time	13
End time.....	14
Clock	15
Childproof lock	15
Changing the basic settings	15
Care and cleaning	16
Cleaning agents	16
Catalytic cooking compartment panels.....	17
Removing and fitting the appliance door.....	17
Removing and inserting the hook-in racks	17
Troubleshooting	18
Error messages.....	18
Replacing the oven light bulb.....	18
After-sales service	19
Energy and environment tips	19
Saving energy with your oven	19
Saving energy with the hob	19
Environmentally-friendly disposal.....	19

Additional information on products, accessories, replacement parts and services can be found at www.bosch-home.com and in the online shop www.bosch-eshop.com

Important safety information

Read these instructions carefully. Only then will you be able to operate your appliance safely and correctly. Retain the instruction manual and installation instructions for future use or for subsequent owners.

This appliance must be installed according to the installation instructions included.

Check the appliance for damage after unpacking it. Do not connect the appliance if it has been damaged in transport.

Only allow a licensed professional to connect the appliance and to convert the appliance to a different type of gas. The appliance must be installed (electric and gas connections) in accordance with the instruction and installation manual. An incorrect connection or incorrect settings may lead to serious accidents and damage to the appliance. The appliance manufacturer accepts no liability for damage of this kind. The appliance's warranty becomes void.

This appliance is intended for domestic use and the household environment only. This appliance must only be used to prepare food and drinks and must never be used as a heater. Do not leave the appliance unattended during operation. Only use the appliance indoors.

This appliance is intended for use up to a maximum height of 2000 metres above sea level.

This appliance is not intended for operation with an external clock timer or a remote control.

This appliance may be used by children over the age of 8 years old and by persons with reduced physical, sensory or mental capabilities or by persons with a lack of experience or knowledge if they are supervised or are instructed by a person responsible for their safety how to use the appliance safely and have understood the associated hazards.

Children must not play with, on, or around the appliance. Children must not clean the appliance or carry out general maintenance unless they are at least 8 years old and are being supervised.

Keep children below the age of 8 years old at a safe distance from the appliance and power cable.

Always slide accessories into the cooking compartment correctly. See *"Description of accessories"* in the instruction manual.

Close the safety valve on the gas supply line if the cooker will not be used for a prolonged period.

WHAT TO DO IF YOU SMELL GAS!

Escaping gas may cause an explosion.

If you smell gas or notice any faults in the gas installation:

- Immediately shut off the gas supply or close the gas cylinder valve.
- Immediately extinguish all naked flames and cigarettes.
- Do not use any light or appliance switches and do not pull any plugs out of sockets. Do not use any telephones or mobile phones within the building.
- Open windows and ventilate the room.
- Call the after-sales service or the gas supplier.

Risk of asphyxiation!

The use of a gas cooker leads to a build-up of heat, moisture and products of combustion in the room where the appliance is installed. Ensure that the installation room is well ventilated. The natural ventilation openings must be kept open or a mechanical ventilation device must be provided (e.g. an extractor hood). Intensive and persistent use of the appliance may mean that it is necessary to have additional ventilation (e.g. opening a window), or more effective ventilation (e.g. operating the existing mechanical ventilation device at a higher setting).

This appliance is approved for use with Natural and ULPG gas.

DO NOT SPRAY AEROSOLS IN THE VICINITY OF THIS APPLIANCE WHILE IT IS IN OPERATION.

THIS APPLIANCE IS NOT TO BE INSTALLED IN MARINE CRAFT OR IN CARAVANS.

DO NOT USE OR STORE FLAMMABLE MATERIALS IN THE APPLIANCE STORAGE DRAWER OR NEAR THE APPLIANCE.

DO NOT MODIFY THIS APPLIANCE.

SERVICING SHALL ONLY BE CARRIED OUT BY AN AUTHORISED PERSON.

Risk of fire!

- A draught is created when the appliance door is opened. Greaseproof paper may come into contact with the heating element and catch fire. Do not place greaseproof paper loosely over accessories during preheating. Always weight down the greaseproof paper with a dish or a baking tin. Only cover the surface required with greaseproof paper. Greaseproof paper must not protrude over the accessories.
- Combustible objects that are left in the cooking compartment may ignite. Never store combustible items in the cooking compartment. Never open the appliance door if there is smoke inside. Switch off the appliance and unplug the mains plug or switch off the fuse in the fuse box. Shut off the gas supply.
- Hot oil and fat can ignite very quickly. Never leave hot fat or oil unattended. Never use water to put out burning oil or fat. Switch off the hotplate. Extinguish flames carefully using a lid, fire blanket or something similar.
- The hotplates become very hot. Never place combustible items on the hob. Never place objects on the hob.
- The appliance becomes very hot and flammable materials could catch fire. Never store or use flammable objects (e.g. spray cans, cleaning agents) under the appliance or in its immediate vicinity. Never place flammable items on or in the appliance.
- When gas hotplates are in operation without any cookware placed on them, they can build up a lot of heat. The appliance and the extractor hood above it may become damaged or be set on fire. Grease residue in the filter of the extractor hood may ignite. Only operate the gas burners with cookware on them.
- The rear of the appliance becomes very hot. This may cause damage to the power cables. Electricity and gas lines must not come into contact with the rear of the appliance.

Risk of burns!

- The appliance becomes very hot. Never touch the interior surfaces of the cooking compartment or the heating elements. Always allow the appliance to cool down. Keep children at a safe distance.
- Accessories and ovenware become very hot. Always use oven gloves to remove accessories or ovenware from the cooking compartment.
- Alcoholic vapours may catch fire in the hot cooking compartment. Never prepare food containing large quantities of drinks with a high alcohol content. Only use small quantities of drinks with a high alcohol content. Open the appliance door with care.
- The hotplates and surrounding area (particularly the hob surround, if fitted) become very hot. Never touch the hot surfaces. Keep children at a safe distance.
- The accessible parts become very hot when in operation. Never touch hot parts. Keep children at a safe distance.
- Empty cookware becomes extremely hot when set on a gas hotplate that is in operation. Never heat up empty cookware.

Risk of scalding!

- The accessible parts become hot during operation. Never touch the hot parts. Keep children at a safe distance.
- When you open the appliance door, hot steam may escape. Open the appliance door with care. Keep children at a safe distance.
- Water in a hot cooking compartment may create hot steam. Never pour water into the hot cooking compartment.

Risk of injury!

- Scratched glass in the appliance door may develop into a crack. Do not use a glass scraper, sharp or abrasive cleaning aids or detergents.
- Incorrect repairs are dangerous. Repairs may only be carried out, and damaged power and gas lines replaced, by an after-sales engineer trained by us. If the appliance is faulty, unplug the mains plug or switch off the fuse in the fuse box. Shut off the gas supply. Contact the after-sales service.
- Faults or damage to the appliance are dangerous. Never switch on a faulty appliance. Unplug the appliance from the mains or switch off the circuit breaker in the fuse box. Shut off the gas supply. Contact the after-sales service.
- Unsuitable pan sizes, damaged or incorrectly positioned pans can cause serious injury. Observe the instructions which accompany the cookware.
- If the appliance is placed on a base and is not secured, it may slide off the base. The appliance must be fixed to the base.

Risk of tipping!

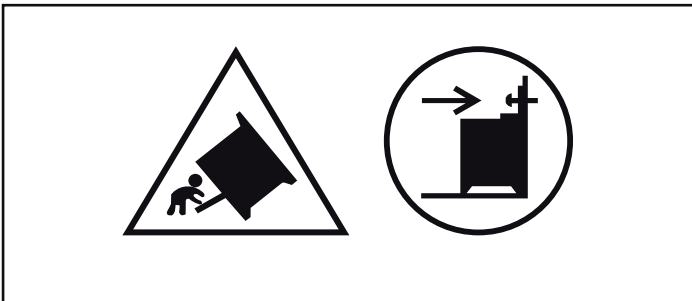

Warning: In order to prevent tipping of the appliance, this stabilizing means must be installed. Refer to the instructions for installation.

Risk of electric shock and serious injury!

- The cable insulation on electrical appliances may melt when touching hot parts of the appliance. Never bring electrical appliance cables into contact with hot parts of the appliance.
- Do not use any high-pressure cleaners or steam cleaners, which can result in an electric shock.
- When replacing the cooking compartment bulb, the bulb socket contacts are live. Before replacing the bulb, unplug the appliance from the mains or switch off the circuit breaker in the fuse box.

Causes of damage

Hob

Caution!

- Only use the burners when cookware has been placed on top. Do not heat up empty pots or pans. The saucepan base will be damaged.
- Clear up spills immediately. Use deep pots for dishes with a lot of liquid. This will prevent the food from boiling over.
- Do not use roasting dishes if they must be heated using two burners. This will cause heat accumulation. The appliance could be damaged.
- Cooking on gas burners releases extra heat and moisture. Adjacent units may become damaged over time. For long cooking times, switch on the cooker hood or ventilate the room.
- Observe the manufacturer's instructions when using special ovenware. Aluminium foil and plastic containers can melt and stick on hot burners.
- Place the pot or pan centrally over the burner. This will optimise transfer of the heat from the burner flame to the pot or pan base. The handle does not become damaged, and greater energy savings are guaranteed.
- Ensure that the gas burners are clean and dry. The burner cup and burner cap must be positioned exactly.

Oven

Caution!

- Accessories, foil, greaseproof paper or ovenware on the cooking compartment floor: do not place accessories on the cooking compartment floor. Do not cover the cooking compartment floor with any sort of foil or greaseproof paper. Do not place ovenware on the cooking compartment floor. This will cause heat accumulation. The baking and roasting times will no longer be correct and the enamel will be damaged.
- Inserting accessories: depending on the appliance model, accessories can scratch the door panel when closing the appliance door. Always insert the accessories into the cooking compartment as far as they will go.
- Water in a hot cooking compartment: do not pour water into the cooking compartment when it is hot. This will cause steam. The temperature change can cause damage to the enamel.
- Moist food: do not store moist food in the cooking compartment when it is closed for prolonged periods. This will damage the enamel.
- Fruit juice: when baking particularly juicy fruit pies, do not pack the baking tray too generously. Fruit juice dripping from the baking tray leaves stains that cannot be removed. If possible, use the deeper universal pan.
- Cooling with the appliance door open: only allow the cooking compartment to cool when it is closed. Even if the appliance door is only open a little, front panels of adjacent units could be damaged over time.
- Heavily soiled oven seal: if the oven seal is heavily soiled, the oven door will no longer close properly when the oven is in operation. The fronts of adjacent units could be damaged. Always keep the oven seal clean.
- Oven door as a bearing surface: do not stand or place objects on the oven door when it is open. Do not hang objects on the oven door.
- Carrying the appliance: do not carry or hold the appliance by the door handle. The door handle cannot support the weight of the appliance and could break.
- Heavy accessories: do not pull out heavily laden accessories too far without first unloading them sufficiently. Heavy accessories will tip when pulled out. This causes pressure to be exerted on the shelf supports in the cooking compartment, which can damage the enamel. Relieve the strain on the accessories when they are pulled out by raising them slightly with one hand. Caution: always use an oven cloth or oven gloves when handling hot accessories.

Storage compartment

Caution!

Do not place hot objects in the storage compartment. It could be damaged.

Your new appliance

Get to know your appliance. You will find information about the control panel and hob, as well as the oven, types of heating and accessories.

Depending on the appliance model, individual details may differ.

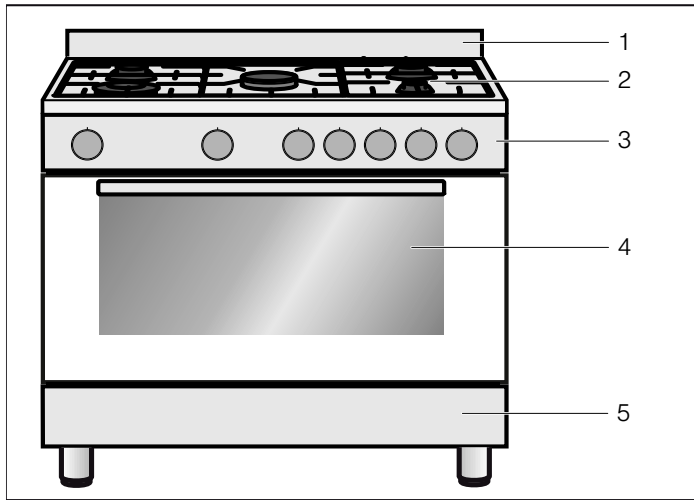

Explanation

1	Splatter guard
2	Hob
3	Control panel
4	Oven
5	Storage compartment

The control panel

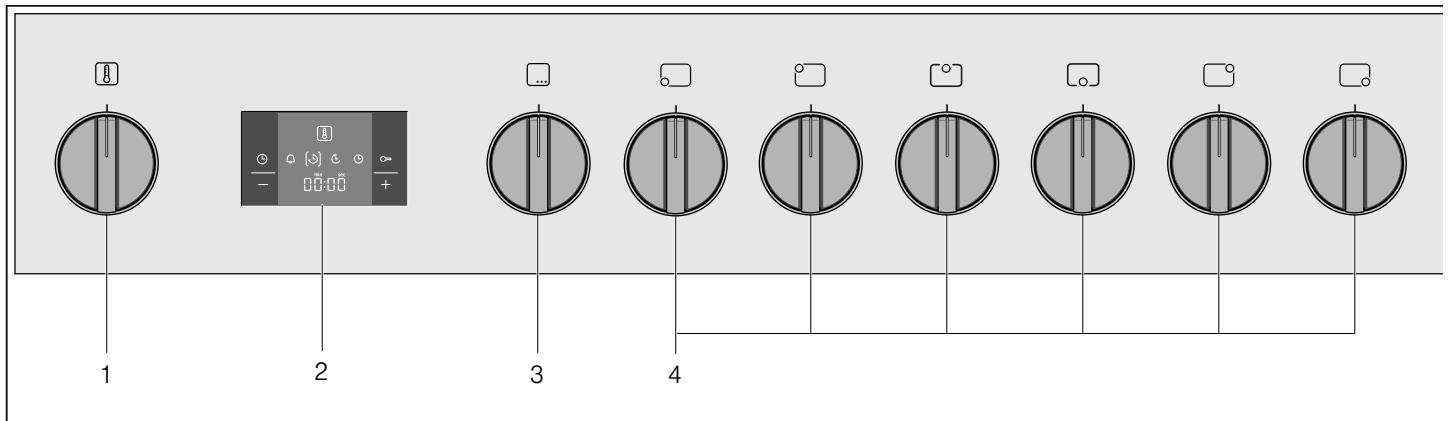

Explanation

1	Control knob for oven temperature
2	Control panel
3	Control knob for oven functions
4	Control knob for hotplates

Control panel

Here, you can see an overview of the control panel. All of the symbols never appear in the display at the same time. Depending on the appliance model, individual details may differ.

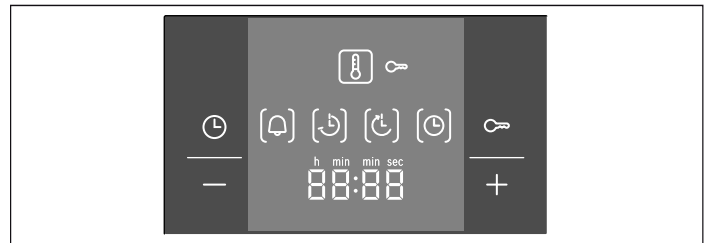

Buttons

The sensors are located under the individual buttons. They must not be pressed too firmly. Only touch the corresponding symbol.

Buttons and display

You can use the buttons to set various additional functions. On the display, you can read the values that you have set.

Button	Use
Time-setting options	Selects the timer , cooking time , end time and clock .
Childproof lock	Locks and unlocks oven functions.
- Minus	Decreases the set values.
+ Plus	Increases the set values.

The time-setting option that is currently selected in the display is indicated by brackets [] around the corresponding symbol. Exception: For the clock, the symbol only lights up if the time is being changed.

The hob

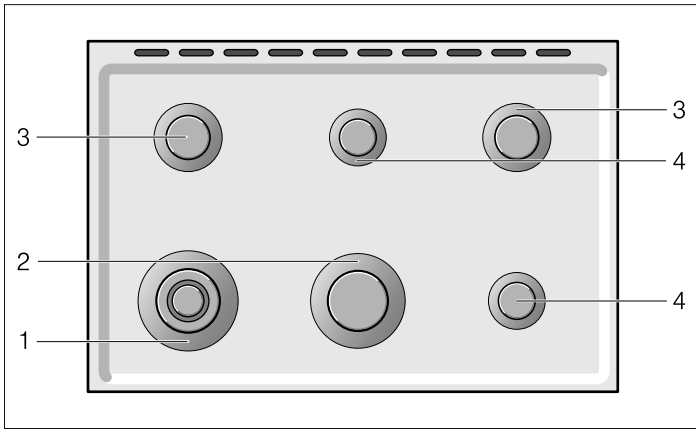

Explanation

1	Wok burner (14.0 MJ/h)
2	High-output burner (12.0 MJ/h)
3	Standard burner (7.0 MJ/h)
4	Economy burner (4.0 MJ/h)

Types of gas burner

Gas burners	Pot/pan diameter
Economy burner	12 - 14 cm
Standard burner	16 - 22 cm
High output burner	18 - 26 cm
Wok burner	18 - 26 cm

Precautions for use

The following advice is intended to help you save energy and prevent pan damage:

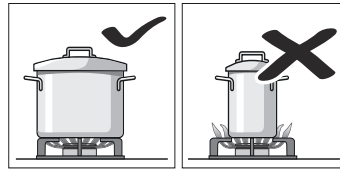

Use pans which are the right size for each burner.
Do not use small pans on large burners. The flame must not touch the sides of the pan.

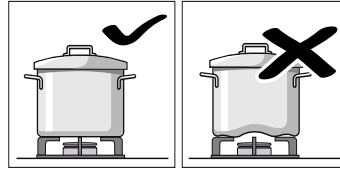

Do not use damaged pans, which do not sit evenly on the hob. Pans may tip over.
Only use pans with a thick, flat base.

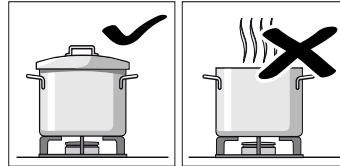

Do not cook without using a lid and make sure the lid is properly fitted. This wastes energy.

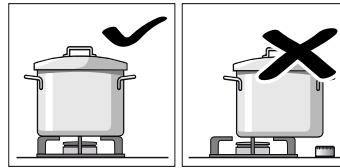

Always centre the pan over the burner, not to one side. Otherwise it could tip over.

Do not place large pans on the burners near the control knobs. These may be damaged by the very high temperatures.

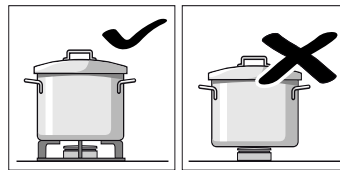

Place the pans on the pan supports, never directly on the burner.

Make sure that the pan supports and burner caps are correctly positioned before using the appliance.

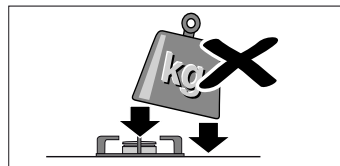

Pans should be placed on the hob carefully.

Do not strike the hob and do not place excessive weight on it.

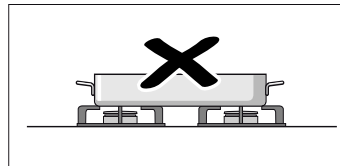

Never use two burners or heat sources to heat one single pan.

Do not use grill pans, earthenware casserole dishes, etc. for a long period of time on maximum power.

Control knob for hotplates

This control knob is used to adjust the heat setting of the gas burner hotplates.

The symbols above the control knob show you the gas burner to which the control knob belongs.

Setting	Meaning
o	Off
@	Large flame, highest power
@	Economy flame, lowest power

The oven

In order to operate the oven, you require two operating knobs: The function selector and the temperature selector.

Control knob for oven

Function selector

Set the operating mode using the function selector.

Symbol	Meaning
○	Off position
☐	Top/bottom heating*
☐	Bottom heating
☐	Grill/rotary spit
☐	Full-surface grill
☐	Hot air grill
☐	Top/bottom heating and hot air
☐	Hot air
☐*	Defrost setting

* Type of heating used to determine the energy efficiency class in accordance with EN50304.

Temperature selector

Set the temperature using the temperature selector.

Setting	Meaning
○	Off
50 - 260	Temperature range in °C

There is a limit stop between settings 260 and ○. Do not turn the knob beyond this point.

Cooling fan

The cooling fan switches on and off as required. The hot air escapes above the door. Caution: Do not cover the ventilation slots. Otherwise the oven will overheat.

So that the cooking compartment cools down more quickly after operation, the cooling fan continues to run for a certain period afterwards.

Accessories

The accessories can be inserted into the cooking compartment at 4 different levels. Always insert them as far as they will go so that the accessories do not touch the door panel. Ensure that the accessories have always been inserted into the cooking compartment correctly.

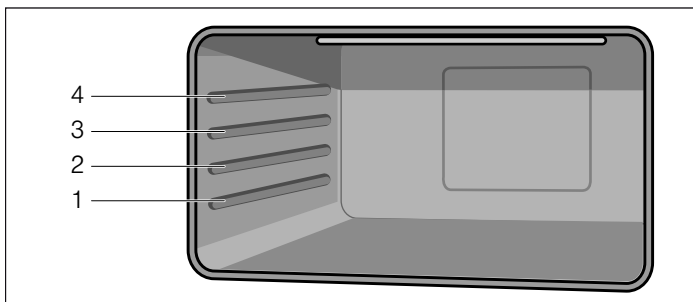

The pull-out rails allow you to pull accessories out completely. When inserting the adapter for the baking and roasting shelf, ensure that it latches into place behind the indentation on the pull-out rails

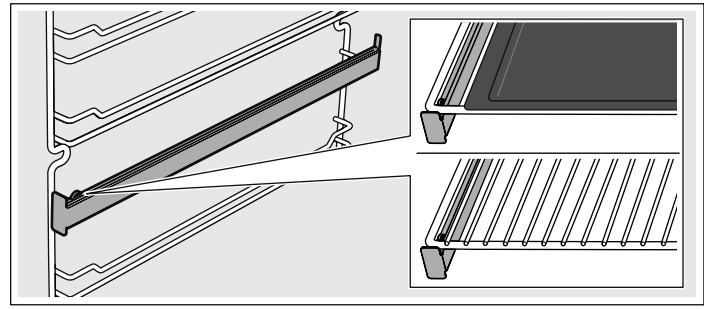





⚠ Risk of fire!

Under no circumstances should a baking sheet, a baking tray, a pan or another form of cookware be placed directly on the oven floor. This causes the floor of the appliance to overheat and can seriously damage the bottom of the fitted unit.

You can pull out the accessories two thirds of the way without them tipping. This allows dishes to be removed easily.

The accessories may become deformed when they become hot. As soon as they have cooled down, the deformation disappears with no effect on the function.

You can buy accessories from the after-sales service, from specialist retailers or online.

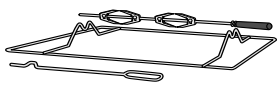
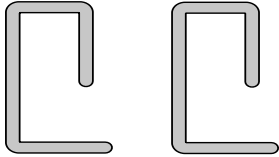
Accessories	Description
	Baking and roasting shelf For ovenware, cake tins, joints, grilled items, frozen meals.
	Enamelled baking tray For moist cakes, pastries, frozen meals and large roasts. Can also be used as a drip tray to collect dripping fat.
	Support for baking tray The baking tray can be inserted into the oven with this support.
	Espresso attachment Attachment for an espresso pot, for placing on the economy burner.
	Wok ring Attachment for a wok, for placing on the wok burner. When using the wok attachment, it is possible to use cooking vessels with a diameter greater than 26 cm (woks, frying pans, pots, vessels with a curved base, etc.).
	Rotary spit With rotary spit support and metal hook For roasts and large pieces of poultry. Only use in combination with the enamelled baking tray.
	Pressure regulator Pressure regulator for liquefied gas.
	Locking pins For locking the hinges.

Before using the oven for the first time

In this section, you can find out what you must do before using your appliance to prepare food for the first time. Read the *Safety information* section beforehand.

Remove the appliance packaging and dispose of it appropriately.

Setting the clock

After the appliance has been connected, the \ominus symbol and four zeros flash in the display. Set the clock.

1. Press the \ominus button.

The clock in the display shows 12:00. The time symbols light up and the brackets are around \ominus .

2. Use the $+$ or $-$ button to set the clock.

After a few seconds, the time that has been set is adopted.

Baking out the oven

Precleaning the oven

1. Remove accessories and hook-in racks from the cooking compartment.
2. Fully remove any remaining packaging, such as small pieces of polystyrene, from the cooking compartment.
3. Some parts are covered with a protective film. Remove the protective film.
4. Clean the outside of the appliance with a soft, damp cloth.
5. Clean the cooking compartment with hot soapy water.

Heating up the oven

To remove the new cooker smell, heat up the oven when it is empty and closed.

1. Turn the temperature selector to the maximum temperature.
2. Switch off the oven after 45 minutes.

Recleaning the oven

1. Clean the cooking compartment with hot soapy water.
2. Fit the hook-in racks.

Cleaning the burner caps and cups

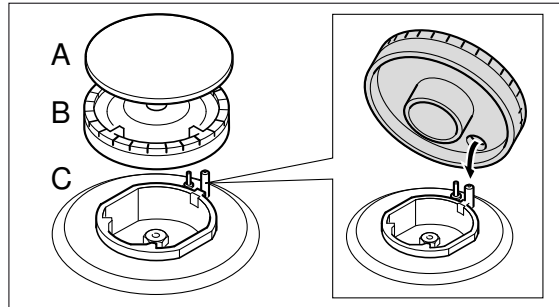

1. Clean the burner caps (A) and cups (B) with water and washing-up liquid.
2. Dry the parts well.
3. Place the burner cup (B) onto the burner (C).
4. Position the burner cap (A) exactly on the burner cup (B).

Cleaning the accessories

Before using the accessories, clean them thoroughly using a cloth and warm soapy water.

Operating the hob

Notes

- Appliances with a hob cover must only be switched on if the hob cover is open.
- The burner caps must always be positioned exactly on top of the burner cups. The slots on the burner cup must be free from obstruction. All parts must be dry.
- Ensure that the burner is not subjected to draughts caused by air conditioning systems, fans or similar appliances.

Switching on the gas burner

1. Press the control knob for the required burner and turn it to the \odot position.
The gas burner ignites.
2. Keep the control knob pressed for a few seconds until the flame stabilises.
3. Set the desired flame setting.

Setting	Meaning
\odot	Economy flame, lowest power
\odot	Large flame, highest power

The flame is not stable between positions \circ and \odot . Always select a position between \odot and \odot .

If the flame goes out

Switch off the control knob. Wait one minute and switch the burner on again.

Risk of fire!

If the flame goes out, gas will escape. Never leave the gas burner unattended during operation. Ensure that there are no draughts.

If the gas burner does not ignite

In the event of a power cut or damp ignition plugs, light the gas burner with a gas lighter or a match.

Switching off the gas burner

Turn the control knob for the required hotplate to position \circ .

Abnormal operation

Flames are usually blue and sharply defined. If the flames are yellowish or noisy or if the gas does not ignite within the period specified under "switching on the gas burner" abnormal operation is indicated. Refer to chapter "After-sales service" of this manual for service contact details.

How to operate your oven

You have the option of adjusting your oven to a range of different settings. You can control the oven using the electronic clock.

Oven lighting

Switching on the oven light

Turn the function selector to an operating mode.

The oven light also switches on when the oven door is opened.









Switching off the oven light

Turn the function selector to the off position.

Close the oven door.

Operating modes

The following operating modes are available.

Operating mode	Use
 Top/bottom heating*	For sponge cakes in tins, bakes, lean joints of beef, veal and game.
 Bottom heating	For bain-marie applications such as crema catalana, or for preserving. Also improvement setting if the base is not fully baked through
 Grill/rotary spit	Grill: For individual portions or small quantities of steaks, sausages, fish and toast. Rotary spit: For roasts, rolled joints and poultry
 Full-surface grill	For several steaks, sausages, fish and pieces of toast.
 Hot air grill	For poultry and larger pieces of meat.
 Top/bottom heating and hot air	For cakes with very moist toppings.
 Hot air	For cakes, pizza and items baked on two levels, for roasting and drying.
 Defrost setting	For defrosting meat, poultry, fish and pastries.

* Type of heating used to determine the energy efficiency class in accordance with EN50304.

Operating the oven

Switching on the oven



Note: Always keep the appliance door closed when it is in operation.

1. Turn the function selector to the desired operating mode.
2. Turn the temperature selector to set the desired temperature.
The oven switches on.

The indicator lamp is lit when the oven is heating up. It goes out during pauses in heating.

Note: The indicator lamp also lights up when the function selector is in the off position and a temperature is set. The oven only begins to heat up when an operating mode is set.

Switching off the oven

1. Turn the function selector to the  position.
2. Turn the temperature selector to the  position.
The oven switches off.

Operating the rotary spit

The rotary spit can be used with excellent results to cook joints, such as rolled roasting joints and poultry. The meat is roasted thoroughly and evenly.

The drive for the rotary spit is automatically activated as soon as you switch on the grill.

Preparing roasts

1. Place the joint as centrally as possible on the rotary spit and secure it at both ends with the retaining clips.
You can also secure the joint using kitchen twine.
2. With poultry, bind the ends of the wings underneath the back and the thighs against the body. This prevents them from overbrowning.
3. Pierce the skin on the underside of the wings to allow the fat to escape.

Inserting the rotary spit

Risk of burns!

Never touch the hot surfaces of the cooking compartment or the heating elements. Children must be kept at a safe distance from the appliance at all times. Open the appliance door carefully. Hot steam may escape.

1. Slide the rotary spit shelf halfway in at shelf position 2.
2. Place the rotary spit on the rotary spit shelf and unscrew and remove the handle.

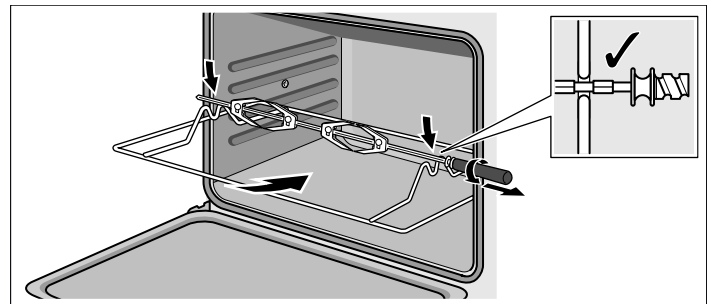

3. Slide in the rotary spit shelf all the way.
4. Slide the rotary spit to the left into the motor mount.

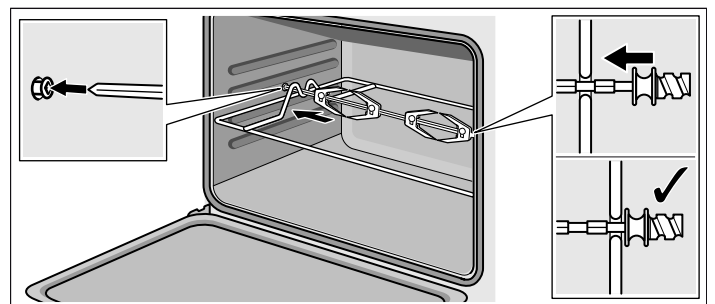

5. Pour water into a baking tray and slide this into shelf position 1 to collect the dripping fat.
6. Close the appliance door.

Switching on the rotary spit

Turn the control knob for the oven to the  position.

Note: Grill+ rotisserie cooking must never exceed 240°C.

Switching off the rotary spit

Turn the control knob for the oven to the  position.

Removing the rotary spit

⚠ Risk of burns!

Never touch the hot surfaces of the cooking compartment or the heating elements. Children must be kept at a safe distance from the appliance at all times. Open the appliance door carefully. Hot steam may escape.

⚠ Risk of burns!

Never touch the rotary spit or other accessories directly when they are hot. Always wear oven gloves or heat-resistant gloves when handling hot accessories.

1. Open the appliance door carefully.
2. Using the metal hook, pull the rotary spit to the right out of the motor mount.

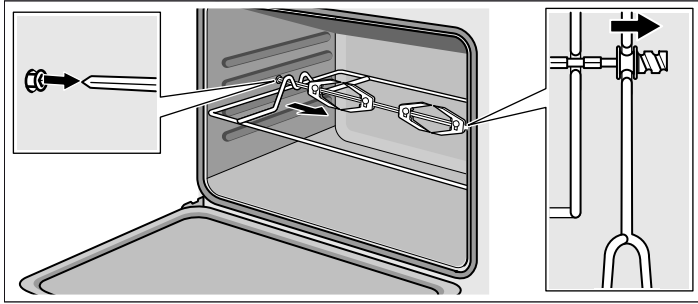

3. Pull the rotary spit shelf halfway out of the oven.
4. Hold the rotary spit in place on the left-hand side with an oven glove and screw the handle onto the rotary spit.

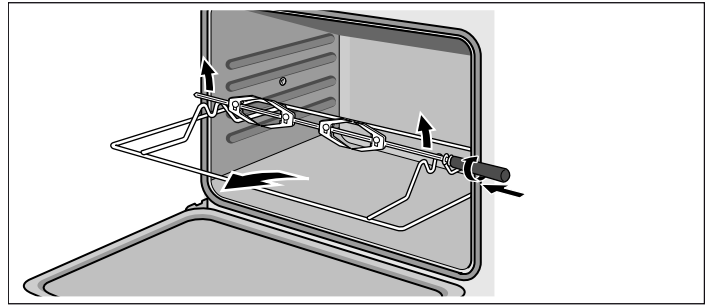

5. Lift the rotary spit carefully out of the rotary spit shelf.
6. Remove the rotary spit shelf and the baking tray from the oven.

Setting the time-setting options

Your oven has various time-setting options. You can use the button to call up the menu and switch between the individual functions. All the time symbols are lit when you can make settings. The brackets [] show you which time-setting option you have currently selected. A time-setting option which has already been set can be changed directly with the **+** or **-** button when the relevant time symbol is in brackets.

Timer

You can use the timer as a kitchen timer. It runs independently of the oven. The timer has its own signal. In this way, you can tell whether it is the timer or a cooking time which has elapsed.

1. Press the button once.
The time symbols light up in the display and the brackets are around .

2. Use the **+** or **-** button to set the timer duration.

Default value for **+**button = 10 minutes

Default value for **-**button = 5 minutes

After a few seconds, the time setting is adopted. The timer starts. The symbol lights up in the display and the timer duration counts down. The other time symbols go out.

The timer duration has elapsed

A signal sounds. 00:00 is shown in the display. Use the button to switch off the timer.

Changing the timer duration

Use the **+** or **-** button to change the timer duration. After a few seconds, the change is adopted.

Cancelling the timer duration

Use the **-** button to reset the timer duration to 00:00. The change will be adopted after a few seconds. The timer is switched off.

Checking the time settings

If several time-setting options are set, the relevant symbols are illuminated on the display. The symbol for the time-setting option that is visible in the display is shown in brackets.

To call up the timer, cooking time, end time or clock, press the button repeatedly until the brackets are around the relevant symbol. The display shows the value for a few seconds.

Cooking time

The cooking time for your dish can be set on the oven. When the cooking time has elapsed, the oven switches itself off automatically. This means that you do not have to interrupt other work to switch off the oven. The cooking time cannot be accidentally exceeded.

Example in the picture: cooking time 45 minutes.

1. Use the function selector to set the type of heating.
2. Set the temperature or grill setting using the temperature selector.
3. Press the button twice.
00:00 is shown in the display. The time symbols light up and the brackets are around .



4. Use the **+** or **-** button to set the cooking time.

Default value for **+** button = 30 minutes

Default value for **-** button = 10 minutes



The oven will start up after a few seconds. The cooking time counts down in the display and the [⌚] symbol lights up. The other time symbols go out.

The cooking time has elapsed

A signal sounds. The oven stops heating. 00:00 is shown in the display. Press the ⌚ button. You can set a new cooking time using the **+** or **-** button. Or press the ⌚ button twice and turn the function selector to the off position. The oven switches off.

Changing the cooking time

Use the **+** or **-** button to change the cooking time. After a few seconds, the change is adopted. If the timer has been set, press the ⌚ button beforehand.

Cancelling the cooking time

Use the **-** button to reset the cooking time to 00:00. After a few seconds, the change is adopted. The cooking time is cancelled. If the timer has been set, press the ⌚ button beforehand.

Checking the time settings

If several time-setting options are set, the relevant symbols are illuminated on the display. The symbol for the time-setting option that is visible in the display is shown in brackets.

To call up the ⌚ timer, ⌚ cooking time, ⌚ end time or ⌚ clock, press the ⌚ button repeatedly until the brackets are around the relevant symbol. The display shows the value for a few seconds.

End time

You can change the time at which you wish your dish to be ready. The oven starts automatically and finishes at the desired time. You can, for example, put your dish in the cooking compartment in the morning and set the cooking time so that it is ready at lunch time.

Ensure that food is not left in the cooking compartment for too long as it may spoil.

Example in the picture: it is 10:30 am, the cooking time is 45 minutes and the oven is required to finish cooking at 12:30 pm.

1. Adjust the function selector.
2. Set the temperature selector.
3. Press the ⌚ button twice.
4. Use the **+** or **-** button to set the cooking time.

5. Press the ⌚ button.

The brackets are around ⌚. The time when the dish will be ready is displayed.

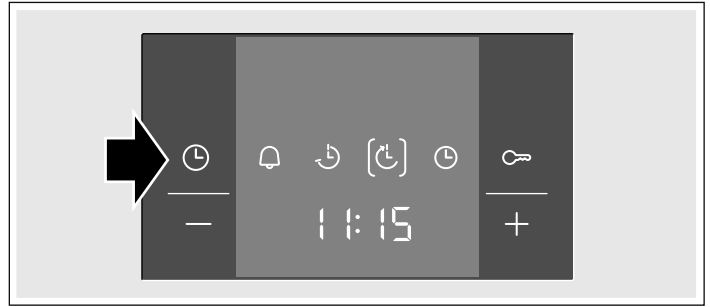

6. Use the **+** or **-** button to set a later end time.



After a few seconds, the oven adopts the settings and switches to standby position. The time at which the dish will be ready is shown in the display and the ⌚ symbol is in brackets. The ⌚ and ⌚ symbols go out. When the oven starts, you can see the cooking time counting down in the display and the ⌚ symbol is in brackets. The ⌚ symbol goes out.

The cooking time has elapsed

A signal sounds. The oven stops heating. 00:00 is shown in the display. Press the ⌚ button. You can set a new cooking time using the **+** or **-** button. Or press the ⌚ button twice and turn the function selector to the off position. The oven switches off.

Changing the end time

Use the **+** or **-** button to change the end time. After a few seconds, the change is adopted. If the timer has been set, first press the ⌚ button twice. Do not change the end time if the cooking time has already started to elapse. The cooking result would no longer be correct.

Cancelling the end time

Use the **-** button to reset the end time to the current time. After a few seconds, the change is adopted. The oven starts. If the timer has been set, first press the ⌚ button twice.

Checking the time settings

If several time-setting options are set, the relevant symbols are illuminated on the display. The symbol for the time-setting option that is visible in the display is shown in brackets.

To call up the ⌚ timer, ⌚ cooking time, ⌚ end time or ⌚ clock, press the ⌚ button repeatedly until the brackets are around the relevant symbol. The display shows the value for a few seconds.

Clock

After the appliance is connected or following a power cut, the ⌚ symbol and four zeros flash in the display. Set the clock.

1. Press the ⌚ button.

The clock in the display shows 12:00. The time symbols light up and the brackets are around ⌚.

2. Use the + or - button to set the clock.

After a few seconds, the time that has been set is adopted.

Changing the clock

No other time-setting option should have been set.

1. Press the ⌚ button four times.

The time symbols light up in the display and the brackets are around ⌚.

2. Use the + or - button to change the clock.

After a few seconds, the time that has been set is adopted.

Hiding the clock

You can hide the clock. For more information, please refer to the section *Changing the basic settings*.

Childproof lock

The oven has a childproof lock to prevent children from switching it on by accident.

The oven will not respond to any settings. You can still set the clock and the timer when the childproof lock is activated.

If the type of heating and temperature or grill setting are set, the childproof lock interrupts the heater element.

Note: If a hob is connected, it will not be affected by the childproof lock on the oven.

Activating the childproof lock

No cooking time or end time should be set.

Press and hold the 🔒 button for approx. four seconds.

The 🔒 symbol appears in the display. The childproof lock is activated.

Deactivating the childproof lock

Press and hold the 🔒 button for approx. four seconds.

The 🔒 symbol goes out in the display. The childproof lock is deactivated.

Changing the basic settings

Your oven has various basic settings. These settings can be customised to suit your requirements.

Basic setting	Selection 1	Selection 2	Selection 3
c1 Clock display	always*	only with the ⌚ button	-
c2 Signal duration upon completion of a cooking time or timer period	approx. 10 seconds	approx. 2 minutes*	approx. 5 minutes
c3 Waiting time until a setting is applied	approx. 2 seconds	approx. 5 seconds*	approx. 10 seconds

* Factory setting

No other time-setting option should have been set.

1. Press and hold the ⌚ button for approx. 4 seconds.

The current basic setting for the clock display is shown in the display, e.g. c1 1 for selection 1.

2. Use the + or - button to change the basic setting.

3. Confirm by pressing the ⌚ button.

The next basic setting appears in the display. You can scroll through all levels with the ⌚ button and change the setting with the + or - button.

4. To finish, press and hold the ⌚ button for approx. 4 seconds.

All basic settings are applied.

You may change the basic settings at any time.

Care and cleaning

With good care and cleaning, your oven will remain clean and fully-functioning for a long time to come. Here we will explain how to maintain and clean your oven correctly.

Notes

- Slight differences in the colours on the front of the oven are caused by the use of different materials, such as glass, plastic and metal.
- Shadows on the door panel which look like streaks, are caused by reflections made by the oven light.
- Enamel is baked on at very high temperatures. This can cause some slight colour variations. This is normal and does not affect their function. The edges of thin trays cannot be completely enamelled. As a result, these edges can be rough. This will not impair the anti-corrosion protection.

Risk of electric shock!

Do not use any high-pressure cleaners or steam cleaners, which can result in an electric shock.

Risk of burns!

The appliance becomes very hot. Never touch the interior surfaces of the cooking compartment or the heating elements. Always allow the appliance to cool down. Keep children at a safe distance.

Cleaning agents

Damage to the various different surfaces caused by using the wrong cleaning agent can be avoided by observing the following instructions.

Do not use

for the hob

- undiluted washing-up liquid or dishwasher detergent
- abrasive materials, scouring sponges
- aggressive cleaners such as oven spray or stain remover
- high-pressure cleaners or steam jet cleaners

Do not use

in the oven

- harsh or abrasive cleaning agents
- cleaning agents with a high alcohol content
- hard scouring pads or cleaning sponges
- high-pressure cleaners or steam cleaners.

Wash new sponge cloths thoroughly before use.

Area	Cleaning agents
Appliance exterior	Hot soapy water: Clean with a dish cloth and dry with a soft cloth. Do not use glass cleaners or glass scrapers.
Stainless steel	Hot soapy water: Clean with a dish cloth and dry with a soft cloth. Remove traces of limescale, grease, starch and albumin (e.g. egg white) immediately. Corrosion can form under such residues. Special stainless steel cleaning products suitable for hot surfaces are available from our after-sales service or from specialist retailers. Apply a very thin layer of the cleaning product with a soft cloth.
Aluminium and plastic	Glass cleaner: Clean with a soft cloth.

Area	Cleaning agents
Gas hob and pan supports	Hot soapy water. Use very little water. Water must not be allowed to enter the appliance through the base of the burners. Clean boiled over liquids and spilt food immediately. You can remove the pan supports. Do not clean the pan supports in the dishwasher.
Gas burners, hot-plate	Remove the burner cups and caps, clean them with soapy water. The gas outlet openings must remain free from obstruction. Ignition plugs: small, soft brush. The gas burners only work properly when the ignition plugs are clean. Dry all parts thoroughly. Ensure they are refitted correctly. The burner caps are coated in black enamel. The colour may change over time. This does not affect their operation. Do not clean the burner caps in the dishwasher.
Enamel surfaces (smooth surfaces)	To facilitate cleaning, you can switch on the interior lighting and detach the appliance door if necessary. Apply ordinary washing-up liquid or a vinegar solution with a soft, damp cloth or chamois leather; dry with a soft cloth. Loosen baked-on food residues with a damp cloth and detergent. We recommend using oven-cleaning gel for heavy deposits of dirt. This can be applied to the affected area. Leave the cooking compartment open after cleaning to allow it to dry.
Self-cleaning surfaces (rough surfaces)	Please see the notes in section: Self-cleaning surfaces
Door panels	Glass cleaner: Clean with a soft cloth. Do not use a glass scraper.
Glass cover for the oven light	Hot soapy water: Clean with a dish cloth.
Seal Do not remove.	Hot soapy water: Clean with a dish cloth. Do not scour.
Shelf	Hot soapy water: Soak and clean with a dish cloth or brush.
Accessories	Hot soapy water: Soak and clean with a dish cloth or brush.

Catalytic cooking compartment panels

The catalytic cooking compartment panels are coated with self-cleaning enamel.

The surfaces clean themselves while the oven is in operation. Larger splashes will only be removed after the oven has been used several times.

The rear and side walls are covered with catalytic panelling. Never clean these surfaces with oven cleaner. Slight discolouration of the enamel does not affect self-cleaning.

Removing and fitting the appliance door

You can remove the appliance door to clean it more thoroughly.

Removing the appliance door

Risk of injury!

Whenever the hinges are not locked, they snap shut with great force. When removing the oven door, ensure that the locking pins are fully inserted into the holes in the hinges.

1. Open the oven door fully.
2. Lock both hinges on the left and right using a locking pin (a).

Note: The locking pins must be fully inserted into the holes in the hinges.

3. Grip the oven door on either side with both hands and close the oven door by approx. 30° (b).

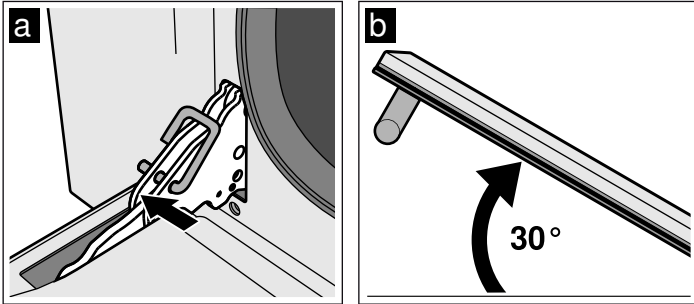

4. Raise the oven door slightly and pull it out.

Note: Do not fully close the oven door. The hinges may become bent and the enamel may be damaged.

Fitting the appliance door

1. Grip the oven door on either side with both hands.
2. Slide the hinges into the slots in the oven (a).

Note: The notch below the hinges must engage into the frame of the oven (b).

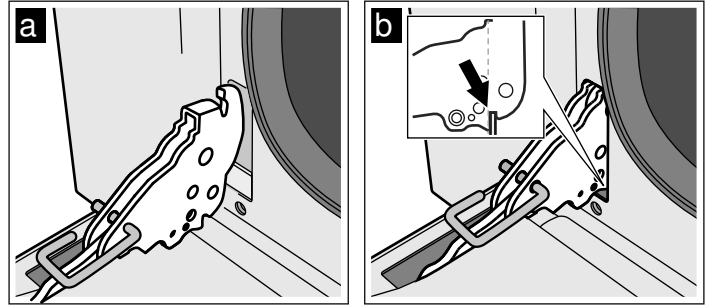

3. Lower the door downwards.
4. Remove the locking pins.

Risk of injury!

If the oven door falls out accidentally or a hinge snaps shut, do not reach into the hinge. Call after-sales service.

Removing and inserting the hook-in racks

You can remove the hook-in racks for easier cleaning.

Removing the hook-in racks

1. Unscrew the right and left-hand screws on the hook-in rack.
2. Remove the hook-in rack.

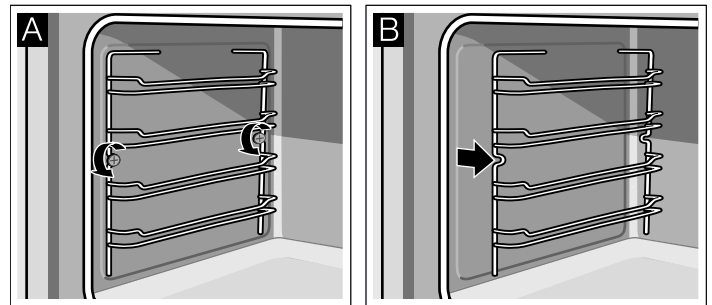

Inserting the hook-in rack

1. Hold the hook-in rack in front of the drill holes in the side panel.
2. Screw in the hook-in rack tight again using the screws.

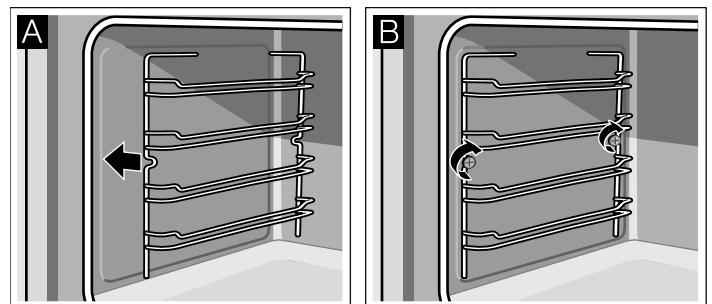

Troubleshooting

Malfunctions often have simple explanations. Refer to the table before calling the after-sales service, as you may be able to remedy the fault yourself.

DO NOT MODIFY THIS APPLIANCE.

SERVICING SHALL ONLY BE CARRIED OUT BY AN AUTHORISED PERSON.

Fault table

Fault	Possible cause	Remedy/information
The appliance is not functioning.	Faulty fuse	Look in the fuse box and check that the fuse is in working order.
	Power cut	Check whether the kitchen light works.
⊕ and zeros flash in the display.	Power cut	Reset the clock.
The oven light has failed.	Faulty oven light	Change the oven light bulb, (see section "Replacing oven light")
The gas burner does not ignite.	Power cut or damp ignition plugs	Light the gas burner with a gas lighter or a match.
The oven does not heat up.	Faulty fuse.	Check the fuse and replace if necessary.
	The function selector has not been set.	Set the function selector.
All dishes prepared in the oven burn within a short period of time.	Faulty thermostat	Call the after-sales service.
The door panel steams up when the oven is hot.	Normal occurrence; caused by the difference in temperature.	Not possible; this has no effect on oven performance.

Error messages

If an error message with **E** appears, press the ⊕ button. The message disappears. A time function that has been set is cleared. If the error message does not disappear, please contact the after-sales service.

You can take remedial action yourself if the following error message is displayed.

Error message	Possible cause	Remedy/information
E011	A button was depressed for too long or is covered up.	Press all buttons individually. Check whether any buttons are jammed, covered up or soiled.

⚠ Risk of electric shock!

Incorrect repairs are dangerous. Repairs may only be carried out by one of our trained after-sales engineers.

Replacing the oven light bulb

If the bulb in the oven light fails, it must be replaced. Replacement heat-resistant bulbs can be obtained from the after-sales service or from specialist retailers. Please supply your appliance's E number and FD number. Do not use any other type of bulb.

⚠ Risk of electric shock!

When replacing the cooking compartment bulb, the bulb socket contacts are live. Before replacing the bulb, unplug the appliance from the mains or switch off the circuit breaker in the fuse box.

1. Switch off the circuit breaker or unplug the mains plug.
2. Open the appliance door.
3. Place a tea towel in the cold cooking compartment to prevent damage.

⚠ Risk of injury!

Incorrect repairs may cause serious hazards. Repairs to the appliance may only be performed by a qualified technician. If repairs are required, contact the after-sales service.

4. Unscrew the glass cover from the defective oven light bulb inside the cooking compartment.

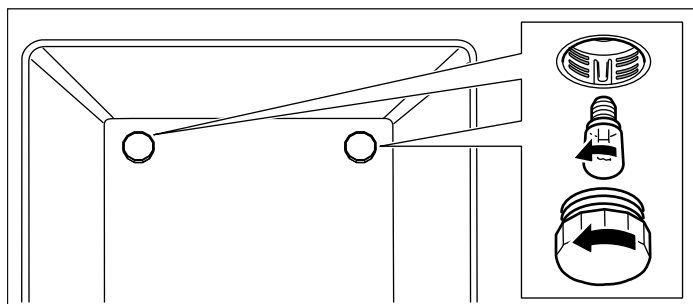

5. Replace the oven light bulb with a bulb of the same type.

Voltage: 230 V;

Power: 25 W;

Thread: E14;

Temperature resistance: 300°C

6. Screw the glass cover for the oven light back on.
7. Remove the tea towel and switch the circuit breaker back on or plug in the mains plug.
8. Switch on the oven lighting and check that it is working properly.

After-sales service

Our after-sales service is there for you if your appliance needs to be repaired. We will always find the right solution in order to avoid unnecessary visits from a service technician.

When calling us, please give the product number (E no.) and the production number (FD no.) so that we can provide you with the correct advice. The rating plate and the relevant numbers can be found on the inside of the storage compartment flap.

You can make a note of the numbers of your appliance and the telephone number of the after-sales service in the space below to save time should it be required.

E no.	FD no.
--------------	---------------

After-sales service 

Please be aware that a visit by an after-sales engineer will be charged if a problem turns out to be the result of operator error, even during the warranty period.

Please find the contact data of all countries in the enclosed customer service list.

To book an engineer visit and product advice

Australia 1300 368 339

New Zealand 0800 245 700

Rely on the professionalism of the manufacturer. You can therefore be sure that the repair is carried out by trained service technicians who carry original spare parts for your appliances.

Energy and environment tips

Here you can find tips on how to save energy when baking and roasting in the oven and when cooking on the hob, and how to dispose of your appliance properly.

Saving energy with your oven

- Only preheat the oven if this is specified in the recipe or in the operating instruction tables.
- Use dark, black lacquered or enamelled baking tins. They absorb the heat particularly well.
- Open the oven door as infrequently as possible while cooking, baking or roasting.
- It is best to bake more than one cake, one after the other. The oven is still warm. This reduces the baking time for the second cake. You can also place two loaf tins next to each other.
- For longer cooking times, you can switch the oven off 10 minutes before the end of the cooking time and use the residual heat to finish cooking.

Saving energy with the hob

- Always use a saucepan which is the correct size for your food. A larger, less full saucepan requires a lot of energy.
- Always place a suitable lid on the saucepan.
- Switch to a lower heat setting in good time.
- The gas flame must always be in contact with the base of the saucepan.

Environmentally-friendly disposal

Dispose of packaging in an environmentally-friendly manner.



This appliance is labelled in accordance with European Directive 2012/19/EU concerning used electrical and electronic appliances (waste electrical and electronic equipment - WEEE). The guideline determines the framework for the return and recycling of used appliances as applicable throughout the EU.



Robert Bosch Hausgeräte GmbH

Carl-Wery-Straße 34

81739 München

Germany

www.bosch-home.com



9000908984

914775327
950623