

Your new dryer

Congratulations - You have chosen to buy a modern, high-quality Bosch domestic appliance. A distinctive feature of your dryer is its low energy consumption.

Every dryer which leaves our factory is carefully checked to ensure that it functions correctly and is in perfect condition. Should you have any questions, our after-sales service will be pleased to help.

Environmentally responsible disposal

Dispose of packaging in an environmentally-responsible manner. This appliance is designated according to European directive 2002/96/EC which governs waste electrical and electronic equipment (WEEE). This directive provides the framework for the EU-wide collection and reuse of used appliances.

For further information about our products, accessories, spare parts and services, please visit: www.bosch-home.com

Observe the safety instructions on page 11.

Read the instruction manual and installation instructions before operating the dryer.

Contents	Page
■ Preparation	2
■ Setting the programmes	2
■ Drying	3/4
■ Notes on laundry	5
■ Care and cleaning	6
■ Overview of programmes	7
■ Installation	8
■ Technical data	9
■ Optional accessories	9
■ What to do if... / After-sales service	10
■ Safety instructions	11

Intended use

- exclusively for domestic use,
- only for drying fabrics which have been washed using water.

Do not leave children unsupervised near the dryer. Keep pets away from the dryer.
The dryer may be operated by children from 8 years of age, by persons who have limited physical, sensory or mental abilities and by persons who have inadequate experience or knowledge, provided they are supervised or have been instructed by a responsible person.

Preparing for installation, see page 8

Never operate the dryer if it is damaged. Inform your after-sales service.

Only if your hands are dry. Only hold the plug by the plug casing.

Remove all objects from pockets. Pay particular attention to cigarette lighters. The drum must be empty before filling.

Before using the dryer for the first time run the drying cycle without any laundry → page 7.

Inspecting the dryer

Connecting the mains plug

Sorting and loading laundry

Selecting and adjusting the programme
Select the drying programme ...
... and adapt to individual requirements

For a detailed programme overview, → page 7.

Service/Status indicators/Additional functions

- Start/Stop
- Reduce Heat
- Easy Iron
- Ready/Anti-Crease
- Clean

Programme selector

- Synthetics Cupboard Dry
- Iron Dry
- Timed Program Cold 20 min
- Warm 20 min.
- Warm 40 min.
- Off
- Cottons Extra Dry
- Cupboard
- Iron Dry
- Timed Program Warm 60 min.

Press the Start/Stop button

Only operate the dryer with the fluff filter inserted.

Clean	Flashes → clean the fluff filter, check the exhaust air duct → page 6.
Reduce Heat	Reduced temperature for delicate fabrics, e.g. polyacrylic, polyamide, elastane or acetate; for longer drying times.
Easy Iron	Reduces creasing and prolongs the anti-creasing phase after the programme has finished.

Drying

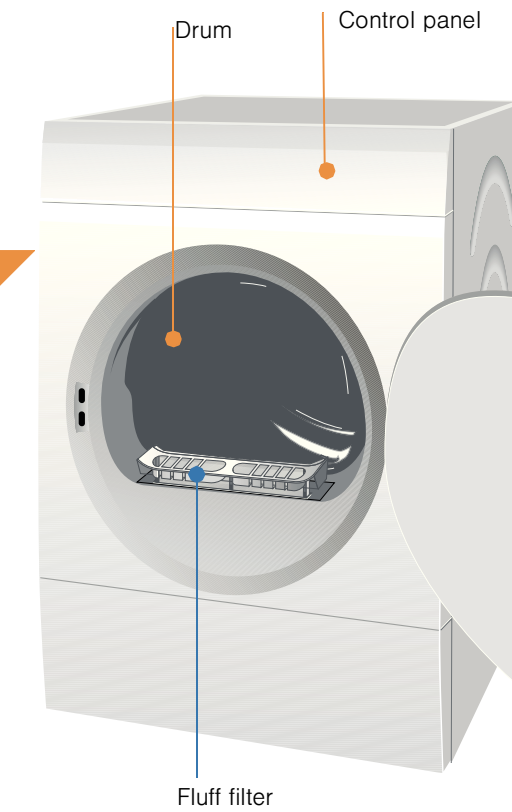

Drying

Cleaning the fluff filter

- Clean the fluff filter after each drying cycle.
- Open the door and pull out the fluff filter.
 - Remove the fluff (brush your hand over the fluff filter). If the fluff filter is very dirty or blocked, wash it out with warm water and dry thoroughly.
 - Insert the fluff filter so that you hear it engage.
 - Remove fluff from door/door area.

Switching off the dryer

Turn the programme selector to **Off**. Do not leave laundry in the dryer.

Removing the laundry

Your dryer has an automatic anti-crease function. The drum is moved at set intervals for 30 minutes after the programme has ended. Laundry remains loose and fluffy (for 90 minutes, if additional **Easy Iron** function is selected - depending on model).

End of programme as soon as the Ready/Anti-Crease indicator light flashes

Interrupting the programme Loading or removing laundry

- The drum and door may be hot.**
- The drying programme can be interrupted briefly for loading or removing laundry. The selected programme must then continue to run to the end.
- Open the door; the drying process is interrupted.
 - Load or remove laundry and close the door.
 - If required, select a new programme and additional functions.
 - Press the **Start/Stop** button.

Notes on laundry ...

Labelling of fabrics
Follow the manufacturer's care instructions.

- Drying at a normal temperature.
- Drying at a lower temperature → in addition, select **Reduce Heat**.
- Do not machine dry.

Be sure to follow the safety instructions → page 11!
For example, do not use the dryer for the following fabrics:

- Airtight fabrics (e.g. rubber-coated fabrics).
- Delicate materials (silk, curtains made from synthetic material) → they may crease.
- Laundry contaminated with oil.

Before drying for the first time

- Do not put any laundry in the machine. Turn the programme selector to Zeitprogramm (timer programme) (→ page 7) and select **Start/Stop**. At the end of the programme, turn the programme selector to **Off**.

Drying tips

- To ensure a consistent result, sort the laundry by fabric type and drying programme.
- Always dry very small fabrics (e.g. baby socks) together with large items of laundry (e.g. hand towels).
- Fasten zips, hooks and eyelets, button covers and tie together cloth belts, bands, etc.
- Do not overdry easy-care laundry → risk of creasing. Allow laundry to finish drying in the air.
- Do not iron laundry immediately after drying, fold items up and leave for a while → the remaining moisture will then be distributed evenly.
- Knitted fabrics (e.g. T-shirts, jerseys) often shrink slightly the first time they are tumble-dried. → Do not use the **Extra Dry** programme.
- Starched laundry is not always suitable for dryers → starch leaves behind a coating that adversely affects the drying operation.
- When washing the laundry that is to be tumble-dried, measure the fabric softener in accordance with the manufacturer's instructions.
- Using a timer programme with a small laundry load → optimisation of the drying result.

Environmental protection / Energy-saving tips

- Before drying, spin the laundry thoroughly in the washing machine → the higher the spin speed, the shorter the drying time will be (consumes less energy), also spin easy-care laundry.
- Use the maximum recommended fill level but do not overload with laundry → **overview of programmes, page 7**.
- Make sure the room is well ventilated during drying.
- Clean the fluff filter after every drying cycle → page 4.

Care and cleaning

Dryer housing, control panel

- Wipe off with a soft, damp cloth.
- Do not use abrasive cleaners or solvents.
- Remove detergent and cleaning agent residue immediately.

Exhaust air duct
Check the exhaust air duct. Clean the exhaust air duct every six months. Do not bend the exhaust air duct.

- Switch off the dryer and allow it to cool down.
- Disconnect the mains plug.
- Remove the exhaust air duct.
- Clean the exhaust air duct.
- Refit the exhaust air duct → Installation instructions for exhaust air duct.

Moisture sensors
The dryer is equipped with stainless steel moisture sensors. Moisture sensors measure the moisture level of the laundry. After sustained, repeated operation, a fine layer of limescale may form on the moisture sensors.

- Open the door.
- Clean the moisture sensors using a slightly damp sponge with a rough surface.

Do not use steel wool or abrasive materials.



PROGRAMMES

TEXTILE TYPE AND INFORMATION

max. 6 kg	Hard-wearing fabrics, boil-proof fabrics made of cotton or linen.
max. 3 kg	Non-iron laundry made of synthetic fibres and mixed fabric, easy-care cotton.
Iron Dry	The condition of the laundry means it is suitable for ironing (iron clothes in order to avoid creases).
Cupboard / Cupboard Dry	For single-layered laundry.
Extra Dry	For laundry with thick, multi-layered parts.
Timed Program	
Warm 60 min.	Pre-dried, multi-layered, sensitive fabrics made of acrylic fibres, or separate small items of laundry. Also for subsequent drying.
Warm 40 min.	
Warm 20 min.	
Cold 20 min.	All types of fabrics. For freshening up or airing of items of laundry that have been worn for a short period of time.

*only for the **Cottons** programme
 Dryness levels can be selected individually → **Extra Dry, **Cupboard / Cupboard Dry** and **Iron Dry** (depending on the model).
 Degree of dryness can be finely adjusted; multi-layered textiles require a longer drying time than single-layered items of clothing.
 Recommendation: Dry separately



9206 79000783333

Robert Bosch Hausgeräte GmbH
 Carl-Wery-Str. 34
 81739 München/Germany

WTAT410ISG

Installation

- Scope of delivery: dryer, instruction manual and installation instructions.
- Check dryer for transport damage.
- The dryer is very heavy. Do not lift without assistance.
- Be careful to avoid sharp edges.
- Do not lift the dryer by protruding parts (e.g. the door) - risk of breakage.
- Do not install in a room where there is a risk of freezing. Freezing water can cause damage.
- If in doubt, have the appliance connected by a specialist.

1. Setting up the dryer

- The mains plug must always be accessible.
- Ensure that the appliance is installed on a clean, level and firm surface.
- Install the exhaust air duct → Installation instructions for exhaust air duct.
- Keep the area around the dryer clean.
- Level the dryer using the front threaded feet. On no account remove the threaded feet.



Remove all accessories from the drum. The drum must be empty.



Do not install the dryer behind a door or sliding door which could prevent or obstruct the dryer door from opening. This will prevent children from locking themselves in and risking their lives.

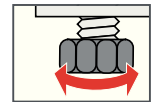

Clean and level

2. Mains connection

- For safety instructions, → page 11.
- Connect to an AC earthed socket. If in doubt have the socket checked by a specialist.
- The mains voltage and the voltage shown on the rating plate (→ page 9) must be the same.
- The connected load and necessary fuse protection are specified on the rating plate.

Technical data

● Dimensions (DxWxH)	60 x 60 x 85 cm
Weight	approximately 35 kg
Max. capacity	6 kg
Ambient temperature	5 - 35 °C
Connection voltage	220 - 240 V
Connected load	2200 W
Fuse protection	10 A
Product number	
Production number	→ Rating plate or inside of the door

You can find the rating plate on the back of the dryer.

● Consumption rates	These are guide values determined under standard conditions. Deviations of up to 10% are possible.		
	Spin speed rpm (residual moisture)	Drying time** in min incl. 8 min cooling time	Energy consumption** in kWh
👤 Cottons 6 kg			
👤 Cupboard / Cupboard Dry*	1400 (approx. 50 %)	100	3.00
	1000 (approx. 60 %)	120	3.38
	800 (approx. 70 %)	140	4.00
👤 Iron Dry*	1400 (approx. 50 %)	78	2.00
	1000 (approx. 60 %)	93	2.00
	800 (approx. 70 %)	108	3.00
👤 Synthetics 3 kg			
👤 Cupboard / Cupboard Dry*	800 (approx. 40 %)	44	1.00
	600 (approx. 50 %)	55	1.00

*Test programmes according to DIN EN 61121.
 **The values may diverge from those specified depending on overvoltage and undervoltage, fabric type, composition of the laundry to be dried, residual moisture in the fabric and the amount of the load.

Optional accessories (order from the after-sales service using the order number)

WTZ 1130	Exhaust air duct set (according to model) The exhaust air is extracted via a hose.
WTZ 11311	Washer-dryer stack connection set The dryer can be placed on top of a suitable washing machine with the same width and depth to save space. The dryer must be fastened to the washing machine using this connection set.

What to do if ...



If you cannot rectify a fault yourself (e.g. switching off/on), please contact our after-sales service. We will always find an appropriate solution and will avoid unnecessary visits by engineers. Trust the expertise of the manufacturer and rest assured that the repair will be carried out by trained service technicians using original spare parts. The contact details of your local after-sales service can be found in the enclosed **after-sales service** directory, or by calling one of these numbers:
 - **GB** 0844 8928979 (Calls from a BT landline will be charged at up to 3 pence per minute. A call set-up fee of up to 6 pence may apply.)
 - **IE** 01450 2655

When contacting the after-sales service, please quote the appliance's product number (E no.) and production number (FD) (see the inside of the door).
 Set the programme selector to **Off** and remove the appliance plug from the socket.

● ① Start/Stop indicator light does not light up.	Mains plug plugged in? Programme selected? Check the socket fuse.
● Clean 🌀/🌀 indicator light flashes.	Clean the fluff filter → page 4. Exhaust air duct blocked or bent? Clean the exhaust air duct → page 6. If necessary, clean the insect screen on the exhaust air pipe.
● Dryer does not start.	① Start/Stop button pressed? Door closed? Programme set?
● Programme terminated shortly after starting.	Ambient temperature greater than 5 °C?
● Water is leaking out.	Make sure the dryer is level.
● The door opens by itself.	Push the door closed until you hear it engage.
● The required degree of dryness was not achieved or the drying time was too long.	Clean the fluff filter → page 4. Ambient temperature higher than 35 °C → ventilate the room. Unsuitable programme selected? → page 7. Dryer installed too closely to other objects? Provide adequate air circulation. Mains failure → Restart the dryer. Fine layer of limescale on the moisture sensors. Clean the sensors → page 6.
● Laundry damp.	Use the next drying programme up or the timer programme → page 7. Warm laundry feels damper than it really is!
● The humidity in the room has increased significantly.	Make sure the room is sufficiently ventilated.
● One or more indicator lights are flashing.	Clean the fluff filter → page 4. Check the installation conditions → page 8. Exhaust air duct blocked or bent? Clean the exhaust air duct → page 6. Switch off, allow to cool, switch back on and restart the programme.
● Power cut.	Remove the laundry from the dryer immediately and spread it out. Heat may escape.
● Condensation in the exhaust air duct.	Exhaust air duct too long? Check the maximum exhaust air duct length. Further information → <i>Installation instructions for exhaust air duct.</i>

Safety instructions



Emergency ONLY use the dryer...	- Pull the mains plug out of the socket immediately or disconnect the fuse. - in rooms inside the house. - for drying fabrics.
The dryer must NEVER...	- be used for other purposes than those described above. - be modified in terms of its technology or attributes.
Dangers	- The dryer must not be used by children or persons who have not been instructed in its use. - Do not leave children unsupervised near the dryer. - Keep pets away from the dryer. - Remove all objects from the pockets of garments. Pay particular attention to cigarette lighters → risk of explosion - Do not lean or sit on the door → risk of tipping . - Open the door with care. Hot steam may escape.
Installation	- Fasten down loose leads → risk of tripping - Do not operate the dryer where there is a risk of frost. - The safety information in the separate installation instructions for the exhaust air duct must be observed without fail.
Mains connection	- Connect the dryer to an AC earthed socket according to specifications, as otherwise it cannot be guaranteed that the appliance is completely safe. - The cable cross-section must be sufficient. - Only use earth-leakage circuit breakers with the following symbol:  - The mains plug and socket must be compatible. - Do not use multiple plugs/couplings and/or extension cables. - Do not touch or hold the mains plug with wet hands → risk of electric shock . - Never pull the mains plug out of the socket by its cable. - Do not damage the mains lead → risk of electric shock .
Operation	- Only load the drum with items of laundry. Check what has been loaded before switching the dryer on. - Do not use the dryer if the laundry has been in contact with solvents, oil, wax, grease or paint (e.g. hair setting spray, nail polish remover, stain remover, cleaning solvent, etc.) → fire/explosion hazard . - Duct danger (e.g. coal dust or flour): do not use the dryer → risk of explosion . - Do not put laundry containing foamed material/rubber in the dryer → elastic material may be destroyed and the dryer may be damaged due to possible deformation of the foamed material. - Switch off the dryer once the programme has ended.
Defect	- Do not use the dryer if it is defective or if you suspect that it is. Repairs must only be carried out by the after-sales service. - Do not use the dryer with a faulty mains cable. In order to avoid risk, have the mains lead replaced only by our after-sales service.
Spare parts Disposal	- Only use genuine spare parts and accessories for safety reasons. - Dryer: Disconnect the mains plug, then cut the mains cable off the appliance. Dispose of the appliance at a public disposal site. - Packaging: Do not allow children access to items of packaging → risk of suffocation - All materials are environmentally friendly and reusable. Dispose of in an environmentally responsible manner.



Dryer

en Instruction manual

Your new dryer

Congratulations - You have chosen to buy a modern, high-quality Bosch domestic appliance.

A distinctive feature of your dryer is its low energy consumption.

Every dryer which leaves our factory is carefully checked to ensure that it functions correctly and is in perfect condition. Should you have any questions, our after-sales service will be pleased to help.

Environmentally responsible disposal

Dispose of packaging in an environmentally-responsible manner.

This appliance is designated according to European directive 2002/96/EC which governs waste electrical and electronic equipment (WEEE).

This directive provides the framework for the EU-wide collection and reuse of used appliances.

For further information about our products, accessories, spare parts and services, please visit: www.bosch-home.com



Observe the safety instructions on page 11.



Read the instruction manual and installation instructions before operating the dryer.

Contents

	Page
Preparation	2
Setting the programmes	2
Drying	3/4
Notes on laundry	5
Care and cleaning	6
Overview of programmes	7
Installation	8
Technical data	9
Optional accessories	9
What to do if... / After-sales service	10
Safety instructions	11

Intended use

- exclusively for domestic use,
- only for drying fabrics which have been washed using water.



Do not leave children unsupervised near the dryer. Keep pets away from the dryer.

The dryer may be operated by children from 8 years of age, by persons who have limited physical, sensory or mental abilities and by persons who have inadequate experience or knowledge, provided they are supervised or have been instructed by a responsible person.

Preparing for installation, see page 8



Never operate the dryer if it is damaged. Inform your after-sales service.



Only if your hands are dry. Only hold the plug by the plug casing.

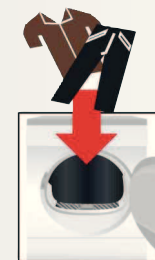

Sorting and loading

Remove all objects from pockets. Pay particular attention to cigarette lighters. The drum must be empty before filling.

Selecting and adjusting the programme

Select the programme

... and adapt to individual requirements

For a detailed programme description, see page 7

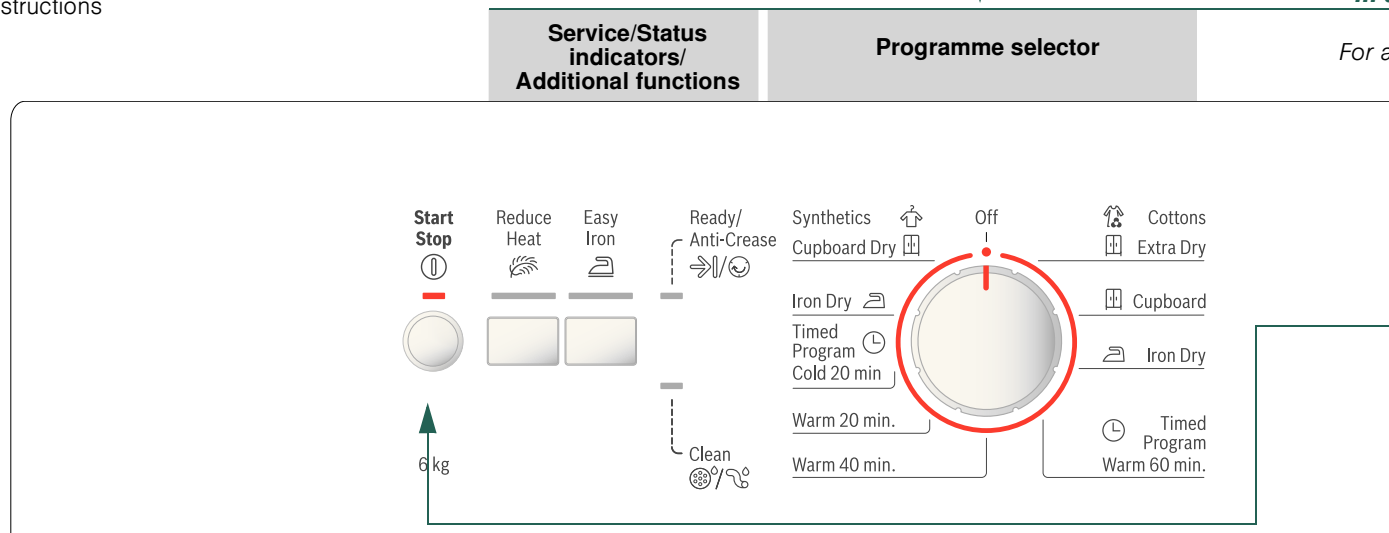

Press the () button



Only use with...

Clean

Flashes → clean the fluff filter, check the exhaust air duct → page 6.

Reduce Heat

Reduced temperature for delicate fabrics , e.g. polyacrylic, polyamide, elastan acetate; for longer drying times.

Easy Iron

Reduces creasing and prolongs the anti-creasing phase after the programme finished.

using the dryer for the first time
drying cycle without any laundry → page 7.

Inspecting
the dryer

Connecting the
mains plug

Loading laundry

Selecting the programme

Starting the drying programme ...

Individual requirements

For an overview, → page 7.

Start/Stop button

How to operate the dryer
with the fluff filter inserted.

or

has

Drying

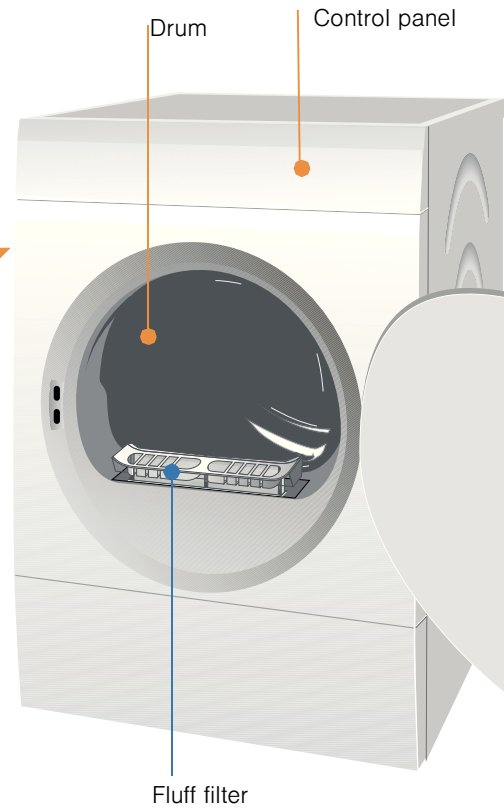

1
2

3

Drying



Cleaning the fluff filter

Clean the fluff filter after each drying cycle.

1. Open the door and pull out the fluff filter.
2. Remove the fluff (brush your hand over the fluff filter).
If the fluff filter is very dirty or blocked, wash it out with warm water and dry thoroughly.
3. Insert the fluff filter so that you hear it engage.
4. Remove fluff from door/door area.

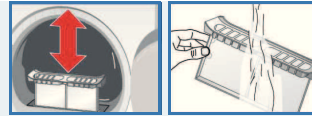

Switching off the dryer

Turn the programme selector to **Off**.
Do not leave laundry in the dryer.

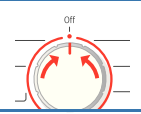

Removing the laundry

Your dryer has an automatic anti-crease function. The drum is moved at set intervals for 30 minutes after the programme has ended. Laundry remains loose and fluffy (for 90 minutes, if additional **Easy Iron** function is selected - depending on model).

End of programme as soon as the **Ready/Anti-Crease** →/⏸ indicator light flashes



Interrupting the programme Loading or removing laundry



The drum and door may be hot.



The drying programme can be interrupted briefly for loading or removing laundry. The selected programme must then continue to run to the end.

1. Open the door; the drying process is interrupted.
2. Load or remove laundry and close the door.
3. If required, select a new programme and additional functions.
4. Press the **Start/Stop** button.

Notes on laundry ...



Labelling of fabrics

Follow the manufacturer's care instructions.

- ☑ Drying at a normal temperature.
- ☑ Drying at a lower temperature → in addition, select **Reduce Heat** .
- ☒ Do not machine dry.



Be sure to follow the safety instructions → *page 11!*
For example, do not use the dryer for the following fabrics:

- Airtight fabrics (e.g. rubber-coated fabrics).
- Delicate materials (silk, curtains made from synthetic material) → they may crease.
- Laundry contaminated with oil.



Before drying for the first time

- Do not put any laundry in the machine. Turn the programme selector to Zeitprogramm (timer programme) (→ *page 7*) and select **Start/Stop**. At the end of the programme, turn the programme selector to **Off**.



Drying tips

- To ensure a consistent result, sort the laundry by fabric type and drying programme.
- Always dry very small fabrics (e.g. baby socks) together with large items of laundry (e.g. hand towels).
- Fasten zips, hooks and eyelets, button covers and tie together cloth belts, bands, etc.
- Do not overdry easy-care laundry → risk of creasing
Allow laundry to finish drying in the air.
- Do not iron laundry immediately after drying, fold items up and leave for a while → the remaining moisture will then be distributed evenly.
- Knitted fabrics (e.g. T-shirts, jerseys) often shrink slightly the first time they are tumble-dried.
→ Do not use the **Extra Dry** programme.
- Starched laundry is not always suitable for dryers → starch leaves behind a coating that adversely affects the drying operation.
- When washing the laundry that is to be tumble-dried, measure the fabric softener in accordance with the manufacturer's instructions.
- Using a timer programme with a small laundry load → optimisation of the drying result.

Environmental protection / Energy-saving tips

- Before drying, spin the laundry thoroughly in the washing machine → the higher the spin speed, the shorter the drying time will be (consumes less energy), also spin easy-care laundry.
- Use the maximum recommended fill level but do not overload with laundry
→ *overview of programmes, page 7*.
- Make sure the room is well ventilated during drying.
- Clean the fluff filter after every drying cycle → *page 4*.

Care and cleaning



Only when the appliance is switched off.



Dryer housing, control panel

- Wipe off with a soft, damp cloth.
- Do not use abrasive cleaners or solvents.
- Remove detergent and cleaning agent residue immediately.



Exhaust air duct

Check the exhaust air duct. Clean the exhaust air duct every six months. Do not bend the exhaust air duct.

1. Switch off the dryer and allow it to cool down.
2. Disconnect the mains plug.
3. Remove the exhaust air duct.
4. Clean the exhaust air duct.
5. Refit the exhaust air duct → Installation instructions for exhaust air duct.



Moisture sensors

The dryer is equipped with stainless steel moisture sensors. Moisture sensors measure the moisture level of the laundry. After sustained, repeated operation, a fine layer of limescale may form on the moisture sensors.

1. Open the door.
2. Clean the moisture sensors using a slightly damp sponge with a rough surface.



Do not use steel wool or abrasive materials.

Sort the laundry according to type of textile and fabric. Fabrics must be suitable for tumble drying.

After drying, laundry is to be ...	ironed	lightly ironed	not ironed	mangled
PROGRAMMES				
TEXTILE TYPE AND INFORMATION				
** Cottons	max. 6 kg			
** Synthetics	max. 3 kg			
Iron Dry				
Cupboard / Cupboard Dry				
* Extra Dry				
Timed Program				
Warm 60 min.				
Warm 40 min.	max. 3 kg			
Warm 20 min.				
Cold 20 min.	max. 3 kg			

*only for the **Cottons** programme.

**Dryness levels can be selected individually → Extra Dry, Cupboard / Cupboard Dry and Iron Dry (depending on the model). Degree of dryness can be finely adjusted; multi-layered textiles require a longer drying time than single-layered items of clothing.

Recommendation: Dry separately

9206 / 9000783333



Robert Bosch Hausgeräte GmbH
Carl-Wery-Str. 34
81739 München/Germany

WTA74101SG

Installation

- Scope of delivery: dryer, instruction manual and installation instructions.
- Check dryer for transport damage.
- The dryer is very heavy. Do not lift without assistance.
- Be careful to avoid sharp edges.
- Do not lift the dryer by protruding parts (e.g. the door) - risk of breakage.
- Do not install in a room where there is a risk of freezing. Freezing water can cause damage.
- If in doubt, have the appliance connected by a specialist.

1. Setting up the dryer

- The mains plug must always be accessible.
- Ensure that the appliance is installed on a clean, level and firm surface.
- Install the exhaust air duct → Installation instructions for exhaust air duct.
- Keep the area around the dryer clean.
- Level the dryer using the front threaded feet. On no account remove the threaded feet.

Remove all accessories from the drum. The drum must be empty.

Do not install the dryer behind a door or sliding door which could prevent or obstruct the dryer door from opening. This will prevent children from locking themselves in and risking their lives.

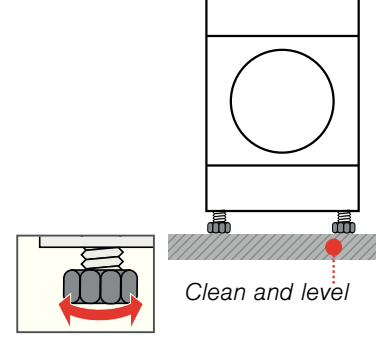

2. Mains connection For safety instructions, → page 11.

- Connect to an AC earthed socket. If in doubt have the socket checked by a specialist.
- The mains voltage and the voltage shown on the rating plate (→ page 9) must be the same.
- The connected load and necessary fuse protection are specified on the rating plate.

Technical data

● Dimensions (DxWxH)	60 x 60 x 85 cm
Weight	approximately 35 kg
Max. capacity	6 kg
Ambient temperature	5 - 35 °C
Connection voltage	220 - 240 V
Connected load	2200 W
Fuse protection	10 A
Product number	
Production number	→ Rating plate or inside of the door

You can find the rating plate on the back of the dryer.

● Consumption rates	These are guide values determined under standard conditions. Deviations of up to 10% are possible.		
	Spin speed rpm (residual moisture)	Drying time** in min incl. 8 min cooling time	Energy consumption** in kWh
👕 Cottons 6 kg			
☑ Cupboard / Cupboard Dry*	1400 (approx. 50 %)	100	3.00
	1000 (approx. 60 %)	120	3.38
	800 (approx. 70 %)	140	4.00
☑ Iron Dry*	1400 (approx. 50 %)	78	2.00
	1000 (approx. 60 %)	93	2.00
	800 (approx. 70 %)	108	3.00
👚 Synthetics 3 kg			
☑ Cupboard / Cupboard Dry*	800 (approx. 40 %)	44	1.00
	600 (approx. 50 %)	55	1.00

*Test programmes according to DIN EN 61121.

**The values may diverge from those specified depending on overvoltage and undervoltage, fabric type, composition of the laundry to be dried, residual moisture in the fabric and the amount of the load.

Optional accessories (order from the after-sales service using the order number)

WTZ
1130

Exhaust air duct set (according to model)
The exhaust air is extracted via a hose.

WTZ
11311

Washer-dryer stack connection set
The dryer can be placed on top of a suitable washing machine with the same width and depth to save space.
The dryer **must be** fastened to the washing machine using this connection set.

What to do if ...



If you cannot rectify a fault yourself (e.g. switching off/on), please contact our after-sales service. We will always find an appropriate solution and will avoid unnecessary visits by engineers. Trust the expertise of the manufacturer and rest assured that the repair will be carried out by trained service technicians using original spare parts. The contact details of your local after-sales service can be found in the enclosed **after-sales service** directory, or by calling one of these numbers:

– **GB** 0844 8928979 (Calls from a BT landline will be charged at up to 3 pence per minute.

A call set-up fee of up to 6 pence may apply.)

– **IE** 01450 2655

When contacting the after-sales service, please quote the appliance's product number (E no.) and production number (FD) (see the inside of the door).

Set the programme selector to **Off** and remove the appliance plug from the socket.

● ① Start/Stop indicator light does not light up.	Mains plug plugged in? Programme selected? Check the socket fuse.
● Clean 🌀/🌀 indicator light flashes.	Clean the fluff filter → <i>page 4</i> . Exhaust air duct blocked or bent? Clean the exhaust air duct → <i>page 6</i> . If necessary, clean the insect screen on the exhaust air pipe.
● Dryer does not start.	① Start/Stop button pressed? Door closed? Programme set?
● Programme terminated shortly after starting.	Ambient temperature greater than 5 °C?
● Water is leaking out.	Make sure the dryer is level.
● The door opens by itself.	Push the door closed until you hear it engage.
● The required degree of dryness was not achieved or the drying time was too long.	Clean the fluff filter → <i>page 4</i> . Ambient temperature higher than 35 °C → ventilate the room. Unsuitable programme selected? → <i>page 7</i> . Dryer installed too closely to other objects? Provide adequate air circulation. Mains failure → Restart the dryer. Fine layer of limescale on the moisture sensors. Clean the sensors → <i>page 6</i> .
● Laundry damp.	Use the next drying programme up or the timer programme → <i>page 7</i> . Warm laundry feels damper than it really is!
● The humidity in the room has increased significantly.	Make sure the room is sufficiently ventilated.
● One or more indicator lights are flashing.	Clean the fluff filter → <i>page 4</i> . Check the installation conditions → <i>page 8</i> . Exhaust air duct blocked or bent? Clean the exhaust air duct → <i>page 6</i> . Switch off, allow to cool, switch back on and restart the programme.
● Power cut.	Remove the laundry from the dryer immediately and spread it out. Heat may escape.
● Condensation in the exhaust air duct.	Exhaust air duct too long? Check the maximum exhaust air duct length. Further information → <i>Installation instructions for exhaust air duct</i> .

Safety instructions



- Emergency**
- Pull the mains plug out of the socket immediately or disconnect the fuse.
- ONLY use the dryer...**
- in rooms inside the house.
 - for drying fabrics.
- The dryer must NEVER...**
- be used for other purposes than those described above.
 - be modified in terms of its technology or attributes.
- Dangers**
- The dryer must not be used by children or persons who have not been instructed in its use.
 - Do not leave children unsupervised near the dryer.
 - Keep pets away from the dryer.
 - Remove all objects from the pockets of garments.
Pay particular attention to cigarette lighters → **risk of explosion**
 - Do not lean or sit on the door → **risk of tipping.**
 - Open the door with care. Hot steam may escape.
- Installation**
- Fasten down loose leads → **risk of tripping**
 - Do not operate the dryer where there is a risk of frost.
 - The safety information in the separate installation instructions for the exhaust air duct must be observed without fail.
- Mains connection**
- Connect the dryer to an AC earthed socket according to specifications, as otherwise it cannot be guaranteed that the appliance is completely safe.
 - The cable cross-section must be sufficient.
 - Only use earth-leakage circuit breakers with the following symbol:
 - The mains plug and socket must be compatible.
 - Do not use multiple plugs/couplings and/or extension cables.
 - Do not touch or hold the mains plug with wet hands → **risk of electric shock.**
 - Never pull the mains plug out of the socket by its cable.
 - Do not damage the mains lead → **risk of electric shock.**
- Operation**
- Only load the drum with items of laundry.
Check what has been loaded before switching the dryer on.
 - Do not use the dryer if the laundry has been in contact with solvents, oil, wax, grease or paint (e.g. hair setting spray, nail polish remover, stain remover, cleaning solvent, etc.) → **fire/explosion hazard.**
 - Dust danger (e.g. coal dust or flour): do not use the dryer → **risk of explosion.**
 - Do not put laundry containing foamed material/rubber in the dryer → elastic material may be destroyed and the dryer may be damaged due to possible deformation of the foamed material.
 - Switch off the dryer once the programme has ended.
- Defect**
- Do not use the dryer if it is defective or if you suspect that it is.
Repairs must only be carried out by the after-sales service.
 - Do not use the dryer with a faulty mains cable. In order to avoid risk, have the mains lead replaced only by our after-sales service.
- Spare parts**
- Only use genuine spare parts and accessories for safety reasons.
- Disposal**
- Dryer: Disconnect the mains plug, **then** cut the mains cable off the appliance. Dispose of the appliance at a public disposal site.
 - Packaging: Do not allow children access to items of packaging → **risk of suffocation**
 - All materials are environmentally friendly and reusable. Dispose of in an environmentally responsible manner.



en Instruction manual