

en

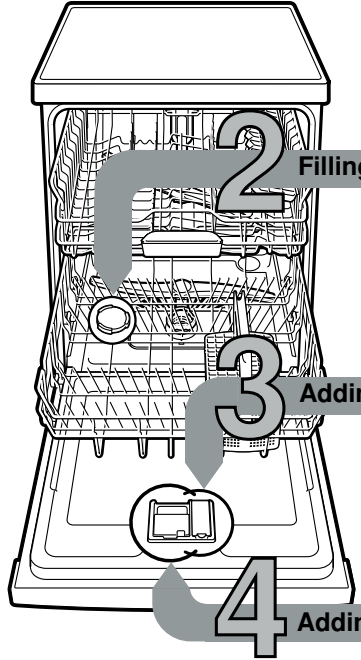

Brief and handy: everything your dishwasher needs ...  
**Before using for the first time, read the Installation instructions and Operating instructions!**



1

**Adjusting the water softening system \***

Ask your water supply company what the water hardness is and enter ...

Water hardness value °Clarke	Hardness range	mmol/l	Factory setting
0-8	soft	0-1.1	H:00
9-10	soft	1.2-1.4	H:01
11-12	medium	1.5-1.8	H:02
13-15	medium	1.9-2.1	H:03
16-20	medium	2.2-2.9	H:04
21-26	hard	3.0-3.7	H:05
27-38	hard	3.8-5.4	H:06
39-62	hard	5.5-8.9	H:07

\* only before the first wash or if the water hardness has been changed

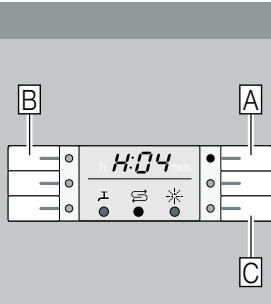

Quickly sorted ...

**How to adjust**

- Switch on ON/OFF switch.
- Hold down programme button A and press START button until H:0... is indicated on the digital display.
- Release both buttons. The LED for button A flashes and the factory set value of H:04 is indicated on the digital display.
- Press programme button C. Each time the button is pressed the set value increases by one setting; when the value reaches H:07, the display jumps back to H:00 (off).
- Press START button. The chosen setting has now been stored.

**2 Filling the salt dispenser** Dissolves limescale (not necessary for set value 0!) ...



Unscrew cover.

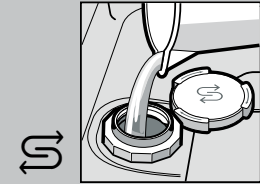

Fill the salt dispenser with water before the first wash only.



Add special salt (never add detergent!).



Screw on the cover. Wash immediately.

**3 Adding rinse aid** Spick and span ...



Press mark 1, lift up cover 2.

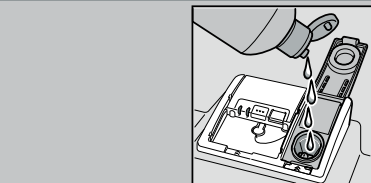

Fill in rinse aid.



Screw on the cover. CLICK!

**4 Adding detergent** A lot of dirt, a lot of detergent ...

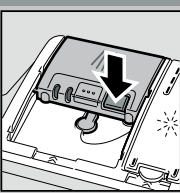

If required, open the cover (press button).

Attention: Combination products are not suitable for all programmes, follow manufacturer's instructions.

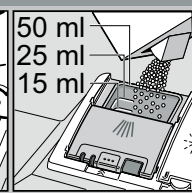
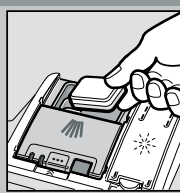

Pour detergent into the dry detergent dispenser only.

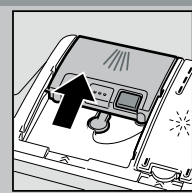

Slide cover shut, press. PLOP!

5

**Switching on the appliance**

6

**Select programme** Quick, economical or intensive ...

**Overview of programmes**

The max. possible number of programmes is illustrated in this overview. The corresponding programmes for your appliance can be found on the fascia.

The programme data has been measured in the laboratory according to European standard EN 50242. Deviations are possible in practice. \* half normal load

	Intensive 70°	Auto 45°-65°	Eco 50°	Gentle 40°	Quick 45°	Prerinse
Duration: hs : mins	←-----→	3:15 - 1:05	←-----→	←-----→	0:29 *	0:15
Energy consumption in kWh	←-----→	1,60 - 0,75	←-----→	←-----→	0,80	0,05
Water consumption in litres	←-----→	19 - 9	←-----→	←-----→	10	4

**Start programme** Here we go ...

8 7

**Additional options \*\***



Express Wash/Speed Perfect (VarioSpeed)

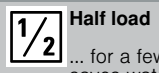

Half load ... for a few items, saves water, energy and time.



Intensive zone ... perfect for a mixed load. Washing pressure and washing temperature are increased slightly.

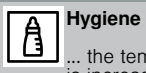

Hygiene ... the temperature is increased during the final rinse process. This increases the hygiene status.



Extra drying ... improves the drying result by increased temperature in the final rinse. (Please take care with delicate dishes.)

9

**Switch off the appliance** Everything o.k. ...

\*\* depending on model

**Maintenance and care**

For perfect rinsing results ...

**Cleaning waste water pump**

**Filters**  
... check, if required, clean.

Rotate filter cylinder, remove filter system ...

rinse under running water ...

insert ...

Screw on filter system  
**NOTE MARK!**

- Pull out the mains plug.
- Remove filters and scoop out water.
- Lever off cover (A).
- Check area around the fan impeller for foreign objects.
- Click cover shut (B).
- Insert filters.

**Spray arms**  
... Remove blockages/deposits.

pull lower arm upwards ...

unscrew upper arm ...

clean spray nozzles under running water (if required use toothpicks) ...

insert lower arm ...  
screw on upper arm tightly

**Rectifying minor faults yourself ...**

... as it is worth doing it yourself!

More information can be found in the operating instructions

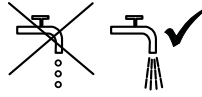
Fault	Possible causes	Remedial action
Display "E:1" is lit	Supply fitting jammed or calcified 	<ul style="list-style-type: none"> <li>▶ Open supply fitting.</li> <li>▶ 1. Unscrew water connection.</li> <li>▶ 2. Clean filter in the water connection.</li> <li>▶ 3. Flow rate must be min. 10 l/min., when water supply is open.</li> <li>▶ If the flow rate is less, replace the supply fitting.</li> <li>▶ Install supply hose without kinks.</li> </ul>
Display "E:22"	Filters are soiled or blocked	▶ Clean the filters (see above).
Display "E:24" and "E:1" are lit	Waste water hose is blocked or kinked Cover not attached to waste water pump	<ul style="list-style-type: none"> <li>▶ Install waste water hose without kinks.</li> <li>▶ Attach cover (see above).</li> </ul>
Display "E:25" and "E:1" are lit	Waste water pump blocked	▶ Clean waste-water pump (see above).
Other fault display "E:XX" is lit	Appliance has technical defect	<ul style="list-style-type: none"> <li>▶ Call factory customer service (state fault display).</li> <li>▶ Unplug appliance.</li> </ul>
Residual water in the appliance	The programme has not yet ended	▶ Close the appliance and switch it on or terminate the programme (see Terminating the programme).
Rust on the cutlery	Cutlery not rust-resistant Hard knife blades are more susceptible Extraneous rust	<ul style="list-style-type: none"> <li>▶ Use dishwasher-proof cutlery.</li> <li>▶ Never wash rusting parts in the appliance.</li> </ul>

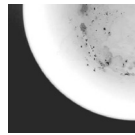
Fault	Possible causes	Remedial action
Utensils are not clean	Utensils are situated close together or one above the other	▶ Separate the utensils, prevent contact points.
Sand or gritty residue on the utensils 	Too little detergent Unsuitable programme selected Spray arm nozzles blocked Filters dirty, not seated firmly Spray arms blocked	<ul style="list-style-type: none"> <li>▶ Follow manufacturer's instructions (detergent).</li> <li>▶ Select a more intensive programme.</li> <li>▶ Clean the spray arms (see above).</li> <li>▶ Clean the filters (see above).</li> <li>▶ Arrange the utensils so that the spray arms can rotate freely.</li> </ul>
Stains and streaks	Rinse aid dosage too high/too low	<ul style="list-style-type: none"> <li>▶ Streaks: reduce dosage.</li> <li>▶ Water or limescale stains: increase dosage.</li> </ul>
Utensils not dry	Rinse aid The combined detergent used has a poor drying performance Appliance setting	<ul style="list-style-type: none"> <li>▶ Increase dosage.</li> <li>▶ Change the product.</li> <li>▶ Use rinse aid.</li> <li>▶ Activate intensive drying (depending on model).</li> </ul>
Milky deposits on the utensils (can be removed)	Water softening system incorrectly set No salt	<ul style="list-style-type: none"> <li>▶ Correctly set water softening system.</li> <li>▶ Refill with special salt.</li> </ul>
Milky deposits, glasses cloudy/tarnished (cannot be removed)	Glasses not dishwasher-proof	▶ Use dishwasher-proof glasses.
		▶ Use a detergent suitable for glasses.
Plastic/utensils discoloured	Too little detergent Discoloration caused by food colourings (tomato sauce)	<ul style="list-style-type: none"> <li>▶ Follow manufacturer's instructions (detergent).</li> <li>▶ Discoloration is harmless; subsequent rinse cycles will cause it to fade.</li> </ul>

**Terminating the programme ...**

**Loading the dishwasher correctly ...**

While the programme is running, press the START button for approx. 3 sec. (Reset).



The numerical display indicates "0:01"; approx. 1 minute after the programme ends, "0:00" is indicated.



Switch off the appliance.

Dishwasher-proof utensils (not soiled with ash, wax, lubricating grease, ink or adhesive labels; remove large remnants of jam, milk products and food according to the operating instructions and check that the spray arms can rotate freely).