



Built-in oven HB.43S..., HB.43T..., HB.43B..., HB.43R..., HEV43T...



**BOSCH**

[en] Instruction manual

# en Table of contents

<b>Important safety information</b> .....	<b>3</b>	Jam making .....	21
Causes of damage .....	4	<b>Acrylamide in food</b> .....	<b>22</b>
<b>Your new oven</b> .....	<b>5</b>	<b>Test dishes</b> .....	<b>22</b>
Control panel .....	5	Baking .....	22
Function control knob .....	5	Grilling .....	23
Control buttons and display panel .....	5		
Temperature control knob.....	6		
Inside the oven .....	6		
<b>Your accessories</b> .....	<b>6</b>		
inserting the accessories .....	6		
Optional accessories .....	7		
<b>Before using the oven for the first time</b> .....	<b>7</b>		
Setting the time .....	7		
Heating the oven.....	7		
Cleaning the accessories.....	7		
<b>Programming the oven</b> .....	<b>8</b>		
Type of heating and temperature .....	8		
Rapid heating .....	8		
<b>Setting the time functions</b> .....	<b>8</b>		
Timer .....	8		
Cooking time .....	9		
End time.....	9		
Time.....	10		
<b>Childproof lock</b> .....	<b>10</b>		
<b>Changing the basic settings</b> .....	<b>10</b>		
<b>Cleaning function</b> .....	<b>11</b>		
Before cleaning .....	11		
Setting .....	11		
After cleaning.....	11		
<b>Care and cleaning</b> .....	<b>11</b>		
Cleaning products .....	11		
Light.....	12		
Removing the grill heating element.....	12		
Removing and refitting the wire shelves or left and right hand side rails .....	12		
Unhooking and hanging the oven door .....	13		
Removing and installing the door panels .....	13		
<b>Troubleshooting</b> .....	<b>14</b>		
Troubleshooting table .....	14		
Changing the oven bulb.....	14		
Protective glass panels.....	14		
<b>After-sales service</b> .....	<b>15</b>		
E number and FD number .....	15		
<b>Energy and environment tips</b> .....	<b>15</b>		
Saving energy.....	15		
Environmentally-friendly disposal.....	15		
<b>Tested for you in our cooking studio</b> .....	<b>15</b>		
Cakes and pastries .....	15		
Practical cooking tips and suggestions .....	17		
Meat, poultry, fish.....	17		
Tips for roasting and grilling.....	19		
Gratins, soufflés, browned items .....	19		
Ready-made products.....	20		
Special dishes .....	20		
Defrosting .....	20		
Drying .....	21		

Additional information on products, accessories, replacement parts and services can be found at [www.bosch-home.com](http://www.bosch-home.com) and in the online shop [www.bosch-eshop.com](http://www.bosch-eshop.com)

## Important safety information

Read these instructions carefully. Only then will you be able to operate your appliance safely and correctly. Retain the instruction manual and installation instructions for future use or for subsequent owners.

This appliance is only intended to be fully fitted in a kitchen. Observe the special installation instructions.

Check the appliance for damage after unpacking it. Do not connect the appliance if it has been damaged in transport.

Only a licensed professional may connect appliances without plugs. Damage caused by incorrect connection is not covered under warranty.

This appliance is intended for domestic use only. The appliance must only be used for the preparation of food and drink. The appliance must be supervised during operation. Only use this appliance indoors.

This appliance is intended for use up to a maximum height of 2000 metres above sea level.

This appliance may be used by children over the age of 8 years old and by persons with reduced physical, sensory or mental capabilities or by persons with a lack of experience or knowledge if they are supervised or are instructed by a person responsible for their safety how to use the appliance safely and have understood the associated hazards.

Children must not play with, on, or around the appliance. Children must not clean the appliance or carry out general maintenance unless they are at least 8 years old and are being supervised.

Keep children below the age of 8 years old at a safe distance from the appliance and power cable.

Always slide accessories into the cooking compartment correctly. See "*Description of accessories*" in the instruction manual.

Mechanical abrasion on baking trays can cause some of the aluminium to be removed, and acidic, alkaline and salty foods can cause the aluminium to dissolve, for example due to fruit acid or baked goods dipped in a lye solution. Do not place food directly onto the baking tray. Line the baking tray with greaseproof paper. Do not use sharp metal objects. Do not use aggressive or abrasive cleaning agents.

### **Risk of fire!**

- Combustible items stored in the cooking compartment may catch fire. Never store combustible items in the cooking compartment. Never open the appliance door if there is smoke inside. Switch off the appliance and unplug it from the mains or switch off the circuit breaker in the fuse box.
- A draught is created when the appliance door is opened. Greaseproof paper may come into contact with the heating element and catch fire. Do not place greaseproof paper loosely over accessories during preheating. Always weight down the greaseproof paper with a dish or a baking tin. Only cover the surface required with greaseproof paper. Greaseproof paper must not protrude over the accessories.

### **Risk of burns!**

- The appliance becomes very hot. Never touch the interior surfaces of the cooking compartment or the heating elements. Always allow the appliance to cool down. Keep children at a safe distance.
- Accessories and ovenware become very hot. Always use oven gloves to remove accessories or ovenware from the cooking compartment.
- Alcoholic vapours may catch fire in the hot cooking compartment. Never prepare food containing large quantities of drinks with a high alcohol content. Only use small quantities of drinks with a high alcohol content. Open the appliance door with care.

### **Risk of scalding!**

- The accessible parts become hot during operation. Never touch the hot parts. Keep children at a safe distance.
- When you open the appliance door, hot steam may escape. Open the appliance door with care. Keep children at a safe distance.
- Water in a hot cooking compartment may create hot steam. Never pour water into the hot cooking compartment.

## **Risk of injury!**

Scratched glass in the appliance door may develop into a crack. Do not use a glass scraper, sharp or abrasive cleaning aids or detergents.

## **Risk of electric shock!**

- Incorrect repairs are dangerous. Repairs may only be carried out by one of our trained after-sales engineers. If the appliance is faulty, unplug the mains plug or switch off the fuse in the fuse box. Contact the after-sales service.
- The cable insulation on electrical appliances may melt when touching hot parts of the appliance. Never bring electrical appliance cables into contact with hot parts of the appliance.
- Do not use any high-pressure cleaners or steam cleaners, which can result in an electric shock.
- When replacing the cooking compartment bulb, the bulb socket contacts are live. Before replacing the bulb, unplug the appliance from the mains or switch off the circuit breaker in the fuse box.
- A defective appliance may cause electric shock. Never switch on a defective appliance. Unplug the appliance from the mains or switch off the circuit breaker in the fuse box. Contact the after-sales service.

## **Risk of burns!**

The appliance will become very hot on the outside during the cleaning function. Never touch the appliance door. Allow the appliance to cool down. Keep children at a safe distance.

## **Causes of damage**

### **Caution!**

- Accessories, foil, greaseproof paper or ovenware on the cooking compartment floor: do not place accessories on the cooking compartment floor. Do not cover the cooking compartment floor with any sort of foil or greaseproof paper. Do not place ovenware on the cooking compartment floor if a temperature of over 50 °C has been set. This will cause heat to accumulate. The baking and roasting times will no longer be correct and the enamel will be damaged.
- Water in a hot cooking compartment: do not pour water into the cooking compartment when it is hot. This will cause steam. The temperature change can cause damage to the enamel.
- Moist food: do not store moist food in the cooking compartment when it is closed for prolonged periods This will damage the enamel.
- Fruit juice: when baking particularly juicy fruit pies, do not pack the baking tray too generously. Fruit juice dripping from the baking tray leaves stains that cannot be removed. If possible, use the deeper universal pan.
- Cooling with the appliance door open: only allow the cooking compartment to cool when it is closed. Even if the appliance door is only open a little, front panels of adjacent units could be damaged over time.
- Very dirty door seal: If the door seal is very dirty, the appliance door will no longer close properly when the appliance is in use. The fronts of adjacent units could be damaged. Always keep the door seal clean.
- Appliance door as a seat, shelf or worktop: Do not sit on the appliance door, or place or hang anything on it. Do not place any cookware or accessories on the appliance door.
- Inserting accessories: depending on the appliance model, accessories can scratch the door panel when closing the appliance door. Always insert the accessories into the cooking compartment as far as they will go.
- Carrying the appliance: do not carry or hold the appliance by the door handle. The door handle cannot support the weight of the appliance and could break.

# Your new oven

We will now describe your new oven. This chapter explains the functions of the control panel and its individual elements. Information is also provided about the oven's accessories and internal components.

## Control panel

Below is a general overview of the control panel. The display panel cannot show all the symbols at the same time. Elements may vary according to the model.

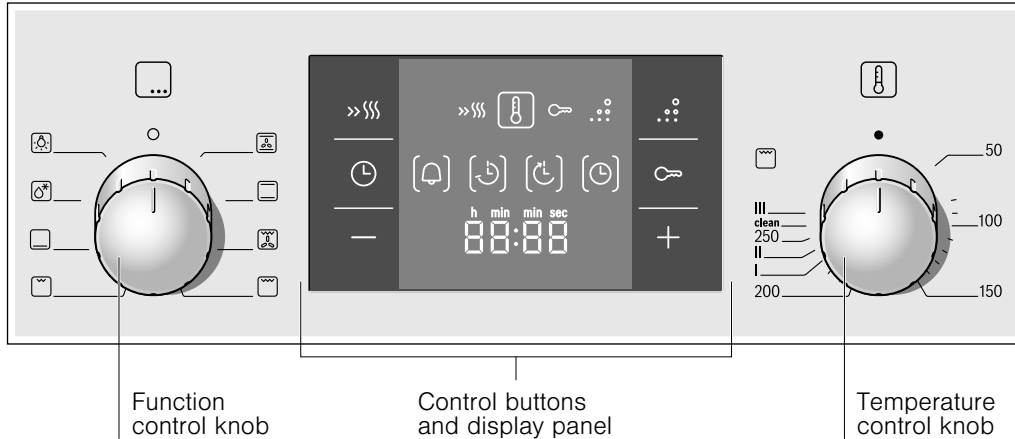

### Retractable control knobs

In some ovens, the control knobs are retractable. The control knob is retracted or returned by pressing it when at the zero setting.

### Buttons

There are sensors under each button. Do not press hard on the buttons. Only press the relevant symbol.

### Function control knob

The function control knob is used to select the type of heating.

Setting	Use
○ Zero setting	The oven is off.
Hot air*	For cakes and pastries. These can be baked on two levels. A fan located on the rear wall of the oven disperses the heat evenly.
Top and bottom heating*	For cakes, gratin dishes, and lean meat roasts, e.g. veal or game, on one level. The heat is provided by the bottom and top heating elements.
Grill with hot air	For roasting joints of meat, poultry and fish. The grill heating element and the fan switch on and off alternately. The fan circulates the heat generated by the grill around the food.
Large surface grill	For grilling steaks, sausages, fish and toasting bread. The entire surface below the grill heating element is heated.
Grill, small surface area	For grilling a small number of steaks or sausages or small amounts of fish, and toasting bread. Only the central area of the grill heating element heats up.

\* Type of heating used to determine the appliance energy efficiency rating according to EN60350.

Setting	Use
Bottom heating	Confits, baking and cooking au gratin. The heat comes from the bottom heating element.
Defrosting	Defrosting, e.g. meat, poultry, bread and cakes. The fan circulates the hot air around the food.
Light	For turning on the oven light.

\* Type of heating used to determine the appliance energy efficiency rating according to EN60350.

Once a type of heating has been selected the oven light is turned on.

### Control buttons and display panel

The buttons are used to set different additional functions. The set values are shown on the display panel.



Button	Use
Rapid heating	Heats the oven particularly quickly.
Cleaning function	Begins the cleaning function to regenerate the self-cleaning surfaces inside the oven.
Time functions	Select the timer , the cooking time , the end time  and the time .
Childproof lock	Blocks and unblocks the control panel.
Minus	Reduces programmed values.
Plus	Increases programmed values.

On the display panel, the brackets [ ] indicate the symbol for the time function selected.

## Temperature control knob

The temperature control knob is used to select the temperature or the grill power level.

Setting	Meaning
● Zero setting	The oven does not heat up.
50-270 Temperature range	The oven's temperature in °C.
I,II and III.	The power levels of the small surface grill ☐ and large surface grill ☐. I = level 1, low II = level 2, medium III = level 3, high
clean	Cleaning function.

When the oven is heating, the  symbol lights up on the display panel. This light goes off when heating is paused. The symbol does not come on with the light function  or the defrost function .

**Note:** If grilling for more than 15 minutes, turn the temperature control knob to the low setting.

## Your accessories

The accessories supplied with your appliance are suitable for making many meals. Ensure that you always insert the accessories into the cooking compartment the right way round.

There is also a selection of optional accessories, with which you can improve on some of your favourite dishes, or simply to make working with your oven more convenient.

### inserting the accessories

The accessories can be placed inside the oven on 5 different levels. Always insert them as far as possible so that the accessories do not touch the door glass.

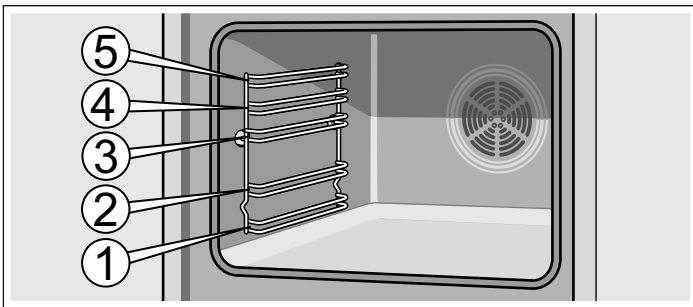

The accessories can be removed halfway until they are secured. This makes it easy to remove food.

When inserting an accessory in the oven, make sure the curvature is at the rear. This is the only way to ensure it fits perfectly.

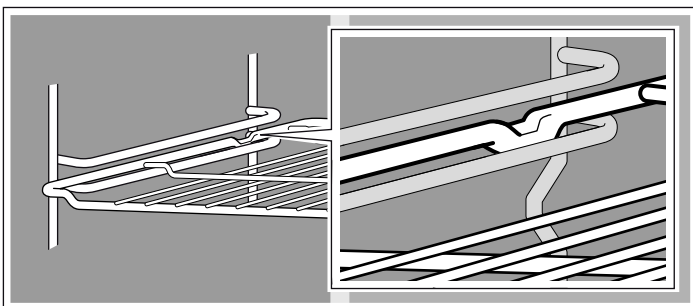

## Inside the oven

There is a light inside the oven. A fan prevents the oven from overheating.

### Fan

The fan can be turned on and off as necessary. The hot air escapes through the top of the door. Warning! Do not cover the vent. The oven could overheat.

The fan remains on for a certain length of time after the oven has been switched off so that it can cool down more quickly.

### Light

The oven light remains on while the oven is working. However, the light can be turned on without the oven being on by setting the function control knob to .

Depending on the equipment, if the appliance has guide rails, these will interlock slightly when fully removed. This means the accessory can be easily inserted. To unlock, reinsert the guide rails in the oven exerting slight pressure.

**Note:** Accessories may deform as they heat up. This deformation will disappear when they cool. This does not affect the normal operation.

Your oven does not have all of the accessories listed below.

You can buy accessories from the after-sales service, from specialist retailers or online.



#### Flat enamel oven tray

For cakes, pastries and biscuits.

Place the tray in the oven with its raised lip facing the door.

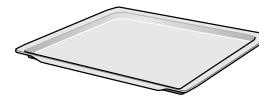

#### Aluminium baking tray

for baking tray bakes and small baked products



#### Flat enamel oven tray

For cakes, pastries and biscuits.

Place the tray in the oven with its raised lip facing the door.



#### Universal deep enamel tray

For juicy cakes, pastries, frozen meals and large joints for roasting. This can also be used as a tray to collect the fat when roasting directly on the wire shelf.

Place the tray in the oven with its raised lip facing the door.

**Note:** Do not place food directly onto the aluminium baking tray. Line the aluminium baking tray with greaseproof paper.

## Optional accessories

You can purchase optional accessories from the after-sales service or specialist retailers. You will find a comprehensive range of products for your oven in our brochures and online. The availability of optional accessories and whether it is possible to order them online may vary depending on your country. Please see the sales brochures for more details.

Not all optional accessories are suitable for every appliance. When purchasing, please always quote the exact designation (E no.) of your appliance.

Optional accessories	HEZ number	Use
Flat enamelled baking tray	HEZ361000	For cakes and biscuits.
Deep enamelled universal pan	HEZ362000	For moist cakes, pastries, frozen meals and large joints. It can also be used to catch dripping fat when you are grilling directly on the wire rack.
Wire rack	HEZ364000	For ovenware, cake tins, roasts, grilled items and frozen meals.
Pizza tray	HEZ317000	Ideal for pizza, frozen products or large, round cakes. You can use the pizza tray instead of the deep universal pan. Place the tray on the wire rack and refer to the specifications in the tables.
Glass roasting dish	HEZ915001	The glass roasting dish is suitable for stews and bakes that are cooked in the oven. Particularly suitable for the automatic programmes and automatic roasting.
Telescopic shelf x3	HEZ368301	The pull-out rails at levels 1, 2 and 3 allow you to pull the accessories out further without them tipping.

## Before using the oven for the first time

In this section, you can find out what you must do before using your oven to prepare food for the first time. First read the section on *Safety information*.

### Setting the time

Once the oven has been connected, the  symbol and four zeros are shown flashing on the display panel. Set the time.

1. Press the  button.

The display shows the time **12:00**.

2. Set the time with the buttons **+** or **-**.

The programmed time is displayed after a few seconds.

### Heating the oven

To remove the "new" smell, heat the oven empty with the door closed. The most effective option is to heat the oven for one hour with the top and bottom heating elements  set at 240 °C. Check that no packaging has been left inside the oven.

1. Select top and bottom heating  using the function control knob.

2. Select 240 °C with the temperature control knob.

Turn the oven off after one hour. To do this, turn the function control knob to zero.

### Cleaning the accessories

Before using the accessories for the first time, clean them thoroughly using a cloth, hot water and a little soap.

# Programming the oven

There are different ways to programme the oven. Programming the type of heating, temperature or grill power. The oven can be programmed with the cooking time (duration) and the end time for each dish. For more information, see the chapter *Setting the time functions*.

## Type of heating and temperature

Example in the picture: top and bottom heat  at 190 °C.

1. Select the type of heating using the function control knob.

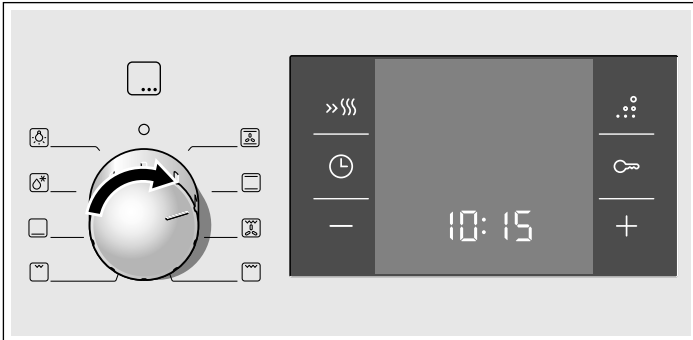

2. Select the temperature or grill power level with the temperature control knob.

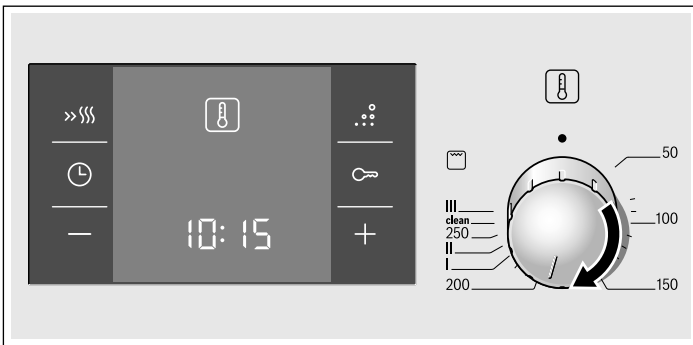

The oven will begin to heat up.

## Switching off the oven

Turn the function selector to the off position.



## Changing the settings

The type of heating and temperature or grill setting can be changed at any time using their respective selectors.

## Rapid heating

With the rapid heating function, the oven reaches the programmed temperature very quickly.

Rapid heating must be used for temperatures of more than 100 °C. Suitable types of heating:

- Hot air 
- Top and bottom heating 
- Bottom heating 

To ensure uniform cooking, the food must not be put into the oven until rapid heating has been completed.

1. Select the temperature and type of heating required.
2. Briefly press the >>||| button.

The display panel shows the >>||| symbol. The oven will begin to heat up.

## End of rapid heating

A beep will sound. The >>||| symbol disappears from the display panel. Put the food in the oven.

## Cancelling rapid heating

Press the >>||| button. The >>||| symbol disappears from the display panel.

# Setting the time functions

This oven has various time functions. The  sensor activates the menu and moves through the different functions. The time symbols remain lit up while settings are programmed. The square brackets [ ] indicate the time function selected. You can modify an already programmed time function directly with the sensors + or -, provided the time symbol is situated between square brackets [ ].

## Timer

The timer works independently of the oven. The timer has its own beep. This can be used to distinguish whether the time set for the timer or the automatic oven shut-off have finished (cooking time).

1. Press the button once .

The time symbols light up on the display panel, the square brackets are next to .

2. Set the timer using the + or - buttons.

Value suggested for the + button = 10 minutes.

Value suggested for the - button = 5 minutes.

The programmed time is shown after a few seconds. The time set for the timer starts to count down. The symbol [  ] lights up on the display panel and the timer's progress is shown. The other time symbols switch off.

## The time set for the timer has elapsed

A beep will sound. The display panel will show 00:00. Switch off the timer using the .

## Changing the time on the timer.





Change the time set for the timer using the + or - buttons. The new time is shown after a few seconds.

## Cancelling the timer

Resetting the timer to 00:00 with the button -. The new time is shown after a few seconds. The timer switches off.

## Viewing the time settings

If several time functions are programmed, the corresponding symbols light up on the display panel. The symbol for the time function in the foreground is in brackets.

To view the timer , the cooking time , the end time  or the actual time , press the  sensor repeatedly until the brackets are around the required symbol. The corresponding value will be shown for a few seconds on the display panel.



## Cooking time

The oven allows you to set the cooking time for each type of food. The oven switches off automatically when the cooking time has finished. This avoids interrupting other tasks to switch the oven off or exceeding the cooking time by mistake.

Example in the picture: cooking time: 45 minutes.

1. Select the type of heating using the function control knob.
2. Select the temperature or grill power level with the temperature control knob.
3. Press the  button twice.

The display panel will show **00:00**. The time symbols light up, the square brackets are next to .

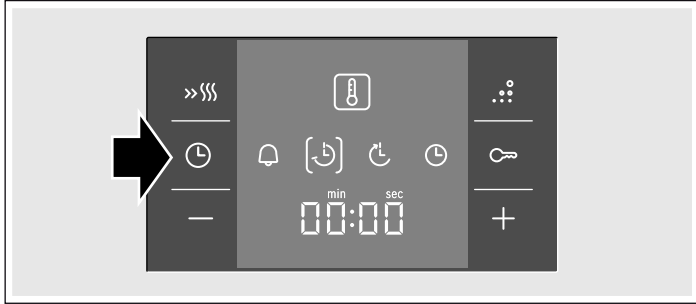

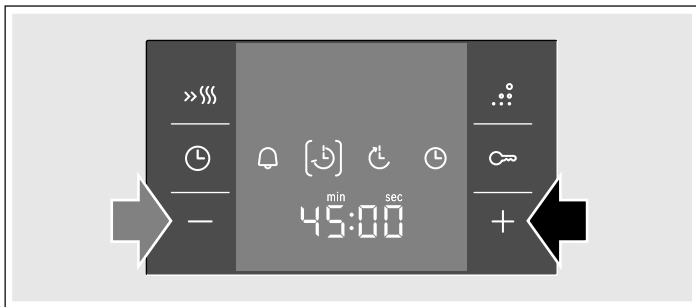

4. Set the cooking time with the **+** or **-** buttons.  
Value suggested for the **+** button = 30 minutes.  
Value suggested for the **-** button = 10 minutes.



The oven will switch on after a few seconds. The display panel shows the cooking time elapsed and the  symbol comes on. The other time symbols switch off.

### The cooking time has finished

A beep will sound. The oven will stop heating. The display panel will show **00:00**. Press the  button. Programme a new cooking time with the **+** or **-** buttons. Or press the  button twice and turn the function control knob to the zero setting. The oven is off.

### Changing the cooking time





Change the cooking time with the **+** or **-** buttons. The new time is shown after a few seconds. If the timer has been programmed, first press the  button.

### Cancelling the cooking time

Reset the cooking time to **00:00** with the button **-**. The new time is shown after a few seconds. The time has been cancelled. If the timer has been programmed, first press the  button.

### Viewing the time settings

If several time functions are programmed, the corresponding symbols light up on the display panel. The symbol for the time function in the foreground is in brackets.



To view the timer , the cooking time , the end time  or the actual time , press the  sensor repeatedly until the brackets are around the required symbol. The corresponding value will be shown for a few seconds on the display panel.

## End time

The oven allows you to set the time when you want the food ready. The oven switches on automatically and switches off at the set time. E.g. the food may be placed in the oven in the morning and the oven set so that it is ready at midday.

Ensure that the food will not go off if it is in the oven for too long.

Example in the picture: It is now 10:30 AM, the cooking time is 45 minutes and the oven should switch off at 12:30 PM.



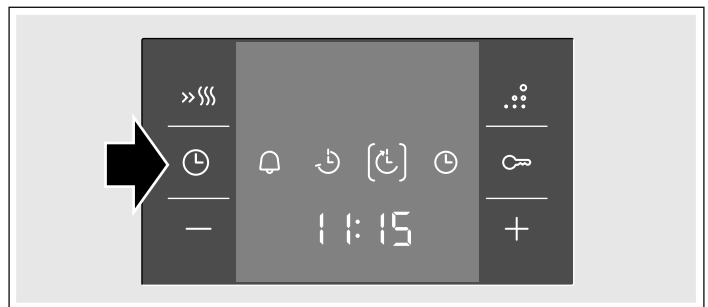

1. Set the function control knob.
2. Set the temperature control knob.
3. Press the  button twice.
4. Set the cooking time with the **+** or **-** buttons.
5. Press the .

The brackets are shown next to . The time the dish will be ready is displayed.

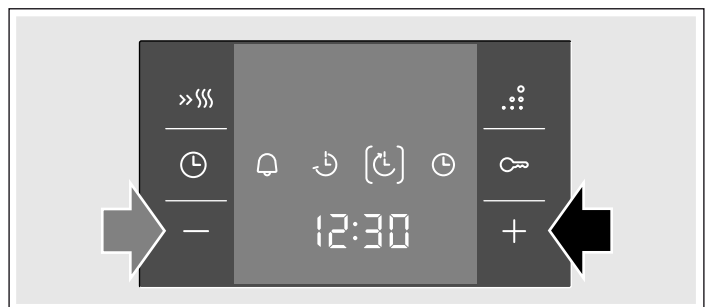



6. Delay the end time using the **+** or **-** buttons.



The oven displays the programmed time after a few seconds and is set to standby. The time when the dish will be ready is displayed and the end time  symbol will be shown in square brackets. The symbols  and  turn off. When the oven is turned on, cooking time progress is shown and the symbol  appears in square brackets. The symbol  is turned off.

### The cooking time has finished

A beep will sound. The oven will stop heating. The display panel will show **00:00**. Press the  button. Programme a new cooking time with the **+** or **-** buttons. Or press the  button twice and turn the function control knob to the zero setting. The oven is off.

### Changing the end time





Change the end time using the buttons **+** or **-**. The new time is shown after a few seconds. If the timer has been programmed, first press the  button twice. Do not change the end time if the cooking time has already started to count down. The final result may not be the same.

### Cancelling the end time

Reset the end time to the current time by pressing **-**. The new time is shown after a few seconds. The oven switches on. If the timer has been programmed, first press the  button twice.

## Viewing the time settings

If several time functions are programmed, the corresponding symbols light up on the display panel. The symbol for the time function in the foreground is in brackets.

To view the timer , the cooking time , the end time  or the actual time , press the  sensor repeatedly until the brackets are around the required symbol. The corresponding value will be shown for a few seconds on the display panel.

## Time

Once the oven has been connected or after a power cut, a flashing  symbol and four zeros are shown on the display panel. Set the time.

1. Press the  button.

The display panel displays the time **12.00**.

2. Set the time with the buttons **+** or **-**.

The programmed time is displayed after a few seconds.

## Changing the time

No other time function can be programmed.

1. Press the  button four times.

The time symbols light up on the display panel, the brackets are located next to .

2. Adjust the time with the buttons **+** or **-**.

The programmed time is displayed after a few seconds.

## Hiding the clock

You can hide the clock. For more information, please refer to the section *Changing the basic settings*.

---

# Childproof lock

The oven includes a childproof lock to prevent it being turned on accidentally.

The oven does not react to any setting. The timer and time can be programmed when the childproof lock is on.

When the heating type and temperature or grill level are programmed, the childproof lock turns off the heating.

### Activating the childproof lock

No cooking time or end time should already be set.

Press the  button for approximately four seconds.

The display panel shows the symbol . The childproof lock is now activated.

### Turning off the childproof lock







Press the  button for approximately four seconds.

The  symbol in the display panel goes off. The childproof lock is now deactivated.

---

# Changing the basic settings



This oven has different basic settings. The settings can be adapted to the user's own needs.

Basic settings	Selection 	Selection 	Selection 
 Time indicator	always*	only with the button 	-
 Duration of signal after the cooking time or the time set on the timer has elapsed	approx. 10 sec	approx. 2 min.*	approx. 5 min
 Time until a setting is applied	approx. 2 sec	approx. 5 sec.*	approx. 10 sec.

\* Default setting

No other time function can be programmed.

1. Press the  button for approximately 4 seconds.

The display panel will show the current basic setting for the time, e.g.  for the Selection .

2. Set the basic setting using the buttons **+** or **-**.

3. Confirm with the  button.

The display panel shows the following basic setting. Using the button  select the levels and using the buttons **+** or **-** make the setting.

4. Press the  button for approximately 4 seconds.

All basic settings have been applied.

The basic settings can be changed again at any time.

# Cleaning function

The cleaning function regenerates the self-cleaning surfaces inside the oven.

The inside rear and side walls and ceiling of some ovens may be lined with a highly porous ceramic lining. This lining absorbs splashes produced during baking and roasting, dissolving them while the oven is on. This cleaning system makes it possible to regenerate self-cleaning surfaces that can not properly clean themselves.

## Before cleaning

Remove all pans and unsuitable accessories from inside the oven.



### Cleaning the oven's base and enamelled walls





Before programming the clean function, clean the surfaces inside the oven that are not self-cleaning. Otherwise, stains will appear that are impossible to remove.

Use a cleaning cloth and hot water with a little soap or vinegar. If very dirty, use a fine steel scourer or a special oven cleaning product. These must only be used when the oven interior is cold. Do not use metal scourers or special oven cleaning products on self-cleaning surfaces.

## Setting

Cleaning takes approximately one hour.

1. Turn the control knob to Hot Air .
2. Turn the temperature knob to **clean**.
3. Press the .

The display panel shows the  symbol. Displays the time cleaning finishes, and the  symbol appears between brackets. Self-cleaning starts within a few seconds. The cleaning time is displayed and the  symbol appears between brackets. The  symbol switches off.

### The cleaning has finished

A beep will sound. The oven will stop heating. The display panel will show **00:00**. Press the  button twice and turn the function control knob to position **0**. The oven switches off.



### To cancel cleaning

Press the  button and turn the function control knob to the **0** setting. The oven switches off.

### Delaying the end time

The time at which cleaning finishes can be changed. Thus, for example, the oven can be cleaned at night leaving it free for use during the day.

Program as described in point 1 to 3. Before cleaning is finished, delay the end time using the **+** or **-** buttons.

The oven is set to standby. The time when the cleaning will be finished is displayed and the  symbol will be shown in square brackets. When cleaning begins, the time is displayed and the  symbol appears between square brackets. The  symbol switches off.

## After cleaning

Once the inside of the oven has cooled, clean the ash remains from the self-cleaning surfaces using a damp cloth.

# Care and cleaning

If cleaned and properly cared for, your oven will keep its bright appearance and operating performance for many years to come. Advice on how to care for and clean your oven is provided below.

## Notes

- Different colours may be seen in your front panel due to the various materials used in its manufacture, such as glass, plastic and metal.
- Dark patches in the door's glass panel may seem to be dirt but they are in fact reflections from the oven light.
- Enamel burns at very high temperatures. This may cause slight discolouration. This is normal and does not affect the oven's operation. The edges of thin baking trays may not be completely enamelled. They may therefore feel slightly rough, although their corrosive protection will be unaffected.

## Cleaning products

Follow the indications provided in the table to avoid damaging the various oven surfaces by using unsuitable cleaning products. Do not use

- abrasive or acidic cleaning products
- strong products containing alcohol
- scourers or hard sponges
- high-pressure or steam cleaners

Wash new dishcloths thoroughly before use.

Zone	Cleaning products
Front panel	Hot water and a little soap: Clean with a dishcloth and dry with a soft cloth. Do not use a glass cleaning product or a glass scraper.
Stainless steel	Hot water and a little soap: Clean with a dishcloth and dry with a soft cloth. Immediately remove any water marks, grease, cornflower or egg white stains since corrosion could occur underneath these marks or stains.  Special products for the care of stainless steel and which are suitable for hot surfaces may be obtained from Technical Assistance Service centres and specialist retail outlets. Use a very fine soft cloth to apply the cleaning product.
Glass panel	Glass cleaning products: Clean using a soft cloth. Do not use a glass scraper.
Display	Glass cleaning products: Clean using a soft cloth. Do not use alcohol, vinegar or other abrasive or acidic cleaning products.
Glass panels on oven door	Glass cleaning products: Clean using a soft cloth. Do not use a glass scraper.

Zone	Cleaning products
Glass cover for the oven light	Hot water and a little soap: Clean with a dishcloth.
The seal Do not remove!	Hot water and a little soap: Clean with a dishcloth. Do not rub.
Wire shelves or rails	Hot water and a little soap: Soak and clean using a dishcloth or brush.
Sliding guides	Hot water and a little soap: Clean with a dishcloth or a brush. Do not leave this to soak or wash in a dishwasher.
Accessories	Hot water and a little soap: Soak and clean using a dishcloth or brush.

### Cleaning the self cleaning surfaces in the oven interior

The inside rear and side walls and ceiling of some ovens may be lined with a highly porous ceramic lining. This lining absorbs splashes produced during baking and roasting, dissolving them while the oven is on. This cleaning will be most effective at higher temperatures and during longer cooking times.

The cleaning system makes it possible to regenerate self-cleaning surfaces that can not properly clean themselves. See the chapter on *Self-cleaning*.

Slight discolouration of the lining does not affect its self-cleaning performance.

### Caution!

- Do not use abrasive cleaning products. These would scratch and impair the highly porous lining.
- Never use oven cleaning products on ceramics. If oven cleaner is spilled on this accidentally, immediately remove it using lots of water and a sponge.

### Cleaning the oven's enamelled bottom and walls

Use a cleaning cloth and hot water with a little soap or vinegar.

If very dirty, use a fine steel scourer or a special oven cleaning product. These must only be used when the oven interior is cold. Do not use metal scourers or special oven cleaning products on self-cleaning surfaces.

## Light

The oven light can be turned on manually to facilitate cleaning.

### Turning on the oven light

Turn the function control knob to the  position.

The light will come on. The temperature control knob must be turned off.

### Turning the oven light off

Turn the function control knob to the o position.

## Removing the grill heating element

The grill heating element can be removed in some ovens to facilitate cleaning.

### ⚠ Risk of burns!

The oven must be cold.

1. Pull the grill element handle towards you and push it upwards until you hear it click into position (figure A).
2. At the same time, hold the grill element and swing it down (figure B).

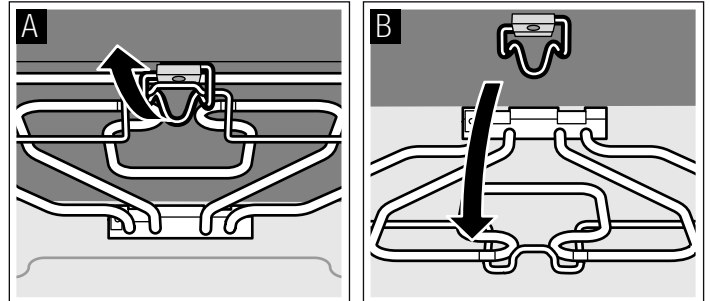

After cleaning, push the grill heating element up again. Push the locking handle down and secure the grill element.

## Removing and refitting the wire shelves or left and right hand side rails

The wire shelves or left and right hand side rails can be removed for cleaning. The oven must be cold.

### Release the guides or rails

1. Lift the front of the guide or rail and release it (figure A).
2. Then pull the guide or rail forwards completely and remove it (figure B).

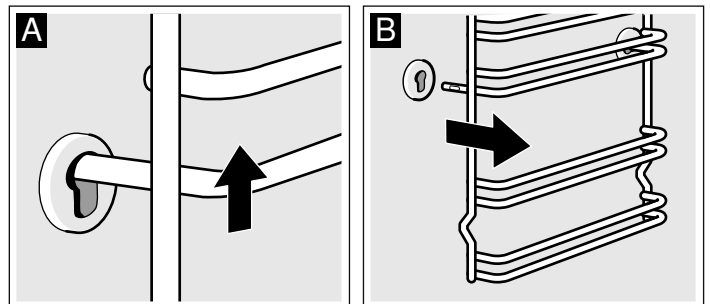

Clean the guides or rails with detergents and a sponge. The use of a brush is recommended for stubborn stains.

### Install the wire shelves or rails

1. First insert the shelf or the rail in the rear groove by pushing it back slightly (figure A)
2. then insert it in the front groove (figure B).

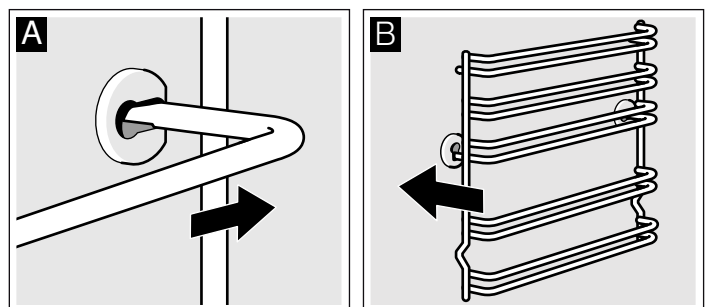

Wire shelves or rails can be adjusted on the left and right hand side. Their curvature should always be face down.

## Unhooking and hanging the oven door

The front panel can be unhooked to help remove the oven door and clean the glass panels.

The oven door hinges are fitted with a locking lever. The door cannot be unhooked if the locking lever is closed (figure A). Once the locking lever has been opened to unhook the door (figure B), the hinges will be locked in position. This prevents the door from suddenly closing.

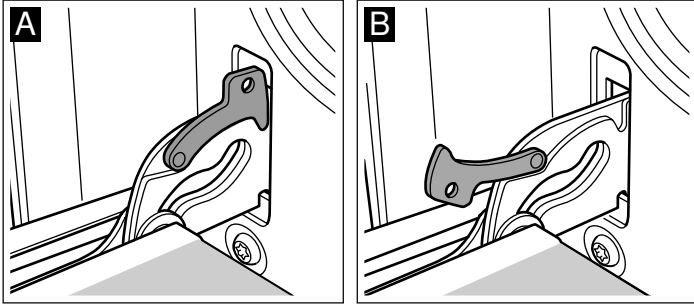

### ⚠ Risk of injuries.!

The hinges may close suddenly if they are not locked in position by the lever. Note that the locking levers are always closed, apart from when unhooking the door, when the levers must be open.

### Unhooking the door

1. Fully open the oven door.
2. Remove both locking levers located on the right and left hand sides (figure A).
3. Fully close the oven door as far as possible (figure B). Grip the left and right hand sides of the door with both hands. Close the door slightly more and remove it.

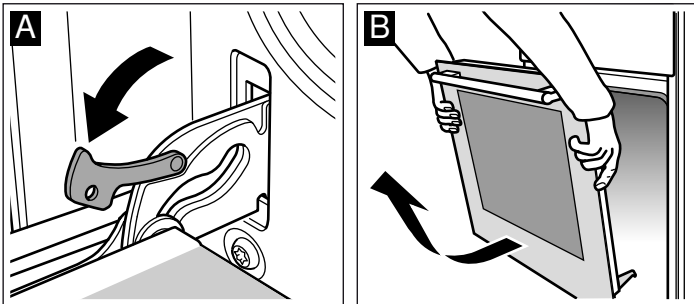

### Hanging the door

Rehang the door by following the same steps but in reverse order.

1. When refitting the door, check that both hinges are positioned exactly inside their respective openings (picture A).
2. The bottom groove of the hinges must fit snugly on both sides.

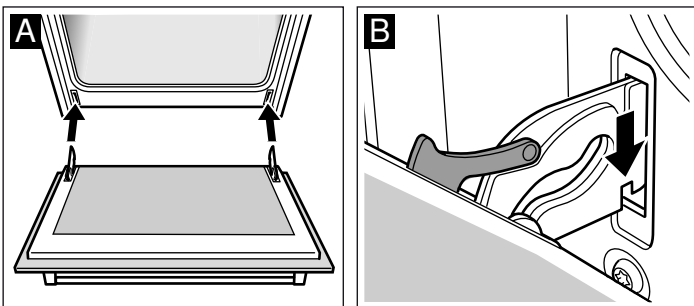

The door may be left crooked if the hinges are not mounted properly.

3. Reclose the attachment levers (picture C). Close the oven door.

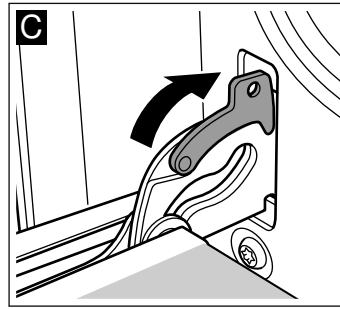

### ⚠ Risk of injuries.!

Do not touch the hinges; the door might accidentally fall or a hinge might suddenly close. Notify the Technical Assistance Service.

## Removing and installing the door panels

To facilitate cleaning, you can remove the glass panels from the oven door.

### Dismantling

1. Unhook the oven door and place it on a cloth with its handle pointing downwards.
2. Remove the upper cover from the oven door. To do this, press with your fingers on the tabs on the left and right (Figure A).
3. Lift and remove the top glass panel (Figure B).

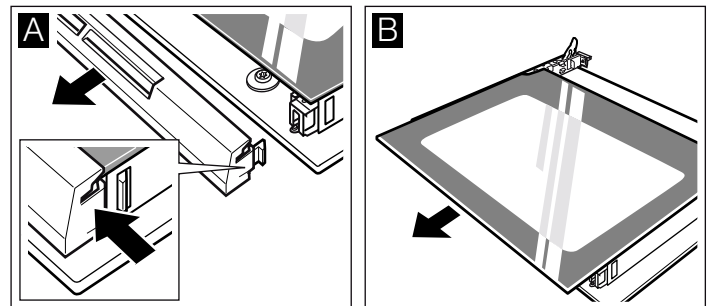

In doors with three glass panels, the following step will also be necessary:

4. Lift and remove the glass panel (Figure C).

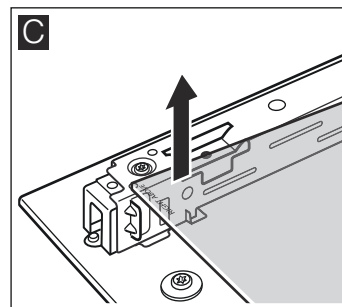

Clean the glass panels using a glass cleaning product and a soft cloth.

Do not use abrasive or corrosive cleaning products, glass scrapers or hard metal scourers as these could damage the glass.

### ⚠ Risk of injury!

Scratched glass in the appliance door may develop into a crack. Do not use a glass scraper, sharp or abrasive cleaning aids or detergents.

## Installing

Follow steps 2 to 4 with doors that have two glass panels.

When installing, ensure that the "right above" inscription on the lower left part is inverted.

1. Insert the glass panel by tilting it backwards (Figure A).
2. Insert the upper glass panel on both mounts by tilting it backwards. Ensure that its smooth surface is facing outwards. (Figure B)

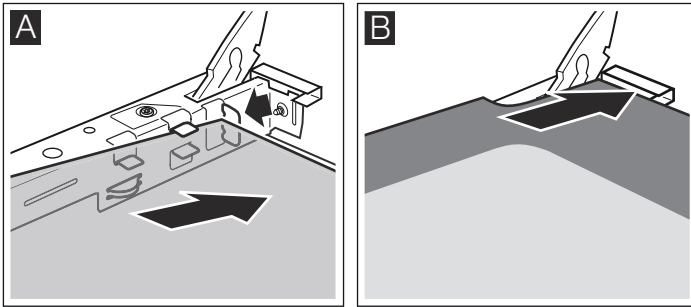

3. Fit and tighten the cover.

4. Refit the oven door.

**Once the glass panels have been correctly fitted, the oven is ready to use.**

## Troubleshooting

Quite often, when there is a malfunction, it is usually a small irregularity which is easy to rectify. Before contacting the Technical Assistance Service, try to determine the cause of the fault using the following table.

### Troubleshooting table

Fault	Possible cause	Solution/advice
The oven does not work.	The fuse has blown.	Check the state of the fuse in the fuse box.
	Power cut.	Check that the light in the kitchen and other household appliances are working.
The display panel shows a flashing $\ominus$ symbol and four zeros.	Power cut.	Set the time once again.
The oven does not heat up.	There is dust on the contacts.	Turn the control knobs several times in both directions.

### Error messages

When the display panel shows an error message with  $\text{E}$ , press the  $\ominus$  button. The message will disappear. The set time function will be deleted. If the error message does not disappear, call the Technical Assistance Service.

The following error messages can be solved by the user.

Error message	Possible cause	Solution/advice
$\text{E011}$	A button has been pressed for too long or has got stuck.	Press all of the buttons one by one. Check if any button is stuck, covered or dirty.

### **⚠ Risk of electric shock.!**

Incorrect repairs can be dangerous. Repairs may only be carried out by qualified personnel from the Technical Assistance Service.

### Changing the oven bulb

If the oven light bulb is damaged it must be replaced. Special 25 W, E14, 220 V-240 V heat-resistant light bulbs (to 300 °C temperature) can be obtained from the Technical Support Service or in specialist shops. Only use this type of bulb.

#### **⚠ Risk of electrical discharge and the resulting shock.!**

Disconnect the appliance from the mains. Ensure that this is turned off.

1. Place a dishcloth into the cold oven to avoid damage.
2. Remove the glass protection by unscrewing it to the left.

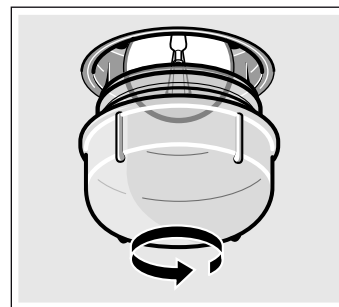

3. Replace the bulb with a similar bulb.
4. Screw the protection glass back into place.
5. Remove the dishcloth and switch the oven back on at the mains.

### Protective glass panels

Damaged protective glass panels must be replaced. Protective glass panels can be obtained from the Technical Assistance Service. Please quote your appliance's product number and production number.

## After-sales service

Our after-sales service is there for you if your appliance needs to be repaired. We will always find the right solution in order to avoid unnecessary visits from a service technician.

### E number and FD number

When calling us, please give the product number (E no.) and the production number (FD no.) so that we can provide you with the correct advice. The rating plate containing these numbers can be found on the right-hand side of the oven door. You can make a note of the numbers of your appliance and the telephone number of the after-sales service in the space below to save time should it be required.

E no.	FD no.
-------	--------

### After-sales service

Please note that there will be a fee for a visit by a service technician in the event of a malfunction, even during the warranty period.

Please find the contact data of all countries in the enclosed customer service list.

#### To book an engineer visit and product advice

**GB** 0344 892 8979

Calls charged at local or mobile rate.

**IE** 01450 2655

0.03 € per minute at peak. Off peak 0.0088 € per minute.

Rely on the professionalism of the manufacturer. You can therefore be sure that the repair is carried out by trained service technicians who carry original spare parts for your appliances.

## Energy and environment tips

Here you can find tips on how to save energy when baking and roasting and how to dispose of your appliance properly.

### Saving energy

- Preheat the oven only if this is required by a recipe or is indicated in the tables.
- Use dark, lacquered or black enamel baking tins. These are more efficient at absorbing heat.
- Keep the oven door closed during cooking, baking and roasting cycles.
- When baking several cakes, these should be preferably baked one after the other. The oven will still be hot, thereby reducing the cooking time for the second cake. Two rectangular baking tins can be placed side-by-side.

- For long cooking times, the oven may be turned off 10 minutes prior to the specified time, allowing the item to continue to cook but taking advantage of the oven's residual heat.

### Environmentally-friendly disposal

Dispose of packaging in an environmentally-friendly manner.



This appliance is labelled in accordance with European Directive 2012/19/EU concerning used electrical and electronic appliances (waste electrical and electronic equipment - WEEE). The guideline determines the framework for the return and recycling of used appliances as applicable throughout the EU.

## Tested for you in our cooking studio

Here you will find a selection of dishes and the ideal settings for them. We will show you which type of heating and which temperature are best suited for your dish. You can find information about suitable accessories and the height at which they should be inserted. There are also tips about cookware and preparation methods.

### Notes

- The values in the table always apply to dishes placed into the cooking compartment when it is cold and empty.  
Only preheat the appliance if the table specifies that you should do so. Do not line the accessories with greaseproof paper until after they have been preheated.
- The times specified in the tables are guidelines only. They will depend on the quality and composition of the food.
- Use the accessories supplied. Additional accessories may be obtained as special accessories from specialist retailers or from the after-sales service.  
Before using the oven, remove any unnecessary accessories and ovenware from the cooking compartment.
- Always use oven gloves when taking hot accessories or ovenware out of the cooking compartment.

### Cakes and pastries

#### Baking on one level

The best results are obtained with the upper and lower heat  when baking cakes.

When baking using the hot air function , the following levels are recommended for the accessories:

- Cakes in moulds: level 2
- Cakes on the tray: level 3

#### Baking at different levels

Using the hot air mode .

Baking on two levels:

- Enamel baking tray: level 3
- Aluminium tray: level 1

Trays put in the oven at the same time are not necessarily ready at the same time.

The tables contain a number of tips for each dish.

If 3 rectangular moulds are used at the same time, place on the shelf as shown in the picture.

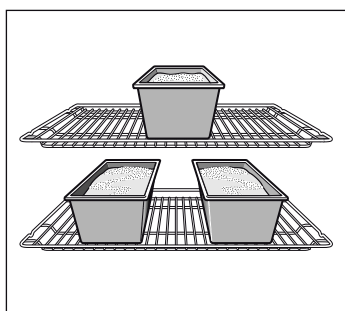

**Note:** Do not place food directly onto the aluminium baking tray. Line the aluminium baking tray with greaseproof paper.

### Baking tins

It is best to use dark-coloured metal baking tins.

Baking times are increased when light-coloured baking tins made of thin metal or glass dishes are used, and cakes do not brown so evenly.

If you wish to use silicone baking tins, use the information and recipes provided by the manufacturer as a guide. Silicone baking tins are often smaller than normal tins. The amount of mixture and recipe instructions may differ.

### Tables

The table shows the optimum heating methods for each type of cake or dessert. The temperature and cooking time will depend on the amount and the consistency of the dough. For this reason the cooking tables always provide approximate cooking times. Always begin by trying the lowest value. The items will be more evenly browned at a lower temperature. If necessary, this can be increased next time.

If the oven is preheated, cooking times are reduced by 5 to 10 minutes.

*Additional information is provided in the Tips for baking section as an appendix to the tables.*

To bake a cake only on one level, place the mould on the enamel tray.

When baking several cakes at the same time, the moulds can be placed together on the wire shelf.

Cake in the baking tin	Tin on the wire rack	Level	Type of heating	Temperature in °C	Baking time in minutes
Tart	Tin-plated tart tin, diameter 31 cm.	1		220-240	40-50
		1+3		190-200	35-45
Quiche	Tin-plated tart tin, diameter 31 cm.	1		220-230	40-50
Cakes*	Tin-plated cake tin, diameter 28 cm.	2		180-200	50-60
Sponge cake, easy	Ring tin/loaf tin	2		160-180	55-70
	3 loaf tins	3+1		140-160	70-90

\* To bake several cakes at the same time, place several baking tins on the wire rack.









Cakes baked on a tray	Level	Type of heating	Temperature in °C	Cooking time, minutes	
Pizzas	Oven tray	2		200-220	25-35
	Aluminium tray + flat oven tray	1+3		170-180	35-45
	Aluminium tray + universal deep tray	1+3		170-180	35-45
Puff pastry	Oven tray	3		180-200	25-35
	Aluminium tray + flat oven tray	1+3		170-190	30-45
	Aluminium tray + universal deep tray	1+3		170-190	30-45
Börek	Universal tray	2		190-200	40-55

Additional baking trays can be obtained from a specialist retail outlet or from the Technical Assistance Service.

Bread and rolls	Level	Type of heating	Temperature in °C	Cooking time, minutes	
Yeast bread made using 1.2 kg of flour* (with preheating)	Enamel baking tray	2		270	8
				200	35-45
Bread made from yeast-containing dough containing 1.2 kg of flour* (with preheating)	Enamel baking tray	2		270	8
				200	40-50
Rolls (e.g. made from rye)	Enamel baking tray	3		200-220	20-20



\* Never pour water directly into a hot oven.



Pastries		Level	Type of heating	Temperature in °C	Cooking time, minutes
Pastries and biscuits	Enamel baking tray	3		150-160	20-30
	Aluminium tray + flat oven tray	1+3		140-150	20-30
	Aluminium tray + universal deep tray	1+3		140-150	20-30
Meringues	Enamel baking tray	3		80-90	180-210
Empty puffs	Enamel baking tray	2		190-210	30-40
Macaroons	Enamel baking tray	3		110-130	30-40
	Aluminium tray + flat oven tray	1+3		100-120	35-45
	Aluminium tray + universal deep tray	1+3		100-120	35-45

Extra baking trays may be obtained as optional accessories from specialist retail outlets.

## Practical cooking tips and suggestions

If you want to use your own recipe.	You can use a similar one to that listed in the cooking table.
How to check whether your sponge cake is ready.	Ten minutes before the end of the cooking time indicated in the recipe, test the thickest part of the cake with a thin wooden skewer. The cake is ready when the skewer comes out clean, with no traces of cake mix left on the skewer.
The cake is too flat.	Next time, try using less liquid or reduce the oven temperature by 10 degrees. Ensure you mix the batter according to the times given in the recipe.
The cake has a peaked centre, but the edges have shrunk.	Do not grease the tin. Once the cake is ready, use a knife to carefully remove it from the tin.
If the cake is too brown on top.	Position the cake lower in the oven, reduce the oven temperature and bake it for longer.
The cake is too dry.	Use a skewer to make small holes in the finished cake. Pour a few drops of fruit juice or alcohol over the cake. Next time, increase the oven temperature by 10 degrees and reduce the cooking time.
The bread or cake (fruit cake, for example) looks fine on the outside but still has soft (soggy) areas inside.	Next time, use less liquid and leave the product for a little longer in the oven, at a lower temperature. The bases of cakes with juicy toppings should be baked first on their own. Then sprinkle chopped almonds or breadcrumbs on the base before adding the topping. Follow the recipe and observe the cooking times.
Biscuits are not evenly browned.	Select a lower temperature; the biscuits will be browned more uniformly. Bake more delicate pastries with top and bottom heating  on one level. Overhanging greaseproof paper may also affect air circulation. Always trim it to fit the baking tray.
Fruit cake is uncooked at the bottom.	Next time, put the cake on a lower level.
Juice from the fruit oozes out.	Next time, use the universal tray if available.
Small pastries made with yeast may stick together during baking.	Leave a space of about 2 cm between them. Then they will have enough space to rise and brown on all sides.
Products have been baked on different levels. Biscuits on the upper tray are darker than those on the lower tray.	Always use the hot air  function when baking products on different levels. Although several baking trays may be placed in the oven at the same time, this does not mean that they will necessarily all be ready at the same time.
Baking moist cakes produces condensation.	Condensation may form when baking. Some of this moisture may evaporate via the door handle, and drops of condensation may form on the control panel or on the front of nearby kitchen units. The oven is physically designed with this in mind.

## Meat, poultry, fish

### Cookware

Any heatproof cookware can be used. For large roasts, the enamel tray can also be used.

It is best to use glass containers. Check that the lid of the cookware will fit and close properly.

If using enamel containers, add more liquid.

When using stainless steel pans, the meat does not brown well and may even be left rare. If so, lengthen the cooking time.

Data shown in tables:

Uncovered cookware = open

Covered cookware = closed

Always place cookware in the centre of the wire shelf.

Hot glass cookware should be placed on a dry dishcloth. The glass could shatter if rested on a wet or cold surface.

### Roasting

Add in a little liquid if the meat is lean. Cover the base of the ovenware with approx. ½ cm of liquid.

Add liquid generously for pot roasts. Cover the base of the ovenware with approx. 1 - 2 cm of liquid.

The amount of liquid depends on the type of meat and the material the ovenware is made of. If preparing meat in an enamelled roasting dish, it will need a little more liquid than if cooked in glass ovenware.

Roasting dishes made from stainless steel are not ideal. The meat cooks more slowly and browns less fully. Use a higher temperature and/or a longer cooking time.

## Grilling

Always use the grill with the oven closed.

For grilling, preheat the oven for about 3 minutes before the food is placed inside the oven.

Place the pieces directly on the wire shelf. If only one piece is prepared, it is best if placed in the centre of the wire shelf.

Place the enamel tray at level 1. The tray will help keep the oven clean by catching any meat juices.

Do not place the baking tray or universal tray at level 4 or 5. Due to the extreme heat, it could be deformed and cause damage to the oven interior when it is removed.

In so far as it is possible, use pieces of the same thickness. This will help them brown evenly and remain juicy. Salt the fillets after grilling.

Turn the pieces after  $\frac{2}{3}$  the time has elapsed.

The grill resistance switches on and off automatically. This is normal. The frequency depends on the chosen power level.

## Meat

Turn pieces of meat halfway through the cooking time.

When the roast is ready, turn off the oven and allow it to rest for an additional 10 minutes. This allows better distribution of the meat juices.

After cooking, wrap sirloin in aluminium foil and leave it to rest for 10 minutes in the oven.

For roast pork with a rind, score the rind in a crossways pattern, then lay the roast in the dish with the rind at the bottom.

Meat	Weight	Cookware	Level	Type of heating	Temperature at °C, grill power	Cooking time, minutes
Beef stew (e. g. ribs)	1.0 kg	covered	2		220-240	90
	1.5 kg		2		210-230	110
	2.0 kg		2		200-220	130
Beef loin	1.0 kg	uncovered	2		210-230	70
	1.5 kg		2		200-220	80
	2.0 kg		2		190-210	90
Rare roast beef	1.0 kg	uncovered	1		210-230	40
Steaks, well done*		Wire shelf	5		3	20
Steaks, rare*			5		3	15
Pork without rind (e. g. neck)	1.0 kg	uncovered	1		190-210	100
	1.5 kg		1		180-200	140
	2.0 kg		1		170-190	160
Pork with rind (e. g. back, leg)	1.0 kg	uncovered	1		180-200	120
	1.5 kg		1		170-190	150
	2.0 kg		1		160-180	180
Smoked pork ribs, on the bone	1.0 kg	covered	2		210-230	70
Minced meat casserole	750 g of meat	uncovered	1		170-190	70
Sausages	approx. 750 g	Wire shelf	4		3	15
Roast veal	1.0 kg	uncovered	2		190-210	100
	2.0 kg		2		170-190	120
Boned leg of lamb	1.5 kg	uncovered	1		150-170	110

\* Preheat the oven for 5 minutes.

## Poultry

The weights of the table are for unstuffed birds ready to roast.

Place whole birds on the wire shelf initially with the breast side down. Turn once after  $\frac{2}{3}$  the estimated time.



Turn pieces of meat such as turkey pieces or turkey breasts over after half the cooking time has elapsed. Turn the pieces of poultry after  $\frac{2}{3}$  the time has elapsed.

If cooking duck or goose, prick the skin below the wings to release the fat.

The birds can be made brown and crunchy if they are smeared with butter, brine or orange juice more or less at the end of cooking time.

If grilling directly on the shelf, place the enamel tray on level 1.

Poultry	Weight	Cookware	Level	Type of heating	Temperature in °C	Cooking time, minutes
Chicken halves, 1 to 4 portions	400 g each	Shelf	2		200-220	40-50
Chicken pieces	250 g each	Shelf	2		200-220	30-40
Chicken, whole 1 to 4 birds	1.0 kg each	Shelf	2		190-210	50-80
Duck	1.7 kg	Shelf	2		180-200	90-100
Goose	3.0 kg	Shelf	2		170-190	110-130

Poultry	Weight	Cookware	Level	Type of heating	Temperature in °C	Cooking time, minutes
Young turkey	3.0 kg	Shelf	2		180-200	80-100
2 turkey legs	800 g each	Shelf	2		190-210	90-110

### Fish



Turn the fish pieces after  $\frac{2}{3}$  the time has elapsed.

Whole fish do not need to be turned over. Bake whole fish in swimming position with the dorsal fin up. So that the fish

remains stable, place a cut potato or a small container suitable for baking into the abdomen of the fish.

To cook fish fillets, add a few tablespoons of liquid when cooking.

If grilling directly on the shelf, place the enamel tray on level 1.

Fish	Weight	Cookware	Level	Type of heating	Temperature in °C	Time in minutes
Fish, white / mixed (entire piece) for example, sea bream	600 g	Enamel baking tray	3		180-190	45-55
Oily fish (small pieces) for example, Salmon		Shelf*	2		180-190	45-55
Hake (stuffed)	1.0 kg	Enamel baking tray	3		180-190	55-65

\* Place the enamel tray on level 1.

## Tips for roasting and grilling

The table does not contain information for the weight of the joint. Select the next lowest weight from the instructions and extend the time.

How to tell when the roast is ready. Use a meat thermometer (available from specialist shops) or carry out a "spoon test". Press down on the roast with a spoon. If it feels firm, it is ready. If the spoon can be pressed in, it needs to be cooked for a little longer.

The roast is too dark and the crackling is partly burnt. Check the shelf height and temperature.

The roast looks good but the juices are burnt. Next time, use a smaller roasting dish or add more liquid.

The roast looks good but the juices are too clear and watery. Next time, use a larger roasting dish and use less liquid.







Steam rises from the roast when basted. This is normal and due to the laws of physics. The majority of the steam escapes through the steam outlet. It may settle and form condensation on the cooler switch panel or on the fronts of adjacent units.

## Gratins, soufflés, browned items

Place the cookware on the wire shelf.

To roast directly on the wire shelf without containers, insert the enameled tray at height 1. This will keep the oven cleaner.

The result of a gratin depends on the size of the dish and gratin height. The data shown in the table are only given as a guide.

Food	Cookware	Level	Type of heating	Temperature at °C, grill power	Cooking time, minutes
Sweet soufflés (e.g. cheese soufflé with fruit)	Soufflé dish	2		180-200	40-50
Gratins seasoned with cooked ingredients (e.g. pasta with a browned topping)	Soufflé dish or enamel tray	3		210-230	30-40
		3		210-230	20-30
Gratins seasoned with raw ingredients* (e.g. dauphinoise potatoes)	Browning dish or enamel tray	2		160-180	50-70
		2		160-180	50-70
Brown toast	Shelf	5		3	4-5
Grill toast	Shelf	3+1		170-180	8-12



\* The browning must not be more than 2 cm thick.

## Ready-made products

Read and note the manufacturer's instructions on the packaging.

When covering accessories with baking paper, ensure that the paper is suitable for high temperatures. Cut the paper to the size of dish to be prepared.

The result depends directly on the type of food. There may be irregularities and colour differences in the raw products.

Food	Accessories	Level	Type of heating	Temperature in °C	Time in minutes
Chips	Shelf or enamel tray	3		190-210	20-30
Pizza	Shelf	2		200-220	15-20
Pizza-baguette	Enamel baking tray	3		190-200	20-25

**Note:** The baking tray may deform when frozen foods are being defrosted. This is due to the accessories being subjected to different temperatures. The deformation will disappear while baking.

## Special dishes

At low temperatures, a good creamy yoghurt and a spongy yeast dough can be obtained.

First remove accessories and wire shelves or left and right-hand side rails from inside the oven.

### Making yoghurt



1. Boil 1 litre of milk (3.5 % fat) and allow it to cool to about 40 °C.
2. Mix 150 g of yoghurt (at fridge temperature).
3. Pour the mixture into jars or bowls and cover them with transparent film.

4. Preheat the oven as instructed.

5. Now, place the bowls or jars on the bottom of the oven and prepare as follows.

### Leaving yeast dough to rise

1. Prepare the yeast dough as usual. Pour the dough into a heat-resistant ceramic baking dish and cover it.
2. Preheat the oven as instructed.
3. Turn off the appliance and allow the dough to rise inside the oven.

Food	Cookware	Level	Type of heating	Temperature	Time
Yoghurt	Place the bowls or jars	at the bottom of the oven		Preheat to 50 °C 50 °C	5 min. 8 h
Allow the yeast dough to rise	Place a heat-resistant baking dish	at the bottom of the oven		Preheat to 50 °C Turn off the appliance and place the dough inside the oven	5-10 min. 20-30 min.

## Defrosting

Defrosting time depends on the type and quantity of food.

Read and note the manufacturer's instructions on the packaging.

Remove frozen food from the container and place in appropriate cookware on the wire shelf.

Place the bird on a dish with the breast facing down.

Frozen products	Accessories	Level	Type of heating	Temperature
For example, cream cakes, buttercream tarts, chocolate or sugar-coated cakes, fruit, chicken, sausages and meat, bread, rolls, pies and other pastries	Shelf	1		The temperature control knob remains off.

## Drying





Use only quality fruit and vegetables and wash thoroughly.

Allow to drain and dry completely.

Cover the enamel tray and the wire shelf with special baking parchment or greaseproof paper.

Turn the fruit or vegetables from time to time.

When they are golden, dry them and remove from the paper.

Food	Level	Type of heating	Temperature in °C	Cooking time, hours
600 g of sliced apples	1+3		80	approximately 5 h
800 g of pears cut into chunks	1+3		80	approximately 8 h
1.5 kg of cherries	1+3		80	approximately 8-10 h
200 g of cleaned, fresh herbs	1+3		80	approximately 1½ h

## Jam making

For cooking, the jars and the elastic bands must be clean and in perfect condition. Whenever possible, use jars of equal sizes. The values in the tables are given for round 1-Litre jars.

### Caution!

Do not use larger or taller jars. Their lids could explode.

Only use fruit and vegetables that are in good condition. Clean them well.

The times given in tables are only given as an indication. These can vary according to the outside temperature, number of jars, quantity and temperature of the jar content. Before turning off the appliance, ensure the jars have begun to bubble.

### Preparation

1. Tip the fruit or vegetable into the jars but do not fill them to the brim.
2. Clean the edges of the jars; these must be clean.
3. Place a cover and wet elastic band on each jar.

4. Close the jars with clamps.

Do not place more than six jars in the oven at the same time.

### Setting

1. Place the enamel tray at level 2. Place the jars on the tray so that they do not touch each other.
2. Pour half a litre of hot water (approx. 80 °C) on the flat oven tray.
3. Close the oven door.
4. Position the control knob to bottom heat position .
5. Set the temperature between 170 and 180 °C.

### Jam making

After approximately 40 - 50 minutes, bubbles begin to form rapidly. Switch the oven off

Take the jars out of the oven after approximately 25 - 35 minutes (the residual heat is used in this time). If these are allowed to cool in the oven for more time, this could promote the formation of germs making the jam acidic.

Fruit in 1 L jars	from when bubbles start to appear	Residual heat
Apples, gooseberries, strawberries	To switch off	approx. 25 minutes
Cherries, apricots, peaches, gooseberries	To switch off	approx. 30 minutes
Apple, pear or cherry puree	To switch off	approx. 35 minutes

### Cooking vegetables

When small bubbles begin to form in the jars, adjust the temperature to approximately 120 - 140 °C. About 35 - 70 minutes, depending on the type of vegetables. After this time, turn off the oven to use the residual heat.

Cold cooking vegetables in 1 L jars	When bubbles start to appear 120-140 °C	Residual heat
Peppers	-	approx. 35 minutes
Beetroot	approx. 35 minutes	approx. 30 minutes
Brussels sprouts	approx. 45 minutes	approx. 30 minutes
Beans, kohlrabi, red cabbage	approx. 60 minutes	approx. 30 minutes
Peas	approx. 70 minutes	approx. 30 minutes

### Remove the jars from the oven

Remove the jars from inside the oven when cooking is finished.

### Caution!

Do not place hot jars on a cold or wet surface. They could explode.

# Acrylamide in food

Acrylamide is produced especially in cereal and potato products prepared at high temperatures, e. g., chips, toast, rolls, bread and bakery products (biscuits, spicy biscuits, Christmas biscuits).

## Tips for preparing food with a low content in acrylamide

<b>General</b>	<ul style="list-style-type: none"> <li>■ Keep cooking time to a minimum.</li> <li>■ Brown food without toasting it too much.</li> <li>■ Large, thick food products contain little acrylamide.</li> </ul>
<b>Baking</b>	<p>With top and bottom heat max. 200 °C</p> <p>With hot air max. 180 °C.</p>
Pastries and biscuits	<p>With top and bottom heat max. 190 °C.</p> <p>With hot air max. 170 °C.</p> <p>Egg or egg yolk reduces acrylamide formation.</p>
Oven chips	Spread in a single layer uniformly on the tray. Bake at least 400 g. per tray so that the potatoes do not dry up

## Test dishes

These tables have been produced for test institutes to facilitate the inspection and testing of the various appliances.

In accordance with EN 50304/EN 60350 (2009) and IEC 60350.

### Baking

Baking on 2 levels:

Always place the universal deep tray on the upper level and the aluminum pan on the lower level.

Butter cookies:

Trays put in the oven at the same time are not necessarily ready at the same time.

Covered apple tart on level 1:

Place dark spring moulds with some space between them.

Covered apple tart on 2 levels:

Place dark spring moulds on top of one another.

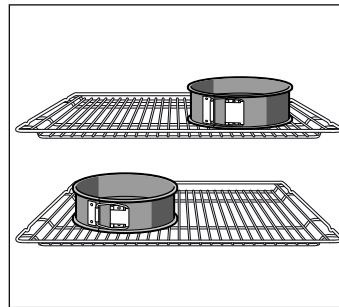



Corrugated cake spring moulds:

Bake using upper and lower heating  on level 1. Use the enamel tray instead of the wire shelf and place spring moulds.

Food	Accessories, advice and warnings	Level	Type of heating	Temperature in °C	Time in minutes
Butter cookies (preheating*)	Flat oven tray	2		160-170	20-30
	Universal deep tray	3		150-160	20-30
	Aluminium tray + flat oven tray	1+3		140-160	20-30
	Aluminium tray + universal deep tray	1+3		140-160	20-30
20 small cakes	Enamel baking tray	3		150-170	20-35
20 small cakes on one tray (preheating)	Aluminium tray + flat oven tray	1+3		140-150	30-40
	Aluminium tray + universal deep tray	1+3		140-150	30-40
Sponge cake (preheating*)	Spring tin	1		170-180	35-45
Pastry case	Enamel baking tray	2		160-180	30-40
	Aluminium tray + flat oven tray	1+3		150-160	30-45
	Aluminium tray + universal deep tray	1+3		150-160	30-40

\* Do not use rapid heating to preheat the oven.

Shelves and baking trays may be obtained as special accessories from specialist retail outlets.



Food	Accessories, advice and warnings	Level	Type of heating	Temperature in °C	Time in minutes
Apple pie	2 wire shelves + 2 corrugated Ø 20 cm spring baking tins.	1+3		170-180	60-70
	Enamel tray + 2 corrugated Ø 20 cm spring baking tins.	1		190-210	70-90

\* Do not use rapid heating to preheat the oven.

Shelves and baking trays may be obtained as special accessories from specialist retail outlets.

## Grilling

If food is placed directly on the wire shelf, place the enamel tray at level 1. The tray will help keep the oven clean by catching any meat juices.

Food	Accessories	Level	Type of heating	Grill power	Time in minutes
Brown toast (preheat for 10 min.)	Shelf	5		3	1/2-2
12 beefburgers* (no pre-heating)	Grill + enamel tray	4+1		3	25-30

\* Turn once after time 2/3.



**Robert Bosch Hausgeräte GmbH**

Carl-Wery-Straße 34

81739 München

Germany

**[www.bosch-home.com](http://www.bosch-home.com)**



9000753014

01  
930522