



PIB6..N1.., PIE6..N1.., PIE7..N1.., PIL8..N1.., PIE9..N1..
Hob



BOSCH

[en] Instruction manual

PIB6..N1..

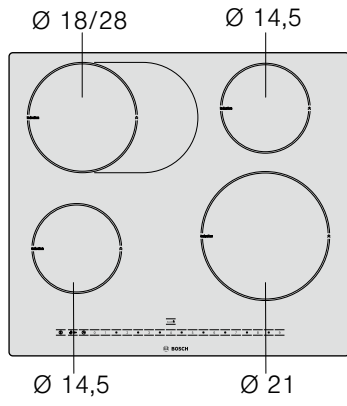

PIE6..N1..

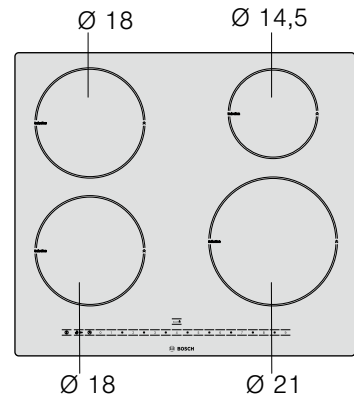

PIE7..N1..

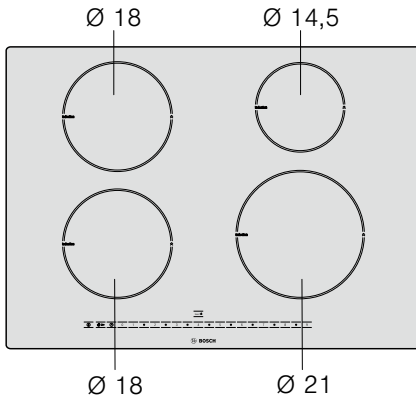

PIL8..N1..

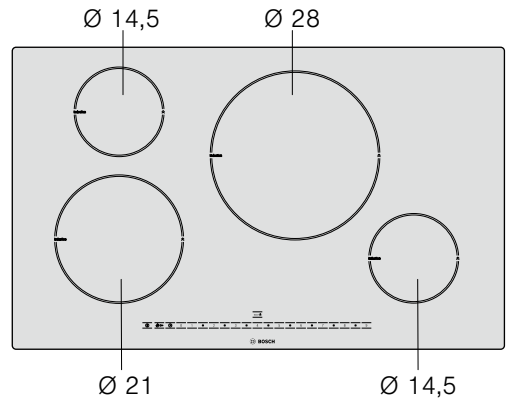

PIE9..N1..

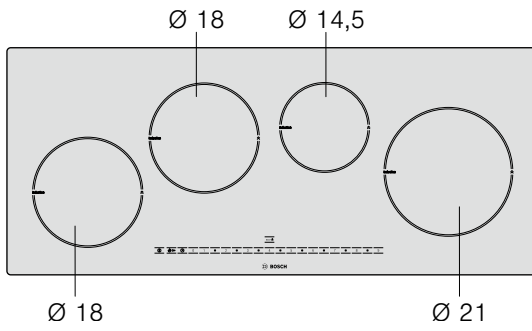

Safety precautions	3	Time programming function	10
Elements that may damage the appliance	5	Turning off a hotplate automatically	10
Protecting the environment	6	Automatic timer	11
Environmentally-friendly disposal of waste products	6	The timer	11
Energy-saving advice	6	Cleaning lock function	11
Induction cooking	6	Automatic time limitation	11
Advantages of induction cooking	6	Basic settings	12
Suitable pans	6	Accessing the basic settings	12
Familiarise yourself with the appliance	7	Care and cleaning	13
The control panel	7	Hob	13
The hotplates	7	Hob frame	13
Residual heat indicator	8	Fixing malfunctions	13
Programming the hob	8	Normal noise while the appliance is working	14
Switching the hob on and off	8	After-sales service	14
Set the hotplate	8		
Cooking guidelines table	8		
Childproof lock	10		
Turning on and off the childproof lock	10		
Activating and deactivating the childproof lock	10		
Powerboost function	10		
Restrictions when using	10		
How to activate	10		
To deactivate	10		

Additional information on products, accessories, replacement parts and services can be found at www.bosch-home.com and in the online shop www.bosch-eshop.com

Safety precautions

Please read this manual carefully. Please keep the instruction and installation manual as well as the appliance certificate in a safe place for later use or for subsequent owners.

Check the appliance after removing it from the packaging. If it has suffered any damage in transport, do not connect the appliance, contact the Technical Assistance Service and provide written notification of the damage caused, otherwise you will lose your right to any type of compensation.

This appliance must be installed in accordance with the installation instructions.

This appliance is intended for domestic use only. The appliance must only be used for the preparation of food and drink. The appliance must be supervised during operation. Only use this appliance indoors.

This appliance is not intended for operation with an external clock timer or a remote control.

This appliance may be used by children over the age of 8 years old and by persons with reduced physical, sensory or mental capacity or by persons with a lack of experience or knowledge if they are supervised or are instructed by a person responsible for their safety how to use the appliance safely and have understood the associated hazards.

Children must not play with the appliance. Children must not clean the appliance or carry out general maintenance unless they are at least 8 years old and are being supervised.

Keep children below the age of 8 years old at a safe distance from the appliance and power cable.

Risk of fire!

- Hot oil and fat can ignite very quickly. Never leave hot fat or oil unattended. Never use water to put out burning oil or fat. Switch off the hotplate. Extinguish flames carefully using a lid, fire blanket or something similar.
- The hotplates become very hot. Never place combustible items on the hob. Never place objects on the hob.
- The appliance gets hot. Do not keep combustible objects or aerosol cans in drawers directly underneath the hob.
- The hob switches off automatically and can no longer be operated. It may switch on unintentionally at a later point. Switch off the circuit breaker in the fuse box. Contact the after-sales service.

Risk of burning!

- The hotplates and the area around them get very hot. Never touch the hot surfaces. Keep children away.
- The hotplate heats up but the display does not work. Switch off the circuit breaker in the fuse box. Contact the after-sales service.

- Metal objects on the hob quickly become very hot. Never place metal objects (such as knives, forks, spoons and lids) on the hob.
- After each use, always turn off the hob at the main switch. Do not wait until the hob turns off automatically after the pan is removed.

Risk of electric shock!

- Incorrect repairs are dangerous. Repairs may only be carried out and damaged power cables replaced by one of our trained after-sales technicians. If the appliance is defective, unplug the appliance from the mains or switch off the circuit breaker in the fuse box. Contact the after-sales service.
- Penetrating moisture may cause an electric shock. Do not use any high-pressure cleaners or steam cleaners.
- A defective appliance may cause electric shock. Never switch on a defective appliance. Unplug the appliance from the mains or switch off the circuit breaker in the fuse box. Contact the after-sales service.
- Cracks or fractures in the glass ceramic may cause electric shocks. Switch off the circuit breaker in the fuse box. Contact the after-sales service.

Electromagnetic hazards!

This appliance complies with safety and electromagnetic compatibility standards. However, people with pacemakers or insulin pumps must refrain from using this appliance. It is impossible to ensure that all of these devices available on the market comply with current electromagnetic compatibility standards, and that interference which may prevent the device from working correctly will not occur. It is also possible that people with other types of devices, such as a hearing aids, could experience some discomfort.

Malfunction risk!

The hob is equipped with a fan in the lower section. If there is a drawer under the hob it should not be used to store small objects or paper, since they could damage the fan or interfere with the cooling if they are sucked into it.

There should be a minimum of 2 cm between the contents of the drawer and fan intake.

Risk of injury!

- When cooking in a bain marie, the hob and cooking container could shatter due to overheating. The cooking container in the bain marie must not directly touch the bottom of the water-filled pot. Only use heat-resistant cookware.
- Saucepans may suddenly jump due to liquid between the pan base and the hotplate. Always keep the hotplate and saucepan bases dry.

Elements that may damage the appliance

Caution!

- Rough pan bases may scratch the hob.
- Avoid leaving empty pots and pans on the hotplate. Doing so may cause damage.
- Do not place hot pans on the control panel, the indicator area, or the hob frame. Doing so may cause damage.
- Hard or pointed objects dropped on the hob may damage it.
- Aluminium foil and plastic containers will melt if placed on the hotplate while it is hot. The use of laminated sheeting is not recommended on the hob.

Overview

The following table presents the most common damage caused:

Damage	Cause	Measure
Stains	Food spillage	Immediately remove spilt food using a glass scraper.
	Unsuitable cleaning products	Only use cleaning products specifically designed for glass-ceramic hobs.
Scratches	Salt, sugar and sand	Do not use the hob as a tray or working surface.
	Pans with rough bottoms may scratch the glass ceramic	Check pans.
Fading	Unsuitable cleaning products	Only use cleaning products specifically produced for glass-ceramic hobs.
	Contact with pans	Lift pots and pans before moving them around.
Chips	Sugar, substances with a high sugar content	Immediately remove spilt food using a glass scraper.

Protecting the environment

Unpack the appliance and dispose of its packaging in such a way that no damage is caused to the environment.

Environmentally-friendly disposal of waste products



This appliance conforms to the Waste Electrical and Electronic Equipment Directive WEEE 2002/96/EC. This directive defines the framework for recycling used appliances within European territory

Energy-saving advice

- Always place the correct lid on cookware. Cooking with an uncovered pan will result in a four-fold increase in energy use. Use a glass lid to provide visibility and avoid having to lift the lid.
- Use cookware equipped with a solid, flat bottom. Curved pan bases increase energy consumption.
- The diameter of the pan base must match the size of the hotplate. If not, energy may be wasted. Note: The manufacturer normally indicates the pan's upper diameter. This is normally greater than the diameter of the pan's base.
- Choose cookware of a size suited to the amount of food you are going to cook. A large pan that is only half full will use a lot of energy.
- Use a small amount of water when cooking. This saves energy, and vegetables retain their vitamins and minerals.
- Select a lower power level.

Induction cooking

Advantages of induction cooking

Induction cooking represents a radical change from the traditional method of heating; the heat is generated directly in the pan. It therefore offers a number of advantages:

- Time savings for cooking and frying; since the pan is heated directly.
- Energy is saved.
- Care and cleaning are simpler. Foods that have spilt do not burn as quickly.
- Heat and safety control; the hob supplies or cuts off power immediately when the control knob is turned on. The induction hotplate stops supplying heat if the pan is removed without having previously switched it off.

Suitable pans

Ferromagnetic pans

Only ferromagnetic pans are suitable for induction cooking, these may be made from:

- enamelled steel
- cast iron
- special cutlery for stainless steel induction pan

To determine whether a pan is suitable, check to see if a magnet will stick to it.

Other suitable cookware for induction

There are other types of cookware especially made for induction whose base is not entirely ferromagnetic.



When using large cookware on a smaller ferromagnetic zone, only the ferromagnetic zone heats up, so heat might not be uniformly distributed.

Cookware with aluminium on the base reduce the ferromagnetic zone, so less heat may be supplied or be difficult to detect.

For good cooking results, the diameter of the cookware's ferromagnetic area should match the size of the hotplate. If cookware is not detected on a hotplate, try it on the next smaller hotplate down.

Unsuitable pans

Never use pans made from:

- common thin steel
- glass
- earthenware
- copper
- aluminium

Characteristics of the pan base

The characteristics of the pan base may affect the uniformity of the cooking results. Pans made from materials which help diffuse heat, such as stainless steel sandwich pans, distribute heat uniformly, saving time and energy.

Absence of pan or unsuitable size

If no pan is placed on the selected hotplate, or if it is made of unsuitable material or is not the correct size, the power level displayed on the hotplate indicator will flash. Place a suitable pan on the hotplate to stop the flashing. If this takes more than 90 seconds, the hotplate will switch off automatically.

Empty pans or those with a thin base

Do not heat empty pans, nor use pans with a thin base. The hob is equipped with an internal safety system. However, an empty pan may heat up so quickly that the "automatic switch off" function may not have time to react and the pan may reach very high temperatures. The base of the pan could melt and damage the glass on the hob. In this case, do not touch the pan and switch the hotplate off. If it fails to work after it has cooled down, please contact the Technical Assistance Service.

Pan detection

Each hotplate has a minimum limit for detecting pans, which varies depending on the material of the pan being used. You should therefore use the hotplate that is most suitable for the diameter of your pan.

Familiarise yourself with the appliance

These instructions for use are applicable to other hobs. On page 2 an overview of the models is provided, along with information on measurements.

The control panel

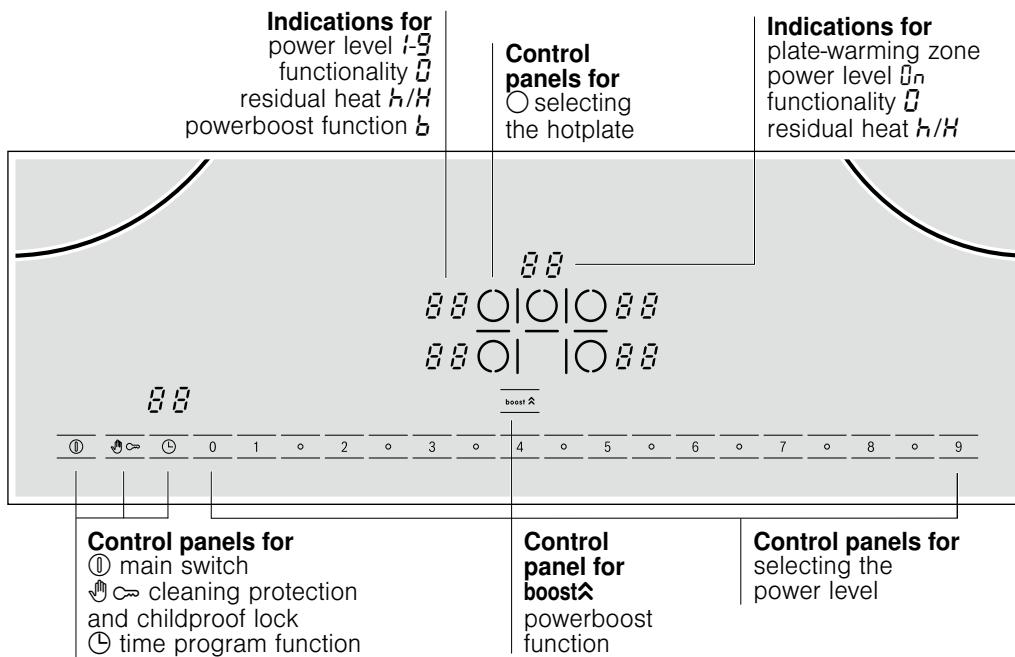

Control surfaces

Pressing a symbol activates its corresponding function.

Notes

- The settings will not change if several symbols are pressed at the same time. This enables the programming zone to be cleaned when food is spilt.
- Always keep the control surfaces dry. Moisture can affect proper functioning.

The hotplates

Hotplate	Activating and deactivating
\bigcirc Single hotplate	Use a correctly sized pan.
Ⓜ Grill plate	The hotplate turns on automatically when a pan the same size as its outer edges is placed on it.
\bigcirc Resistive plate-warming zone	To activate: press the \bigcirc symbol for the plate-warming zone and the display shows 0_n To deactivate: press the \bigcirc symbol again and \square appears in the display.*

* The residual heat indicator lights up.

Only use pans suitable for induction cooking, see the "Appropriate cookware" section.

Residual heat indicator

The hob has a residual heat indicator for each hotplate to show those which are still hot. Avoid touching a hotplate that displays this.

Even when switched off, the **h/H** light will remain on as long as the hotplate remains hot.

If the pan is removed before the hotplate is turned off the **h/H** indicators and the selected power level will appear alternately.

Programming the hob

This section will show you how to program the hotplates. The table contains power levels and cooking times for several dishes.

Switching the hob on and off

The hob is turned on and off using the main switch.

To switch on: press the **ⓘ** symbol. The main switch display and the hotplate displays **○** light up. The hob is ready for use.

To switch off: press the **ⓘ** symbol. The main switch display and the hotplate displays **○** turn off. The hob is switched off. The residual heat indicator will remain lit until the hotplates have cooled down sufficiently.

Note: The range turns off automatically when all of the hotplates are off for over 15 seconds.

Set the hotplate

Select the power level required with the 1 to 9 symbols.

Power level 1 = minimum power

Power level 9 = maximum power

Each power level has an intermediate level. This level is marked with the **o** symbol in the programming area.

Selecting the power level

The hob must be switched on.

1. Press the **○** symbol of the corresponding hotplate.

Indicator **0.0** will come on.

2. Then press the required power level symbol.

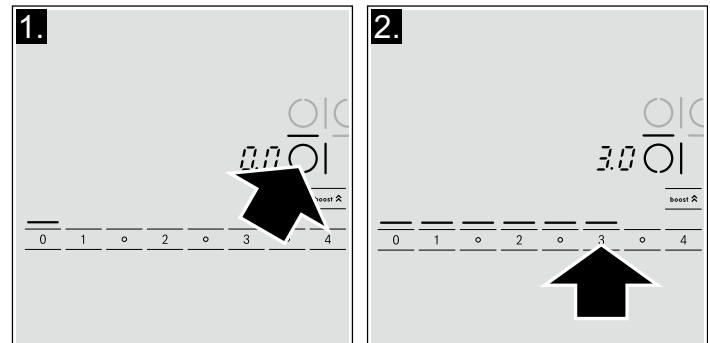

3. To change the power level: select the hotplate and then press the symbol of the required power level. To select an intermediate level, press the **o** symbol that is between the power level symbols.

Switch off the hotplate

Select the hotplate and then press the power level symbol 0.

Note: If no pan has been placed on the induction hotplate, the selected power level flashes. After a certain time, the hotplate switches off.

Cooking guidelines table

The table below contains some examples.

Cooking times depend on the power level, type, weight and quality of the food. As such they are approximate.

Power levels affect cooking results.

When heating purées, creams and thick sauces, stir occasionally.

Use power level 9 to begin cooking.

	Power level	Cooking time (minutes)
Melt		
Chocolate, chocolate coating, butter, honey	1-1.5	-
Gelatine	1-1.5	-
Heating and keeping warm		
Stew (e.g., lentils)	1-2	-
Milk**	1.5-2.5	-
Sausages heated in water**	3-4	-
Defrosting and heating		
Frozen spinach	2.5-3.5	5-15 min
Frozen goulash	2.5-3.5	20-30 min

* Uncovered cooking

** Uncovered

	Power level	Cooking time (minutes)
Slow cooking, simmering		
Potato dumplings	4.5-5.5*	20-30 min
Fish	4-5*	10-15 min
White sauces (e.g., bechamel)	1-2	3-6 min
Whipped sauces (e.g., Bearnaise, Hollandaise)	3-4	8-12 min
Boiling, steaming, sautéing		
Rice (with a double amount of water)	2-3	15-30 min
Rice pudding	2-3	25-35 min
Unpeeled potatoes	4-5	25-30 min
Peeled potatoes with salt	4-5	15-25 min
Pasta	6-7*	6-10 min
Soups	3.5-4.5	15-60 min
Vegetables	2.5-3.5	10-20 min
Greens, frozen foods	3.5-4.5	7-20 min
Cooked in a pressure cooker	4.5-5.5	-
Stewing		
Meat roll	4-5	50-60 min
Stew	4-5	60-100 min
Goulash	3.5-4.5	50-60 min
Bake / Fry with a little oil**		
Steaks, plain or breaded	6-7	6-10 min
Frozen steaks	6-7	8-12 min
Chops, plain or breaded	6-7	8-12 min
Beefsteak (3 cm thick)	7-8	8-12 min
Chicken breast (2 cm thick)	5-6	10-20 min
Frozen chicken breast	5-6	10-30 min
Plain fish and fish fillet	5-6	8-20 min
Breaded fish and fish fillet	6-7	8-20 min
Frozen breaded fish (e.g., fish fingers)	6-7	8-12 min
Prawns and shrimps	7-8	4-10 min
Frozen meals (e.g., stir-fries)	6-7	6-10 min
Pancakes	6-7	fry individually
Omelette	3.5-4.5	fry individually
Fried eggs	5-6	3-6 min
Frying** (150-200 g per serving with 1-2 l. of oil)		
Frozen foods (e.g., French fries, chicken nuggets)	8-9	fry one portion at a time
Frozen croquettes	7-8	
Meatballs	7-8	
Meat (e.g., chicken pieces)	6-7	
Fish, in breadcrumbs or batter	6-7	
Greens, mushrooms, in breadcrumbs or batter (e.g., baby mushrooms)	6-7	
Confectionary products (e.g., fritters, fruit in batter)	4-5	

* Uncovered cooking



** Uncovered

Childproof lock

The hob can be protected against being accidentally turned on, to ensure that children do not switch on the hotplates.

Turning on and off the childproof lock.

The hob should be switched off.

To turn on: press and hold the  symbol for approx. 4 seconds. The  symbol lights up for 4 seconds. The hob is locked.

To turn off: press and hold the  symbol for approx. 4 seconds. The lock is now deactivated.

Activating and deactivating the childproof lock

With this function, the childproof lock automatically activates when a hob is switched off.



Activating and deactivating

See the "Basic Settings" section.

Powerboost function

The Powerboost function can be used to heat large amounts of water more quickly than the power level .

Restrictions when using

This function is available for all hotplates, provided that the other zone of the same group is not operating (see image). Otherwise, in the visual display of the selected hotplate  and  will flash; then the power level will automatically set itself to .

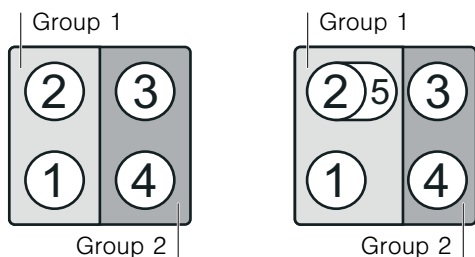

How to activate

1. Select a hotplate.
2. Press the **boost**  symbol. The function has been turned on.

To deactivate

1. Select a hotplate.
2. Press the **boost**  symbol. The Powerboost function has been deactivated.

Note: In certain circumstances, the Powerboost function may turn off automatically in order to protect the electronic components inside the hob.

Time programming function



This function may be used in two different ways:

- to automatically switch off a hotplate.
- as a timer.

Turning off a hotplate automatically

Enter the time period for the hotplate. The hotplate turns off automatically once the time has elapsed.

How to program

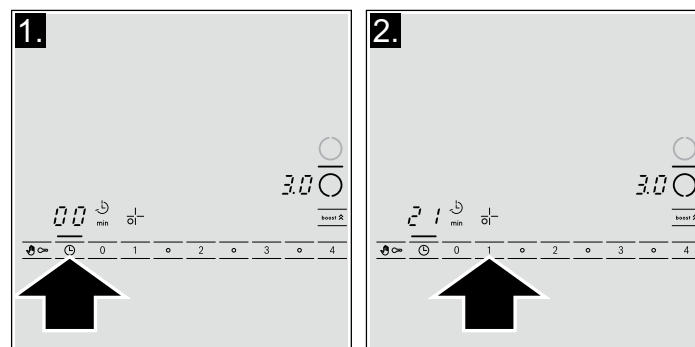

1. Select the required hotplate and power level.
2. Press the  symbol twice.  light up on the time function program display.

3. In the next 10 seconds, program the required time using symbols **1** to **9**.



The cooking time starts to count.



Once the time has elapsed

The hotplate switches off once this time has elapsed. A beep is heard and  appears in the hotplate and the time programming function display shows  for 10 seconds.

When the  symbol is pressed, the displays turn off and the beep goes off.

Changing or cancelling the time

Select the hotplate and press the  symbol twice.

The  and  displays appear

Change the cooking time using symbols **1** to **9** or press **0** to cancel the time.

Notes



- If a cooking time has been programmed, the display always shows the time of this function. To check the cooking time remaining in a hotplate, select a hotplate and press the  symbol twice.
- If a time has been programmed for several hotplates, the time of the selected hotplate is always shown.
- Any cooking time can be programmed for up to 99 minutes.

Automatic timer

With this function you may select a cooking time for all hotplates. Once a hotplate is switched on, the selected time will begin to count down. The hotplate will automatically switch off when the cooking time has elapsed.

Instructions on activating the timer are found in the chapter entitled "Basic settings".



Note: The cooking time can be changed or cancelled for any hotplate:

Press the  symbol several times until the  indicator of the required hotplate lights up. Adjust the cooking time with symbols **1** to **9** or deactivate with the symbol **0**.



The timer

The timer can be set for periods of up to 99 minutes. It is independent of the other settings. This function does not automatically switch off a hotplate.



How to program

1. Press the  symbol. The indicator  lights up.  lights up in the time program function display.
2. Set the required time using symbols **1** to **9**.
The time starts again after a few seconds.

Once the time has elapsed

Once the time has elapsed, a beep will sound.  and  are displayed in the time program function display. After pressing the  symbol, the indications turn off.

Changing or cancelling the time

Press the  symbol, the  indicator lights up.

Change the time using the **1** to **9** symbols or press **0** to cancel.

Cleaning lock function



Cleaning the control panel while the hob is on may change the settings.

In order to avoid this, the hob has a cleaning lock function. Press the  symbol. A signal sounds. The control panel is locked for 35 seconds. The surface of the control panel can now be cleaned without risk of changing the settings.

Note: The lock does not affect the main switch. The hob may be switched off when desired.

Automatic time limitation

If the hotplate remains in use for a long time and no changes are made in the settings, the automatic time limitation function is triggered.

The hotplate stops heating. The  symbol and the residual heat indicator  flash alternatively in the display.

The indicator goes out when any symbol is pressed. The hotplate can now be reset.

When the automatic time function is used, it is governed by the selected power level (from 1 to 10 hours).

Basic settings

The device has several basic settings. These settings may be adapted to the user's individual needs.

Indicator	Function
c 1	Childproof lock 0 Deactivated.* 1 Activated.
c 2	Sound signals 0 Confirmation beep and error signal deactivated. 1 Only confirmation beep deactivated. 2 All signals activated.*
c 5	Automatic timer 0 Switched off.* 1-99 Automatic shut-off time.
c 6	Duration of the time program function warning signal 1 10 seconds*. 2 30 seconds. 3 1 minute.
c 7	Power-Management function 0 = Deactivated.* 1 = 1,000 W. minimum power. 1 = 1,500 W. 2 = 2,000 W. etc. 9 or 9. = maximum power of the hob.
c 9	Hotplate time selection 0 Unlimited: the last hotplate programmed remains selected.* 1 Limited: The hotplate will only remain selected for 10 seconds.
c 0	Return to basic settings 0 Personal settings.* 1 Return to factory settings.

*Factory settings

Accessing the basic settings

The hob should be switched off.

1. Turn on the hob with the main switch.
2. In the next 10 seconds, hold down the  symbol for 4 seconds.

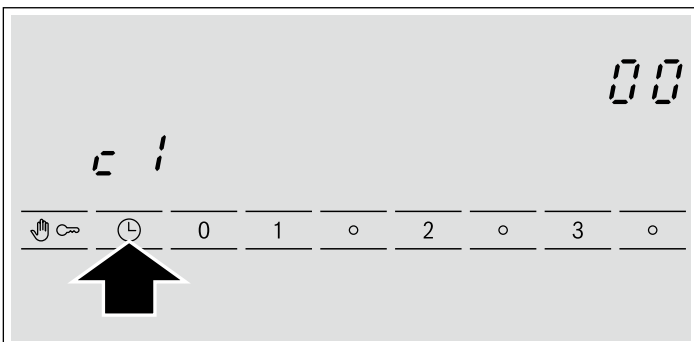

c 1 is displayed on the left of the screen and 0 on the right.

3. Press the  symbol until the indicator for the required function is displayed.

4. Next select the setting required with symbols 0 to 9.

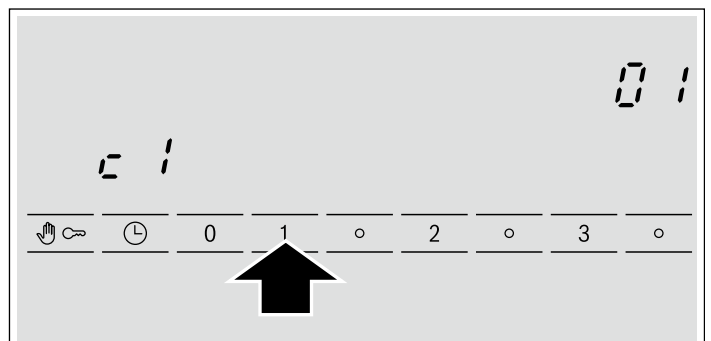

5. Press the  symbol for 4 seconds. The settings will have been properly saved.

Leaving the basic settings

Turn off the hob with the main switch.

Care and cleaning

The advice and warnings contained in this section aim to guide you in cleaning and maintaining the hob, so that it is kept in the best possible condition

Hob

Cleaning

Clean the hob after each use. This prevents food remains left on the surface from burning. Wait until the hob is cold enough before attempting to clean it.

Only use cleaning products specifically designed for glass-ceramic hobs. Follow the instructions provided on the packaging.

Do not use:

- Abrasive products
- heavy-duty cleaners, like oven sprays and stain removers
- Pads that may scratch
- High-pressure or steam cleaners

Glass scraper

Remove dried-on food remains using a glass scraper.

1. Release the scraper safety catch
2. Use the blade to clean the hob surface

Do not attempt to clean the hob surface with the base of the scraper. This could result in scratching.

Risk of injury!!

The blade is extremely sharp. Risk of cuts. Protect the blade when not in use. Replace the blade immediately when any imperfections are found.

Care of the appliance

Apply an additive to protect and preserve the hob. Follow the advice and warnings provided with the product.

Hob frame

In order to avoid damage to the hob frame, follow the indications below:

- Use only slightly soapy hot water
- Do not use sharp or abrasive products
- Do not use a glass scraper

Fixing malfunctions

Malfunctions are generally caused by minor faults. Before contacting the Technical Assistance Service, make sure you have read the following recommendations and warnings.

Indicator	Malfunction	Measure
none	The electric power supply has been interrupted. The appliance has not been correctly connected following the connection diagram. Electronic system malfunction.	Use other electrical appliances to check if there has been a power cut. Make sure that the appliance has been connected correctly. If in the above checks, the malfunction is not resolved, contact the Technical Assistance Service.
<i>E</i> flashing	The control panel is wet or an object is resting on it.	Dry the control panel area or remove the object.
<i>E_r</i> + number / <i>d</i> + number / <i>E</i> + number	Electronic system malfunction.	Disconnect the hob from the mains. Wait 30 seconds or so, then connect it again.*
<i>F0</i> / <i>F9</i>	There is an internal error in the system.	Disconnect the hob from the mains. Wait 30 seconds or so, then connect it again.*
<i>F2</i>	The electronic system has overheated and the corresponding hotplate has been switched off.	Wait until the electronic system has cooled down completely. Then press any symbol on the hob.*
<i>F4</i>	The electronic system has overheated and all hotplates have been switched off.	
<i>U1</i>	Supply voltage outside normal operating limits.	Please contact the local electricity board.
<i>U2</i> / <i>U3</i>	The hotplate has overheated and switched off to protect its working surface.	Wait until the electronic system has cooled down sufficiently before switching it back on.

* If the warning persists call the Technical Assistance Service.

Do not place hot pans on the control panel.

Normal noise while the appliance is working

Induction heating technology is based on the creation of electromagnetic fields that generate heat directly at the base of the pan. Depending on how the pan has been manufactured, these may produce certain noises or vibrations such as those described below:

A deep humming sound as in a transformer

This noise is produced when cooking on a high power level. It is caused by the amount of energy transferred from the hob to the pan. The noise disappears or becomes faint when the power level is lowered.

A low whistling sound

This noise is produced when the pan is empty. It disappears when water or food is added to the pan.

A crackling sound

This noise occurs in pans which are made from different materials superimposed on one another. It is caused by the vibrations that occur at joining surfaces of the different superimposed materials. The noise comes from the pan. The amount of food and cooking method can vary.

A high-pitched whistling sound

This noise is produced mainly in pans made from different materials superimposed on one another, and it occurs when such pans are heated at maximum power on two hotplates at the same time. The whistling disappears or becomes fainter as soon as the power level is lowered.

Noise from the fan

For proper use of the electronic system, the temperature of the hob must be controlled. For this purpose, the hob has a fan that starts working after detecting excess temperatures at different power levels. The fan may also work due to inertia after the hob has been switched off, if the temperature detected is still too high.

The noises described are normal, they are part of induction heating technology and not a sign of malfunction.

After-sales service

Our after-sales service is there for you if your appliance should need to be repaired. We are committed to find the best solution also in order to avoid an unnecessary call-out.

E number and FD number:

Please quote the E number (product number) and the FD number (production number) of your appliance when contacting the after-sales service. The rating plate bearing these numbers can be found on the appliance certificate.

Please note that a visit from an after-sales service engineer is not free of charge, even during the warranty period.

Please find the contact data of all countries in the enclosed customer service list.

To book an engineer visit and product advice

- GB** 0844 8928979
Calls from a BT landline will be charged at up to 3 pence per minute. A call set-up fee of up to 6 pence may apply.
- IE** 01450 2655

Trust the expertise of the manufacturer, and rest assured that the repair will be carried out by trained service technicians using original spare parts for your domestic appliance.



Robert Bosch Hausgeräte GmbH

Carl-Wery-Straße 34

81739 München

Germany

www.bosch-home.com



9000691922

00
911018