

USER INSTRUCTIONS

INSTALLATION INSTRUCTIONS

MAINTENANCE INSTRUCTIONS

This cooktop is for use with Natural Gas and Universal LPG

Leave these instructions with the owner

PCI815B91A



**BOSCH**

Robert Bosch Hausgeräte GmbH  
Carl-Wery-Straße 34  
81739 München  
Cod. 9000617265 A

[www.bosch-home.com](http://www.bosch-home.com)



# Content

Safety considerations . . . . .	5
For your safety . . . . .	5
What to do if you smell gas . . . . .	5
Warnings . . . . .	5
Installation . . . . .	7
Statutory requirements . . . . .	7
Preparing to install . . . . .	7
Clearances . . . . .	8
Installation of cooktop into the kitchen bench . . . . .	9
Connection . . . . .	9
Electrical . . . . .	9
Gas . . . . .	10
Conversion from Nat. Gas to Universal LPG . . . . .	11
To change injectors . . . . .	11
Changing the nozzles of the burners on the cooktop. . . . .	12
Adjustment of the taps . . . . .	13
Operating instructions. . . . .	15
Burner locations . . . . .	15
The gas burners. Operation . . . . .	15
Switching on automatically . . . . .	15
Safety system . . . . .	16
Switching off a burner. . . . .	16
Power levels . . . . .	16
Warnings. . . . .	16
Suitable pans . . . . .	17
Accessories . . . . .	17
Additional wok pan support . . . . .	17
Additional coffee maker support. . . . .	18
Cooking recommendation . . . . .	18
Precautions for use. . . . .	19
Cleaning and maintenance . . . . .	20
Cleaning . . . . .	20
Unsuitable products . . . . .	20
Maintenance . . . . .	20
Service . . . . .	21
Wiring diagram . . . . .	22

Dear customer,

Congratulations on your choice and thank you for purchasing one of our appliances. This practical, modern and functional appliance is manufactured using materials of the highest quality which are subject to strict quality control checks throughout the entire manufacturing process. The appliance is meticulously tested to ensure that it meets your demands and produces perfect cooking results.

Do not remove the appliance from its protective packaging until it is installed in the unit.

Please read these instructions carefully before proceeding to install and use the appliance. The information contained in these instructions is essential for the correct operation of the appliance and, more importantly, for your safety.

The packaging of your appliance has been manufactured using only the materials which are strictly necessary to guarantee efficient protection during transport.

These materials are 100% recyclable, thus reducing the environmental impact. You can also contribute to caring for the environment, by following the advice below:

- dispose of the packaging in the appropriate recycling bin
- before you get rid of an old appliance, make sure you disable it. Contact your local authority to find out the address of your nearest recycling centre to dispose of your appliance
- do not pour used oil down the sink. Collect it in a sealed container and take it to an appropriate collection point or, failing that, place it in the rubbish bin (it will end up in a controlled dump; this is probably not the best option, but it will avoid contaminating ground water)

**IMPORTANT:**

In the unlikely event that the appliance should be damaged or not meet your expectations in terms of quality, please inform us as soon as possible. For the warranty to be valid, the appliance must not have been tampered with, or used inappropriately.

---

# Safety considerations

---

## For your safety

If the information in this manual is not followed exactly, a fire or explosion may result causing property damage, personal injury or death.

Do not store articles on or against this appliance.

Do not store flammable material near this appliance.

Do not spray aerosols in the vicinity of this appliance while it is in operation.

---

## What to do if you smell gas

Do not try to light the appliance.

Do not touch any electrical switch; do not use any phone in your building.

Immediately call your gas supplier from a neighbour's phone. Follow the gas supplier's instructions.

If you cannot reach your gas supplier, call the fire department.

Installation and service must be performed by an authorised person.

---

## Warnings

**DO NOT MODIFY THIS APPLIANCE.**

Do not allow the flame to extend beyond the edge of the cooking utensil. This instruction is based on safety considerations.

Do not forget that the unit becomes hot when in use. Common sense is important. Just because the flame is out, does not mean parts cannot still be hot.

This appliance shall not be used for space heating. This instruction is based on safety considerations.

Be sure to disconnect the electrical supply before disassembly of the appliance.

Keep the appliance area clear and free from combustible materials, gasoline and other flammable vapours and liquids.

This appliance must be installed in a position with the proper level of ventilation. Do not obstruct the flow of combustion and ventilation air.

Cabinets installed above the gas cooktop must have a minimum clearance of 650 mm (24").

The gas pressure regulator supplied with the appliance must be installed in line with the gas pipe. (N.G. only).

For pressure testing in excess of 3.5 kPa (1/2 psig) the appliance and its individual shutoff valve must be disconnected from the gas supply piping system.

Important. When using a very large pot, leave a gap of at least 50 mm (2") to avoid damaging any parts in bench top wood, plastic or other non-heat resistant materials. Never leave oil or hot fat unattended.

The surfaces on heating and cooking appliances get hot when in use. Be careful. **Keep children away from the appliance.**

Only use your appliance for the preparation of food and **never** for room-heating purposes.

This appliance leaves the factory set for the gas supply indicated on the data label. **Call the Service Centre** if it needs to be altered.

Do not tamper inside the appliance. If necessary, call your local **Service Centre**.

Overheated fat or oil can easily catch fire. Never leave the appliance unattended when cooking food with fat or oil, e.g. chips.

Never pour water on burning fat or oil. **DANGER OF BURNS!** Cover the receptacle to smother the flames and turn the cooktop off.

In the event of a fault, cut the gas and electricity supplies to the appliance. Call our **Service Centre** to repair the fault.

Do not use unstable or uneven-based receptacles on cooking plates or burners. They may accidentally tip over.

If a gas supply knob/valve jams, do not force it. Call your official Service Centre immediately for them to repair or replace it.

The illustrations used in this booklet are only intended as a guide.

Grids become very hot during use. When operating the appliance control knobs, take care not to make contact with the grids.

Do not use this appliance neither in marine craft nor in caravans.

This appliance is not intended for use by persons (including children) with reduced physical, sensory or mental capabilities, or lack of experience and knowledge, unless they have been given supervision or instruction concerning use of the appliance by a person responsible for their safety.

Make sure you keep these instructions for use and assembly in a safe place, so that you can hand them on with the appliance if it ever changes owner.

Note: To avoid jeopardising the electrical safety of the appliance, it is forbidden to use high-pressure or steam jet cleaning devices.

**SHOULD THE RELEVANT CONDITIONS NOT BE PROPERLY SATISFIED, THE INSTALLER, AND NOT THE MANUFACTURER, SHALL BE HELD LIABLE.**

# Installation

## Statutory requirements

This installation must conform with the following:

- Manufacturer's Installation instructions
- Local Gas Fitting Regulations
- Municipal Building Codes,
- Refer to AS/NZS 5601.1 for Gas Installations.
- S.A.A. Wiring Code
- Local Electrical Regulations
- Any other statutory regulations

## Preparing to install

Refer to AS/NZS 5601.1 for piping size details. These built-in cooktops are intended to be inserted in a benchtop cutout.

Only an officially authorised technician should connect the appliance.

Before you begin, turn off the gas and electricity supply.

Installation dimensions are shown in Fig. 1.

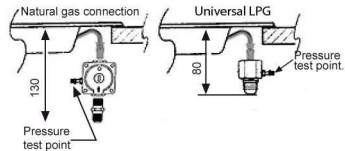
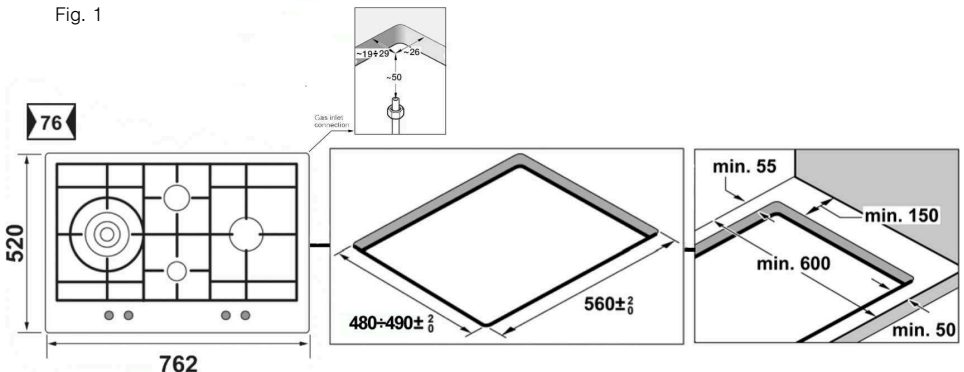

Fig. 1



Before connecting the unit, check whether the local connection conditions (type of gas) are compatible with the unit's setting. Observe any special conditions imposed by local suppliers (utilities). The specifications of this cooktop are stated on the data label located on the bottom of the cooktop base.

A duplicate data label is supplied for adhesion to an accessible location near the hotplate if the data label on the base of the hotplate cannot be accessed when the hotplate is installed.

## Clearances

A range hood fitted above the top must be installed according to the installation instructions for the range hood. A minimum distance of 650 mm is required for a range hood and 750 mm for an exhaust fan.

Any adjoining wall surface situated within 200 mm from the edge of any hob burner must be a suitable non-combustible material for a height of 150 mm for the entire length of the hob. Any combustible construction above the hotplate must be at least 650 mm above the top of the burner and no construction shall be within 450 mm above the top of the burner.

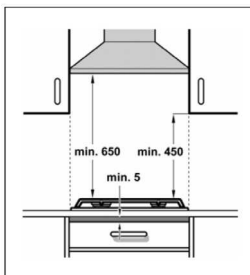

A minimum depth of 50 mm from the top of the worktop surface must be provided for the appliance.

If the base of the hotplate can be touched, a protecting shield must be fitted. This shield must be at least 10 mm from the lowest part of the hotplate and must be capable of withstanding the appliance temperatures. Minimum thickness of benchtop is 30 mm. See Fig. 2.

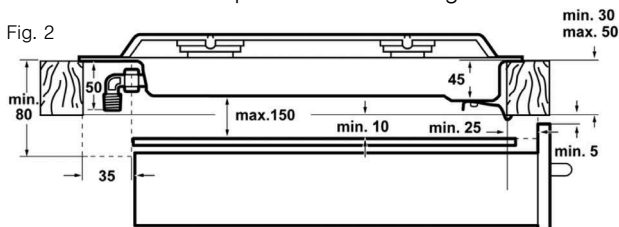

If an oven is positioned below the cooktop the barrier does not need to be fitted, but a space of 35 mm must be maintained between the underside of the cooktop and the top of the oven.

## Installation of cooktop into the kitchen bench

### Installation procedure:

Side clearances: If the distance measured from the periphery of the nearest burner to any vertical surface is less than 200 mm, the surface shall be protected in accordance with clauses 6.10.1.2 of AS/NZS 5601.1

1. For cutout dimensions and clearances refer Fig.1.

2. The clips and the adhesive seal (underside of the cooktop) are already fitted (depending on the model), do not under any circumstances remove them. The seal ensures that the entire work surface will be watertight, and prevents water seepage. In order to fit the appliance into the kitchen unit, first place the cooktop in the correct position then loosen each of the clips so that they all turn freely (it is not necessary to completely undo them). Insert and centre the cooktop.

Press the sides of the cooktop until it is supported around its entire perimeter.

Turn the clips and tighten them fully. Fig. 3.

Fig. 3.

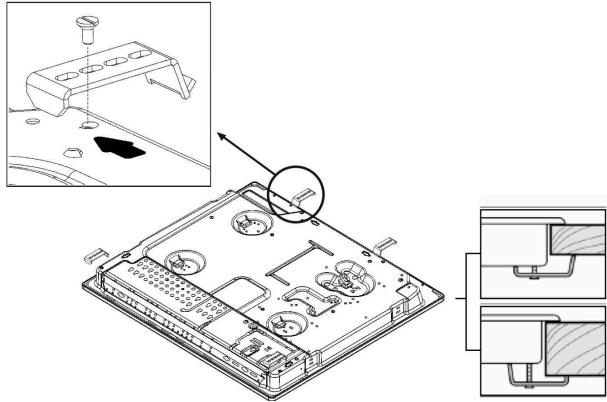

## Connection

### Electrical

Fig. 4



An electrical 10 amp socket needs to be within 1 m of the hotplate to allow electrical connection. The socket must remain accessible after installation of the appliance.

### Important note:

This appliance is connected to the mains (240 VAC) by means of the connecting lead which must be fixed to the kitchen unit to prevent it from coming into contact with hot parts of the cooktop (or an oven installed underneath) and remain accessible after installation of the cooktop.

When making this connection make sure that the lead cannot come into contact with hot parts of the cooktop.

Important: This appliance must be earthed. When connecting the cooktop ensure that the earth wire is



## Gas

connected first and that all wires are connected to the correct terminals. Fig. 4.

During the planning stage, consider the position of supply connections.

The cooktop must be connected to the gas supply with upstream connection of an isolation valve in accordance with the respectively valid regulations. We recommend that the isolation valve be fitted prior to the cooktop to enable isolation of cooktop from gas supply. The valve must be easily accessible at all times.

To find out the factory set gas type, see bottom of cooktop next to gas connection.

Remove plastic cap from gas supply line prior to installation.

Fit regulator (N.G.) or a test point (Universal LPG) directly to the R 1/2" connection as per Fig. 5. and Fig. 6.

Direction of gas flow is indicated on the rear of the regulator.

For position of the inlet connection refer Fig.1.

Use pipe compound or thread sealant, properly threaded pipes and careful assembly procedure so that there is no cross threading, etc., which might cause damage or leakage.

Make sure that all connections performed are free of leakage.

The manufacturer does not accept any liability for leakage on connections performed by the installer or if the L-tube is moved or twisted.

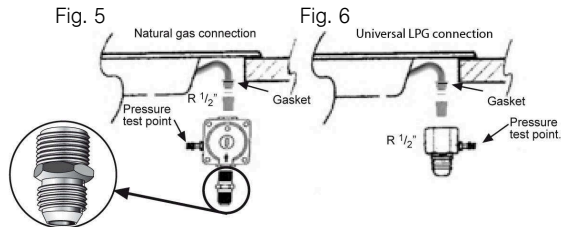

There are two ways to carry out the connection to the main gas line:

A. The hotplate can be connected with rigid pipe as specified in AS/NZS 5601.1

B. Flexible Hose: If installing with a hose assembly, install with a hose assembly that complies with AS/NZS 1869 (AGA Approved), 10 mm ID, class Bor D, no more than 1,2 m long and in accordance with AS/NZS 5601.1.

Ensure that the hose does not contact the hot surfaces of the hotplate, oven, dishwasher or any other appliance that may be installed underneath or next to the hotplate. The hose should not be subjected to abrasion, kinking or permanent deformation and should be able to be inspected along its entire length with the cooktop in the installed position. Unions compatible with the hose fittings must be used and all connections tested for gas leaks.

The supply connection point shall be accessible with the appliance installed.

**WARNING:** Ensure that the hose assembly is restrained from accidental contact with the flue outlet of an underbench oven.

**Before Leaving-** Check all connections for gas leaks with soap and water. **DO NOT** use a naked flame for detecting leaks. Ignite all burners both individually and concurrently to ensure correct operation of gas valves, burners and ignition. Turn gas taps to low flame position and observe stability of the flame for each burner individually and all together. Adhere the duplicate data plate to an accessible location near the hotplate. When satisfied with the hotplate, please instruct the user on the correct method of operation. In case the appliance fails to operate correctly after all checks have been carried out, refer to the authorised service provider in your area.

It should be expressly noted that we cannot accept any liability for direct or indirect damage caused by wrong connection, leakage or improper installation. When being repaired, the appliance must always be disconnected from the mains supply; if required, notify our customer service.

---

## Converting the cooktop from Nat. Gas to Universal LPG

### To change injectors

All work involved in installation, setting and adaptation to a different gas type must be carried out by authorised personnel from our Service Centre and must comply with current regulations and the conditions laid down by the local gas company.

Request change-over injectors from our customer service department (refer injector chart below for sizes).

Burner	Natural Gas		Universal LPG	
	Hourly Gas Consumption (MJ)	Injector mark	Hourly Gas Consumption (MJ)	Injector mark (mm)
Auxiliary	3,60	90	3,50	50
Semi-rapid	6,50	118	6,00	67
Rapid	10,80	155	10,00	85
Triple flame	16,00	182	13,50	100

Before conversion the cooktop must be disconnected from the electricity and gas valves must be turned to the OFF position.

## Changing the nozzles of the burners on the cooktop

- Remove the pan supports, burner covers and diffusers. Fig. 7.

Fig. 7

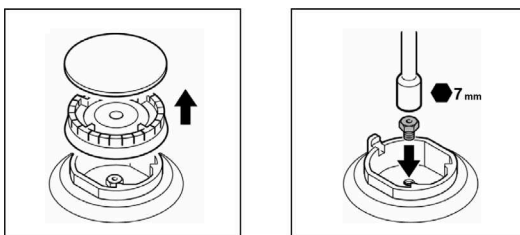

- Change the nozzles using the spanner provided by our Service Centre (code 340847, for double and triple flame burners code 340808), taking special care to ensure that the nozzle does not fall when it is removed from the burner or when fitted. Fig. 8.

Ensure that it is completely tightened in order to guarantee the seal.

Fig. 8

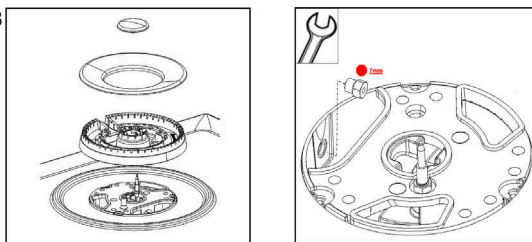

## Adjustment of the taps

Set the control knobs to minimum.

Remove the control knobs from the taps. Fig. 9.

It has a flexible rubber valve reinforcing ring. Simply press on this seal with the tip of a screwdriver to allow access to the tap adjusting screw.

Fig. 9

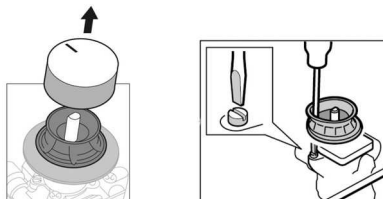

**Never remove the valve reinforcing ring.**

Adjust the minimum ring setting by turning the by-pass screw using a flat head screwdriver.

To adjust the minimum flame for N.G. replace the control knob onto the spindle, light the gas and turn the control knob to the small flame position. Screw the adjustment screw anti-clockwise to establish a minimum stable flame position. The flame should remain alight and not burn back to the injector when the valve is turned quickly from 'Full On' to the "Minimum flame" position and back a few times. To adjust the minimum flame position for ULPG the screw must be fully tightened down clockwise.

If the by-pass screw cannot be accessed, disassemble the grease splash tray, which is fixed to the rest of the hob using a clip and screw mounting system. The following steps must be taken to remove it:

- Remove all the pan supports, burner covers, diffusers and control knobs.
- Remove the hob (see *Installation of cooktop into the kitchen bench*).
- Remove the fastening parts from the bottom of the grease splash tray. Fig. 10.

Fig. 10

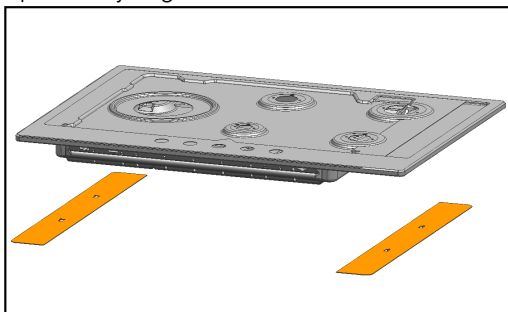

- Remove the screws on the burners.

- Use the disassembly lever 483196 available from our Technical Assistance Service. Remove the front clips by applying the lever to the zones indicated. Fig. 10a.

Fig. 10a

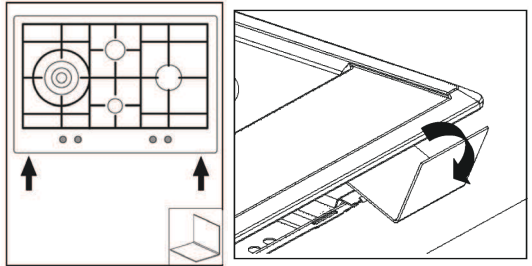

To assemble the grease splash tray again, proceed in the reverse order to removal.

It is important that **all** the seals are refitted to form a seal. These devices are essential for the correct operation of the appliance as they prevent liquids and dirt from entering the appliance.

Refit the control knobs.

Never remove the tap spindle. In the event of a malfunction, change the whole tap. Fig. 11.

Fig. 11

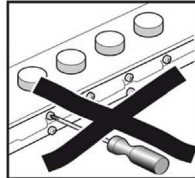

**Warning!** After finishing, the sticker indicating the new type of gas must be placed close to the specifications plate.

# Operating instructions

## Burner locations

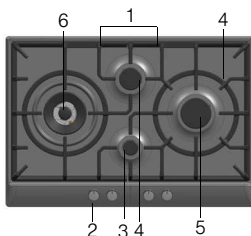

- 1 Pan supports
- 2 Control knobs
- 3 Auxiliary burner (up to 1 kW)
- 4 Semi-rapid burner (up to 1,75 kW)
- 5 Rapid burner (up to 3 kW)
- 6 Triple-flame burner (up to 4 kW)

## The gas burners Operation

There are indications to show which burner each control knob operates. Fig. 12.

Fig. 12



It is essential to ensure that all the burner parts and pan supports are correctly installed for the appliance to work correctly. Fig.13-14.

Fig. 13



Fig. 14

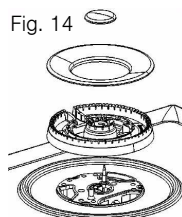

## Switching on automatically

If your cooktop can be switched on automatically (ignition sparkers):

1. Press the chosen burner control knob and turn it anticlockwise to the maximum power setting.

While the control knob is still pressed down, sparks are produced on all burners. The flame ignites (it is no longer necessary to press down the control knob).

2. Turn the control knob to the required setting.

If it does not come on, turn the control knob to the off setting and repeat the steps above. This time, press and hold the control knob for longer (up to 10 seconds).

Warning! If after 15 seconds the flame does not ignite, switch off the burner and open a nearby window or door. Wait at least one minute before trying to switch the burner on.

Depending on the model, your cooktop may have a safety system (thermocouple) that prevents the flow of gas if the burners accidentally switch off. To ensure that this device is active, switch on the burner as usual and, without releasing the control knob, press and hold it down firmly for 4 seconds after lighting the flame. Fig. 15.

## Safety system

Fig. 15

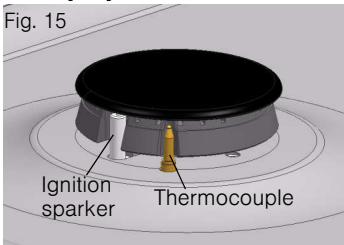

## Switching off a burner

Turn the corresponding control knob clockwise to the 0 setting.

## Power levels

The progressive control knobs can be used to control the power needed, from minimum to maximum power.

Setting	○	Control off
Large flame	⊕	Maximum capacity or aperture and electricity on
Economy flame	⊖	Minimum capacity or aperture

## Warnings

It is normal to hear a slight whistling noise while the burner is operating.

When it is first used, it is normal for the burner to give off odours; this does not pose any risk and does not indicate a malfunction; they will disappear in time.

A few seconds after switching off the burner, it will make a sound (thud). This is not a fault - this means that the safety device is no longer operating.

Keep the burner as clean as possible. If the ignition sparkers are dirty they will not light properly. Clean them periodically using a small non-wire brush. Bear in mind that the ignition sparkers must not suffer any serious impacts.

An orange-coloured flame is normal. This is caused by the presence of dust in the atmosphere, spilt liquids, etc. The kitchen will become hot and humid when this gas appliance is used. You must therefore ensure that the

kitchen is well ventilated: either keep the natural ventilation apertures open, or install a ventilation system (extractor hood).

If using the appliance intensively for prolonged periods, you may require additional ventilation (e.g. by opening a window) or more effective ventilation (e.g. by increasing the cooktop's ventilation, if possible).

If the burner flames are accidentally blown out, switch off the burner operating control knob and do not try to relight it for at least one minute.

Use “Large” setting to bring the pan to the boil, then adjust the flame between “Large flame” and “Economy flame” to maintain the required pan temperature.

Important:

The use of a cooktop leads to the production of heat and moisture in the kitchen. For this reason make sure that the room is properly ventilated. Keep natural ventilation openings, such as windows, open or provide a mechanical ventilation device (e.g. a range hood or overhead exhaust fan). An orange flame is normal and simply indicates the presence of salt in the atmosphere (from cooking). If the flame has yellow patches, this is not a fault (of any kind).

## Suitable pans

The chart below gives the correct pan usage for each burner

Burner	Minimum pan diameter	Maximum pan diameter
Semi-rapid burner	14 cm	20 cm
Rapid burner	22 cm	26 cm
Double or triple flame burners	22 cm	
Auxiliary burner	12 cm	16 cm

## Accessories

Additional wok pan support  
Wok pan



Depending on the model, the hob may include the following accessories. These are also available from the Technical Assistance Service.

Additional wok pan support: to be used exclusively on double and triple-flame burners with concave-based pans.

Using these pans may cause some temporary deformation of the grease splash tray. This is normal and does not affect the operation of the appliance.



## Additional coffee maker support

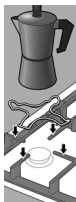

Only for use on the auxiliary burner with pans which are no more than 12 cm in diameter.

The manufacturer accepts no liability if these accessories are not used or are used incorrectly.

## Cooking recommendation

	Very high, high	Medium	Low
Double or triple flame burner	Boiling, grilling, browning and Asian food (wok).	Reheating and keeping things hot: cooked and pre-cooked dishes.	
Rapid burner	Steaks, omelettes, frying.	Rice, white sauce and ragout.	Steaming and vegetables.
Semi-rapid burner	Steaming potatoes, fresh vegetables, stews, pasta.	Reheating, keeping things hot and making tasty casseroles.	
Auxiliary burner	Casseroles, rice pudding and caramels.	Defrosting and slow cooking: vegetables, fruits and frozen products.	Melting: butter, chocolate and jelly.



Do not place anything, eg. flame tamer, asbestos mat, between pan and pan support as serious damage to the appliance may result.



Do not remove the pan support and enclose the burner with a wok stand as this will concentrate and deflect heat onto the hotplate.



Do not use large pots or heavy weights which can bend the pan support or deflect flame onto the hotplate.

## Precautions for use

The following advice is intended to help you save energy and prevent pan damage:

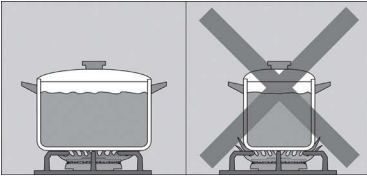

Use pans which are the right size for each burner.  
Do not use small pans on large burners. The flame should not touch the sides of the pan.

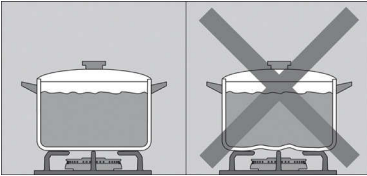

Do not use damaged pans, which do not sit evenly on the cooktop. Pans may tip over.  
Only use pans with a thick, flat base.

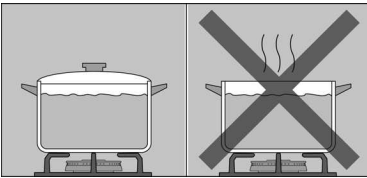

Do not cook without using a lid and make sure the lid is properly fitted to avoid wasting energy.

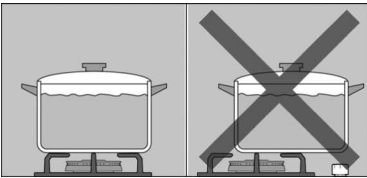

Always place the pan right over the burner, not to one side. Otherwise it could tip over.

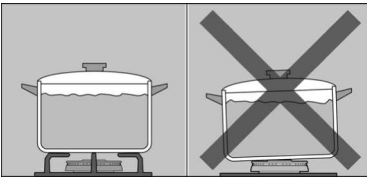

Do not place large pans on the burners near the control knobs. These may be damaged by the very high temperatures.

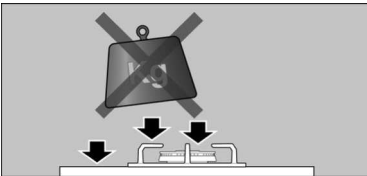

Place the pans on the pan supports, never directly on the burner.

Pans should be placed on the cooktop carefully.  
Do not strike the cooktop and do not place excessive weight on it.  
Make sure that the pan supports and burner covers are correctly positioned before using the appliance.

# Cleaning and maintenance

## Cleaning

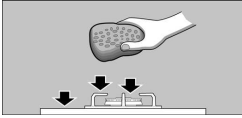

Once the appliance is cool, use a sponge to clean it with soap and water.

After each use, clean the surface of the respective burner parts once they have cooled down. If any residue is left (baked-on food, drops of grease etc.), however little, it will become stuck to the surface and more difficult to remove later. The holes and grooves must be clean for the flame to ignite properly.

The movement of some pans may leave metal residue on the pan supports.

Clean the burners and pan supports using soapy water and scrub with a non-wire brush.

If the pan supports are fitted with rubber rests, ensure that these are also cleaned. The rests may come loose and the pan support may scratch the hob.

Always dry the burners and pan supports completely. Water droplets or damp patches on the hob at the start of cooking may damage the enamel.

After cleaning and drying the burners, make sure the burner covers are correctly placed on the diffuser.

Do not use steam cleaners. This could damage the hob.

If your hob is fitted with a glass or aluminium panel, never use a knife, scraper or similar to clean the point where it joins the metal.

## Unsuitable products

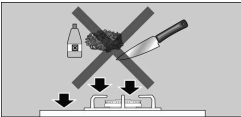

## Maintenance

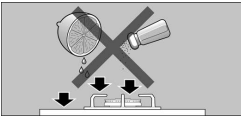

Always clean off any liquid as soon as it is spilt: you will save yourself any unnecessary effort.

Do not leave acidic liquids (e.g. lemon juice, vinegar, etc.) on the hob.

Where possible, do not allow salt to come into contact with the surface of the electric hob.

The ring cover of the double or triple flame burner and stainless steel parts such as hotplate rings, top sheet and the area around the burners may become discoloured over time. This is normal because of the high temperatures. Each time the appliance is used these parts should be cleaned with a product that is suitable for stainless steel.

The stainless steel cleaner must not be used in the area around the controls. The (printed) symbols may be wiped off.

## Service

DO NOT MODIFY THIS APPLIANCE.

Only authorized personnel from the Service Centre are qualified to work on the appliance.

Sometimes certain faults detected can be easily resolved. Before calling the Service Centre, bear in mind the following advice:

Fault	Possible cause	Solution
The general electrical system is malfunctioning.	Defective fuse. The automatic safety switch or circuit breaker has tripped.	Check the fuse in the main fuse box and change it if it is damaged. Check the main control panel to see if the automatic safety switch or circuit breaker has tripped.
The automatic on function does not work.	There may be food or cleaning products stuck between the ignition sparkers and the burners. The burners are wet. The burner covers are not correctly positioned. The appliance is not earthed, is not correctly connected or the earth wire is faulty.	The space between the ignition sparker and the burner must be clean. Dry the burner covers carefully. Check that the covers are correctly positioned. Contact the electrical installer.
The burner flame is not uniform.	The burner components are not correctly positioned. The grooves on the burner are dirty.	Ensure the components are correctly positioned. Clean the grooves on the diffuser.
The flow of gas does not appear normal or no gas comes out.	The gas supply is blocked via intermediary valves. If the gas is supplied from a gas cylinder, check that this is not empty.	Open all intermediary valves. Change the gas cylinder.
The kitchen smells of gas.	A gas tap has been left on. There may be a leak in the gas cylinder coupling.	Turn off the gas taps. Check that the coupling is sound.
The safety valves on one of the burners are not working.	The control knob was not held down for long enough. The grooves on the diffuser are dirty.	Once the burner is lit, hold the control knob down a few seconds longer. Clean the grooves on the diffuser.

Any of the following are considered to be abnormal operation and may require servicing:

Yellow tipping of the cooktop burner flame.

Sooting up of cooking utensils.

Burners not lighting properly.

Gas valves, which are difficult to turn in case the appliance fails to operate correctly, contact the authorised service provider in your area.

# Wiring diagram

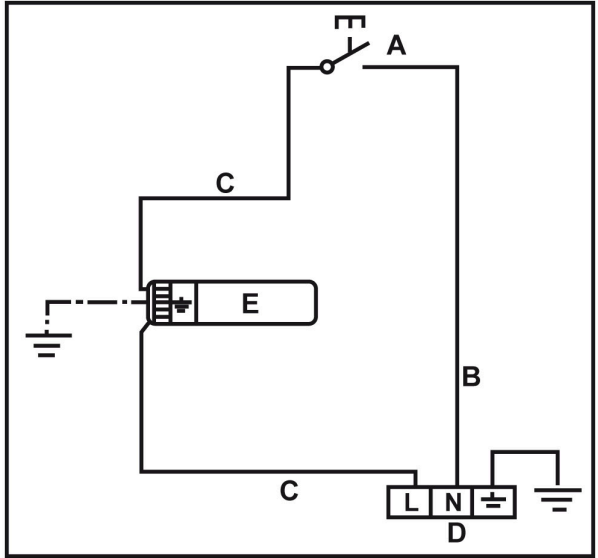

- A. Switch
- B. Blue wire
- C. Brown wire
- D. Terminal
- E. Ignition module

www.bosch-home.com      CIF: A-28-893550		
<b>ROBERT BOSCH HAUSGERÄTE GMBH</b>		
E-Nr: PCI815B91A		FD
Gas type	NG	ULPG
Test point pressure (kPa)	1,0	2,75
Injectors marks		
LH	182	100
RH	155	85
CR	118	67
CF	90	50
HGC (MJ)	36,90	33,00
In compliance with AS/NZS 3100 and AS 4551:2008		
Preinstalled NG		
MADE IN SPAIN Distributed by BSH Home Appliances Pty Ltd		GMK 10047