

HBN13B2.1B



BOSCH

[en] Instruction manual2



9000540892

Safety precautions	3	Changing the basic settings	10
Before installation	3	Care and cleaning	10
Safety notes	3	Cleaning agents	10
Causes of damage	3	Cleaning the hook-in racks	11
Your new oven	4	Detaching and attaching the oven door	11
Control panel	4	Cleaning the door panels	12
Buttons and display	4	Troubleshooting	12
Function and temperature selector	4	Malfunction table	12
Function selector	5	Replacing the oven light bulb	13
Temperature selector	5	Glass cover	13
Cooking compartment	5	After-sales service	13
Shelf positions	5	E number and FD number	13
Accessories	5	Energy and environment tips	13
Before using for the first time	7	Saving energy	13
Setting the clock	7	Environmentally-friendly disposal	13
Heating up the oven	7	Tested for you in our cooking studio.	14
Cleaning accessories	7	Cakes and pastries	14
Setting the oven	7	Baking tips	15
Switching on the oven	7	Meat, poultry, fish	16
Switching off the oven	7	Tips for roasting and grilling	18
Setting the time-setting options	8	Preprepared products	18
Timer	8	Special dishes	19
Cooking time	8	Defrost	20
End time	9	Desiccation	20
Clock	9	Acrylamide in foodstuffs	20
Childproof lock	9	Test dishes	21
Switching on the childproof lock	9	Baking	21
Switching off the childproof lock	9	Grilling	21

Additional information on products, accessories, replacement parts and services can be found at www.bosch-home.com and in the online shop www.bosch-eshop.com

Safety precautions

Please read this instruction manual carefully. Please keep the instruction and installation manuals in a safe place. Please pass on these manuals to the new owner if you sell the appliance.

Before installation

Damage during transport

Check the appliance for damage after unpacking it. Do not connect the appliance if it has been damaged in transit.

Electrical connection

Only a licensed expert may connect the appliance. You will lose your warranty entitlement in the event of any damage caused by incorrect connection.

Safety notes

This appliance is intended for domestic use only. This appliance must only be used for food preparation.

Adults and children must not operate the appliance without supervision,

- if they are physically or mentally incapable of doing so or
- if they have insufficient knowledge or experience.

Never let children play with the appliance.

Hot cooking compartment

Risk of burns!

- Never touch the interior surfaces of the cooking compartment or the heating elements. Open the appliance door carefully. Hot steam may escape. Small children must be kept at a safe distance from the appliance.
- Never prepare food containing large quantities of drinks with a high alcohol content. Alcoholic vapours can catch fire in the cooking compartment. Only use small quantities of drinks with a high alcohol content and open the appliance door carefully.

Risk of fire!

- Never store combustible items in the cooking compartment. Never open the appliance door if there is smoke inside. Switch off the appliance. Pull out the mains plug or switch off the circuit breaker in the fuse box.
- Do not place greaseproof paper loosely over accessories during preheating. A draught is created when the appliance door is opened. The greaseproof paper may come into contact with the heating element and catch fire. Always weight down the greaseproof paper with a dish or a baking tin. Only cover the surface required with greaseproof paper. The greaseproof paper must not protrude over the accessories.

Risk of short circuit!

Never trap connecting cables of electrical appliances in the hot appliance door. The cable insulation could melt.

Risk of scalding!

Never pour water into the hot cooking compartment. This will produce hot steam.

Hot accessories and ovenware

Risk of burns!

Never remove ovenware or accessories from the cooking compartment without an oven cloth or oven gloves.

Improper repairs

Risk of electric shock!

Improper repairs are dangerous. Repairs may only be carried out by one of our trained after-sales engineers. If the appliance is defective, pull out the mains plug or switch off the appliance at the circuit breaker in the fuse box. Call the after-sales service.

Causes of damage

Caution!

- Accessories, foil, greaseproof paper or ovenware on the cooking compartment floor: do not place accessories on the cooking compartment floor. Do not cover the cooking compartment floor with any sort of foil or greaseproof paper. Do not place ovenware on the cooking compartment floor if a temperature of over 50 °C has been set. This will cause heat to accumulate. The baking and roasting times will no longer be correct and the enamel will be damaged.
- Water in a hot cooking compartment: do not pour water into the cooking compartment when it is hot. This will cause steam. The temperature change can cause damage to the enamel.
- Moist food: do not store moist food in the cooking compartment when it is closed for prolonged periods This will damage the enamel.
- Fruit juice: when baking particularly juicy fruit pies, do not pack the baking tray too generously. Fruit juice dripping from the baking tray leaves stains that cannot be removed. If possible, use the deeper universal pan.
- Cooling with the appliance door open: only allow the cooking compartment to cool when it is closed. Even if the appliance door is only open a little, front panels of adjacent units could be damaged over time.
- Heavily soiled oven seal: if the oven seal is heavily soiled, the oven door will no longer close properly when the oven is in operation. The fronts of adjacent units could be damaged. Always keep the oven seal clean.
- Oven door as a bearing surface: do not stand or place objects on the oven door when it is open. Do not place ovenware or accessories on the oven door.
- Carrying the appliance: do not carry or hold the appliance by the door handle. The door handle cannot support the weight of the appliance and could break.

Your new oven

Here you will learn about your new oven. The control panel and the individual operating controls are explained. You will find information on the cooking compartment and the accessories.

Control panel

Here is an overview of the control panel. The display never shows all of the symbols at the same time. Details may vary, depending on the appliance model.

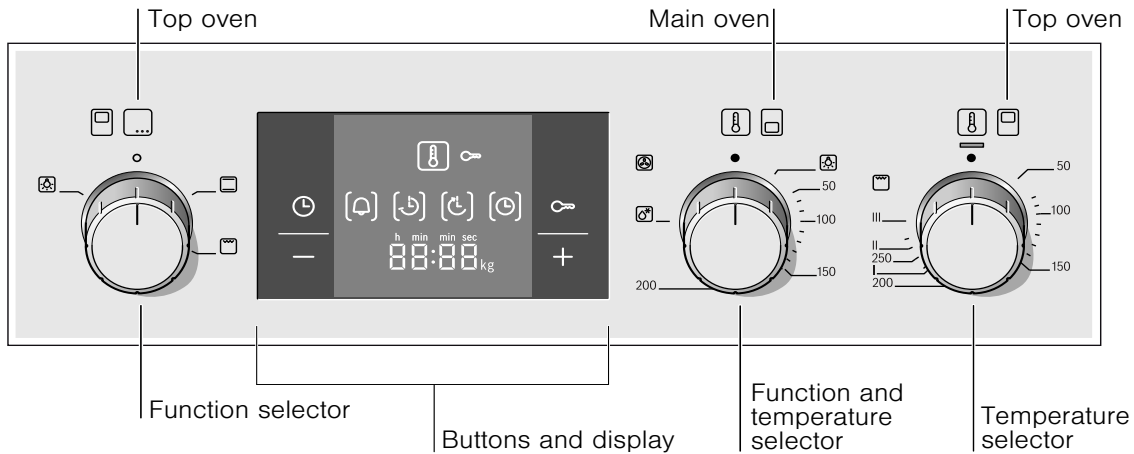

Control knobs

The control knobs can be popped out. Simply press the control knob when it is in the off position to pop it in or out.

Buttons

The sensors are located under the individual buttons. They must not be pressed too firmly. Only touch the corresponding symbol.

Buttons and display

You can use the buttons to set various additional functions. You can read the values that you have set in the display.

Button	Use
Time-setting options	Selects the timer , cooking time , end time and clock .
Childproof lock	Locks and unlocks the control panel.
Minus	Decreases the set values.
Plus	Increases the set values.

The time-setting option that is currently selected in the display is indicated by the brackets [] around the corresponding symbol. Exception: for the clock, the symbol only lights up when you are making changes.

Function and temperature selector

Using the function and temperature selector, set the type of heating and temperature in the main oven.

Setting	Use
Off position	The main oven is switched off.
3D hot air* 50 - 250 °C	For cakes and pastries on one or more levels. The fan distributes the heat from the heating ring in the back panel evenly around the cooking compartment.
Defrosting	For defrosting, e.g. meat, poultry, bread and cakes. The fan causes the warm air to swirl around the dish.
Oven light	Switches on the oven light.





* Type of heating used to determine the energy efficiency class according to EN50304.

When you make settings, the oven light in the cooking compartment switches on.

When the main oven is heating, the symbol lights up in the display. It goes out during pauses in the heating. For the Defrost type of heating, the symbol does not light up.

Function selector

Use the function selector to select the type of heating for the  main oven.



Setting	Use
 Off position	The top oven is switched off.
 Top/bottom heating*	For cakes, bakes and lean joints of meat, e.g. beef or game, on one level. The heat is emitted evenly from above and below.
 Grill, large area	For grilling steaks, sausages, toast and pieces of fish. The whole area below the grill heating element becomes hot.
 Oven light	Switches on the oven light.

* Type of heating used to determine the energy efficiency class according to EN50304.

When you make settings, the oven light in the cooking compartment switches on.

Temperature selector

Use the temperature selector to set the temperature or grill setting in the  top oven.

Setting	Use
 Off position	The top oven is not heating.
50 - 270	Temperature range The temperature in the cooking compartment in °C.
I, II, III	Grill settings The grill settings for the  Grill, large area. I = level 1, low II = level 2, medium III = level 3, high

When the top oven is heating, the indicator lamp for the  temperature lights up. It goes out during heating pauses.

Cooking compartment

The oven light is located in the cooking compartment. A cooling fan protects the oven from overheating.

Oven light

During operation, the oven light in the cooking compartment is on. The  setting on the function selector can be used to switch on the light without heating the oven.

Cooling fan

The cooling fan switches on and off as required. The hot air escapes above the door. Caution: do not cover the ventilation slots. Otherwise the oven will overheat.

So that the cooking compartment cools down more quickly after operation, the cooling fan continues to run for a certain period afterwards.

Shelf positions

You can pull out the accessories two thirds of the way without them tipping. This allows meals to be removed easily.

The accessories may become deformed when they become hot. As soon as they have cooled down, the deformation disappears with no effect on the function.

Main oven

The accessories can be inserted into the oven at 3 different levels.

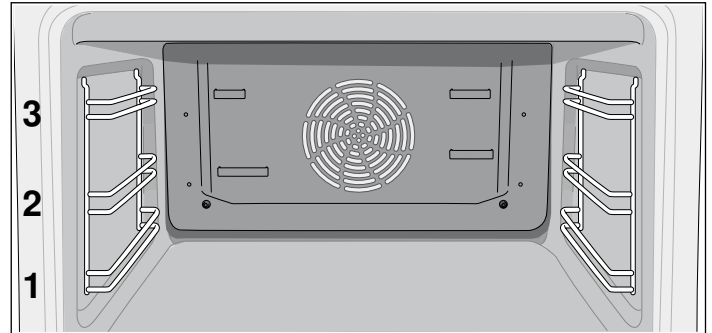

Top oven

The accessories can be inserted into the oven at 2 different levels.

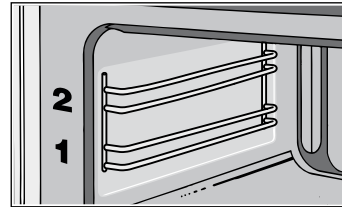

Accessories

You can buy accessories from the after-sales service, from specialist retailers or online. Please specify the HEZ number.



Wire rack

For ovenware, cake tins, joints, grilled items and frozen meals.

Insert the wire rack with the curvature pointing downward .



Insert grid

For roasting.

Always place the insert grid in the universal pan. This ensures that dripping fat and meat juices are collected.

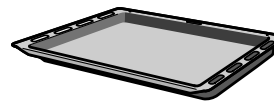

Universal pan

For moist cakes, pastries, frozen meals and large joints. It can also be used to catch dripping fat when grilling directly on the wire rack.

Slide the universal pan into the oven with the sloping edge facing the oven door.

Optional accessories

You can purchase special accessories from the after-sales service or specialist retailers. You will find a comprehensive range of products for your oven in our brochures and on the

Internet. The availability of special accessories and whether it is possible to order them online may vary depending on your country. Please see the sales brochures for more details.

Optional accessories	HEZ number	Use
Wire rack	HEZ334000	For cookware, cake tins, roasts, grilling and frozen meals.
Enamel baking tray	HEZ331000	For cakes and biscuits. Push the baking tray into the oven with the sloping edge facing towards the oven door.
Universal pan	HEZ332000	For moist cakes, pastries, frozen meals and large roasts. It can also be used to catch dripping fat when you are grilling directly on the grid. Slide the universal pan into the oven with the sloping edge facing the oven door.
Insert grid	HEZ324000	For roasting. Always place the roasting rack in the universal pan. This ensures that dripping fat and meat juices are collected.
Grill tray	HEZ325000	Use for grilling in place of the grid or as a splatter guard, so that the oven does not become very dirty. Only use the grill tray in the universal pan. Grilling on the grill tray: only use at shelf height 1, 2 and 3. Using the grill tray as a splash guard: insert the universal pan with the grill tray under the wire rack.
Glass pan	HEZ336000	A deep baking tray made of glass. Can also be used as a serving dish.
Pizza tray	HEZ317000	Ideal for pizza, frozen products or large round cakes. You can use the pizza tray instead of the universal pan. Place the baking tray on the wire rack and proceed according to the details in the tables.
Enamel baking tray with non-stick coating	HEZ331010	Cakes and biscuits can be removed more easily from the baking tray. Push the baking tray into the oven with the sloping edge facing towards the oven door.
Universal pan with non-stick coating	HEZ332010	Moist cakes, pastries, frozen meals and large roasts can be removed more easily from the universal pan. Slide the universal pan into the oven with the sloping edge facing the oven door.
Telescopic shelf x3	HEZ 338307	The pull-out rails at levels 1, 2 and 3 allow you to pull accessories out further without them tipping.
Protective grid for oven door	672942	Prevents the oven door from being touched accidentally from the outside while the appliance is in operation.

After-sales service products

You can obtain suitable care and cleaning agents and other accessories for your domestic appliances from the after-sales

service, specialist retailers or (in some countries) online via the e-Shop. Please specify the relevant product number.

Cleaning cloths for stainless-steel surfaces	Product no. 311134	Reduces the build-up of dirt. Impregnated with a special oil for perfect maintenance of your appliance's stainless-steel surfaces.
Oven and grill cleaning gel	Product no. 463582	For cleaning the cooking compartment. The gel is odourless.
Microfibre cloth with honeycomb structure	Product no. 460770	Especially suitable for cleaning delicate surfaces, such as glass, glass ceramic, stainless steel or aluminium. The microfibre cloth removes liquid and grease deposits in one go.
Door lock	Product no. 612594	To prevent children from opening the oven door. The locks on different types of appliance door are screwed in differently. See the information sheet supplied with the door lock.

Before using for the first time



Here, you will find out what you have to do before preparing food with your oven for the first time. Read the Safety information section beforehand.

Setting the clock



Once you have connected the appliance, the  symbol and four zeros light up in the display. Set the clock.

1. Press the  button.
The time 12:00 is shown in the display.
2. Use the **+** or **-** button to set the clock.
After a few seconds, the time which has been set is adopted.

Heating up the oven

To get rid of the new cooker smell, heat up the oven when it is empty and closed. One hour with  3D hot air or  Top/

bottom heating at 240 °C is ideal. Make sure that there are no packaging remains in the cooking compartments.

1. Use the function selector to set  Top/bottom heating.
2. Use the temperature selector to set the temperature to 240 °C.
3. Use the function and temperature selector to set 240 °C and  3D hot air.
Turn the oven off after one hour. To do so, turn all function and temperature selectors to the off position.

Cleaning accessories

Before using the accessories for the first time, clean them thoroughly using hot, soapy water and a soft cloth.

Setting the oven

There are various ways in which you can set your oven. Here we will explain how you can select the desired type of heating and temperature or grill setting. You can select the oven cooking time and end time for your dish. Please refer to the section on *Setting the time-setting options*.

Switching on the oven

Main oven

Using the function and temperature selector, set a temperature for  3D hot air mode.

Turn the function and temperature selector to the  position to set the Defrost setting.

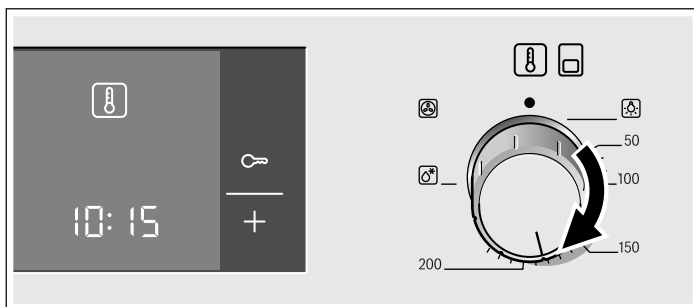

The main oven begins to heat up.

Top oven

Example shown below: Top/bottom heating at 200°C

1. Use the function selector to set the type of heating.

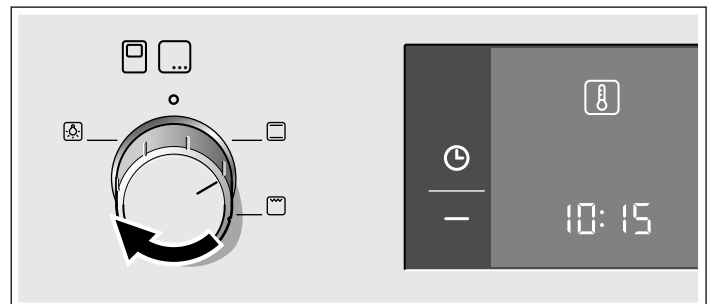

2. Set the temperature or grill setting using the temperature selector.

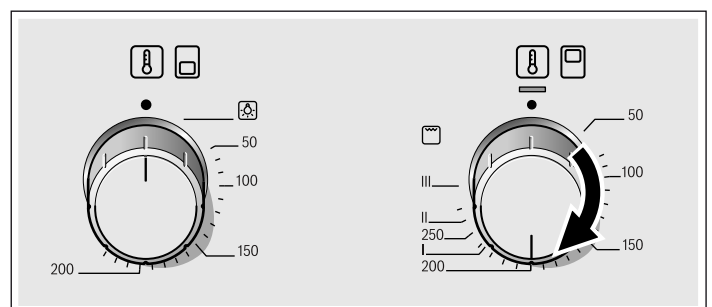

The top oven begins to heat up.



Changing the settings

The type of heating and temperature or grill setting can be changed at any time with their respective selector.

Switching off the oven

Turn the function and temperature selector to the off position.

Setting the time-setting options

The  main oven has various time-setting options. You can use the  button to access the menu and switch between the individual options. All the time symbols are lit during the time when you can make settings. The [] brackets show you which time-setting function you have currently selected. A time-setting option which has already been set can be changed directly using the + or - button, when its time symbol is in brackets.

Timer

You can use the timer as a kitchen timer. It runs independently of the oven. The timer has its own signal. In this way, you can tell whether it is the timer or a cooking time which has elapsed.

1. Press the  button once.

The time symbols light up in the display and the brackets are around .

2. Use the + or - button to set the timer duration.

Default value for +button = 10 minutes

Default value for -button = 5 minutes

After a few seconds, the time setting is adopted. The timer starts. The  symbol lights up in the display and the timer duration counts down. The other time symbols go out.

The timer duration has elapsed

A signal sounds. 00:00 is shown in the display. Use the  button to switch off the timer.

Changing the timer duration





Use the + or - button to change the timer duration. After a few seconds, the change is adopted.

Cancelling the timer duration

Use the - button to reset the timer duration to 00:00. The change will be adopted after a few seconds. The timer is switched off.

Checking the time settings



If several time-setting options are set, the relevant symbols are illuminated on the display. The symbol for the time-setting option that is visible in the display is shown in brackets.

To call up the  timer,  cooking time,  end time or  clock, press the  button repeatedly until the brackets are around the relevant symbol. The display shows the value for a few seconds.

Cooking time

You can set a cooking time for your dish in the  main oven. When the cooking time has elapsed, the main oven switches itself off automatically. This means that you do not have to interrupt other work to switch off the main oven. The cooking time cannot be accidentally exceeded.

Example shown below: Cooking time of 45 minutes.

1. Turn the function and temperature selector to set the heating type and temperature for the main oven.
2. Press the  button twice. The display shows 00:00. The time symbols light up, the brackets are around .

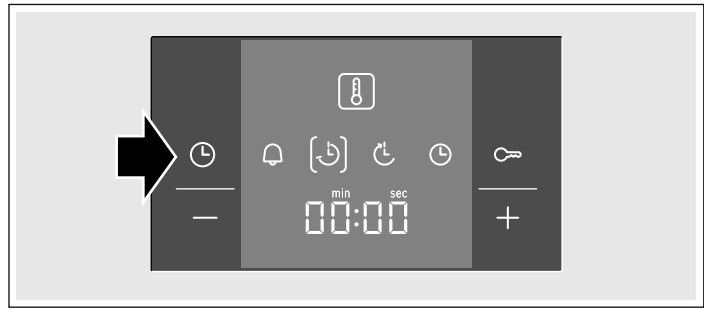

3. Use the + or - button to set the cooking time.

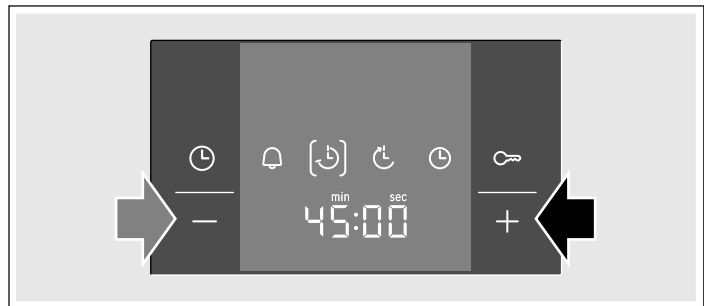

■ Default value for the + button = 30 minutes

■ Default value for the - button = 10 minutes



The main oven will start up after a few seconds. The cooking time counts down in the display and the  symbol lights up. The other time symbols go out.

The cooking time has elapsed

A signal sounds. The main oven stops heating. 00:00 is shown in the display. Press the  button. The + or - buttons can be used to set a new cooking time. Or press the  button twice and turn the function and temperature selector to the off position. The main oven is switched off.

Changing the cooking time





Use the + or - button to change the cooking time. After a few seconds, the change is adopted. If the timer has been set, press the  button beforehand.

Cancelling the cooking time

Use the - button to reset the cooking time to 00:00. After a few seconds, the change is adopted. The cooking time is cancelled. If the timer has been set, press the  button beforehand.

Checking the time settings

If several time-setting options are set, the relevant symbols are illuminated on the display. The symbol for the time-setting option that is visible in the display is shown in brackets.



To call up the  timer,  cooking time,  end time or  clock, press the  button repeatedly until the brackets are around the relevant symbol. The display shows the value for a few seconds.

End time

You can delay the time at which you wish your dish to be ready. The  main oven starts automatically and finishes at the desired time. You can, for example, put your dish in the compartment in the morning and set the cooking time so that it is ready at lunch time.

Ensure that food is not left in the cooking compartment for too long as it may spoil.



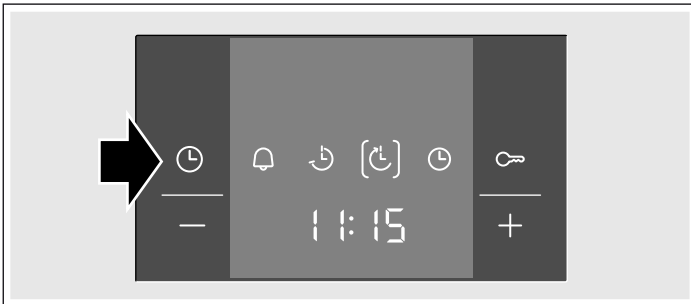

Example shown below: It is 10:30, the cooking time is 45 minutes and the main oven is required to finish cooking at 12:30.

1. Turn the function and temperature selector to set the heating type and temperature for the main oven.
2. Press the  button twice.
3. Use the **+** or **-** button to set the cooking time.
4. Press the  button. The brackets are around . The time when the dish will be ready is displayed.





5. Use the button **+** or **-** to delay the end time.



After a few seconds, the oven adopts the settings and switches to standby. The display shows the time at which the dish will be ready and the  symbol is in brackets. The symbols  and  go out. When the main oven starts, the cooking time counts down in the display and the  symbol is shown in brackets. The  symbol goes out.

The cooking time has elapsed

A signal sounds. The main oven stops heating. 00:00 is shown in the display. Press the  button. The **+** or **-** buttons can be used to set a new cooking time. Or press the  button twice and turn the function and temperature selector to the off position. The main oven is switched off.

Changing the end time





Use the **+** or **-** button to change the end time. After a few seconds, the change is adopted. If the timer has been set, first press the  button twice. Do not change the end time if the cooking time has already started to elapse. The cooking result would no longer be correct.

Cancelling the end time

Use the **-** button to set the end time back to the current time. After a few seconds, the change is adopted. The main oven starts. If the timer has been set, first press the  button twice.

Checking the time settings

If several time-setting options are set, the relevant symbols are illuminated on the display. The symbol for the time-setting option that is visible in the display is shown in brackets.

To call up the  timer,  cooking time,  end time or  clock, press the  button repeatedly until the brackets are around the relevant symbol. The display shows the value for a few seconds.



Clock

After the appliance is connected or following a power cut, the  symbol and four zeros light up in the display. Set the clock.

1. Press the  button.
The time 12:00 is shown in the display.
2. Use the **+** or **-** button to set the clock.
After a few seconds, the time that has been set is adopted.

Changing the clock

No other time-setting option should have been set.

1. Press the  button four times.
The time symbols light up in the display and the brackets are around .
2. Use the **+** or **-** button to change the clock.
After a few seconds, the time that has been set is adopted.

Hiding the clock

You can hide the clock. For more information, please refer to the section *Changing the basic settings*.

Childproof lock

The  main oven has a childproof lock to prevent children from switching it on by accident or changing a setting.

The main oven does not respond to any settings. You can still set the clock and the timer when the childproof lock is activated.

If the heating type and temperature or grill setting are set for the main oven, the childproof lock interrupts the heater element.

Switching on the childproof lock

No cooking time or end time may be set.

Press and hold the  button for approximately 4 seconds.

The  symbol appears in the display. The childproof lock is activated.

Switching off the childproof lock

Press and hold the  button for approximately 4 seconds.

The  symbol in the display goes out. The childproof lock is deactivated.

Changing the basic settings

Your oven has various basic settings. These settings can be customised to suit your requirements.

Basic setting	Selection 1	Selection 2	Selection 3
c1 Clock display	always*	only with the ⊖ button	-
c2 Signal duration upon completion of a cooking time or timer period	approx. 10 seconds	approx. 2 minutes*	approx. 5 minutes
c3 Waiting time until a setting is applied	approx. 2 seconds	approx. 5 seconds*	approx. 10 seconds

* Factory setting

No other time-setting option should have been set.

1. Press and hold the ⊖ button for approx. 4 seconds.
The current basic setting for the clock display is shown in the display, e.g. c1 1 for selection 1.
2. Use the + or - button to change the basic setting.
3. Confirm by pressing the ⊖ button.
The next basic setting appears in the display. You can scroll through all levels with the ⊖ button and change the setting with the + or - button.
4. To finish, press and hold the ⊖ button for approx. 4 seconds.
All basic settings are applied.

You may change the basic settings at any time.

Care and cleaning

With good care and cleaning, your oven will remain clean and fully-functioning for a long time to come. Here we will explain how to maintain and clean your oven correctly.

Notes

- Slight differences in the colours on the front of the oven are caused by the use of different materials, such as glass, plastic and metal.
- Shadows on the door panel which look like streaks, are caused by reflections made by the oven light.
- Enamel is baked on at very high temperatures. This can cause some slight colour variations. This is normal and does not affect their function. The edges of thin trays cannot be completely enamelled. As a result, these edges can be rough. This will not impair the anti-corrosion protection.

Cleaning agents

To ensure that the different surfaces are not damaged by using the wrong cleaning agent, observe the information in the table. Do not use

- sharp or abrasive cleaning agents,
- cleaning agents with a high concentration of alcohol,
- hard scouring pads or sponges,
- high-pressure cleaners or steam cleaners.

Wash new sponge cloths thoroughly before use.

Area	Cleaning agents
Oven front	Hot soapy water: Clean with a dish cloth and dry with a soft cloth. Do not use glass cleaners or glass scrapers.
Stainless steel	Hot soapy water: Clean with a dish cloth and dry with a soft cloth. Remove flecks of limescale, grease, starch and albumin (e.g. egg white) immediately. Corrosion can form under such residues. Special stainless steel cleaning products suitable for warm surfaces are available from our after-sales service or from specialist retailers. Apply a thin layer of the cleaning product with a soft cloth.

Area	Cleaning agents
Door panels	Glass cleaner: Clean with a soft cloth. Do not use a glass scraper.
Glass cover for the oven light	Hot soapy water: Clean with a dish cloth.
Seal Do not remove.	Hot soapy water: Clean with a dish cloth. Do not scour.
Shelves	Hot soapy water: Soak and clean with a dish cloth or brush.
Telescopic shelves	Hot soapy water: Clean with a dish cloth or a brush. Do not soak or clean in the dishwasher.
Accessories	Hot soapy water: Soak and clean with a dish cloth or brush.

Cleaning self-cleaning surfaces in the cooking compartment

The back panel and ceiling in the top oven, and the back panel in the main oven, are coated with self-cleaning enamel. This coating absorbs and dispels splashes from baking and roasting while the oven is in operation. The higher the temperature and the longer the oven is in operation the better the result will be.

If dirt is still visible after operating the oven several times, clean the self-cleaning surfaces with hot soapy water and a soft cloth.

Over time, discolourations may occur, which can no longer be removed. These will not damage the enamel.

Caution!

Damage to surfaces on self-cleaning areas due to applying oven cleaner. Never clean the self-cleaning surfaces with oven cleaner.

If oven cleaner accidentally gets onto self-cleaning surfaces, remove it immediately with a sponge and plenty of water.

Caution!

Damage to surfaces on self-cleaning areas due to the use of abrasive and acidic cleaning agents and aids.
Do not use cleaning agents containing abrasive substances or acids.
Do not use abrasive cleaning aids such as steel wool or scourers.

Clean the cooking compartment floor and side panels

Use a dish cloth and hot soapy water or a vinegar solution.

If there are heavy deposits of dirt, use a stainless steel scouring pad or oven cleaner. Only use when the cooking compartment is cold. Never treat the self-cleaning surfaces with a scouring pad or oven cleaner.

Cleaning the hook-in racks

You can remove the hook-in racks for easier cleaning.

⚠ Risk of burning due to hot components in the cooking compartment!

Wait until the cooking compartment has cooled down.

1. Push the hook-in rack upwards at the front and unhook to the side.
2. Pull the hook-in rack forwards at the rear and unhook to the side.

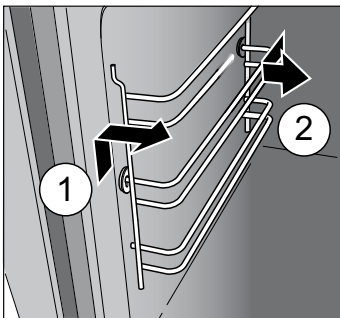

3. Clean the hook-in racks with washing-up liquid and a sponge or brush.
4. Align the hook-in rack with the indentation (a) facing upwards, so that the shelf heights match.
5. Insert the hook-in rack at the rear until the limit stop.
6. Push the hook-in rack towards the rear.
7. Insert the hook-in rack at the front until the limit stop.
8. Push the hook-in rack downwards.

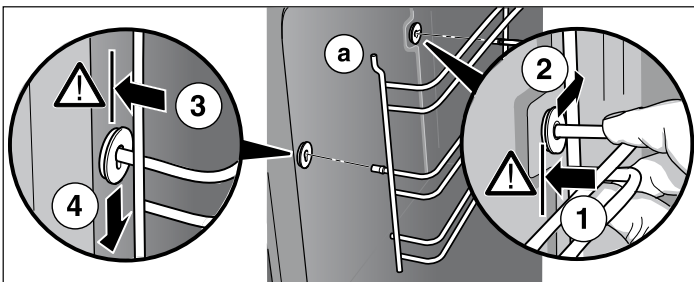

Detaching and attaching the oven door

For cleaning purposes and to remove the door panels, you can detach the oven door.

The oven door hinges each have a locking lever. When the locking levers are closed (figure A), the oven door is secured in place. It cannot be detached. When the locking levers are open in order to detach the oven door (Fig. B), the hinges are locked. They cannot snap shut.

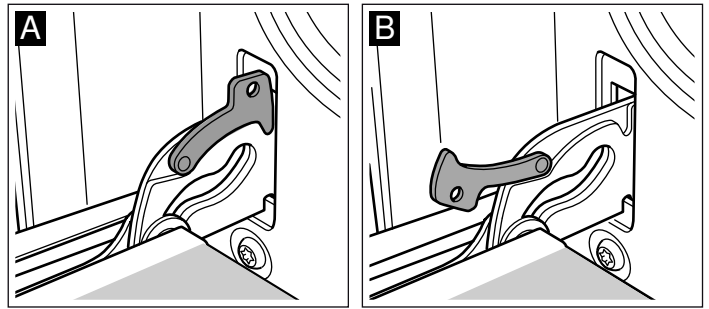

⚠ Risk of injury!

Whenever the hinges are not locked, they snap shut with great force. Ensure that the locking levers are always fully closed or, when detaching the oven door, fully open.

Detaching the door

1. Open the oven door fully.
2. Fold up the two locking levers on the left and right (figure A).
3. Close the oven door as far as the limit stop. With both hands, grip the door on the left and right-hand sides. Close the door a little further and pull it out (figure B).

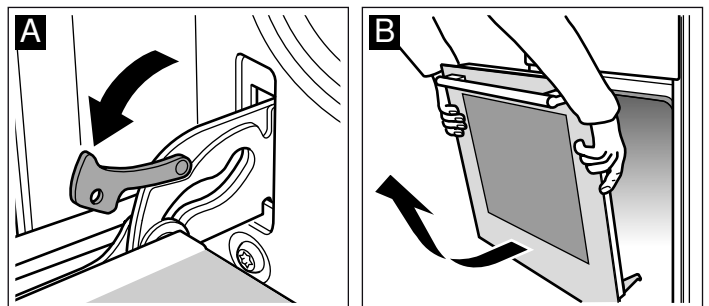

Attaching the door

Reattach the oven door in the reverse sequence to removal.

1. When attaching the oven door, ensure that both hinges are inserted straight into the opening (figure A).
2. The notch on the hinge must engage on both sides (figure B).

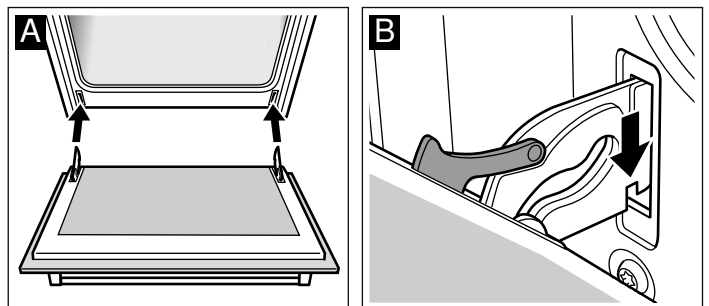

3. Fold back both locking levers (figure C). Close the oven door.

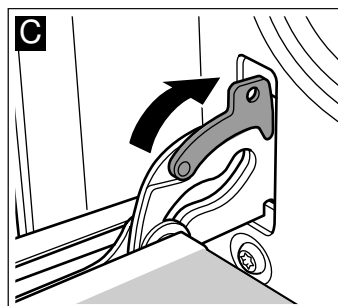

⚠ Risk of injury!

If the oven door falls out accidentally or a hinge snaps shut, do not reach into the hinge. Call the after-sales service.

Cleaning the door panels

To facilitate cleaning, you can remove the inner door panels from the appliance doors.

⚠ Risk of injury!

The components inside the appliance door may have sharp edges. Take care not to cut yourself. Wear protective gloves.

⚠ Risk of injury!

The appliance must not be used again until the door panels and appliance door have been correctly fitted.

Removing the door panel

Note: Before removing, make a note of which way round the door panel is fitted, so that it is not refitted the wrong way round.

📺 Main oven and 📺 top oven

1. Unhook the appliance door and lay it on a soft, clean surface with the front side facing downwards (see section: Removing and fitting the appliance door).
2. Unscrew the cover at the top left and right of the appliance door and detach it (figure A).
3. Lift the door panel and pull it out (figure B).

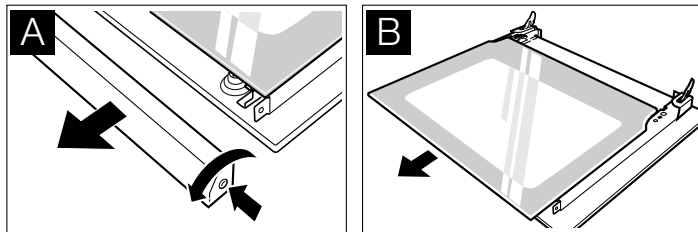

📺 Top oven

You can also remove and clean the intermediate panel in the top oven.

1. Press the holder on the intermediate panel on one side and unlatch it, using a spatula, for example (figure C).
2. Unlatch the other side in the same way and remove the intermediate panel.

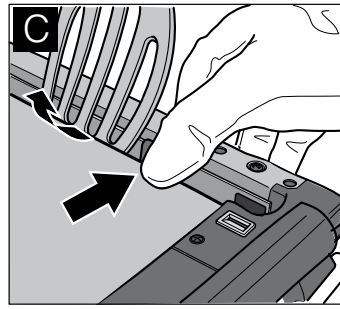

Cleaning

Clean the door panel with glass cleaner and a soft cloth.

Caution!

Do not use any sharp or abrasive medium or a glass scraper. The glass could be damaged.

Fitting the door panels

📺 Top oven

1. Place the intermediate panel in the supports on the left and right (figure D).
2. Push the intermediate panel downwards in the retainers.

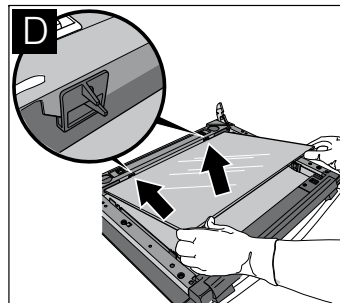

📺 Main oven and 📺 top oven

1. Slide in the door panel all the way.
2. Put the cover back in place and screw it in.
3. Refit the appliance door.

Troubleshooting

Malfunctions often have simple explanations. Refer to the table before calling the after-sales service as you may be able to remedy the fault yourself.

Malfunction table

If a dish doesn't turn out as well as you had hoped, refer to the section *Tested for you in our cooking studio*, where you will find plenty of cooking tips and tricks.

Problem	Possible cause	Remedy/information
The oven does not work.	The circuit breaker is defective.	Look in the fuse box and check that the circuit breaker is in working order.
	Power cut	Check whether the kitchen light or other kitchen appliances are working.
🕒 and zeros light up in the display.	Power cut	Reset the clock.
The oven does not heat up.	There is dust on the contacts.	Turn the control knobs back and forth several times.

Error messages

If an error message with **E** appears, press the **⏻** button. The message disappears. A time function that has been set is cleared. If the error message does not disappear, please contact the after-sales service.

You can take remedial action yourself if the following error message is displayed.

Error message	Possible cause	Remedy/information
E011	A button was depressed for too long or is covered up.	Press all buttons individually. Check whether any buttons are jammed, covered up or soiled.

⚠ Risk of electric shock!

Incorrect repairs are dangerous. Repairs may only be carried out by one of our trained after-sales engineers.

Replacing the oven light bulb

Replace faulty oven light bulbs.

Spare bulbs can be obtained from the after-sales service or specialist retailers. Use the following oven lights for the top oven and the main oven: E14, 220 - 240 V, 25 W, heat-resistant to 300 °C

Risk of electric shock !

Disconnect the appliance from the power supply. Switch off the circuit breaker or remove the fuse from the household fuse box.

1. Place a tea towel in the cold cooking compartment to prevent damage.
2. Turn the glass cover anticlockwise and remove it.

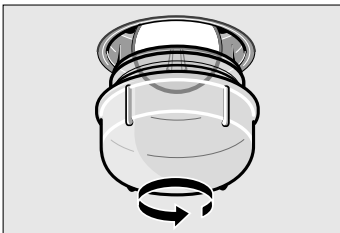

3. Replace the oven light bulb with a bulb of the same type.
4. Screw on the glass cover again.
5. Remove the tea towel and switch on the circuit breaker.

Note: Use rubber gloves if the glass cover cannot be unscrewed: Or order a special removal tool from the after-sales service:

- For the main oven: Order no. 613634
- For the top oven: Order no. 621743

Glass cover

You must replace a damaged glass cover. Suitable glass covers may be obtained from the after-sales service. Please specify the E number and FD number of your appliance.

After-sales service

Our after-sales service is there for you if your appliance needs to be repaired. We will always find the right solution in order to avoid unnecessary visits from a service technician.

E number and FD number

When calling us, please give the product number (E no.) and the production number (FD no.) so that we can provide you with the correct advice. The rating plate containing these numbers can be found on the right-hand side of the oven door. You can make a note of the numbers of your appliance and the telephone number of the after-sales service in the space below to save time should it be required.

E no.	FD no.
-------	--------

After-sales service

Please note that there will be a fee for a visit by a service technician in the event of a malfunction, even during the warranty period.

Please find the contact data of all countries in the enclosed customer service list.

To book an engineer visit and product advice

- GB** 0844 8928979
Calls from a BT landline will be charged at up to 3 pence per minute. A call set-up fee of up to 6 pence may apply.
- IE** 01450 2655

Trust the expertise of the manufacturer, and rest assured that the repair will be carried out by trained service technicians using original spare parts for your domestic appliance.

Energy and environment tips

Here you can find tips on how to save energy when baking and roasting and how to dispose of your appliance properly.

Saving energy

- Only preheat the oven if this is specified in the recipe or in the operating instruction tables.
- Use dark, black lacquered or enamelled baking tins. They absorb the heat particularly well.
- Open the oven door as infrequently as possible while you are cooking, baking or roasting.
- It is best to bake several cakes one after the other. The oven is still warm. This reduces the baking time for the second cake. You can also place two loaf tins next to each other.
- For longer cooking times, you can switch the oven off 10 minutes before the end of the cooking time and use the residual heat to finish cooking.

Environmentally-friendly disposal

Dispose of packaging in an environmentally-friendly manner.



This appliance complies with European Directive 2002/96/EC on Waste Electrical and Electronic Equipment (WEEE). The directive gives a framework for the collection and recycling of old appliances, which is valid across the EU.

Tested for you in our cooking studio.



Here you will find a selection of dishes and the ideal settings for them. We will show you which type of heating and which temperature are best suited for your dish. You can find information about suitable accessories and the height at which they should be inserted. There are also tips about cookware and preparation methods.

Notes

- The values in the table always apply to dishes placed into the cooking compartment when it is cold and empty.
Only preheat the appliance if the table specifies that you should do so. Do not line the accessories with greaseproof paper until after they have been preheated.
- The times specified in the tables are guidelines only. They will depend on the quality and composition of the food.
- Use the accessories supplied. Additional accessories may be obtained as special accessories from specialist retailers or from the after-sales service.
Before using the oven, remove any unnecessary accessories and ovenware from the cooking compartment.
- Always use oven gloves when taking hot accessories or ovenware out of the cooking compartment.

Cakes and pastries

Baking on one level

When baking cakes, the best results can be achieved using  Top/bottom heating. When baking with  3D hot air, note the following: Bake cakes in tins and on a tray at shelf height 1.

Baking on two or more levels

Use  3D hot air.

Baking on 2 levels:

- Baking tray in shelf position 3
- Universal pan in shelf position 1

Tables

The tables show the ideal type of heating for the various cakes and pastries. The temperature and baking time depend on the amount and consistency of the mixture. This is why temperature ranges are given in the tables. You should try the lower temperature first, since a lower temperature allows more even

Baking trays that are placed in the oven at the same time will not necessarily be ready at the same time.

The tables show numerous suggestions for well-known dishes.

2 small, round cake tins on one level should be placed diagonally on the wire rack.

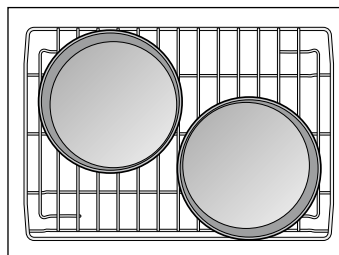

For 4 small, round cake tins, place 2 diagonally on each wire rack. Slide in the wire racks one on top another, one on each level.

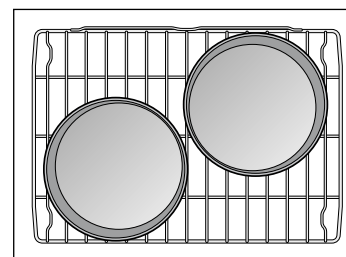
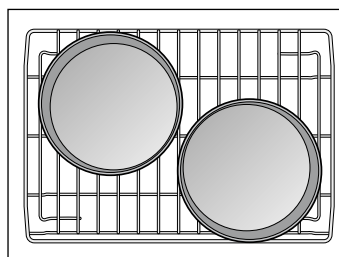

Baking tins







It is best to use dark-coloured metal baking tins. Baking times are increased when light-coloured baking tins made of thin metal or glass dishes are used, and cakes do not brown so evenly.

If you wish to use silicone baking tins, use the information and recipes provided by the manufacturer as a guide. Silicone baking tins are often smaller than normal tins. The amount of mixture and recipe instructions may differ.

browning. You can increase the temperature next time if necessary.

More information can be found in the "Baking tips" section which follows the tables.

Main oven

Food	Dish	Shelf position	Type of heating	Temperature in °C	Baking time in minutes
Victoria sandwich	Wire rack + 2 tins, dia. 20 cm	1	 *	160-170	25-30
Light fruit cake	Wire rack + deep tin, dia. 20 cm	1	 *	140-150	80-100
Rich fruit cake	Wire rack + deep round tin, dia. 23 cm or square tin, 20 cm	1	 *	140-150	210-240
Fruit crumble	Wire rack + flat glass dish	1	 *	160-170	40-50
Sponge cake (fat-free)	Wire rack + baking tin (dark coated)	1	 *	160-170	25-35
Swiss roll	Wire rack + Swiss roll tin	1	 *	180-190	10-15
Tart	Wire rack + plate or pie tin, dia. 20 cm	1	 *	160-170	50-60

* preheat

** preheat at higher temperature, then reduce and insert food

Food	Dish	Shelf position	Type of heating	Temperature in °C	Baking time in minutes
Quiche	Wire rack + quiche tin (dark coated)	1	🔥*	170-180	45-55
(White) bread	Wire rack + loaf tin (1 x 900 g or 2 x 450 g)	1	🔥**	210-220	20-30
Scones	Universal pan	1	🔥*	180-200	8-10
Biscuits	Universal pan	1	🔥*	160-170	15-20
Small cakes	Wire rack + 12-cup tin	1	🔥*	160-170	20-25
Jam tarts	Wire rack + 12-cup tin	1	🔥*	180-190	15-20
Meringues	Universal pan	1	🔥*	80	100-130
Pavlova	Universal pan	1	🔥*	150**+ 90	80-100
Pie	Wire rack + pie dish	1	🔥*	170-180	70-80
Yorkshire pudding	Universal pan + 12-cup tin	1	🔥*	200-220	10-15
Jacket potatoes	Universal pan	1	🔥*	160-170	60-70
Pizza (homemade)	Universal pan	1	🔥*	210-220	20-30

* preheat

** preheat at higher temperature, then reduce and insert food

Food	Dish	Shelf position	Type of heating	Temperature in °C	Baking time in minutes
Victoria sandwich 2 levels	2 wire racks + 4 tins, dia. 20 cm	3+1	🔥*	160-170	25-30
Scones 2 levels	Wire rack with baking tray + universal pan	3+1	🔥*	180-200	8-12
Biscuits 2 levels	Wire rack with baking tray + universal pan	3+1	🔥*	160-170	15-20
Small cakes 2 levels	2 wire racks + 2 12-cup tins	3+1	🔥*	150-160	20-30
Jacket potatoes 2 levels	2 wire racks	3+1	🔥*	160-170	65-75
Pizza (homemade)	Wire rack with baking tray + universal pan	3+1	🔥*	180-190	35-45

* preheat

🔥 Top oven

Food	Dish	Shelf position	Type of heating	Temperature in °C	Time in minutes
Victoria sandwich	Wire rack + 1 tin, dia. 20 cm	1	🔥*	160-170	25-30
Scones	Wire rack + baking tray	1	🔥*	200-210	10-12
Small cakes	Wire rack + 12-cup tin	1	🔥*	150-160	25-30
Jam tarts	Wire rack + 12-cup tin	1	🔥*	190-210	15-25
Swiss roll	Wire rack + Swiss roll tin	1	🔥*	180-190	10-15
Biscuits	Wire rack + baking tray	1	🔥*	170-180	10-15
Meringues	Wire rack + baking tray	1	🔥*	80	110-140

* Preheat.

Baking tips

You wish to bake according to your own recipe. Use similar items in the baking tables as a guide.

How to establish whether sponge cake is baked through. Approximately 10 minutes before the end of the baking time specified in the recipe, stick a cocktail stick into the cake at the highest point. If the cocktail stick comes out clean, the cake is ready.

The cake collapses. Use less fluid next time or set the oven temperature 10 degrees lower. Observe the specified mixing times in the recipe.

The cake has risen in the middle but is lower around the edge. Do not grease the sides of the springform cake tin. After baking, loosen the cake carefully with a knife.

The cake goes too dark on top.	Place it lower in the oven, select a lower temperature and bake the cake for a little longer.
The cake is too dry.	When it is done, make small holes in the cake using a cocktail stick. Then drizzle fruit juice or an alcoholic beverage over it. Next time, select a temperature 10 degrees higher and reduce the baking time.
The bread or cake (e.g. cheesecake) looks good, but is soggy on the inside (sticky, streaked with water).	Use slightly less fluid next time and bake for slightly longer at a lower temperature. For cakes with a moist topping, bake the base first. Sprinkle it with almonds or bread crumbs and then place the topping on top. Please follow the recipe and baking times.
The cake is unevenly browned.	Select a slightly lower temperature to ensure that the cake is baked more evenly. Protruding greaseproof paper can affect the air circulation. For this reason, always cut greaseproof paper to fit the baking tray.
The bottom of a fruit cake is too light.	Place the cake one level lower the next time.
The fruit juice overflows.	Next time, use the deeper universal pan, if you have one.
Small baked items made out of yeast dough stick to one another when baking.	There should be a gap of approx. 2 cm around each item. This gives enough space for the baked items to expand well and turn brown on all sides.
You were baking on several levels. The items on the top baking tray are darker than that on the bottom baking tray.	Always use  3D hot air to bake on more than one level. Baking trays that are placed in the oven at the same time will not necessarily be ready at the same time.
Condensation forms when you bake moist cakes.	Baking may result in the formation of water vapour, which escapes above the door. The steam may settle and form water droplets on the control panel or on the fronts of adjacent units. This is a natural process.

Meat, poultry, fish

Ovenware

The universal pan with insert wire rack is suitable for large roasts. You may also use any heat-resistant ovenware.

Glass ovenware is the most suitable. Ensure that the lid of the roasting dish fits well and closes properly.

Add a little more liquid when using enamelled roasting dishes.

With roasting dishes made of stainless steel, browning is not so intense and the meat may be somewhat less well cooked. Increase the cooking times.

Always place the ovenware in the centre of the wire rack.

Place hot glass ovenware on a dry mat after cooking. The glass could crack if placed on a cold or wet surface.

Roasting

The information in the table applies to food placed in a cold oven and for meat taken directly from the refrigerator.

The joints of meat should weigh between 500 g and 2 kg.

Ensure that you always use the lower temperature, if the weight of the joint you wish to roast is high.

If there are several pieces of meat, calculate the roasting time using the weight of the heaviest piece of meat. The individual pieces of meat should be approximately the same size.

Meat











Turn pieces of meat halfway through the cooking time.

When the roast is ready, turn off the oven and allow it to rest for an additional 10 minutes. This allows better distribution of the meat juices.

After cooking, wrap sirloin in aluminium foil and leave it to rest for 10 minutes in the oven.

For roast pork with a rind, score the rind in a crossways pattern, then lay the roast in the dish with the rind at the bottom.

Main oven

Meat	Dish	Shelf position	Type of heating	Temperature in °C	Time, mins per 500 g + add. time
Beef					
Slow roast joint	Universal pan with roasting rack	1		130-140	40+40
Top side and top rump	Universal pan with roasting rack	1		160-170	30+25
Lamb					
Leg	Universal pan with roasting rack	1		160-170	30+25
Shoulder (on the bone)	Universal pan with roasting rack	1		160-170	25+20
Shoulder (boned and rolled)	Universal pan with roasting rack	1		170-180	25+25
Rack of lamb	Universal pan with roasting rack	1		180-190	25+25
Pork					
Roast joint	Universal pan with roasting rack	1		180-190	35+35
Loin joint	Universal pan with roasting rack	1		170-180	30+30
Belly	Universal pan with roasting rack	1		160-170	30+25
Gammon joint	Universal pan with roasting rack	1		160-170	30+30

Meat	Dish	Shelf position	Type of heating	Temperature in °C	Time, mins per 500 g + add. time
Poultry					
Chicken	Universal pan with roasting rack	1		170-180	20+25
Chicken, portion	Universal pan with roasting rack	1		190-200	20+25
Chicken, quarter (450 g each)	Universal pan with roasting rack	1		180-190	20+25
Duck	Universal pan with roasting rack	1		180-190	20+20
Turkey, crown	Universal pan with roasting rack	1		160-170	15+15
Casserole					
Diced meat (beef, pork, lamb)	Wire rack + glass roasting dish with lid	2		140	120-150 total time
Braising steaks	Wire rack + glass roasting dish with lid	2		140	120-150 total time
Chicken	Wire rack + glass roasting dish with lid	2		140	60-90

Tips for grilling

Always grill with the oven door closed.

Place the food to be grilled directly on the wire rack. If you are grilling a single piece of food, the best results are achieved by placing it in the centre of the wire rack. The universal pan should also be inserted underneath. The meat juices are collected in the pan and the oven is kept cleaner.

If possible, grill items should be of equal thickness. This ensures that they brown evenly while also remaining succulent. Only add salt to steaks once they have been grilled.

Turn grilled items after the specified time.

Whole fish does not need to be turned. Place the whole fish in the oven in its swimming position with its dorsal fin facing upwards. Placing a scored potato or a small oven-proof container in the stomach cavity of the fish will provide stability.

The grill element switches on and off intermittently. This is normal. How often this happens depends on the selected grill setting.

Top oven

Observe the notes in the table about preheating.

Food	Dish	Shelf position	Type of heating	Grill setting	Time in minutes
Beef					
Steaks 2-3 cm thick	Wire rack + universal pan	2+ 1	*	3	1st side 10-13, 2nd side 6-8
Burgers 1-2 cm thick	Wire rack + universal pan	2+ 1		3	1st side 10-12, 2nd side 6-8
Lamb					
Steaks 2-3 cm thick	Wire rack + universal pan	2+ 1	*	3	1st side 6-8, 2nd side 4-6
Chops 2-3 cm thick	Wire rack + universal pan	2+ 1	*	3	1st side 7-9, 2nd side 5-8
Pork					
Steaks 1-2 cm thick	Wire rack + universal pan	2+ 1	*	3	1st side 9-12, 2nd side 6-8
Chops 2-3 cm thick	Wire rack + universal pan	2+ 1	*	3	1st side 10-13, 2nd side 8-12
Burgers 1-2 cm thick	Wire rack + universal pan	2+ 1		3	1st side 10-12, 2nd side 6-8
Sausages 2-4 cm thick	Wire rack + universal pan	2+ 1		3	14 --18**
Chicken					
Drumsticks 150 g each	Wire rack + universal pan	2+ 1		2	1st side 16-20, 2nd side 12-15

* Preheat for 3 minutes

** Turn frequently

Food	Dish	Shelf position	Type of heating	Grill setting	Time in minutes
Breast (boneless) 150 g each	Wire rack + universal pan	2+ 1		2	1st side 13-15, 2nd side 8-10

Fish

Whole trout 300 g each	Wire rack + universal pan	2+ 1		1	25-30
Fillets 150 g each	Wire rack + universal pan	2+ 1		1	15-20

* Preheat for 3 minutes

** Turn frequently

Tips for roasting and grilling

The table does not contain information for the weight of the joint.	Select the next lowest weight from the instructions and extend the time.
How to tell when the roast is ready.	Use a meat thermometer (available from specialist shops) or carry out a "spoon test". Press down on the roast with a spoon. If it feels firm, it is ready. If the spoon can be pressed in, it needs to be cooked for a little longer.
The roast is too dark and the crackling is partly burnt.	Check the shelf height and temperature.
The roast looks good but the juices are burnt.	Next time, use a smaller roasting dish or add more liquid.
The roast looks good but the juices are too clear and watery.	Next time, use a larger roasting dish and use less liquid.
Steam rises from the roast when basted.	This is normal and due to the laws of physics. The majority of the steam escapes through the steam outlet. It may settle and form condensation on the cooler switch panel or on the fronts of adjacent units.

Preprepared products

Observe the instructions on the packaging.

If you line the accessories with greaseproof paper, make sure that the paper is suitable for these temperatures. Make sure the paper is a suitable size for the dish to be cooked.

The cooking result greatly depends on the quality of the food. Pre-browning and unevenness can sometimes even be found on the raw product.

Leave a little space between bread rolls when crisping them up. Do not place too many bread rolls on the accessories.

Sprinkle grated cheese over the top of your lasagne to give it a beautiful and evenly browned finish.

Main oven

Food	Dish	Shelf position	Type of heating	Temperature in °C	Time in minutes
Pizza, frozen					
Pizza with a thin base	Universal pan	1	*	190-200	15-20
Pizza with a thick base	Universal pan	1	*	180-190	20-25
Pizza baguette	Universal pan	1	*	170-180	25-30
Pizza, chilled					
Pizza, chilled	Universal pan	1	*	200-210	10-15
Potato products, frozen					
Chips	Universal pan	1	*	190-200	25-30
Duchess potatoes	Universal pan	1	*	180-190	20-25
Hash browns (fried potatoes), filled potato skins	Universal pan	1	*	180-190	20-25
Potato wedges	Universal pan	1	*	180-190	20-25
Baked goods, frozen					
Rolls, baguettes	Universal pan	1	*	180-190	10-20

* preheat

Food	Dish	Shelf position	Type of heating	Temperature in °C	Time in minutes
Fried foods, frozen					
Fish fingers	Universal pan	1	*	180-200	15-20
Food, frozen					
Lasagne, 400 g	Wire rack	1	*	180-190	35-40
Lasagne, 1200 g	Wire rack	1	*	180-190	40-50
Food, chilled					
Lasagne, 400 g	Wire rack	1	*	170-180	35-40
Lasagne, 1200 g	Wire rack	1	*	170-180	40-45

* preheat

Special dishes

At low temperatures, 3D hot air is equally useful for producing creamy yoghurt as it is for proving light yeast dough. First, remove accessories, hook-in racks or telescopic shelves from the cooking compartment.

Preparing yoghurt

1. Bring 1 litre of milk (3.5 % fat) to the boil and cool down to 40 °C.
2. Stir in 150 g of yoghurt (chilled).

3. Pour into cups or small screw-top jars and cover with cling film.
4. Preheat the cooking compartment as indicated.
5. Place the cups or jars on the cooking compartment floor and incubate as indicated.

Proving dough

1. Prepare the dough as usual, place it in a heat-resistant ceramic dish and cover.
2. Preheat the cooking compartment as indicated.
3. Switch off the oven and place the dough in the cooking compartment and leave it to prove.

Main oven

Meal	Cookware	Level	Type of heating	Temperature	Cooking time
Yoghurt	Cups or screw-top jars	Place on the cooking compartment floor		Preheat to 50 °C Switch on the oven light	5 mins approx. 8 hrs
Proving dough	Heat-resistant dish	Place on the cooking compartment floor		Preheat to 50 °C Switch off the appliance, place the yeast dough in the cooking compartment	10 mins 20-30 mins

Upper oven

Meal	Cookware	Level	Type of heating	Temperature	Cooking time
Yoghurt	Cups or screw-top jars	Place on the cooking compartment floor		Preheat to 100 °C Switch on the oven light	15 mins approx. 8 hrs

Defrost

The defrosting time will depend on the type and quantity of the food.

Observe the instructions on the packaging.

Take frozen food out of its packaging and place in a suitable dish on the wire rack.

Place poultry on a plate with the breast side facing down.

Frozen food	Accessories	Level	Type of heating	Temperature
e.g. cream cakes, buttercream cakes, gateaux with chocolate or sugar icing, fruit, chicken, sausage and meat, bread and bread rolls, cakes and other baked items	Wire rack	1		The temperature selector remains switched off





Desiccation

Use unblemished fruit and vegetables only and wash it thoroughly.

Drain off the excess water, then wipe it dry.

Insert the universal pan at shelf height 1, insert wire rack at shelf height 3. Line the universal pan and the wire rack with greaseproof or parchment paper.

Turn very juicy fruit or vegetables several times. Remove fruit and vegetables from the paper as soon as they have dried.

Dishes	Level	Type of heating	Temperature in °C	Cooking time in hours
600 g apple rings	1+3		80	approx. 5
800 g pear slices	1+3		80	approx. 8
1.5 kg damsons or plums	1+3		80	approx. 8-10
200 g herbs, washed	1+3		80	approx. 1½

Acrylamide in foodstuffs

Acrylamide is mainly produced in grain and potato products prepared at high temperatures, such as potato crisps, chips,

toast, bread rolls, bread or fine baked goods (biscuits, gingerbread, cookies).

Tips for keeping acrylamide to a minimum when preparing food

General	<ul style="list-style-type: none"> ■ Keep cooking times to a minimum. ■ Cook meals until they are golden brown, but not too dark. ■ Large, thick pieces of food contain less acrylamide.
Baking	<p>With top/bottom heating max. 200 °C.</p> <p>With 3D hot air or hot air max. 180 °C.</p>
Biscuits	<p>With top/bottom heating max. 190 °C.</p> <p>With 3D hot air or hot air max. 170 °C.</p> <p>Egg or egg yolk reduces the production of acrylamide.</p>
Oven chips	<p>Spread evenly over the baking tray, in a single layer. Bake at least 400 g per baking tray so that the chips do not dry out</p>

Test dishes

These tables have been produced for test institutes to facilitate the inspection and testing of the various appliances.

In accordance with EN 50304/EN 60350 (2009) and IEC 60350.

Baking

When baking on 2 levels at once, always insert the universal pan above the baking tray.

When baking on 3 levels at once, insert the universal pan in the centre of the oven.







German apple pie on 2 levels:

place dark springform cake tins on top of one another, one on each level.

German apple pie on 1 level:

Place dark springform cake tins in a diagonal line on the same level.

Main oven

Meal	Accessories and cookware	Level	Type of heating	Temperature in °C	Cooking time in minutes
Piped cookies*	baking tray	1		140-150	20-30
	Baking tray + universal pan	3+1		140-150	20-30
Small cakes**	baking tray	1		150-160	20-30
	Baking tray + universal pan	3+1		150-160	25-35
Hot water sponge cake*	Springform cake tin on the wire rack	1		160-170	25-35
German apple pie*	Wire rack + 2 springform cake tins, dia. 20 cm	1		170-180	70-80



* Preheat oven

** Preheat for 10 minutes

Grilling

If you are grilling food directly on the wire rack, the universal pan should also be inserted at level 1. The liquid is then collected, keeping the oven cleaner.

Top oven

Meal	Accessories and cookware	Level	Type of heating	Grill setting	Duration in minutes
Making toast, preheat for 10 minutes	wire rack	2		3	0.5-2
Beefburgers, 12 pieces*, do not preheat	Wire rack + Universal pan	2+ 1		3	25-30

* turn over after $\frac{2}{3}$ of the cooking time.



Robert Bosch Hausgeräte GmbH
Carl-Wery-Straße 34
81739 München
DEUTSCHLAND